

DYNAMIC SOUND & VISUAL EXPERIENCE

# MAGICSING USER'S MANUAL



ALL-IN-ONE KARAOKE  
**ET23KM- / EX23DT**  
VER.100

**I**  
**Thank you for your purchase**  
Please read this carefully before using your MAGICSING

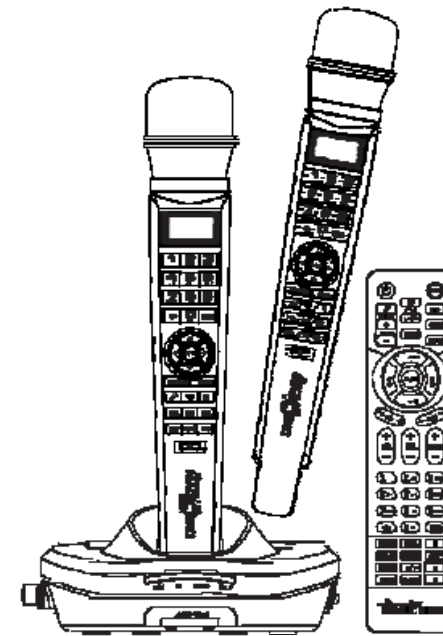

Thank you for purchasing Enter Tech's MagicSing.  
With this wireless karaoke system, you can enjoy singing.  
Sing together and have fun with your family and friends.  
Show off your talent anytime, anywhere!

User's Manual | ET23KM  
VER.100

## **FCC Information to User**

This equipment has been tested and found to comply with the limits for a Class B digital device, pursuant to Part 15 of the FCC Rules. These limits are designed to provide reasonable protection against harmful interference in a residential installation. This equipment generates, uses and can radiate radio frequency energy and, if not installed and used in accordance with the instructions, may cause harmful interference to radio communications. However, there is no guarantee that interference will not occur in a particular installation. If this equipment does cause harmful interference to radio or television reception, which can be determined by turning the equipment off and on, the user is encouraged to try to correct the interference by one of the following measures:

- Reorient or relocate the receiving antenna.
- Increase the separation between the equipment and receiver.
- Connect the equipment into an outlet on a circuit different from that to which the receiver is connected.
- Consult the dealer or an experienced radio/TV technician for help.

## **Caution**

Modifications not expressly approved by the party responsible for compliance could void the user's authority to operate the equipment.

**FCC Compliance Information :** This device complies with Part 15 of the FCC Rules. Operation is subject to the following two conditions: (1) This device may not cause harmful interference, and (2) this device must accept any interference received, including interference that may cause undesired operation

## **IMPORTANT NOTE:**

### **FCC RF Radiation Exposure Statement:**

This equipment complies with FCC RF radiation exposure limits set forth for an uncontrolled environment. This equipment should be installed and operated with a minimum distance of 20 centimeters between the radiator and your body. This transmitter must not be co-located or operating in conjunction with any other antenna or transmitter.

# CONTENTS

## Chapter 01. Introduction

Specifications .....	01-01
Basic Items .....	01-02
Optional Items .....	01-03

## Chapter 02. How to Set up Your MAGICSING

How to Connect to a TV .....	02-01
How to Connect to a TV & Stereo (Sound System) .....	02-01
How to Change the background video using other video sources .....	02-02
How to Convert [PAL] or [NTSC] mode of TV .....	02-02

## Chapter 03. Product Guide

ET23KM Main Station & Wired Mic .....	03-01
ET23KM Wireless Karaoke Key Buttons .....	03-02
ET23KM Remote Control .....	03-07

## Chapter 04. Functions and Settings

KARAOKE	
- Song Search .....	04-01
- Recording .....	04-03
- MY-MIC .....	04-05
- User's Contents .....	04-06
- Theme .....	04-07
- Jump .....	04-07
- Vocal Assist (Multiplex) .....	04-08
- Musical Notation .....	04-08
- User Background (SD card) .....	04-09
HOW TO SING .....	04-10
MOVIE .....	04-11
GAME .....	04-12
CONFIGURATION MENU .....	04-14
SOFTWARE INSTALLATION .....	04-16
ET MANAGER .....	04-23

## Chapter 05. Optional Items

Recording Pack .....	05-01
Additional Song Pack .....	05-02

## Chapter 06. Additional Information

Precaution .....	06-01
Troubleshooting .....	06-02

## Chapter.01 - Introduction

### SPECIFICATIONS

ET23KM MAIN STATION	
· Model No.	ET23KM
· Sound Engine	CT-500(SEIP-II)
· Wireless Mic. Bandwidth	2403 ~ 2477 MHz
· Dimension / Weight	137(W) x 203(H) x 60(L)mm / 322g
· Power Consumption	During the Stand-By : 17mA / 153mW During the Playing - JPEG MODE : 300mA / 2.7W - MOVING MODE : 540mA / 4.86W
· Audio Output	Stereo Line Out(Full scale Output) - TV Mode : 2Vrms - AMP Mode : 3.5Vrms
· Video Output	Format : NTSC or PAL 1Vp-p @ 75 Ohm Load
· External Video Input	Composite 1Vp-p @ 75 Ohm Load
· Resolution	NTSC : 720 x 480(interlace) / PAL : 720 x 576(interlace)
· USB(Slave only)	USB2.0(HI Speed), USB1.1Support
· Operating Temperature	-10°C ~ 60°C
· Power Supply	AC Adaptor(DC 9V/1A)

WIRELESS KARAOKE	
· Model No.	EX23DT
· RF Frequency	2403~ 2477 MHz
· Battery	1.5V (AA) x 2 EA
· Dimensions	43.5(W) x 43.5(L) x 259(H) mm
· Weight	170g ( without the batteries )
· Wattage	70mA / 210mW
· Operating Temperature	-10°C ~ 60°C
· Effective Distance	Up to 10m unobstructed distance

**BASIC ITEMS**

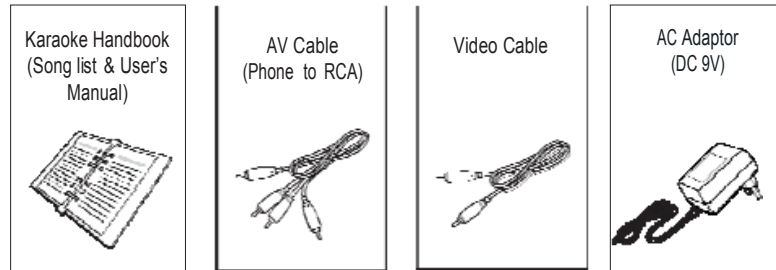
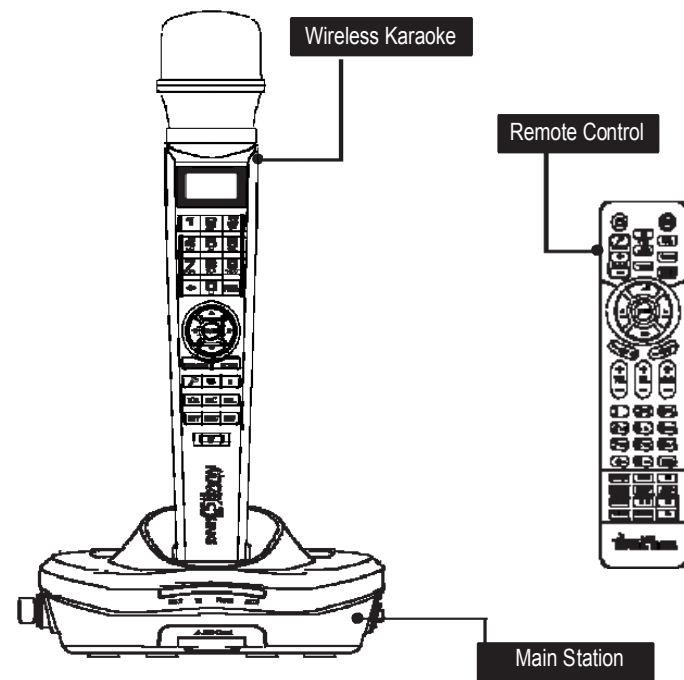

**BASIC ITEMS**

- ET23KM Main Station
- Karaoke Handbook (Songlist & User's Manual)
- Wireless Karaoke x 2 ea / Battery AA x 4 ea
- Remote Control / Battery AAA x 2 ea
- USB Installation CD
- AV Cable (Phone to RCA)
- Video Cable
- AC Adaptor (9V)
- USB Cable
- SD card

**OPTIONAL ITEMS**



ET23KM Main Station

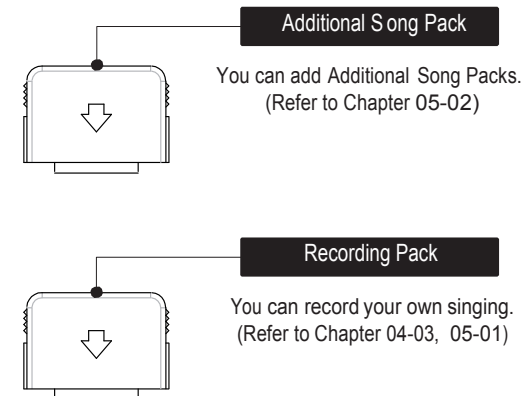

**OPTIONAL ITEMS**

- Recording Pack
- Additional Song Pack

## HOW TO CONNECT TO A TV

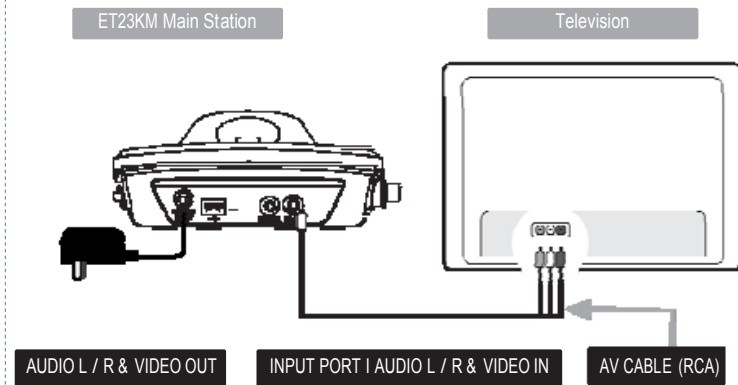

1. Connect the Audio / Video cable to the RCA jack terminal on your TV, as shown above. If there are only two RCA jack terminals on your TV (mono TV), connect the yellow jack (male) to the yellow RCA jack terminal and connect the white jack (male) to the other RCA jack terminal of your TV.

※ Please turn off the function “Automatic Volume Levelling” (AVL / AVC) on your television set.

## HOW TO CONNECT TO A TV & STEREO (SOUND SYSTEM)

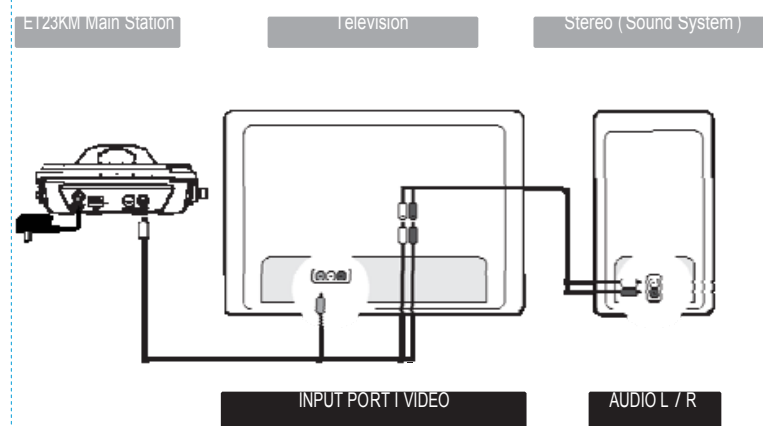

1. Connect the yellow jack to the yellow RCA terminal on your TV. Connect the red and white jack to jack terminals on your stereo (sound system). You might need an extension cable if your stereo (sound system) is placed far away from your TV.

## HOW TO CHANGE THE BACKGROUND VIDEO USING OTHER VIDEO SOURCES

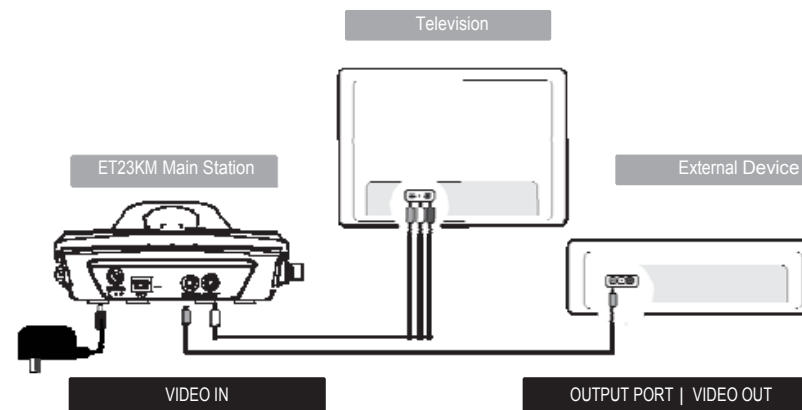

1. Connect the video cable to the VIDEO OUT jack terminal on other optional video sources (VCD, DVD, VIDEO).
2. Connect the other side of the video cable to the VIDEO IN jack terminal of MAGICSING.
3. Press [MODE+0+1] on either the mic or the remote control to use other video sources as background video by selecting "EXT.VIDEO INPUT" on the "configuration menu".

## HOW TO CONVERT [PAL] OR [NTSC] MODE OF TV

1. To convert to PAL mode, turn off the mic first.  
Press and hold button [8] on the mic, and then press the [POWER] button using another finger until the word "PAL" appears on the TV screen.  
(Do not release button [8] and the [POWER] button until the word "PAL" appears on the TV screen.)
2. To convert to NTSC mode, turn off the mic first.  
Press and hold button [9] on the mic, and then press the [POWER] button using another finger until the word "NTSC" appears on the TV screen.  
(Do not release button [9] and the [POWER] button until the word "NTSC" appears on the TV screen.)

## ET23KM MAIN STATION

ET23KM Main Station



### A POWER ON / OFF SWITCH

- Turns on or off the main station.

### B POWER INDICATOR

- A green light indicates that the ET23KM is turned on and ready for use.
- A red light indicates that the ET23KM is in the standby mode. Press the power button on the remote control or turn off the power button on the main station and turn it on again.
- No light indicates that the power button on the main station is in the off position. Please turn it on.

### C WIRELESS MIC INDICATORS

- A blue light indicates that the wireless mic is connected to the main station.

## ET& ?A WIRELESS KARAOKE KEY BUTTONS

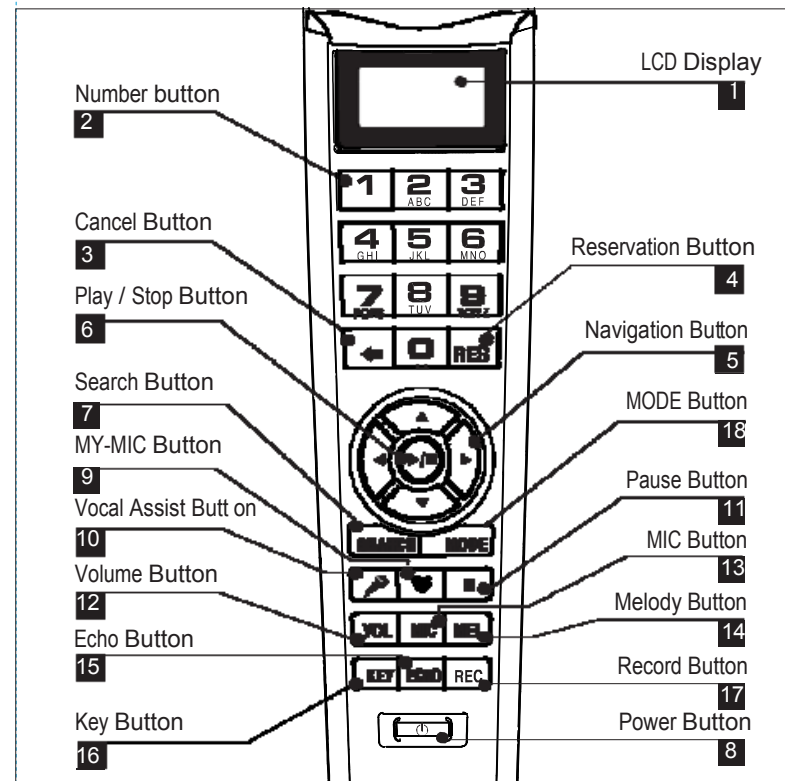

### 1. LCD DISPLAY

### 2. NUMBER BUTTON

### 3. CANCEL BUTTON

- Press this button to erase one by one what you input or to cancel some function you chose.

### 4. RESERVATION BUTTON

- Please select a song and press **[RES]** to reserve the song (The song number will be displayed on the screen under the "Reserved" menu.)
- Press **[MODE]** twice to exit the reservation list and go back to the on-screen list by pressing **[▼]**, **[▲]**.
- In case you want to delete a reserved song, select that song in the "reserved" list and press **[RES]** again.
- You can reserve up to 100 songs, but only 4 songs with their respective numbers will appear on a blue bar on the upper portion of the screen.

## 5. NAVIGATION BUTTONS

- Press these buttons to choose different modes, different songs and so on by scrolling up/down and left/right.

## 6. PLAY / STOP BUTTON

-  - Press [▶/■] once to play the selected song.
- Press [▶/■] again to stop playing the song.

## 7. SEARCH BUTTON

-  - Pressing [SEARCH] will prompt you to different modes of choosing a song.
- You can also search a song from the on-screen list by pressing [▼], [▲] or inputting characters. (Refer to Chapter.04-01)

## 8. POWER BUTTON

-  - Turns on or off the mic.  
Press [POWER] slightly to turn it on.  
Press [POWER] for 3 seconds to turn it off.
- When there is no input signal within 10 minutes, the power will be turned off automatically.

## 9. MY-MIC BUTTON

-  - This function enables you to save your own customized settings over the song you chose.
- While singing a song, adjust settings such as the volume, melody, echo, etc., press [♥] on the mic to save the settings.
- To see the stored [MY-MIC] song list, press [♥] again.
- Press [▼], [▲] to select the song you wish to sing again with the adjusted settings. Press [▶/■] to play the song and press [RES] to delete it from the list.
- The lists containing the customized settings will be retained even after turning off the ET23KM.

## 10. VOCAL ASSIST BUTTON

-  - Press this button to see the list of vocal assist. (Refer to Chapter.04-08)
- While singing a song, you can activate or deactivate vocal assist function by pressing this button repeatedly.

## 11. PAUSE BUTTON

-  - Press this button to pause the song you are singing.
- After pressing this button, you can also enjoy the "How to Sing" function by using the navigation buttons.

## 12. VOLUME BUTTON

-  - When you press [VOL], two different sub volume control menus appear on the TV screen ① Music(press once)  
② Multiplex(Press two times).

## 13. MIC BUTTON

-  - Press [MIC] to adjust the volume of the main mic then press [▼], [▲] to decrease / increase the volume.
- This setting will remain until the product is reset or the values are changed by users.

## 14. MELODY BUTTON

-  - Press this button, and then use the navigation buttons to adjust the melody levels of a song.

## 15. ECHO BUTTON

-  - Press this button and then use the navigation buttons to adjust the ECHO levels of a song.

## 16. KEY BUTTON

-  - Press [KEY] and then press [▼], [▲] to decrease / increase the pitch level while singing a song.  
The TV screen will display the range of keys (-7 ~ 8) with the default value [0] on the key bar at the upper part of the screen.
- At the end of the song or when you press [▶/■] to stop the song, this setting will return to the initial default value [0].

### 17. RECORD BUTTON

- [REC]** - Choose / select a song first before recording.
- Press **[MODE + REC]** to start recording.
- Press **[▶ / ■]** to stop recording.
- Press **[REC]** to start the playback of the song.

### 18. MODE BUTTON

- [MODE]** - You can see the function menu bar on the upper screen by pressing **[MODE]**. First, find a function you want to use by pressing **[▼]**, **[▲]**, and then press **[▶ / ■]** to prompt you to the sub-menu.
- Press **[▼]**, **[▲]** then **[▶ / ■]** to choose an option.
- **[MODE]** is used in conjunction with other buttons to access secondary functions.

### \* MODE Function

<b>[MODE]+[1]</b>	<b>VOLUME (3 Different Sub Volume Control Menus Appear)</b> ① Music volume control 0~15 / ② Melody volume control 0~15 ③ Vocal Assist volume control 0~15
<b>[MODE]+[2]</b>	<b>TEMPO (Adjusts the Tempo of a Song)</b> The range of the tempo adjustment is between -7 ~ 8, and you can select a tempo at which you want to play the song by selecting a value from this scope.
<b>[MODE]+[3]</b>	<b>KEY (Adjusts the Level of the Pitch)</b> The range of the pitch adjustment is between -7 ~ 8, and you can select the pitch level.
<b>[MODE]+[4]</b>	<b>SEARCH (Song Search Function)</b> Look for your favorite song.
<b>[MODE]+[5]</b>	<b>EFFECT (Musical Effects) : 4 Different Sub Menus Appear</b> ① Mic Echo volume control 0~15 ② Instrument : You can change the melody instrument by using <b>[▼]</b> , <b>[▲]</b> , <b>[◀]</b> , <b>[▶]</b> to one of the 8 instrumental sounds while singing a song. ③ Voice change : Mic voice alteration function that can change your voice either to female voice or to male voice. ④ Vocal assist ON / OFF
<b>[MODE]+[6]</b>	<b>PLAYING (Technical Effects) : 5 Different Sub Menus Appear</b> ① Jump : Skips the prelude or interlude ② Continuous Playback : If you wish to continue playing songs in sequential order, select a starting song and press <b>MODE → 6 → 2</b> (for example, if you select song number 241, play the song, and then press <b>MODE → 6 → 2</b> ). ③ Random Play : MagicSing randomly chooses a song for you. ④ Pause : A song pauses. Press <b>[▶ / ■]</b> to continue playing. ⑤ Selected Section Repeat : Repeats a certain section in a song. ※ Press <b>[MODE + 6 + 5]</b> to set the starting point and <b>[MODE + 6 + 5]</b> again to set the ending point. Pressing <b>[MODE + 6 + 5]</b> 3rd time turns off this function. ※ This "selected repeat function" is not available for the prelude and interlude sections of a song
<b>[MODE]+[7]</b>	<b>USER'S CONTENTS</b> ① USER'S JPEG / ② MP3
<b>[MODE]+[8]</b>	<b>REC &amp; PLAY</b> ① Record / ② Playback (Playing the recorded song)
<b>[MODE]+[9]</b>	<b>SPECIAL EFFECT : 5 Different Sub Menus Appear</b> ① Musical Notation (Key Note Guide) / ② My-Mic / ③ Theme : Background Themes (9 background themes to choose from) and Scoreboard (Records your scores at the end of each song) / ④ Silence : Silent mode (you can choose from "level 1", "level 2", and "off") / ⑤ Lyrics ON / OFF
<b>[MODE]+[0]</b>	<b>CONFIG. (Configuration)</b>



## LET'S GET A REMOTE CONTROL

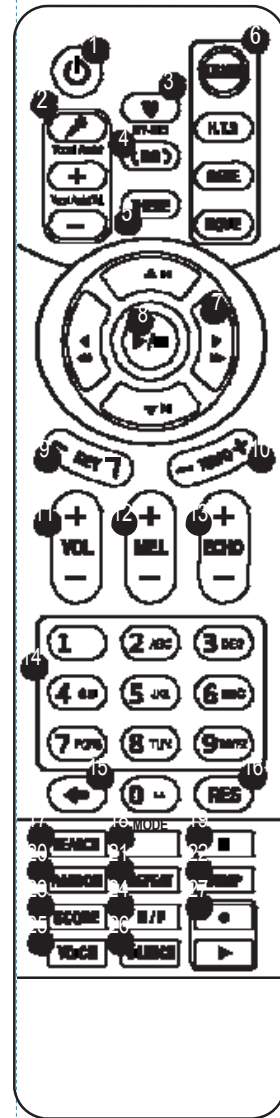

- 1 **POWER** : POWER ON/OFF.
- 2 **VOCAL ASSIST SETTING** : Vocal Assist ON / OFF
- 3 **MY-MIC** : MY-MIC.
- 4 **BACKGROUND CHANGE** : Changes backgrounds.
- 5 **THEME** : Selecting background image.
- 6 **SHORTCUT** : Guides directly to some modes.
- 7 **NAVIGATION** : Multi-function guide buttons.
- 8 **PLAY / STOP** : Plays & Stops a song or function.
- 9 **KEY** : Adjusts the song key.
- 10 **TEMPO** : Adjusts the song tempo.
- 11 **VOLUME** : Adjusts the volume.
- 12 **MELODY** : Adjusts the melody level.
- 13 **ECHO** : Adjusts the echo level.
- 14 **0~9** : Arabic numbers.
- 15 **←** : Cancel.
- 16 **RES** : Reserves and cancels a reservation.
- 17 **SEARCH** : Song search.
- 18 **MODE** : Functions.
- 19 **||** : Pause.
- 20 **RANDOM** : Random song select.
- 21 **REPEAT** : Section repeat.
- 22 **SCORE** : Changes the level of difficulty.
- 23 **M/F** : Converts voice to man's or woman's.
- 24 **VOICE** : Changes the voice.
- 25 **SILENCE** : Silence mode.
- 26 **REC** : Recording & Playback.

## KARAOKE

### 1 SONG SEARCH

#### I. Entering the Song Search Mode

- Press [SEARCH] or [MODE+4] on the remote control to enter the Song Search Screen.



#### II. Buttons for the song search mode on the remote control

- [SEARCH] : Press [SEARCH] repeatedly to select one of these three modes below.
  - 1) Searching by Title : You can search for a song by typing some letters or numbers or special characters of the song title. (Refer to "IV. How to Search a Song" on the next page, chapter 04-02)
  - 2) Searching by Singer : You can search for a song by typing some letters or numbers or special characters of the singer's name. (Refer to "IV. How to Search a Song" on the next page, chapter 04-02)
  - 3) Exit Mode : Neither the "title" icon nor the "singer" icon will be highlighted on the screen.
- [←] : Press this button to erase characters.
- [MODE] : Pressing this button repeatedly while keying in characters toggles you to either the letters, numbers or special characters.



### III. Exiting the "Song Search" mode

- After entering the "song search" mode, search a song using [▼], [▲], [◀], [▶] and play the song by pressing [▶/■] or reserve the song by pressing [RES].
- After entering the "song search" mode, set it to the "exit mode" by pressing [SEARCH] and end the search by pressing any number button.  
(If there are reserved songs, the list containing those reserved songs will be displayed on the screen.)

### IV. How to Search a Song

After entering the song search screen, press [MODE] to set one of the three input methods below.

#### ① Input letters

[1] [2] A → B → C [3] D → E → F [4] G → H → I [5] J → K → L  
[6] M → N → O [7] P → Q → R → S [8] T → U → V [9] W → X → Y → Z [0] SPACE

#### ② Input numbers

[1] → 1 [2] → 2 [3] → 3 [4] → 4 [5] → 5  
[6] → 6 [7] → 7 [8] → 8 [9] → 9 [0] → 0

#### ③ Input special characters

[1] . → , → : → ; [2] ' → " → ` [3] \_ → = → ~ [4] + → - → \* → / [5] ! → # → \$ → %  
[6] & → ? → @ [7] ^ → W → | [8] ( → ) → < → > [9] [ → ] [0] SPACE



(The search function disregards spaces. E.g. : If you want to search a song whose title is "A DONDE VOY," you only have to enter "AD" without space between characters to execute the search.)

- Press the [0] ~ [9] buttons to input characters.

#### - Examples

To enter "TOU" : Press [8] once → [6] three times → [8] two times

To enter "ABC" : Press [2] once → [2] two times → [2] three times



## 2 RECORDING

Use this function to record your singing(VOICE with the MUSIC) and to playback your recorded singing performance.

### 1. RECORDING TO THE MEMORY IN THE MAIN STATION

In case of no SD card and/or Recording Pack on the main station, follow the procedure below.

How to Use:

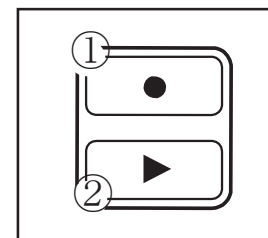

- 1) Select a song.
- 2) Press [●] the remote control to start recording ( ① ).
- 3) To stop : Press [▶/■].
- 4) To do playback : Press [▶] on the remote control ( ② ).
- 5) To stop the playback : Press [▶/■].

※ A song recorded less than two seconds will not be recorded.

※ You can record a song of up to five minutes long.  
(approximately for 1(one) song)

### 2. RECORDING TO AN SD CARD AND/OR RECORDING PACK

You can record your own singing into an SD card or a Recording Pack. If both the SD card and Recording Pack inserted at the same time, you need to decide which one to use. (The recording pack looks exactly the same as an additional song pack but contains no songs and its data is replaceable.)

How to Use:

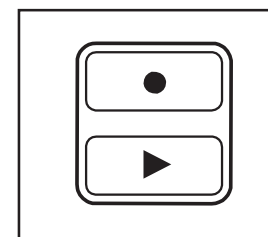

- 1) Insert an SD card or Recording Pack before turning on the main station.
- 2) Select a song.
- 3) Press [●] under the "RECORD" section on the remote control to start recording
- 4) To stop, press [▶/■].

- 5) To see the list of the recorded songs, press [▶] the remote control.
- 6) To play back the song, choose a recorded song first by pressing [▼], [▲], [◀], [▶] on the remote control. After selecting the song the song, press [▶/■] on the remote control.
- 7) To stop the playback, press [▶/■].
- 8) To delete a recorded song, choose the song and press [RES].

- ※ You can't record your singing to an SD card when MOVING PICTURES are playing. While an SD card or Recording Pack is being used, your singing cannot be recorded on the main station memory.
- ※ When an Additional Song Pack is used on the main station, songs recorded from the Additional Song Pack can be played or deleted too.
- ※ You cannot record your singing performance in the middle of the song. Therefore, even if you press [•] on the remote control while singing a song, the song stops, restarts, and then the recording takes place.
- ※ Settings such as tempo or key should be set in advance as these cannot be changed while the song is being recorded. Also, during the recording, certain functions such as continuous play or pause are not available.
- ※ Recording time
  1. Recording Pack : About 180 minutes (NAND 1Gb)
  2. SD card : About 60 Hours (2GB)  
(In case there is no files on the SD card)

### 3 MY-MIC

This function enables you to save your own customized settings over the song you chose such as the volume of music, melody, microphone, echo effect, and vocal assist as well as the tempo, key setting. You can recall these settings when you select and sing the song again.

#### 1. SAVING ADJUSTED SETTINGS

- While singing a song, adjust settings such as the volume of music, melody and so the way you want to customize the song, and then press [♥] while the song is still playing on the remote control.
- The song with the adjusted settings will be saved in the [MY-MIC] song list.  
(If the same song is already in the list, the song will be updated with new settings.)
- The lists containing the customized settings will be retained even after turning off the ET23KM.

#### 2. SELECTING & PLAYING A SONG

- Press [♥] to see the [MY-MIC] song list while not playing any song.
- Select the song from the list and press [▶/■] to play the song with the stored settings.

#### 3. DELETING A SONG

- Press [♥] while selecting a song to see the stored list of MY-MIC songs.
- Press [▼], [▲], [◀], [▶] to select the song you want to delete, and press [RES] to delete it.

## 4 USER'S CONTENTS

Users can play their own contents (MP3 and Picture) they saved in an SD card. Press [MODE + 7] to explore.

### 1. USER'S JPEG

Play & Enjoy your own picture through TV.

- Before putting JPEG files into an SD card, the files have to be converted by ET-MANAGER.  
(Refer to the "USER BACKGROUND" section)
- Insert the SD card into ET23KM.
- Select this function for your pictures to be shown on the screen.
- To move pictures forward and backward, press [◀] or [▶].
- To exit, press [⏪] or [RES].

### 2. MP3

Play & Enjoy MP3 files through TV.

(No need to convert any MP3 files and to use any music player.)

- Move the downloaded MP3 files into the "MP3" folder on the SD card from your PC.
- Insert the SD card into ET23KM.
- When you select this function, a MP3 list will appear on the screen.
- Select a song from the list and press [▶ / ■] to play the song.
- Follow the direction of "Control Bar" shown on the screen.
- To exit, press [⏪] or [RES].

## 5 THEME (BACKGROUND THEME AND SCOREBOARD)

### 1. THIS FUNCTION CAN ONLY BE SET BEFORE CHOOSING A SONG

- Press [MODE + 9 + 3] or [THEME] on the remote control for this function.

### 2. TO FINISH THIS FUNCTION, PRESS [RES]

### 3. BACKGROUND THEME

- You can select any theme from a set of nine different themes as screen background.
- Press number buttons [1] ~ [9] or [▼], [▲], [◀], [▶] to set the theme you want.

[1] Love	[2] Party	[3] Summer
[4] Nature	[5] Carnival	[6] Sports
[7] City	[8] Country	[9] Tour

Once a background theme is set, only the pictures related to the selected theme will be shown on the screen.

### 4. SCOREBOARD

- The scoreboard shows the corresponding song numbers and the scores of the songs that you have played.  
(Only 7 songs will be displayed on the screen.)

## 6 JUMP (PRELUDE / INTERLUDE SKIP)

- You can use the [JUMP] function only during the prelude or the interlude of a song.
- Press [JUMP] on the remote control to skip the prelude or the interlude part of a song.

## 7 VOCAL ASSIST (MULTIPLEX)

The song comes up with a professional singer's voice with the music. This feature is available only songs indicated "Vocal Assist" on the TV screen and song book.

### 1. VOCAL ASSIST [ ON ]

- If you wish to activate this function, press the [ ]  on remote control or [MODE + 5 + 4] to turn it ON, while singing a multiplex song.
- The voice will fade out when you sing a song and if you stop singing, the voice will fade in.

### 2. VOCAL ASSIST [ OFF ]

- If you wish to deactivate this function, press [ ]  or [MODE + 5 + 4] to turn it OFF, while singing a multiplex song, which enables you to sing along with the singer's voice.
- If you do not want to hear any voice of the vocal assist at all, press [—] button of [Vocal Assist] on the remote control, and then the volume bar will appear on the upper part of the TV screen. Then press [—] until it reaches "0".

### 3. VOLUME ADJUSTMENT

- Press Vocal Assist [—], [+] on the remote control to adjust the volume of the vocal assist until it reaches a desired level.

## 8 MUSICAL NOTATION (KEY NOTE GUIDE)

1. Press [MODE + 9 + 1] on the mic to see the song list containing only the songs with this note guide function.  
(This function is available only for the songs in the list.)
  2. Choose a song from the list and play the song.  
After that, press [MODE + 9 + 1] on the mic to choose one of the three settings which are "Normal", "Easy", and "OFF".
    - A. Normal : Displays the musical notes on the upper part of the screen with the original key of the song.
    - B. Easy : Displays the musical notes on the upper part of the screen with the basic "C" key.
    - C. OFF : Does not display any musical notes.
- ※ A musical notation appears on the upper part of the screen as soon as a song starts.
  - ※ This gives the user an idea of the key/pitch of the song he/she is about to sing.

## 9 USER BACKGROUND(SD CARD)

### 1. BACKGROUND IMAGES

- If you have background images in a folder named "BACKGROUND" on your SD card, you can display them on the TV screen when you select "USER'S JPEG" mode.

### 2. HOW TO USE

- Install "ET-MANAGER" on your computer using the CD provided with the mic.
- Execute "ET-MANAGER".
- Change the format of image files that you have by selecting "BACKGROUND IMAGE".
- When changing the image file format, these files are stored in a designated folder with the format of "\*.obj".
- Move the converted image files into the "BACKGROUND" folder on the SD card, and insert the SD card into the slot of the main station.
  - ※ If the SD card drive is designated as "E :\", and the converted image file is "image.obj", move the "image.obj" into the "E:\BACKGROUND" folder.
  - ※ Image file formats that you can convert into ".obj" format include Bitmap file (\*.bmp), JPEG file (\*.jpg, \*.jpeg), TIF file (\*.tif, \*.tiff), and GIF file (\*.gif).
  - ※ For the detail information, refer to "ET-MANAGER" section. (Chapter.04-17)

## HOW TO SING

This function is for users to keep practicing a particular part of a song they want by moving the part of the song forward and backward. Users also can find any particular parts of a song with its play time as well.

### 1. PURPOSE

- When you want to repeat some part of the song over and over to practice.
- When you want to move to some part of song without waiting.
- When you want to memorize some part of song.
- When you want to go backward to repeat singing.

### 2. HOW TO USE

- 1) Press [ II ] while singing.
- 2) Press [▼], [▲], [◀], [▶] to show lyrics
- 3) Press [▼], [▲] to go forward or backward.
- 4) Press [▶ / ■] to play.
- 5) Press [ II ] again if you want to repeat the part and follow the same procedure from 2) above.

※ Does not support any vocal assist on this mode.

## MOVIE

This mode is for users to enjoy music videos, moving pictures and their own contents downloaded from the internet such as MTV, movies, TV shows.

### 1. HOW TO USE

- 1) Press the [MOVIE] button located on the bottom part of the remote control.
  - 2) When the list of movies is shown, press the [▼], [▲] buttons to navigate through movie files, and then select the movie file you want to play.
  - 3) Press [▶ / ■] to play or stop.
  - 4) Press [◀◀], [▶▶] to move it faster (Pressing once : x2 faster, twice : x4 faster, three times : x8 faster and four times : x20 faster) and then press [▶ / ■] to play.
  - 5) Press [▼], [▲] to select another movie file you want to play.
  - 6) Press [ + ], [ - ] under the [VOLUME] section on the remote control to adjust the volume.
  - 7) **ZOOM** : Press [ 0 ]    **HELP** : Press [MODE]
- ※ If the capacity of a movie file is too big due to its high definition, some delay on its video and sound may occur.
- ※ ET23KM supports an SD memory card up to 8GB.

## GAME

When you select a game, its instructions will be displayed on the TV screen before the game starts.

### 1. SINGING CONTEST

- This contest will be held between team A and team B. Each team respectively selects three songs at random and sings them by turns. A team getting a higher score will be the winner. This game will be started by pushing any button on the mic except the power button. Have fun!!

### 2. SONG QUIZ

- Please listen carefully to the music and select a correct song title. If your answer is incorrect, one heart [1 point] will be reduced. There is also a bonus question in every five questions from which you get one heart [1 point] if your answer to that bonus question is correct. Please select one of the levels below by pressing the corresponding no. button on the mic to start the game.

### 3. IQ200

- This game is to test player's memory power. 1 or 2 player can play this game. Players have to memorize the keyboard number and press same key.

### 4. BINGO 1

- Game 1 : Randomly showing numbers from 1 to 99.
- To restart the game press [MODE] button.
- To exit, press [ ] or [RES] button.

### 5. BINGO 2

- Game 2 : 1~4 players can play at the same time. Players have to find a set of numbers from 1 to 9 to win and refer to the instructions on the screen.
- To restart the game press [MODE] button.
- To exit, press [ ] or [RES] button.

### 6. DART

- This game is called "Dart Game".
- Players throw darts to the target through their sound.
- If a player makes a higher or louder sound, the dart will go further and faster and vice versa.

### 7. TEN-TEN

Each player gets 5 cards and will have 10 seconds to make 20 or 10 in sum by adding number of 3 cards.  
Remaining 2 cards determines the winner.  
Add 2 remaining cards and only last digit number is the player's number.

Higher number wins the game.  
But if remaining 2 cards numbers are same.  
It is higher card than last digit single number (0,0) is the highest ranking number.

Ranking of number

Highest-----Lowest  
(0,0) (9,9) (8,8) (7,7) (6,6) (5,5) (4,4) (3,3) (2,2) (1,1) X9 X8 X7 X6 X5 X4 X3 X2 X1

#### ※ EXAMPLE

Player 1  
7 8 5 6 1 7+8+5=20 6+1=7 player 1's number 7

Player 2  
0 1 9 3 8 0+1+9=10 3+8=11 Player 2's number 1

Player 3  
8 3 9 7 7 8+3+9=20 7,7 same number Player 3's number (7,7)

Player 4  
1 8 1 0 0 1+8+1=10 0,0 same number Player 4's number (0,0)

1st place : Player 4, 2nd place : Player 3,  
3th place : Player 1, 4th place : Player 2

### 8. Black Jack

This game's rule is same as basic Blackjack rule.  
Goal of this game is making 21 with several numbers of player's card.

## CONFIGURATION MENU

1. Press [MODE]+[0] to enter the configuration menu.
2. Press [MODE] to exit the configuration.

[1] Select a function using [▼], [▲] or press the corresponding number on the left side of the function.

To select a sub-option, press the corresponding number on the left side again or press [▶/■].

[2] Select a function by pressing [▼], [▲]. And then press [0] to change its option, and press [▼], [▲] to select sub-options. (Press [▶/■] to exit a sub-option.)

### 3. CONFIGURATION OPTIONS

[1] SELECTING BACKGROUNDS : Users can select one of the four types of background images as below.

- 1) MAGIC SING JPEG : Showing built in JPEG image files as a background.
- 2) EXT-VIDEO INPUT : Showing external videos as a background.
- 3) MOVING PICTURE : Showing moving pictures (video files) from a SD card.
- 4) USER'S JPEG : Showing the user's JPEG files from an SD card.

[2] OUTPUT MODE : Sets the output mode to TV or AMP.

[3] LYRICS BAR : ON (A blue bar behind lyrics appears) / OFF. (The blue bar disappears)

[4] MIC V.C. : Changes your voice either to a female's or male's. (The "OFF" mode means to go back to your own voice)

### 4. ADVANCED CONFIGURATION

Press [5] in the config. menu to enter the advanced config.

1) Score Check

- BEGINNER : This level only evaluates your tempo when you sing a song.
- AMATEUR : This level evaluates both tempo and pitch when you sing a song. Singing in suitable chord is accepted.
- PROFESSIONAL : This level evaluates both tempo and pitch based on the original Song's key and tempo.
- OFF : Turns off(hides) score check function when you sing a song.

※ This setting remains until the product is reset or the values are changed by users.

2) Real Time Score : Shows your score throughout the whole song you are currently singing if you turn this function on.

3) Song Countdown : Sets the countdown (4, 3, 2, 1) display ON/OFF.

4) Lyrics Line : Selects the number of lyric lines shown on the TV screen (2 lines, 3 lines, Auto).

5) Lyrics Position : Sets the position of lyrics on the screen. (Center, Left-Right, All Mixed)

6) Language : Selects the language for the system.



## SOFTWARE INSTALLATION

Installing the ET manager and USB driver in your PC :

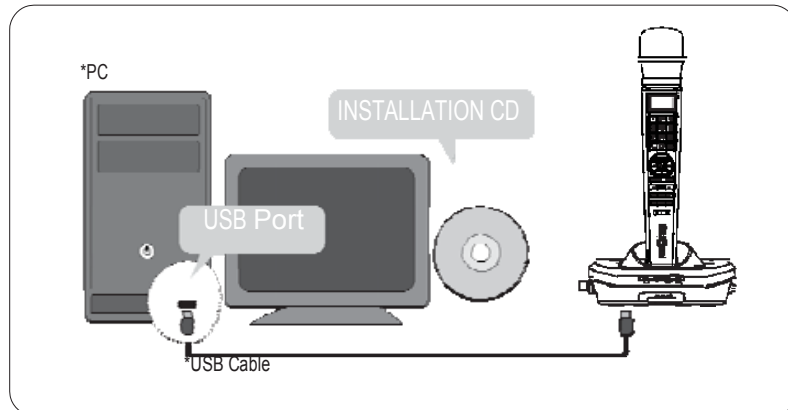

1. Enables you to use your own images or pictures in your computer as MagicSing background pictures on TV.
2. Enables you to convert the recorded songs from the Recording Pack to your PC as wave files.

Note : In the absence of the Installation CD, you can install the ET manager and USB driver softwares in your PC by downloading them from our website. ([www.enter-tech.com](http://www.enter-tech.com))

### 1 HOW TO INSTALL USB DRIVER + ET MANAGER

Insert the Installation CD into your PC, and then you will see the pop-up screen as shown below.



Note : Please do not connect MagicSing to a PC by USB cable before installing "Install USB Driver".

### 1) USB Driver Installation

This installation should be completed in advance to execute ET Manager. Click "Install USB Driver" (1) and follow the below instruction of "ET USB Driver - InstallShield Wizard" as shown below.

- a) Click "Next" to start the installation.

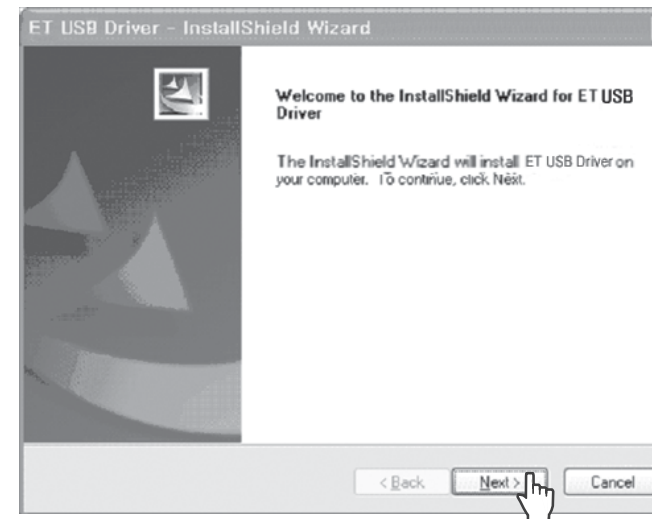

- b) Click "Continue anyway" to proceed.

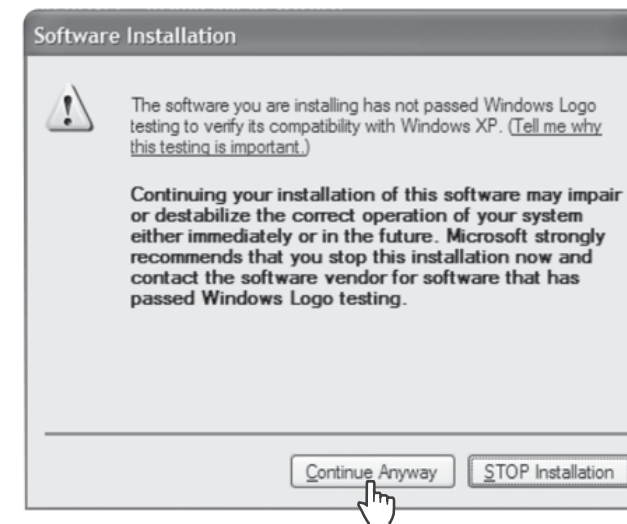

c) Select "Yes" and click "Finish" to restart the computer.

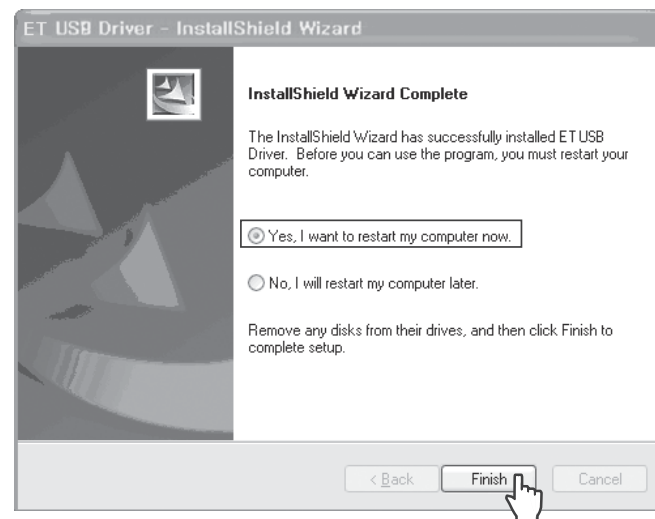

## 2) ET Manager Installation

After restarting the computer, take the "Installation CD" out and put it back into your PC again.

Click "Install ET Manager" (②) on the first pop-up screen and follow the instructions of "ET Manager InstallShield Wizard".

When you see the pop-up screen below, click "Finish" to complete the ET Manager installation.

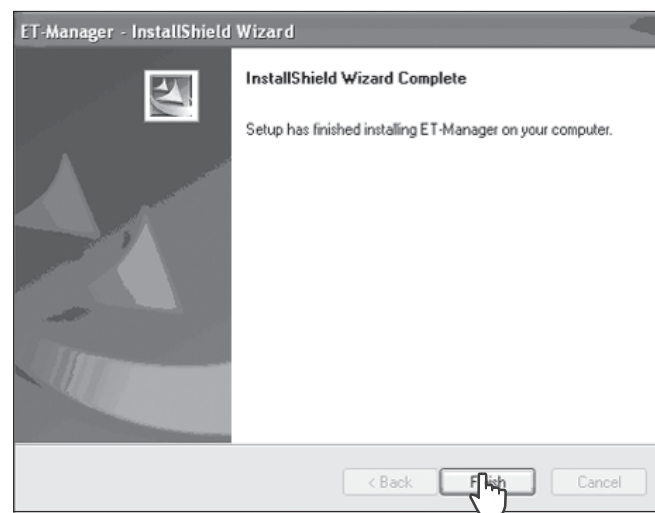

## 3) EXIT

After completing the two previous installations, you will see the screen below again.

In order to exit, click "Cancel" (③).



And follow the below steps to execute the ET Manager properly.

## 2 HOW TO CONNECT MAGICISING TO A PC WITH A USB CABLE

1. Turn on the power of main station.
2. Plug the USB cable in the PC's USB port as shown in the picture below.
3. Plug the USB cable in the MagicSing's USB port as shown in the picture below.

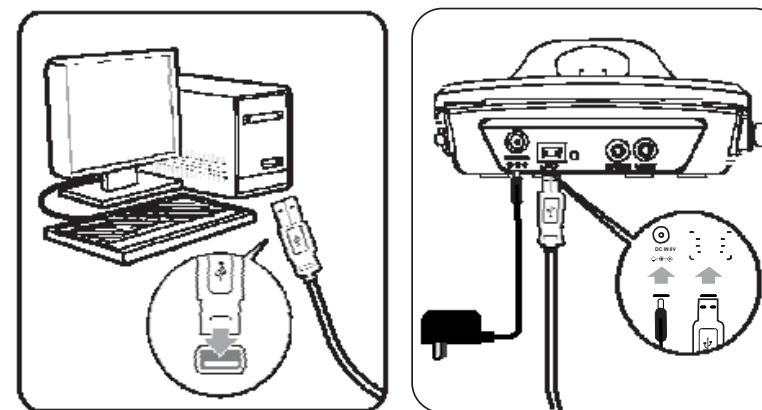

"USB CONNECTED" will appear on TV SCREEN.

4. When you connect MagicSing to a PC for the first time, the “Found New Hardware Wizard” window below will show up as it will try to search the USB driver in your PC system.

(In order to operate “ET manager”, the following steps should be completed.)

a) Click “Yes, this time only” and “Next” to continue.



b) Click “Install the software automatically (Recommended)” and “Next” to continue.

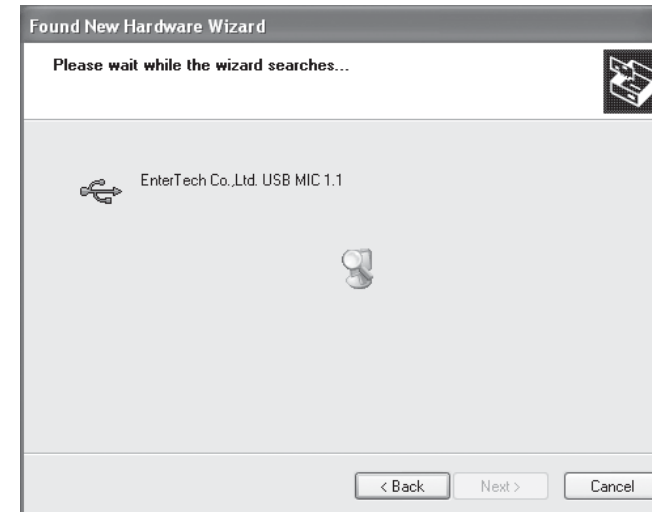
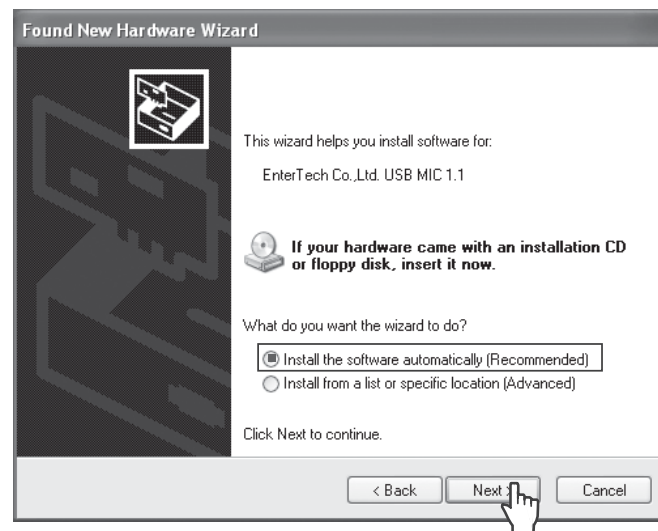

c) Click “Continue anyway” to proceed.

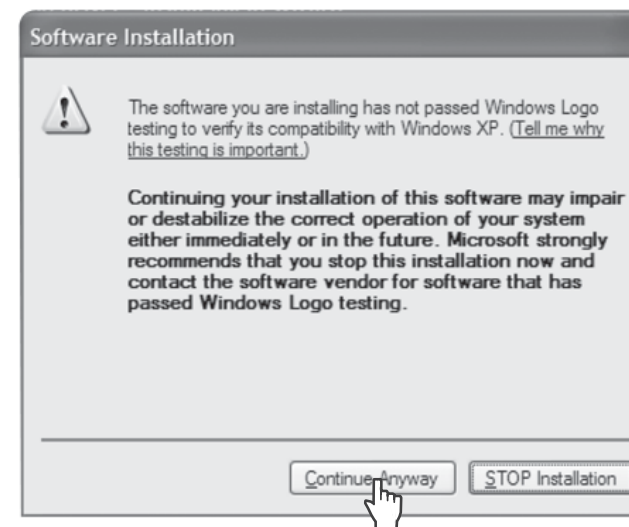

d) Click "Finish" to close the wizard.

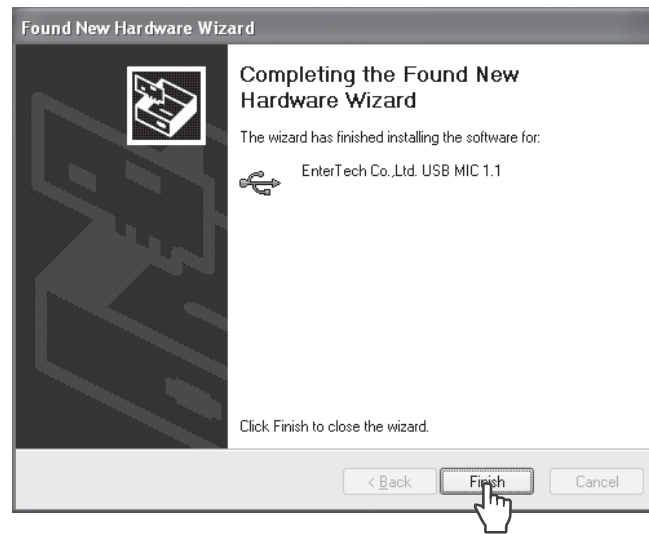

## ET MANAGER

### 1 GENERAL DESCRIPTION

#### A. Background Image

Converts image files you have in your PC into background images of MagicSing so that you can enjoy your personalized picture backgrounds on TV.

#### B. Recorded Song

You can save your songs in the Recording Pack and you can convert and transmit the recorded songs into your PC as a "MP2" file (USB cable needed) to play those through PC or MP3 player.

Note : This function is available only when you use a Recording Pack.

### 2 FUNCTION

#### A. Background Image

##### 1) User Interface Layout



- 1 **BACKGROUND IMAGE** : Shows the "Background Image" window when you click on this button.
- 2 **IMAGE FILE SEARCH WINDOW** : Enables you to search folders in your PC and select the images from the chosen folders.
- 3 **IMAGE VIEWER** : Enables you to see your chosen images.
- 4 **SAVE IMAGE IN SD CARD** : Converts the selected image to a MagicSing background image file when you click on this button.
- 5 **CONVERT PROGRESS BAR** : Shows the length of the time in which your image files are being saved into an SD card.
- 6 **EXIT** : Allows you to exit from the "ET manager window" above.

2) How to use

**STEP1**

- 1 Open the ET Manager window by double-clicking the ET Manager icon in your PC a "Background Image" screen will appear.
- 2 Search and select images from your files.(Choose from among the folders first, and then select an image by checking off the small box beside the file name.)  
Click the file name to see the image on the Image Viewer.
- 4 Click the "SAVE IMAGE IN SD CARD" to save the selected images as background files.

**STEP2**

- 6 Search for your SD card and click it, and then click ok.  
(You will see the progress bar moving which indicates that the files are being saved.)
- 7 To make sure that the images were saved in the SD card, open the SD card by clicking "My Computer", and then click "Removable Disk" (the SD card folder). You will see a folder entitled "BACKGROUND", click it and you will see your image files converted to EBJ.file format.

**STEP3**

- 8 Safely remove the SD card from your PC and insert it into the SD card slot located on the right side of the MagicSing main station.(IMPORTANT : THE MAIN STATION SHOULD BE TURNED OFF before inserting the .SD card)
- 9 Turn the main station on.  
MagicSing will automatically display the images saved in the SD card on your TV.

**B. Record**

1) User Interface Layout.

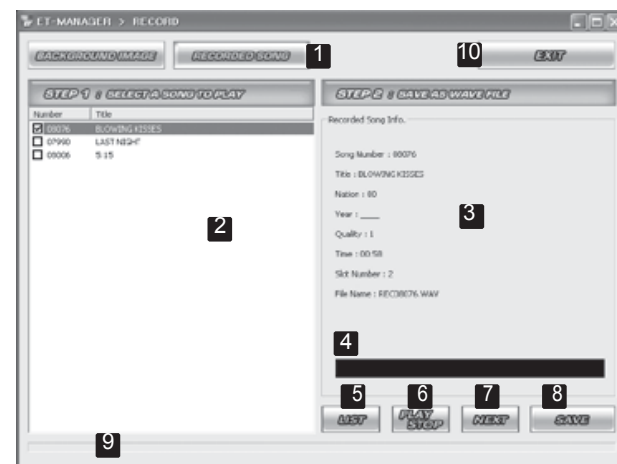

- 1 **RECORDED SONG** : Click on the "RECORDED SONG" tab to work with Recorded Songs.
- 2 **SONG LIST** : When you click "LIST", it shows you the list of the song titles recorded in the recording pack. (if there's any)
- 3 **RECORDED SONG INFO** : Shows the song info. of a song recorded in the recording pack which is currently playing.
- 4 **SONG COUNTER BAR** : Time counter of the song currently playing.
- 5 **LIST** : Clicking on this tab shows you the song titles(if there's any) in the "Song list" window.
- 6 **PLAY / STOP** : Clicking on this "PLAY" tab plays the selected song (Select a song by checking off the box beside the song title.) Clicking on this "STOP" tab stops the song currently playing. (The "PLAY" button will be transformed into the "STOP" button as soon as the song starts playing.)
- 7 **NEXT** : Clicking on this tab plays the next song on the list. (Check off the box first beside the song title(s) you want to play next.)
- 8 **SAVE** : Clicking on this tab saves the selected songs in your PC as a MP2 file.
- 9 **DOWNLOAD PROGRESS BAR** : Shows the length of the recorded song currently playing.
- 10 **EXIT** : Allows you to exit from the "RECORDED SONG" window.

2) How to use

- 1 Insert a recording pack into the main station and turn on the power.
- 2 If there are recorded songs in the recording pack, just go to step 3. If not, record your favorite songs first which you want to convert and save into your PC.
- 3 Connect the main station to a PC by USB cable.
- 4 Execute "ET MANAGER".
- 5 Click on the "RECORDED SONG" tab.
- 6 Click on the "LIST" tab to show you the song titles (if there's any) in the "Song List" window.
- 7 Select a song from the song list by checking off the box beside the song.
- 8 Click on the "PLAY / STOP" tab to hear the selected song on your PC.
- 9 Click on the "NEXT" tab to play the next song.  
(Check off the box first beside the song title(s) you want to play next.)
- 10 Click on the "PLAY / STOP" tab to stop the song currently playing.
- 11 Click on the "SAVE" tab to save the selected song into your PC as a MP2 file.

## RECORDING PACK

You can record your own singing into the Recording Pack.

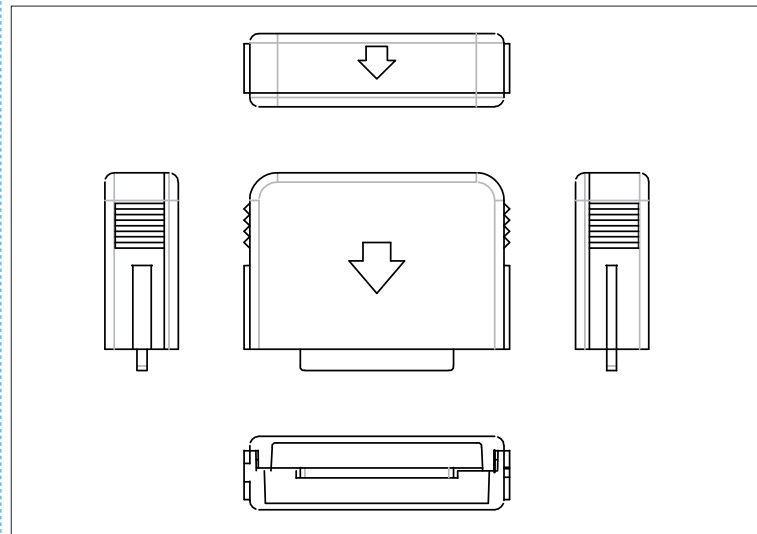

- **Turn off MagicSing** : MagicSing should be turned off first.
- Insert the Recording Pack into one of the slots in the back of the main station according to the direction of the arrow.
- Turn on the power of main station then select a song number and press [ • ] under the “record” section on the remote control.
- To stop the recording, press [ • ] again on the remote control or you can also press [▶/■].
- To play back the recorded songs, press [▶] under the “record” section on the remote control, and your recorded songs will be listed on the screen. Select a song using [▼/▲], then press [▶/■].
- To stop the playback, press [▶/■] again.
- To delete the recorded songs, press [RES] on the highlighted songs.
- ~~You cannot record your singing performance in the internal memory of main station while you are recording it in the recording pack.~~
- ~~You cannot record your singing performance in the middle of a song. If you press [ • ] in the middle of the song, the song stops, restarts, and then recording takes place.~~
- ~~The Tempo, Jump and Key functions will not work when you are playing back the recorded songs.~~

## ADDITIONAL SONG PACK

You can add more of your favorite songs to MagicSing.

### How to Insert an Additional Song Pack

First, turn OFF the power. This is very important to turn off the main station before removing or inserting a song pack.

main station

- Turn off the power of the main station
- Pull up the clip lock on the back cover of the main station, according to the direction of the arrow, then remove the back cover.

Clip Lock

- Make sure the arrow on the song pack is pointing left when you insert the song pack.  
(6 additional song packs can be inserted.)

- After the song pack is inserted, close the back cover.
- Turn on the power of main station.

### SONG LIST INSERTION

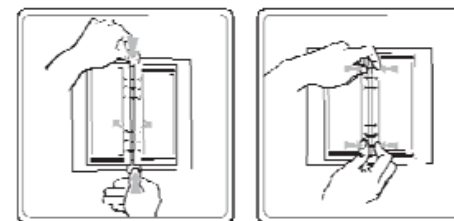

Press down both the top and the bottom metal tabs of the binder simultaneously to open the binder rings.

Insert the new song list between the binder rings.

Close the binder rings.

## PRECAUTION



Use the adaptor that comes with MagicSing only. There are many adaptors that are plug-compatible with MagicSing, but have different electrical specifications. These adaptors would work only for a short period of time but would very soon damage MagicSing.

### USE THE RECOMMENDED ACCESSORIES ONLY (DC 9V / 1A)



Do not drop MagicSing. Any external or internal damage due to dropping is not covered under warranty.



Do not insert or remove song packs while MagicSing is turned on.



Do not store MagicSing in direct sunlight, in a high temperature, or highly humid.



Do not use strong chemicals to clean MagicSing, as these chemicals may damage the unit. Keep MagicSing away from pets and small children.



Do not press the LED / LCD part.



Never use a sharp object on the keypad.



In case MagicSing was stored in a high-temperature setting, allow sufficient time for it to cool down before using it.



Do not immerse MagicSing in water or splash water on it. Water damage is not covered by the warranty.



Do not disassemble the parts of the MagicSing. This will void the warranty.



Do not plug MagicSing in if it is wet. Immediately contact the service center. If any solid object or liquid gets inside MagicSing, unplug it and have it checked by our service center.

## TROUBLESHOOTING

In case of problems, please check the following recommendations before contacting the service center.

### If MagicSing doesn't power up

#### ET23KM MAIN STATION

Make sure the adaptor is correctly plugged into the power outlet. Check that the male plug is properly inserted into the female jack.

#### WIRELESS KARAOKE

Check if the battery type is AA. If the battery is low, MagicSing may not work properly.

### If the user's voice cannot be heard

Press the VOL button and check the volume of the wireless karaoke.

### If the TV does not show pictures or emit sound

Make sure all the AV connectors are properly connected according to the correct colors. Check if the TV is in the video mode.

### If the video does not show properly (converting PAL or NSC mode)

To convert to PAL mode, turn off a wireless mic first. Press and hold button "8" on the wireless mic, and then press "POWER" button using another finger until the word "PAL" appears on the TV screen. (Do not release button "8" and the "POWER" button until the word "PAL" appears on the TV screen.) To convert to NTSC mode, turn off a wireless mic first. Press and hold button "9" on the wireless mic, and then press the "POWER" button using another finger until the word "NTSC" appears on the TV screen. (Do not release button "9" and the "POWER" button until the word "NTSC" appears on the TV screen.)

### If there is any doubt about the product's performance

Turn off a wireless mic first, and then press and hold the "0" button on the wireless mic, and press the [POWER] button using another finger until the words "USER RESET" appear on the TV screen. (Do not release the "0" button and the [POWER] button until the words "USER RESE" appear on the TV screen)

**When the wireless karaoke needs to be repaired, the main station should be included and returned to your nearest service center.**

**To contact our nearest service center in your area, please visit our website. "www.enter-tech.com"**



VER.100

[WWW.ENTER-TECH.COM](http://WWW.ENTER-TECH.COM)

**ENTER-TECH CO.,LTD.**

Enter B/D, 156-7, Ojeong-dong, Ojeong-gu, Bucheon-City, Kyunggi-do, Korea ( 421-814 )  
TEL : +82-32-673-1671 / +82-2-2605-0884 | FAX : +82-2-2691-5354 | E-MAIL : enter@enter-tech.com  
Designed by ENTER-TECH KOREA | Printed in China  
VER.100