



FCC 47 CFR PART 15 SUBPART C: 2008 AND ANSI C63.4: 2003

TEST REPORT

For

WiFi Internet Melody Station

Model Number: MAA502AM

Brand Name: AMIT; ZALiP

Issued for

Advance Multimedia Internet Technology Inc.

No.28, Lane 31, Sec. 1, Huandong Rd., Sinshih Township, Tainan County 74146, Taiwan

Issued by

Compliance Certification Services Inc.

Tainan Lab.

**No. 8, Jiu Cheng Ling, Jiaokeng Village, Sinhua
Township, Tainan Hsien 712, Taiwan R.O.C.**

TEL: 886-6-580-2201

FAX: 886-6-580-2202



Note: This report shall not be reproduced except in full, without the written approval of Compliance Certification Services Inc. Ltd. This document may be altered or revised by Compliance Certification Services Inc. personnel only, and shall be noted in the revision section of the document

Total Page: 117



REVISION HISTORY

Rev.	Issue Date	Revisions	Effect Page	Revised By
00	January 29, 2010	Initial Issue	ALL	Leah Peng



TABLE OF CONTENTS

1. TEST REPORT CERTIFICATION	4
2. EUT DESCRIPTION	5
2.1 DESCRIPTION OF EUT & POWER	5
3. DESCRIPTION OF TEST MODES.....	7
4. TEST METHODOLOGY.....	8
5. FACILITIES AND ACCREDITATIONS.....	8
5.1 FACILITIES.....	8
5.2 EQUIPMENT.....	8
5.3 LABORATORY ACCREDITATIONS LISTINGS.....	8
5.4 TABLE OF ACCREDITATIONS AND LISTINGS	9
6. CALIBRATION AND UNCERTAINTY	10
6.1 MEASURING INSTRUMENT CALIBRATION.....	10
6.2 MEASUREMENT UNCERTAINTY	10
7. SETUP OF EQUIPMENT UNDER TEST	11
7.1 SETUP CONFIGURATION OF EUT	11
7.2 SUPPORT EQUIPMENT	11
7.3 EUT OPERATING CONDITION.....	12
8. APPLICABLE LIMITS AND TEST RESULTS.....	13
8.1 6DB BANDWIDTH.....	13
8.2 MAXIMUM PEAK OUTPUT POWER	24
8.3 MAXIMUM PERMISSIBLE EXPOSURE	35
8.4 POWER SPECTRAL DENSITY	37
8.5 CONDUCTED SPURIOUS EMISSION	47
8.6 RADIATED EMISSIONS.....	58
8.7 POWERLINE CONDUCTED EMISSIONS	105
9. ANTENNA REQUIREMENT.....	111
9.1 STANDARD APPLICABLE	111
9.2 ANTENNA CONNECTED CONSTRUCTION.....	111
APPENDIX SETUP PHOTOS.....	112



1. TEST REPORT CERTIFICATION

Applicant : Advance Multimedia Internet Technology Inc.

Address : No.28, Lane 31, Sec. 1, Huandong Rd., Sinshih Township, Tainan County
74146, Taiwan

Manufacture : Advance Multimedia Internet Technology Inc.

Address : No.28, Lane 31, Sec. 1, Huandong Rd., Sinshih Township, Tainan County
74146, Taiwan

Equipment Under Test : WiFi Internet Melody Station

Model Number : MAA502AM

Brand Name : AMIT; ZALiP

Date of Test : December 9, 2009 ~ December 28, 2009

APPLICABLE STANDARD	
STANDARD	TEST RESULT
FCC Part 15 Subpart C : 2008 AND ANSI C63.4 : 2003	No non-compliance noted

Approved by:

Jeter Wu
Section Manager

Reviewed by:

Eric Yang
Senior Engineer



2. EUT DESCRIPTION

2.1 DESCRIPTION OF EUT & POWER

Product Name	WiFi Internet Melody Station
Model Number	MAA502AM
Brand Name	AMIT; ZALiP
Frequency Range	IEEE 802.11b/g, 802.11n HT20 (DTS Band):2412MHz~2462MHz IEEE 802.11n HT40 (DTS Band):2422MHz~2452MHz
Transmit Power (ERP)	IEEE 802.11b Mode : 20.70dBm (DTS Band) (117.49 mW) IEEE 802.11g Mode : 21.53dBm (DTS Band) (142.233 mW) IEEE 802.11n HT20 Mode : 17.13dBm (DTS Band) (51.6416 mW) IEEE 802.11n HT40 Mode : 17.08dBm (DTS Band) (51.0505 mW)
Channel Spacing	IEEE 802.11b/g, 802.11n HT20/HT40: 5MHz
Channel Number	IEEE 802.11b/g, 802.11n HT20:11 Channels IEEE 802.11n HT40 :7 Channels
Transmit Data Rate	IEEE 802.11b : 11, 5.5, 2, 1 Mbps IEEE 802.11g : 54, 48, 36, 24, 18, 12, 9, 6 Mbps IEEE 802.11n HT20 : 65, 58.5, 52, 39, 26, 19.5, 13, 6.5 Mbps IEEE 802.11n HT40 : 135, 121.5, 108, 81, 54, 40.5, 27, 13.5 Mbps
Type of Modulation	IEEE 802.11b : DSSS (CCK, DQPSK, DBPSK)
	IEEE 802.11g : OFDM (64QAM, 16QAM, QPSK, BPSK)
	IEEE 802.11n HT20/40 : OFDM (64QAM, 16QAM, QPSK, BPSK)
Frequency Selection	By software / firmware
Antenna Type	PIFA Antenna 4.14dBi (Built-in PIFA antenna) Manufacture: Wha Yu Group; Antenna model: SSR-92899
EUT Power Rating	Powered from Adapter Adapter1: AMIGO I.T.E. POWER SUPPLY Model: AMS3-1201500FU Input: 100-240Vac, 50/60Hz, 0.5A Output: 12Vdc, 1.5A



	Adapter2:PHIHONG SWITCHING POWER SUPPLY Model: PSA18R-120P Input: 100-240Vac, 0.5A, 50-60Hz, 40-60VA Output: 12Vdc, 1.5A
Power Source	120Vac, 60Hz
Remote Control	1 pcs .
Temperature Range	0 ~ +55°C

REMARK:

1. The sample selected for test was engineering sample that approximated to production product and was provided by manufacturer.
2. This submittal(s) (test report) is intended for FCC ID: **PBLMAA502AM** filing to comply with Section 15.207,15.209 and 15.247 of the FCC Part 15, Subpart C Rules.
3. For more details, please refer to the User's manual of the EUT.
4. Client consigns one model sample(**Model Number: MAA502AM**) and two adapters to test (**Adapter Model Number: AMS3-1201500FU & PSA18R-120P**). Therefore, the testing Lab. just guarantees the unit, which has been tested.



3. DESCRIPTION OF TEST MODES

The EUT is a WiFi Internet Melody Station.

The antenna peak gain 4.14dBi were chosen for full testing.

IEEE 802.11 b ,802.11g ,802.11n HT20 mode (DTS Band)

The EUT had been tested under operating condition.

There are three channels have been tested as following:

Channel	Frequency (MHz)
Low	2412
Middle	2437
High	2462

IEEE 802.11b mode: 11Mbps data rate (worst case) were chosen for full testing.

IEEE 802.11g mode: 6Mbps data rate (worst case) were chosen for full testing.

IEEE 802.11n HT20 mode: 6.5Mbps data rate (worst case) were chosen for full testing.

IEEE 802.11n HT40 mode (DTS Band)

The EUT had been tested under operating condition.

There are three channels have been tested as following:

Channel	Frequency (MHz)
Low	2422
Middle	2437
High	2452

IEEE 802.11n HT40 mode: 13.5Mbps data rate (worst case) were chosen for full testing.

The worst-case data rates are determined according to the description above, based on the investigations by measuring the PSD, peak power and average power across all the data rates, bandwidths, modulations and spatial stream modes.

The worst-case channel is determined as the channel with the highest output power. The highest measured output power was at 2437 MHz.



4. TEST METHODOLOGY

The tests documented in this report were performed in accordance with ANSI C63.4 and FCC CFR 47 2.1046, 2046, 2.1047, 2.1049, 2.1051, 2.1053, 2.1055, 2.1057, 15.207, 15.209 and 15.247.

5. FACILITIES AND ACCREDITATIONS

5.1 FACILITIES

All measurement facilities used to collect the measurement data are located at No. 8, Jiu Cheng Ling, Jiaokeng Village, Sinhua Township, Tainan Hsien 712, Taiwan R.O.C. The sites are constructed in conformance with the requirements of ANSI C63.7, ANSI C63.4 and CISPR Publication 22.

5.2 EQUIPMENT

Radiated emissions are measured with one or more of the following types of linearly polarized antennas: tuned dipole, biconical, log periodic, bi-log, and/or ridged waveguide, horn. Spectrum analyzers with preselectors and quasi-peak detectors are used to perform radiated measurements.

Conducted emissions are measured with Line Impedance Stabilization Networks and EMI Test Receivers.





Calibrated wideband preamplifiers, coaxial cables, and coaxial attenuators are also used for making measurements.

All receiving equipment conforms to CISPR Publication 16-1, "Radio Interference Measuring Apparatus and Measurement Methods."

5.3 LABORATORY ACCREDITATIONS LISTINGS

The test facilities used to perform radiated and conducted emissions tests are accredited by Taiwan Accreditation Foundation for the specific scope of accreditation under Lab Code: 1109 to perform Electromagnetic Interference tests according to FCC PART 15 AND CISPR 22 requirements. No part of this report may be used to claim or imply product endorsement by TAF or any agency of the Government. In addition, the test facilities are listed with Federal Communications Commission (registration no: TW-1037).

5.4 TABLE OF ACCREDITATIONS AND LISTINGS

Country	Agency	Scope of Accreditation	Logo
USA	FCC	3/10 meter Open Area Test Sites to perform FCC Part 15/18 measurements	 TW-1037
Japan	VCCI	3/10 meter Open Area Test Sites and conducted test sites to perform radiated/conducted measurements	 C-2882 R-2635
Taiwan	TAF	CISPR 11, FCC METHOD-47 CFR Part 18, EN 55011, EN 60601-1-2, CISPR 22, CNS 13438, EN 55022, EN 55024, AS/NZS CISPR 22 CISPR 14, EN 55014-1, EN 55014-2, CNS 13783-1, CISPR 22, CNS 13439, EN 55013, FCC Method-47 CFR Part 15 Subpart B, IC ICES-003, VCCI V-3 & V-4 FCC Method-47 CFR Part 15 Subpart C and ANSI C63.4, LP 0002 EN / IEC 61000-4-2 / -3 / -4 / -5 / -6 / -8 / -11 EN 61000-3-2, EN 61000-3-3 EN 61000-6-3, EN 61000-6-1, AS/NZS 4251.1, EN 61000-6-4, EN 61000-6-2, AS/NZS 4251.2, EN 61204-3, EN 50130-4, EN 62040-2, EN 50371, EN 50385, AS/NZS 4268, ETSI EN 300 386 ETSI EN 300 328, ETSI EN 301 489-1/-3/-9/-17 ETSI EN 301 893, ETSI EN 300 220-2/-1 ETSI EN 300 440-2/-1 ETSI EN 301 357-2/-1 RSS-310, RSS-210 Issue 7, RSS-Gen Issue 2	 Testing Laboratory 1109
Taiwan	BSMI	CNS 13438, CNS 13783-1, CNS13439	 SL2-IN-E-0039 SL2-R1/R2-0039 SL2-A1-E-0039
Canada	Industry Canada	RSS210, Issue 7	 IC 2324H-1

* No part of this report may be used to claim or imply product endorsement by TAF or any agency of the US Government.



6. CALIBRATION AND UNCERTAINTY

6.1 MEASURING INSTRUMENT CALIBRATION

The measuring equipment utilized to perform the tests documented in this report has been calibrated in accordance with the manufacturer's recommendations, and is traceable to recognized national standards.

6.2 MEASUREMENT UNCERTAINTY

Where relevant, the following measurement uncertainty levels have been estimated for tests performed on the apparatus:

Uncertainty figures are valid to a confidence level of 95%, K=2

7. SETUP OF EQUIPMENT UNDER TEST

7.1 SETUP CONFIGURATION OF EUT

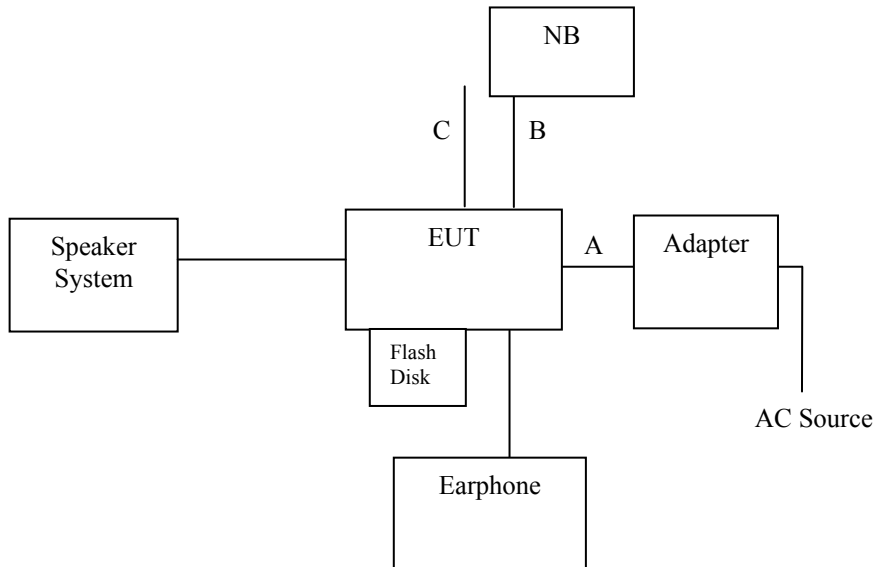

7.2 SUPPORT EQUIPMENT

No.	Product	Manufacturer	Model No.	FCC ID	Signal Cable
1	Speaker System	KINKO	KY-550	R34100	Audio cable, unshd, 1.6m
2	Flash Disk	Kingston	DTI/512	DOC	N/A
3	Note Book	IBM	R51	R33026	Power cable, unshd, 1.6m
4	Earphone	N/A	N/A	DOC	Earphone cable, unshd, 1.6m

No.	Signal cable description	
A-1	DC power cable (AMIGO)	Unshielded, 1.6m, 1pcs.
A-2	DC power cable (PHIHONG)	Unshielded, 1.9m, 1pcs., with a core
B	LAN cable	Unshielded, 10m, 1pcs.
C	Antenna cable	Unshielded, 1.4m, 1pcs.

REMARK:

- All the above equipment/cables were placed in worse case positions to maximize emission signals during emission test.
- Grounding was established in accordance with the manufacturer's requirements and conditions for the intended use.



7.3 EUT OPERATING CONDITION

RF Setup

1. Set up all computers like the setup diagram.
2. The “Ralink QA Test Program for RT3052” software was used for testing
The EUT driver software installed in the host support equipment during testing was Ralink QA Test Program for RT3052 Drive

TX Mode:

- ⇒ **Tx Mode:**CCK 、OFDM 、 HT MixMode (Bandwidth: 20 、 40)
- ⇒ **Tx Data Rate:** 11Mbps long (IEEE 802.11b mode ,chain 0 TX)
6Mbps (IEEE 802.11g mode ,chain 0 TX)
6.5Mbps (IEEE 802.11n HT20 mode ,chain 0 TX)
13.5Mbps (IEEE 802.11n HT40 mode, chain 0 TX)

Power control mode

- Target Power:** IEEE 802.11b Channel Low (2412MHz) = **10 (Chain 0)**
IEEE 802.11b Channel Middle (2437MHz) = **10 (Chain 0)**
IEEE 802.11b Channel High (2462MHz) = **0F (Chain 0)**
- Target Power:** IEEE 802.11g Channel Low (2412MHz) = **10 (Chain 0)**
IEEE 802.11g Channel Middle (2437MHz) = **10 (Chain 0)**
IEEE 802.11g Channel High (2462MHz) = **0C (Chain 0)**
- Target Power:** IEEE 802.11n HT20 Channel Low (2412MHz) = **10 (Chain 0)**
IEEE 802.11 n HT20 Channel Middle (2437MHz) = **10 (Chain 0)**
IEEE 802.11 n HT20 Channel High (2462MHz) = **0F (Chain 0)**
- Target Power:** IEEE 802.11n HT40 Channel Low (2422MHz) = **10 (Chain 0)**
IEEE 802.11 n HT40 Channel Middle (2437MHz) = **10 (Chain 0)**
IEEE 802.11 n HT40 Channel High (2452MHz) = **0F (Chain 0)**

(2) RX Mode :

Start RX

3. All of the function are under run.
4. Start test.

Normal Link Setup

1. Set up all computers like the setup diagram.
 2. All of the function are under run.
 3. Notebook PC (2) ping 192.168.0.10 -t to Notebook PC (1).
 4. Notebook PC (1) ping 192.168.0.20 -t to Notebook PC (2).
 5. Notebook PC (1) ping 192.168.0.50 -t to Wireless Access Point (3).
- Start test.



8. APPLICABLE LIMITS AND TEST RESULTS

8.1 6DB BANDWIDTH

LIMIT

§ 15.247(a) (2) For direct sequence systems, the minimum 6dB bandwidth shall be at least 500kHz

TEST EQUIPMENTS

Name of Equipment	Manufacturer	Model	Serial Number	Calibration Due
Spectrum Analyzer	R&S	FSEK 30	835253/002	OCT. 14, 2010

TEST SETUP

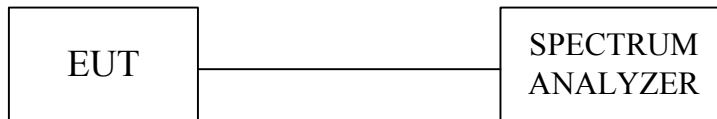

TEST PROCEDURE

The transmitter output was connected to a spectrum analyzer. The bandwidth of the fundamental frequency was measured by spectrum analyzer with 100 KHz RBW and 100 KHz VBW. The 6dB bandwidth is defined as the total spectrum the power of which is higher than peak power minus 6dB.

**TEST RESULTS**

No non-compliance noted.

IEEE 802.11b mode (One TX)

Channel	Channel Frequency (MHz)	6dB Bandwidth (kHz)	Minimum Limit (kHz)	Pass / Fail
Low	2412	12124	500	PASS
Middle	2437	12184	500	PASS
High	2462	12224	500	PASS

NOTE :

1. At final test to get the worst-case emission at 11Mbps.
2. The cable assembly insertion loss of 11.7dB (including 10 dB pad and 1.7 dB cable) was entered as an offset in the spectrum analyzer to allow for direct reading of power.

IEEE 802.11g mode (One TX)

Channel	Channel Frequency (MHz)	6dB Bandwidth (kHz)	Minimum Limit (kHz)	Pass / Fail
Low	2412	16531	500	PASS
Middle	2437	16535	500	PASS
High	2462	16533	500	PASS

NOTE :

1. At final test to get the worst-case emission at 6Mbps.
2. The cable assembly insertion loss of 11.7dB (including 10 dB pad and 1.7 dB cable) was entered as an offset in the spectrum analyzer to allow for direct reading of power.

**IEEE 802.11n HT20 mode (One TX)**

Channel	Channel Frequency (MHz)	6dB Bandwidth (kHz)	Minimum Limit (kHz)	Pass / Fail
Low	2412	17835	500	PASS
Middle	2437	17824	500	PASS
High	2462	17834	500	PASS

- NOTE :**
1. At final test to get the worst-case emission at 6.5Mbps.
 2. The cable assembly insertion loss of 11.7dB (including 10 dB pad and 1.7 dB cable) was entered as an offset in the spectrum analyzer to allow for direct reading of power.

IEEE 802.11n HT40 mode (One TX)

Channel	Channel Frequency (MHz)	6dB Bandwidth (kHz)	Minimum Limit (kHz)	Pass / Fail
Low	2422	36248	500	PASS
Middle	2437	36251	500	PASS
High	2452	36272	500	PASS

- NOTE :**
1. At final test to get the worst-case emission at 13.5Mbps.
 2. The cable assembly insertion loss of 11.7dB (including 10 dB pad and 1.7 dB cable) was entered as an offset in the spectrum analyzer to allow for direct reading of power.



6dB BANDWIDTH (802.11b MODE)

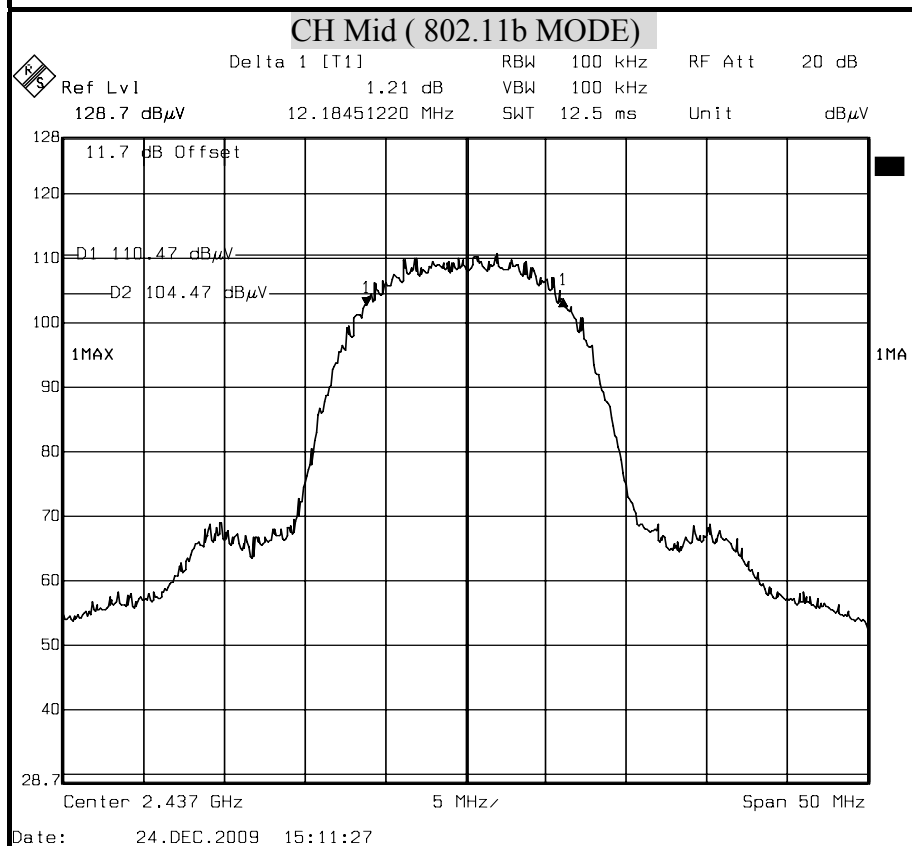
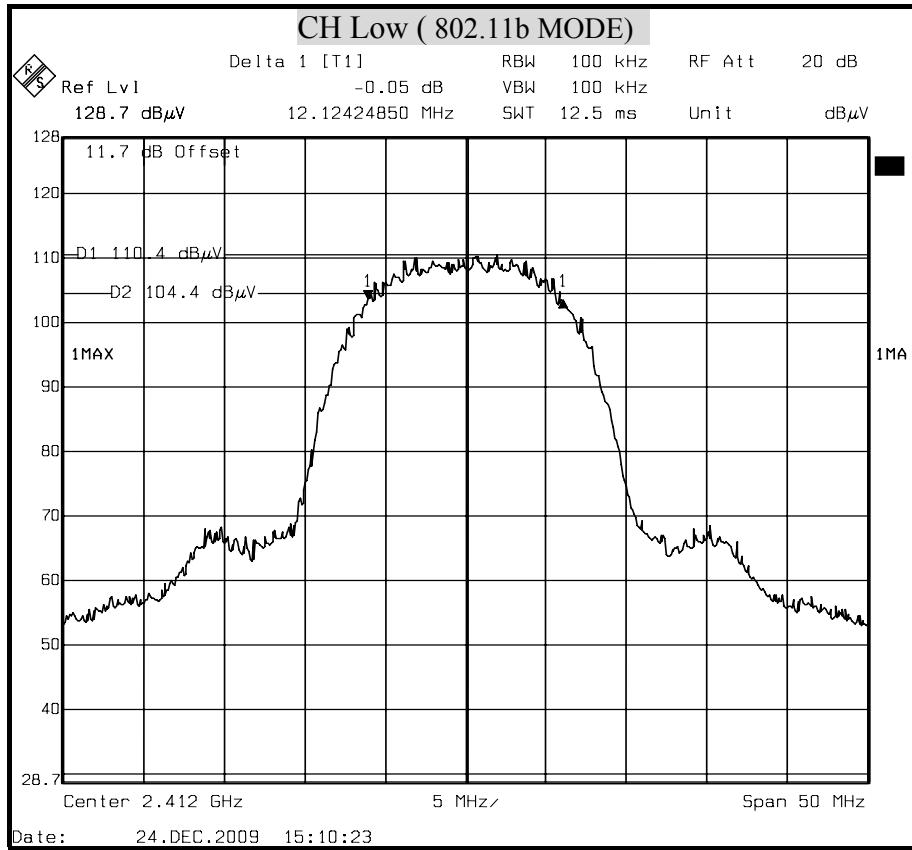

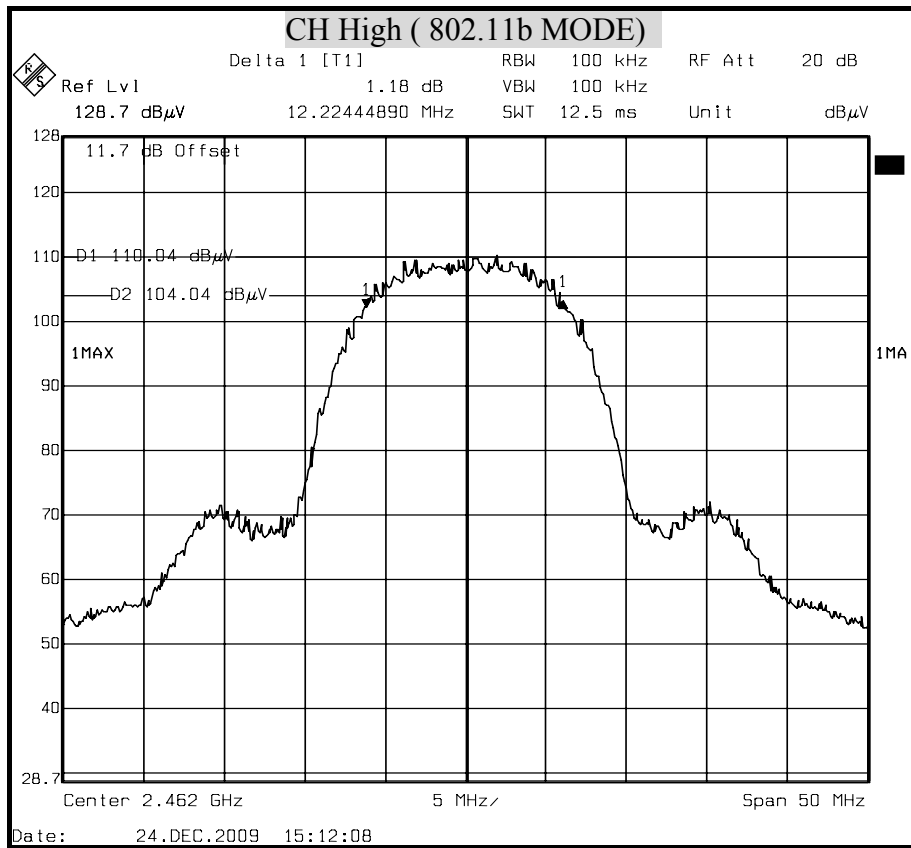



6dB BANDWIDTH (802.11g MODE)

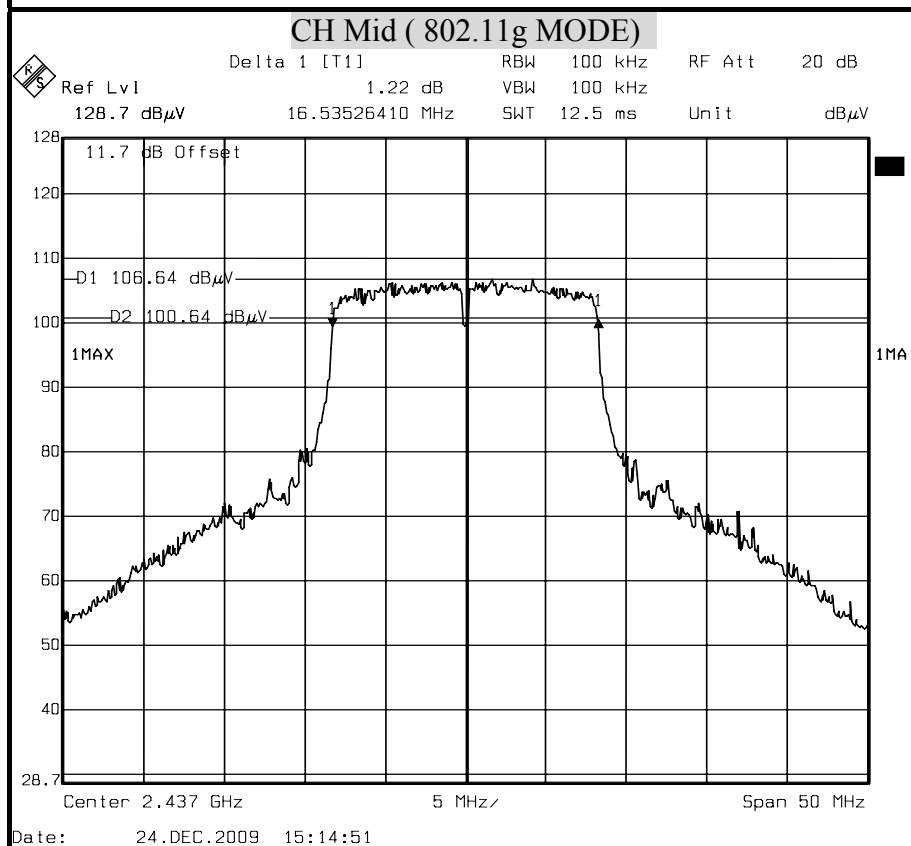
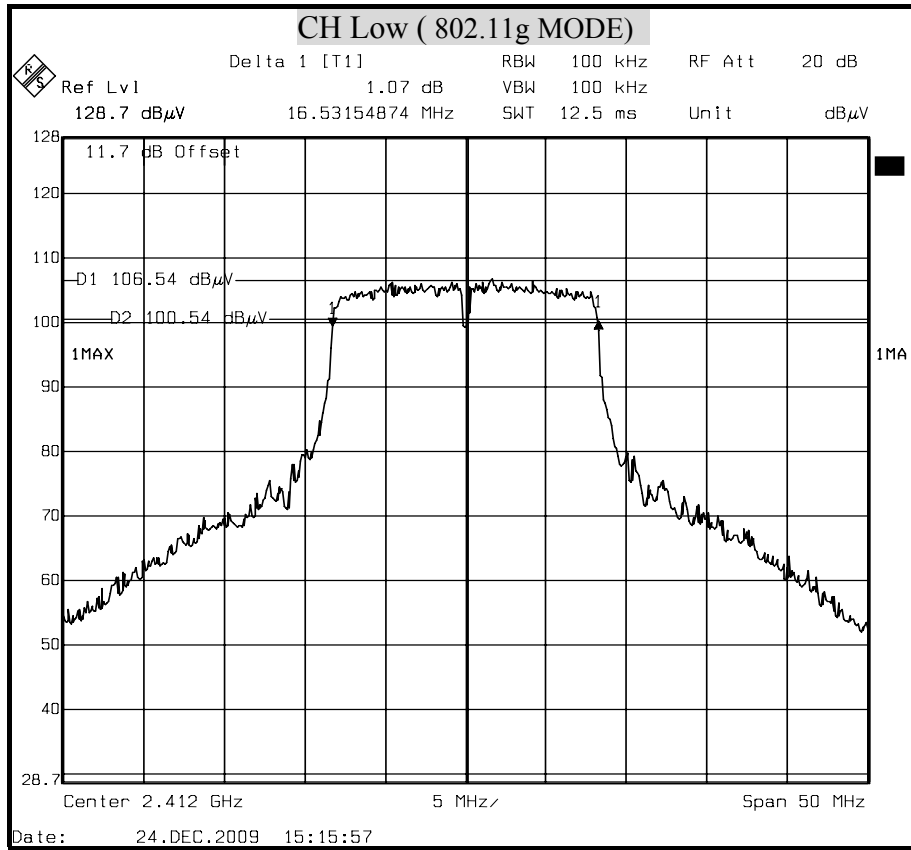

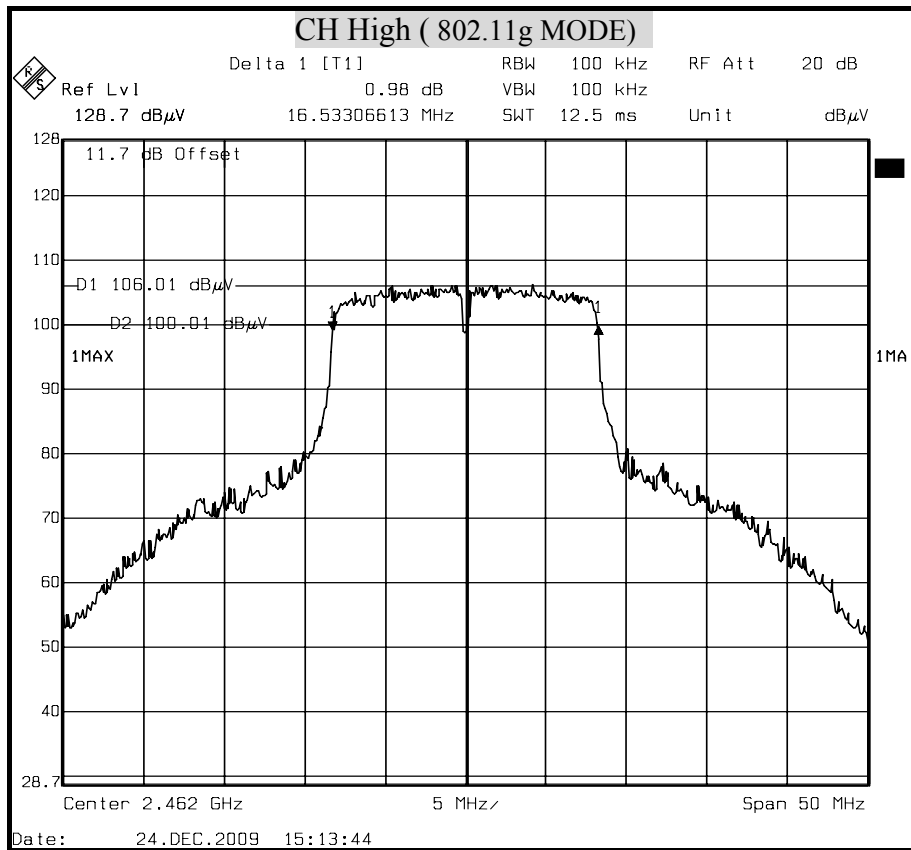



6dB BANDWIDTH (802.11n HT20 MODE)

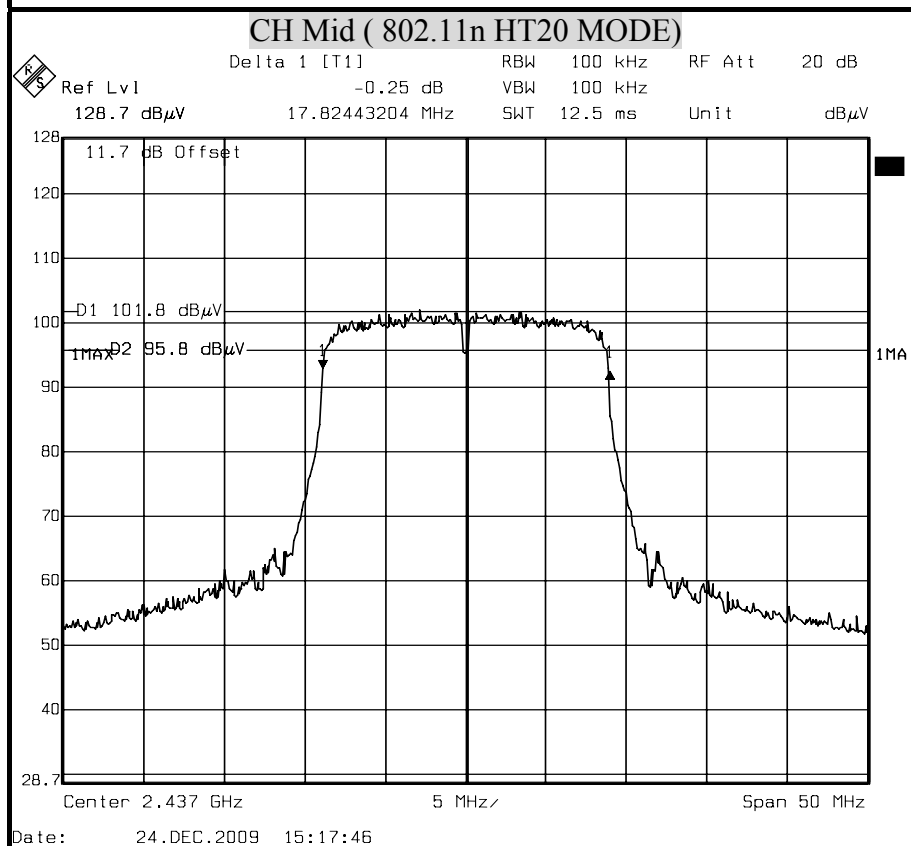
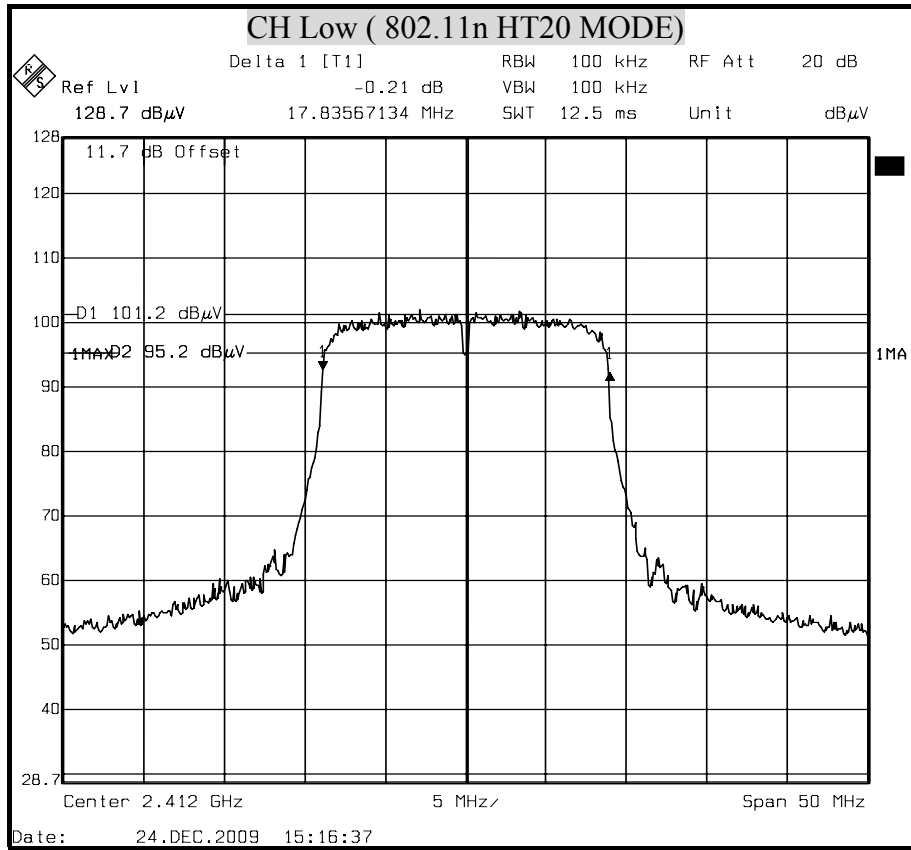

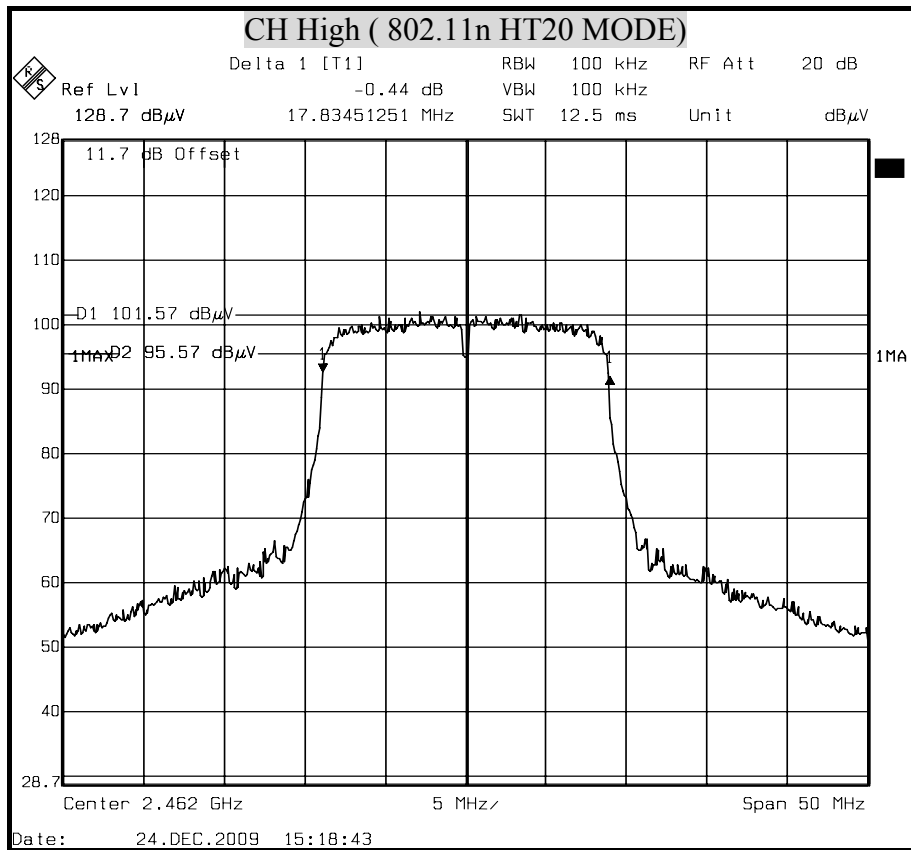



6dB BANDWIDTH (802.11n HT40 MODE)

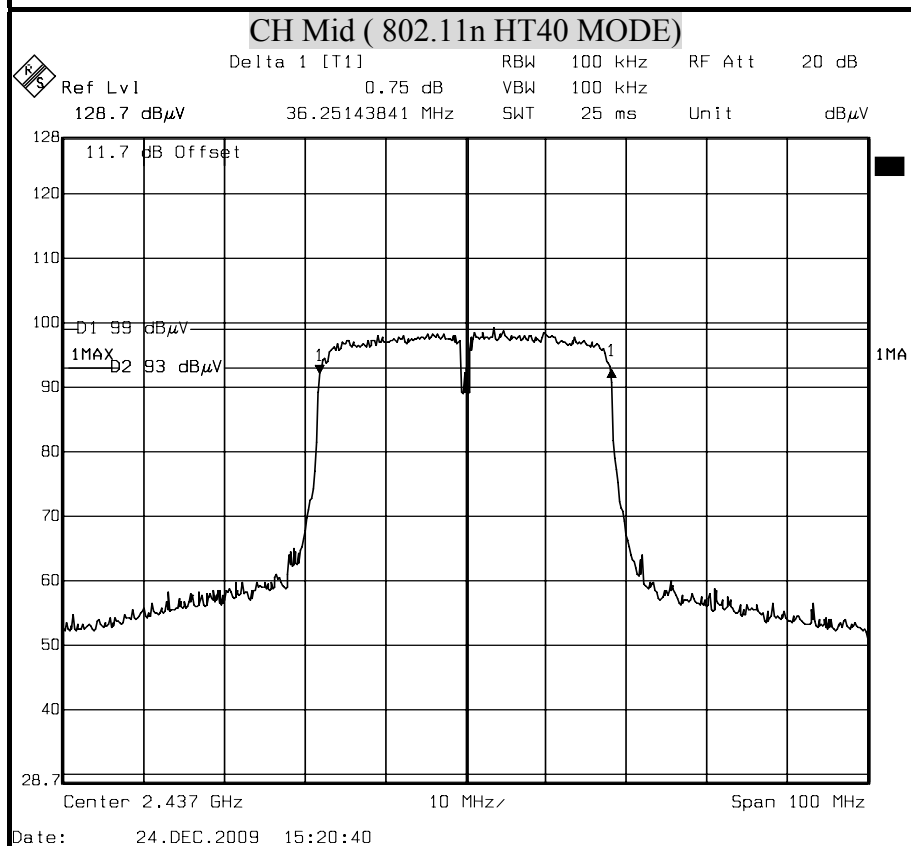
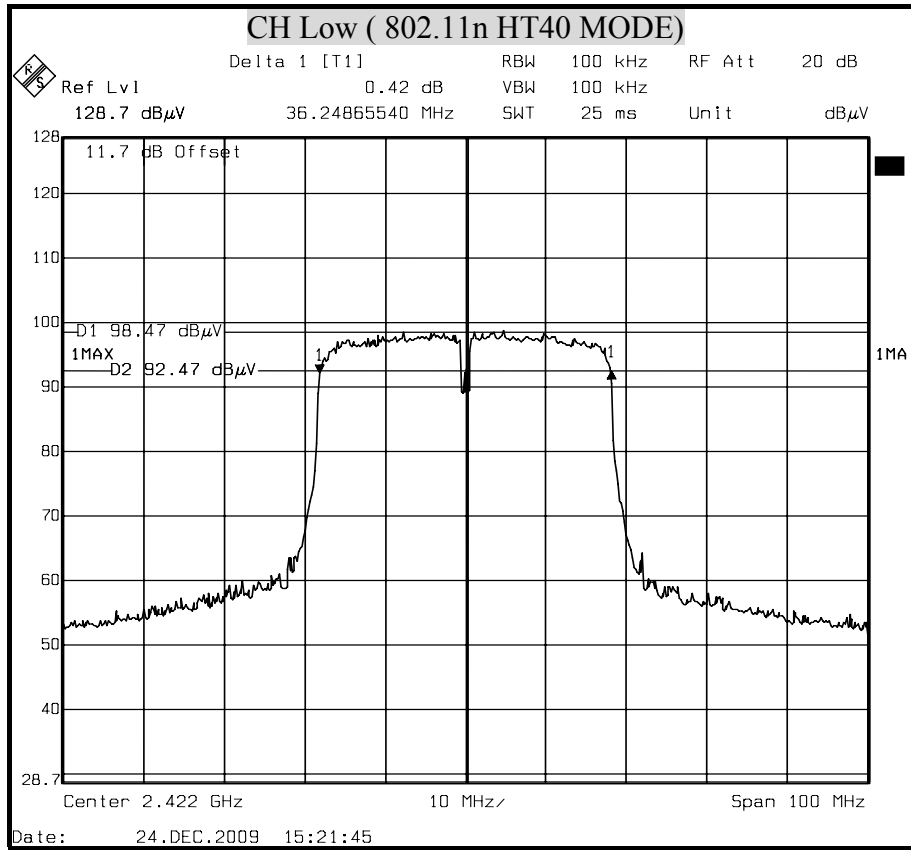

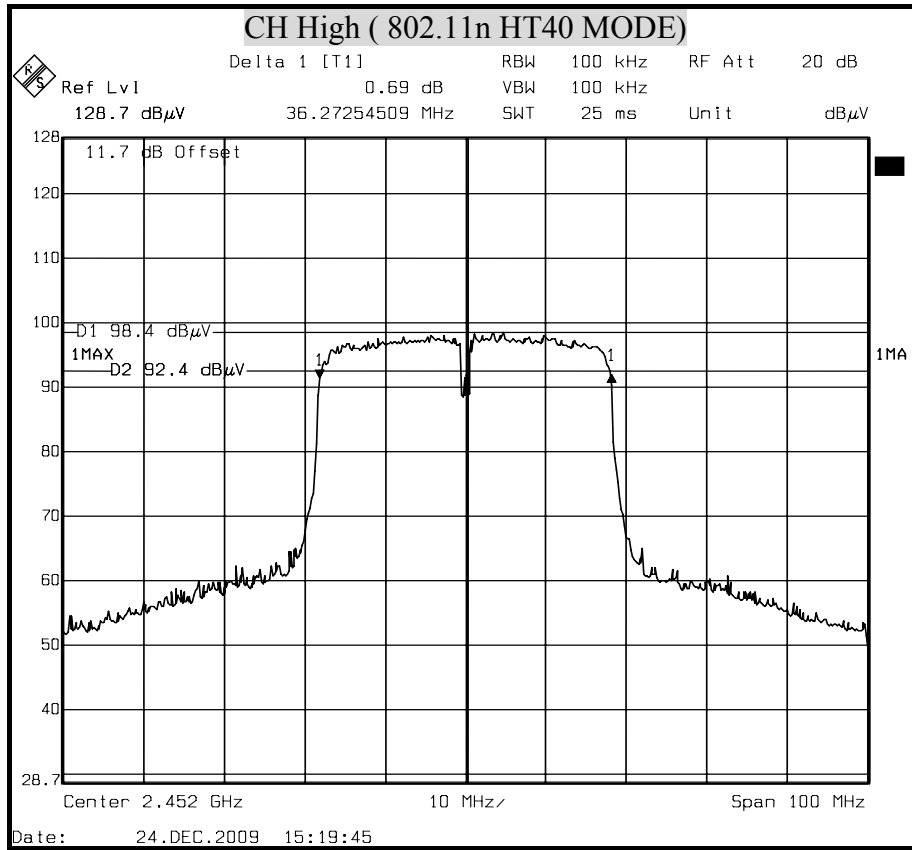



8.2 MAXIMUM PEAK OUTPUT POWER

LIMIT

§ 15.247(b) The maximum peak output power of the intentional radiator shall not exceed the following :

§ 15.247(b) (3) For systems using digital modulation in the 902-928 MHz, 2400-2483.5 MHz, and 5725-5850 MHz bands : 1 watt.

§ 15.247(b) (4) Except as shown in paragraphs (c) of this section , if transmitting antennas of directional gain greater than 6 dBi are used the peak output power from the intentional radiator shall be reduced below the stated values in paragraphs (b)(1) or (b)(2), and (b)(3) of this section , as appropriate, by the amount in dB that the directional gain of the antenna exceeds 6 dBi.

TEST EQUIPMENTS

Name of Equipment	Manufacturer	Model	Serial Number	Calibration Due
Spectrum Analyzer	R&S	FSEK 30	835253/002	OCT. 14, 2010

TEST SETUP

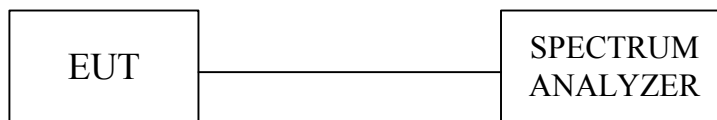

TEST PROCEDURE

Connect the EUT to spectrum analyzer, set the center frequency of the spectrum analyzer to the channel center frequency. Set the RBW to 1MHz and VBW to 3MHz.

Measurement of Digital Transmission Systems Operating under Section 15.247

TEST RESULTS

No non-compliance noted

**IEEE 802.11b mode (One TX)**

Channel	Channel Frequency (MHz)	Peak Power (dBm)	Peak Power Limit (dBm)	Pass / Fail
Low	2412	20.63	30	PASS
Middle	2437	20.70	30	PASS
High	2462	20.28	30	PASS

- NOTE :**
1. At final test to get the worst-case emission at 11Mbps.
 2. The cable assembly insertion loss of 11.7dB (including 10 dB pad and 1.7 dB cable) was Entered as an offset in the spectrum analyzer to allow for direct reading of power.

IEEE 802.11g mode (One TX)

Channel	Channel Frequency (MHz)	Peak Power (dBm)	Peak Power Limit (dBm)	Pass / Fail
Low	2412	21.51	30	PASS
Middle	2437	21.53	30	PASS
High	2462	21.16	30	PASS

- NOTE :**
1. At final test to get the worst-case emission at 6Mbps.
 2. The cable assembly insertion loss of 11.7dB (including 10 dB pad and 1.7 dB cable) was Entered as an offset in the spectrum analyzer to allow for direct reading of power.

**IEEE 802.11n HT20 mode(One TX)**

Channel	Channel Frequency (MHz)	Peak Power (dBm)	Peak Power Limit (dBm)	Pass / Fail
Low	2412	17.06	30	PASS
Middle	2437	17.13	30	PASS
High	2462	16.77	30	PASS

- NOTE :**
1. At final test to get the worst-case emission at 6.5Mbps.
 2. The cable assembly insertion loss of 11.7dB (including 10 dB pad and 1.7 dB cable) was Entered as an offset in the spectrum analyzer to allow for direct reading of power.

IEEE 802.11n HT40 mode (One TX)

Channel	Channel Frequency (MHz)	Peak Power (dBm)	Peak Power Limit (dBm)	Pass / Fail
Low	2422	17.00	30	PASS
Middle	2437	17.08	30	PASS
High	2452	16.57	30	PASS

- NOTE :**
1. At final test to get the worst-case emission at 13.5Mbps.
 2. The cable assembly insertion loss of 11.7dB (including 10 dB pad and 1.7 dB cable) was Entered as an offset in the spectrum analyzer to allow for direct reading of power.



MAXIMUM PEAK OUTPUT POWER (802.11b MODE)

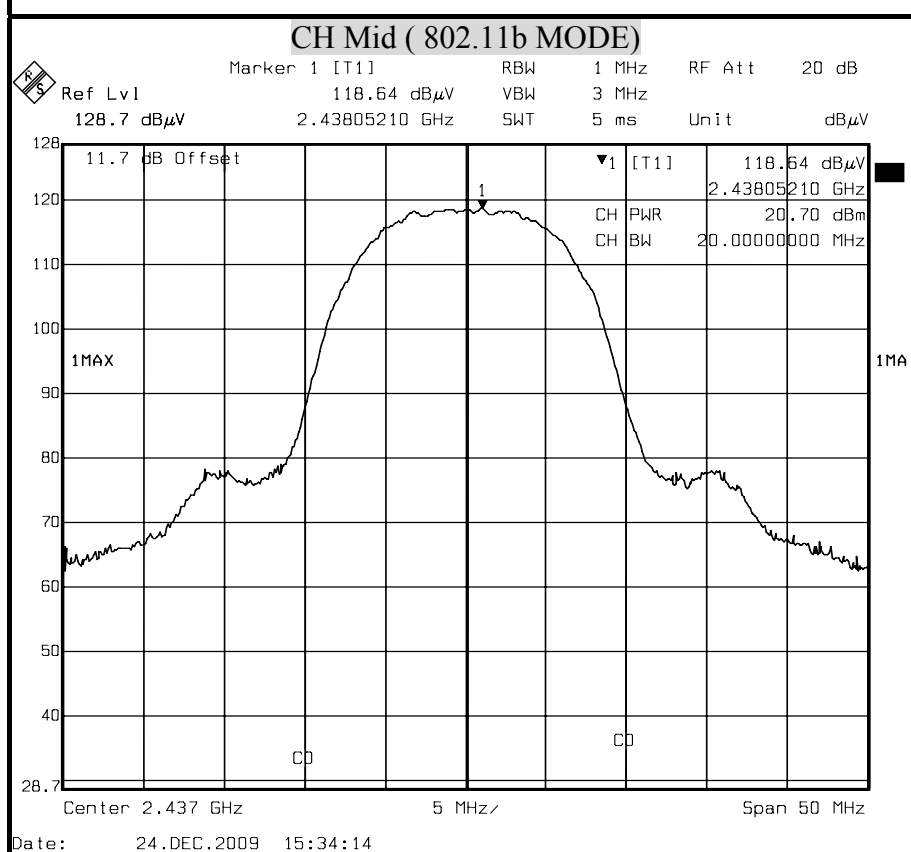
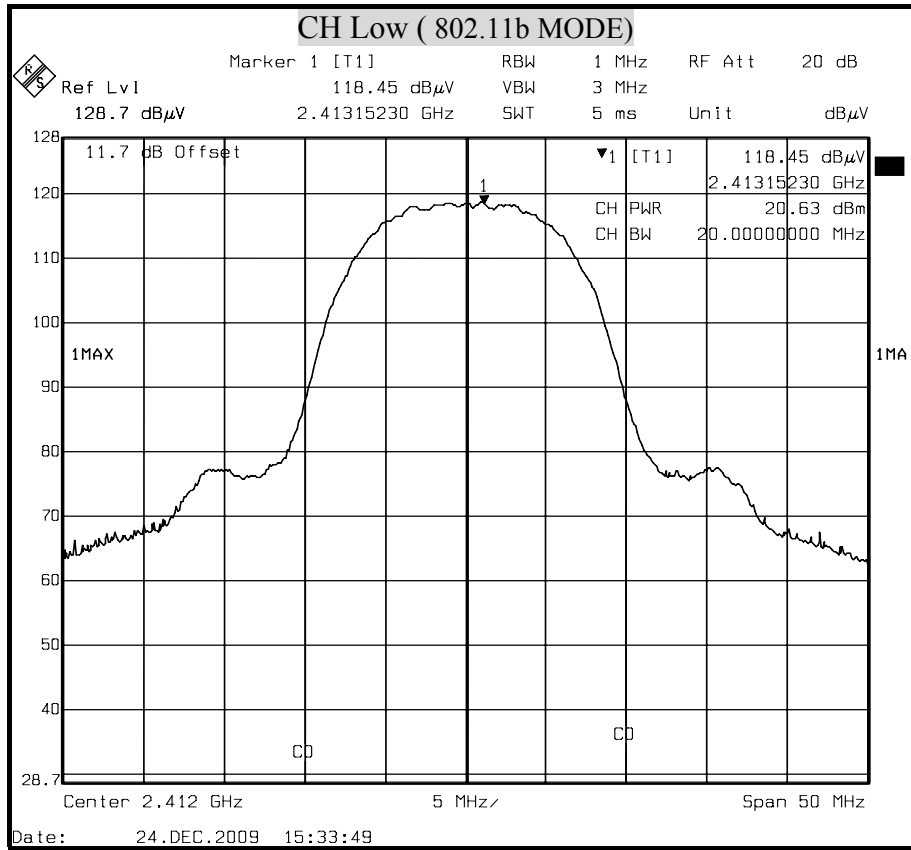

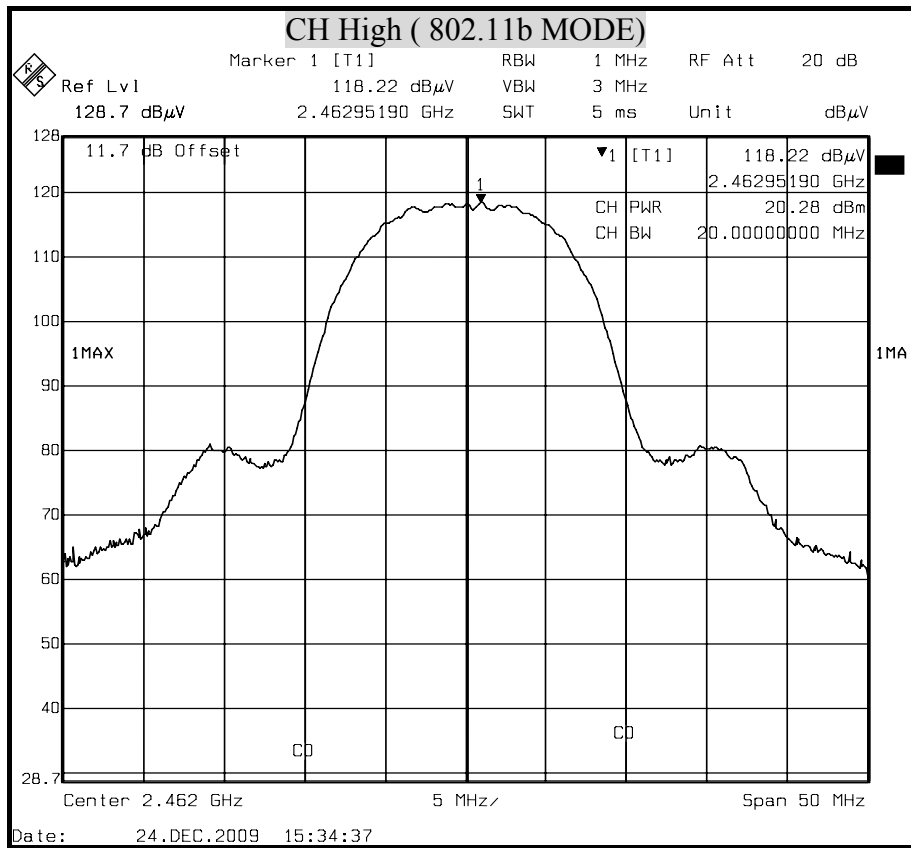



MAXIMUM PEAK OUTPUT POWER (802.11g MODE)

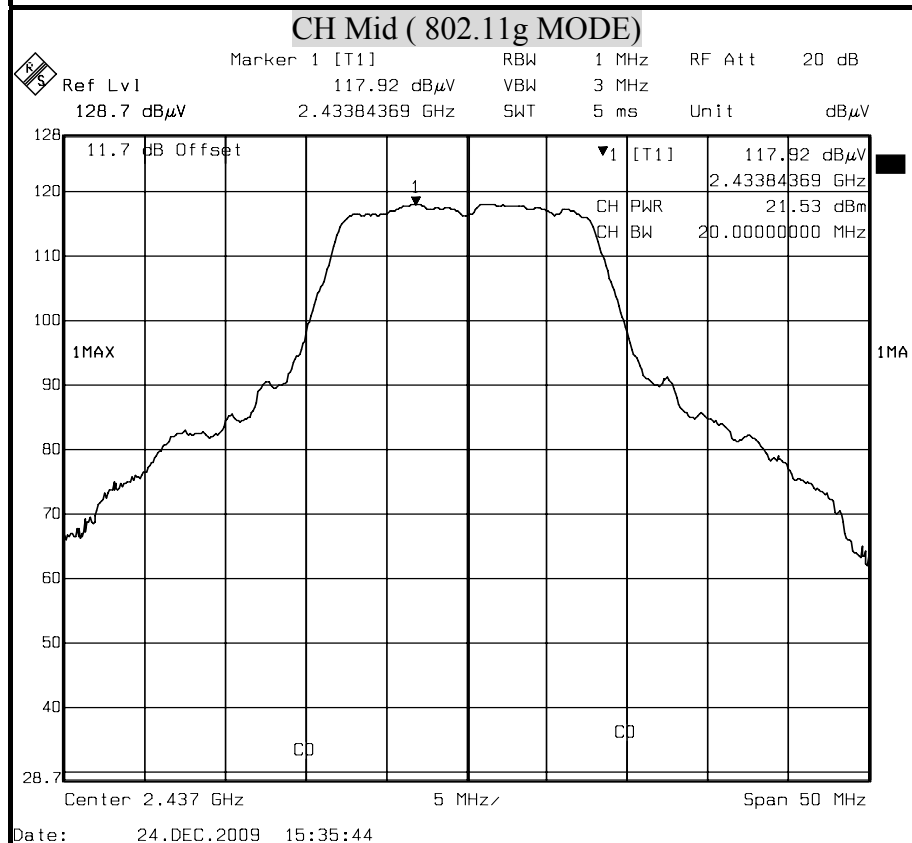
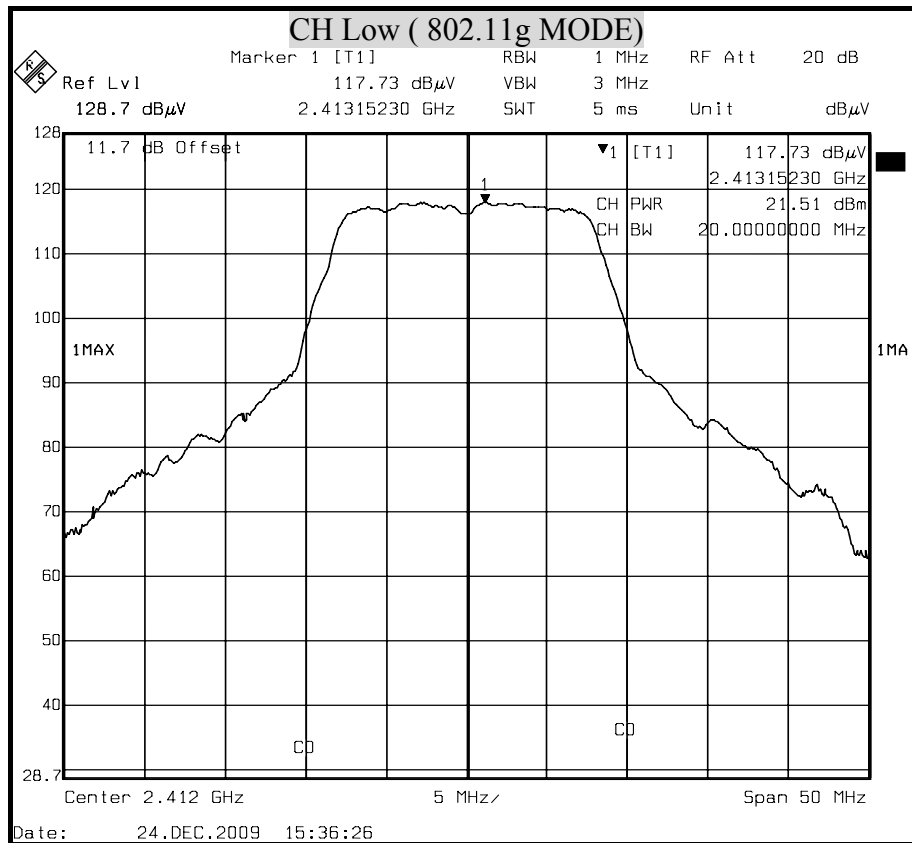

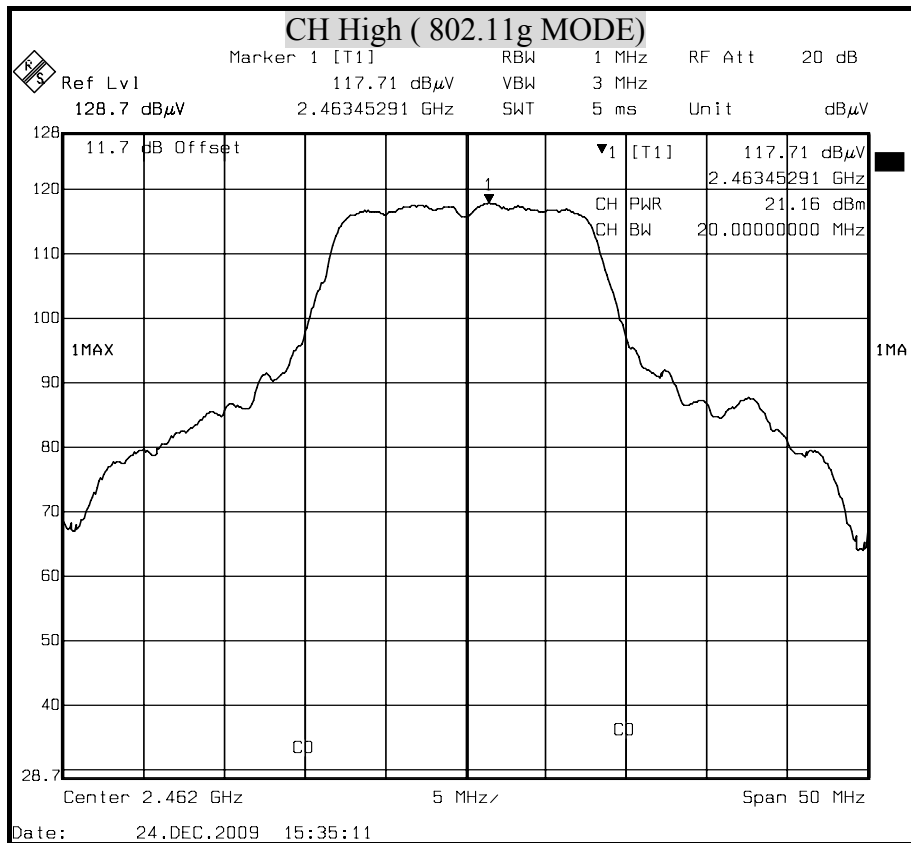



MAXIMUM PEAK OUTPUT POWER (802.11n HT20 MODE)

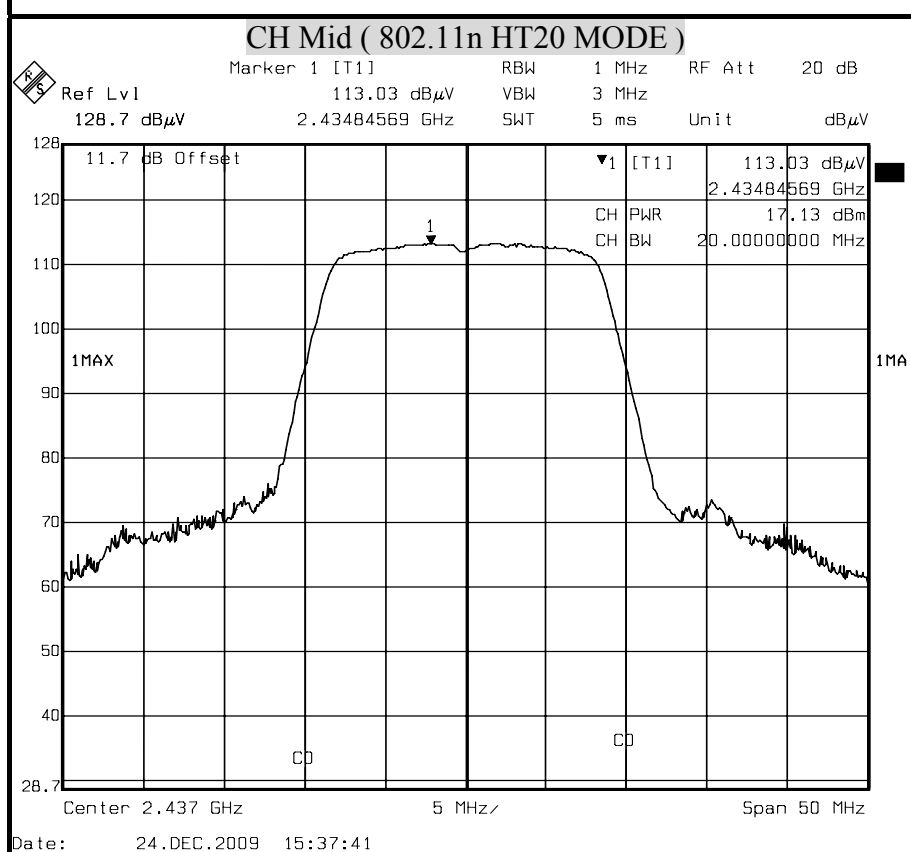
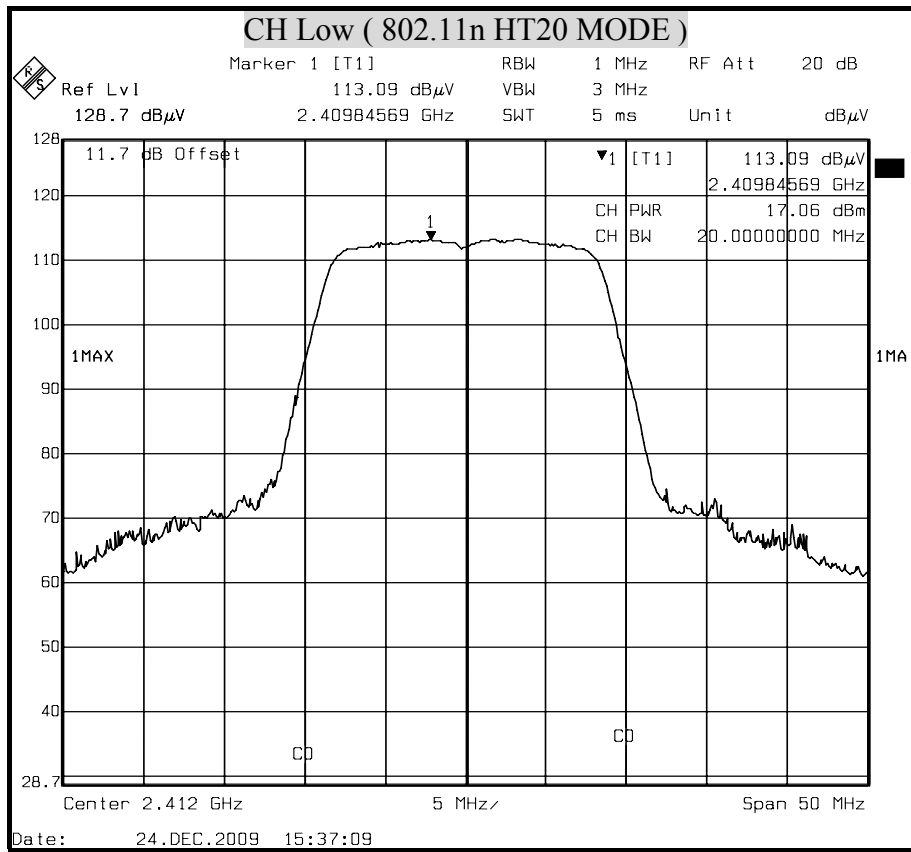

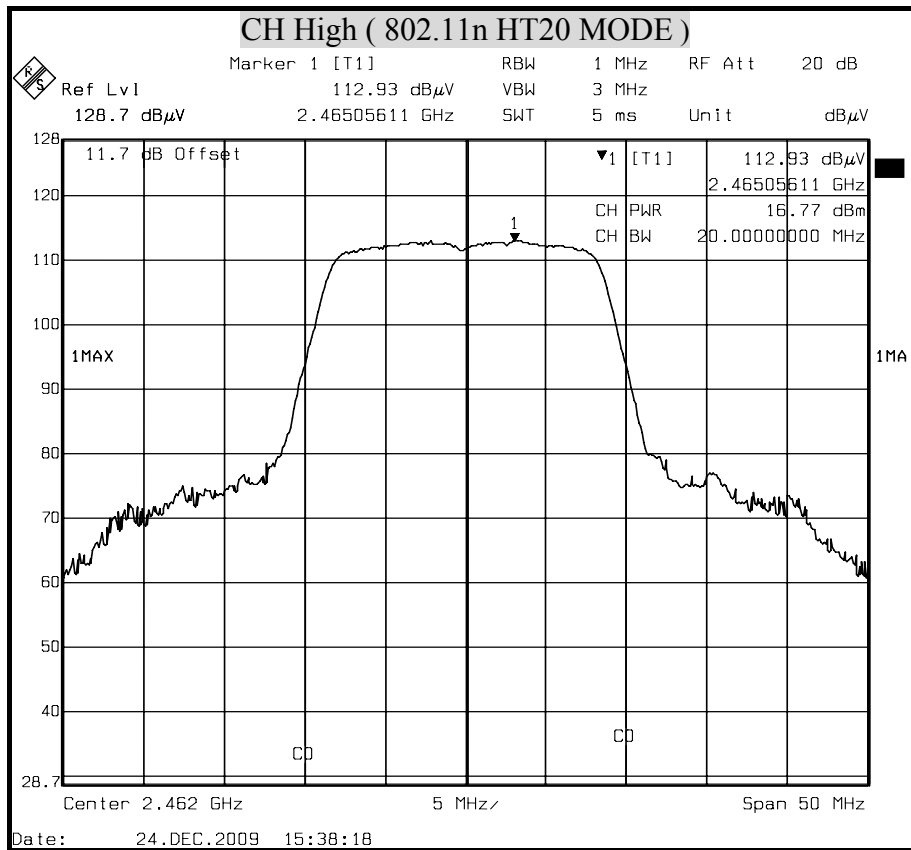



MAXIMUM PEAK OUTPUT POWER (802.11n HT40 MODE)

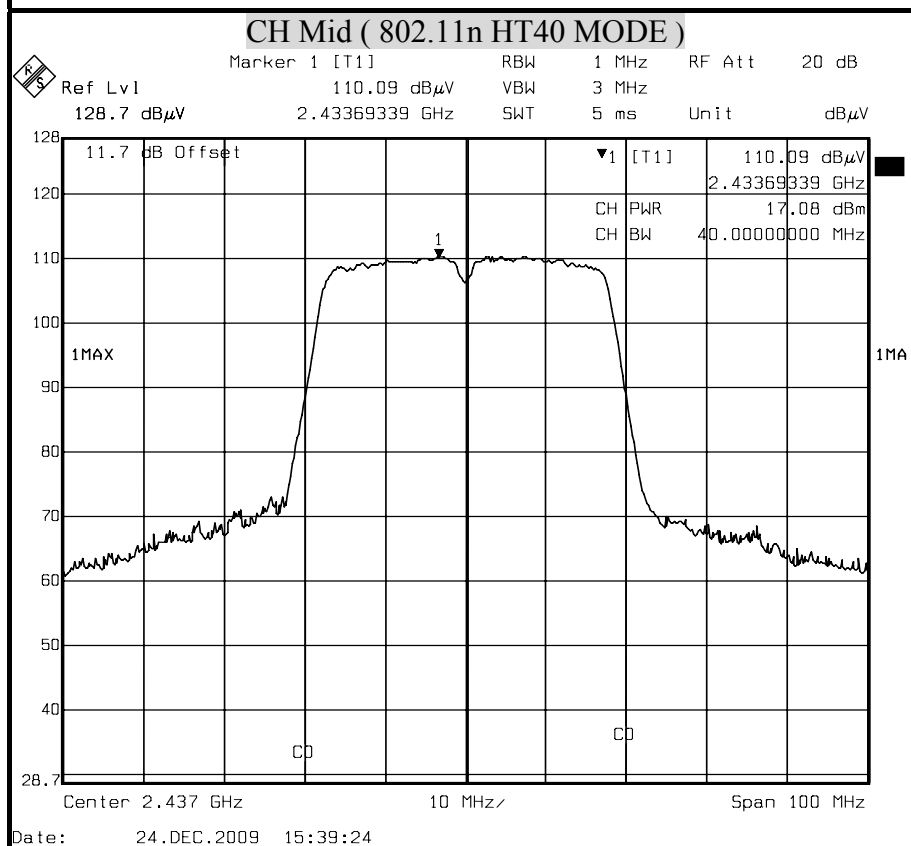
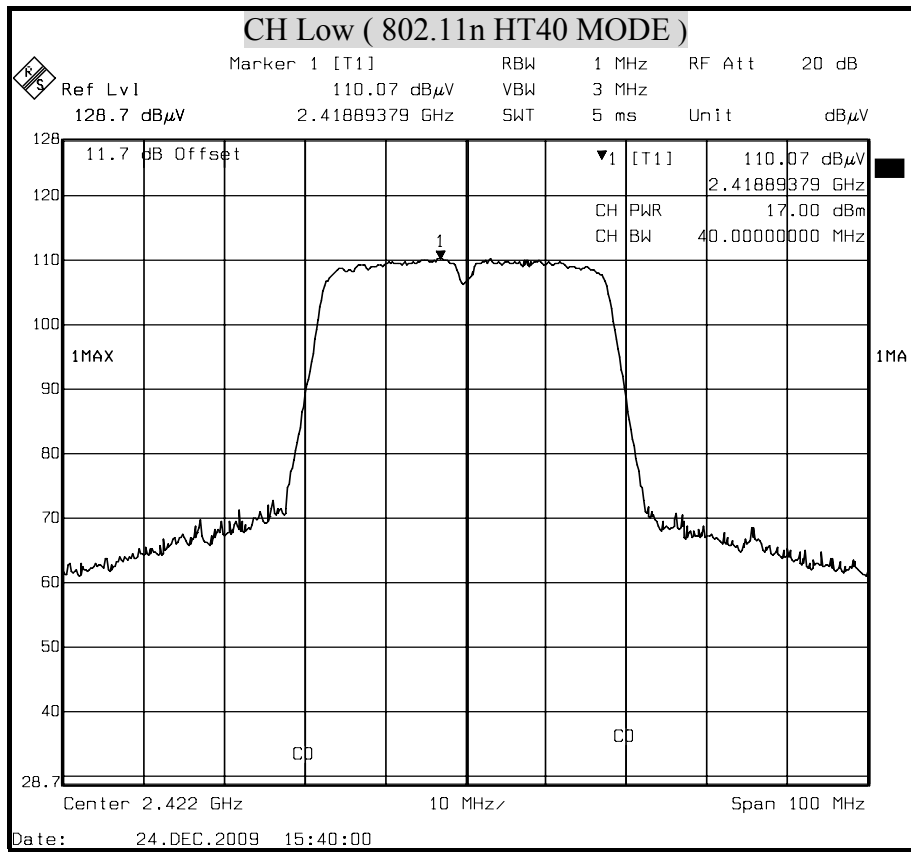

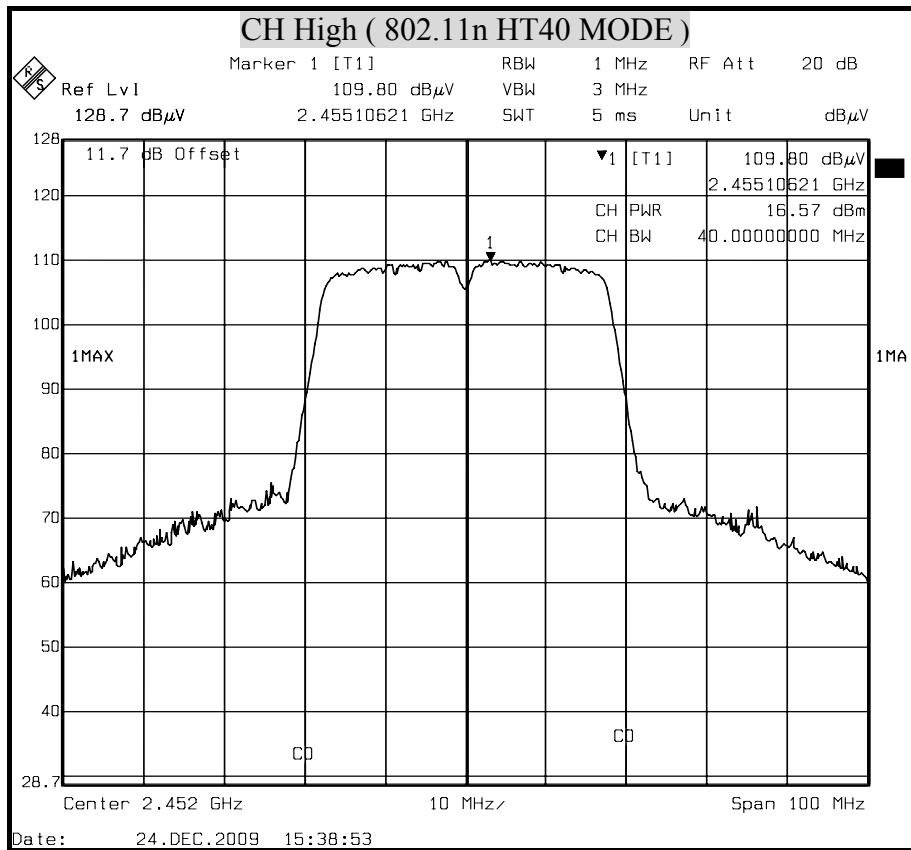



8.3 MAXIMUM PERMISSIBLE EXPOSURE

According to FCC 1.1310 : The criteria listed in the following table shall be used to evaluate the environment impact of human exposure to radio frequency (RF) radiation as specified in 1.1307(b) LIMITS FOR MAXIMUM PERMISSIBLE EXPOSURE (MPE)

Frequency Range (MHz)	Electric Field Strength (V/m)	Magnetic Field Strength (A/m)	Power Density (mW/cm ²)	Average Time
(A) Limits for Occupational / Control Exposures				
300-1,500	--	--	F/300	6
1,500-100,000	--	--	5	6
(B) Limits for General Population / Uncontrol Exposures				
300-1,500	--	--	F/1500	6
1,500-100,000	--	--	1	30

CALCULATIONS

Given $E = \frac{\sqrt{30 \times P \times G}}{d}$ & $S = \frac{E^2}{3770}$

Where $E =$ Field strength in Volts / meter

$P =$ Power in Watts

$G =$ Numeric antenna gain

$d =$ Distance in meters

$S =$ Power density in milliwatts / square centimeter

Combining equations and re-arranging the terms to express the distance as a function of the remaining variables yields:

$$S = \frac{30 \times P \times G}{3770d^2}$$

Changing to units of mW and cm, using:

$$P (mW) = P (W) / 1000 \text{ and}$$

$$d (cm) = d(m) / 100$$

Yields

$$S = \frac{30 \times (P/1000) \times G}{3770 \times (d/100)^2} = 0.0796 \times \frac{P \times G}{d^2}$$

Where $d =$ Distance in cm

$P =$ Power in mW

$G =$ Numeric antenna gain

$S =$ Power density in mW / cm²

**LIMIT**Power Density Limit, $S=1.0\text{mW}/\text{cm}^2$ **TEST RESULTS**

No non-compliance noted.

$$S = \frac{30 \times (P/1000) \times G}{3770 \times (d/100)^2} = 0.0796 \times \frac{P \times G}{d^2}$$

 $G=4.14\text{dBi}=2.59417936\text{mW}$ IEEE 802.11b $=0.0796*117.4898*2.59417936/400=0.060653$ IEEE 802.11g $=0.0796*142.2329*2.59417936/400=0.073427$ IEEE 802.11n HT20 $=0.0796*51.64164*2.59417936/400=0.026660$ IEEE 802.11n HT40 $=0.0796*51.05050*2.59417936/400=0.026354$

Mode	Minimum separation distance (cm)	Output Power (dBm)	Output Power (mw)	Antenna Gain (dBi)	Power Density Limit (mW/cm^2)	Power Density at 20cm (mW/cm^2)
IEEE 802.11b	20.0	20.70	117.49	4.14	1	0.060653
IEEE 802.11g	20.0	21.53	142.23	4.14	1	0.073427
IEEE 802.11n HT20	20.0	17.13	51.64	4.14	1	0.026660
IEEE 802.11n HT40	20.0	17.08	51.05	4.14	1	0.026354

REMARK: For mobile or fixed location transmitters, the maximum power density is $1.0 \text{ mW}/\text{cm}^2$ even if the calculation indicates that the power density would be larger.



8.4 POWER SPECTRAL DENSITY

LIMIT

§ 15.247(e) For digitally modulated systems, the power spectral density conducted from the intentional radiator to the antenna shall not greater than 8 dBm in any 3 kHz band during any time interval of continuous transmission.

TEST EQUIPMENTS

Name of Equipment	Manufacturer	Model	Serial Number	Calibration Due
Spectrum Analyzer	R&S	FSEK 30	835253/002	OCT. 14, 2010

TEST SETUP

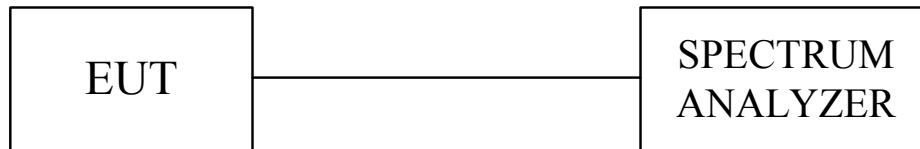

TEST PROCEDURE

The transmitter output was connected to the spectrum analyzer, the bandwidth of the fundamental frequency was measured with the spectrum analyzer using RBW=3KHz and VBW ≥ RBW, set sweep time=span / 3KHz.

The power spectral density was measured and recorded.

The sweep time is allowed to be longer than span / 3KHz for a full response of the mixer in the spectrum analyzer.

TEST RESULTS

Total peak power calculation formula:
 $10 \log (10^{\text{Chain 0 PPSD}} / 10)$.

No non-compliance noted.

**IEEE 802.11b mode**

Channel	Channel Frequency (MHz)	PPSD Chain 0 (dBm)	Maximum Limit (dBm)	Pass / Fail
Low	2412	-11.12	8	PASS
Middle	2437	-10.97	8	PASS
High	2462	-11.77	8	PASS

- NOTE :**
1. At final test to get the worst-case emission at 11Mbps.
 2. The cable assembly insertion loss of 11.7dB (including 10 dB pad and 1.7 dB cable) was Entered as an offset in the spectrum analyzer to allow for direct reading of power.

IEEE 802.11g mode

Channel	Channel Frequency (MHz)	PPSD Chain 0 (dBm)	Maximum Limit (dBm)	Pass / Fail
Low	2412	-15.20	8	PASS
Middle	2437	-15.15	8	PASS
High	2462	-15.56	8	PASS

- NOTE :**
1. At final test to get the worst-case emission at 6Mbps.
 2. The cable assembly insertion loss of 11.7dB (including 10 dB pad and 1.7 dB cable) was Entered as an offset in the spectrum analyzer to allow for direct reading of power.

IEEE 802.11n HT20 mode

Channel	Channel Frequency (MHz)	PPSD Chain 0 (dBm)	Maximum Limit (dBm)	Pass / Fail
Low	2412	-17.26	8	PASS
Middle	2437	-17.24	8	PASS
High	2462	-18.36	8	PASS

- NOTE :**
1. At final test to get the worst-case emission at 6.5Mbps.
 2. The cable assembly insertion loss of 11.7dB (including 10 dB pad and 1.7 dB cable) was Entered as an offset in the spectrum analyzer to allow for direct reading of power.

IEEE 802.11n HT40 mode

Channel	Channel Frequency (MHz)	PPSD Chain 0 (dBm)	Maximum Limit (dBm)	Pass / Fail
Low	2422	-17.65	8	PASS
Middle	2437	-17.48	8	PASS
High	2452	-18.82	8	PASS

- NOTE :**
1. At final test to get the worst-case emission at 13.5Mbps.
 2. The cable assembly insertion loss of 11.7dB (including 10 dB pad and 1.7 dB cable) was Entered as an offset in the spectrum analyzer to allow for direct reading of power.



POWER SPECTRAL DENSITY (IEEE 802.11b MODE)

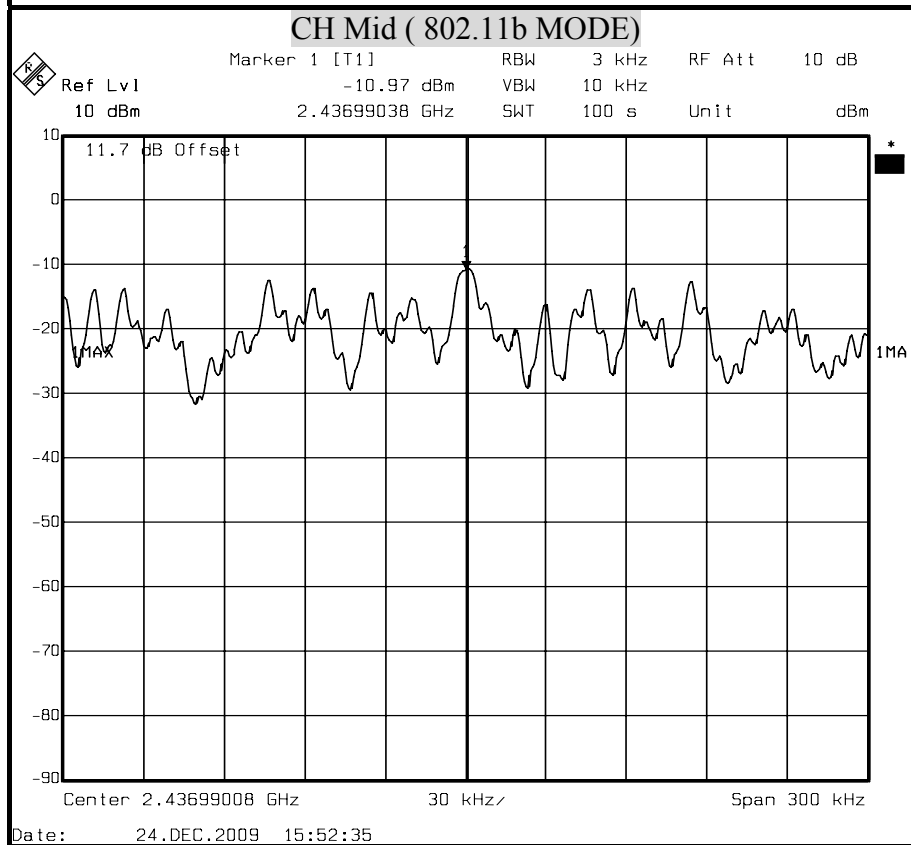
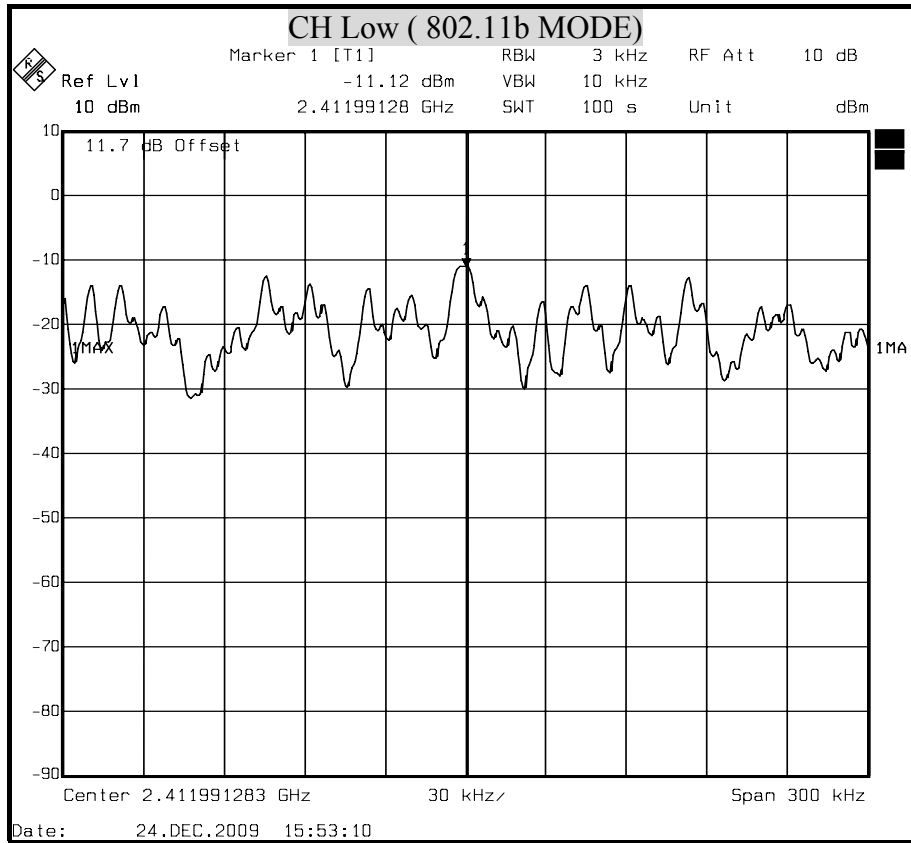

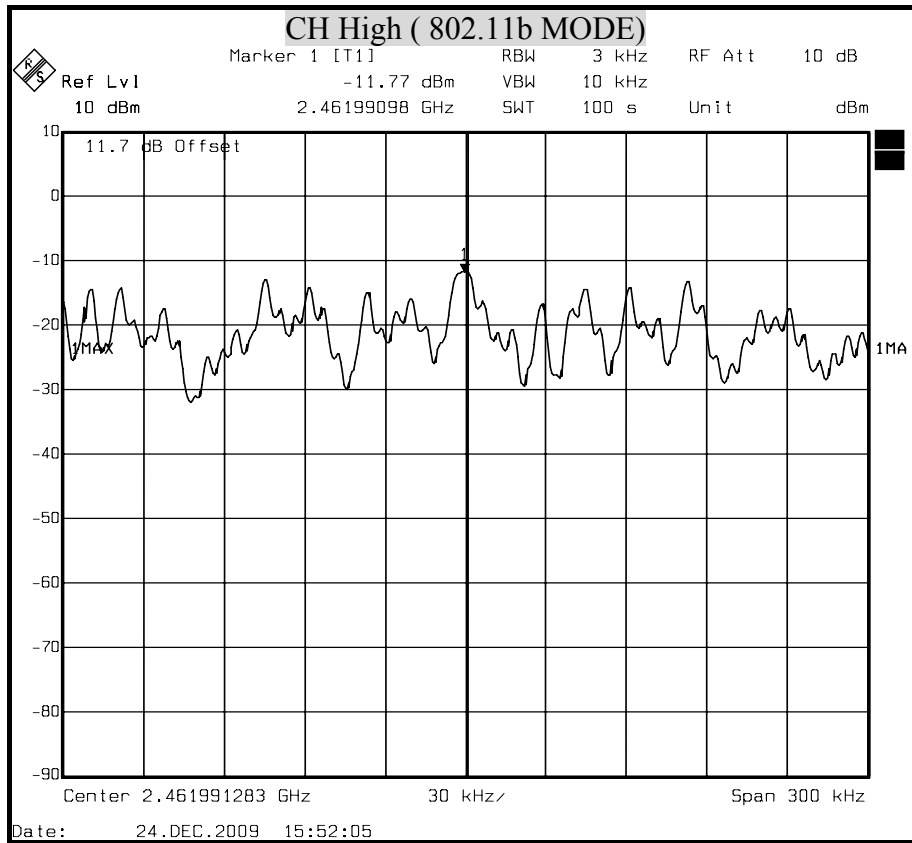



POWER SPECTRAL DENSITY (IEEE 802.11g MODE)

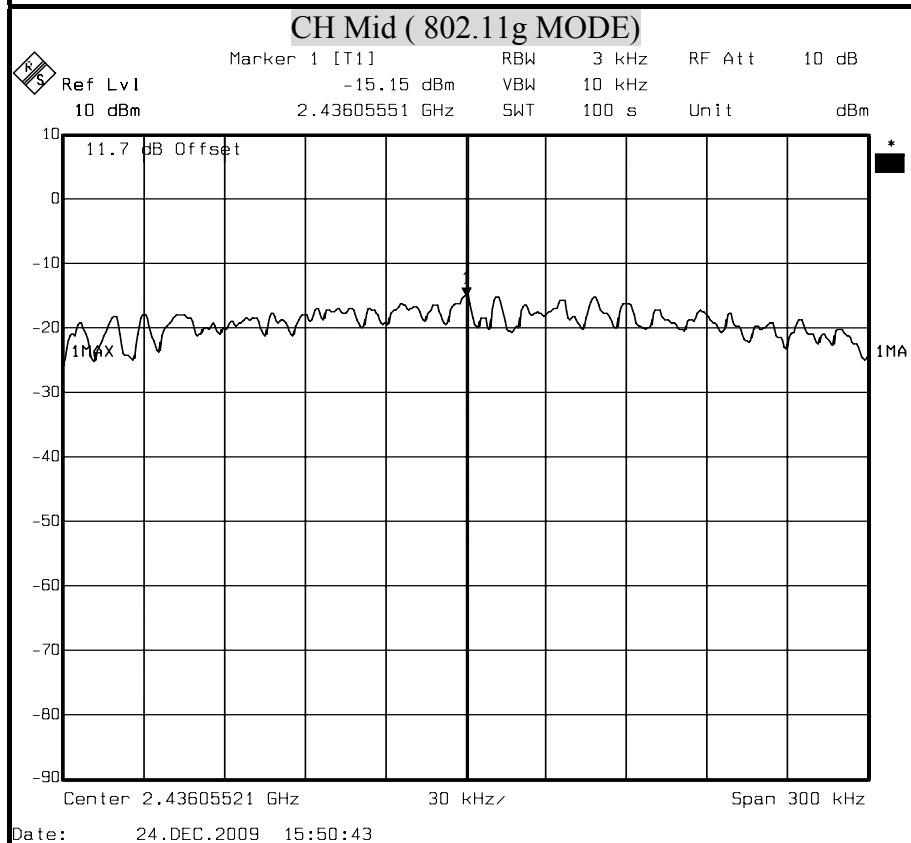
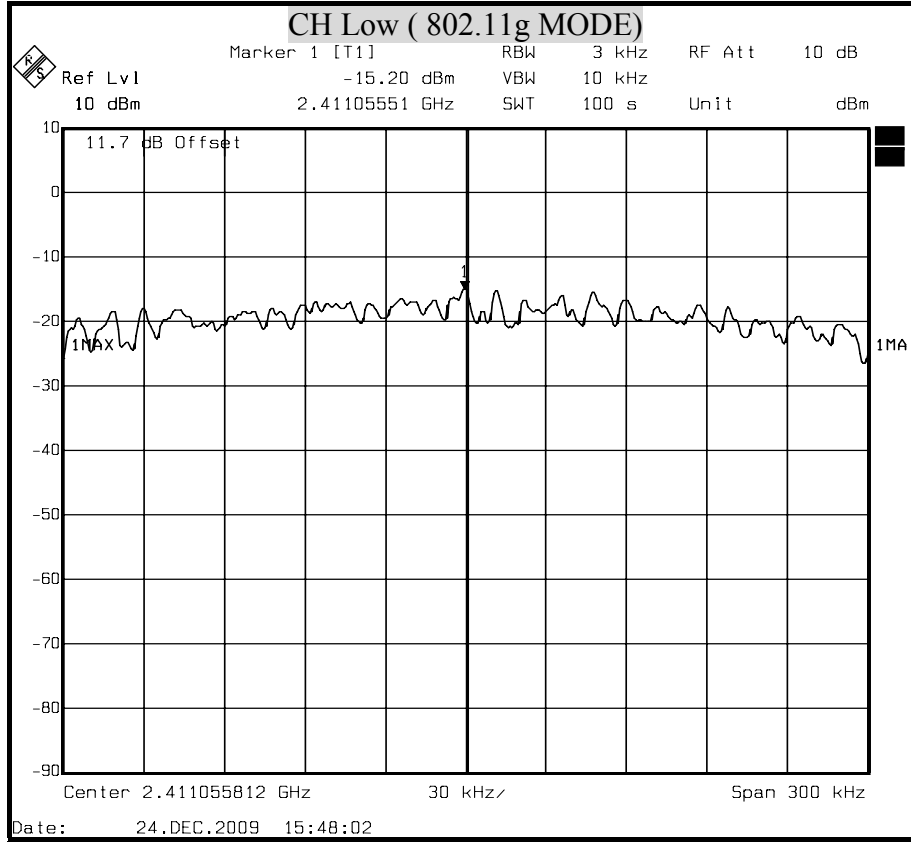

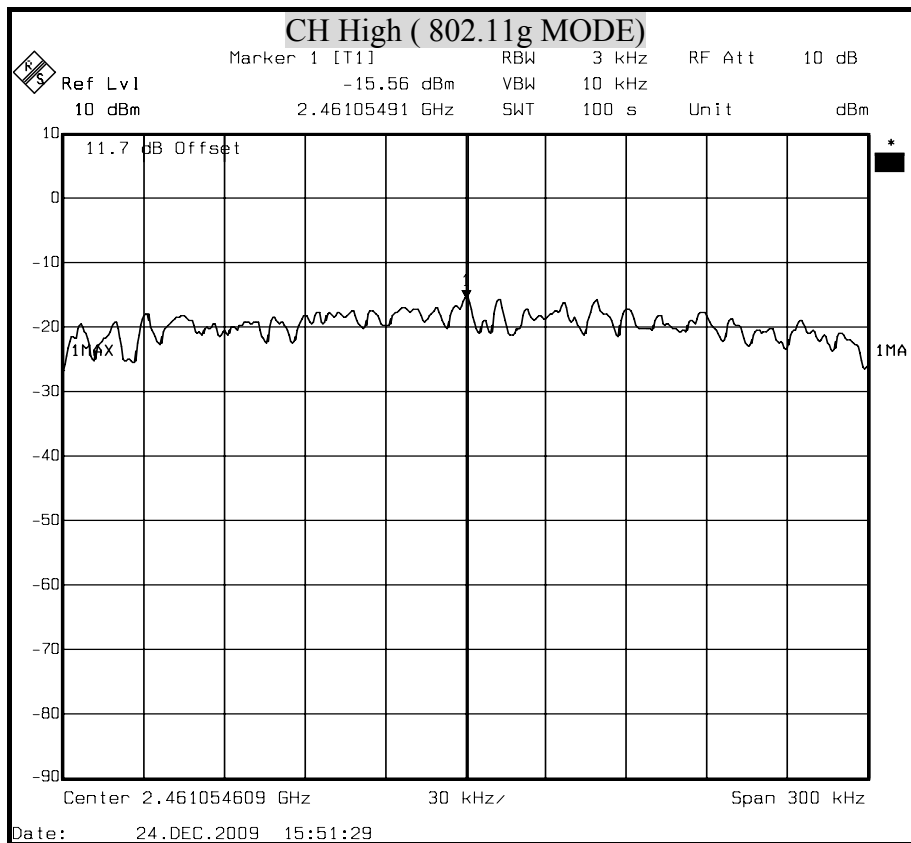



POWER SPECTRAL DENSITY (802.11n HT20 MODE)

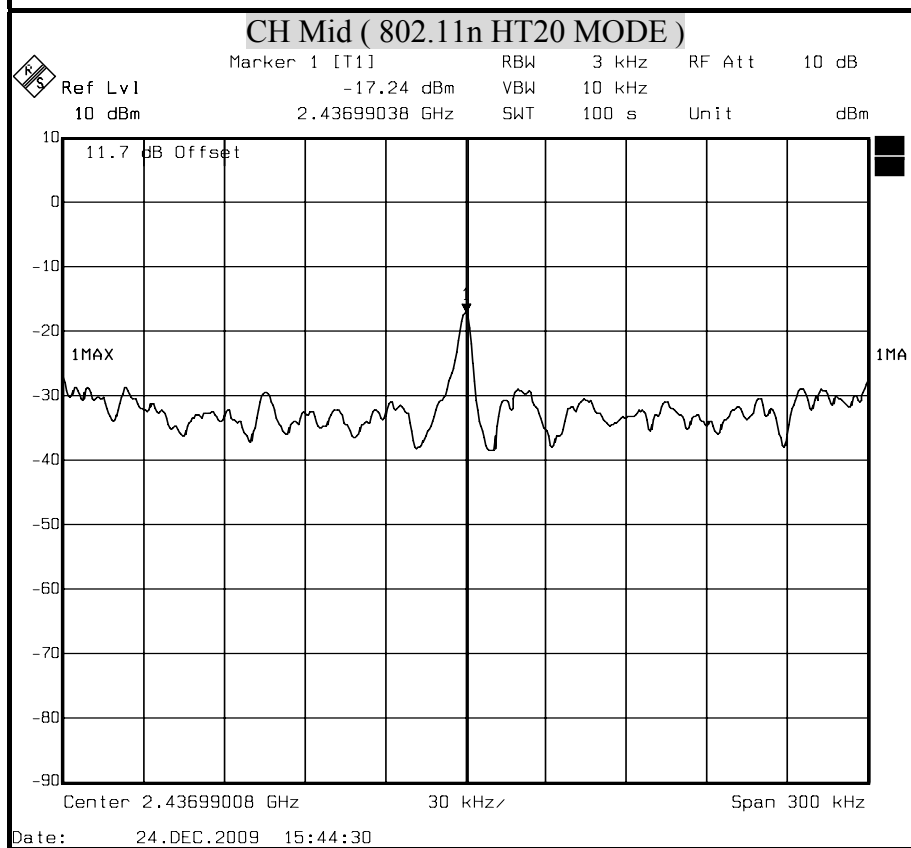
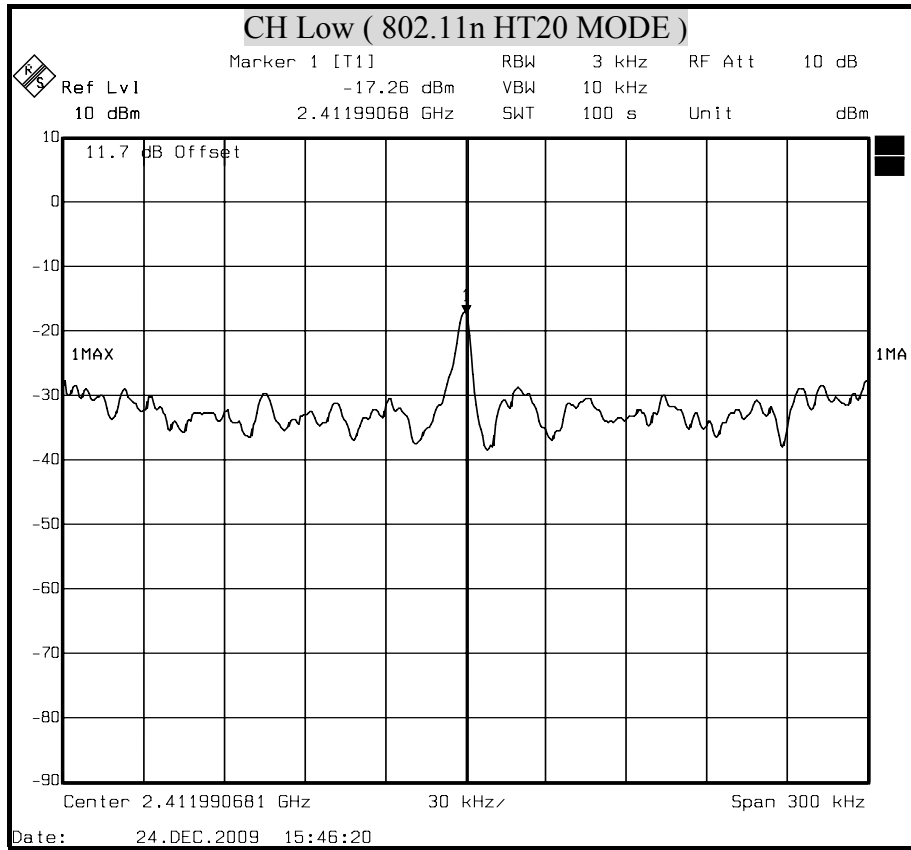

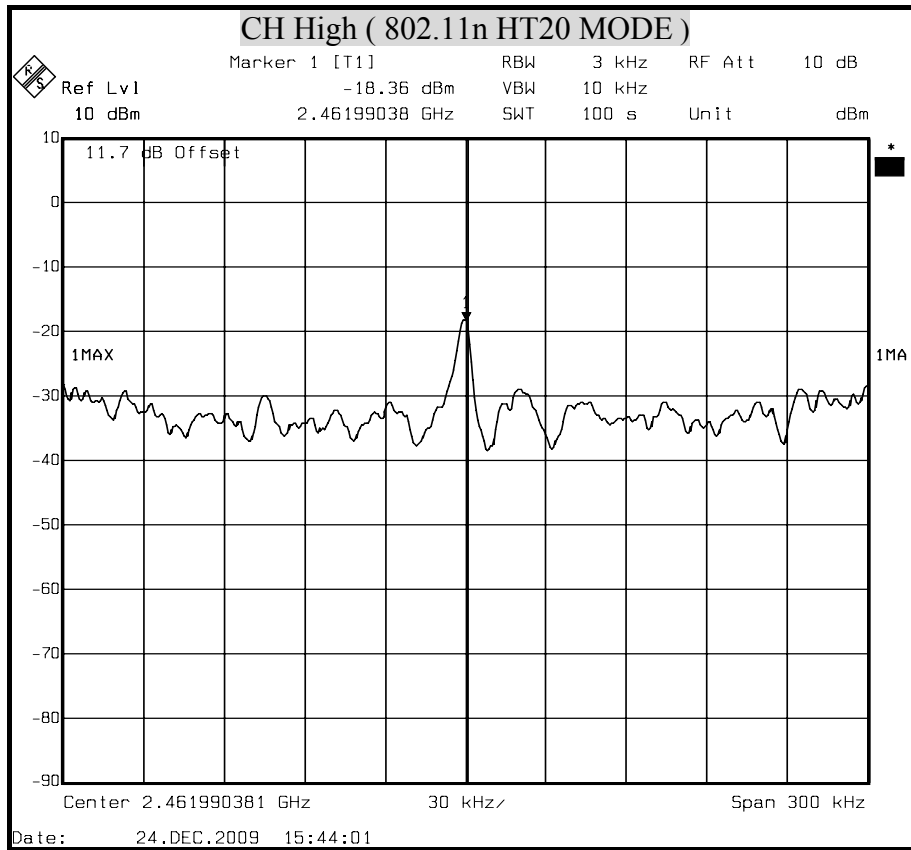



POWER SPECTRAL DENSITY (802.11n HT40 MODE)

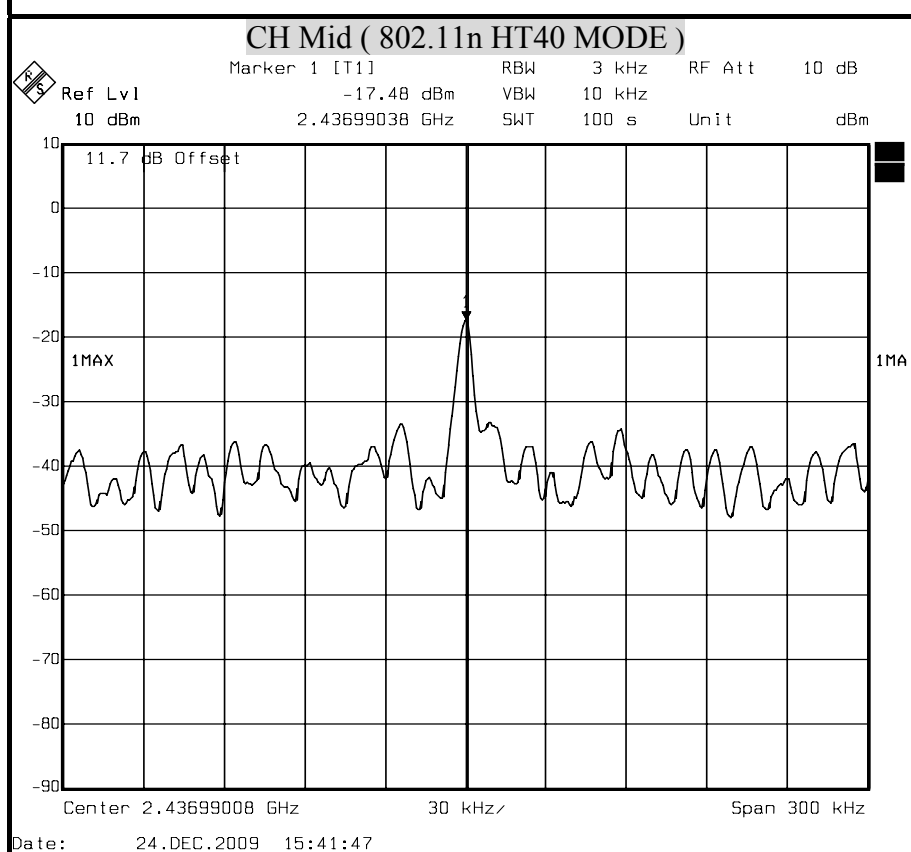
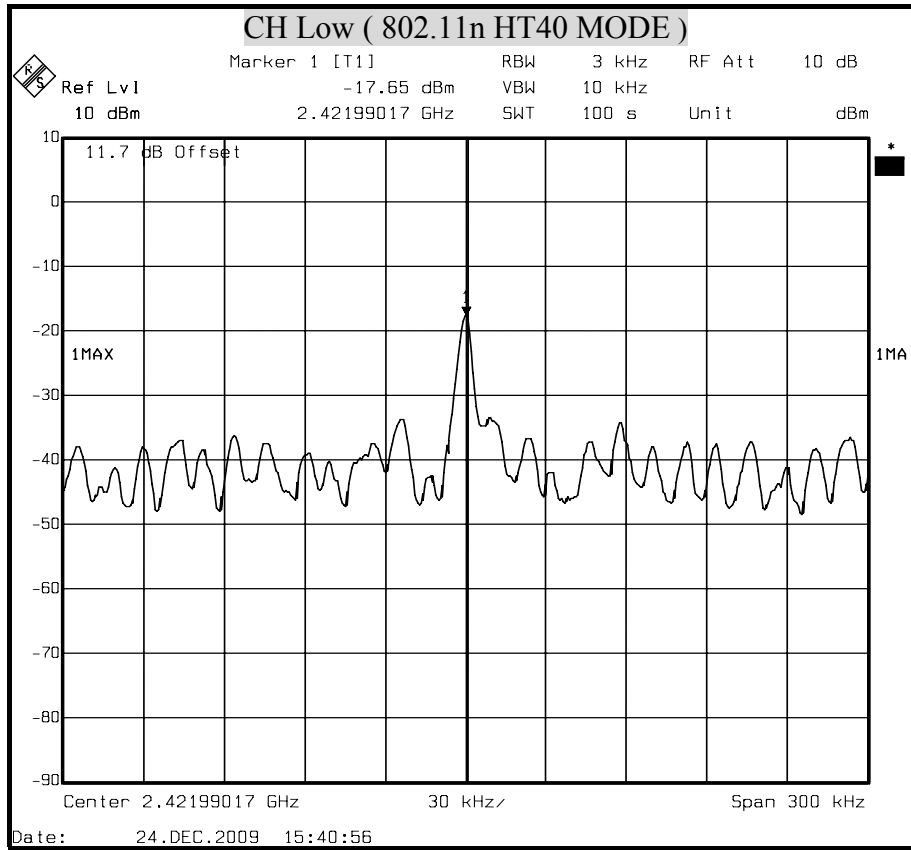

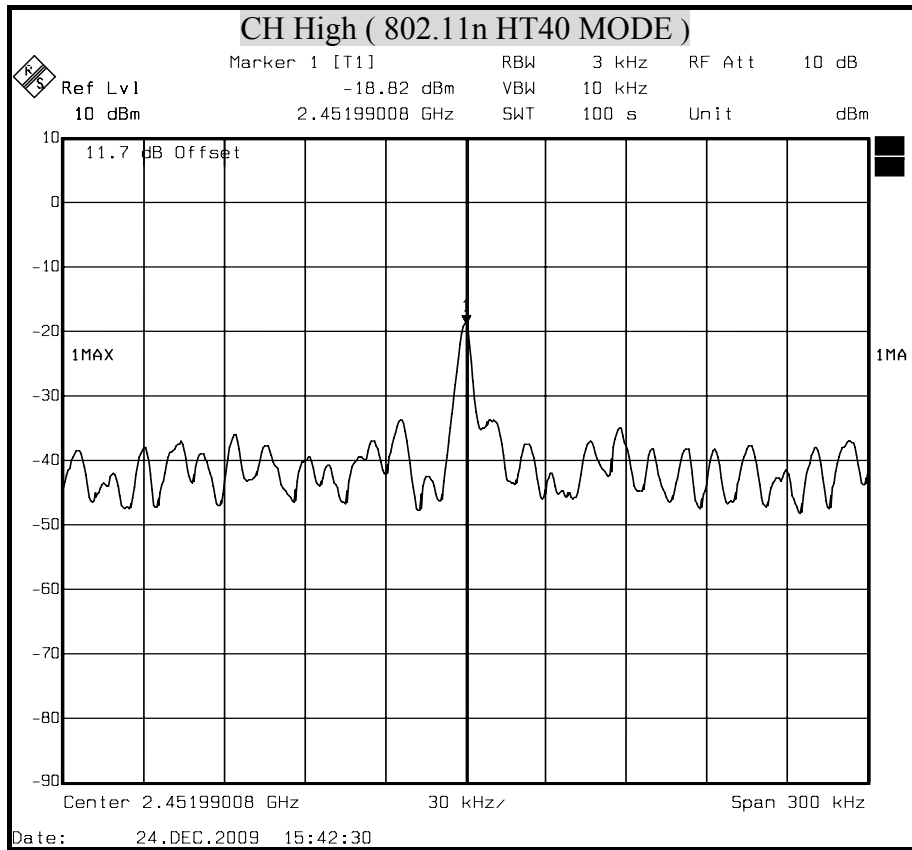

8.5 CONDUCTED SPURIOUS EMISSION

LIMITS

§ 15.247(d) In any 100 kHz bandwidth outside the frequency band in which the spread spectrum intentional radiator is operating, the radio frequency power that is produced by the intentional radiator shall be at least 20 dB below that in the 100 kHz bandwidth within the band that contains the highest level of the desired power, based on either an RF conducted or a radiated measurement. Attenuation below the general limits specified in § 15.209(a) is not required. In addition, radiated emissions which fall in the restricted bands, as defined in § 15.205(a), must also comply with the radiated emission limits specified in § 15.209(a) (see § 15.205(c)).

TEST PROCEDURE

The transmitter output is connected to a spectrum analyzer. The resolution bandwidth is set to 100 kHz. The video bandwidth is set to 100 kHz.

The spectrum from 30 MHz to 26.5 GHz is investigated with the transmitter set to the lowest, middle, and highest channels in the 2.4 GHz band.

TEST SETUP

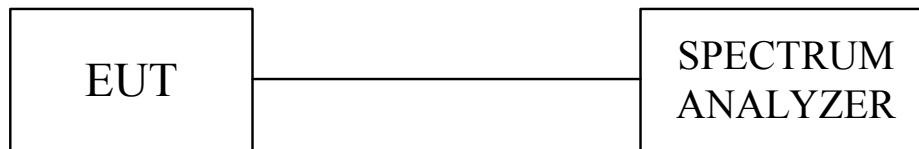

TEST RESULTS

No non-compliance noted.

**802.11b Mode**

CH Low

Frequency (MHz)	Offset (dB)	Reading (dBuV)	Level (dBuV)	Limit (dBuV)	Margin (dB)
2410.5236	11.7	98.14	109.84	N/A	N/A
1462.2444	11.7	41.75	53.45	89.84	-36.39
6925.9919	11.7	44.49	56.19	89.84	-33.65
21619.7595	11.7	47.82	59.52	89.84	-30.32

CH Mid

Frequency (MHz)	Offset (dB)	Reading (dBuV)	Level (dBuV)	Limit (dBuV)	Margin (dB)
2435.2154	11.7	97.92	109.62	N/A	N/A
1515.2905	11.7	40.29	51.99	89.62	-37.63
6979.038	11.7	44.29	55.99	89.62	-33.63
21831.9438	11.7	47.59	59.29	89.62	-30.33

CH High

Frequency (MHz)	Offset (dB)	Reading (dBuV)	Level (dBuV)	Limit (dBuV)	Margin (dB)
2461.2358	11.7	97.56	109.26	N/A	N/A
1462.2444	11.7	40.37	52.07	89.26	-37.19
6979.038	11.7	44.76	56.46	89.26	-32.80
21725.8517	11.7	47.59	59.29	89.26	-29.97

802.11g Mode

CH Low

Frequency (MHz)	Offset (dB)	Reading (dBuV)	Level (dBuV)	Limit (dBuV)	Margin (dB)
2411.532	11.7	94.25	105.95	N/A	N/A
1462.2444	11.7	41.55	53.25	85.95	-32.70
6979.038	11.7	43.86	55.56	85.95	-30.39
21778.8978	11.7	46.72	58.42	85.95	-27.53

CH Mid

Frequency (MHz)	Offset (dB)	Reading (dBuV)	Level (dBuV)	Limit (dBuV)	Margin (dB)
2436.532	11.7	93.65	105.35	N/A	N/A
1621.3827	11.7	39.95	51.65	85.35	-33.70
6925.9919	11.7	44.65	56.35	85.35	-29.00
21619.7595	11.7	47.10	58.8	85.35	-26.55

CH High

Frequency (MHz)	Offset (dB)	Reading (dBuV)	Level (dBuV)	Limit (dBuV)	Margin (dB)
2462.5352	11.7	93.79	105.49	N/A	N/A
1515.2905	11.7	40.99	52.69	85.49	-32.80
6979.038	11.7	43.74	55.44	85.49	-30.05
21672.8056	11.7	46.72	58.42	85.49	-27.07

**802.11n HT20 Mode**

CH Low

Frequency (MHz)	Offset (dB)	Reading (dBuV)	Level (dBuV)	Limit (dBuV)	Margin (dB)
2412.0235	11.7	88.91	100.61	N/A	N/A
1674.4288	11.7	40.91	52.61	80.61	-28.00
6925.9919	11.7	44.26	55.96	80.61	-24.65
21672.8056	11.7	47.53	59.23	80.61	-21.38

CH Mid

Frequency (MHz)	Offset (dB)	Reading (dBuV)	Level (dBuV)	Limit (dBuV)	Margin (dB)
2436.1359	11.7	89.10	100.8	N/A	N/A
1674.4288	11.7	40.99	52.69	80.80	-28.11
6925.9919	11.7	44.41	56.11	80.80	-24.69
21884.4989	11.7	47.92	59.62	80.80	-21.18

CH High

Frequency (MHz)	Offset (dB)	Reading (dBuV)	Level (dBuV)	Limit (dBuV)	Margin (dB)
2462.2351	11.7	89.33	101.03	N/A	N/A
1462.2444	11.7	40.85	52.55	81.03	-28.48
6917.4115	11.7	45.85	57.55	81.03	-23.48
21823.3634	11.7	48.53	60.23	81.03	-20.80

802.11n HT40 Mode

CH Low

Frequency (MHz)	Offset (dB)	Reading (dBuV)	Level (dBuV)	Limit (dBuV)	Margin (dB)
2421.0103	11.7	86.53	98.23	N/A	N/A
1568.3366	11.7	41.00	52.7	78.23	-25.53
6970.4576	11.7	44.82	56.52	78.23	-21.71
21717.2712	11.7	48.51	60.21	78.23	-18.02

CH Mid

Frequency (MHz)	Offset (dB)	Reading (dBuV)	Level (dBuV)	Limit (dBuV)	Margin (dB)
2437.3201	11.7	86.53	98.23	N/A	N/A
1462.2444	11.7	40.13	51.83	78.23	-26.40
6652.1811	11.7	42.57	54.27	78.23	-23.96
21664.2252	11.7	46.78	58.48	78.23	-19.75

CH High

Frequency (MHz)	Offset (dB)	Reading (dBuV)	Level (dBuV)	Limit (dBuV)	Margin (dB)
2451.2036	11.7	84.66	96.36	N/A	N/A
1037.8757	11.7	39.08	50.78	76.36	-25.58
6865.3654	11.7	44.71	56.41	76.36	-19.95
21717.2712	11.7	46.59	58.29	76.36	-18.07



OUT-OF-BAND SPURIOUS EMISSIONS-CONDUCTED MEASUREMENT

(IEEE 802.11b MODE)

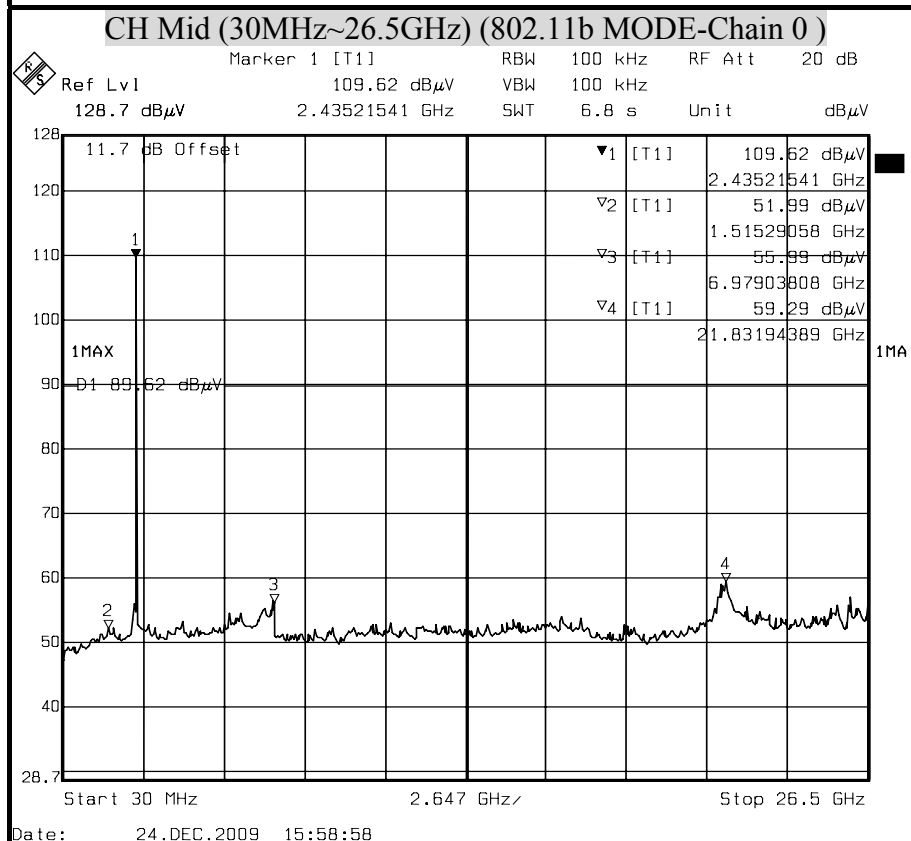
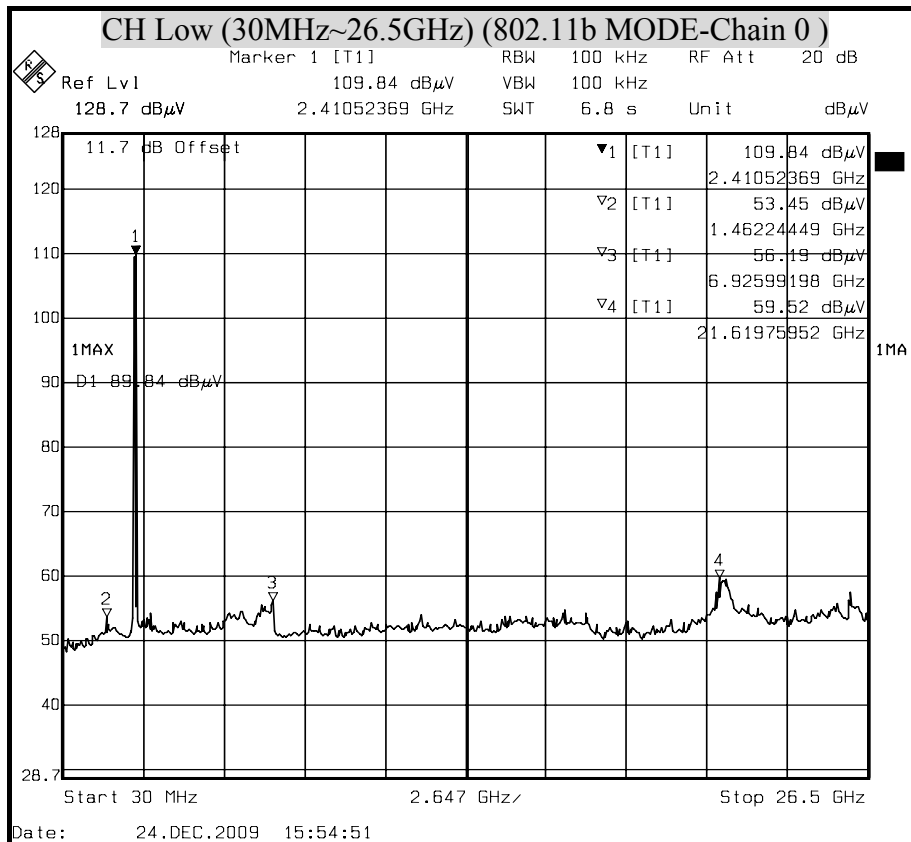

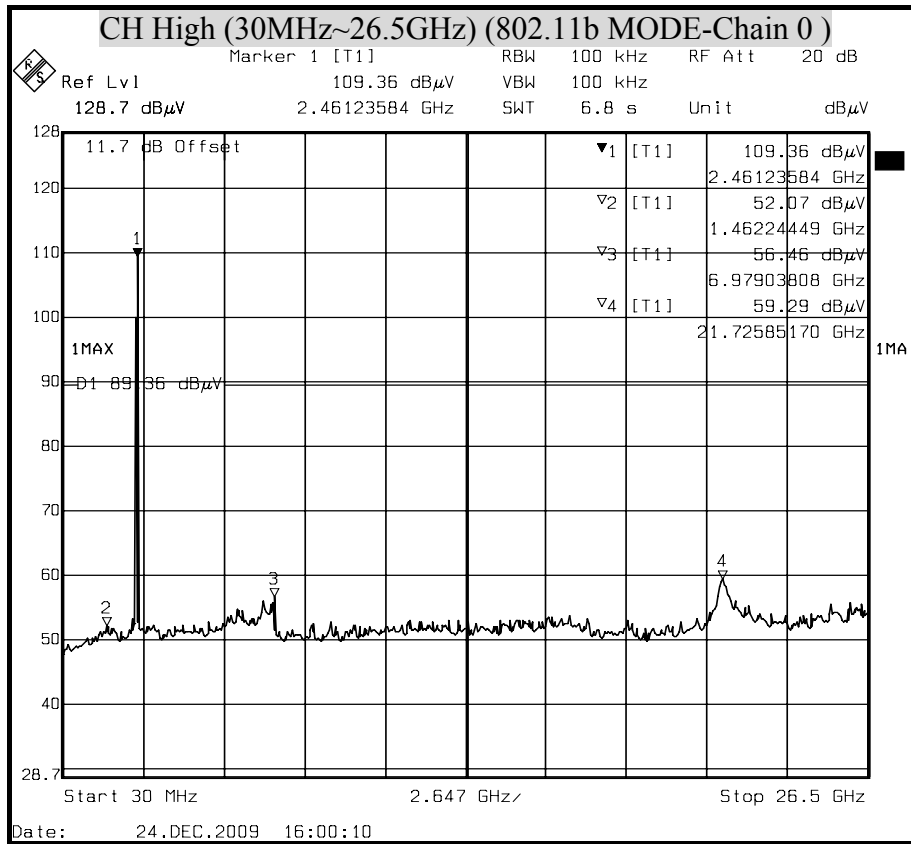



OUT-OF-BAND SPURIOUS EMISSIONS-CONDUCTED MEASUREMENT

(802.11g MODE)

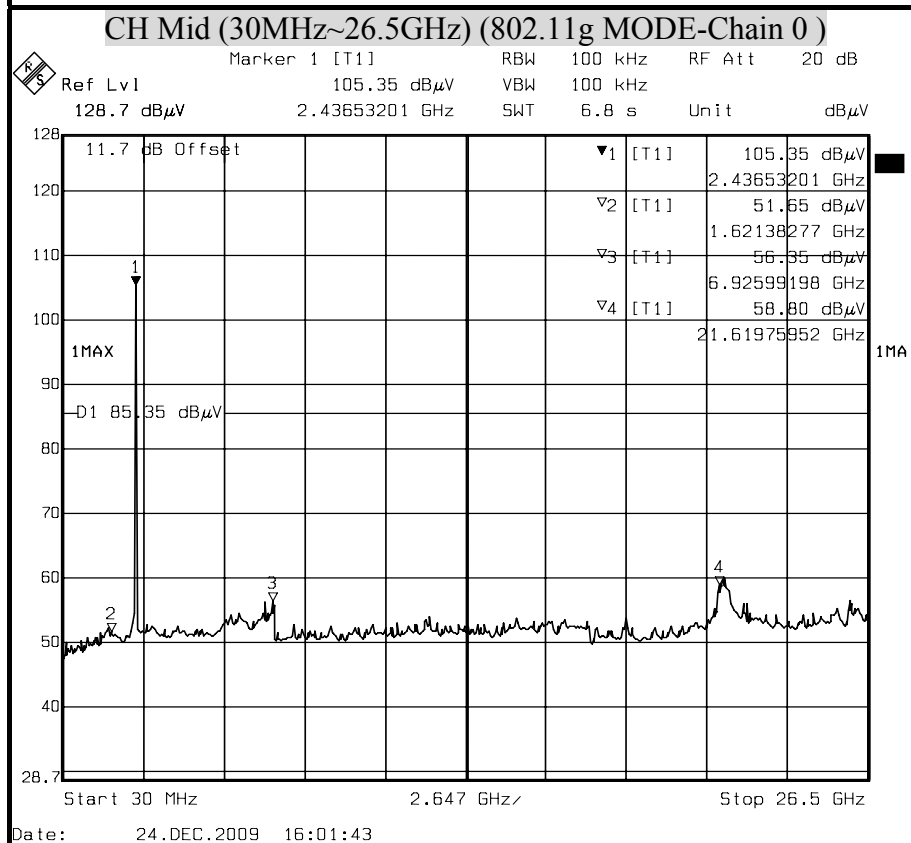
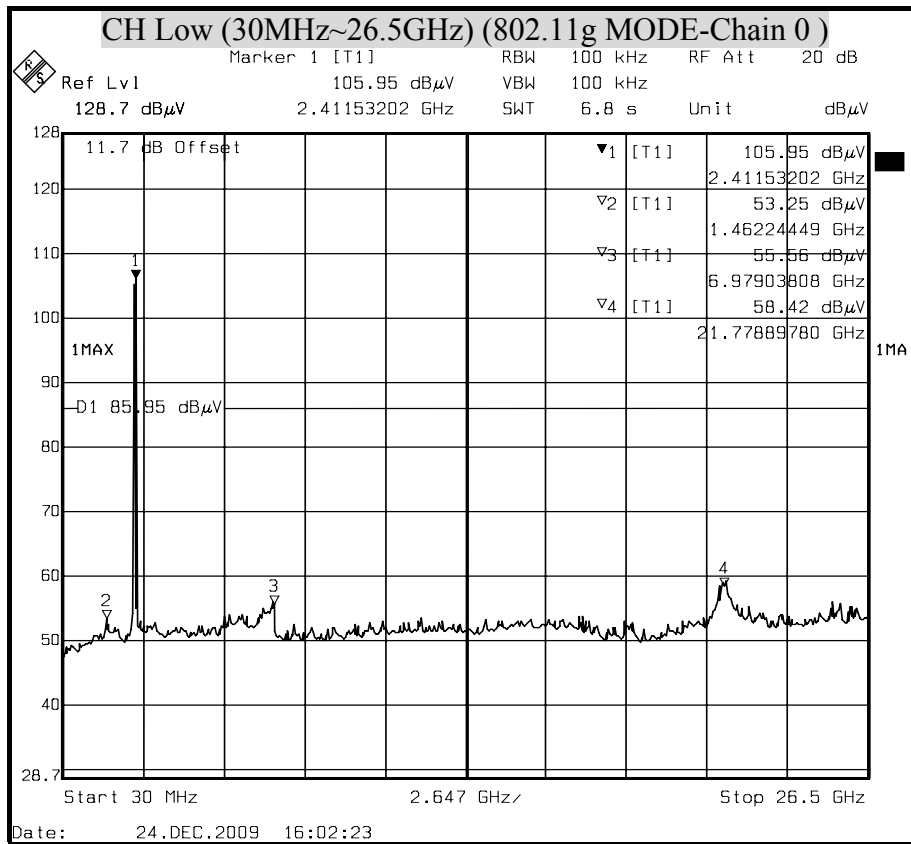

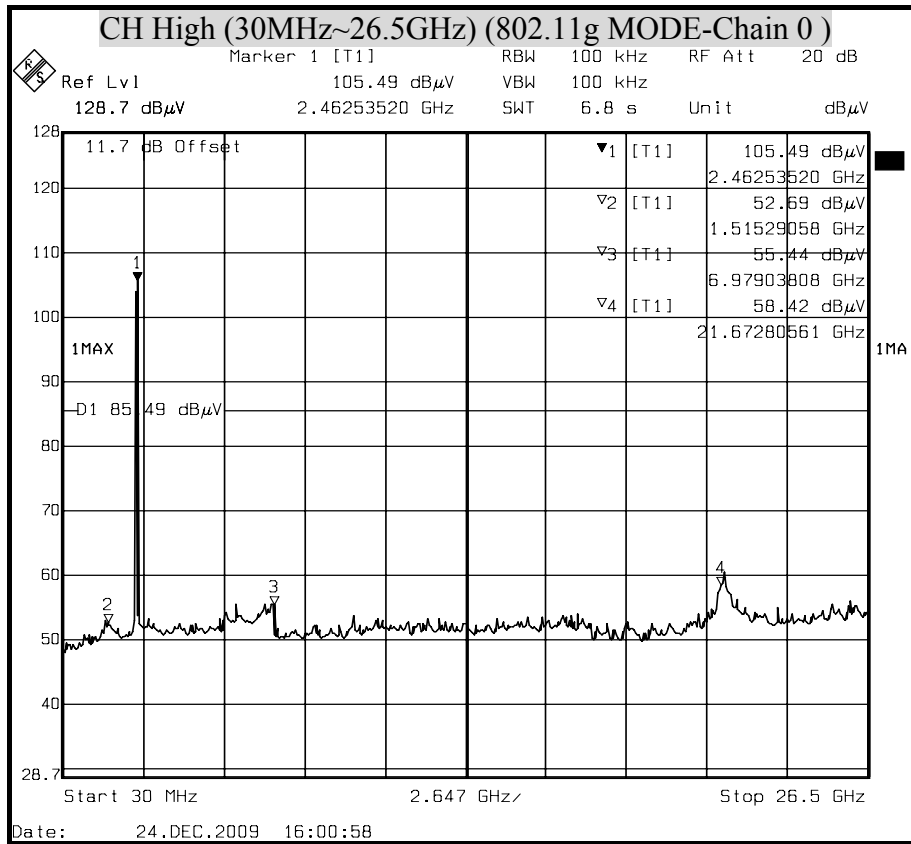



OUT-OF-BAND SPURIOUS EMISSIONS-CONDUCTED MEASUREMENT

(802.11n HT20 MODE)

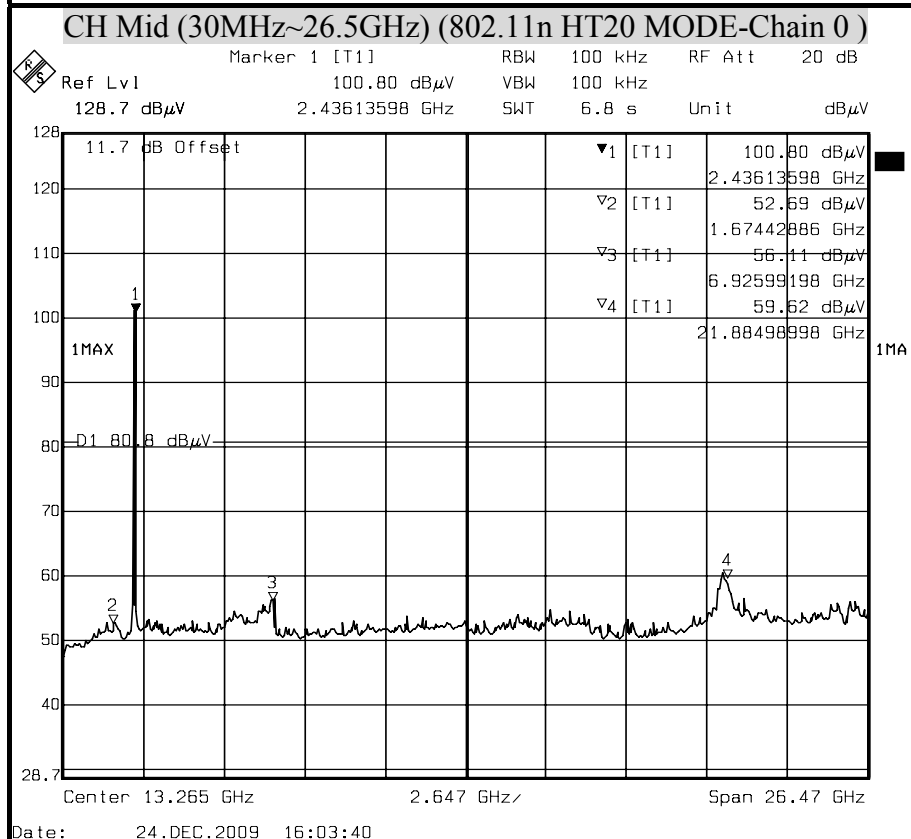
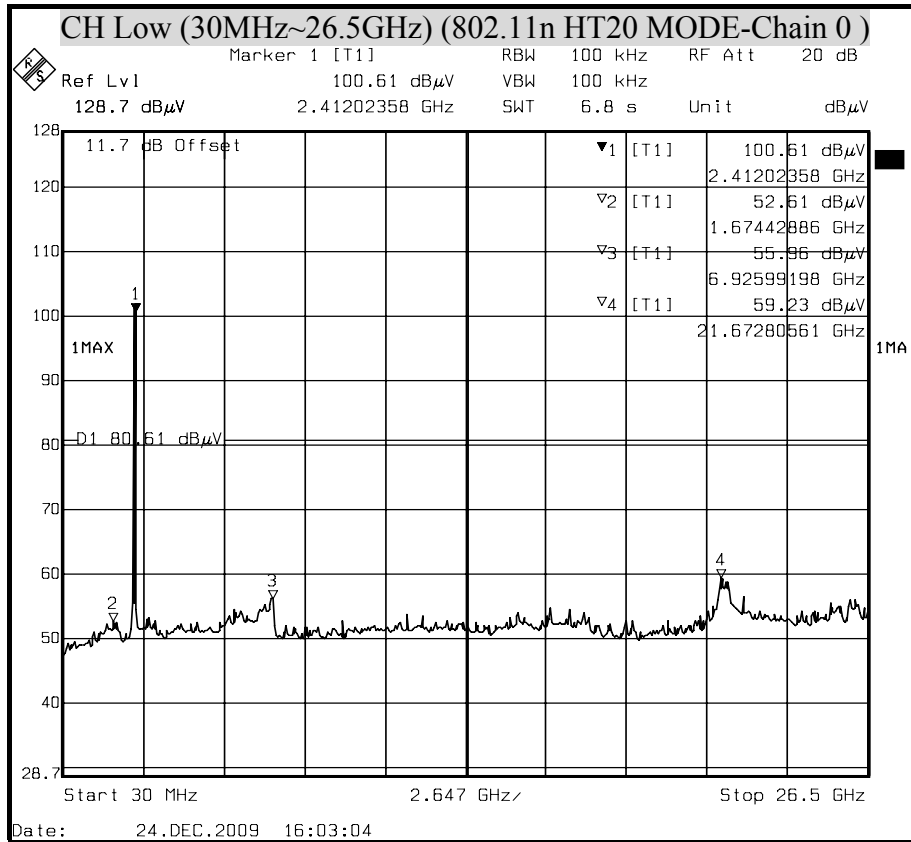

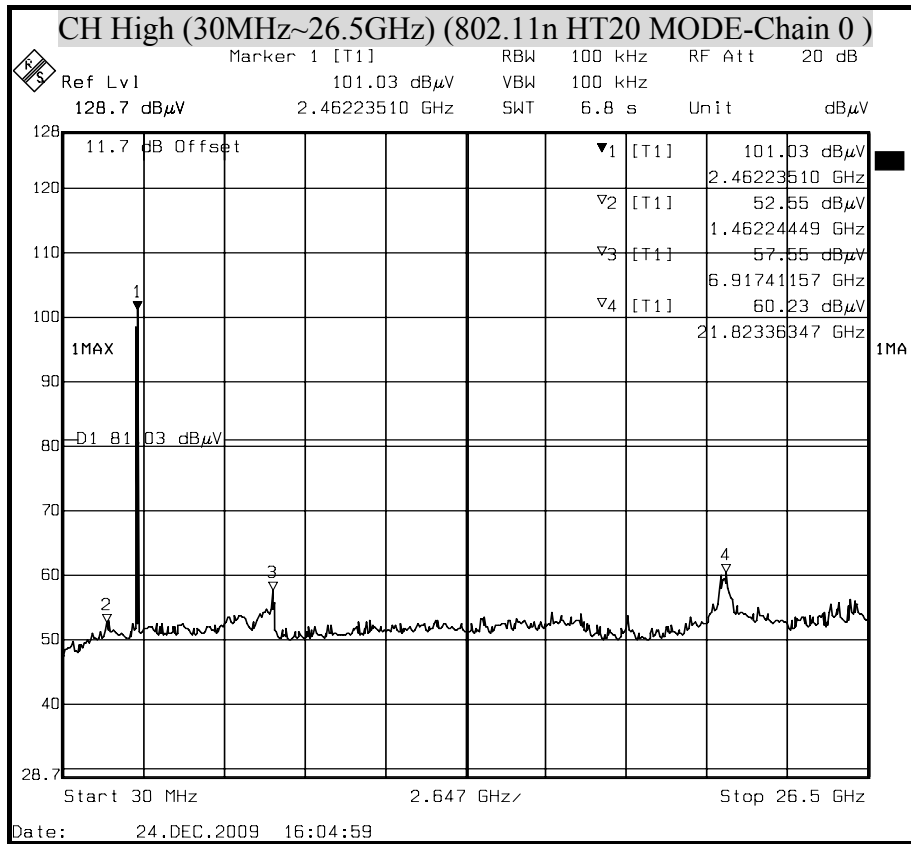



OUT-OF-BAND SPURIOUS EMISSIONS-CONDUCTED MEASUREMENT

(802.11n HT40 MODE)

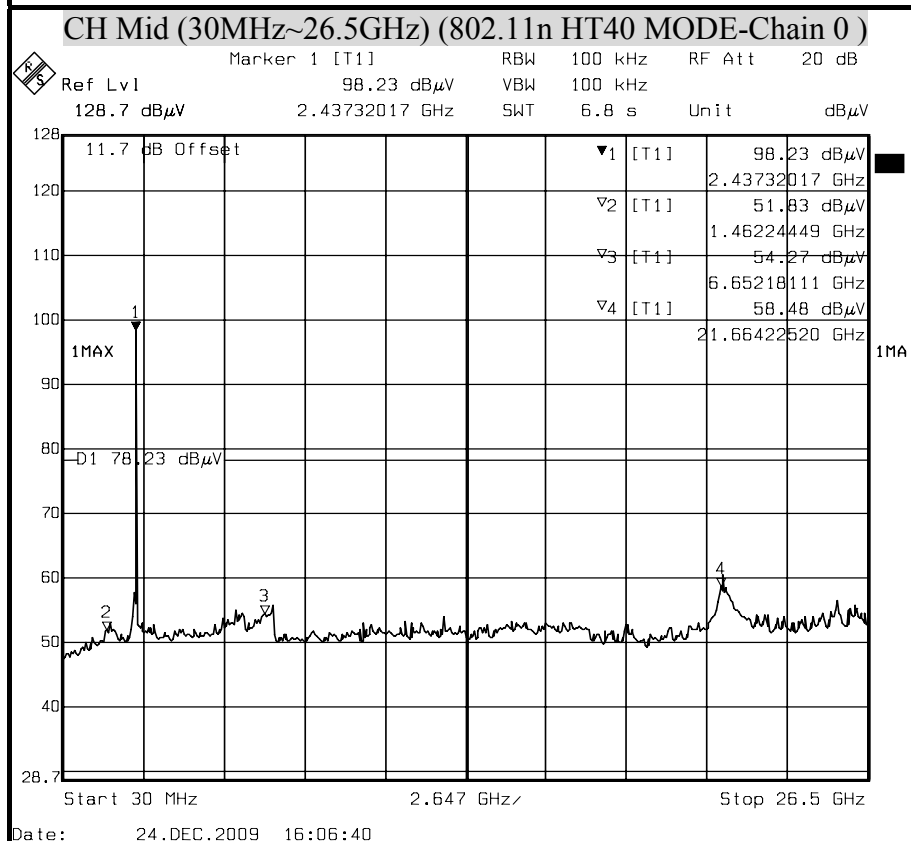
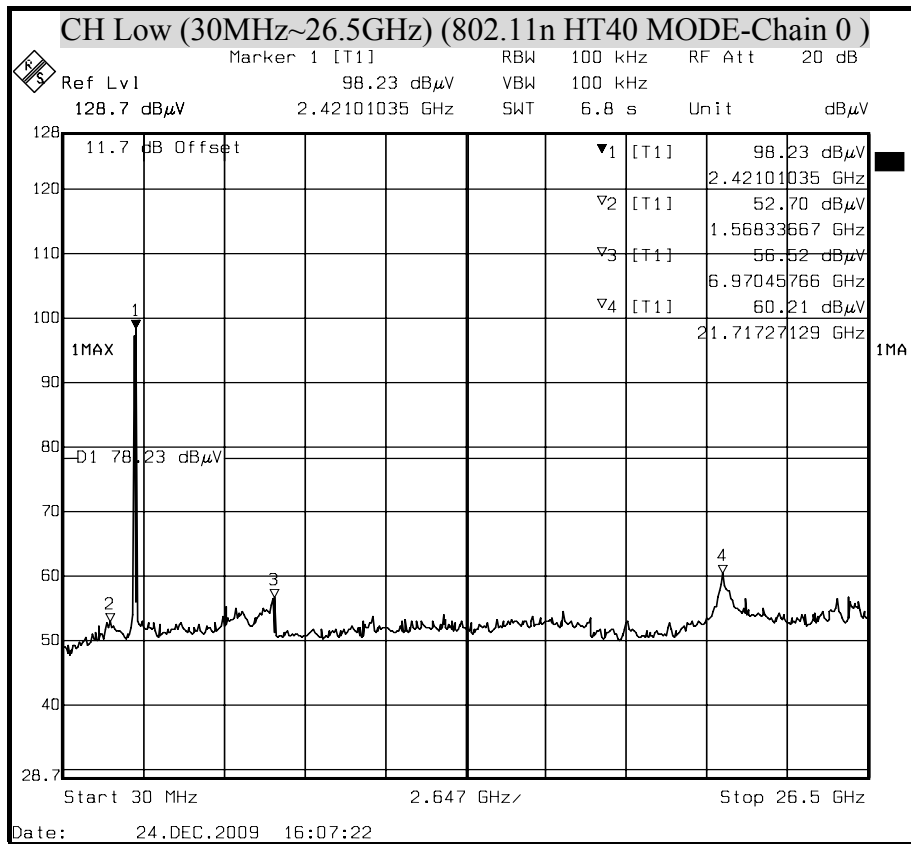

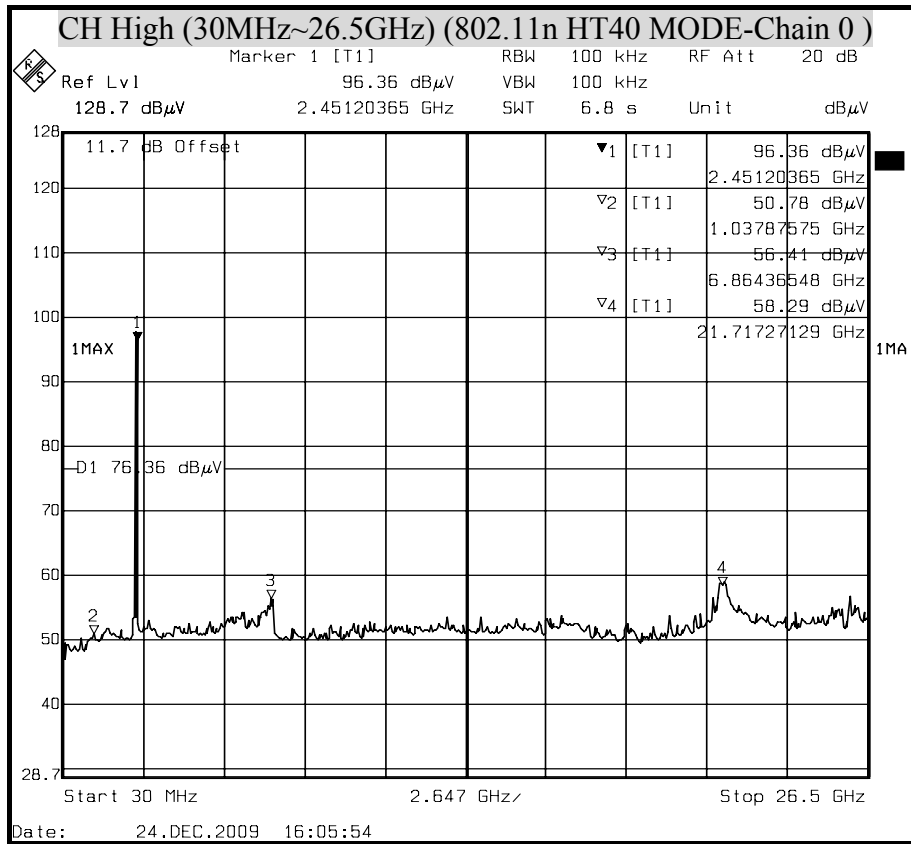



8.6 RADIATED EMISSIONS

8.6.1 TRANSMITTER RADIATED SUPURIOUS EMSSIONS

LIMITS

§ 15.205 (a) Except as shown in paragraph (d) of this section, only spurious emissions are permitted in any of the frequency bands listed below:

MHz	MHz	MHz	GHz
0.090 - 0.110	16.42 - 16.423	399.9 - 410	4.5 - 5.15
¹ 0.495 - 0.505	16.69475 - 16.69525	608 - 614	5.35 - 5.46
2.1735 - 2.1905	16.80425 - 16.80475	960 - 1240	7.25 - 7.75
4.125 - 4.128	25.5 - 25.67	1300 - 1427	8.025 - 8.5
4.17725 - 4.17775	37.5 - 38.25	1435 - 1626.5	9.0 - 9.2
4.20725 - 4.20775	73 - 74.6	1645.5 - 1646.5	9.3 - 9.5
6.215 - 6.218	74.8 - 75.2	1660 -1710	10.6 -12.7
6.26775 - 6.26825	108 -121.94	1718.8 - 1722.2	13.25 -13.4
6.31175 - 6.31225	123 - 138	2200 - 2300	14.47 – 14.5
8.291 - 8.294	149.9 - 150.05	2310 - 2390	15.35 -16.2
8.362 - 8.366	156.52475 - 156.52525	2483.5 - 2500	17.7 - 21.4
8.37625 - 8.38675	156.7 - 156.9	2655 - 2900	22.01 - 23.12
8.41425 - 8.41475	162.0125 - 167.17	3260 - 3267	23.6 - 24.0
12.29 - 12.293	167.72 - 173.2	3332 - 3339	31.2 - 31.8
12.51975 - 12.52025	240 - 285	3345.8 - 3338	36.43 - 36.5
12.57675 - 12.57725	322 -335.4	3600 - 4400	(²)
13.36 - 13.41			

¹ Until February 1, 1999, this restricted band shall be 0.490-0.510 MHz.

² Above 38.6

§ 15.205 (b) Except as provided in paragraphs (d) and (e), the field strength of emissions appearing within these frequency bands shall not exceed the limits shown in Section 15.209. At frequencies equal to or less than 1000 MHz, compliance with the limits in Section 15.209 shall be demonstrated using measurement instrumentation employing a CISPR quasi-peak detector. Above 1000 MHz, compliance with the emission limits in Section 15.209 shall be demonstrated based on the average value of the measured emissions. The provisions in Section 15.35 apply to these measurements.



§ 15.209 (a) Except as provided elsewhere in this Subpart, the emissions from an intentional radiator shall not exceed the field strength levels specified in the following table :

Frequency (MHz)	Field Strength (microvolts/meter)	Measurement Distance (meters)
30 - 88	100 **	3
88 - 216	150 **	3
216 - 960	200 **	3
Above 960	500	3

** Except as provided in paragraph (g), fundamental emissions from intentional radiators operating under this Section shall not be located in the frequency bands 54-72 MHz, 76-88 MHz, 174-216 MHz or 470-806 MHz, However, operation within these frequency bands is permitted under other sections of this Part, e-g, Sections 15.231 and 15.241.

§ 15.209 (b) In the emission table above, the tighter limit applies at the band edges.

TEST EQUIPMENTS

The following test equipments are utilized in making the measurements contained in this report.]

Open Area Test Site # 6				
Name of Equipment	Manufacturer	Model	Serial Number	Calibration Due
Spectrum Analyzer	R&S	FSEK 30	835253/002	OCT. 14, 2010
Temp./Humidity Chamber	K.SON	THS-M1	242	AUG. 12, 2010
EMI Test Receiver	R&S	ESVS10	833206/012	APR. 28, 2010
Pre-Amplifier	HP	8447F	2944A03817	AUG. 31, 2010
Amplifier	MITEQ	AFS44-00108650-42-10P-44	1205908	NOV. 10, 2010
Bilog Antenna	Sunol	JB1	A013105-1	DEC. 10, 2010
Horn Antenna	Com-Power	AH-118	071032	DEC. 29, 2010
Turn Table	YO Chen	001	N/A	N.C.R
Antenna Tower	AR	TP100A	N/A	N.C.R
Controller	CT	SC101	N/A	N.C.R
RF Swieth	E-INSTRUMENT TELH LTD	ERS-180-1-2	EC1204141	N.C.R
Power Meter	Anritsu	ML2487A	6K00003888	APR. 26, 2010
Power Sensor	Anritsu	MA2491A	33265	APR. 26, 2010
AC Power Source	T-POWER	TFC-3020	N930010	N.C.R
DC Power Source	LOKO	DSP-5050	L1507009282	N.C.R

TEST SETUP

The diagram below shows the test setup that is utilized to make the measurements for emission from 30 to 1GHz.

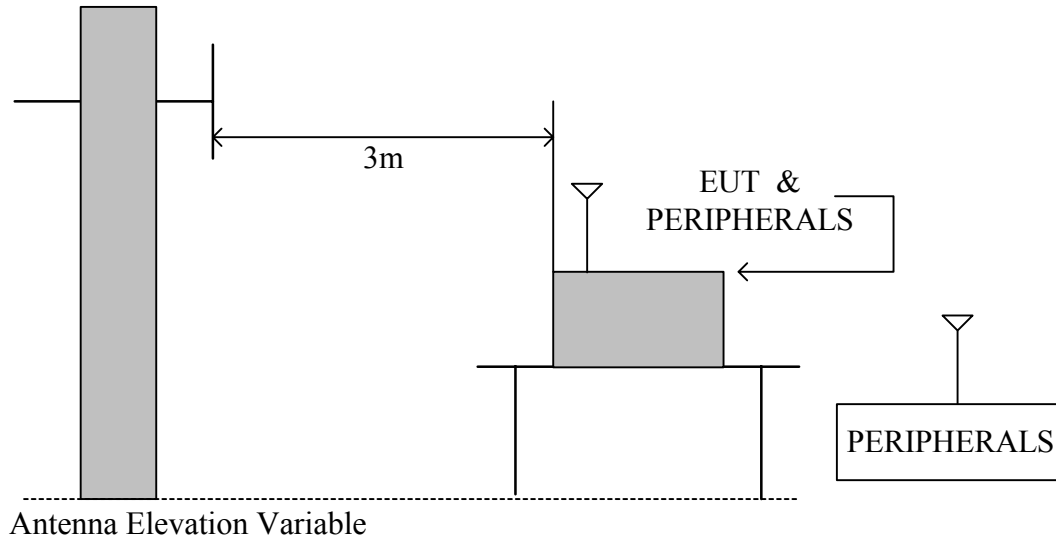

The diagram below shows the test setup that is utilized to make the measurements for emission above 1GHz.

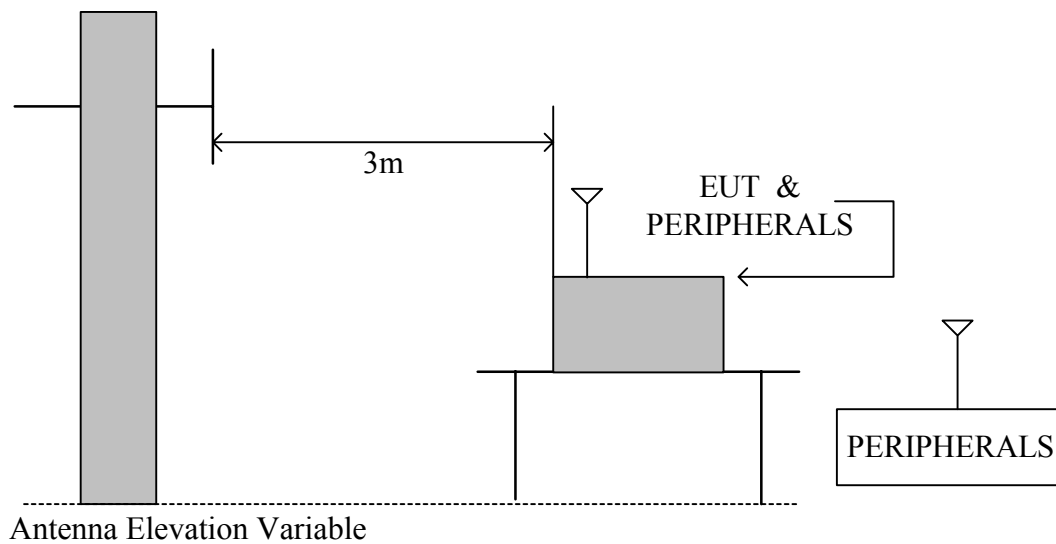



TEST PROCEDURE

- a. The EUT was placed on the top of a rotating table 0.8 meters above the ground at a 10 meter open area test site. The table was rotated 360 degrees to determine the position of the highest radiation.
- b. While measuring the radiated emission below 1GHz, the EUT was set 3 meters away from the interference-receiving antenna, which was mounted on the top of a variable-height antenna tower. While measuring the radiated emission above 1GHz, the EUT was set 3 meters away from the interference-receiving antenna
- c. The antenna is a broadband antenna, and its height is varied from one meter to four meters above the ground to determine the maximum value of the field strength. Both horizontal and vertical polarization of the antenna are set to make the measurement.
- d. For each suspected emission, the EUT was arranged to its worst case and then the antenna was tuned to heights from 1 meter to 4 meters and the table was turned from 0 degrees to 360 degrees to find the maximum reading.
- e. The test-receiver system was set to Peak Detect Function and Specified Bandwidth with Maximum Hold Mode.
- f. If the emission level of the EUT in peak mode was 10 dB lower than the limit specified, then testing could be stopped and the peak values of the EUT would be reported. Otherwise the emissions that did not have 10 dB margin would be re-tested one by one using peak, quasi-peak or average method as specified and then reported in a data sheet.

NOTE:

1. The resolution bandwidth and video bandwidth of test receiver/spectrum analyzer is 120 KHz for Peak detection (PK) and Quasi-peak detection (QP) at frequency below 1GHz.
2. The resolution bandwidth and video bandwidth of test receiver/spectrum analyzer is 1 MHz for Peak detection and frequency above 1GHz.
3. The resolution bandwidth of test receiver/spectrum analyzer is 1 MHz and the video bandwidth is 10 Hz for Average detection (AV) at frequency above 1GHz.
4. **No emission is found between lowest internal used/generated frequency to 30MHz (9kHz~30MHz)**

TEST RESULTS

No non-compliance noted.

**8.6.2 WORST-CASE RADIATED EMISSION BELOW 1 GHz**

Product Name	WiFi Internet Melody Station	Test Date	2009/12/28
Model	MAA502AM	Test By	Eric Yang
Test Mode	Normal operating (worst case) Adapter Model: AMS3-1201500FU	TEMP& Humidity	25.8°C, 58%

Horizontal

Frequency	Meter Reading	Antenna Factor	Cable Loss	Emission Level	Limits	Margin	Detector Mode
(MHz)	(dB μ V)	(dB/M)	(dB)	(dB μ V/M)	(dB μ V/M)	(dB)	PK/QP
50.57	15.80	8.27	0.96	25.03	40.00	-14.97	QP
125.00	18.20	14.30	1.40	33.90	43.50	-9.60	QP
250.00	19.30	12.20	2.02	33.52	46.00	-12.48	QP
320.00	12.80	14.44	2.72	29.96	46.00	-16.04	QP
500.00	17.30	18.00	3.05	38.35	46.00	-7.65	QP
625.00	11.40	19.63	3.61	34.64	46.00	-11.36	QP
853.34	8.70	22.28	4.34	35.32	46.00	-10.68	QP
N/A	-----	-----	-----	-----	-----	-----	-----

Vertical

Frequency	Meter Reading	Antenna Factor	Cable Loss	Emission Level	Limits	Margin	Detector Mode
(MHz)	(dB μ V)	(dB/M)	(dB)	(dB μ V/M)	(dB μ V/M)	(dB)	PK/QP
50.36	19.85	8.28	0.96	29.09	40.00	-10.91	QP
125.00	17.40	14.30	1.40	33.10	43.50	-10.40	QP
250.00	20.50	12.20	2.02	34.72	46.00	-11.28	QP
320.00	19.40	14.44	2.72	36.56	46.00	-9.44	QP
500.00	12.70	18.00	3.05	33.75	46.00	-12.25	QP
640.00	13.20	19.82	3.64	36.66	46.00	-9.34	QP
853.34	9.70	22.28	4.34	36.32	46.00	-9.68	QP
N/A	-----	-----	-----	-----	-----	-----	-----

REMARK: Emission level (dB μ V/m) = Antenna Factor (dB/m) + Cable loss (dB) + Meter Reading (dB μ V).



Product Name	WiFi Internet Melody Station	Test Date	2009/12/28
Model	MAA502AM	Test By	Eric Yang
Test Mode	Normal operating (worst case) Model: PSA18R-120P	TEMP& Humidity	25.8°C, 58%

Horizontal

Frequency	Meter Reading	Antenna Factor	Cable Loss	Emission Level	Limits	Margin	Detector Mode
(MHz)	(dB μ V)	(dB/M)	(dB)	(dB μ V/M)	(dB μ V/M)	(dB)	PK/QP
61.53	17.90	7.79	0.99	26.68	40.00	-13.32	QP
125.00	17.40	14.30	1.40	33.10	43.50	-10.40	QP
250.00	19.20	12.20	2.02	33.42	46.00	-12.58	QP
320.00	12.60	14.44	2.72	29.76	46.00	-16.24	QP
500.00	17.80	18.00	3.05	38.85	46.00	-7.15	QP
625.00	11.20	19.63	3.61	34.44	46.00	-11.56	QP
853.32	8.50	22.28	4.34	35.12	46.00	-10.88	QP
N/A	-----	-----	-----	-----	-----	-----	-----

Vertical

Frequency	Meter Reading	Antenna Factor	Cable Loss	Emission Level	Limits	Margin	Detector Mode
(MHz)	(dB μ V)	(dB/M)	(dB)	(dB μ V/M)	(dB μ V/M)	(dB)	PK/QP
61.34	17.30	7.78	0.99	26.07	40.00	-13.93	QP
125.00	17.90	14.30	1.40	33.60	43.50	-9.90	QP
250.00	20.40	12.20	2.02	34.62	46.00	-11.38	QP
320.00	19.10	14.44	2.72	36.26	46.00	-9.74	QP
500.00	13.20	18.00	3.05	34.25	46.00	-11.75	QP
640.00	13.40	19.82	3.64	36.86	46.00	-9.14	QP
853.32	9.20	22.28	4.34	35.82	46.00	-10.18	QP
N/A	-----	-----	-----	-----	-----	-----	-----

REMARK: Emission level (dB μ V/m) =Antenna Factor (dB/m) + Cable loss (dB) + Meter Reading (dB μ V).

**8.6.3 TRANSMITTER RADIATED EMISSION ABOVE 1 GHz**

Product Name	WiFi Internet Melody Station	Test Date	2009/12/21
Model	MAA502AM	Test By	Eric Yang
Test Mode	IEEE 802.11b TX (CH Low)	TEMP& Humidity	26.8°C, 51%

Horizontal

TX / IEEE 802.11b mode / CH Low				Measurement Distance at 3m				Horizontal polarity		
Freq.	Reading	AF	Cable Loss	Pre-amp	Filter	Level	Limit	Margin	Mark	
(MHz)	(dBμV)	(dB/m)	(dB)	(dB)	(dB)	(dBμV/m)	(dBμV/m)	(dB)	(P/Q/A)	
3493.72	60.94	30.20	3.20	40.45	0.90	54.78	74.00	-19.22	P	
3493.72	56.25	30.20	3.20	40.45	0.90	50.09	54.00	-3.91	A	
* 4823.51	52.43	32.81	3.70	41.34	0.69	48.30	74.00	-25.70	P	
* 4823.51	41.11	32.81	3.70	41.34	0.69	36.98	54.00	-17.02	A	
7234.47	51.37	38.83	4.93	41.43	1.43	55.13	74.00	-18.87	P	
7234.47	40.24	38.83	4.93	41.43	1.43	44.00	54.00	-10.00	A	
N/A	-----	-----	-----	-----	-----	-----	-----	-----	P	
N/A	-----	-----	-----	-----	-----	-----	-----	-----	A	

REMARK:

1. AF: Antenna Factor, Cable: Cable Loss, Pre-Amp: Preamplifier gain, Filter: High Pass Filter Insertion Loss (3.5GHz)
2. Spectrum analyzer setting P(Peak): RBW=1MHz, VBW=1MHz, A(Average): RBW=1MHz, VBW=10Hz
3. The result basic equation calculation is as follow:
Level = Reading + AF + Cable – Preamp + Filter – Dist, Margin = Level-Limit
4. The other emission levels were 20dB below the limit
5. The test limit distance is 3M limit.



Product Name	WiFi Internet Melody Station	Test Date	2009/12/21
Model	MAA502AM	Test By	Eric Yang
Test Mode	IEEE 802.11b TX (CH Low)	TEMP& Humidity	26.8°C, 51%

Vertical

TX / IEEE 802.11b mode / CH Low				Measurement Distance at 3m				Vertical polarity	
Freq.	Reading	AF	Cable Loss	Pre-amp	Filter	Level	Limit	Margin	Mark
(MHz)	(dBμV)	(dB/m)	(dB)	(dB)	(dB)	(dBμV/m)	(dBμV/m)	(dB)	(P/Q/A)
3493.68	58.54	30.20	3.20	40.45	0.90	52.38	74.00	-21.62	P
3493.68	54.25	30.20	3.20	40.45	0.90	48.09	54.00	-5.91	A
* 4822.65	53.67	32.81	3.70	41.33	0.69	49.54	74.00	-24.46	P
* 4822.65	48.12	32.81	3.70	41.33	0.69	43.99	54.00	-10.01	A
7235.46	51.22	38.83	4.93	41.43	1.43	54.99	74.00	-19.01	P
7235.46	42.03	38.83	4.93	41.43	1.43	45.80	54.00	-8.20	A
N/A	-----	-----	-----	-----	-----	-----	-----	-----	P
N/A	-----	-----	-----	-----	-----	-----	-----	-----	A

REMARK:

1. AF: Antenna Factor, Cable: Cable Loss, Pre-Amp: Preamplifier gain, Filter: High Pass Filter Insertion Loss (3.5GHz)
2. Spectrum analyzer setting P(Peak): RBW=1MHz, VBW=1MHz, A(Average): RBW=1MHz, VBW=10Hz
3. The result basic equation calculation is as follow:
Level = Reading + AF + Cable – Preamp + Filter – Dist, Margin = Level-Limit
4. The other emission levels were 20dB below the limit
5. The test limit distance is 3M limit.



Product Name	WiFi Internet Melody Station	Test Date	2009/12/21
Model	MAA502AM	Test By	Eric Yang
Test Mode	IEEE 802.11b TX (CH Middle)	TEMP& Humidity	26.8°C, 51%

Horizontal

	TX / IEEE 802.11b mode / CH Middle				Measurement Distance at 3m				Horizontal polarity	
	Freq. (MHz)	Reading (dBμV)	AF (dB/m)	Cable Loss (dB)	Pre-amp (dB)	Filter (dB)	Level (dBμV/m)	Limit (dBμV/m)	Margin (dB)	Mark (P/Q/A)
	3492.28	59.74	30.20	3.20	40.45	0.90	53.58	74.00	-20.42	P
	3492.28	54.88	30.20	3.20	40.45	0.90	48.72	54.00	-5.28	A
*	4874.03	55.14	32.92	3.73	41.41	0.71	51.10	74.00	-22.90	P
*	4874.03	43.25	32.92	3.73	41.41	0.71	39.21	54.00	-14.79	A
*	7312.63	50.53	38.94	4.96	41.32	1.60	54.71	74.00	-19.29	P
*	7312.63	41.65	38.94	4.96	41.32	1.60	45.83	54.00	-8.17	A
	N/A	-----	-----	-----	-----	-----	-----	-----	-----	P
	N/A	-----	-----	-----	-----	-----	-----	-----	-----	A

REMARK:

1. AF: Antenna Factor, Cable: Cable Loss, Pre-Amp: Preamplifier gain, Filter: High Pass Filter Insertion Loss (3.5GHz)
2. Spectrum analyzer setting P(Peak): RBW=1MHz, VBW=1MHz, A(Average): RBW=1MHz, VBW=10Hz
3. The result basic equation calculation is as follow:
Level = Reading + AF + Cable – Preamp + Filter – Dist, Margin = Level-Limit
4. The other emission levels were 20dB below the limit
5. The test limit distance is 3M limit.



Product Name	WiFi Internet Melody Station	Test Date	2009/12/21
Model	MAA502AM	Test By	Eric Yang
Test Mode	IEEE 802.11b TX (CH Middle)	TEMP& Humidity	26.8°C, 51%

Vertical

TX / IEEE 802.11b mode / CH Middle				Measurement Distance at 3m Vertical polarity					
Freq.	Reading	AF	Cable Loss	Pre-amp	Filter	Level	Limit	Margin	Mark
(MHz)	(dBμV)	(dB/m)	(dB)	(dB)	(dB)	(dBμV/m)	(dBμV/m)	(dB)	(P/Q/A)
3249.27	52.51	30.05	2.82	40.24	1.22	46.35	74.00	-27.65	P
3249.27	46.78	30.05	2.82	40.24	1.22	40.62	54.00	-13.38	A
* 4875.75	57.74	32.93	3.73	41.41	0.71	53.70	74.00	-20.30	P
* 4875.75	45.73	32.93	3.73	41.41	0.71	41.69	54.00	-12.31	A
* 7310.86	51.83	38.94	4.96	41.32	1.60	56.00	74.00	-18.00	P
* 7310.86	41.25	38.94	4.96	41.32	1.60	45.42	54.00	-8.58	A
N/A	-----	-----	-----	-----	-----	-----	-----	-----	P
N/A	-----	-----	-----	-----	-----	-----	-----	-----	A

REMARK:

1. AF: Antenna Factor, Cable: Cable Loss, Pre-Amp: Preamplifier gain, Filter: High Pass Filter Insertion Loss (3.5GHz)
2. Spectrum analyzer setting P(Peak): RBW=1MHz, VBW=1MHz, A(Average): RBW=1MHz, VBW=10Hz
3. The result basic equation calculation is as follow:
Level = Reading + AF + Cable – Preamp + Filter – Dist, Margin = Level-Limit
4. The other emission levels were 20dB below the limit
5. The test limit distance is 3M limit.



Product Name	WiFi Internet Melody Station	Test Date	2009/12/21
Model	MAA502AM	Test By	Eric Yang
Test Mode	IEEE 802.11b TX (CH High)	TEMP& Humidity	26.8°C, 51%

Horizontal

TX / IEEE 802.11b mode / CH High				Measurement Distance at 3m				Horizontal polarity	
Freq.	Reading	AF	Cable Loss	Pre-amp	Filter	Level	Limit	Margin	Mark
(MHz)	(dBμV)	(dB/m)	(dB)	(dB)	(dB)	(dBμV/m)	(dBμV/m)	(dB)	(P/Q/A)
3282.56	50.24	30.07	2.87	40.27	1.17	44.08	74.00	-29.92	P
3282.56	44.68	30.07	2.87	40.27	1.17	38.52	54.00	-15.48	A
* 4922.25	52.41	33.03	3.76	41.48	0.73	48.44	74.00	-25.56	P
* 4922.25	41.75	33.03	3.76	41.48	0.73	37.78	54.00	-16.22	A
* 7385.94	50.22	39.04	4.99	41.21	1.76	54.80	74.00	-19.20	P
* 7385.94	39.87	39.04	4.99	41.21	1.76	44.45	54.00	-9.55	A
N/A	-----	-----	-----	-----	-----	-----	-----	-----	P
N/A	-----	-----	-----	-----	-----	-----	-----	-----	A

REMARK:

1. AF: Antenna Factor, Cable: Cable Loss, Pre-Amp: Preamplifier gain, Filter: High Pass Filter Insertion Loss (3.5GHz)
2. Spectrum analyzer setting P(Peak): RBW=1MHz, VBW=1MHz, A(Average): RBW=1MHz, VBW=10Hz
3. The result basic equation calculation is as follow:
Level = Reading + AF + Cable – Preamp + Filter – Dist, Margin = Level-Limit
4. The other emission levels were 20dB below the limit
5. The test limit distance is 3M limit.



Product Name	WiFi Internet Melody Station	Test Date	2009/12/21
Model	MAA502AM	Test By	Eric Yang
Test Mode	IEEE 802.11b TX (CH High)	TEMP& Humidity	26.8°C, 51%

Vertical

TX / IEEE 802.11b mode / CH High				Measurement Distance at 3m				Vertical polarity	
Freq.	Reading	AF	Cable Loss	Pre-amp	Filter	Level	Limit	Margin	Mark
(MHz)	(dBμV)	(dB/m)	(dB)	(dB)	(dB)	(dBμV/m)	(dBμV/m)	(dB)	(P/Q/A)
3282.63	52.94	30.07	2.87	40.27	1.17	46.78	74.00	-27.22	P
3282.63	47.28	30.07	2.87	40.27	1.17	41.12	54.00	-12.88	A
* 4921.93	55.79	33.03	3.76	41.48	0.73	51.82	74.00	-22.18	P
* 4921.93	44.66	33.03	3.76	41.48	0.73	40.69	54.00	-13.31	A
* 7385.97	52.11	39.04	4.99	41.21	1.76	56.69	74.00	-17.31	P
* 7385.97	41.87	39.04	4.99	41.21	1.76	46.45	54.00	-7.55	A
N/A	-----	-----	-----	-----	-----	-----	-----	-----	P
N/A	-----	-----	-----	-----	-----	-----	-----	-----	A

REMARK:

1. AF: Antenna Factor, Cable: Cable Loss, Pre-Amp: Preamplifier gain, Filter: High Pass Filter Insertion Loss (3.5GHz)
2. Spectrum analyzer setting P(Peak): RBW=1MHz, VBW=1MHz, A(Average): RBW=1MHz, VBW=10Hz
3. The result basic equation calculation is as follow:
Level = Reading + AF + Cable – Preamp + Filter – Dist, Margin = Level-Limit
4. The other emission levels were 20dB below the limit
5. The test limit distance is 3M limit.



Product Name	WiFi Internet Melody Station	Test Date	2009/12/21
Model	MAA502AM	Test By	Eric Yang
Test Mode	IEEE 802.11g TX (CH Low)	TEMP& Humidity	26.8°C, 51%

Horizontal

TX / IEEE 802.11g mode / CH Low				Measurement Distance at 3m				Horizontal polarity		
Freq.	Reading	AF	Cable Loss	Pre-amp	Filter	Level	Limit	Margin	Mark	
(MHz)	(dBμV)	(dB/m)	(dB)	(dB)	(dB)	(dBμV/m)	(dBμV/m)	(dB)	(P/Q/A)	
3215.97	51.24	30.03	2.77	40.22	1.26	45.08	74.00	-28.92	P	
3215.97	46.33	30.03	2.77	40.22	1.26	40.17	54.00	-13.83	A	
* 4823.61	49.88	32.81	3.70	41.34	0.69	45.75	74.00	-28.25	P	
* 4823.61	40.25	32.81	3.70	41.34	0.69	36.12	54.00	-17.88	A	
7237.94	50.34	38.83	4.93	41.42	1.44	54.12	74.00	-19.88	P	
7237.94	40.72	38.83	4.93	41.42	1.44	44.50	54.00	-9.50	A	
N/A	-----	-----	-----	-----	-----	-----	-----	-----	P	
N/A	-----	-----	-----	-----	-----	-----	-----	-----	A	

REMARK:

1. AF: Antenna Factor, Cable: Cable Loss, Pre-Amp: Preamplifier gain, Filter: High Pass Filter Insertion Loss (3.5GHz)
2. Spectrum analyzer setting P(Peak): RBW=1MHz, VBW=1MHz, A(Average): RBW=1MHz, VBW=10Hz
3. The result basic equation calculation is as follow:

$$\text{Level} = \text{Reading} + \text{AF} + \text{Cable} - \text{Preamp} + \text{Filter} - \text{Dist}, \text{Margin} = \text{Level} - \text{Limit}$$
4. The other emission levels were 20dB below the limit
5. The test limit distance is 3M limit.



Product Name	WiFi Internet Melody Station	Test Date	2009/12/21
Model	MAA502AM	Test By	Eric Yang
Test Mode	IEEE 802.11g TX (CH Low)	TEMP& Humidity	26.8°C, 51%

Vertical

TX / IEEE 802.11g mode / CH Low				Measurement Distance at 3m Vertical polarity					
Freq.	Reading	AF	Cable Loss	Pre-amp	Filter	Level	Limit	Margin	Mark
(MHz)	(dBμV)	(dB/m)	(dB)	(dB)	(dB)	(dBμV/m)	(dBμV/m)	(dB)	(P/Q/A)
3216.01	54.67	30.03	2.77	40.22	1.26	48.51	74.00	-25.49	P
3216.01	49.46	30.03	2.77	40.22	1.26	43.30	54.00	-10.70	A
* 4823.75	51.42	32.81	3.70	41.34	0.69	47.29	74.00	-26.71	P
* 4823.75	42.33	32.81	3.70	41.34	0.69	38.20	54.00	-15.80	A
7237.96	52.11	38.83	4.93	41.42	1.44	55.89	74.00	-18.11	P
7237.96	42.67	38.83	4.93	41.42	1.44	46.45	54.00	-7.55	A
N/A	-----	-----	-----	-----	-----	-----	-----	-----	P
N/A	-----	-----	-----	-----	-----	-----	-----	-----	A

REMARK:

1. AF: Antenna Factor, Cable: Cable Loss, Pre-Amp: Preamplifier gain, Filter: High Pass Filter Insertion Loss (3.5GHz)
2. Spectrum analyzer setting P(Peak): RBW=1MHz, VBW=1MHz, A(Average): RBW=1MHz, VBW=10Hz
3. The result basic equation calculation is as follow:
Level = Reading + AF + Cable – Preamp + Filter – Dist, Margin = Level-Limit
4. The other emission levels were 20dB below the limit
5. The test limit distance is 3M limit.



Product Name	WiFi Internet Melody Station	Test Date	2009/12/21
Model	MAA502AM	Test By	Eric Yang
Test Mode	IEEE 802.11g TX (CH Middle)	TEMP& Humidity	26.8°C, 51%

Horizontal

TX / IEEE 802.11g mode / CH Middle				Measurement Distance at 3m				Horizontal polarity	
Freq.	Reading	AF	Cable Loss	Pre-amp	Filter	Level	Limit	Margin	Mark
(MHz)	(dBμV)	(dB/m)	(dB)	(dB)	(dB)	(dBμV/m)	(dBμV/m)	(dB)	(P/Q/A)
3249.15	50.24	30.05	2.82	40.24	1.22	44.08	74.00	-29.92	P
3249.15	44.33	30.05	2.82	40.24	1.22	38.17	54.00	-15.83	A
* 4973.62	50.14	33.14	3.79	41.56	0.75	46.26	74.00	-27.74	P
* 4973.62	40.27	33.14	3.79	41.56	0.75	36.39	54.00	-17.61	A
* 7315.24	49.87	38.94	4.96	41.31	1.60	54.07	74.00	-19.93	P
* 7315.24	39.65	38.94	4.96	41.31	1.60	43.85	54.00	-10.15	A
N/A	-----	-----	-----	-----	-----	-----	-----	-----	P
N/A	-----	-----	-----	-----	-----	-----	-----	-----	A

REMARK:

1. AF: Antenna Factor, Cable: Cable Loss, Pre-Amp: Preamplifier gain, Filter: High Pass Filter Insertion Loss (3.5GHz)
2. Spectrum analyzer setting P(Peak): RBW=1MHz, VBW=1MHz, A(Average): RBW=1MHz, VBW=10Hz
3. The result basic equation calculation is as follow:
Level = Reading + AF + Cable – Preamp + Filter – Dist, Margin = Level-Limit
4. The other emission levels were 20dB below the limit
5. The test limit distance is 3M limit.



Product Name	WiFi Internet Melody Station	Test Date	2009/12/21
Model	MAA502AM	Test By	Eric Yang
Test Mode	IEEE 802.11g TX (CH Middle)	TEMP& Humidity	26.8°C, 51%

Vertical

TX / IEEE 802.11g mode / CH Middle				Measurement Distance at 3m Vertical polarity					
Freq.	Reading	AF	Cable Loss	Pre-amp	Filter	Level	Limit	Margin	Mark
(MHz)	(dBμV)	(dB/m)	(dB)	(dB)	(dB)	(dBμV/m)	(dBμV/m)	(dB)	(P/Q/A)
3249.18	52.09	30.05	2.82	40.24	1.22	45.93	74.00	-28.07	P
3249.18	46.49	30.05	2.82	40.24	1.22	40.33	54.00	-13.67	A
* 4873.45	52.24	32.92	3.73	41.41	0.71	48.19	74.00	-25.81	P
* 4873.45	42.11	32.92	3.73	41.41	0.71	38.06	54.00	-15.94	A
* 7314.95	51.84	38.94	4.96	41.31	1.60	56.03	74.00	-17.97	P
* 7314.95	41.33	38.94	4.96	41.31	1.60	45.52	54.00	-8.48	A
N/A	-----	-----	-----	-----	-----	-----	-----	-----	P
N/A	-----	-----	-----	-----	-----	-----	-----	-----	A

REMARK:

1. AF: Antenna Factor, Cable: Cable Loss, Pre-Amp: Preamplifier gain, Filter: High Pass Filter Insertion Loss (3.5GHz)
2. Spectrum analyzer setting P(Peak): RBW=1MHz, VBW=1MHz, A(Average): RBW=1MHz, VBW=10Hz
3. The result basic equation calculation is as follow:
Level = Reading + AF + Cable – Preamp + Filter – Dist, Margin = Level-Limit
4. The other emission levels were 20dB below the limit
5. The test limit distance is 3M limit.



Product Name	WiFi Internet Melody Station	Test Date	2009/12/21
Model	MAA502AM	Test By	Eric Yang
Test Mode	IEEE 802.11g TX (CH High)	TEMP& Humidity	26.8°C, 51%

Horizontal

TX / IEEE 802.11g mode / CH High				Measurement Distance at 3m				Horizontal polarity	
Freq.	Reading	AF	Cable Loss	Pre-amp	Filter	Level	Limit	Margin	Mark
(MHz)	(dBμV)	(dB/m)	(dB)	(dB)	(dB)	(dBμV/m)	(dBμV/m)	(dB)	(P/Q/A)
3282.49	49.55	30.07	2.87	40.27	1.17	43.39	74.00	-30.61	P
3282.49	43.27	30.07	2.87	40.27	1.17	37.11	54.00	-16.89	A
* 4924.47	49.61	33.03	3.76	41.49	0.73	45.65	74.00	-28.35	P
* 4924.47	38.75	33.03	3.76	41.49	0.73	34.79	54.00	-19.21	A
* 7386.72	49.82	39.04	4.99	41.21	1.76	54.40	74.00	-19.60	P
* 7386.72	38.97	39.04	4.99	41.21	1.76	43.55	54.00	-10.45	A
N/A	-----	-----	-----	-----	-----	-----	-----	-----	P
N/A	-----	-----	-----	-----	-----	-----	-----	-----	A

REMARK:

1. AF: Antenna Factor, Cable: Cable Loss, Pre-Amp: Preamplifier gain, Filter: High Pass Filter Insertion Loss (3.5GHz)
2. Spectrum analyzer setting P(Peak): RBW=1MHz, VBW=1MHz, A(Average): RBW=1MHz, VBW=10Hz
3. The result basic equation calculation is as follow:
Level = Reading + AF + Cable – Preamp + Filter – Dist, Margin = Level-Limit
4. The other emission levels were 20dB below the limit
5. The test limit distance is 3M limit.



Product Name	WiFi Internet Melody Station	Test Date	2009/12/21
Model	MAA502AM	Test By	Eric Yang
Test Mode	IEEE 802.11g TX (CH High)	TEMP& Humidity	26.8°C, 51%

Vertical

TX / IEEE 802.11g mode / CH High				Measurement Distance at 3m Vertical polarity					
Freq.	Reading	AF	Cable Loss	Pre-amp	Filter	Level	Limit	Margin	Mark
(MHz)	(dBμV)	(dB/m)	(dB)	(dB)	(dB)	(dBμV/m)	(dBμV/m)	(dB)	(P/Q/A)
3282.67	51.86	30.07	2.87	40.27	1.17	45.70	74.00	-28.30	P
3282.67	45.73	30.07	2.87	40.27	1.17	39.57	54.00	-14.43	A
* 4924.41	51.62	33.03	3.76	41.49	0.73	47.66	74.00	-26.34	P
* 4924.41	41.25	33.03	3.76	41.49	0.73	37.29	54.00	-16.71	A
* 7386.79	51.11	39.04	4.99	41.21	1.76	55.69	74.00	-18.31	P
* 7386.79	40.87	39.04	4.99	41.21	1.76	45.45	54.00	-8.55	A
N/A	-----	-----	-----	-----	-----	-----	-----	-----	P
N/A	-----	-----	-----	-----	-----	-----	-----	-----	A

REMARK:

1. AF: Antenna Factor, Cable: Cable Loss, Pre-Amp: Preamplifier gain, Filter: High Pass Filter Insertion Loss (3.5GHz)
2. Spectrum analyzer setting P(Peak): RBW=1MHz, VBW=1MHz, A(Average): RBW=1MHz, VBW=10Hz
3. The result basic equation calculation is as follow:
Level = Reading + AF + Cable – Preamp + Filter – Dist, Margin = Level-Limit
4. The other emission levels were 20dB below the limit
5. The test limit distance is 3M limit.



Product Name	WiFi Internet Melody Station	Test Date	2009/12/21
Model	MAA502AM	Test By	Eric Yang
Test Mode	IEEE 802.11n HT20 TX (CH Low)	TEMP& Humidity	26.8°C, 51%

Horizontal

TX / IEEE 802.11n HT20 mode / CH Low				Measurement Distance at 3m				Horizontal polarity	
Freq.	Reading	AF	Cable Loss	Pre-amp	Filter	Level	Limit	Margin	Mark
(MHz)	(dBµV)	(dB/m)	(dB)	(dB)	(dB)	(dBµV/m)	(dBµV/m)	(dB)	(P/Q/A)
3215.98	52.11	30.03	2.77	40.22	1.26	45.95	74.00	-28.05	P
3215.98	47.36	30.03	2.77	40.22	1.26	41.20	54.00	-12.80	A
* 4823.56	52.04	32.81	3.70	41.34	0.69	47.91	74.00	-26.09	P
* 4823.56	41.68	32.81	3.70	41.34	0.69	37.55	54.00	-16.45	A
7233.18	50.22	38.83	4.93	41.43	1.43	53.97	74.00	-20.03	P
7233.18	39.87	38.83	4.93	41.43	1.43	43.62	54.00	-10.38	A
N/A	-----	-----	-----	-----	-----	-----	-----	-----	P
N/A	-----	-----	-----	-----	-----	-----	-----	-----	A

REMARK:

1. AF: Antenna Factor, Cable: Cable Loss, Pre-Amp: Preamplifier gain, Filter: High Pass Filter Insertion Loss (3.5GHz)
2. Spectrum analyzer setting P(Peak): RBW=1MHz, VBW=1MHz, A(Average): RBW=1MHz, VBW=10Hz
3. The result basic equation calculation is as follow:
 $Level = Reading + AF + Cable - Preamp + Filter - Dist$, $Margin = Level - Limit$
4. The other emission levels were 20dB below the limit
5. The test limit distance is 3M limit.



Product Name	WiFi Internet Melody Station	Test Date	2009/12/21
Model	MAA502AM	Test By	Eric Yang
Test Mode	IEEE 802.11n HT20 TX (CH Low)	TEMP& Humidity	26.8°C, 51%

Vertical

TX / IEEE 802.11n HT20 mode / CH Low				Measurement Distance at 3m				Vertical polarity	
Freq.	Reading	AF	Cable Loss	Pre-amp	Filter	Level	Limit	Margin	Mark
(MHz)	(dBμV)	(dB/m)	(dB)	(dB)	(dB)	(dBμV/m)	(dBμV/m)	(dB)	(P/Q/A)
3216.02	54.71	30.03	2.77	40.22	1.26	48.55	74.00	-25.45	P
3216.02	49.70	30.03	2.77	40.22	1.26	43.54	54.00	-10.46	A
* 4822.40	54.14	32.81	3.70	41.33	0.69	50.01	74.00	-23.99	P
* 4822.40	43.25	32.81	3.70	41.33	0.69	39.12	54.00	-14.88	A
7232.45	52.41	38.83	4.93	41.43	1.43	56.16	74.00	-17.84	P
7232.45	41.65	38.83	4.93	41.43	1.43	45.40	54.00	-8.60	A
N/A	-----	-----	-----	-----	-----	-----	-----	-----	P
N/A	-----	-----	-----	-----	-----	-----	-----	-----	A

REMARK:

1. AF: Antenna Factor, Cable: Cable Loss, Pre-Amp: Preamplifier gain, Filter: High Pass Filter Insertion Loss (3.5GHz)
2. Spectrum analyzer setting P(Peak): RBW=1MHz, VBW=1MHz, A(Average): RBW=1MHz, VBW=10Hz
3. The result basic equation calculation is as follow:

$$\text{Level} = \text{Reading} + \text{AF} + \text{Cable} - \text{Preamp} + \text{Filter} - \text{Dist}, \text{Margin} = \text{Level} - \text{Limit}$$
4. The other emission levels were 20dB below the limit
5. The test limit distance is 3M limit.



Product Name	WiFi Internet Melody Station	Test Date	2009/12/21
Model	MAA502AM	Test By	Eric Yang
Test Mode	IEEE 802.11n HT20 TX (CH Middle)	TEMP& Humidity	26.8°C, 51%

Horizontal

	TX / IEEE 802.11n HT20 mode / CH Middle				Measurement Distance at 3m				Horizontal polarity	
	Freq. (MHz)	Reading (dB μ V)	AF (dB/m)	Cable Loss (dB)	Pre-amp (dB)	Filter (dB)	Level (dB μ V/m)	Limit (dB μ V/m)	Margin (dB)	Mark (P/Q/A)
	3249.38	50.22	30.05	2.82	40.24	1.22	44.06	74.00	-29.94	P
	3249.38	45.37	30.05	2.82	40.24	1.22	39.21	54.00	-14.79	A
*	4872.65	51.24	32.92	3.73	41.41	0.71	47.19	74.00	-26.81	P
*	4872.65	40.69	32.92	3.73	41.41	0.71	36.64	54.00	-17.36	A
*	7313.66	49.88	38.94	4.96	41.31	1.60	54.07	74.00	-19.93	P
*	7313.66	38.97	38.94	4.96	41.31	1.60	43.16	54.00	-10.84	A
	N/A	-----	-----	-----	-----	-----	-----	-----	-----	P
	N/A	-----	-----	-----	-----	-----	-----	-----	-----	A

REMARK:

1. AF: Antenna Factor, Cable: Cable Loss, Pre-Amp: Preamplifier gain, Filter: High Pass Filter Insertion Loss (3.5GHz)
2. Spectrum analyzer setting P(Peak): RBW=1MHz, VBW=1MHz, A(Average): RBW=1MHz, VBW=10Hz
3. The result basic equation calculation is as follow:
Level = Reading + AF + Cable – Preamp + Filter – Dist, Margin = Level-Limit
4. The other emission levels were 20dB below the limit
5. The test limit distance is 3M limit.



Product Name	WiFi Internet Melody Station	Test Date	2009/12/21
Model	MAA502AM	Test By	Eric Yang
Test Mode	IEEE 802.11n HT20 TX (CH Middle)	TEMP& Humidity	26.8°C, 51%

Vertical

TX / IEEE 802.11n HT20 mode / CH Middle				Measurement Distance at 3m				Vertical polarity	
Freq.	Reading	AF	Cable Loss	Pre-amp	Filter	Level	Limit	Margin	Mark
(MHz)	(dBμV)	(dB/m)	(dB)	(dB)	(dB)	(dBμV/m)	(dBμV/m)	(dB)	(P/Q/A)
3249.35	52.66	30.05	2.82	40.24	1.22	46.50	74.00	-27.50	P
3249.35	47.06	30.05	2.82	40.24	1.22	40.90	54.00	-13.10	A
* 4873.56	54.22	32.92	3.73	41.41	0.71	50.18	74.00	-23.82	P
* 4873.56	43.26	32.92	3.73	41.41	0.71	39.22	54.00	-14.78	A
* 7315.24	51.22	38.94	4.96	41.31	1.60	55.42	74.00	-18.58	P
* 7315.24	41.67	38.94	4.96	41.31	1.60	45.87	54.00	-8.13	A
N/A	-----	-----	-----	-----	-----	-----	-----	-----	P
N/A	-----	-----	-----	-----	-----	-----	-----	-----	A

REMARK:

1. AF: Antenna Factor, Cable: Cable Loss, Pre-Amp: Preamplifier gain, Filter: High Pass Filter Insertion Loss (3.5GHz)
2. Spectrum analyzer setting P(Peak): RBW=1MHz, VBW=1MHz, A(Average): RBW=1MHz, VBW=10Hz
3. The result basic equation calculation is as follow:
Level = Reading + AF + Cable – Preamp + Filter – Dist, Margin = Level-Limit
4. The other emission levels were 20dB below the limit
5. The test limit distance is 3M limit.



Product Name	WiFi Internet Melody Station	Test Date	2009/12/21
Model	MAA502AM	Test By	Eric Yang
Test Mode	IEEE 802.11n HT20 TX (CH High)	TEMP& Humidity	26.8°C, 51%

Horizontal

TX / IEEE 802.11n HT20 mode / CH High				Measurement Distance at 3m				Horizontal polarity	
Freq.	Reading	AF	Cable Loss	Pre-amp	Filter	Level	Limit	Margin	Mark
(MHz)	(dBμV)	(dB/m)	(dB)	(dB)	(dB)	(dBμV/m)	(dBμV/m)	(dB)	(P/Q/A)
3282.74	50.22	30.07	2.87	40.27	1.17	44.06	74.00	-29.94	P
3282.74	45.67	30.07	2.87	40.27	1.17	39.51	54.00	-14.49	A
* 4924.16	51.24	33.03	3.76	41.49	0.73	47.28	74.00	-26.72	P
* 4924.16	42.33	33.03	3.76	41.49	0.73	38.37	54.00	-15.63	A
* 7387.59	49.87	39.04	4.99	41.21	1.76	54.46	74.00	-19.54	P
* 7387.59	39.28	39.04	4.99	41.21	1.76	43.87	54.00	-10.13	A
N/A	-----	-----	-----	-----	-----	-----	-----	-----	P
N/A	-----	-----	-----	-----	-----	-----	-----	-----	A

REMARK:

1. AF: Antenna Factor, Cable: Cable Loss, Pre-Amp: Preamplifier gain, Filter: High Pass Filter Insertion Loss (3.5GHz)
2. Spectrum analyzer setting P(Peak): RBW=1MHz, VBW=1MHz, A(Average): RBW=1MHz, VBW=10Hz
3. The result basic equation calculation is as follow:
Level = Reading + AF + Cable – Preamp + Filter – Dist, Margin = Level-Limit
4. The other emission levels were 20dB below the limit
5. The test limit distance is 3M limit.



Product Name	WiFi Internet Melody Station	Test Date	2009/12/21
Model	MAA502AM	Test By	Eric Yang
Test Mode	IEEE 802.11n HT20 TX (CH High)	TEMP& Humidity	26.8°C, 51%

Vertical

TX / IEEE 802.11n HT20 mode / CH High				Measurement Distance at 3m				Vertical polarity	
Freq.	Reading	AF	Cable Loss	Pre-amp	Filter	Level	Limit	Margin	Mark
(MHz)	(dBμV)	(dB/m)	(dB)	(dB)	(dB)	(dBμV/m)	(dBμV/m)	(dB)	(P/Q/A)
3282.68	52.89	30.07	2.87	40.27	1.17	46.73	74.00	-27.27	P
3282.68	47.28	30.07	2.87	40.27	1.17	41.12	54.00	-12.88	A
* 4923.54	53.25	33.03	3.76	41.49	0.73	49.29	74.00	-24.71	P
* 4923.54	44.71	33.03	3.76	41.49	0.73	40.75	54.00	-13.25	A
* 7387.65	51.22	39.04	4.99	41.21	1.76	55.81	74.00	-18.19	P
* 7387.65	41.72	39.04	4.99	41.21	1.76	46.31	54.00	-7.69	A
N/A	-----	-----	-----	-----	-----	-----	-----	-----	P
N/A	-----	-----	-----	-----	-----	-----	-----	-----	A

REMARK:

1. AF: Antenna Factor, Cable: Cable Loss, Pre-Amp: Preamplifier gain, Filter: High Pass Filter Insertion Loss (3.5GHz)
2. Spectrum analyzer setting P(Peak): RBW=1MHz, VBW=1MHz, A(Average): RBW=1MHz, VBW=10Hz
3. The result basic equation calculation is as follow:

$$\text{Level} = \text{Reading} + \text{AF} + \text{Cable} - \text{Preamp} + \text{Filter} - \text{Dist}, \text{Margin} = \text{Level} - \text{Limit}$$
4. The other emission levels were 20dB below the limit
5. The test limit distance is 3M limit.



Product Name	WiFi Internet Melody Station	Test Date	2009/12/21
Model	MAA502AM	Test By	Eric Yang
Test Mode	IEEE 802.11n HT40 TX (CH Low)	TEMP& Humidity	26.8°C, 51%

Horizontal

TX / IEEE 802.11n HT40 mode / CH Low				Measurement Distance at 3m				Horizontal polarity		
Freq.	Reading	AF	Cable Loss	Pre-amp	Filter	Level	Limit	Margin	Mark	
(MHz)	(dBμV)	(dB/m)	(dB)	(dB)	(dB)	(dBμV/m)	(dBμV/m)	(dB)	(P/Q/A)	
3229.24	50.42	30.04	2.79	40.23	1.24	44.26	74.00	-29.74	P	
3229.24	41.67	30.04	2.79	40.23	1.24	35.51	54.00	-18.49	A	
* 4841.66	51.24	32.85	3.71	41.36	0.70	47.14	74.00	-26.86	P	
* 4841.66	42.38	32.85	3.71	41.36	0.70	38.28	54.00	-15.72	A	
* 7264.17	50.22	38.87	4.94	41.38	1.50	54.14	74.00	-19.86	P	
* 7264.17	39.87	38.87	4.94	41.38	1.50	43.79	54.00	-10.21	A	
N/A	-----	-----	-----	-----	-----	-----	-----	-----	P	
N/A	-----	-----	-----	-----	-----	-----	-----	-----	A	

REMARK:

1. AF: Antenna Factor, Cable: Cable Loss, Pre-Amp: Preamplifier gain, Filter: High Pass Filter Insertion Loss (3.5GHz)
2. Spectrum analyzer setting P(Peak): RBW=1MHz, VBW=1MHz, A(Average): RBW=1MHz, VBW=10Hz
3. The result basic equation calculation is as follow:
Level = Reading + AF + Cable – Preamp + Filter – Dist, Margin = Level-Limit
4. The other emission levels were 20dB below the limit
5. The test limit distance is 3M limit.



Product Name	WiFi Internet Melody Station	Test Date	2009/12/21
Model	MAA502AM	Test By	Eric Yang
Test Mode	IEEE 802.11n HT40 TX (CH Low)	TEMP& Humidity	26.8°C, 51%

Vertical

TX / IEEE 802.11n HT40 mode / CH Low				Measurement Distance at 3m Vertical polarity					
Freq.	Reading	AF	Cable Loss	Pre-amp	Filter	Level	Limit	Margin	Mark
(MHz)	(dBμV)	(dB/m)	(dB)	(dB)	(dB)	(dBμV/m)	(dBμV/m)	(dB)	(P/Q/A)
3229.30	52.25	30.04	2.79	40.23	1.24	46.09	74.00	-27.91	P
3229.30	43.16	30.04	2.79	40.23	1.24	37.00	54.00	-17.00	A
* 4843.11	53.24	32.85	3.72	41.36	0.70	49.15	74.00	-24.85	P
* 4843.11	44.15	32.85	3.72	41.36	0.70	40.06	54.00	-13.94	A
* 7364.24	52.24	39.01	4.98	41.24	1.71	56.70	74.00	-17.30	P
* 7364.24	41.35	39.01	4.98	41.24	1.71	45.81	54.00	-8.19	A
N/A	-----	-----	-----	-----	-----	-----	-----	-----	P
N/A	-----	-----	-----	-----	-----	-----	-----	-----	A

REMARK:

1. AF: Antenna Factor, Cable: Cable Loss, Pre-Amp: Preamplifier gain, Filter: High Pass Filter Insertion Loss (3.5GHz)
2. Spectrum analyzer setting P(Peak): RBW=1MHz, VBW=1MHz, A(Average): RBW=1MHz, VBW=10Hz
3. The result basic equation calculation is as follow:

$$\text{Level} = \text{Reading} + \text{AF} + \text{Cable} - \text{Preamp} + \text{Filter} - \text{Dist}, \text{Margin} = \text{Level} - \text{Limit}$$
4. The other emission levels were 20dB below the limit
5. The test limit distance is 3M limit.



Product Name	WiFi Internet Melody Station	Test Date	2009/12/21
Model	MAA502AM	Test By	Eric Yang
Test Mode	IEEE 802.11n HT40 TX (CH Middle)	TEMP& Humidity	26.8°C, 51%

Horizontal

	TX / IEEE 802.11n HT40 mode / CH Middle				Measurement Distance at 3m				Horizontal polarity	
	Freq. (MHz)	Reading (dBμV)	AF (dB/m)	Cable Loss (dB)	Pre-amp (dB)	Filter (dB)	Level (dBμV/m)	Limit (dBμV/m)	Margin (dB)	Mark (P/Q/A)
	3249.28	50.41	30.05	2.82	40.24	1.22	44.25	74.00	-29.75	P
	3249.28	44.72	30.05	2.82	40.24	1.22	38.56	54.00	-15.44	A
*	4872.55	50.14	32.92	3.73	41.41	0.71	46.09	74.00	-27.91	P
*	4872.55	41.27	32.92	3.73	41.41	0.71	37.22	54.00	-16.78	A
*	7313.49	49.86	38.94	4.96	41.31	1.60	54.05	74.00	-19.95	P
*	7313.49	39.88	38.94	4.96	41.31	1.60	44.07	54.00	-9.93	A
	N/A	-----	-----	-----	-----	-----	-----	-----	-----	P
	N/A	-----	-----	-----	-----	-----	-----	-----	-----	A

REMARK:

1. AF: Antenna Factor, Cable: Cable Loss, Pre-Amp: Preamplifier gain, Filter: High Pass Filter Insertion Loss (3.5GHz)
2. Spectrum analyzer setting P(Peak): RBW=1MHz, VBW=1MHz, A(Average): RBW=1MHz, VBW=10Hz
3. The result basic equation calculation is as follow:
Level = Reading + AF + Cable – Preamp + Filter – Dist, Margin = Level-Limit
4. The other emission levels were 20dB below the limit
5. The test limit distance is 3M limit.



Product Name	WiFi Internet Melody Station	Test Date	2009/12/21
Model	MAA502AM	Test By	Eric Yang
Test Mode	IEEE 802.11n HT40 TX (CH Middle)	TEMP& Humidity	26.8°C, 51%

Vertical

TX / IEEE 802.11n HT40 mode / CH Middle				Measurement Distance at 3m				Vertical polarity	
Freq.	Reading	AF	Cable Loss	Pre-amp	Filter	Level	Limit	Margin	Mark
(MHz)	(dBμV)	(dB/m)	(dB)	(dB)	(dB)	(dBμV/m)	(dBμV/m)	(dB)	(P/Q/A)
3249.24	52.68	30.05	2.82	40.24	1.22	46.52	74.00	-27.48	P
3249.24	47.15	30.05	2.82	40.24	1.22	40.99	54.00	-13.01	A
* 4873.25	52.22	32.92	3.73	41.41	0.71	48.17	74.00	-25.83	P
* 4873.25	43.65	32.92	3.73	41.41	0.71	39.60	54.00	-14.40	A
* 7312.54	51.42	38.94	4.96	41.32	1.60	55.60	74.00	-18.40	P
* 7312.54	42.11	38.94	4.96	41.32	1.60	46.29	54.00	-7.71	A
N/A	-----	-----	-----	-----	-----	-----	-----	-----	P
N/A	-----	-----	-----	-----	-----	-----	-----	-----	A

REMARK:

1. AF: Antenna Factor, Cable: Cable Loss, Pre-Amp: Preamplifier gain, Filter: High Pass Filter Insertion Loss (3.5GHz)
2. Spectrum analyzer setting P(Peak): RBW=1MHz, VBW=1MHz, A(Average): RBW=1MHz, VBW=10Hz
3. The result basic equation calculation is as follow:
Level = Reading + AF + Cable – Preamp + Filter – Dist, Margin = Level-Limit
4. The other emission levels were 20dB below the limit
5. The test limit distance is 3M limit.



Product Name	WiFi Internet Melody Station	Test Date	2009/12/21
Model	MAA502AM	Test By	Eric Yang
Test Mode	IEEE 802.11n HT40 TX (CH High)	TEMP& Humidity	26.8°C, 51%

Horizontal

TX / IEEE 802.11n HT40 mode / CH High				Measurement Distance at 3m				Horizontal polarity	
Freq.	Reading	AF	Cable Loss	Pre-amp	Filter	Level	Limit	Margin	Mark
(MHz)	(dBμV)	(dB/m)	(dB)	(dB)	(dB)	(dBμV/m)	(dBμV/m)	(dB)	(P/Q/A)
3269.27	51.24	30.06	2.85	40.26	1.19	45.08	74.00	-28.92	P
3269.27	45.67	30.06	2.85	40.26	1.19	39.51	54.00	-14.49	A
* 4903.28	50.22	32.99	3.75	41.45	0.72	46.22	74.00	-27.78	P
* 4903.28	40.75	32.99	3.75	41.45	0.72	36.75	54.00	-17.25	A
* 7257.46	49.86	38.86	4.94	41.39	1.48	53.75	74.00	-20.25	P
* 7257.46	39.28	38.86	4.94	41.39	1.48	43.17	54.00	-10.83	A
N/A	-----	-----	-----	-----	-----	-----	-----	-----	P
N/A	-----	-----	-----	-----	-----	-----	-----	-----	A

REMARK:

1. AF: Antenna Factor, Cable: Cable Loss, Pre-Amp: Preamplifier gain, Filter: High Pass Filter Insertion Loss (3.5GHz)
2. Spectrum analyzer setting P(Peak): RBW=1MHz, VBW=1MHz, A(Average): RBW=1MHz, VBW=10Hz
3. The result basic equation calculation is as follow:

$$\text{Level} = \text{Reading} + \text{AF} + \text{Cable} - \text{Preamp} + \text{Filter} - \text{Dist}, \text{Margin} = \text{Level} - \text{Limit}$$
4. The other emission levels were 20dB below the limit
5. The test limit distance is 3M limit.



Product Name	WiFi Internet Melody Station	Test Date	2009/12/21
Model	MAA502AM	Test By	Eric Yang
Test Mode	IEEE 802.11n HT40 TX (CH High)	TEMP& Humidity	26.8°C, 51%

Vertical

TX / IEEE 802.11n HT40 mode / CH High				Measurement Distance at 3m				Vertical polarity	
Freq.	Reading	AF	Cable Loss	Pre-amp	Filter	Level	Limit	Margin	Mark
(MHz)	(dBμV)	(dB/m)	(dB)	(dB)	(dB)	(dBμV/m)	(dBμV/m)	(dB)	(P/Q/A)
3269.20	53.12	30.06	2.85	40.26	1.19	46.96	74.00	-27.04	P
3269.20	47.15	30.06	2.85	40.26	1.19	40.99	54.00	-13.01	A
* 4902.75	53.24	32.99	3.75	41.45	0.72	49.24	74.00	-24.76	P
* 4902.75	43.22	32.99	3.75	41.45	0.72	39.22	54.00	-14.78	A
* 7257.64	51.22	38.86	4.94	41.39	1.48	55.11	74.00	-18.89	P
* 7257.64	41.75	38.86	4.94	41.39	1.48	45.64	54.00	-8.36	A
N/A	-----	-----	-----	-----	-----	-----	-----	-----	P
N/A	-----	-----	-----	-----	-----	-----	-----	-----	A

REMARK:

1. AF: Antenna Factor, Cable: Cable Loss, Pre-Amp: Preamplifier gain, Filter: High Pass Filter Insertion Loss (3.5GHz)
2. Spectrum analyzer setting P(Peak): RBW=1MHz, VBW=1MHz, A(Average): RBW=1MHz, VBW=10Hz
3. The result basic equation calculation is as follow:
Level = Reading + AF + Cable – Preamp + Filter – Dist, Margin = Level-Limit
4. The other emission levels were 20dB below the limit
5. The test limit distance is 3M limit.



8.6.4 RESTRICTED BAND EDGES

802.11b Mode

Channel	Polarity	Freq.(MHz)	Level(dBuV)	Limit(dBuV)	Margin(dB)	Detector
LOW	H	2390.00	60.94	74	-13.06	Peak
	H	2390.00	48.56	54	-5.44	Average
	V	2390.00	58.43	74	-15.57	Peak
	V	2390.00	46.6	54	-7.40	Average
HIGH	H	2483.50	61.05	74	-12.95	Peak
	H	2483.50	49.68	54	-4.32	Average
	V	2483.50	59.19	74	-14.81	Peak
	V	2483.50	46.7	54	-7.30	Average

802.11g Mode

Channel	Polarity	Freq.(MHz)	Level(dBuV)	Limit(dBuV)	Margin(dB)	Detector
LOW	H	2390.00	69.58	74	-4.42	Peak
	H	2390.00	51.72	54	-2.28	Average
	V	2390.00	59.13	74	-14.87	Peak
	V	2390.00	47.01	54	-6.99	Average
HIGH	H	2483.50	69.9	74	-4.10	Peak
	H	2483.50	52.34	54	-1.66	Average
	V	2483.50	65.69	74	-8.31	Peak
	V	2483.50	49.29	54	-4.71	Average

802.11n HT-20 Mode

Channel	Polarity	Freq.(MHz)	Level(dBuV)	Limit(dBuV)	Margin(dB)	Detector
LOW	H	2390.00	64.24	74	-9.76	Peak
	H	2390.00	47.78	54	-6.22	Average
	V	2390.00	58.54	74	-15.46	Peak
	V	2390.00	46.02	54	-7.98	Average
HIGH	H	2483.50	65.51	74	-8.49	Peak
	H	2483.50	48.73	54	-5.27	Average
	V	2483.50	58.60	74	-15.40	Peak
	V	2483.50	46	54	-8.00	Average

802.11n HT-40 Mode

Channel	Polarity	Freq.(MHz)	Level(dBuV)	Limit(dBuV)	Margin(dB)	Detector
LOW	H	2390.00	62.24	74	-11.76	Peak
	H	2390.00	49.15	54	-4.85	Average
	V	2390.00	58.6	74	-15.40	Peak
	V	2390.00	46.56	54	-7.44	Average
HIGH	H	2483.50	67.23	74	-6.77	Peak
	H	2483.50	52.88	54	-1.12	Average
	V	2483.50	59.67	74	-14.33	Peak
	V	2483.50	47.4	54	-6.60	Average



Detector mode : Peak Polarity : Horizontal

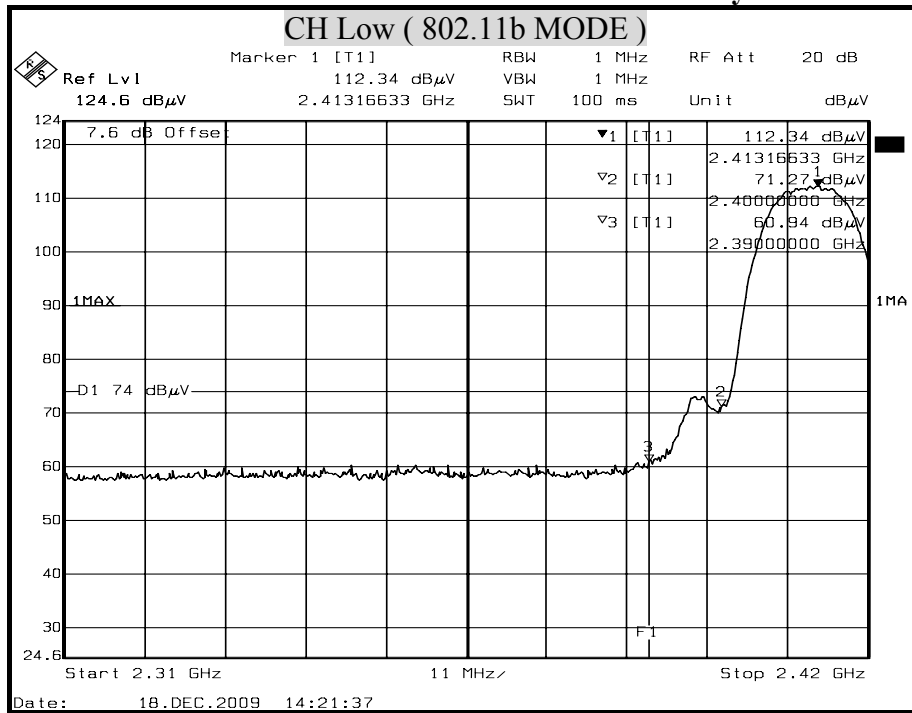

Detector mode : Average Polarity : Horizontal

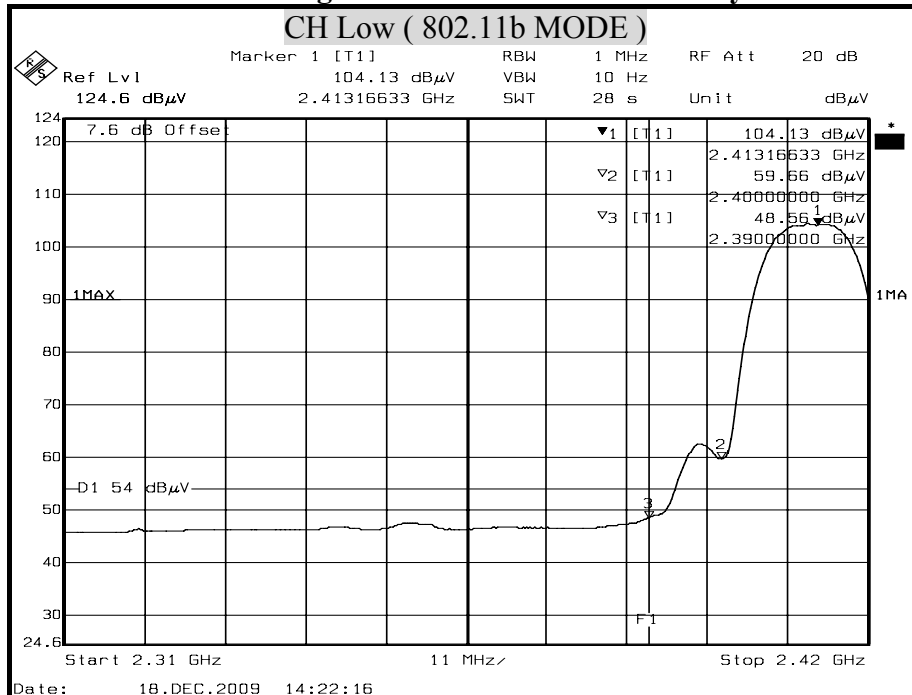

Remark:

1. Display Line = 54/74 dB μ V/m.
2. 2390MHz Offset(dB) = Antenna Factor(dB/m) + Cable Loss(dB) - Pre-Amplifier(dB) + Attenuator(dB)=7.6(dB)
3. 2483.5MHz Offset(dB) = Antenna Factor(dB/m) + Cable Loss(dB) - Pre-Amplifier(dB) + Attenuator(dB)=7.62(dB)



Detector mode : Peak

Polarity : Vertical

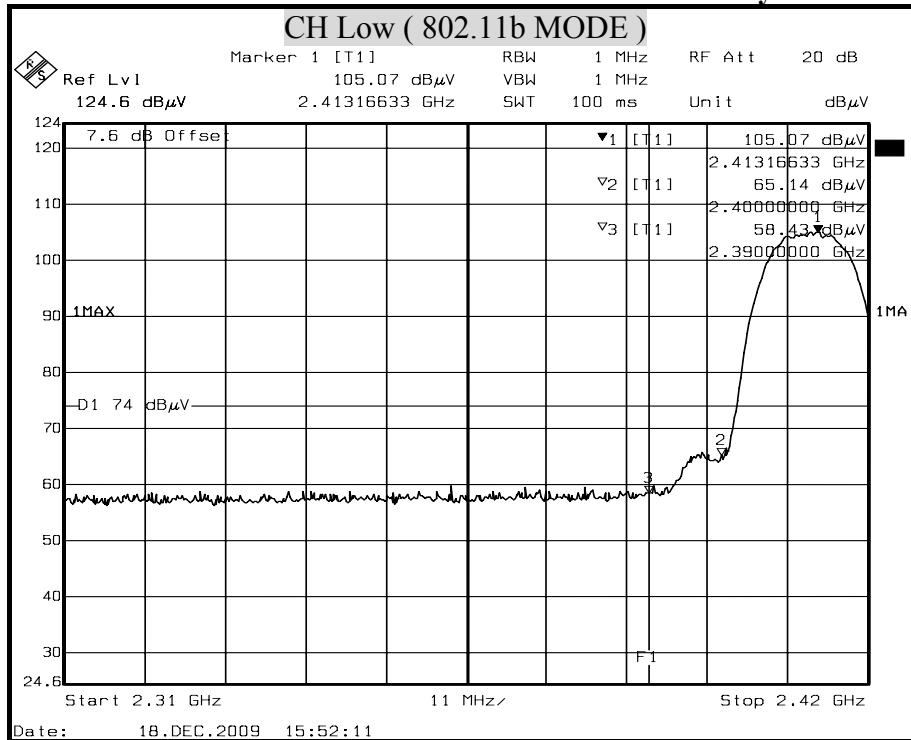

Detector mode : Average

Polarity : Vertical

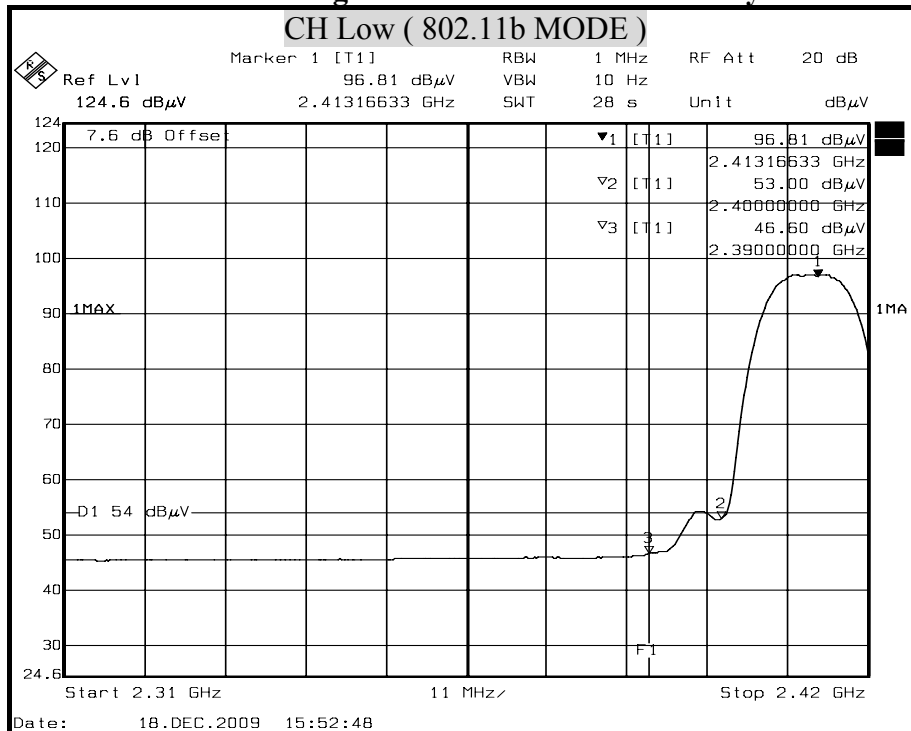

Remark:

1. Display Line = 54/74 dB μ V/m.
2. 2390MHz Offset(dB) = Antenna Factor(dB/m) + Cable Loss(dB) - Pre-Amplifier(dB) + Attenuator(dB)=7.6(dB)
3. 2483.5MHz Offset(dB) = Antenna Factor(dB/m) + Cable Loss(dB) - Pre-Amplifier(dB) + Attenuator(dB)=7.62(dB)



Detector mode : Peak Polarity : Horizontal

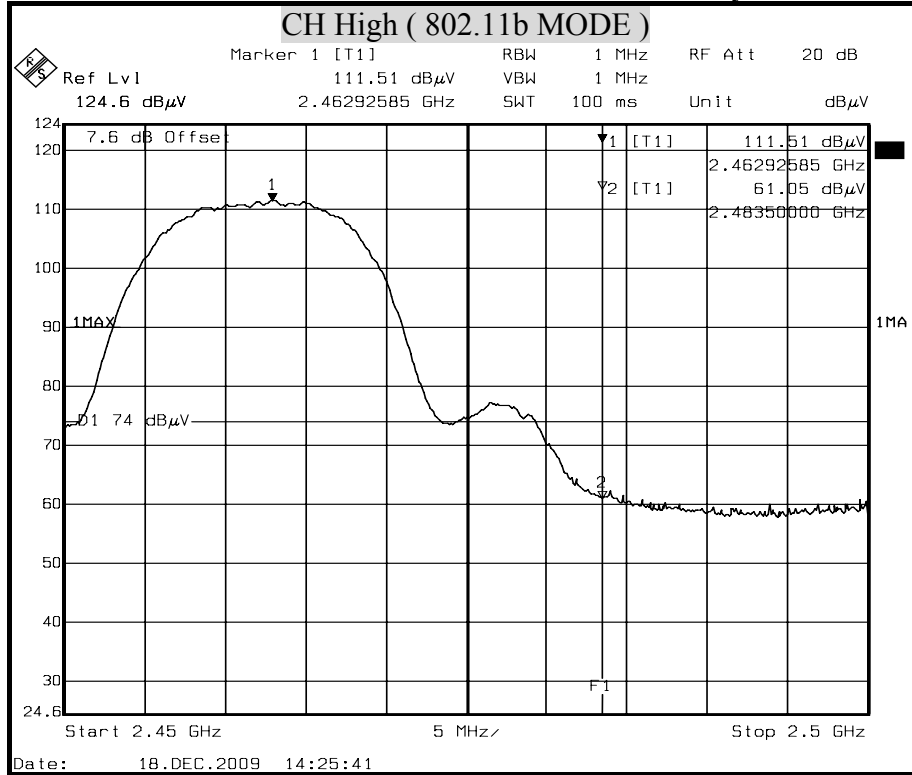

Detector mode : Average Polarity : Horizontal

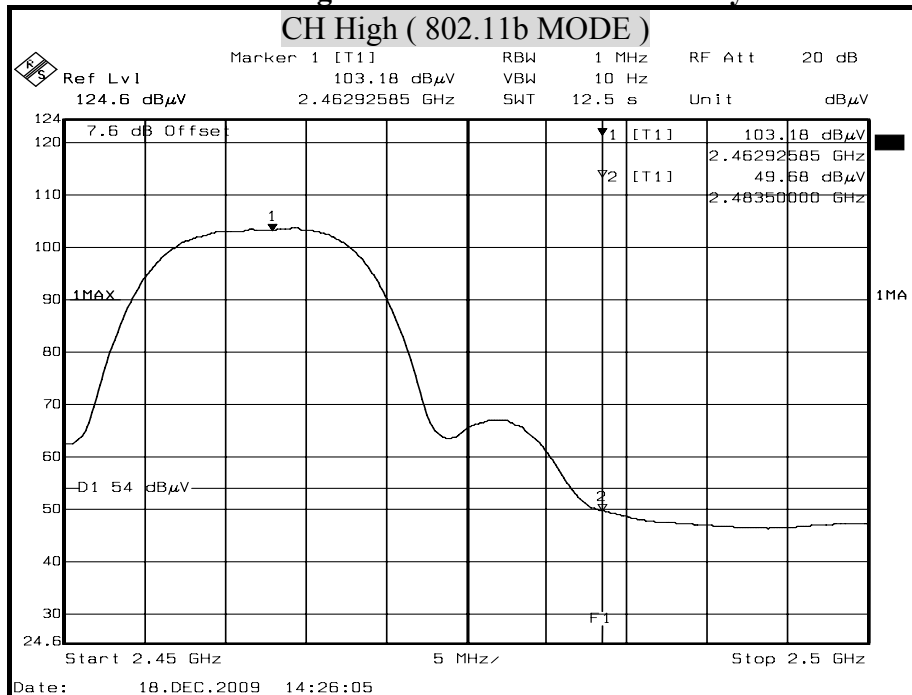

Remark:

1. Display Line = 54/74 dB μ V/m.
2. 2390MHz Offset(dB) = Antenna Factor(dB/m) + Cable Loss(dB) - Pre-Amplifier(dB) + Attenuator(dB)=7.6(dB)
3. 2483.5MHz Offset(dB) = Antenna Factor(dB/m) + Cable Loss(dB) - Pre-Amplifier(dB) + Attenuator(dB)=7.62(dB)



Detector mode : Peak Polarity : Vertical

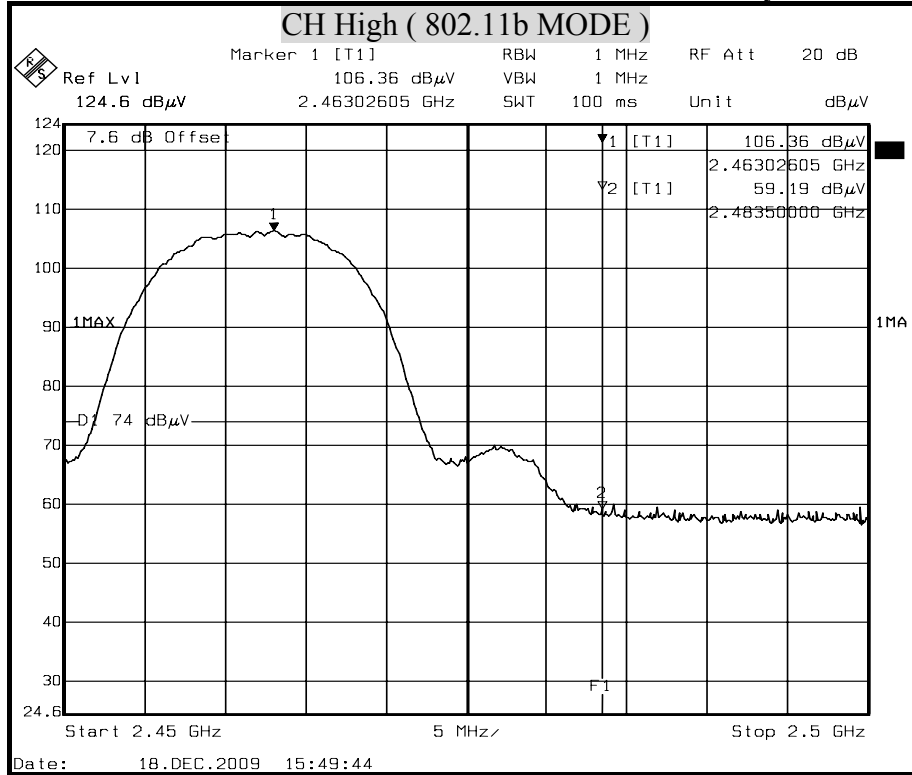

Detector mode : Average Polarity : Vertical

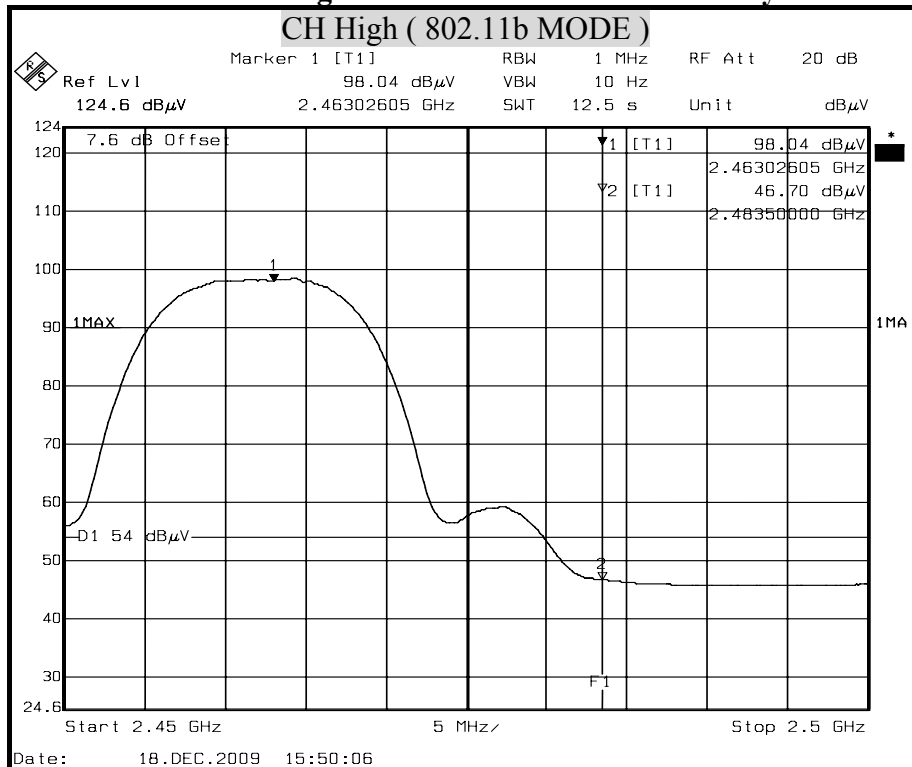

Remark:

1. Display Line = 54/74 dB μ V/m.
2. 2390MHz Offset(dB) = Antenna Factor(dB/m) + Cable Loss(dB) - Pre-Amplifier(dB) + Attenuator(dB)=7.6(dB)
3. 2483.5MHz Offset(dB) = Antenna Factor(dB/m) + Cable Loss(dB) - Pre-Amplifier(dB) + Attenuator(dB)=7.62(dB)



Detector mode : Peak **Polarity : Horizontal**

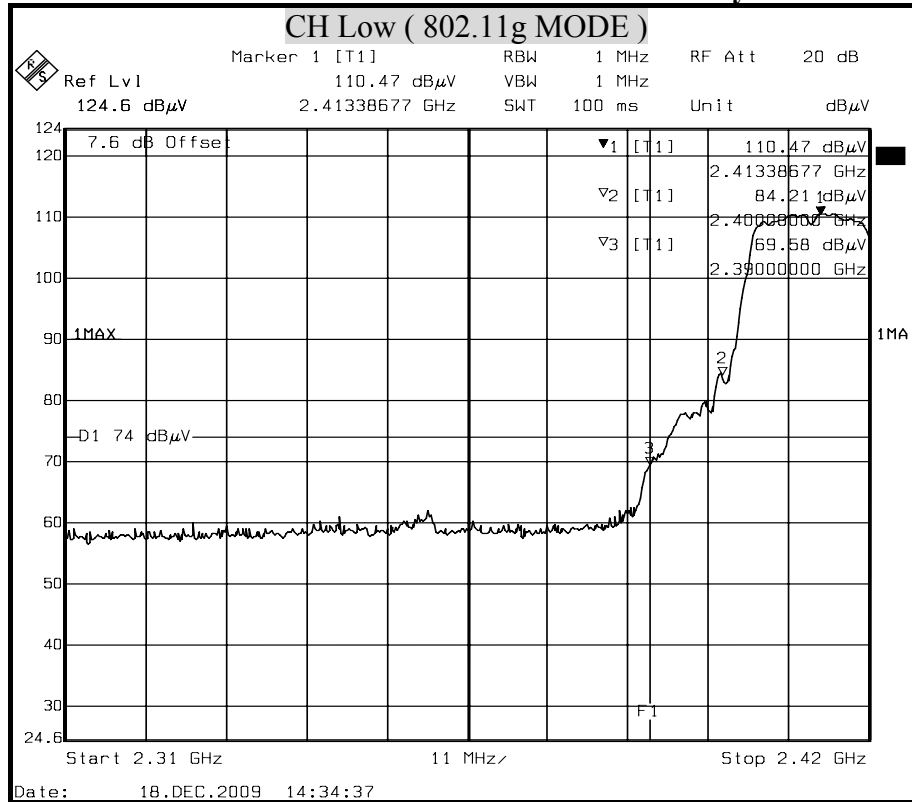

Detector mode : Average **Polarity : Horizontal**

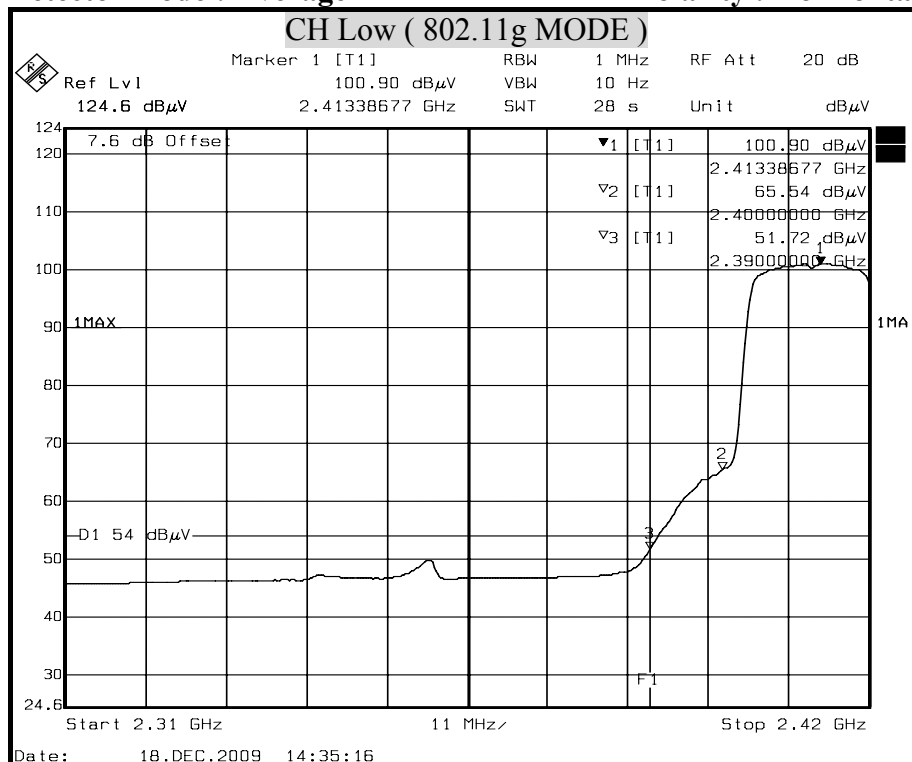

Remark:

1. Display Line = 54/74 dB μ V/m.
2. 2390MHz Offset(dB) = Antenna Factor(dB/m) + Cable Loss(dB) - Pre-Amplifier(dB) + Attenuator(dB)=7.6(dB)
3. 2483.5MHz Offset(dB) = Antenna Factor(dB/m) + Cable Loss(dB) - Pre-Amplifier(dB) + Attenuator(dB)=7.62(dB)



Detector mode : Peak Polarity : Vertical

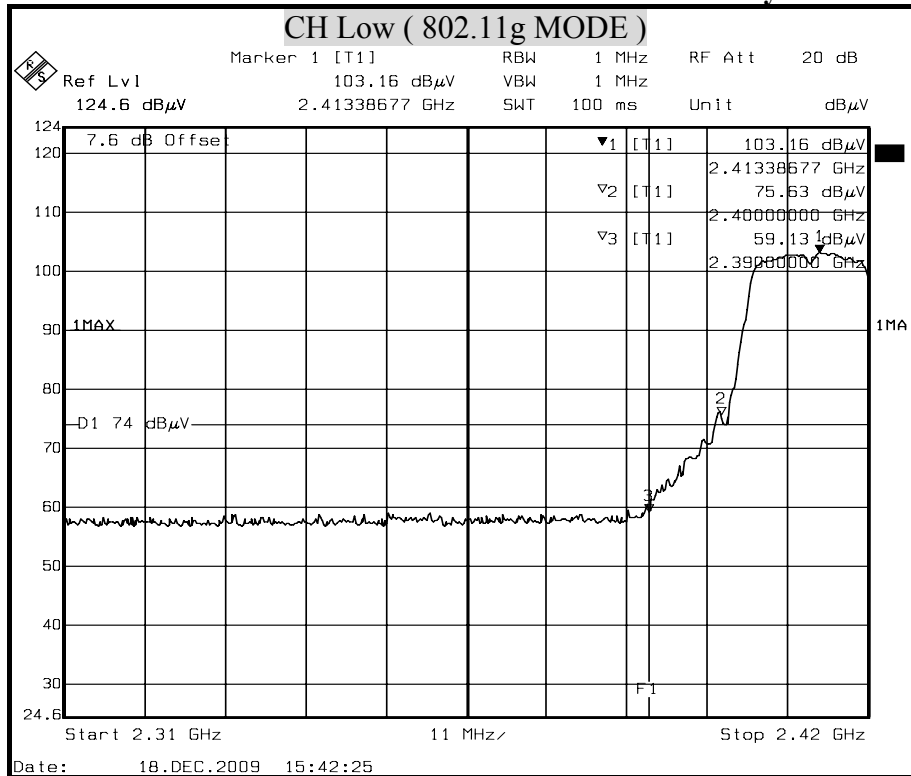

Detector mode : Average Polarity : Vertical

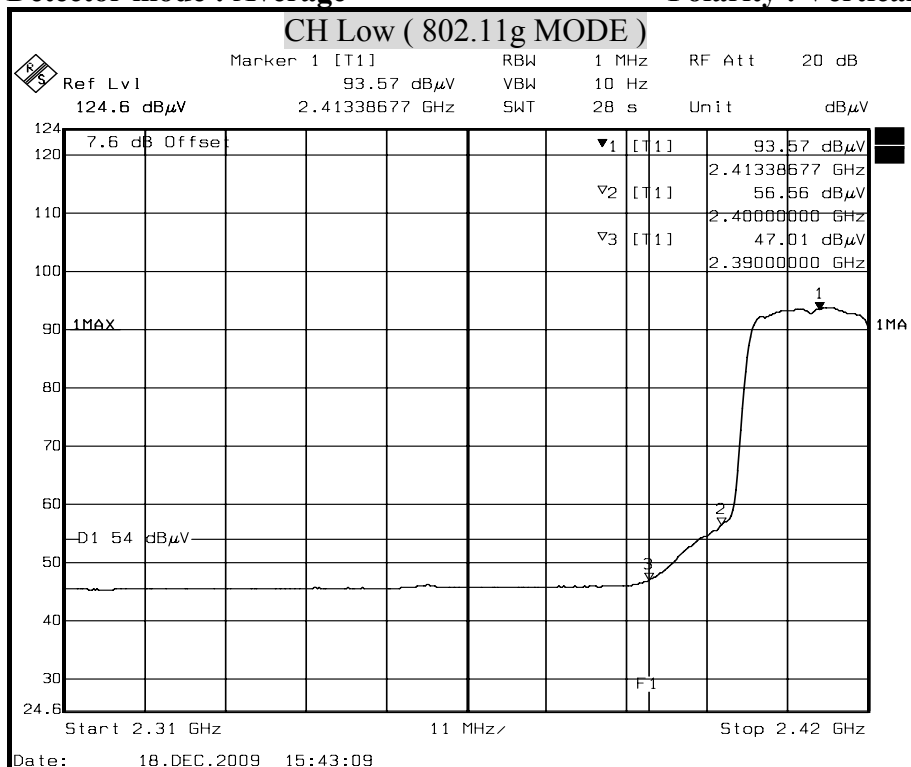

Remark:

1. Display Line = 54/74 dB μ V/m.
2. 2390MHz Offset(dB) = Antenna Factor(dB/m) + Cable Loss(dB) - Pre-Amplifier(dB) + Attenuator(dB)=7.6(dB)
3. 2483.5MHz Offset(dB) = Antenna Factor(dB/m) + Cable Loss(dB) - Pre-Amplifier(dB) + Attenuator(dB)=7.62(dB)



Detector mode : Peak Polarity : Horizontal

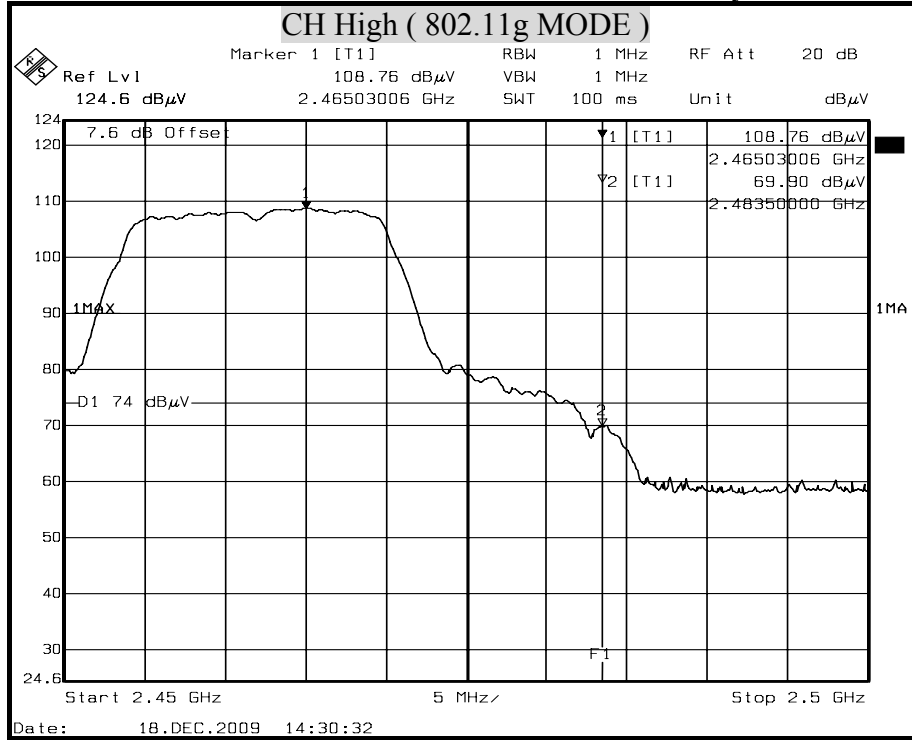

Detector mode : Average Polarity : Horizontal

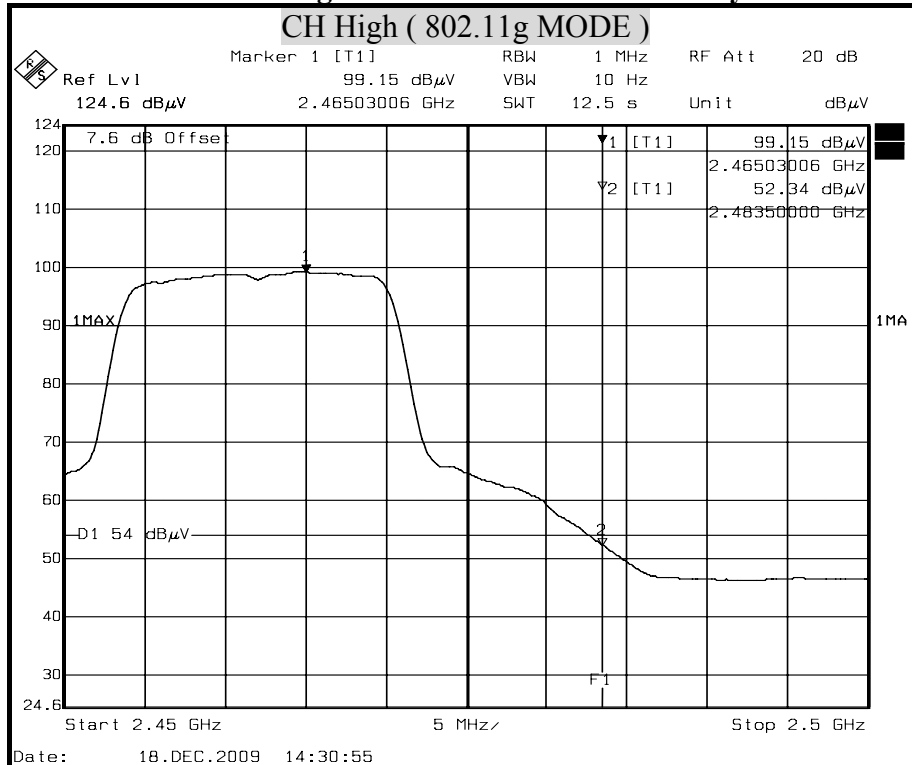

Remark:

1. Display Line = 54/74 dB μ V/m.
2. 2390MHz Offset(dB) = Antenna Factor(dB/m) + Cable Loss(dB) - Pre-Amplifier(dB) + Attenuator(dB)=7.6(dB)
3. 2483.5MHz Offset(dB) = Antenna Factor(dB/m) + Cable Loss(dB) - Pre-Amplifier(dB) + Attenuator(dB)=7.62(dB)



Detector mode : Peak Polarity : Vertical

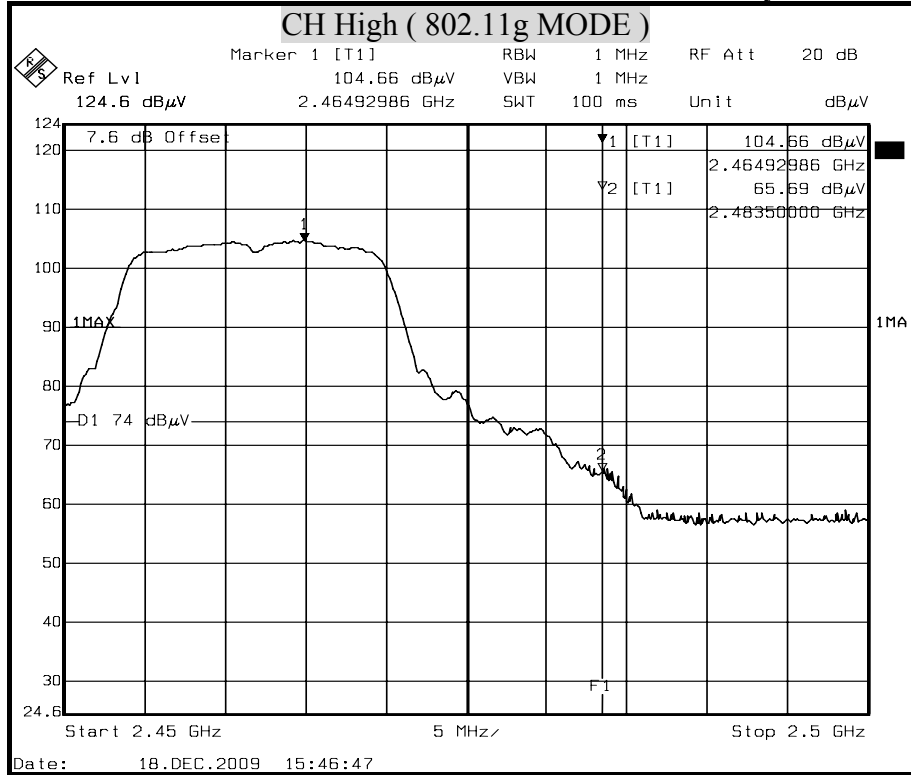

Detector mode : Average Polarity : Vertical

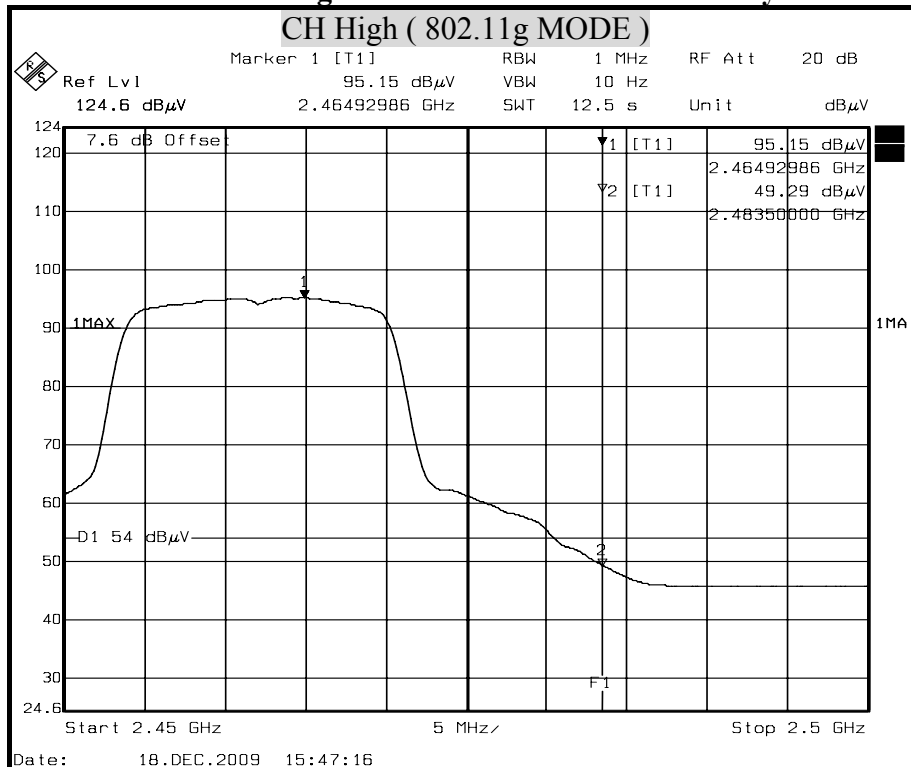

Remark:

1. Display Line = 54/74 dB μ V/m.
2. 2390MHz Offset(dB) = Antenna Factor(dB/m) + Cable Loss(dB) - Pre-Amplifier(dB) + Attenuator(dB)=7.6(dB)
3. 2483.5MHz Offset(dB) = Antenna Factor(dB/m) + Cable Loss(dB) - Pre-Amplifier(dB) + Attenuator(dB)=7.62(dB)



Detector mode : Peak Polarity : Horizontal

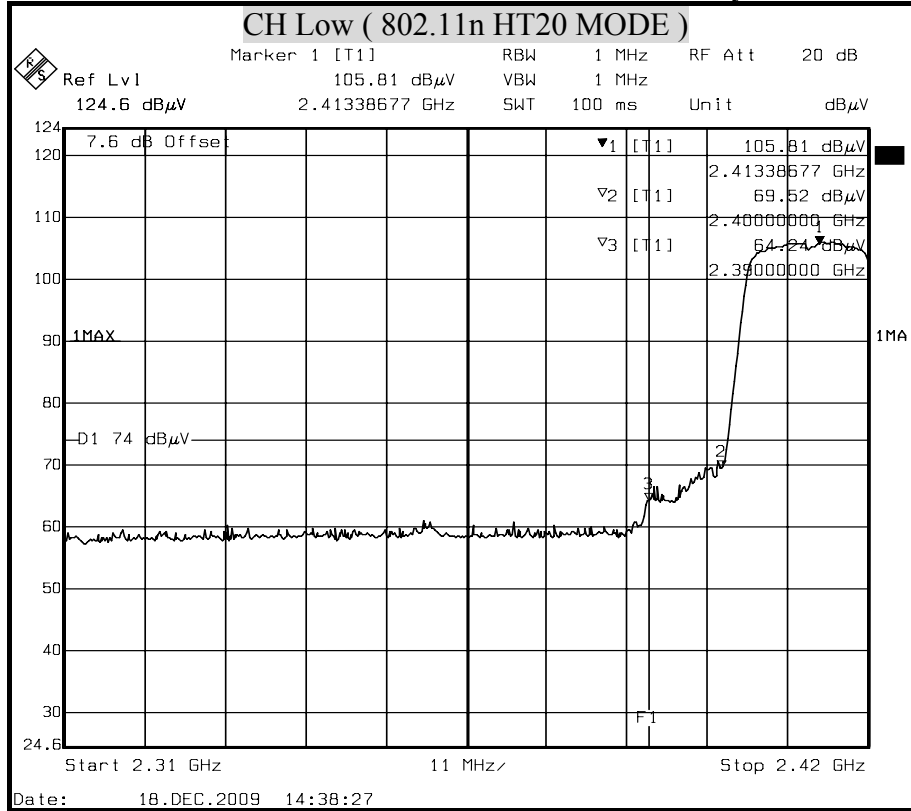

Detector mode : Average Polarity : Horizontal

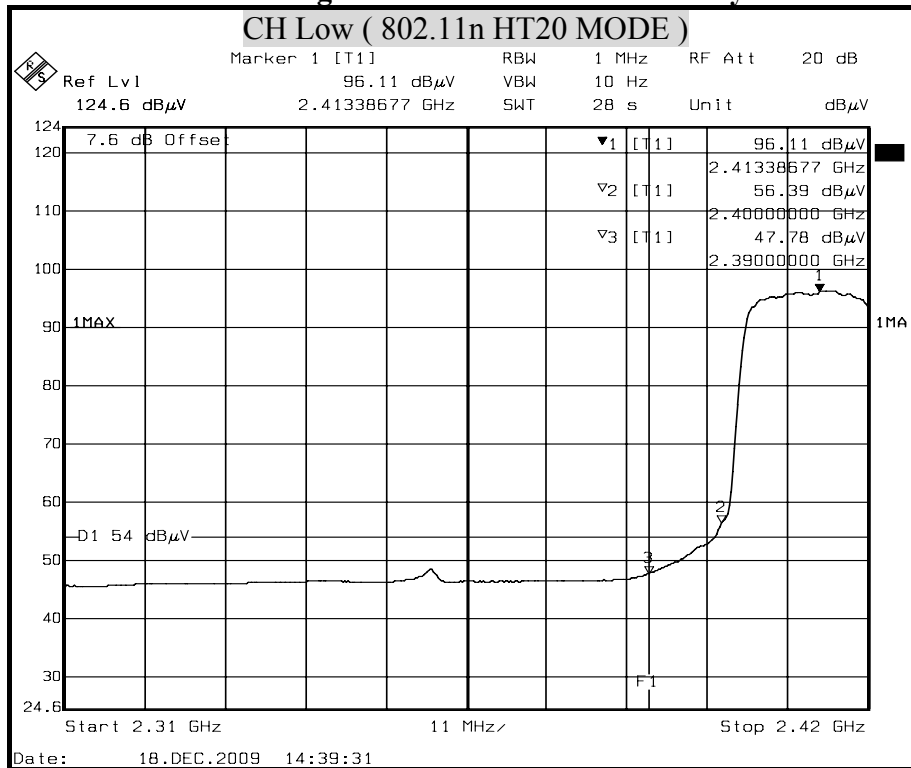

Remark:

1. Display Line = 54/74 dB µ V/m.
2. 2390MHz Offset(dB) = Antenna Factor(dB/m) + Cable Loss(dB) - Pre-Amplifier(dB) + Attenuator(dB)=7.6(dB)
3. 2483.5MHz Offset(dB) = Antenna Factor(dB/m) + Cable Loss(dB) - Pre-Amplifier(dB) + Attenuator(dB)=7.62(dB)



Detector mode : Peak Polarity : Vertical

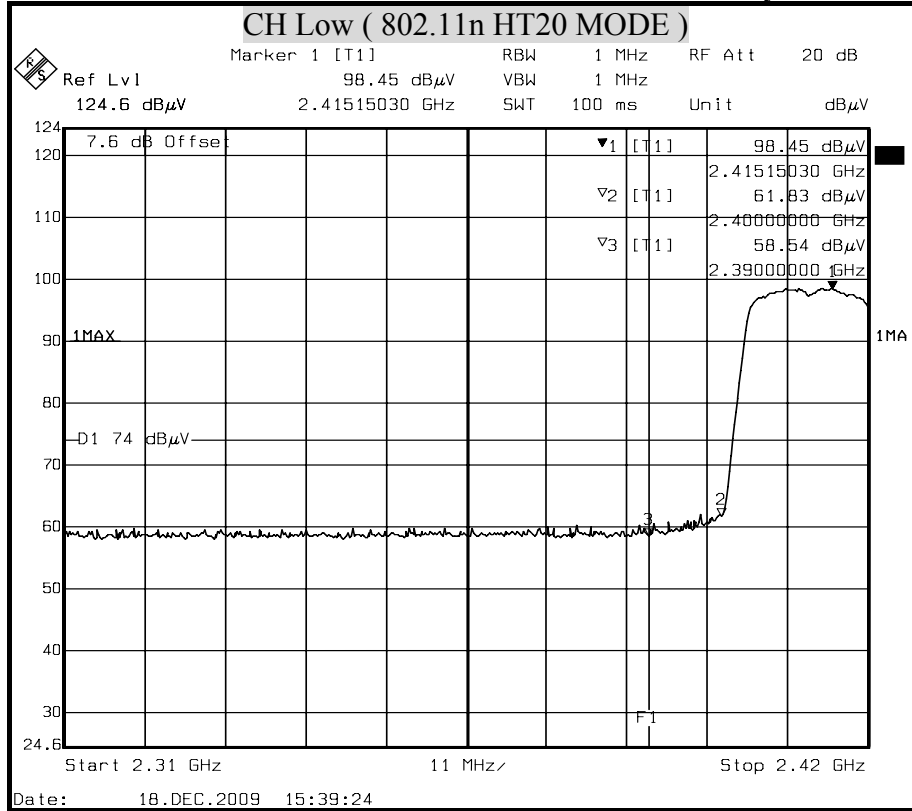

Detector mode : Average Polarity : Vertical

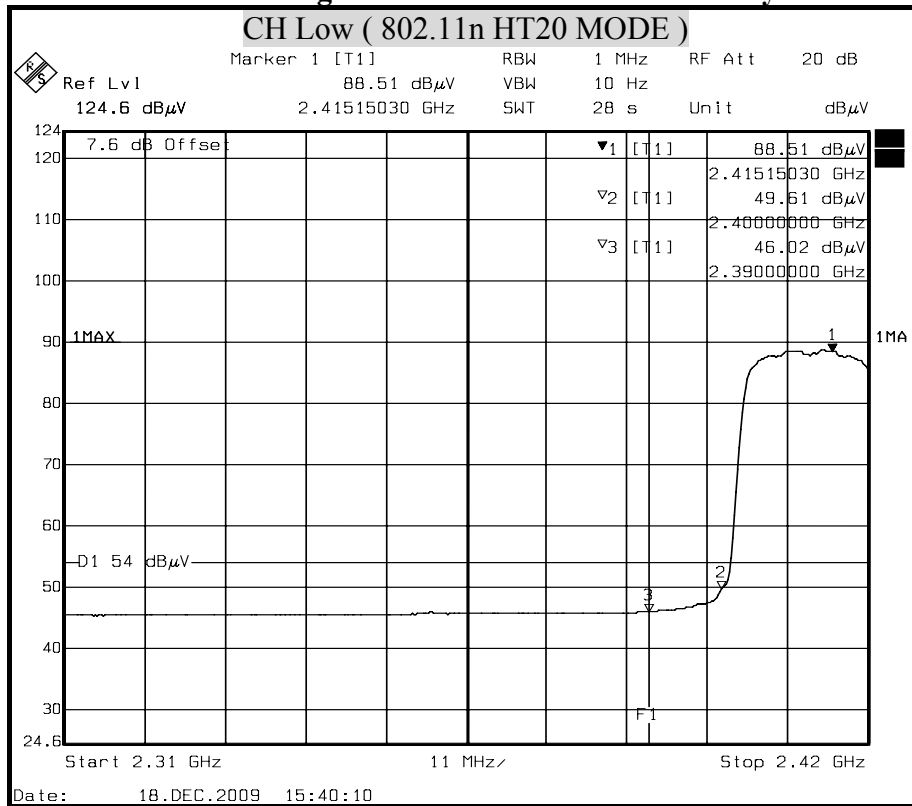

Remark:

1. Display Line = 54/74 dB µ V/m.
2. 2390MHz Offset(dB) = Antenna Factor(dB/m) + Cable Loss(dB) - Pre-Amplifier(dB) + Attenuator(dB)=7.6(dB)
3. 2483.5MHz Offset(dB) = Antenna Factor(dB/m) + Cable Loss(dB) - Pre-Amplifier(dB) + Attenuator(dB)=7.62(dB)



Detector mode : Peak Polarity : Horizontal

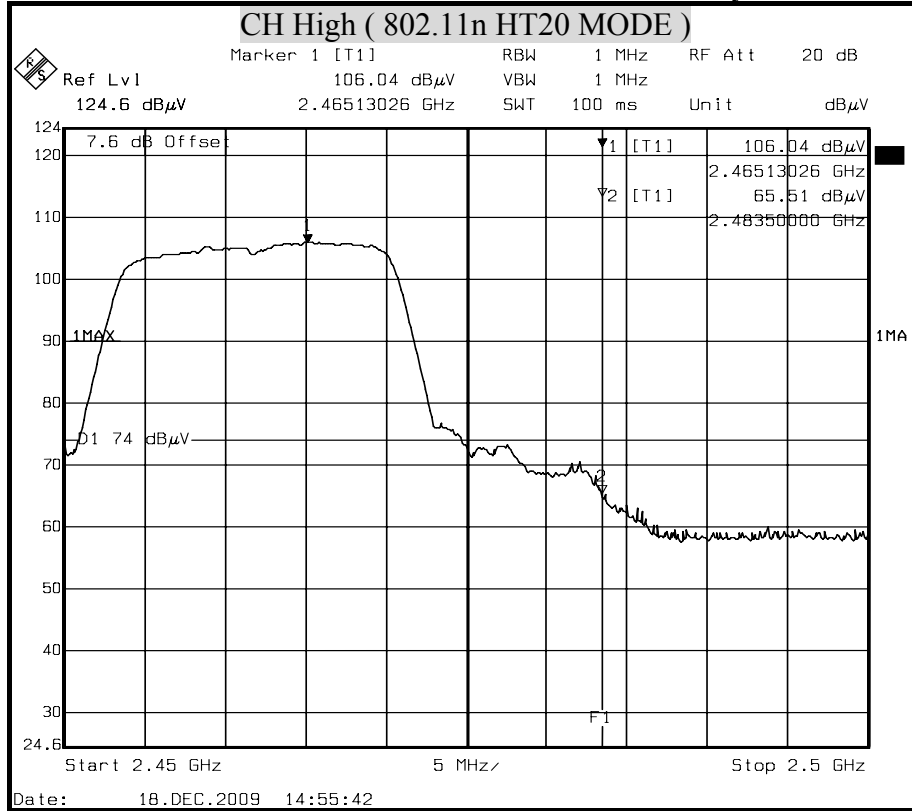

Detector mode : Average Polarity : Horizontal

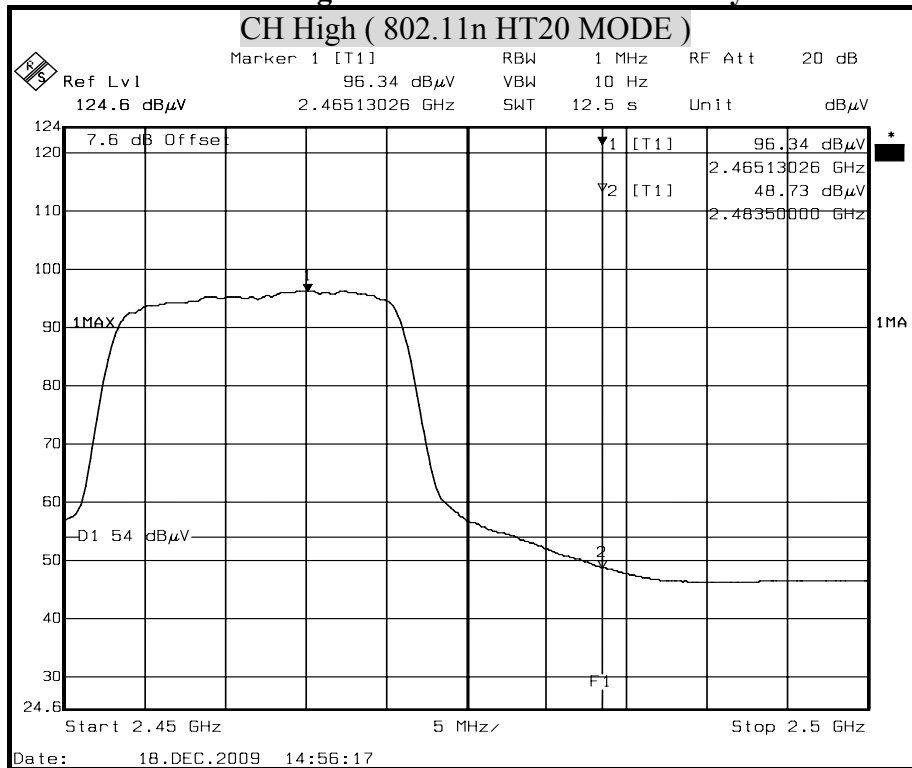

Remark:

1. Display Line = 54/74 dB μ V/m.
2. 2390MHz Offset(dB) = Antenna Factor(dB/m) + Cable Loss(dB) - Pre-Amplifier(dB) + Attenuator(dB)=7.6(dB)
3. 2483.5MHz Offset(dB) = Antenna Factor(dB/m) + Cable Loss(dB) - Pre-Amplifier(dB) + Attenuator(dB)=7.62(dB)



Detector mode : Peak Polarity : Vertical

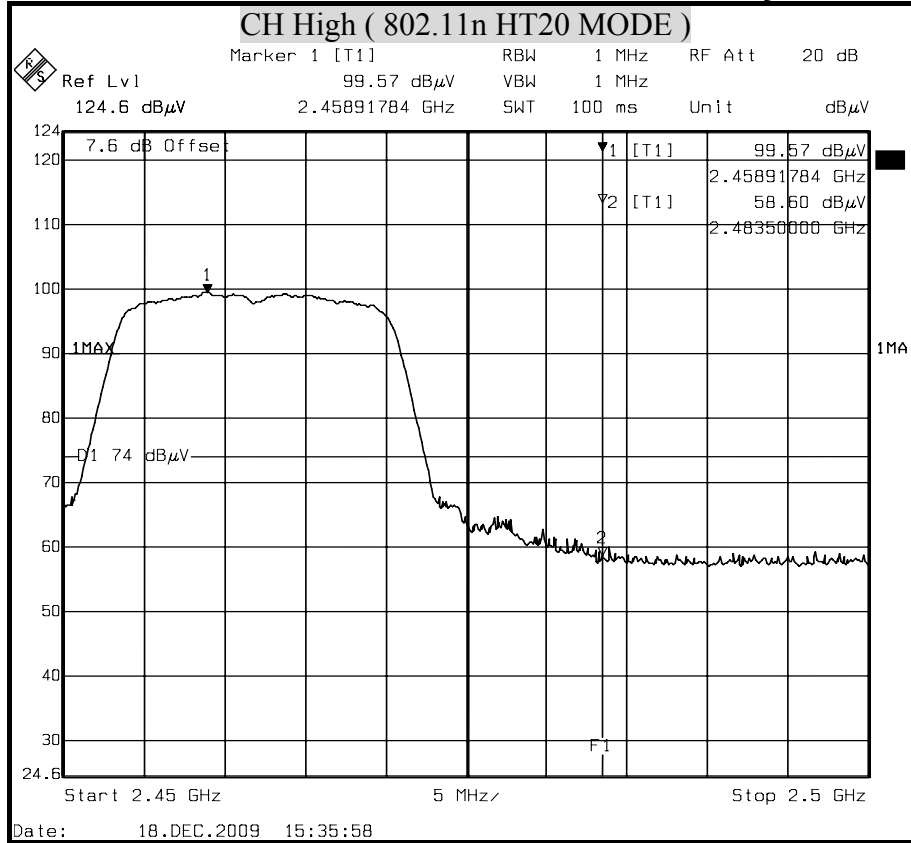

Detector mode : Average Polarity : Vertical

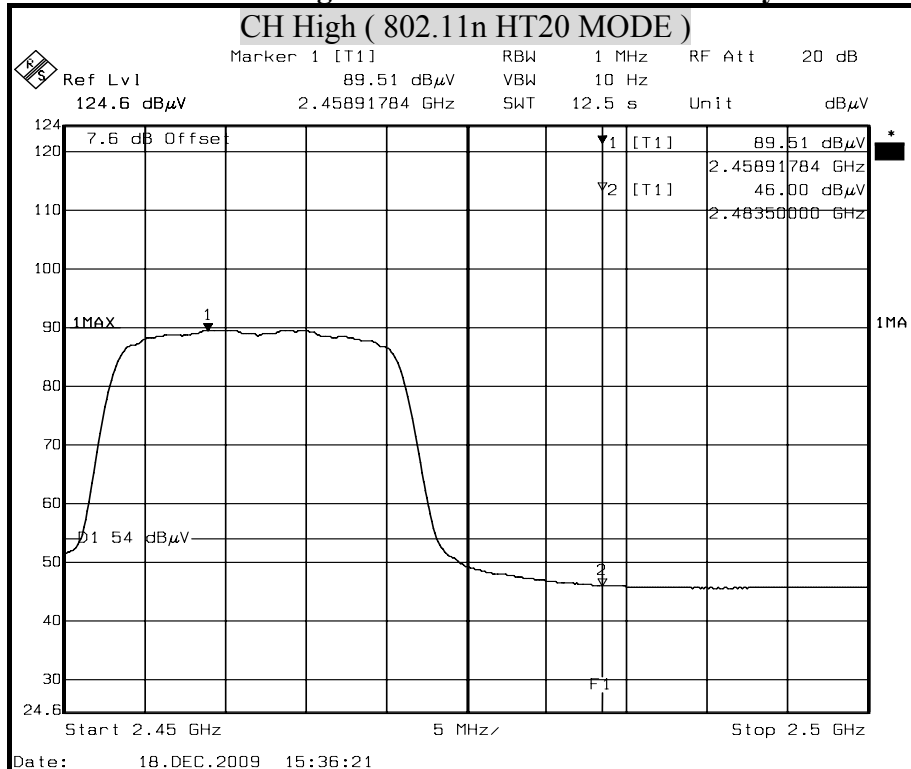

Remark:

1. Display Line = 54/74 dB μ V/m.
2. 2390MHz Offset(dB) = Antenna Factor(dB/m) + Cable Loss(dB) - Pre-Amplifier(dB) + Attenuator(dB)=7.6(dB)
3. 2483.5MHz Offset(dB) = Antenna Factor(dB/m) + Cable Loss(dB) - Pre-Amplifier(dB) + Attenuator(dB)=7.62(dB)



Detector mode : Peak Polarity : Horizontal

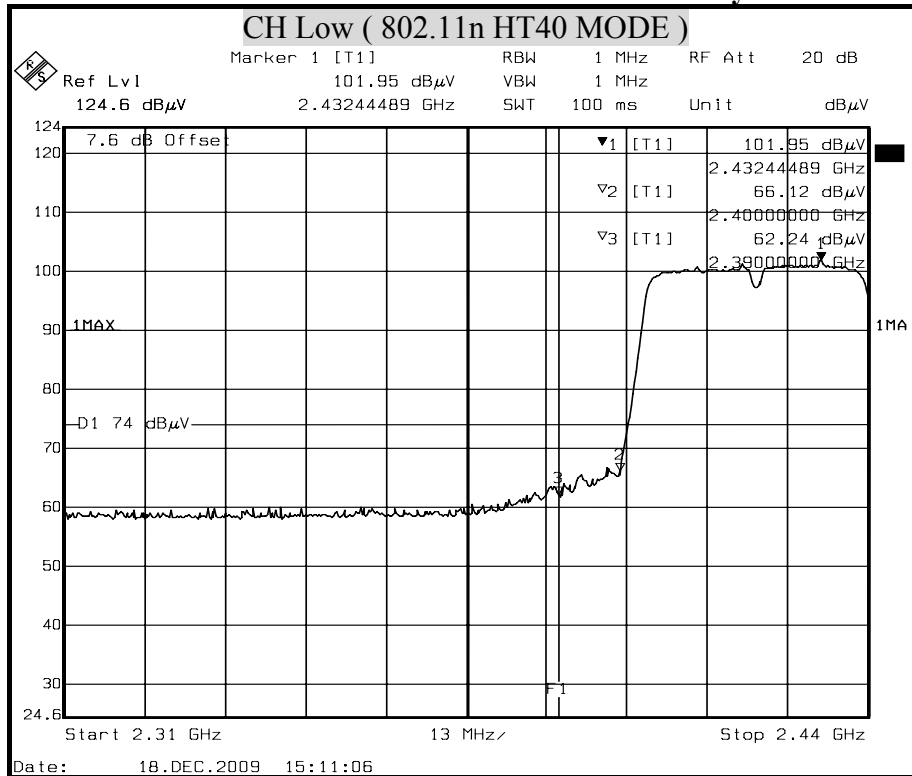

Detector mode : Average Polarity : Horizontal

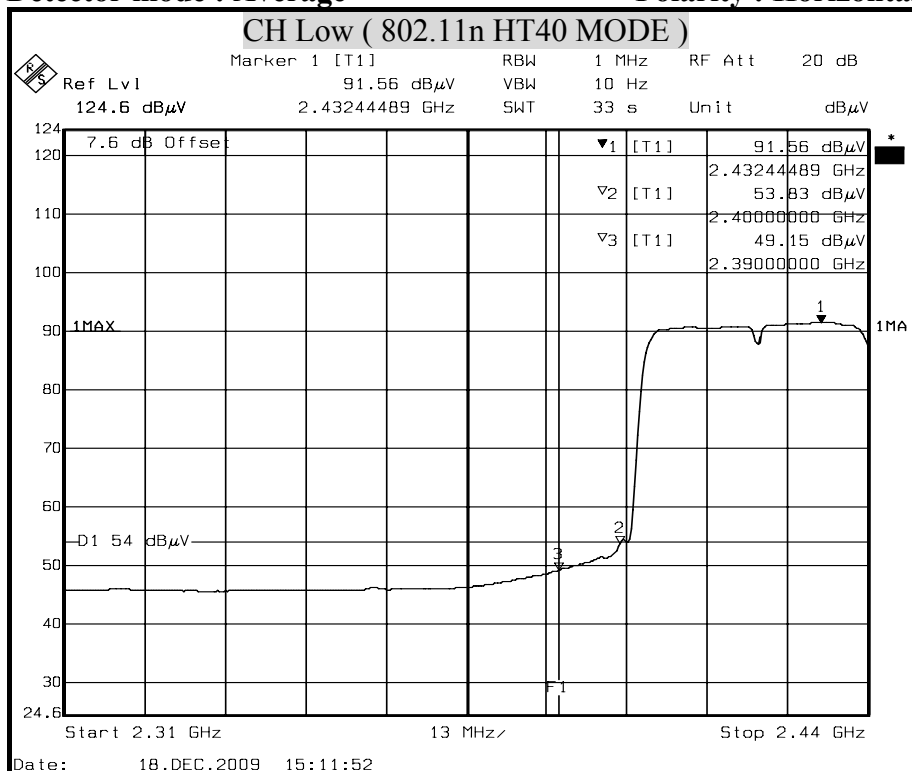

Remark:

1. Display Line = 54/74 dB μ V/m.
2. 2390MHz Offset(dB) = Antenna Factor(dB/m) + Cable Loss(dB) - Pre-Amplifier(dB) + Attenuator(dB)=7.6(dB)
3. 2483.5MHz Offset(dB) = Antenna Factor(dB/m) + Cable Loss(dB) - Pre-Amplifier(dB) + Attenuator(dB)=7.62(dB)



Detector mode : Peak Polarity : Vertical

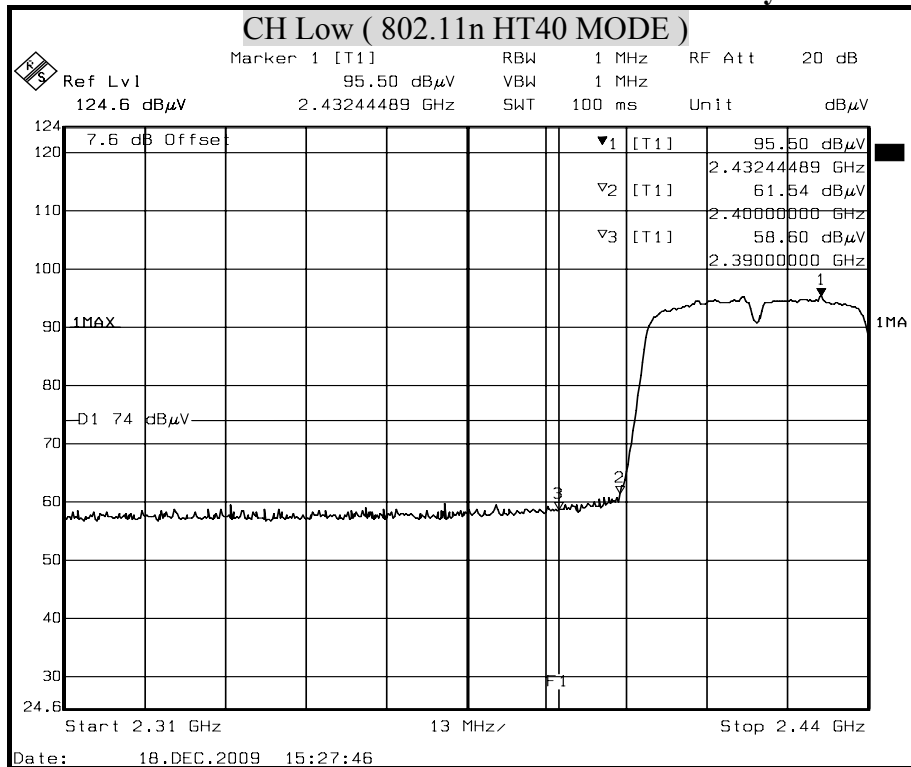

Detector mode : Average Polarity : Vertical

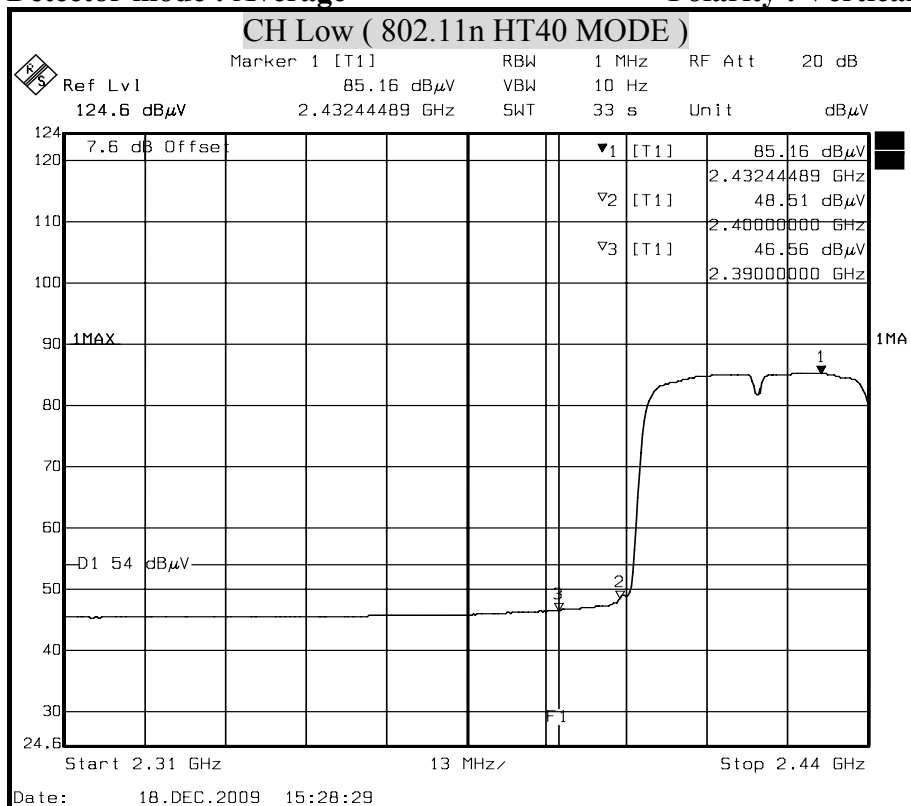

Remark:

1. Display Line = 54/74 dB μ V/m.
2. 2390MHz Offset(dB) = Antenna Factor(dB/m) + Cable Loss(dB) - Pre-Amplifier(dB) + Attenuator(dB)=7.6(dB)
3. 2483.5MHz Offset(dB) = Antenna Factor(dB/m) + Cable Loss(dB) - Pre-Amplifier(dB) + Attenuator(dB)=7.62(dB)



Detector mode : Peak Polarity : Horizontal

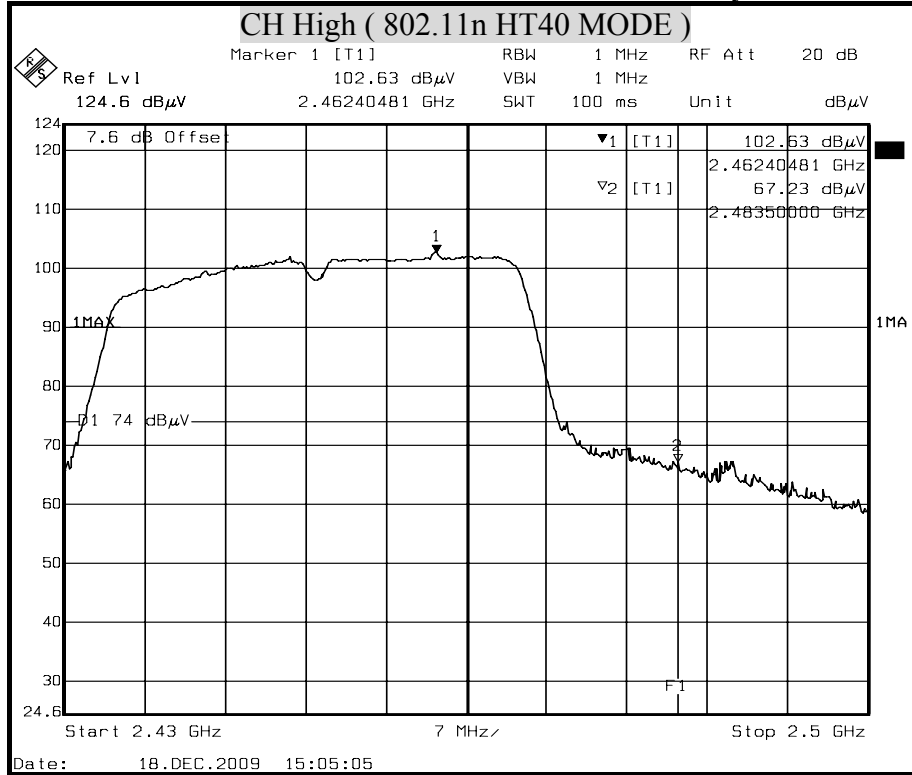

Detector mode : Average Polarity : Horizontal

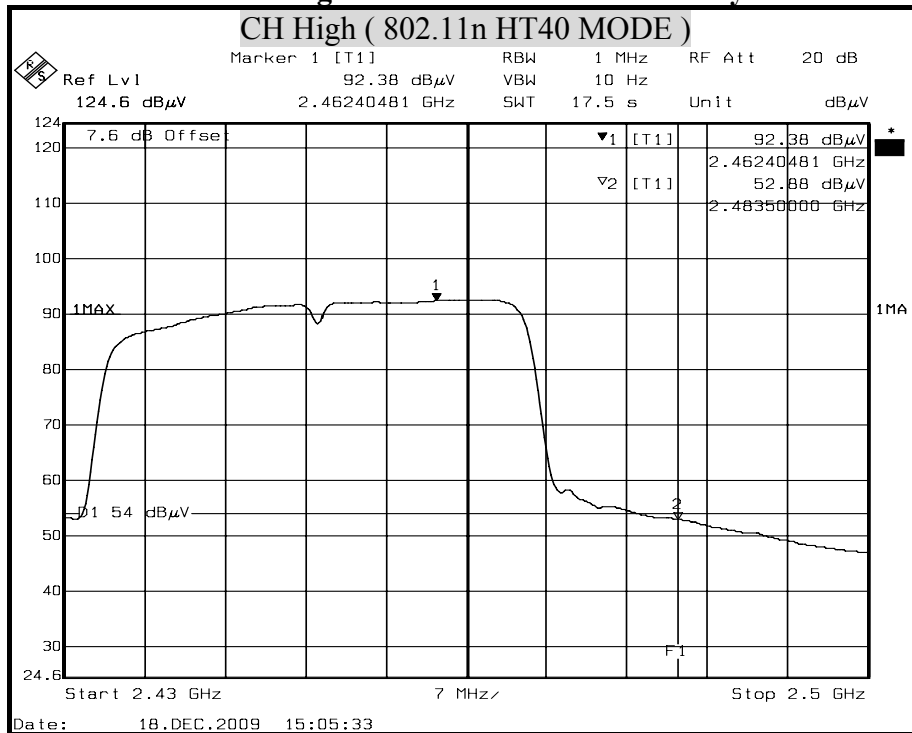

Remark:

1. Display Line = 54/74 dB μ V/m.
2. 2390MHz Offset(dB) = Antenna Factor(dB/m) + Cable Loss(dB) - Pre-Amplifier(dB) + Attenuator(dB)=7.6(dB)
3. 2483.5MHz Offset(dB) = Antenna Factor(dB/m) + Cable Loss(dB) - Pre-Amplifier(dB) + Attenuator(dB)=7.62(dB)



Detector mode : Peak Polarity : Vertical

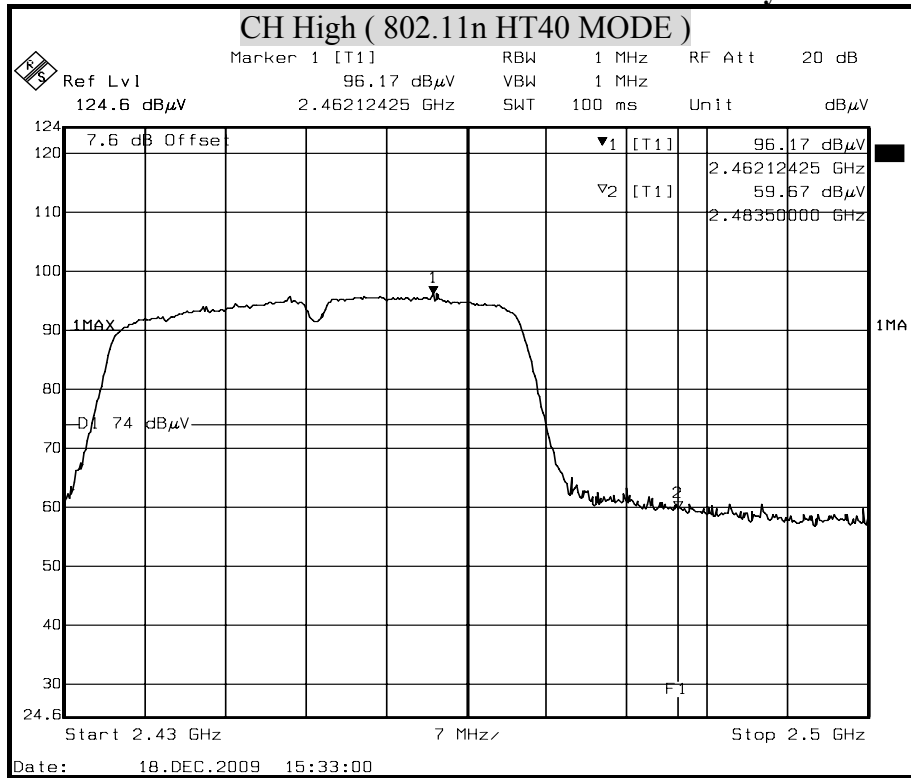

Detector mode : Average Polarity : Vertical

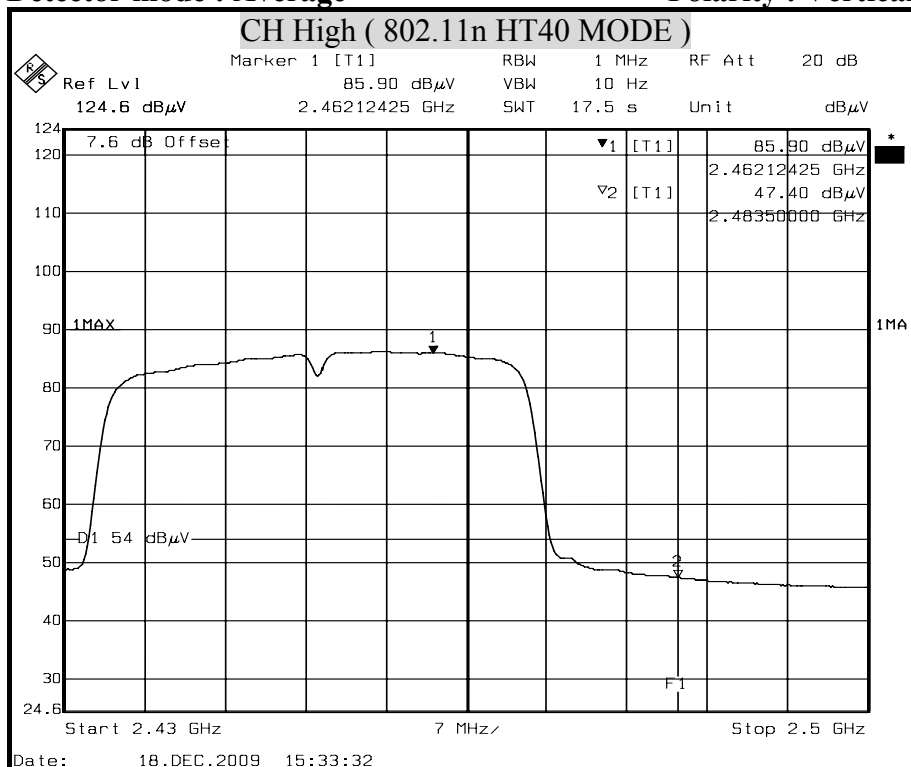

Remark:

1. Display Line = 54/74 dB μ V/m.
2. 2390MHz Offset(dB) = Antenna Factor(dB/m) + Cable Loss(dB) - Pre-Amplifier(dB) + Attenuator(dB)=7.6(dB)
3. 2483.5MHz Offset(dB) = Antenna Factor(dB/m) + Cable Loss(dB) - Pre-Amplifier(dB) + Attenuator(dB)=7.62(dB)



8.7 POWERLINE CONDUCTED EMISSIONS

LIMITS

§ 15.207 (a) Except as shown in paragraph (b) and (c) this section, for an intentional radiator that is designed to be connected to the public utility (AC) power line, the radio frequency voltage that is conducted back onto the AC power line on any frequency or frequencies within the band 150 kHz to 30 MHz shall not exceed the limits in the following table, as measured using a 50 μ H/50 ohms line impedance stabilization network (LISN). Compliance with the provisions of this paragraph shall be based on the measurement of the radio frequency voltage between each power line and ground at the power terminal.

The lower limit applies at the boundary between the frequency ranges.

Frequency of Emission (MHz)	Conducted limit (dB μ v)	
	Quasi-peak	Average
0.15 - 0.5	66 to 56	56 to 46
0.5 - 5	56	46
5 - 30	60	50

TEST EQUIPMENTS

The following test equipments are used during the conducted power line tests:

Conducted Emission room				
Name of Equipment	Manufacturer	Model	Serial Number	Calibration Due
L.I.S.N.	SCHWARZBECK	NNLK 8121	8121-446	NOV. 19, 2010 For Insertion loss
	Rohde & Schwarz	ESH 3-Z5	840062/021	NOV. 29, 2010
TEST RECEIVER	Rohde & Schwarz	ESCS 30	100348	JUL. 16, 2010
TYPE N COAXIAL CABLE	CCS	BNC50	11	AUG. 26, 2010
Test S/W	e-3 (5.04211c) R&S (2.27)			

TEST SETUP

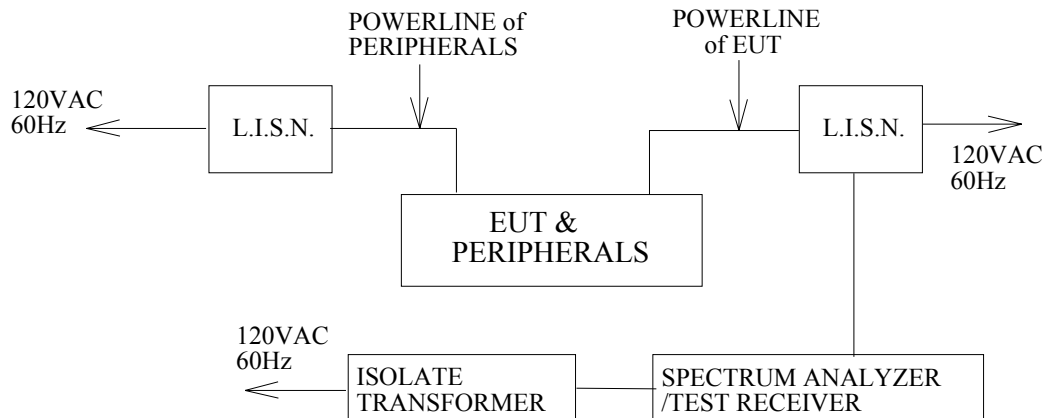

TEST PROCEDURE

The EUT is placed on a non-conducting table 40 cm from the vertical ground plane and 80cm above the horizontal ground plane. The EUT IS CONFIGURED IN ACCORDANCE WITH ANSI C63.4.

The resolution bandwidth is set to 9 kHz for both quasi-peak detection and average detection measurements.

Line conducted data is recorded for both NEUTRAL and LINE.

TEST RESULTS

No non-compliance noted.



CONDUCTED RF VOLTAGE MEASUREMENT

Model No.	MAA502AM	Resolution Bandwidth	9 kHz
Environmental Conditions	28 °C, 50 % RH	Test Mode	Normal (USB+LAN+WIFI)
Tested by	Shiang Su	Adapter Brand(model)	AMIGO(AMS3-1201500FU)

LINE

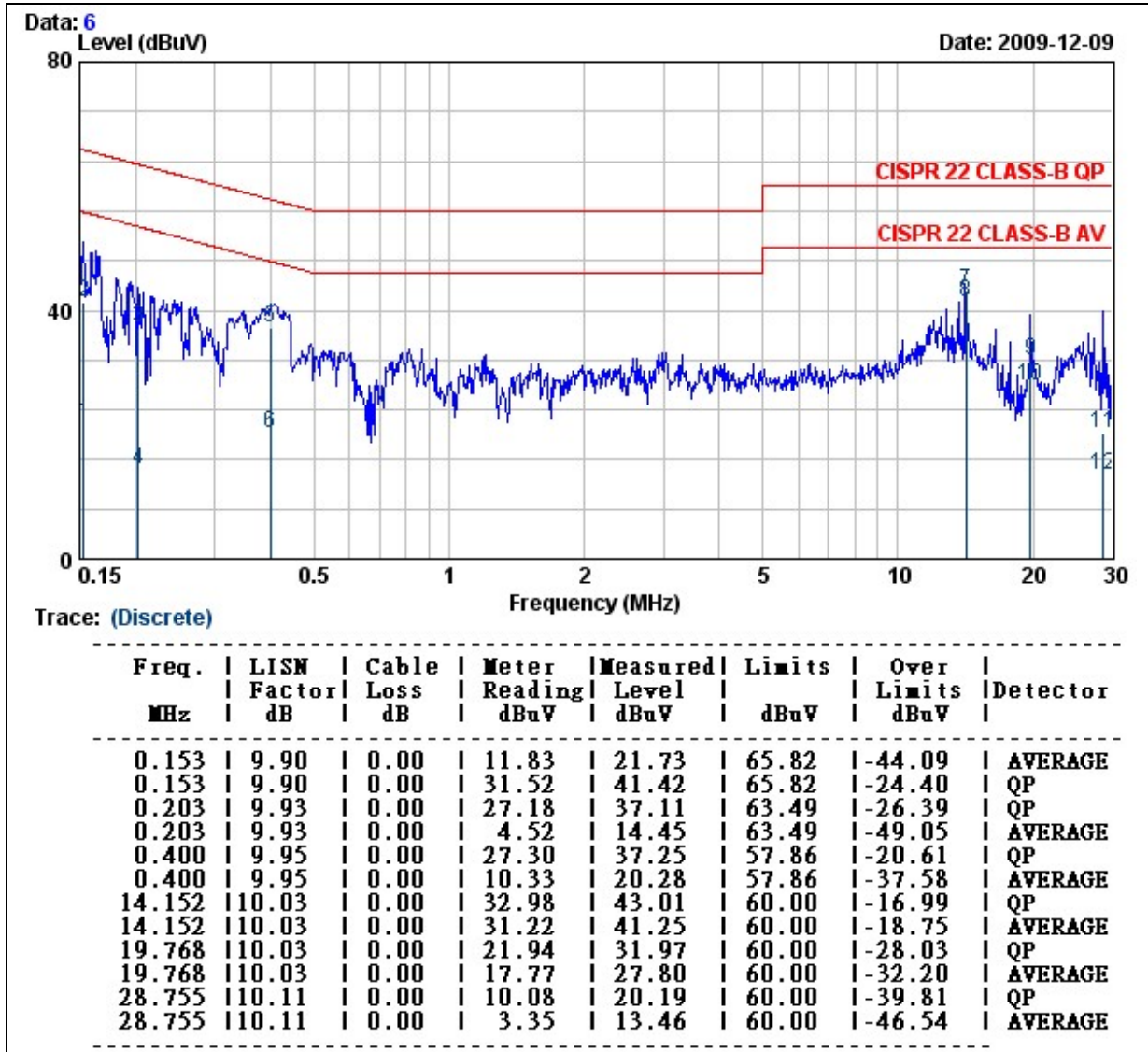

- REMARKS :**
1. Level (dBUV) = Read Level (dBUV) + LISN Factor (dB) + Cable Loss (dB)
 2. Over Limit value (dB) = Level (dBUV) – Limit Line (dBUV)



Model No.	MAA502AM	Resolution Bandwidth	9 kHz
Environmental Conditions	28 °C, 50 % RH	Test Mode	Normal (USB+LAN+WIFI)
Tested by	Shiang Su	Adapter Brand(model)	AMIGO(AMS3-1201500FU)

NEUTRAL

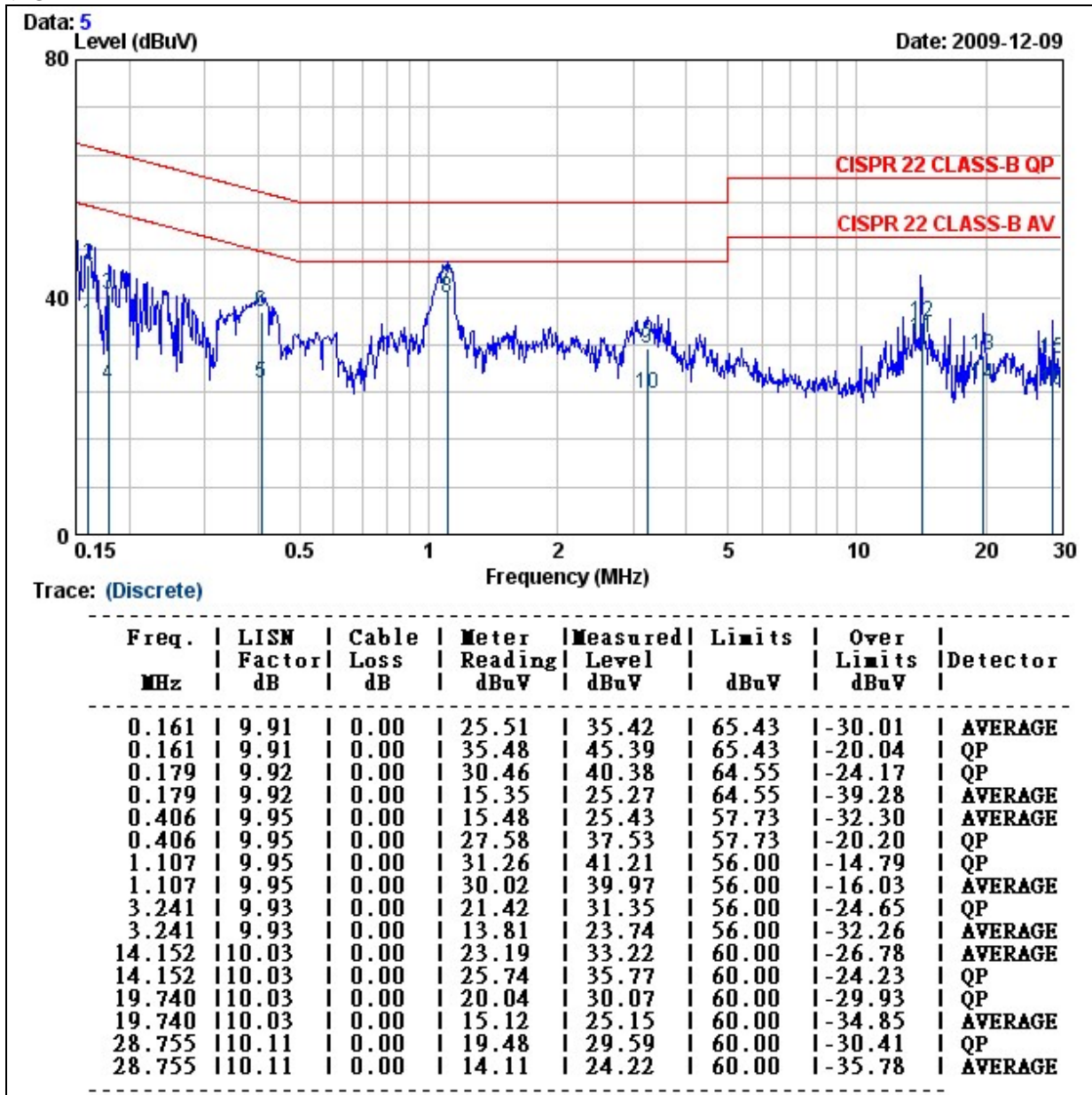

REMARKS : 1. Level (dBUV) = Read Level (dBUV) + LISN Factor (dB) + Cable Loss (dB)
 2. Over Limit value (dB) = Level (dBUV) – Limit Line (dBUV)



Model No.	MAA502AM	Resolution Bandwidth	9 kHz
Environmental Conditions	28 °C, 50 % RH	Test Mode	Normal (USB+LAN+WIFI)
Tested by	Shiang Su	Adapter Brand(model)	PHIHONG (PSA18R-120P)

LINE

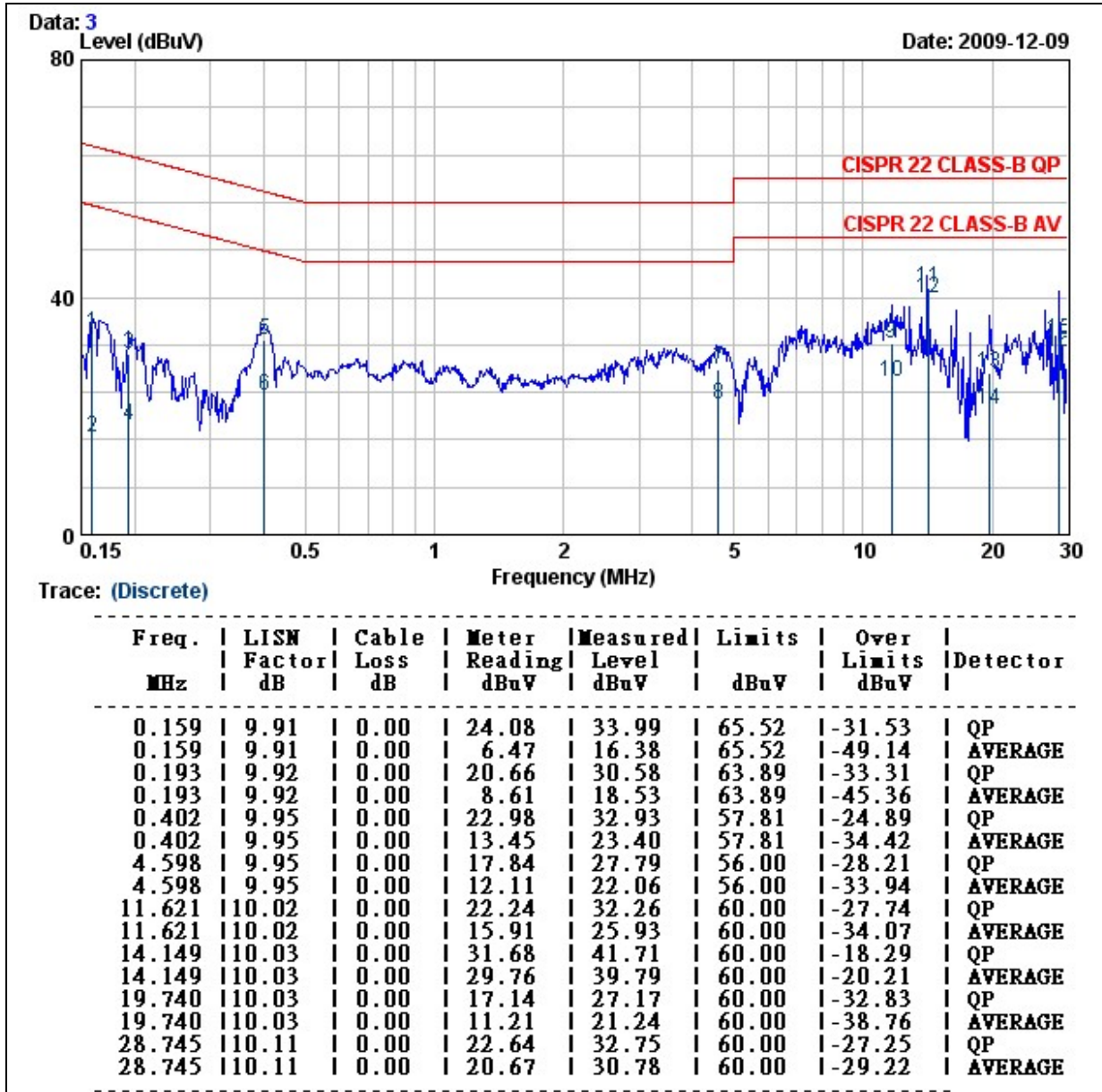

REMARKS : 1. Level (dBUV) = Read Level (dBUV) + LISN Factor (dB) + Cable Loss (dB)
 2. Over Limit value (dB) = Level (dBUV) – Limit Line (dBUV)



Model No.	MAA502AM	Resolution Bandwidth	9 kHz
Environmental Conditions	28 °C, 50 % RH	Test Mode	Normal (USB+LAN+WIFI)
Tested by	Shiang Su	Adapter Brand(model)	PHIHONG (PSA18R-120P)

NEUTRAL

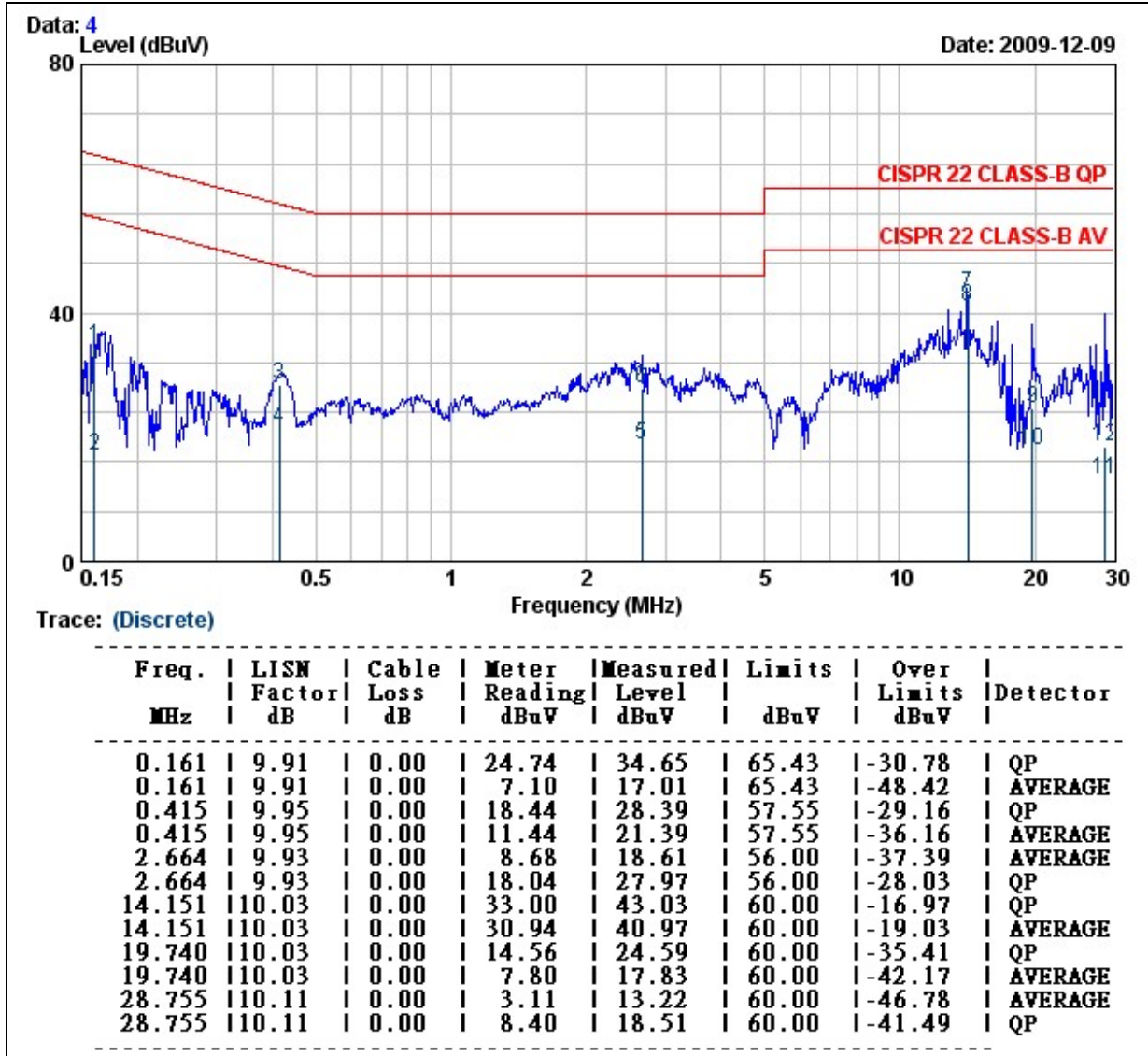

REMARKS : 1. Level (dBUV) = Read Level (dBUV) + LISN Factor (dB) + Cable Loss (dB)
 2. Over Limit value (dB) = Level (dBUV) – Limit Line (dBUV)



9. ANTENNA REQUIREMENT

9.1 STANDARD APPLICABLE

For intentional device, according to FCC 47 CFR Section 15.203, an intentional radiator shall be designed to ensure that no antenna other than that furnished by the responsible party shall be used with the device.

And according to FCC 47 CFR Section 15.247 (b), if transmitting antennas of directional gain greater than 6dBi are used, the power shall be reduced by the amount in dB that the directional gain of the antenna exceeds 6dBi.

9.2 ANTENNA CONNECTED CONSTRUCTION

The antenna spec:

PIFA Antenna 4.14dBi (Built-in PIFA antenna)

Manufacture: Wha Yu Group; Antenna model: SSR-92899