

Pacific Industrial Company, LTD.

TEST REPORT

SCOPE OF WORK:

47 CFR FCC Part 15.231 – Radio Spectrum report

Model:

PMV-G100

REPORT NUMBER

210500001THC-001

ISSUE DATE

Aug. 24, 2021

PAGES

28

DOCUMENT CONTROL NUMBER

GFT-OP-10h (28-Nov-2018)

© 2020 Intertek



Radio Spectrum TEST REPORT

Applicant:	Pacific Industrial Company, LTD. 1300-1, Yokoi, Godo-cho, Anpachi-gun, Gifu 503-2397, Japan
Product:	TPMS (Tire Pressure Monitoring System Transmitter)
Model No.:	PMV-G100
FCC ID:	PAXPMVG100
Test Method/ Standard:	47 CFR FCC Part 15.231
Test By:	Intertek Testing Services Taiwan Ltd., Hsinchu Laboratory No. 11, Lane 275, Ko-Nan 1 Street, Chia-Tung Li, Shiang-Shan District, Hsinchu City, Taiwan



Zero chen

Zero Chen
Engineer

Durant Wei

Durant Wei
Reviewer

This report is for the exclusive use of Intertek's Client and is provided pursuant to the agreement between Intertek and its Client. Intertek's responsibility and liability are limited to the terms and conditions of the agreement. Intertek assumes no liability to any party, other than to the Client in accordance with the agreement, for any loss, expense or damage occasioned by the use of this report. Only the Client is authorized to permit copying or distribution of this report and then only in its entirety. Any use of the Intertek name or one of its marks for the sale or advertisement of the tested material, product or service must first be approved in writing by Intertek. The observations and test results in this report are relevant only to the sample tested. This report by itself does not imply that the material, product, or service is or has ever been under an Intertek certification program.

Revision History

Report No.	Issue Date	Revision Summary
210500001THC-001	Aug. 24, 2021	Original report

Table of Contents

1. General Information	5
1.1 Identification of the EUT	5
1.2 Antenna description	5
2. Test specifications.....	6
2.1 Test standard	6
2.2 Operation mode	6
2.3 Peripherals equipment	6
3. Radiated emission test FCC 15.231 (b)	7
3.1 Test setup & procedure	7
3.1.1 Radiated emission from 9kHz to 30MHz uses Loop Antenna:	7
3.1.2 Radiated emission below 1GHz using Bilog Antenna	8
3.1.3 Radiated emission above 1GHz using Horn Antenna	8
3.2 Radiated emission limit	9
3.2.1 Fundamental and harmonics emission limits.....	9
3.2.2 General radiated emission limit	9
3.3 Radiated emission test data FCC 15.231	10
3.3.1 Measurement results: Fundamental emission.....	10
3.3.2 Measurement results: frequencies equal to or less than 1 GHz	11
3.3.3 Measurement results: frequency above 1GHz.....	21
4. Measured bandwidth FCC 15.231(C).....	22
5. Timing requirement of activation operated transmitter.....	24
6. Conducted emission FCC 15.207	26
Appendix A: Test equipment list.....	27
Appendix B: Measurement Uncertainty.....	28

Summary of Test Data

Test Requirement	Applicable Rule	Result
Radiated Emission test	15.231(e), 15.209	Pass
Measured bandwidth	15.231(c)	Pass
Timing requirement of operated transmitter	15.231(e)	Pass
Conducted Emission test	15.207	N/A
Antenna Requirement	15.203	Pass

Note: Please note that the test results with statement of conformity, the decision rules which are based on: Safety Testing: the specification, standard or IEC Guide 115.

Other Testing: the specification, standard and not taking into account the measurement uncertainty.

1. General Information**1.1 Identification of the EUT**

Product:	TPMS (Tire Pressure Monitoring System Transmitter)
Model No.:	PMV-G100
Operating Frequency:	433.92 MHz
Rated Power:	DC 3V
Power Cord:	N/A
Sample receiving date:	2021/05/04
Sample condition:	Workable
Test Date(s):	2021/05/18 ~ 2021/08/24

1.2 Antenna description

Antenna Type : Metal Antenna
Connector Type : Fixed

2. Test specifications

2.1 Test standard

The EUT was performed according to the procedures in FCC Part 2.1053 and the requirement in FCC Part 15 Subpart C Section 15.231.

2.2 Operation mode

The EUT was supplied with DC 3V from battery.

TX mode: EUT powered on and transmit signal continued.

The signal is maximized through rotation and placement in the three orthogonal axes.

After verifying three axes, we found the maximum electromagnetic field was occurred at Y axis. The final test data was executed under this configuration.

2.3 Peripherals equipment

Peripherals	Brand	Model No.	Serial No.	Data cable
Battery	Panasonic	CR2032A	N/A	N/A

3. Radiated emission test FCC 15.231 (b)

3.1 Test setup & procedure

3.1.1 Radiated emission from 9kHz to 30MHz uses Loop Antenna:

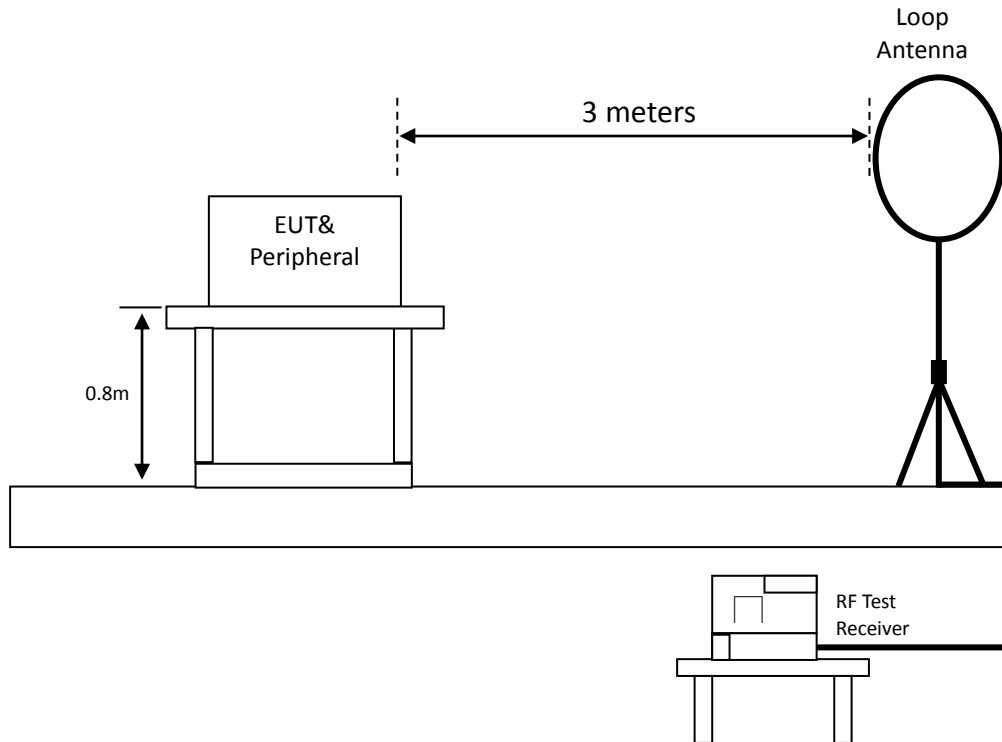

3.1.2 Radiated emission below 1GHz using Bilog Antenna

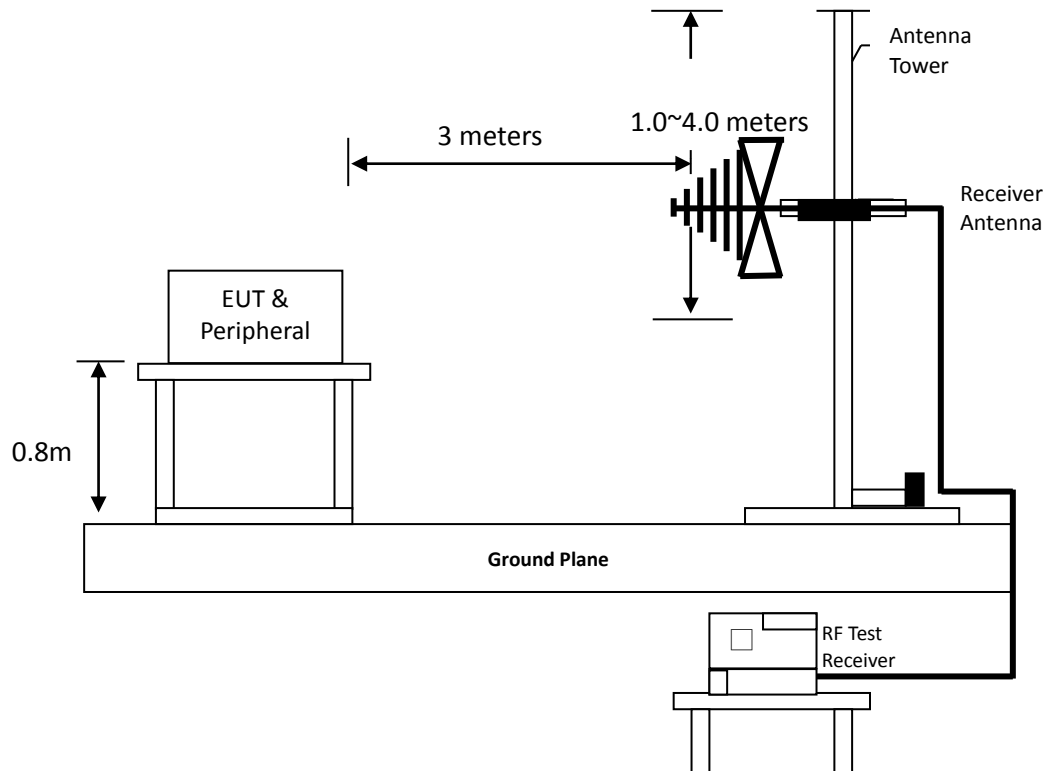

3.1.3 Radiated emission above 1GHz using Horn Antenna

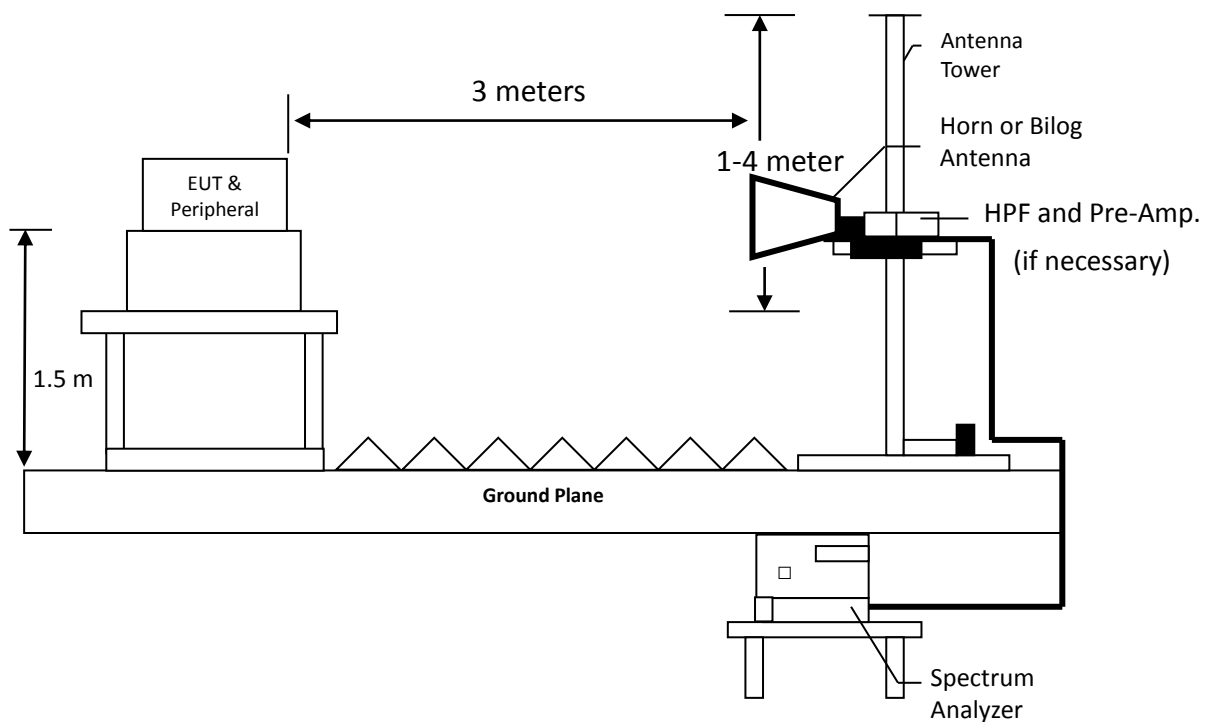

3.2 Radiated emission limit

3.2.1 Fundamental and harmonics emission limits

Frequency (MHz)	Field Strength of Fundamental		Field Strength of Harmonics	
	(uV/m@3 m)	(dBuV/m@3 m)	(uV/m@3 m)	(dBuV/m@3 m)
433.92	4398.68	72.86	439.86	52.86

3.2.2 General radiated emission limit

The spurious Emission shall test through the 10th harmonic. In addition, radiated emissions which fall in the restricted bands, as defined in §15.205(a), must also comply with the radiated emission limits specified in §15.209(a).

Frequency MHz	15.209 Limits (dBµV/m@3m)
30-88	40
88-216	43.5
216-960	46
Above 960	54

Remark:

1. In the above table, the tighter limit applies at the band edges.
2. Distance refers to the distance in meters between the measuring instrument antenna and the closed point of any part of the device or system

TEST REPORT

3.3 Radiated emission test data FCC 15.231

3.3.1 Measurement results: Fundamental emission

Temperature: 26 °C
 Relative Humidity: 55 %
 Test date: 2021/5/18

Mode	Frequency (MHz)	Spectrum Analyzer Detector	Antenna Polarization	Correction Factor (dB/m)	Reading (dBμV)	Corrected Reading (dBμV/m)	Limit @ 3 m (dBμV/m)	Margin (dB)
ASK	433.92	PK	V	25.77	43.80	69.57	92.86	-23.29
	433.92	AV	V	-	-	51.53	72.86	-21.33
	433.92	PK	H	25.77	50.89	76.66	92.86	-16.20
	433.92	AV	H	-	-	58.62	72.86	-14.24
FSK	433.92	PK	V	25.77	44.43	70.20	92.86	-22.66
	433.92	AV	V	-	-	52.16	72.86	-20.70
	433.92	PK	H	25.77	49.85	75.62	92.86	-17.24
	433.92	AV	H	-	-	57.58	72.86	-15.28

Remark: Correction Factor = Antenna Factor + Cable Loss

Note: AV Corrected Reading = PK Corrected Reading + Duty cycle correction factor (-18.54)

TEST REPORT

3.3.2 Measurement results: frequencies equal to or less than 1 GHz

Temperature: 26 °C
 Relative Humidity: 55 %
 Test date: 2021/5/18

9kHz – 30MHz (Mode: ASK)

Antenna Polarization	Frequency (MHz)	Spectrum Analyzer Detector	Correction Factor (dB/m)	Reading (dBμV)	Corrected Reading (dBμV/m)	Limit @ 3 m (dBμV/m)	Margin (dB)
Perpendicular	0.03	AV	19.53	55.53	75.06	117.78	-42.72
Perpendicular	0.09	QP	18.51	51.14	69.65	108.42	-38.77
Perpendicular	0.16	AV	18.57	50.77	69.34	103.58	-34.24
Perpendicular	0.22	AV	18.75	46.26	65.01	100.80	-35.79
Perpendicular	0.48	AV	19.29	41.74	61.03	93.96	-32.93
Perpendicular	0.80	QP	19.66	29.59	49.25	69.59	-20.34

Remark: Corr. Factor = Antenna Factor + Cable Loss

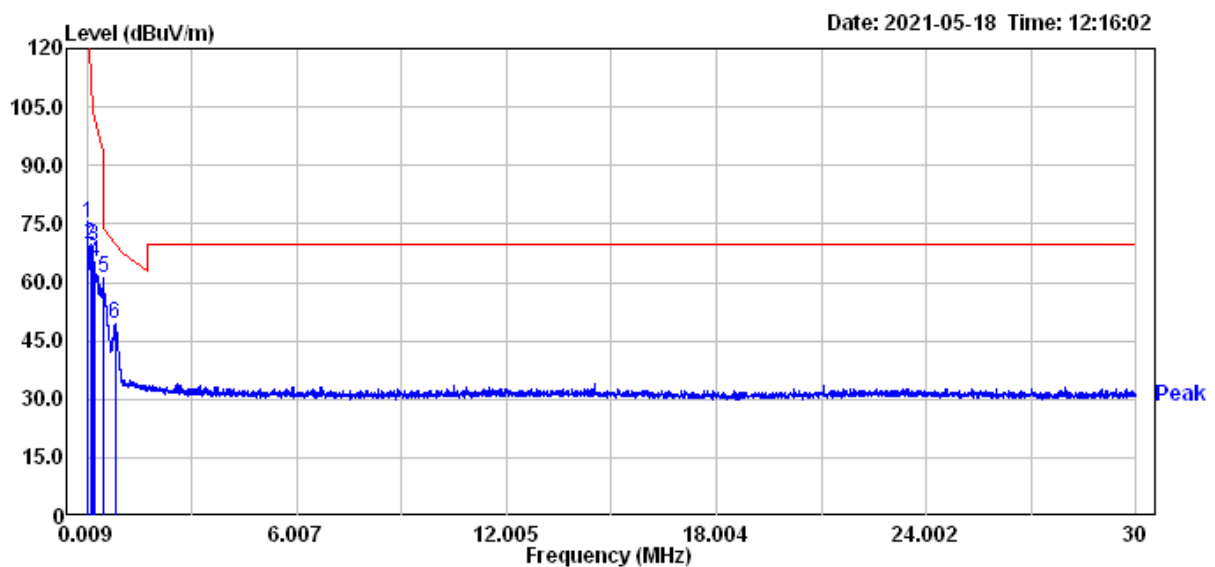

TEST REPORT

9kHz – 30MHz (Mode: ASK)

Antenna Polarization	Frequency (MHz)	Spectrum Analyzer Detector	Correction Factor (dB/m)	Reading (dBμV)	Corrected Reading (dBμV/m)	Limit @ 3 m (dBμV/m)	Margin (dB)
Parallel	0.03	AV	19.53	55.08	74.61	117.78	-43.17
Parallel	0.09	QP	18.51	50.28	68.79	108.42	-39.63
Parallel	0.15	AV	18.53	50.24	68.77	104.02	-35.25
Parallel	0.22	AV	18.75	45.69	64.44	100.80	-36.36
Parallel	0.47	AV	19.26	39.04	58.30	94.09	-35.79
Parallel	0.80	QP	19.66	29.67	49.33	69.50	-20.17

Remark: Corr. Factor = Antenna Factor + Cable Loss

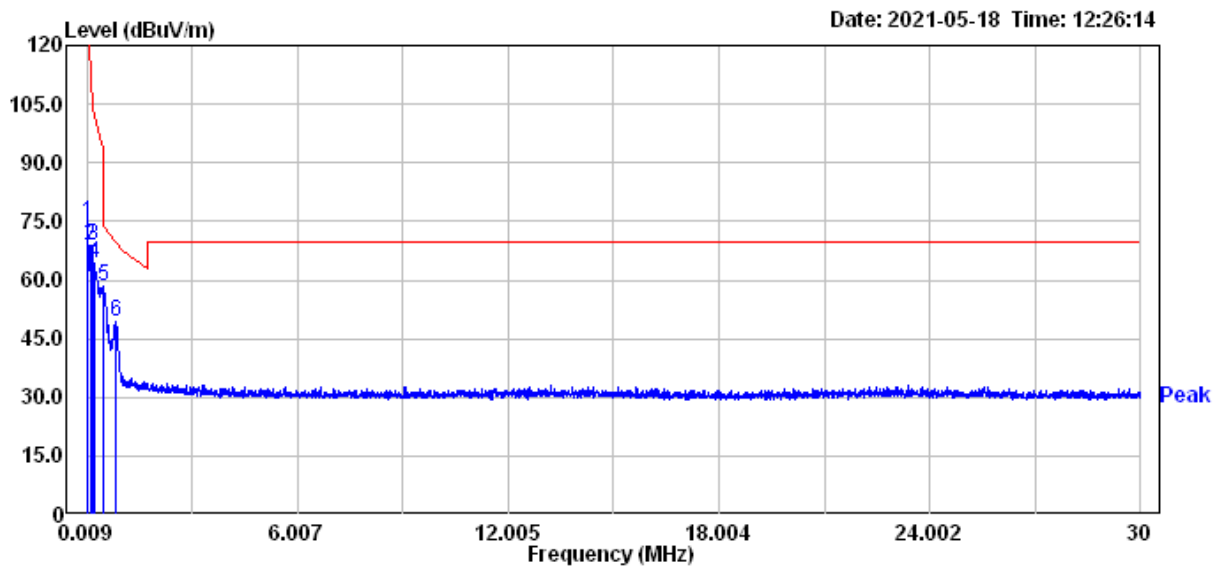

9kHz – 30MHz (Mode: ASK)

Antenna Polarization	Frequency (MHz)	Spectrum Analyzer Detector	Correction Factor (dB/m)	Reading (dBμV)	Corrected Reading (dBμV/m)	Limit @ 3 m (dBμV/m)	Margin (dB)
Ground-parallel	0.03	AV	19.53	55.27	74.80	117.78	-42.98
Ground-parallel	0.16	AV	18.57	51.63	70.20	103.58	-33.38
Ground-parallel	0.20	AV	18.75	46.46	65.21	101.76	-36.55
Ground-parallel	0.32	AV	18.74	43.67	62.41	97.61	-35.20
Ground-parallel	0.48	AV	19.29	40.06	59.35	93.96	-34.61
Ground-parallel	0.83	QP	19.65	31.79	51.44	69.26	-17.82

Remark: Corr. Factor = Antenna Factor + Cable Loss

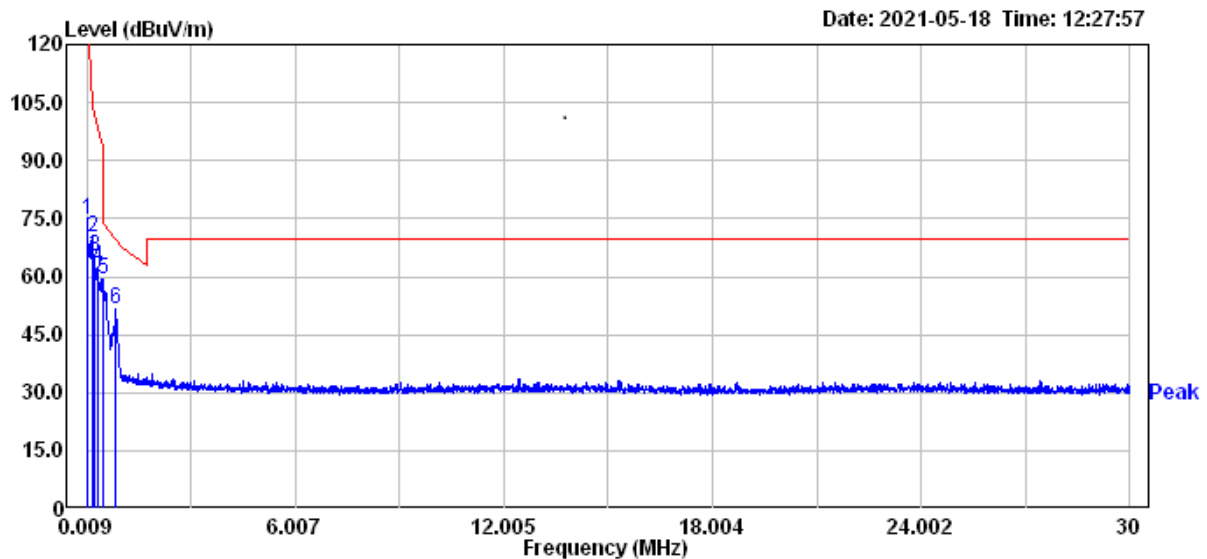

TEST REPORT

9kHz – 30MHz (Mode: FSK)

Antenna Polarization	Frequency (MHz)	Spectrum Analyzer Detector	Correction Factor (dB/m)	Reading (dB μ V)	Corrected Reading (dB μ V/m)	Limit @ 3 m (dB μ V/m)	Margin (dB)
Perpendicular	0.03	AV	19.53	55.08	74.61	117.78	-43.17
Perpendicular	0.08	AV	18.90	49.40	68.30	109.99	-41.69
Perpendicular	0.15	AV	18.53	50.10	68.63	104.02	-35.39
Perpendicular	0.39	AV	18.84	40.46	59.30	95.76	-36.46
Perpendicular	0.46	AV	19.17	38.76	57.93	94.37	-36.44
Perpendicular	0.80	QP	19.66	28.48	48.14	69.50	-21.36

Remark: Corr. Factor = Antenna Factor + Cable Loss

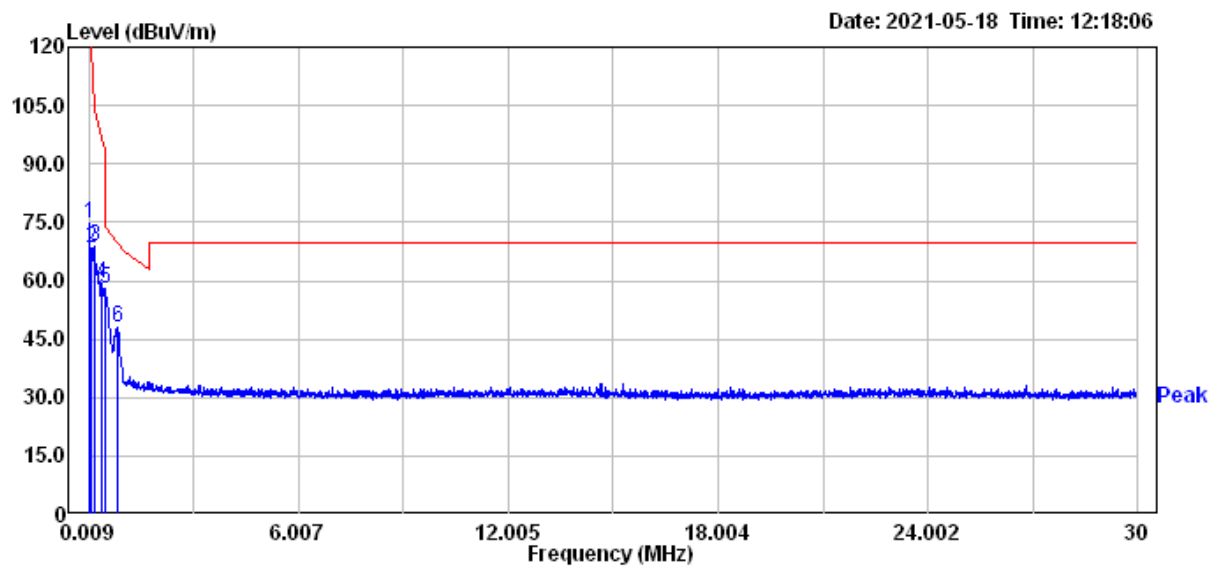

TEST REPORT

9kHz – 30MHz (Mode: FSK)

Antenna Polarization	Frequency (MHz)	Spectrum Analyzer Detector	Correction Factor (dB/m)	Reading (dB μ V)	Corrected Reading (dB μ V/m)	Limit @ 3 m (dB μ V/m)	Margin (dB)
Parallel	0.03	AV	19.53	55.14	74.67	117.78	-43.11
Parallel	0.08	AV	18.90	50.24	69.14	109.99	-40.85
Parallel	0.14	AV	18.50	50.09	68.59	104.44	-35.85
Parallel	0.17	AV	18.64	46.49	65.13	102.79	-37.66
Parallel	0.47	AV	19.26	40.98	60.24	94.09	-33.85
Parallel	0.80	QP	19.66	29.62	49.28	69.50	-20.22

Remark: Corr. Factor = Antenna Factor + Cable Loss

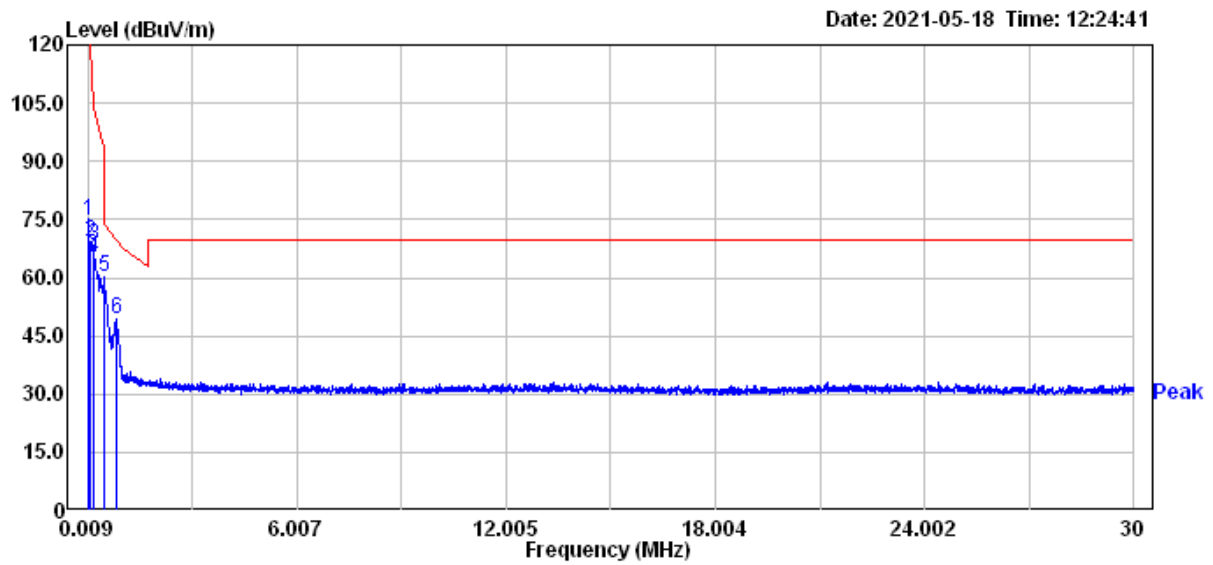

TEST REPORT

9kHz – 30MHz (Mode: FSK)

Antenna Polarization	Frequency (MHz)	Spectrum Analyzer Detector	Correction Factor (dB/m)	Reading (dB μ V)	Corrected Reading (dB μ V/m)	Limit @ 3 m (dB μ V/m)	Margin (dB)
Ground-parallel	0.03	AV	19.53	55.06	74.59	117.78	-43.19
Ground-parallel	0.09	QP	18.51	50.60	69.11	108.42	-39.31
Ground-parallel	0.15	AV	18.53	50.88	69.41	104.02	-34.61
Ground-parallel	0.22	AV	18.75	46.49	65.24	100.80	-35.56
Ground-parallel	0.30	AV	18.71	43.02	61.73	98.03	-36.30
Ground-parallel	0.47	AV	19.26	39.67	58.93	94.09	-35.16

Remark: Corr. Factor = Antenna Factor + Cable Loss

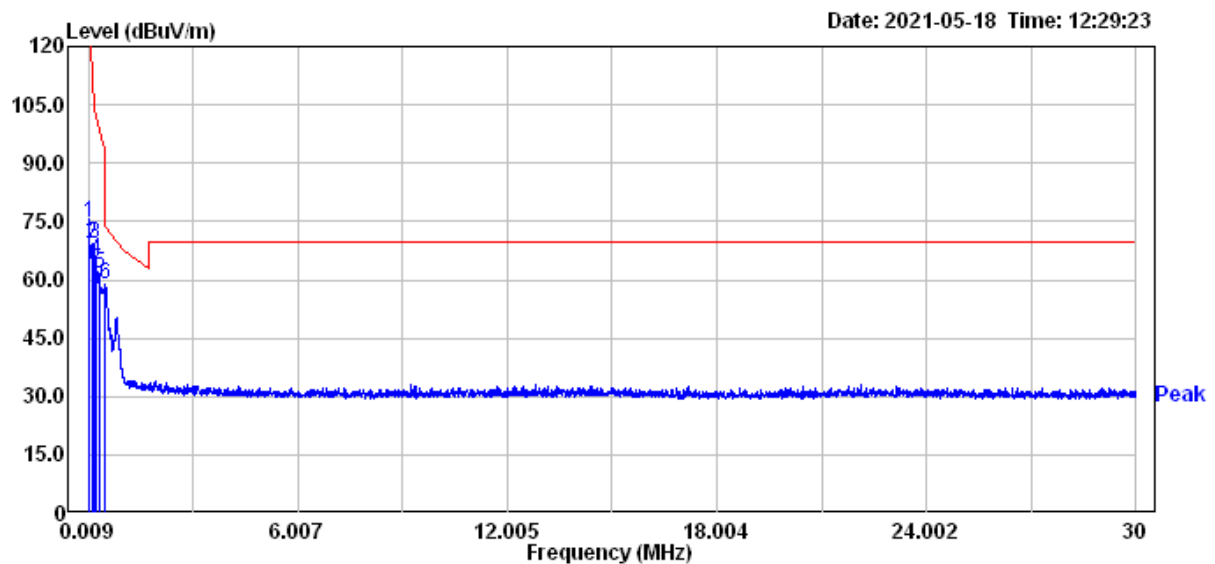

TEST REPORT

Temperature: 26 °C
 Relative Humidity: 55 %
 Test date: 2021/5/18

30MHz – 1GHz (Mode: ASK)

Antenna Polarization	Frequency (MHz)	Spectrum Analyzer Detector	Correction Factor (dB/m)	Reading (dBμV)	Corrected Reading (dBμV/m)	Limit @ 3 m (dBμV/m)	Margin (dB)
Vertical	63.95	QP	20.11	7.02	27.13	60.82	-33.69
Vertical	152.22	QP	20.87	8.46	29.33	60.82	-31.49
Vertical	241.46	QP	20.31	9.46	29.77	46.00	-16.23
Vertical	277.35	QP	21.50	8.79	30.29	46.00	-15.71
Vertical	709.97	QP	30.79	11.57	42.36	60.82	-18.46
Vertical	731.31	QP	31.31	11.30	42.61	60.82	-18.21

Remark: Corr. Factor = Antenna Factor + Cable Loss

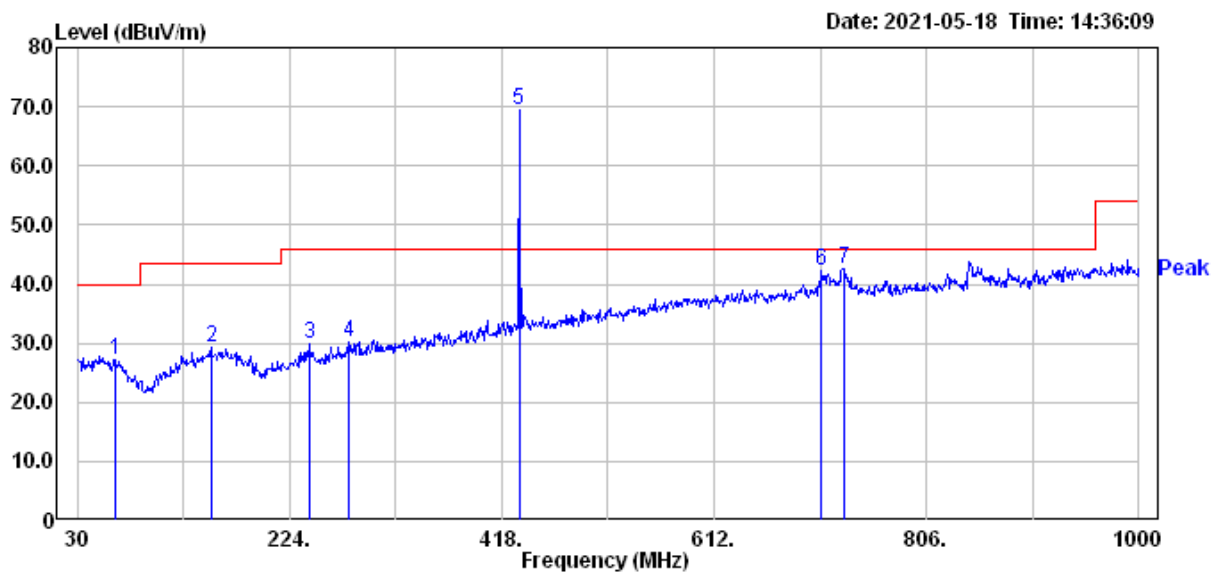

TEST REPORT

30MHz – 1GHz (Mode: ASK)

Antenna Polarization	Frequency (MHz)	Spectrum Analyzer Detector	Correction Factor (dB/m)	Reading (dB μ V)	Corrected Reading (dB μ V/m)	Limit @ 3 m (dB μ V/m)	Margin (dB)
Horizontal	53.28	QP	20.94	7.31	28.25	60.82	-32.57
Horizontal	159.98	QP	21.13	9.31	30.44	60.82	-30.38
Horizontal	245.34	QP	20.39	9.70	30.09	46.00	-15.91
Horizontal	362.71	QP	23.63	8.29	31.92	60.82	-28.90
Horizontal	592.60	QP	29.17	9.67	38.84	60.82	-21.98
Horizontal	729.37	QP	31.22	12.12	43.34	60.82	-17.48

Remark: Corr. Factor = Antenna Factor + Cable Loss

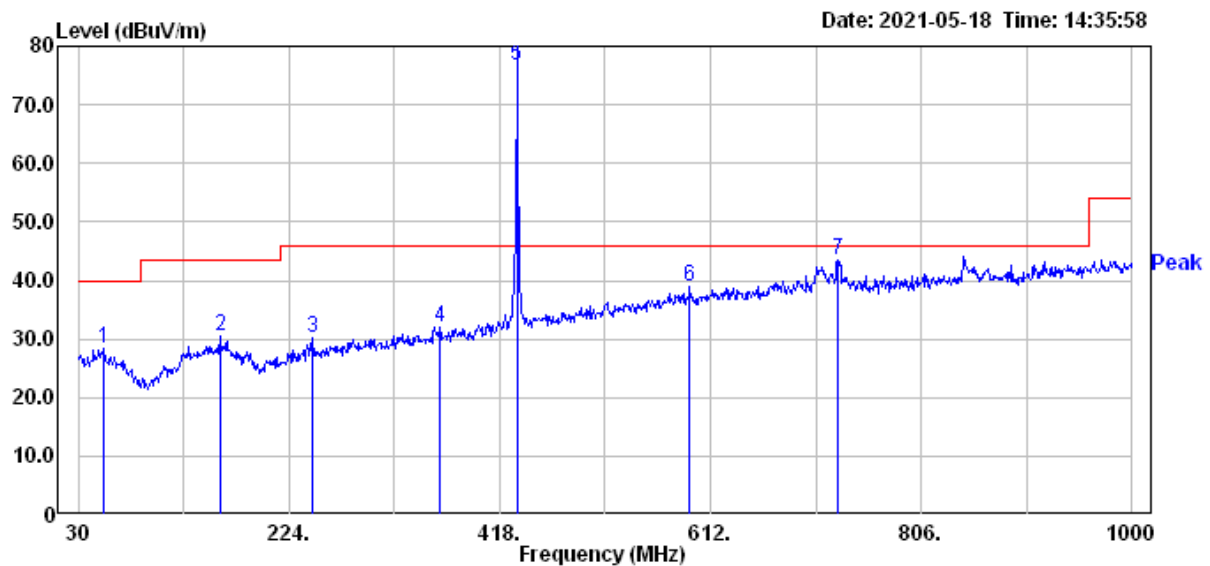

TEST REPORT

30MHz – 1GHz (Mode: FSK)

Antenna Polarization	Frequency (MHz)	Spectrum Analyzer Detector	Correction Factor (dB/m)	Reading (dBμV)	Corrected Reading (dBμV/m)	Limit @ 3 m (dBμV/m)	Margin (dB)
Vertical	56.19	QP	20.63	7.31	27.94	60.82	-32.88
Vertical	147.37	QP	20.77	8.77	29.54	60.82	-31.28
Vertical	168.71	QP	20.90	8.53	29.43	43.50	-14.07
Vertical	242.43	QP	20.32	8.98	29.30	46.00	-16.70
Vertical	709.00	QP	30.78	11.53	42.31	60.82	-18.51
Vertical	729.37	QP	31.22	11.41	42.63	60.82	-18.19

Remark: Corr. Factor = Antenna Factor + Cable Loss

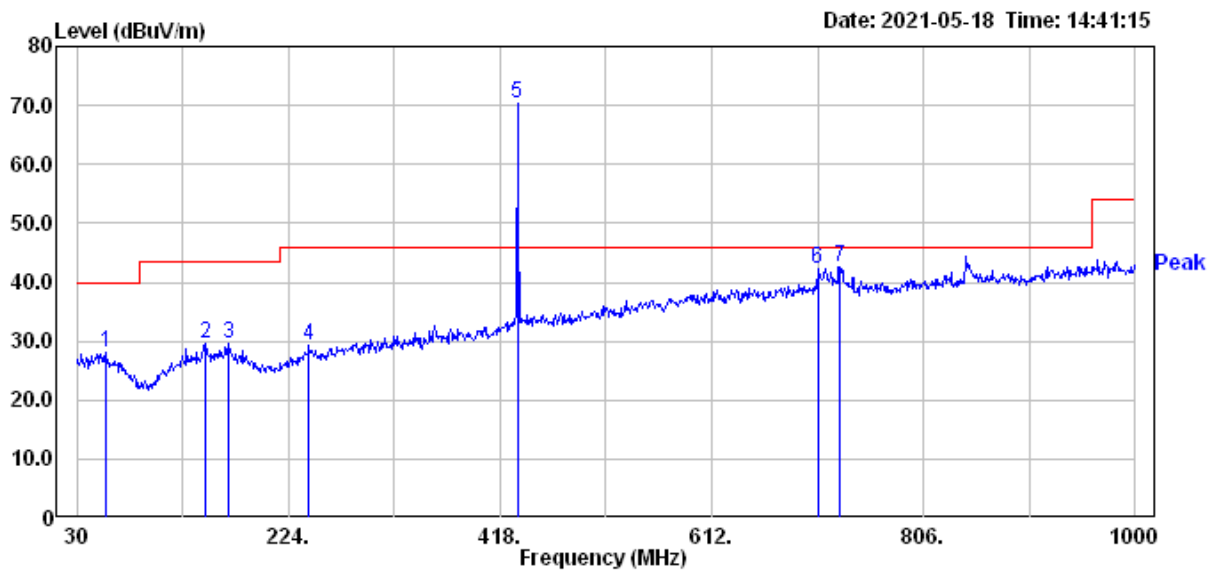

TEST REPORT

30MHz – 1GHz (Mode: FSK)

Antenna Polarization	Frequency (MHz)	Spectrum Analyzer Detector	Correction Factor (dB/m)	Reading (dB μ V)	Corrected Reading (dB μ V/m)	Limit @ 3 m (dB μ V/m)	Margin (dB)
Horizontal	67.83	QP	19.36	8.97	28.33	60.82	-32.49
Horizontal	170.65	QP	20.77	8.50	29.27	43.50	-14.23
Horizontal	244.37	QP	20.37	9.45	29.82	46.00	-16.18
Horizontal	339.43	QP	23.00	7.39	30.39	60.82	-30.43
Horizontal	711.91	QP	30.82	11.23	42.05	60.82	-18.77
Horizontal	826.37	QP	32.94	10.70	43.64	60.82	-17.18

Remark: Corr. Factor = Antenna Factor + Cable Loss

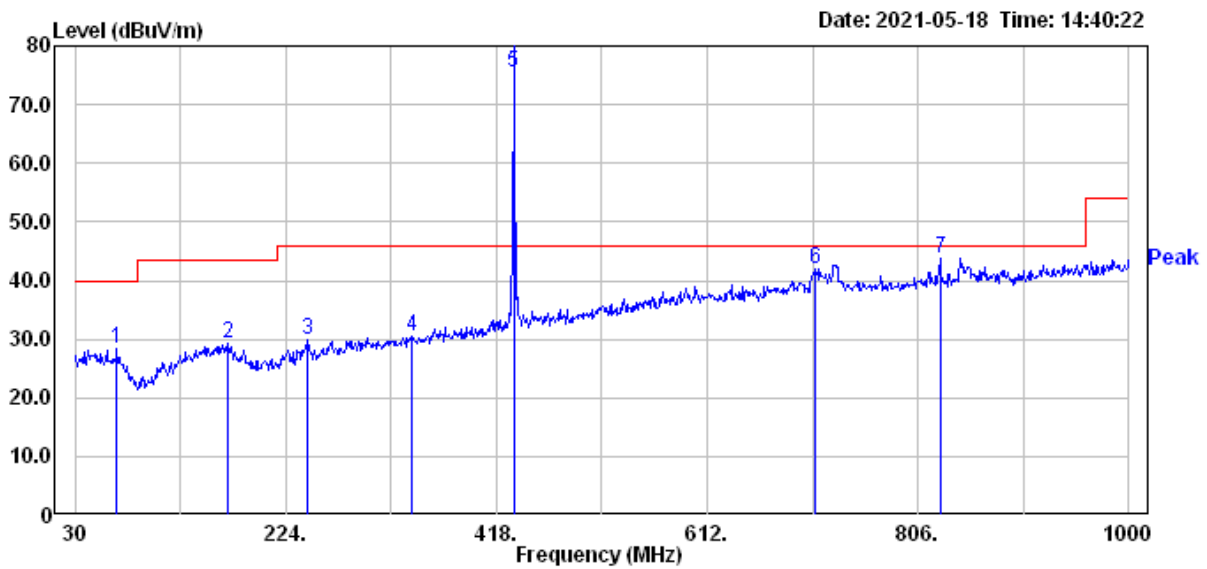

TEST REPORT

3.3.3 Measurement results: frequency above 1GHz

Temperature: 26 °C
 Relative Humidity: 55 %
 Test date: 2021/5/18

Mode	Frequency (MHz)	Spectrum Analyzer Detector	Antenna Polarization	Correction Factor (dB/m)	Reading (dBµV)	Corrected Reading (dBµV/m)	Limit @ 3 m (dBµV/m)	Margin (dB)
ASK	2818.25	PK	V	36.65	10.17	46.82	74.00	-27.18
	2814.75	PK	H	36.62	8.92	45.54	74.00	-28.46
FSK	2221.50	PK	V	35.10	9.71	44.81	74.00	-29.19
	2165.50	PK	H	34.83	9.81	44.64	74.00	-29.36

Remark: Correction Factor = Antenna Factor + Cable Loss + High Pass Filter Loss - Pre_Amplifier Gain

TEST REPORT

4. Measured bandwidth FCC 15.231(C)

Temperature: 27 °C
Relative Humidity: 57 %
Test date: 2021/5/25

The bandwidth of the emission shall be no wider than 0.25% of the center frequency for devices operating above 70MHz and below 900MHz. Bandwidth is determined at the points 20dB down from the modulated carrier.

Mode	Frequency (MHz)	20dB Occupied Bandwidth (MHz)	Limit (MHz)	Result
ASK	433.92	0.012	1.085	Pass
FSK	433.92	0.114	1.085	Pass

20dB Occupied Bandwidth@ASK

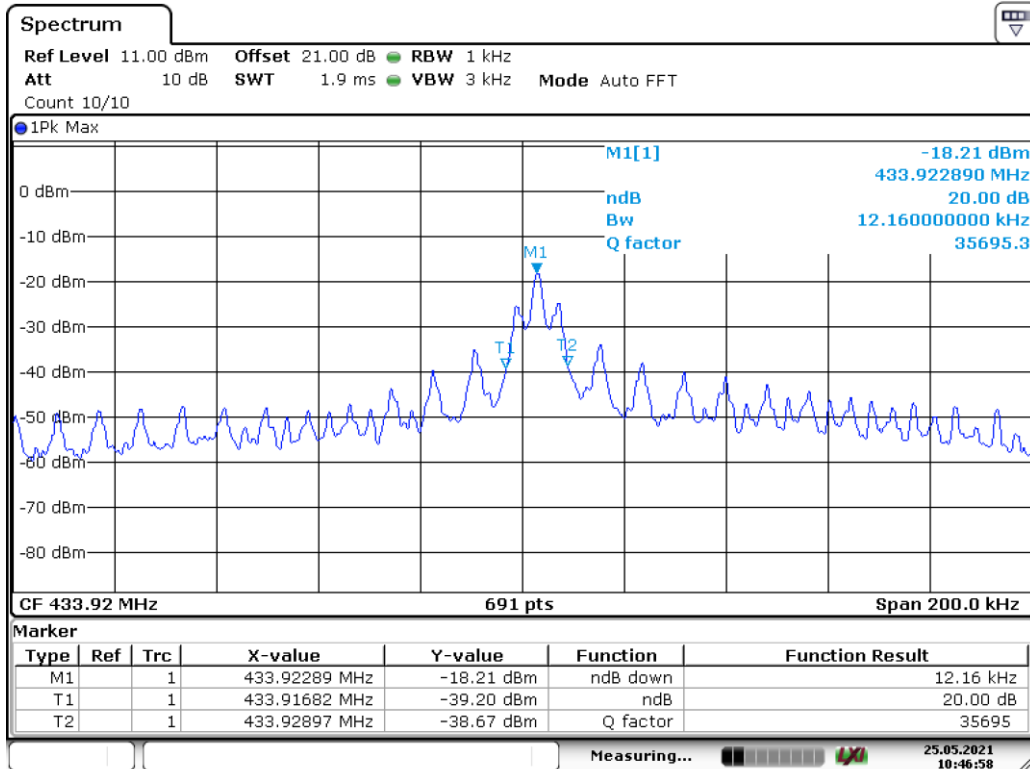

Date: 25.MAY.2021 10:46:58

20dB Occupied Bandwidth@FSK

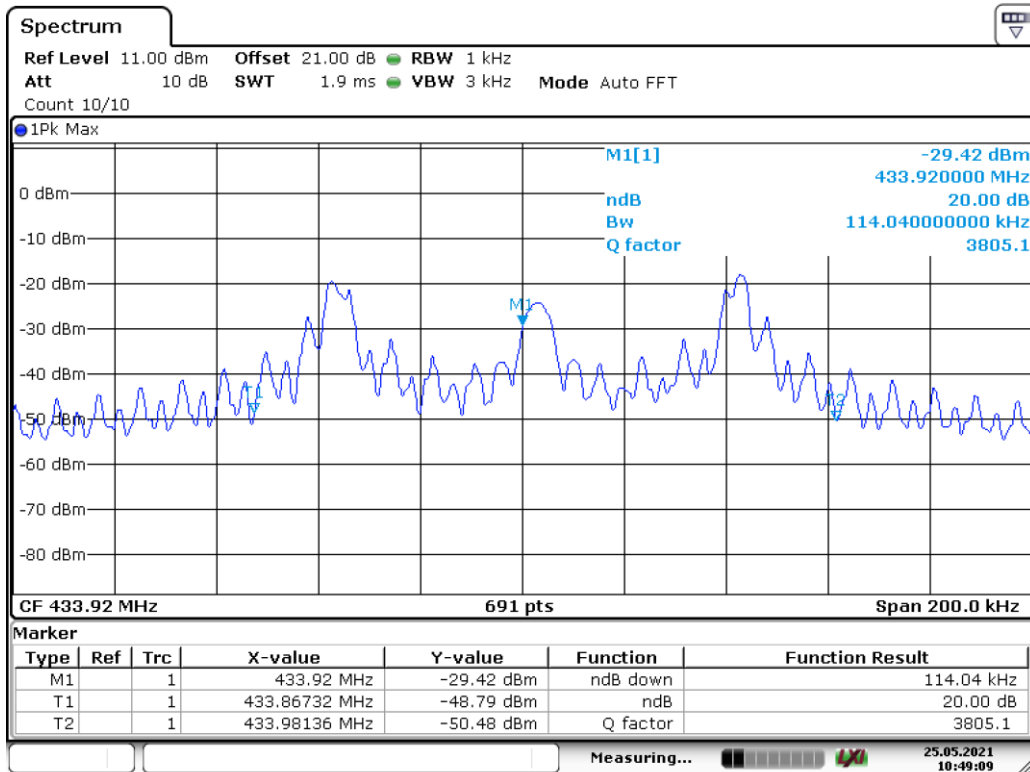

Date: 25.MAY.2021 10:49:09

5. Timing requirement of operated transmitter

Devices operated under the provisions of this paragraph shall be provided with a means for automatically limiting operation so that the duration of each transmission shall not be greater than one second and the silent period between transmissions shall be at least 30 times the duration of the transmission but in no case less than 10 seconds.

Mode	Frequency (MHz)	Transmission period (s)	Transmission period Limit (s)	Silent period Limit (s)	Result
ASK	433.92	0.7826	<1	>23.478	Pass
FSK	433.92	0.7826	<1	>23.478	Pass

Note: The silent period between transmissions shall be at least 30 times the duration of the transmission but in no case less than 10 seconds.
The duration time is 0.7826s, $0.7826 \times 30 = 23.478s$.

Transmitter Pulse Duration@ASK

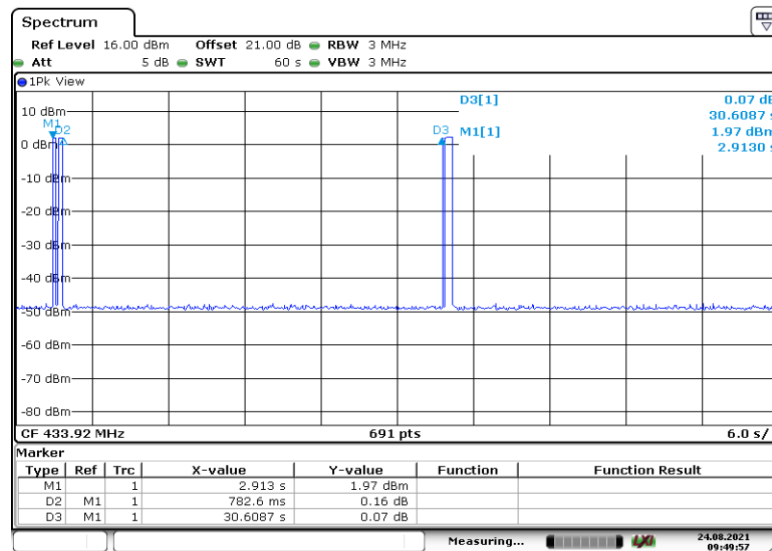

Date: 24.AUG.2021 09:49:57

Transmitter Pulse Duration@FSK

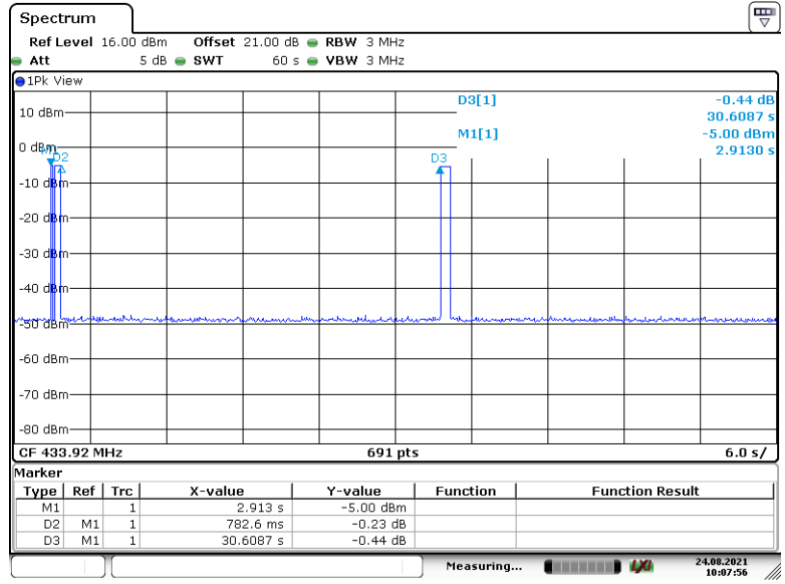

Date: 24.AUG.2021 10:07:56

6. Conducted emission FCC 15.207

Since the EUT is not connected to AC source, therefore, the test can be waived.

Appendix A: Test equipment list

Test Equipment/ Test site	Brand	Model No.	Serial No.	Calibration Date	Next Calibration Date
Signal Analyzer	Rohde & Schwarz	FSV40	101532	2020/09/28	2021/09/27
Signal Analyzer	Agilent	N9030A	MY51380492	2020/08/17	2021/08/16
Active Loop Antenna	SCHWARZBECK MESS-ELEKTRONIC	FMZB1519	1519-067	2021/04/14	2022/04/13
Broadband Antenna	SHWARZBECK	VULB 9168	9168-172	2020/06/02	2021/06/01
Horn Antenna	SHWARZBECK	BBHA 9120 D	9120D-456	2021/01/11	2022/01/10
Pre-Amplifier	EMC Co.	EMC12635SE	980205	2021/01/13	2022/01/12
966-2(A) Cable	SUHNER	SUCOLEX 104	295105/4	2021/03/08	2022/03/07
966-2(B) Cable	SUHNER	SUCOFLEX 104P	CB0005	2021/03/08	2022/03/07
20dB Attenuator	Mini-Circuits	BW-S20W5+	N/A	2021/05/26	2022/05/25
966-2_3m Semi-Anechoic Chamber	966_2	CEM-966_2	N/A	2021/01/15	2022/01/14
Test software	Audix	e3	V9	NCR	NCR

Appendix B: Measurement Uncertainty

This uncertainty represents an expanded uncertainty expressed at approximately the 95 % confidence level using a coverage factor of $k=2$.

Item	Uncertainty
Timing requirement of operated transmitter	1.27 dB
Occupied Bandwidth	7.78 %
Radiated disturbances from 9kHz~30MHz in a semi-anechoic chamber at a distance of 3m	3.70 dB
Vertically polarized radiated disturbances from 30MHz~1GHz in a semi-anechoic chamber at a distance of 3m	5.16 dB
Horizontally polarized radiated disturbances from 30MHz~1GHz in a semi-anechoic chamber at a distance of 3m	5.02 dB
Radiated disturbances from 1GHz~18GHz in a semi-anechoic chamber at a distance of 3m	5.17 dB
AC Power Line Conducted Emission	3.08 dB