

CETECOM ICT Services is now

CTC | advanced
member of RWTÜV group

TEST REPORT

Test report no.: 1-1110/16-60-02-B



Deutsche
Akkreditierungsstelle
D-PL-12076-01-01

Testing laboratory

CTC advanced GmbH

Untertuerkheimer Strasse 6 – 10

66117 Saarbruecken / Germany

Phone: + 49 681 5 98 - 0

Fax: + 49 681 5 98 - 9075

Internet: <http://www.ctcadvanced.com>

e-mail: mail@ctcadvanced.com

Accredited Testing Laboratory:

The testing laboratory (area of testing) is accredited according to DIN EN ISO/IEC 17025 (2005) by the Deutsche Akkreditierungsstelle GmbH (DAkkS)

The accreditation is valid for the scope of testing procedures as stated in the accreditation certificate with the registration number: D-PL-12076-01-01

Applicant

Pacific Industrial Co., Ltd

Godo-Cho, Anpachi

Gifu 503-2397 / JAPAN

Phone: -/-

Fax: -/-

Contact: Kunitaka Yano

e-mail: knyano@pacific-ind.co.jp

Phone: +81 584 28 01 11

Manufacturer

Pacific Industrial Co., Ltd

Godo-Cho, Anpachi

Gifu 503-2397 / JAPAN

Test standard/s

47 CFR Part 15	Title 47 of the Code of Federal Regulations; Chapter I; Part 15 - Radio frequency devices
RSS - 210 Issue 9	Spectrum Management and Telecommunications Radio Standards Specification - Licence-Exempt Radio Apparatus: Category I Equipment

For further applied test standards please refer to section 3 of this test report.

Test Item

Kind of test item:	Tire Pressure Monitoring System Transmitter
Model name:	PMV-CE71
FCC ID:	PAXPMVCE71
IC:	3729A-PMVCE71
Frequency:	433.920 MHz
Technology tested:	Modulated carrier
Antenna:	Integrated PCB antenna
Power supply:	3.0 V DC by lithium battery



This test report is electronically signed and valid without handwriting signature. For verification of the electronic signatures, the public keys can be requested at the testing laboratory.

Test report authorized:

p.o.

Stefan Bös
Lab Manager
Radio Communications & EMC

Test performed:

Marco Bertolino
Lab Manager
Radio Communications & EMC

1 Table of contents

1	Table of contents.....	2
2	General information	3
2.1	Notes and disclaimer	3
2.2	Application details.....	3
2.3	Test laboratories sub-contracted	3
3	Test standard/s and references	4
4	Test environment.....	5
5	Test item.....	5
5.1	General description.....	5
5.2	Additional information	5
6	Description of the test setup.....	6
6.1	Shielded semi anechoic chamber.....	7
6.2	Shielded fully anechoic chamber	8
6.3	Test setup for normalized measurement configurations	9
7	Sequence of testing	10
7.1	Sequence of testing radiated spurious 9 kHz to 30 MHz.....	10
7.2	Sequence of testing radiated spurious 30 MHz to 1 GHz.....	11
7.3	Sequence of testing radiated spurious 1 GHz to 5 GHz	12
8	Summary of measurement results	13
8.1	Additional comments	13
9	Measurement results.....	14
9.1	Timing of the transmitter and silent periods between transmissions	14
9.2	Emission bandwidth.....	20
9.3	Field strength of the fundamental	21
9.4	Field strength of the harmonics and spurious	22
10	Observations	27
Annex A	Document history	27
Annex B	Further information.....	27
Annex C	Accreditation Certificate	28

2 General information

2.1 Notes and disclaimer

The test results of this test report relate exclusively to the test item specified in this test report. CTC advanced GmbH does not assume responsibility for any conclusions and generalizations drawn from the test results with regard to other specimens or samples of the type of the equipment represented by the test item.

The test report may only be reproduced or published in full. Reproduction or publication of extracts from the report requires the prior written approval of CTC advanced GmbH.

The testing service provided by CTC advanced GmbH has been rendered under the current "General Terms and Conditions for CTC advanced GmbH".

CTC advanced GmbH will not be liable for any loss or damage resulting from false, inaccurate, inappropriate or incomplete product information provided by the customer.

Under no circumstances does the CTC advanced GmbH test report include any endorsement or warranty regarding the functionality, quality or performance of any other product or service provided.

Under no circumstances does the CTC advanced GmbH test report include or imply any product or service warranties from CTC advanced GmbH, including, without limitation, any implied warranties of merchantability, fitness for purpose, or non-infringement, all of which are expressly disclaimed by CTC advanced GmbH.

All rights and remedies regarding vendor's products and services for which CTC advanced GmbH has prepared this test report shall be provided by the party offering such products or services and not by CTC advanced GmbH. In no case this test report can be considered as a Letter of Approval.

This test report is electronically signed and valid without handwritten signature. For verification of the electronic signatures, the public keys can be requested at the testing laboratory.

This test report replaces the test report with the number 1-1110/16-60-02-A and dated 2017-01-17

2.2 Application details

Date of receipt of order:	2016-11-16
Date of receipt of test item:	2016-12-12
Start of test:	2016-12-14
End of test:	2016-12-16
Person(s) present during the test:	-/-

2.3 Test laboratories sub-contracted

None

3 Test standard/s and references

Test standard	Date	Description
47 CFR Part 15	-/-	Title 47 of the Code of Federal Regulations; Chapter I; Part 15 - Radio frequency devices
RSS - 210 Issue 9	August 2016	Spectrum Management and Telecommunications Radio Standards Specification - Licence-Exempt Radio Apparatus: Category I Equipment

Guidance	Version	Description
ANSI C63.4-2014	-/-	American national standard for methods of measurement of radio-noise emissions from low-voltage electrical and electronic equipment in the range of 9 kHz to 40 GHz
ANSI C63.10-2013	-/-	American national standard of procedures for compliance testing of unlicensed wireless devices

6 Description of the test setup

Typically, the calibrations of the test apparatus are commissioned to and performed by an accredited calibration laboratory. The calibration intervals are determined in accordance with the DIN EN ISO/IEC 17025. In addition to the external calibrations, the laboratory executes comparison measurements with other calibrated test systems or effective verifications. Weekly chamber inspections and range calibrations are performed. Where possible, RF generating and signaling equipment as well as measuring receivers and analyzers are connected to an external high-precision 10 MHz reference (GPS-based or rubidium frequency standard).

In order to simplify the identification of the equipment used at some special tests, some items of test equipment and ancillaries can be provided with an identifier or number in the equipment list below (Lab/Item).

Agenda: Kind of Calibration

k	calibration / calibrated	EK	limited calibration
ne	not required (k, ev, izw, zw not required)	zw	cyclical maintenance (external cyclical maintenance)
ev	periodic self verification	izw	internal cyclical maintenance
Ve	long-term stability recognized	g	blocked for accredited testing
v/k!	Attention: extended calibration interval		
NK!	Attention: not calibrated	*)	next calibration ordered / currently in progress

6.1 Shielded semi anechoic chamber

The radiated measurements are performed in vertical and horizontal plane in the frequency range from 9 kHz to 1 GHz in semi-anechoic chambers. The EUT is positioned on a non-conductive support with a height of 0.80 m above a conductive ground plane that covers the whole chamber. The receiving antennas are confirmed with specifications ANSI C63. These antennas can be moved over the height range between 1.0 m and 4.0 m in order to search for maximum field strength emitted from EUT. The measurement distances between EUT and receiving antennas are indicated in the test setups for the various frequency ranges. For each measurement, the EUT is rotated in all three axes until the maximum field strength is received. The wanted and unwanted emissions are received by spectrum analyzers where the detector modes and resolution bandwidths over various frequency ranges are set according to requirement ANSI C63.

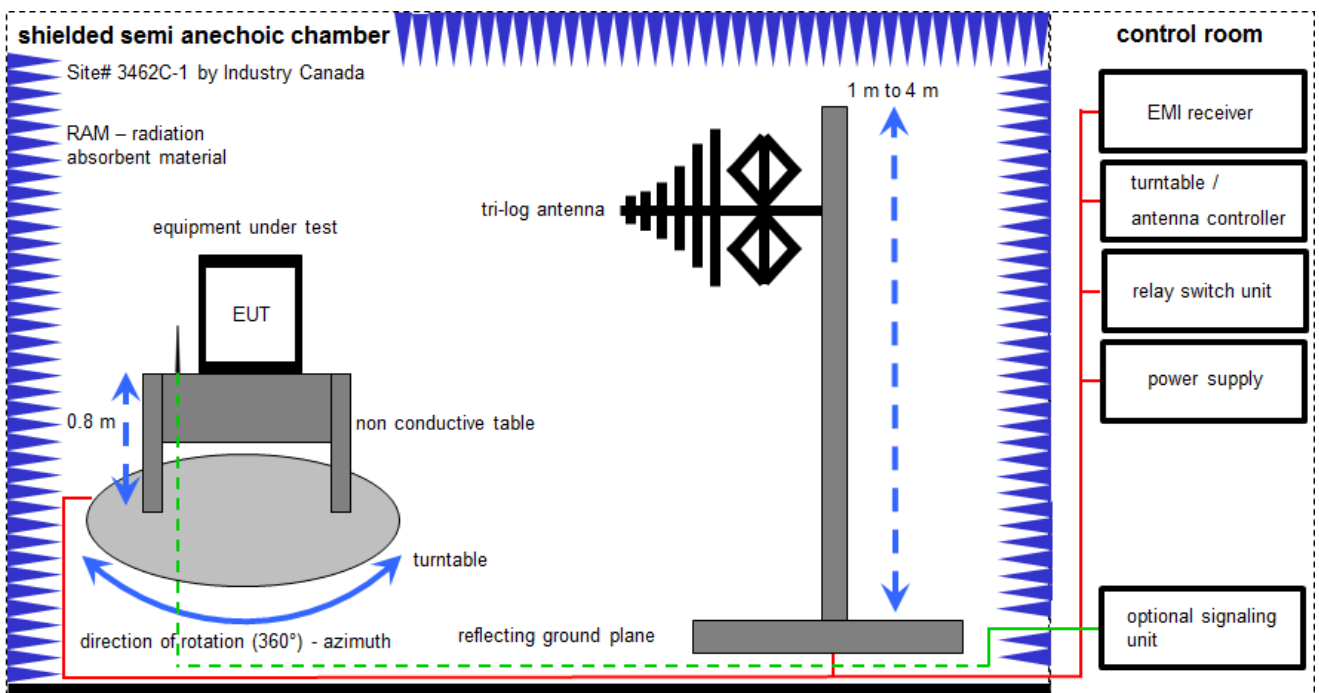

Measurement distance: tri-log antenna 10 meter

$$FS = UR + CL + AF$$

(FS-field strength; UR-voltage at the receiver; CL-loss of the cable; AF-antenna factor)

Example calculation:

$$FS [dB\mu V/m] = 12.35 [dB\mu V/m] + 1.90 [dB] + 16.80 [dB/m] = 31.05 [dB\mu V/m] (35.69 \mu V/m)$$

Equipment table:

No.	Lab / Item	Equipment	Type	Manufacturer	Serial No.	INV. No.	Kind of Calibration	Last Calibration	Next Calibration
1	A	Switch-Unit	3488A	HP	2719A14505	300000368	ev	-/-	-/-
2	A	EMI Test Receiver	ESCI 3	R&S	100083	300003312	k	08.03.2016	08.03.2017
3	A	Positioning Controller	Model 2090	ETS-Lindgren	64672	300003746	izw	-/-	-/-
4	A	Turntable Interface-Box	Model 105637	ETS-Lindgren	44583	300003747	izw	-/-	-/-
5	A	TRILOG Broadband Test-Antenna 30 MHz - 3 GHz	VULB9163	Schwarzbeck	295	300003787	k	25.04.2016	25.04.2018

6.2 Shielded fully anechoic chamber

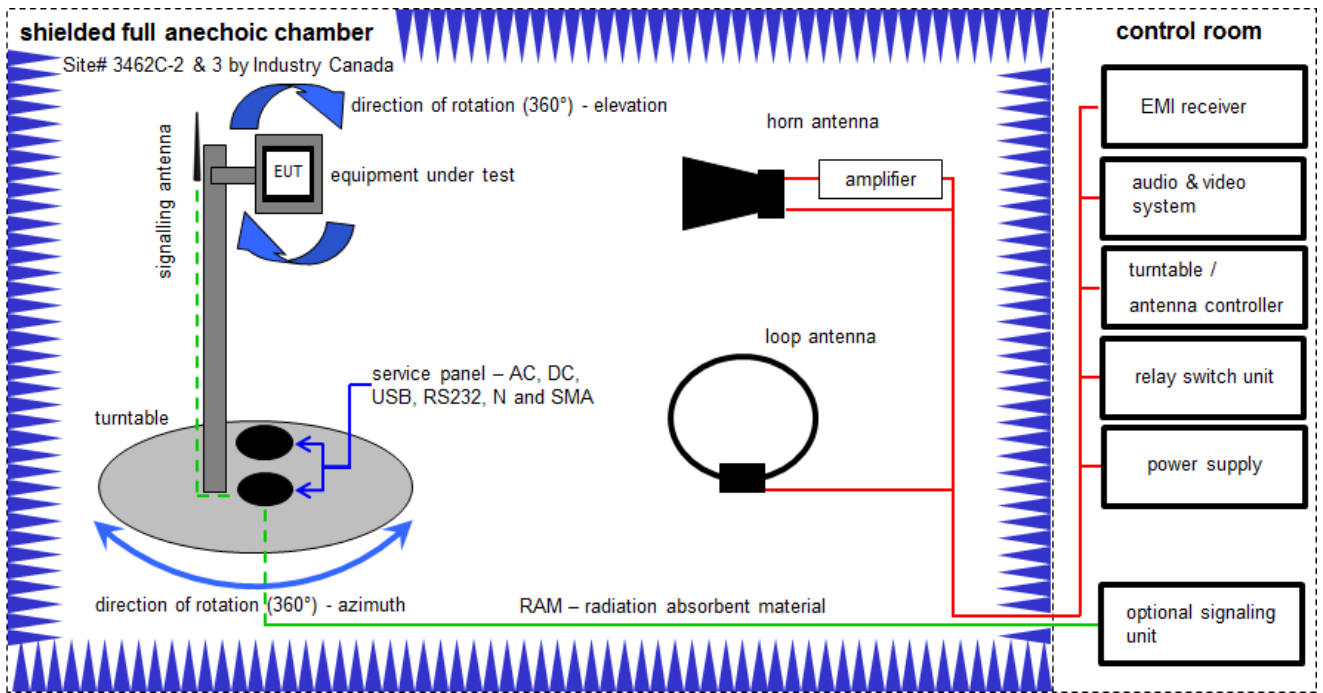

Measurement distance: horn antenna 3 meter; loop antenna 3 meter

$$FS = UR + CA + AF$$

(FS-field strength; UR-voltage at the receiver; CA-loss of the signal path; AF-antenna factor)

Example calculation:

$$FS [dB\mu V/m] = 40.0 [dB\mu V/m] + (-35.8) [dB] + 32.9 [dB/m] = 37.1 [dB\mu V/m] (71.61 \mu V/m)$$

Equipment table:

No.	Lab / Item	Equipment	Type	Manufacturer	Serial No.	INV. No.	Kind of Calibration	Last Calibration	Next Calibration
1	A	Double-Ridged Waveguide Horn Antenna 1-18.0GHz	3115	EMCO	8812-3088	300001032	vKI!	20.05.2015	20.05.2017
2	A, B	Anechoic chamber	FAC 3/5m	MWB / TDK	87400/02	300000996	ev	-/-	-/-
3	A, B	Switch / Control Unit	3488A	HP	*	300000199	ne	-/-	-/-
4	B	Active Loop Antenna 10 kHz to 30 MHz	6502	EMCO/2	8905-2342	300000256	k	24.06.2015	24.06.2017
5	A	Amplifier	js42-00502650-28-5a	Parzich GMBH	928979	300003143	ne	-/-	-/-
6	A, B	4U RF Switch Platform	L4491A	Agilent Technologies	MY50000037	300004509	ne	-/-	-/-
7	A, B	EMI Test Receiver 9kHz-26,5GHz	ESR26	R&S	101376	300005063	vKI!	13.09.2016	13.03.2018

6.3 Test setup for normalized measurement configurations

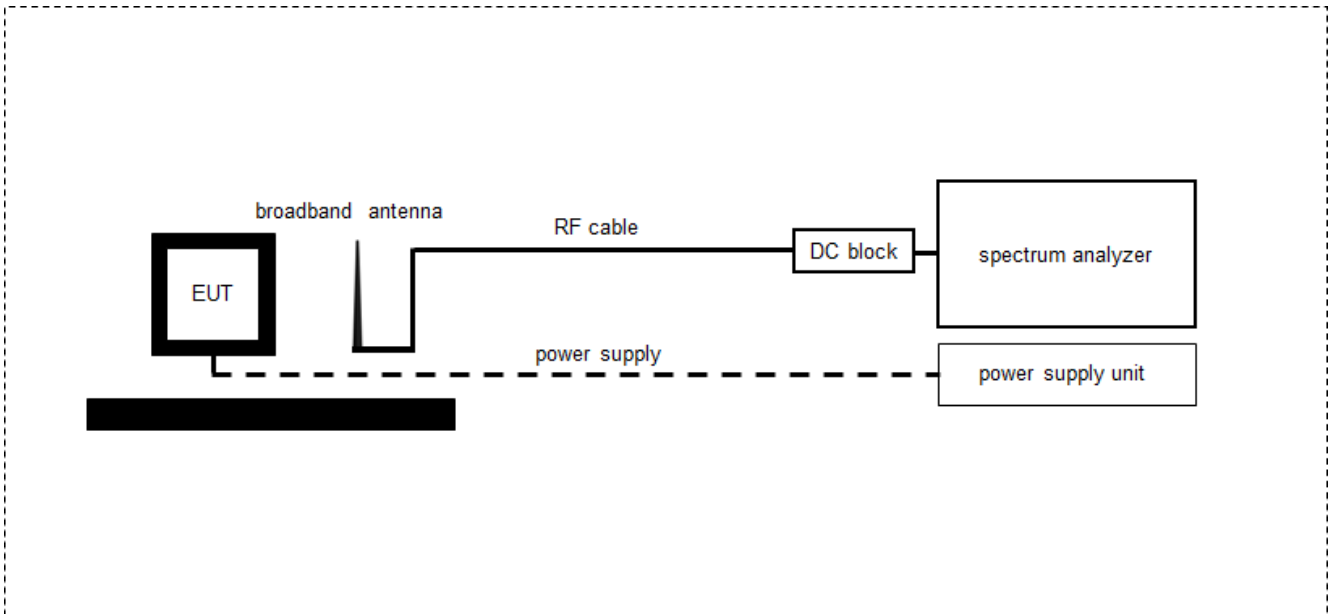

Equipment table:

No.	Lab / Item	Equipment	Type	Manufacturer	Serial No.	INV. No.	Kind of Calibration	Last Calibration	Next Calibration
1	A	Signal Analyzer 40 GHz	FSV40	R&S	101042	300004517	k	21.01.2016	21.01.2017
2	A	RF-Cable	ST18/SMAm/SMAm/72	Huber & Suhner	Batch no. 699714	400001184	ev	-/-	-/-
3	A	DC-Blocker 0.1-40 GHz	8141A	Inmet	Batch no. 699714	400001185	ev	-/-	-/-

7 Sequence of testing

7.1 Sequence of testing radiated spurious 9 kHz to 30 MHz

Setup

- The equipment is set up to simulate normal operation mode as described in the user manual or defined by the manufacturer.
- If the EUT is a tabletop system, a 2-axis positioner with 1.5 m height is used.
- If the EUT is a floor standing device, it is placed directly on the turn table.
- Auxiliary equipment and cables are positioned to simulate normal operation conditions as described in ANSI C 63.4.
- The AC power port of the EUT (if available) is connected to a power outlet below the turntable.
- Measurement distance is 3 m (see ANSI C 63.4) – see test details.
- EUT is set into operation.

Premeasurement

- The turntable rotates from 0° to 315° using 45° steps.
- The antenna height is 1.5 m.
- At each turntable position the analyzer sweeps with positive-peak detector to find the maximum of all emissions.

Final measurement

- Identified emissions during the premeasurement are maximized by the software by rotating the turntable from 0° to 360°. In case of the 2-axis positioner is used the elevation axis is also rotated from 0° to 360°.
- The final measurement is done in the position (turntable and elevation) causing the highest emissions with quasi-peak (as described in ANSI C 63.4).
- Final levels, frequency, measuring time, bandwidth, turntable position, correction factor, margin to the limit and limit will be recorded. A plot with the graph of the premeasurement and the limit is stored.

7.2 Sequence of testing radiated spurious 30 MHz to 1 GHz

Setup

- The equipment is set up to simulate normal operation mode as described in the user manual or defined by the manufacturer.
- If the EUT is a tabletop system, a table with 0.8 m height is used, which is placed on the ground plane.
- If the EUT is a floor standing device, it is placed on the ground plane with insulation between both.
- Auxiliary equipment and cables are positioned to simulate normal operation conditions as described in ANSI C 63.4.
- The AC power port of the EUT (if available) is connected to a power outlet below the turntable.
- Measurement distance is 10 m or 3 m (see ANSI C 63.4) – see test details.
- EUT is set into operation.

Premeasurement

- The turntable rotates from 0° to 315° using 45° steps.
- The antenna is polarized vertical and horizontal.
- The antenna height changes from 1 m to 3 m.
- At each turntable position, antenna polarization and height the analyzer sweeps three times in peak to find the maximum of all emissions.

Final measurement

- The final measurement is performed for at least six highest peaks according to the requirements of the ANSI C63.4.
- Based on antenna and turntable positions at which the peak values are measured the software maximize the peaks by changing turntable position $\pm 45^\circ$ and antenna height between 1 and 4 m.
- The final measurement is done with quasi-peak detector (as described in ANSI C 63.4).
- Final levels, frequency, measuring time, bandwidth, antenna height, antenna polarization, turntable angle, correction factor, margin to the limit and limit are recorded. A plot with the graph of the premeasurement with marked maximum final results and the limit is stored.

7.3 Sequence of testing radiated spurious 1 GHz to 5 GHz

Setup

- The equipment is set up to simulate normal operation mode as described in the user manual or defined by the manufacturer.
- If the EUT is a tabletop system, a 2-axis positioner with 1.5 m height is used.
- If the EUT is a floor standing device, it is placed directly on the turn table.
- Auxiliary equipment and cables are positioned to simulate normal operation conditions as described in ANSI C 63.4.
- The AC power port of the EUT (if available) is connected to a power outlet below the turntable.
- Measurement distance is 3 m (see ANSI C 63.4) – see test details.
- EUT is set into operation.

Premeasurement

- The turntable rotates from 0° to 315° using 45° steps.
- The antenna is polarized vertical and horizontal.
- The antenna height is 1.5 m.
- At each turntable position and antenna polarization the analyzer sweeps with positive peak detector to find the maximum of all emissions.

Final measurement

- The final measurement is performed for at least six highest peaks according to the requirements of the ANSI C63.4.
- Based on antenna and turntable positions at which the peak values are measured the software maximizes the peaks by rotating the turntable from 0° to 360°. This measurement is repeated for different EUT-table positions (0° to 150° in 30°-steps) and for both antenna polarizations.
- The final measurement is done in the position (turntable, EUT-table and antenna polarization) causing the highest emissions with Peak and RMS detector (as described in ANSI C 63.4).
- Final levels, frequency, measuring time, bandwidth, turntable position, EUT-table position, antenna polarization, correction factor, margin to the limit and limit are recorded. A plot with the graph of the premeasurement with marked maximum final results and the limit is stored.

8 Summary of measurement results

<input checked="" type="checkbox"/>	No deviations from the technical specifications were ascertained
<input type="checkbox"/>	There were deviations from the technical specifications ascertained
<input type="checkbox"/>	This test report is only a partial test report. The content and verdict of the performed test cases are listed below.

TC Identifier	Description	Verdict	Date	Remark
RF-Testing	CFR Part 15 RSS 210, Issue 9	See table!	2017-01-19	-/-

Test specification clause	Test case	Temperature conditions	Power source voltages	C	NC	NA	NP	Remark
§ 15.35 (c) 15.231(a & e) RSS-GEN	Timing of the transmitter (Duty cycle correction factor)	Nominal	Nominal	<input checked="" type="checkbox"/>	<input type="checkbox"/>	<input type="checkbox"/>	<input type="checkbox"/>	-/-
§ 15.231 (a & e) RSS-210 Issue 9	Silent period between transmissions	Nominal	Nominal	<input checked="" type="checkbox"/>	<input type="checkbox"/>	<input type="checkbox"/>	<input type="checkbox"/>	-/-
§ 15.231 (c) RSS-210 Issue 9	Emission bandwidth	Nominal	Nominal	<input checked="" type="checkbox"/>	<input type="checkbox"/>	<input type="checkbox"/>	<input type="checkbox"/>	-/-
§ 15.231 (a & e) RSS-210 Issue 9	Fieldstrength of Fundamental	Nominal	Nominal	<input checked="" type="checkbox"/>	<input type="checkbox"/>	<input type="checkbox"/>	<input type="checkbox"/>	-/-
§ 15.209 RSS-210 Issue 9	Fieldstrength of harmonics and spurious	Nominal	Nominal	<input checked="" type="checkbox"/>	<input type="checkbox"/>	<input type="checkbox"/>	<input type="checkbox"/>	-/-
§ 15.209 RSS-GEN	Receiver spurious emissions (radiated)	Nominal	Nominal	<input type="checkbox"/>	<input type="checkbox"/>	<input checked="" type="checkbox"/>	<input type="checkbox"/>	1*

Note: C = Compliant; NC = Not compliant; NA = Not applicable; NP = Not performed

1* No receiver mode integrated.

8.1 Additional comments

Reference documents: Customer Questionnaire_1-1110-16-60_PMV-CE71
 PMV-CC71, PMV-CE71_Trriger device manual (RF test mode instruction)
 TPMS_Technical_Document_PMV-CE71_FCC向け-434MHz_161201
 TPMS_Technical_Document_PMV-CE71_FCC向け-434MHz_P6差替_170117
 (EUT information and timing)

Special test descriptions: None

Configuration descriptions: None

9 Measurement results

9.1 Timing of the transmitter and silent periods between transmissions

Measurement:

Measurement parameter	
Detector:	Peak
Sweep time:	See plots
Resolution bandwidth:	1 MHz
Video bandwidth:	3 MHz
Span:	Zero
Trace mode:	Single sweep
Test setup:	See chapter 6.3 A

Limits:

FCC	IC
<p>(c) Unless otherwise specified, e.g. Section 15.255(b), when the radiated emission limits are expressed in terms of the average value of the emission, and pulsed operation is employed, the measurement field strength shall be determined by averaging over one complete pulse train, including blanking intervals, as long as the pulse train does not exceed 0.1 seconds. As an alternative (provided the transmitter operates for longer than 0.1 seconds) or in cases where the pulse train exceeds 0.1 seconds, the measured field strength shall be determined from the average absolute voltage during a 0.1 second interval during which the field strength is at its maximum value. The exact method of calculating the average field strength shall be submitted with any application for certification or shall be retained in the measurement data file for equipment subject to notification or verification.</p>	
<p style="text-align: center;">§15.231 (e)</p> <p>In addition, devices operated under the provisions of this paragraph shall be provided with a means for automatically limiting operation so that the duration of each transmission shall not be greater than one second and the silent period between transmissions shall be at least 30 times the duration of the transmission but in no case less than 10 seconds.</p>	
<p style="text-align: center;">§15.231 (a)</p> <p>The provisions of this section are restricted to periodic operation within the band 40.66-40.70 MHz and above 70 MHz. Except as shown in paragraph (e) of this section, the intentional radiator is restricted to the transmission of a control signal such as those used with alarm systems, door openers, remote switches, etc. Continuous transmissions, voice, video and the radio control of toys are not permitted. Data is permitted to be sent with a control signal. The following conditions shall be met to comply with the provisions for this periodic operation: (1) A manually operated transmitter shall employ a switch that will automatically deactivate the transmitter within not more than 5 seconds of being released. (2) A transmitter activated automatically shall cease transmission within 5 seconds after activation. (3) Periodic transmissions at regular predetermined intervals are not permitted. However, polling or supervision transmissions, including data, to determine system integrity of transmitters used in security or safety applications are allowed if the total duration of transmissions does not exceed more than two seconds per hour for each transmitter. There is no limit on the number of individual transmissions, provided the total transmission time does not exceed two seconds per hour. (4) Intentional radiators which are employed for radio control purposes during emergencies involving fire, security, and safety of life, when activated to signal an alarm, may operate during the pendency of the alarm condition. (5) Transmission of set-up information for security systems may exceed the transmission duration limits in paragraphs (a)(1) and (a)(2) of this section, provided such transmissions are under the control of a professional installer and do not exceed ten seconds after a manually operated switch is released or a transmitter is activated automatically. Such set-up information may include data.</p>	

Result:

Plot 1: Transmit burst

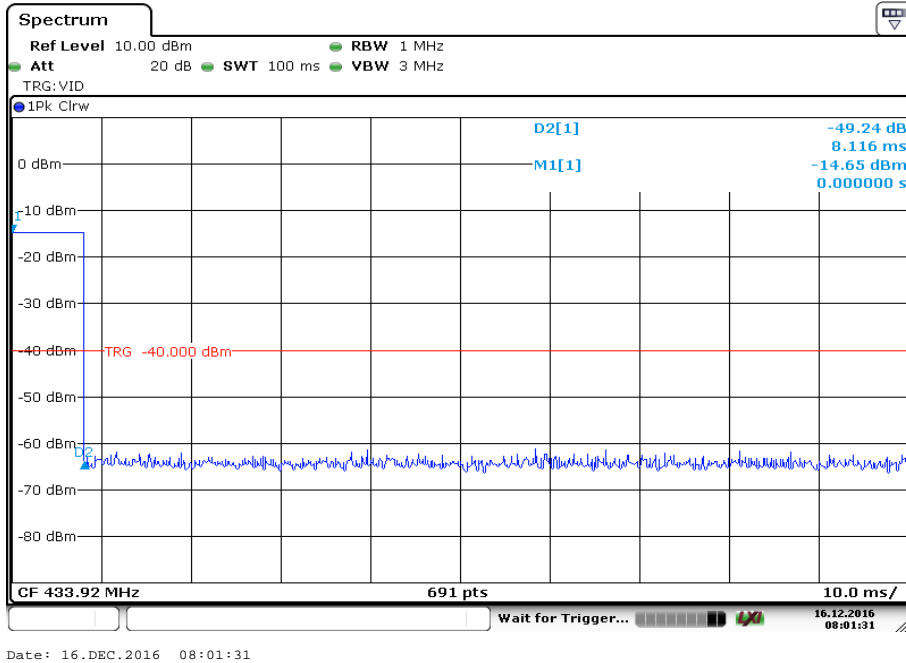

Transmit time (Tx on) = 8.1 ms @ 100 ms

The peak-to-average correction factor is calculated with $20\text{Log} [\text{Tx on}/(\text{Tx on} + \text{Tx off})]$.
 Hereby the peak-to-average correction factor is 21.83 dB

Plot 2: TX on time

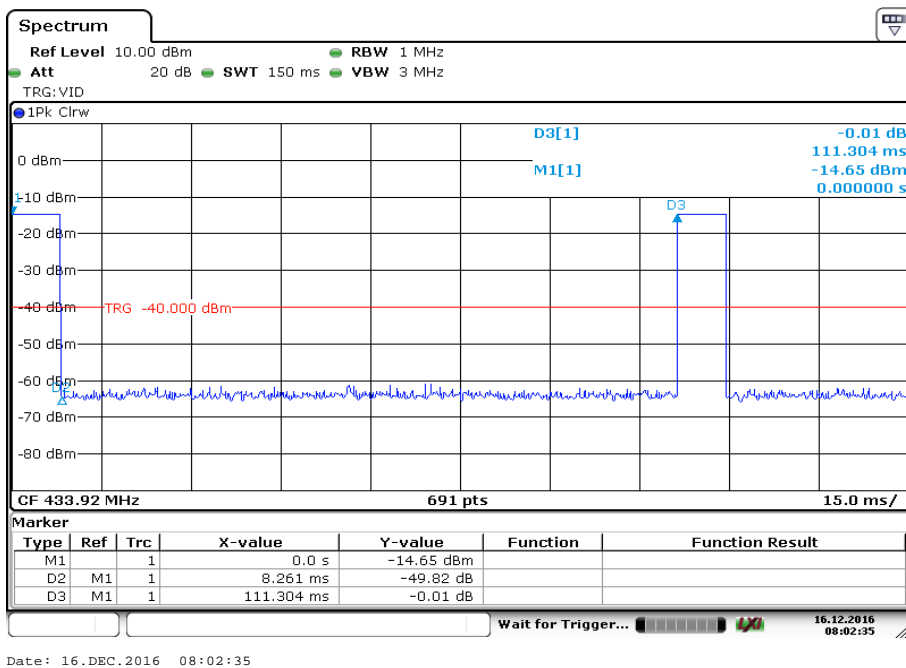

Plot 3: TX on time (4 bursts / 1 pulse train)

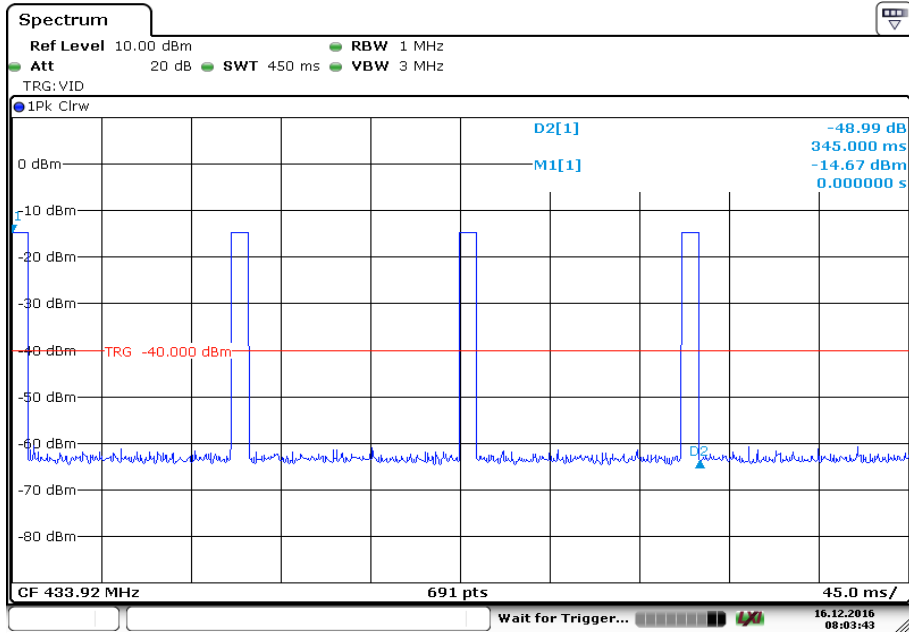

Date: 16.DEC.2016 08:03:43

Timing according to the technical document TPMS_Technical_Document_PMV-CE71_FCC向け-434MHz_P6差替_170117:

Rotating mode: §15.231 (e)

1 burst within 111.3 ms = 8.1 % (8.1 ms) correction factor: $20 \log (0.0942) = 21.83 \text{ dB}$

4 burst within 64 sec (every 111.3 ms) same correction factor

Minimum silent period: $64 \text{ sec} - (3 * 111.3 \text{ ms} + 8.1 \text{ ms}) = 64 \text{ sec} - 342 \text{ ms} = 63.658 \text{ ms}$

Limit: 1. > 30 times of the transmission = $30 * (3*111.3 \text{ ms} + 8.1 \text{ ms}) = 10.26 \text{ ms}$
 (only relevant if greater than 10 sec)
 2. > 10 sec

Rotating mode

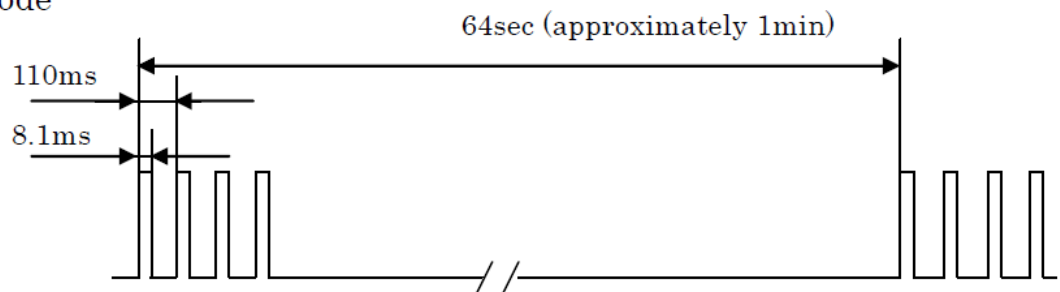

Stationary mode: §15.231 (e)

1 burst within 3840 sec = 8.1 % (8.1 ms) correction factor: $20 \log (0.081) = 21.83 \text{ dB}$

Minimum silent period: 3840 sec – 8.1 ms = **3839.9919 sec**

Limit: 1. > 30 times of the transmission = $30 * 8.1 \text{ ms} = 243 \text{ ms}$ (only relevant if greater than 10 sec)
2. > 10 sec

Stationary mode //

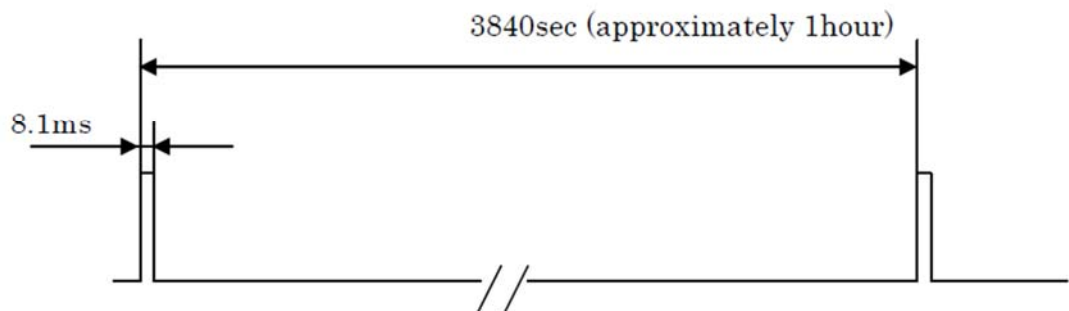

Pressure alert: §15.231 (a)

The device will only enter the pressure alert mode, if there is a rapid change in the tire pressure and therefore it is an automatically activated transmission and not a transmission at pre-determined intervals. Therefore, for the pressure alert mode falls under the requirements of section §15.231 (a):

Limit: A transmitter activated automatically shall cease transmission within 5 seconds after activation.

The pressure alert mode will transmit for a duration of 30 frames before returning to another mode:

Transmission length = $29 * 111.3 + 8.1 \text{ ms} = 3.236 \text{ s} < 5 \text{ s}$

Pressure alert

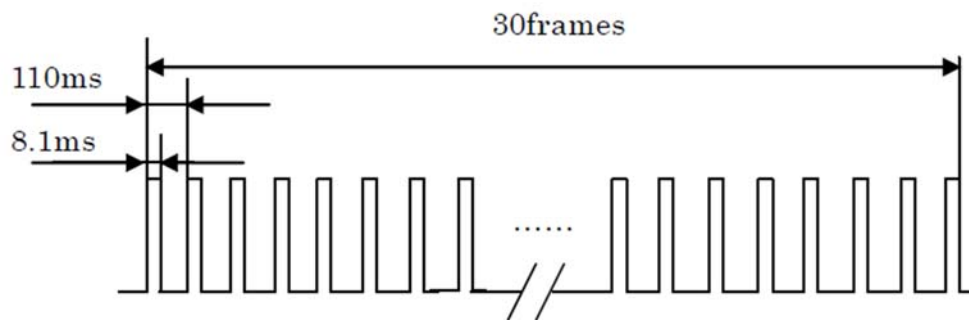

9.2 Emission bandwidth

Measurement:

Measurement of the 99 % bandwidth of the modulated signal

Measurement parameter	
Detector:	Peak
Sweep time:	200 ms
Resolution bandwidth:	1 % of the span (10 kHz)
Video bandwidth:	3 x RBW (30 kHz)
Span:	1 MHz
Trace mode:	Max. hold
Test setup:	See chapter 6.3 A

Limits:

FCC	IC
The OBW shall not be wider than 0.25% of the centre frequency, here maximum 787.5 kHz.	

Result:

Plot 1: Emissions bandwidth

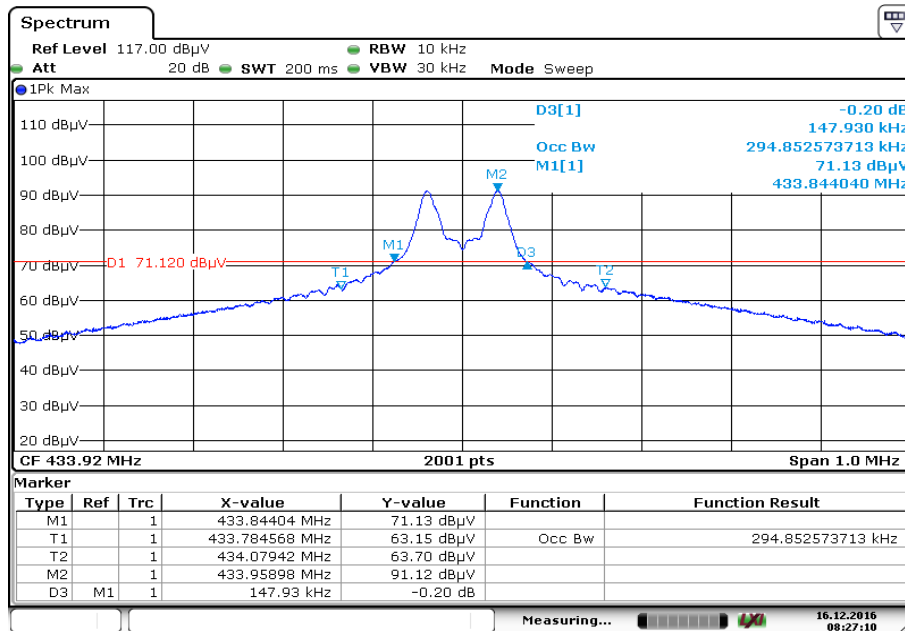

Date: 16.DEC.2016 08:27:10

99 % emission bandwidth: 295 kHz

20 dBc bandwidth: 148 kHz

9.3 Field strength of the fundamental

Measurement:

Measurement parameter	
Detector:	Peak / pulse averaging / quasi peak
Sweep time:	Auto
Resolution bandwidth:	120 kHz
Video bandwidth:	3 x RBW
Trace mode:	Max. hold
Test setup:	See chapter 6.2 A

Limits:

FCC		IC	
Field strength of the fundamental. In addition to the provisions of Section 15.205, the field strength of emissions from intentional radiators operated under this Section shall not exceed the following:			
Fundamental Frequency (MHz)	Field strength of Fundamental (µV/m)	Measurement distance (m)	
40.66 – 40.70	1,000	3	
70-130	500	3	
130-174	500 to 1,500	3	
174-260	1,500	3	
260-470	1,500 to 5,000	3	
Above 470	5,000	3	
433.92	4398.67 [72.87 dBµV/m]	3	
40.66 – 40.70	2,250	3	
70-130	1,250	3	
130-174	1,250 to 3,750	3	
174-260	3,750	3	
260-470	3,750 to 12,500	3	
Above 470	12,500	3	
433.92	10996.66 [80.83 dBµV/m]	3	

Result:

TEST CONDITIONS		Field strength (dBµV/m at 3 m distance)	
Frequency		MHz	MHz
Mode		Peak	Average
T _{nom}	V _{nom}	74.1	52.3*
Measurement uncertainty		±3dB	

*Value recalculated from Peak-to-Average correction factor calculated in 9.1

9.4 Field strength of the harmonics and spurious

Measurement:

Measurement parameter	
Detector:	Peak / average / quasi peak
Sweep time:	Auto
Resolution bandwidth:	200 Hz / 9 kHz / 120 kHz
Video bandwidth:	3 x RBW
Span:	See plots
Trace mode:	Max. hold
Test setup:	See chapter 6.1 A See chapter 6.2 B

Limits:

FCC		IC
Field strength of the fundamental. In addition to the provisions of Section 15.205, the field strength of emissions from intentional radiators operated under this Section shall not exceed the following:		
Fundamental Frequency (MHz)	Field strength of spurious (µV/m)	Measurement distance (m)
40.66 – 40.70	100 /225	3
70-130	50 / 125	3
130-174	50 to 150 125 to 375	3
174-260	150 / 375	3
260-470	150 to 500 375 to 1,250	3
Above 470	500 / 1,250	3

The maximum permitted unwanted emission level is 20 dB below the maximum permitted fundamental level. Spurious emissions shall be attenuated to the average (or, alternatively, CISPR quasi-peak) limits shown in this table or to the general limits shown in Section 15.209, whichever limit permits a higher field strength.

FCC		IC
Frequency (MHz)	Field strength (µV/m)	Measurement distance (m)
0.009 – 0.490	2400/F(kHz)	300
0.490 – 1.705	24000/F(kHz)	30
1.705 – 30	30	30
30 – 88	100	3
88 – 216	150	3
216 – 960	200	3
above 960	500	3

Results:

f [MHz]	Detector	Limit max. allowed [dBµV/m]	Amplitude of emission [dBµV/m]	Results
For emissions below 1 GHz, please look at the table below the 1 GHz plot.				
1301.76	Peak	74.0	45.7	compliant
	DC AVG	54.0	Peak below average limit.	-/-
1735.68	Peak	-/-	No restricted band!	No rated!
	DC AVG	-/-		
2169.60	Peak	-/-	No restricted band!	No rated!
	DC AVG	-/-		
2603.52	Peak	-/-	No restricted band!	No rated!
	DC AVG	-/-		
3037.44	Peak	-/-	No restricted band!	No rated!
	DC AVG	-/-		
3471.36	Peak	-/-	No restricted band!	No rated!
	DC AVG	-/-		
3905.28	Peak	74.0	51.2	compliant
	DC AVG	54.0	Peak below average limit.	-/-
4339.20	Peak	-/-	No restricted band!	No rated!
	DC AVG	-/-		

Plots:

Plot 1: 9 kHz to 30 MHz

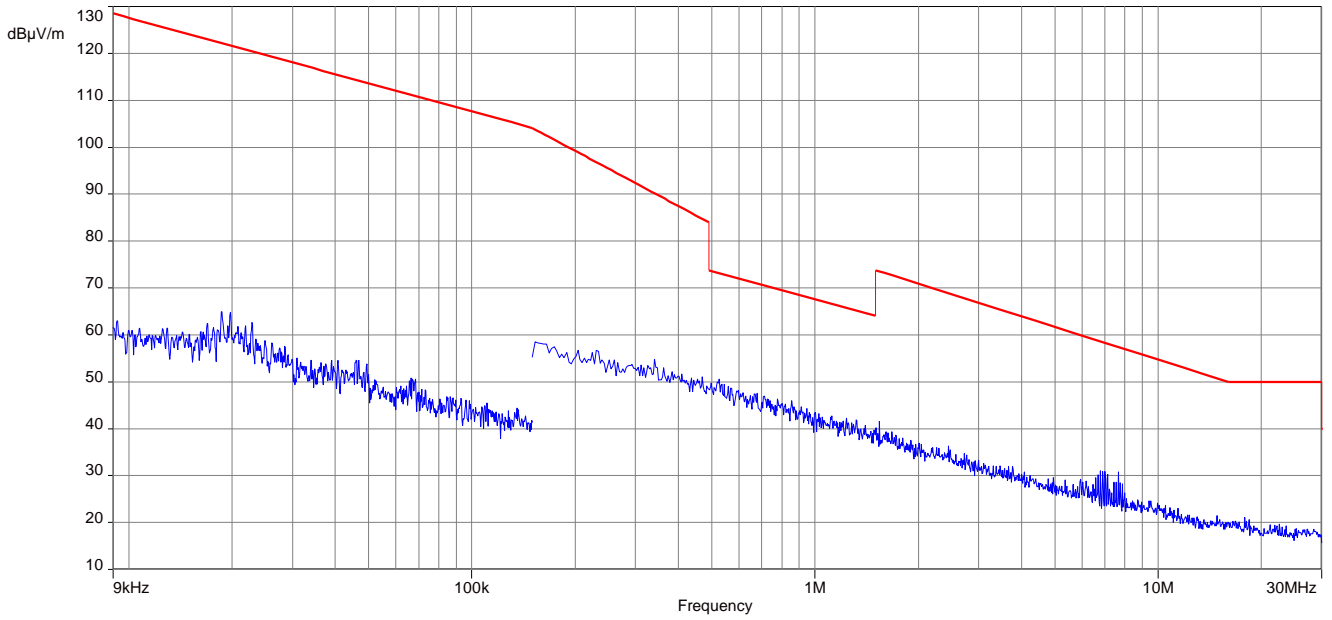

Plot 2: 30 MHz to 1000 MHz, vertical & horizontal polarisation

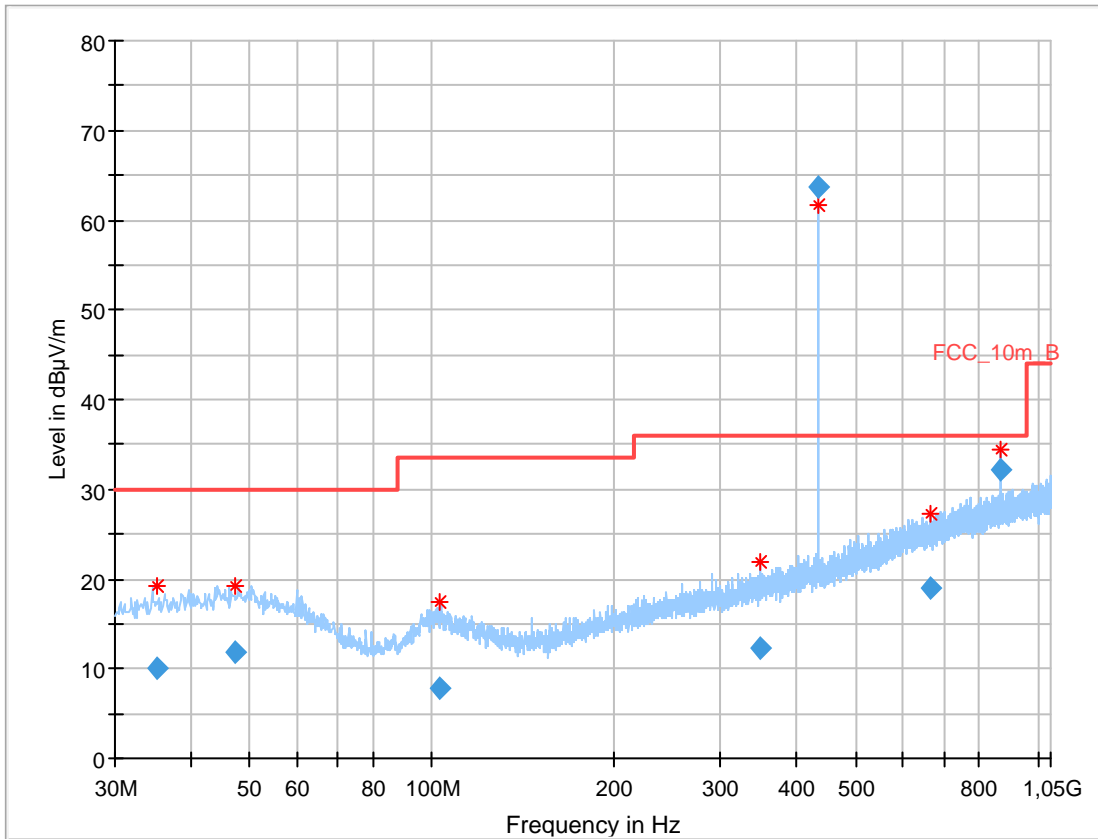

Final_Result:

Frequency (MHz)	QuasiPeak (dBµV/m)	Limit (dBµV/m)	Margin (dB)	Meas. Time (ms)	Bandwidth (kHz)	Height (cm)	Pol	Azimuth (deg)	Corr. (dB)
35.125200	9.96	30.00	20.04	1000.0	120.000	185.0	H	0.0	12.7
47.490450	11.78	30.00	18.22	1000.0	120.000	98.0	V	305.0	13.7
103.329150	7.85	33.50	25.65	1000.0	120.000	179.0	H	274.0	11.8
348.592950	12.35	36.00	23.65	1000.0	120.000	185.0	V	32.0	15.9
433.959750	63.65	36.00	-27.65	1000.0	120.000	98.0	V	132.0	17.4
662.876400	18.92	36.00	17.08	1000.0	120.000	185.0	V	59.0	21.2
867.767250	32.07	36.00	3.93	1000.0	120.000	101.0	H	202.0	23.8

Plot 3: 1000 MHz to 5000 MHz, vertical & horizontal polarisation

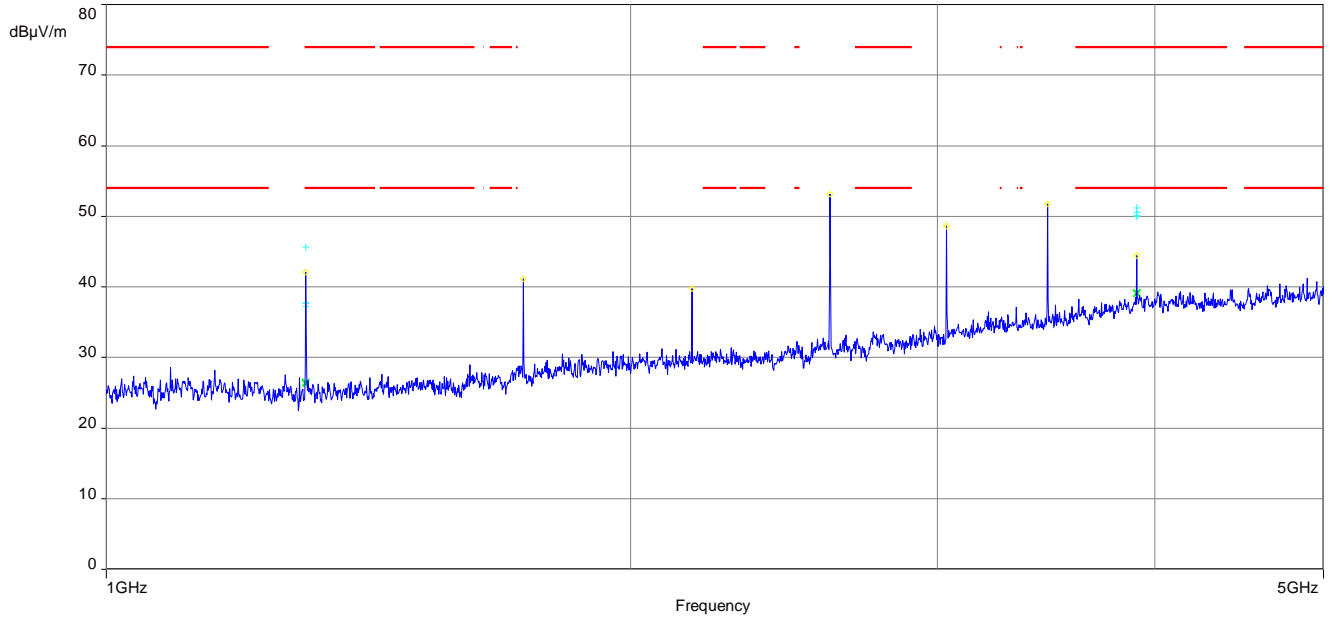

10 Observations

No observations except those reported with the single test cases have been made.

Annex A Document history

Version	Applied changes	Date of release
	Initial release	2016-12-20
A	Editorial changes & timing recalculated	2017-01-17
B	timing recalculated (pressure alert)	2017-01-19

Annex B Further information

Glossary

AVG	-	Average
DUT	-	Device under test
EMC	-	Electromagnetic Compatibility
EN	-	European Standard
EUT	-	Equipment under test
ETSI	-	European Telecommunications Standard Institute
FCC	-	Federal Communication Commission
FCC ID	-	Company Identifier at FCC
HW	-	Hardware
IC	-	Industry Canada
Inv. No.	-	Inventory number
N/A	-	Not applicable
PP	-	Positive peak
QP	-	Quasi peak
S/N	-	Serial number
SW	-	Software
PMN	-	Product marketing name
HMN	-	Host marketing name
HVIN	-	Hardware version identification number
FVIN	-	Firmware version identification number
OBW		Occupied Bandwidth
OC		Operating Channel
OCW		Operating Channel Bandwidth
OOB		Out Of Band

Annex C Accreditation Certificate

first page

last page



Deutsche Akkreditierungsstelle GmbH

Befehle gemäß § 8 Absatz 1 AkkStelleG i.V.m. § 1 Absatz 1 AkkStelleGBV
 Unterzeichnerin der Multilateralen Abkommen
 von EA, ILAC und IAF zur gegenseitigen Anerkennung

Akkreditierung



Die Deutsche Akkreditierungsstelle GmbH bestätigt hiermit, dass das Prüflaboratorium

CTC advanced GmbH
 Untertürkheimer Straße 6-10, 66117 Saarbrücken

die Kompetenz nach DIN EN ISO/IEC 17025:2005 besitzt, Prüfungen in folgenden Bereichen durchzuführen:

- Funk
- Mobilfunk (GSM / DCS) + OTA
- Elektromagnetische Verträglichkeit (EMV)
- Produktsicherheit
- SAR / EMF
- Umwelt
- Smart Card Technology
- Bluetooth*
- Automotive
- Wi-Fi-Services
- Kanadische Anforderungen
- US-Anforderungen
- Akustik
- Near Field Communication (NFC)

Die Akkreditierungsurkunde gilt nur in Verbindung mit dem Bescheid vom 25.11.2016 mit der Akkreditierungsnummer D-PL-12076-01 und ist gültig bis 17.01.2018. Sie besteht aus diesem Deckblatt, der Rückseite des Deckblatts und der folgenden Anlage mit insgesamt 63 Seiten.

Registrierungsnummer der Urkunde: D-PL-12076-01-01

Frankfurt, 25.11.2016

Im Auftrag Dipl.-Ing. Gregor Hoff Eigner
 Abteilungsleiter

Siehe Hinweise auf der Rückseite

Deutsche Akkreditierungsstelle GmbH

Standort Berlin
 Spittelmarkt 10
 10117 Berlin

Standort Frankfurt am Main
 Europa-Allee 52
 60327 Frankfurt am Main

Standort Braunschweig
 Bundesallee 100
 38116 Braunschweig

Die auszugsweise Veröffentlichung der Akkreditierungsurkunde bedarf der vorherigen schriftlichen Zustimmung der Deutsche Akkreditierungsstelle GmbH (DAkkS). Ausgenommen davon ist die separate Weiterverbreitung des Deckblatts durch die umeitig genannte Konformitätsbewertungsstelle in unveränderter Form.

Es darf nicht der Anschein erweckt werden, dass sich die Akkreditierung auch auf Bereiche erstreckt, die über den durch die DAkkS bestätigten Akkreditierungsbereich hinausgehen.

Die Akkreditierung erfolgte gemäß des Gesetzes über die Akkreditierungsstelle (AkkStelleG) vom 31. Juli 2009 (BGBl. I S. 2625) sowie der Verordnung (EG) Nr. 765/2008 des Europäischen Parlaments und des Rates vom 9. Juli 2008 über die Vorschriften für die Akkreditierung und Marktüberwachung im Zusammenhang mit der Vermarktung von Produkten (Abtl. L 218 vom 9. Juli 2008, S. 30). Die DAkkS ist Unterzeichnerin der Multilateralen Abkommen zur gegenseitigen Anerkennung der European co-operation for Accreditation (EA), des International Accreditation Forum (IAF) und der International Laboratory Accreditation Cooperation (ILAC). Die Unterzeichner dieser Abkommen erkennen ihre Akkreditierungen gegenseitig an.

Der aktuelle Stand der Mitgliedschaft kann folgenden Webseiten entnommen werden:
 EA: www.european-accreditation.org
 ILAC: www.ilac.org
 IAF: www.iaf.nu

Note:
 The current certificate including annex can be received on request.