

5. Marking location and layout

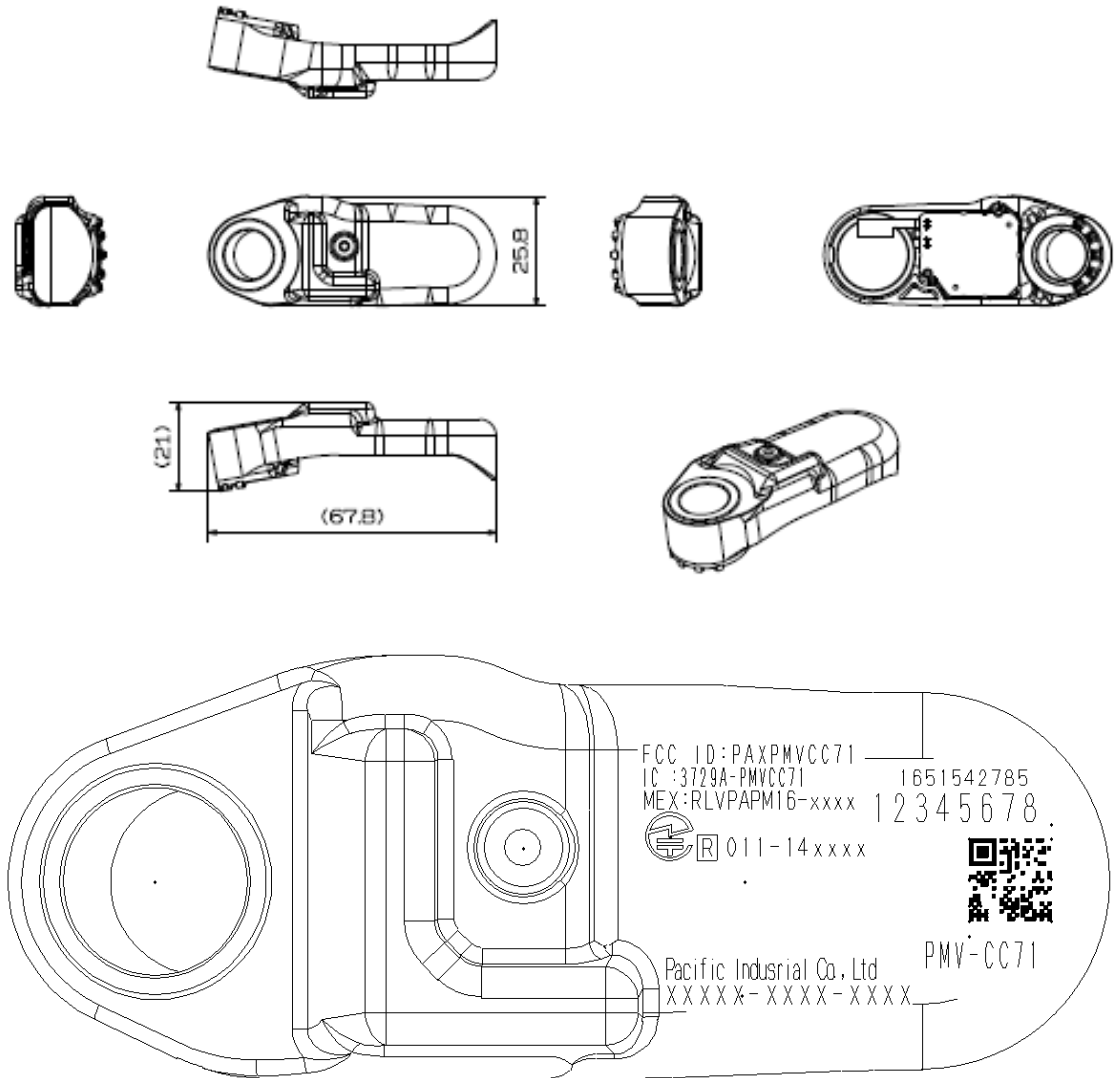

Notes: Compliance statement of marking will not be changed.
But marking layout and size may be changed.

Fig 5. Marking location and dimension

CONFIDENTIAL & PIC PROPRIETARY