

KANSAI ELECTRONIC INDUSTRY DEVELOPMENT CENTERHEAD OFFICE
6-8-7 NISHITENMA
KITA-KU OSAKA 530-0047 JAPAN

Corporate Juridical Person

IKOMA TESTING LABORATORY
12128 TAKAYAMA-CHO
IKOMA-CITY NARA 630-0101 JAPAN**TEST REPORT**Report No.A-017-05-C

Date: 27 December 2005

This test report is to certify that the tested device properly complies with the requirements of:

FCC Rules and Regulations Part 15 Subpart C Intentional Radiators.

All the tests necessary to show compliance to the requirements were performed and these results met the specifications of requirement. The results of this report should not be construed to imply compliance of equipment other than that, which was tested. Unless the laboratory permission, this report should not be copied in part.

1. Applicant

Company Name : Pacific Industrial Co., Ltd. TPMS DEPT.

Mailing Address : Godo-cho, Ampachi, GIFU, 503-2397

2. Identification of Tested DeviceType of Device : Transmitter
Kind of Equipment Authorization : : DoC : Certification : Verification
FCC ID : PAXPMV107L
Device Name : Tire Pressure Monitoring System Transmitter
Trade Name : PACIFIC
Model Number : PMV-107L
Serial Number : No.1 : Production : Pre-production : Prototype
Date of Manufacture : September 2005**3. Test Items and Procedure**: AC Power Line Conducted Emission Measurement
: Radiated Emission Measurement
: Emission Bandwidth Measurement

Above all tests were performed under: ANSI C63.4 – 2003

: without deviation, : with deviation (details are found inside of this report)**4. Date of Test**

Receipt of Test Sample : 20 December 2005

Condition of Test Sample : : Damage is not found on the set.: Damage is found on the set. (Details are described in this report)

Test Completed on : 20 December 2005

Seiichi Izumi
General Manager / Ikoma Testing Laboratory

Table of Contents

0. LABORATORY ACCREDITATION AND MEASUREMENT UNCERTAINTY	3
0.1. Laboratory Accreditation.....	3
0.2. Measurement Uncertainty	3
1. CERTIFICATION OF THE COMPLIANCE	3
2. GENERAL INFORMATION	4
2.1. Product Description.....	4
2.2. Description for Equipment Authorization	5
2.3. Test Facility	5
3. TESTED SYSTEM.....	6
3.1. Test Mode	6
3.2. Characteristics of transmitting train	6
3.3. Characterization and condition of EUT System	8
4. RADIATED EMISSION MEASUREMENT	9
4.1. Test Procedure	9
4.2. Test Results	10
5. EMISSION BANDWIDTH MEASUREMENT	17
5.1. Test Configuration.....	17
5.2. Test Results	17
6. USED TEST EQUIPMENTS AND CALIBRATION STATUS	19

0. LABORATORY ACCREDITATION AND MEASUREMENT UNCERTAINTY

0.1. Laboratory Accreditation

KEC is accredited by the National Voluntary Laboratory Accreditation Program (NVLAP) for the specific scope of accreditation under Lab Code: 200207-0.

When the test report concerns with the NVLAP accreditation test, the first page of the test report is signed by NVLAP Approved Signatory accompanied by the NVLAP logo.

The report must not be used by the client to claim product endorsement by NVLAP or any agency of the U.S. Government.

0.2. Measurement Uncertainty

The result of a measurement is only an approximation or estimate of the value of a specific quantity. And thus the measured is complete only when a statement of uncertainty is given.

KEC quotes Measurement Uncertainty (U)
of +/- 4.9dB for Radiated Emissions
of +/- 2.2dB for Conducted Emissions

1. CERTIFICATION OF THE COMPLIANCE

This test report is to certify that the tested device properly complies with the requirements of FCC Rules and Regulations Part 15 Subpart C Intentional Radiators.

2. GENERAL INFORMATION

2.1. Product Description

The PACIFIC Model No.: PMV-107L (referred to as the EUT in this report) is a Tire Pressure Monitoring System Transmitter for cars.

1) Technical Specifications

Operating frequency range	: 315.00MHz
Type of antenna	: Internal Antenna
Type of Emission	: A1A

2) Contained Oscillators

SAW	: 315.00MHz
-----	-------------

3) Rated Power Supply : DC3V (Lithium battery)

2.2. Description for Equipment Authorization

(1) Type of device	: <input checked="" type="checkbox"/> Intentional Radiators
(2) Reference Rule and Specification	: FCC Rule Part 15 Subpart C, Section 15.231 Periodic operation in the band 40.66 – 40.70MHz and above 70MHz <input type="checkbox"/> Section 15.207 <input checked="" type="checkbox"/> Section 15.209 <input checked="" type="checkbox"/> Section 15.231 (c) <input checked="" type="checkbox"/> Section 15.231 (e)
(3) Kind of Equipment Authorization	: <input type="checkbox"/> DoC <input checked="" type="checkbox"/> Certification <input type="checkbox"/> Verification
(4) Procedure of Application	: <input type="checkbox"/> Original Equipment <input checked="" type="checkbox"/> Modification
(5) Highest Frequency used in the Device	: 314.98MHz
(6) Upper Frequency of Radiated Emission Measurement Range	: <input type="checkbox"/> 1000MHz <input type="checkbox"/> 2000MHz <input type="checkbox"/> 5000MHz <input checked="" type="checkbox"/> Tenth harmonics of the highest fundamental frequency

2.3. Test Facility

All tests described in this report were performed by:	
Name:	KANSAI ELECTRONIC INDUSTRY DEVELOPMENT CENTER (KEC) IKOMA TESTING LABORATORY
Open Area Test Site	<input type="checkbox"/> No.1 <input type="checkbox"/> No.4
Anechoic Chamber	<input type="checkbox"/> No.1 <input checked="" type="checkbox"/> No.3
Shielded Room	<input type="checkbox"/> No.1 <input type="checkbox"/> No.2 <input type="checkbox"/> No.4 <input type="checkbox"/> No.6
Address:	12128, Takayama-cho Ikoma-city, Nara, 630-0101 Japan
<p>These test facilities have been filed with the FCC under the criteria of ANSI C63.4-2003. The KEC has been accredited by the NVLAP (Lab. Code: 200207-0) based on ISO/IEC 17025. Also the laboratory has been authorized by TUV Product Service (GER) and TUV Rheinland (GER) based on their criteria for testing laboratory (ISO/IEC 17025). EMC M.C. Anechoic Chamber No.3 has been filed with the Industry Canada under the criteria of RSS212, issue 1. (File number : IC4149-3)</p>	

3. TESTED SYSTEM

3.1. Test Mode

Continuously transmitted mode.

[Note]

The EUT was operated continuously in measurement. In the measurement of radiated emission.

The EUT was placed horizontally or vertically on the test table.

The data of operation modes that produce the maximum emission were reported at each frequency.

3.2. Characteristics of transmitting train

The transmission of EUT is less than 1.0 second and the intervals are greater than 10 seconds.
 See plot figure 1.

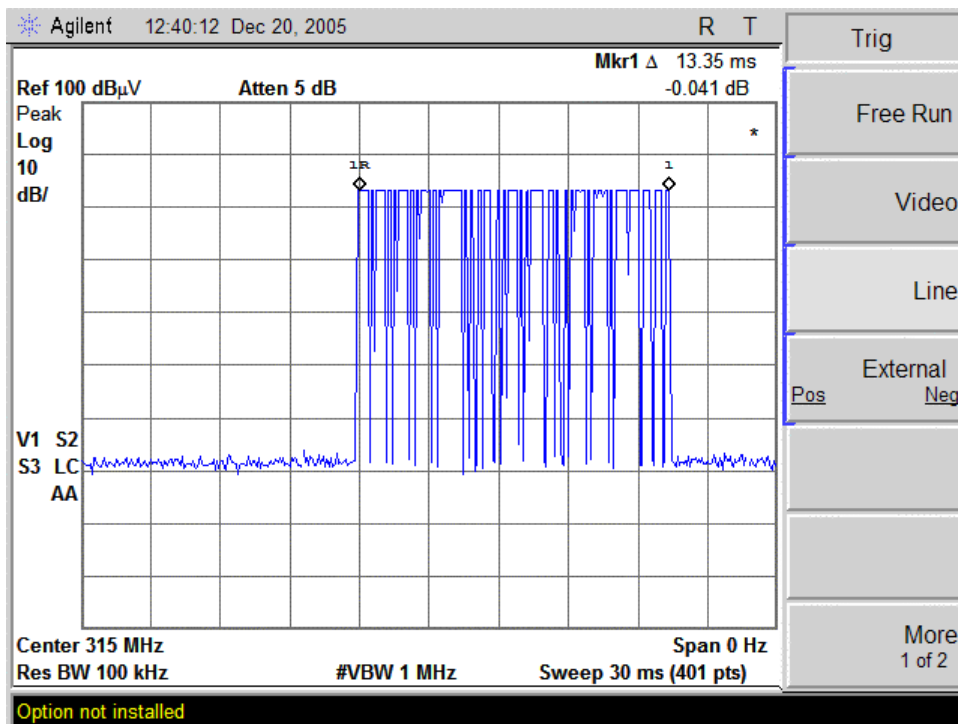

Figure 1. normal transmission

- Continued -

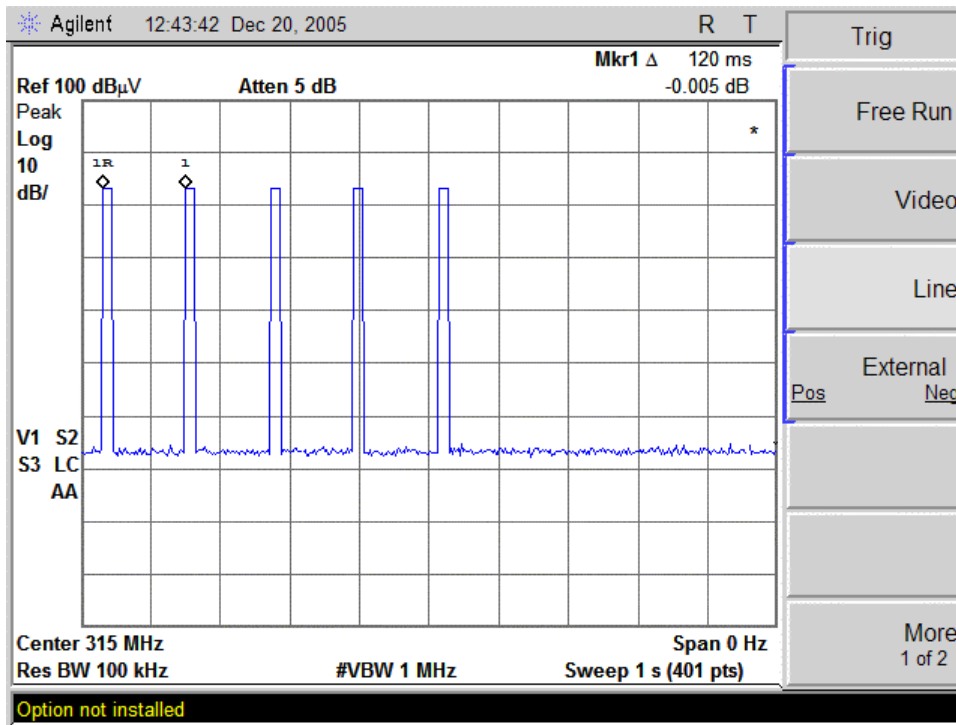

Figure 2. Alert status transmission 1

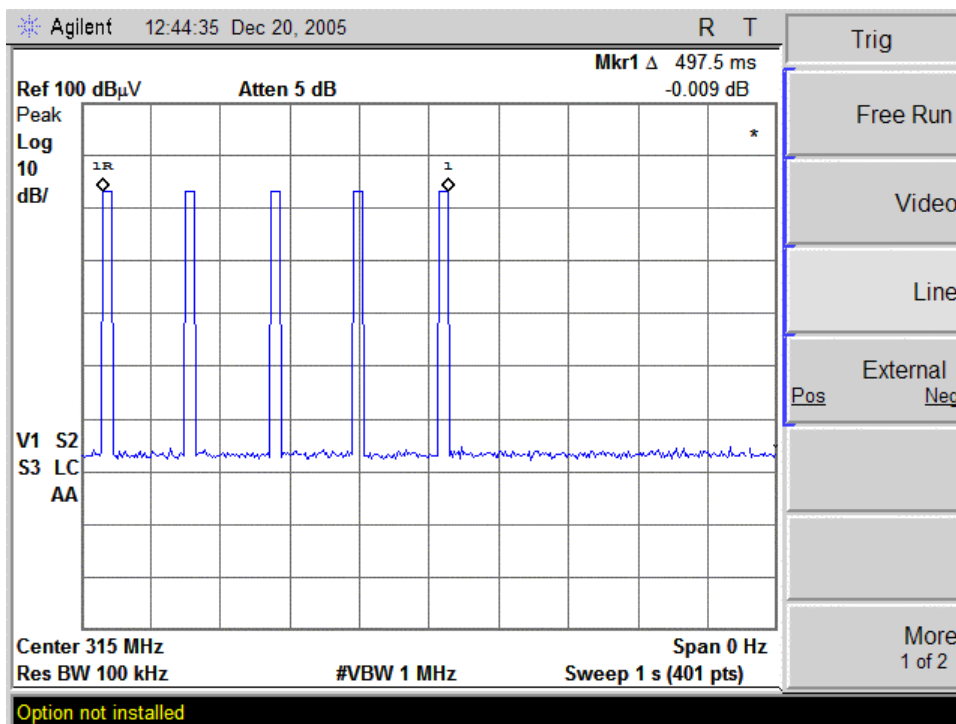

Figure 3. Alert status transmission 1

- Continued -

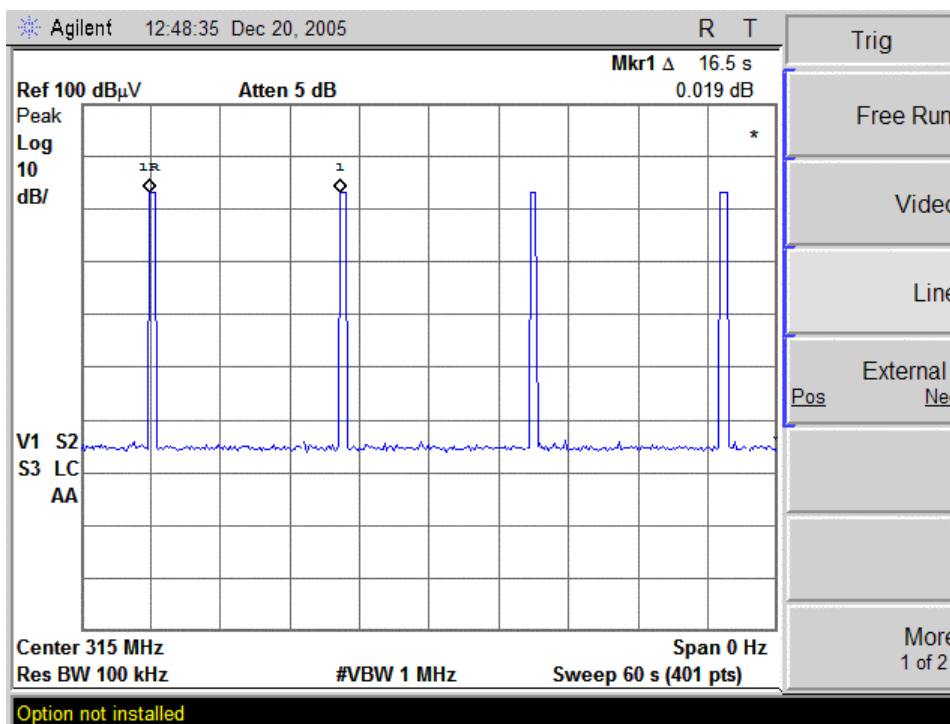

Figure 4. Transmission interval

[Note]

- (1) In figure 3, the duration of each transmission is not greater than one second.
- (2) In figure 4, the silent period between transmissions shall be at least 30 times the duration of the transmission but in no case less than 10 seconds.

3.3. Characterization and condition of EUT System

: normal, : not normal (that is)

4. RADIATED EMISSION MEASUREMENT

4.1. Test Procedure

- (1) Configure the EUT System in accordance with ANSI C63.4-2003 section 8.
: without deviation, : with deviation (details are found below)
 See also the block diagram and the photographs of EUT System configuration in this report.
- (2) If the EUT system is connected to a public power network, all power cords for the EUT System are connected the receptacle on the turntable.
- (3) Warm up the EUT System.
- (4) Activate the EUT System and run the prepared software for the test, if necessary.
- (5) To find out the emissions of the EUT System, preliminary radiated measurement are performed at a closer distance than that specified for final radiated measurement using the spectrum analyzer (*1) and the broad band antenna.
 In the frequency above 1GHz, it is performed using the spectrum analyzer (*2) and the horn antenna.
- (6) To find out an EUT System condition, which produces the maximum emission, the configuration of EUT System, the position of the cables, and the operation mode, are changed under normal usage of the EUT.
- (7) The spectrums are scanned from 30MHz to the upper frequency of measurement range, and collect the six highest emissions minimum on the spectrum analyzer relative to the limits in the whole range.
- (8) In final compliance test, the six highest emissions minimum, recorded above, are measured at the specified distance using the broad band antenna or the tuned dipole antenna and the test receiver (*3).
 In the frequency above 1GHz, the measurements are performed by the horn antenna and
 the test receiver (*4).
 the spectrum analyzer (*2) with pre-amplifier.

[Note]

(*1) Spectrum Analyzer Set Up Conditions

Frequency range : 30 – 1000MHz
 Resolution bandwidth : 100kHz
 Detector function : Peak mode

(*2) Spectrum Analyzer Set Up Conditions

Frequency range : 1GHz – Upper frequency of measurement range
 Resolution bandwidth : 1MHz
 Video bandwidth : 1MHz
 Attenuator : 10dB
 Detector function : Peak mode

(*3) Test Receiver Set Up Conditions

Detector function : Quasi – Peak or Peak
 IF bandwidth : 120kHz

(*4) Test Receiver Set Up Conditions

Detector function : Average
 IF bandwidth : 1MHz

4.2. Test Results

Measurement Distance : 3m : 10m

Measured Frequency (MHz)	Antenna Factor (*1) (dB/m)	Conversion Factor (*2) (dB)	Meter Reading		Maximum Field Strength (dBμV/m)	Limit		Margin for Limit (dB)
			Horizontal Polarization (dBμV)	Vertical Polarization (dBμV)		Peak (dBμV/m)	Average (dBμV/m)	
[Peak Detector Measurement]								
[Fundamental]								
314.94	20.9	-	60.7	55.2	81.6	87.7	67.7	6.1
[Harmonics]								
629.89	26.9	-	17.6	12.4	44.5	67.7	47.7	23.2
945.00	31.3	-	9.1	5.6	40.4	67.7	47.7	27.3
[Average Detector Measurement]								
[Fundamental]								
314.94	20.9	-23.1	60.7	55.2	58.5	-	67.7	9.2
[Harmonics]								
629.89	26.9	-23.1	17.6	12.4	21.4	-	47.7	26.3
945.00	31.3	-23.1	9.1	5.6	17.3	-	47.7	30.4

[Note]

The restrict band data below 1GHz, see the figure 5. 30 – 1000MHz spectrum chart.

- Continued -

Restricted Band Above 1GHz

Measured Frequency (MHz)	Antenna Factor (*1) (dB/m)	Conversion Factor (*2) (dB)	Meter Reading		Maximum Field (dB μ V/m)	Limit		Margin for Limit (dB)
			Horizontal Polarization (dB μ V)	Vertical Polarization (dB μ V)		Peak (dB μ V/m)	Average (dB μ V/m)	
[Peak Detector Measurement]								
[Harmonics]								
1259.75	-12.4	-	53.8	53.1	41.4	74.0	54.0	32.6
1574.76	-12.2	-	71.2	66.7	59.0	74.0	54.0	15.0
1889.55	-10.7	-	63.1	61.6	52.4	74.0	54.0	21.6
2204.06	-10.4	-	55.2	55.1	44.8	74.0	54.0	29.2
2519.63	-9.9	-	47.2	47.6	37.7	74.0	54.0	36.3
2834.57	-9.3	-	46.4	46.4	37.1	74.0	54.0	36.9
3149.71	-8.6	-	<45.0	<45.0	<36.4	74.0	54.0	>37.6
[Average Detector Measurement]								
[Harmonics]								
1259.75	-12.4	-23.1	50.8	50.0	15.3	-	54.0	38.7
1574.76	-12.2	-23.1	71.2	66.7	35.9	-	54.0	18.1
1889.55	-10.7	-23.1	62.2	60.9	28.4	-	54.0	25.6
2204.06	-10.4	-23.1	53.9	53.5	20.4	-	54.0	33.6
2519.63	-9.9	-23.1	42.0	42.6	9.6	-	54.0	44.4
2834.57	-9.3	-23.1	<40.0	40.0	7.6	-	54.0	46.4
3149.71	-8.6	-23.1	<40.0	<40.0	<8.3	-	54.0	>45.7

Test data in Graph

RADIATED EMISSION

Date : 2005/Dec/20 10:30:23

KEC No. : A-017-05-C	Reference No. : FCC Paer15 Subpart C
Model No. : PMV-107L	Power Supply : DC:3V(Lithium battery)
Serial No. : No. 1	Temp/Humi : 20°C, 40%
Test Condition :	Operator : H. Matsuyama

Memo :

LIMIT :

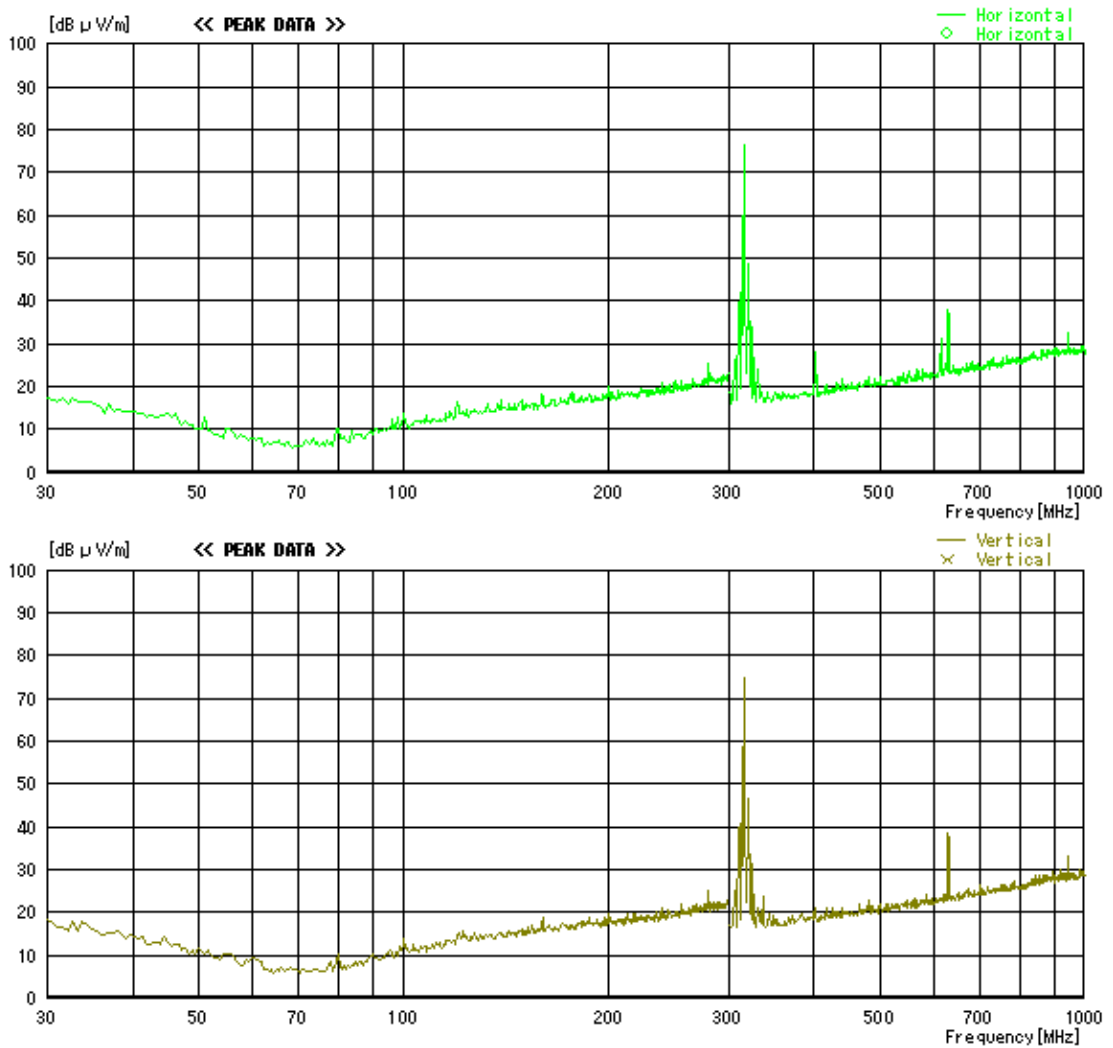

Figure 5. 30 – 1000MHz spectrum chart

[Note]

This spectrum chart is the result of Exploratory radiated emission measurement by using the spectrum analyzer. The result of Final radiated emission measurement is shown in the table of previous page.

- Continued -

<p>[Remark]</p> <p>(*1) : Antenna Factor includes the cable loss, above 1GHz, antenna factor includes both of the cable loss and pre-amplifier gain.</p> <p>(*2) : Conversion Factor, See figure 6 and 9 (the picture of spectrum analyzer) and See Page 14, Calculation of Conversion Factor (Peak detector to Average).</p> <p>(*3) : If the measurement value with the peak detector meets the average limits, the measurement with average detector is omitted.</p> <p>In FCC rule, the limit of measurement of radiated emission above 1GHz is regulated on the average value. Therefore, the average value above 1GHz was determined by using a reduced the video bandwidth of spectrum analyzer to obtain the average value in this case spectrum analyzer set up condition.</p> <p>Resolution Bandwidth : 1MHz Video Bandwidth : 30Hz Detector function : Peak detector</p> <p>[Note]</p> <p>(1) * mark in Measured Frequency : Measured with the tuned dipole antenna. No mark in Measured Frequency : Measured with the broadband antenna.</p> <p>(2) All emission not reported were less than 10dBμV at meter reading.</p>
<p>[Calculation method]</p> <p>Maximum Field Strength (dBμV/m) = Meter Reading (at maximum level of Horizontal or Vertical) (dBμV) + Antenna Factor (dB/m)</p> <p>[Calculation of Limit (Average detector)]</p> <p><u>Fundamental</u> L = 20log (16.667 \times F - 2833.333) Where, L: Limit [dBμV/m], F: Frequency [MHz] L = 67.7 [dBμV/m] at F=314.95[MHz]</p> <p><u>Spurious Emission</u> L = 67.7 - 20 = 47.7 [dBμV/m] Above 1000 MHz, the limit is replaced at 54 dBμV/m.</p>

[Environment]

Temperature: 20°C

Humidity: 40%

[Tested Date / Tester]

20 December 2005

Signature



Hironobu Matsuyama

- Continued -

[Calculation of Conversion Factor (Peak detector to Average)]

In accordance with ANSI C63.4-2003 section 13.1.4.2, The EUT's transmitting pulse modulated emissions, therefore the average level of emissions are found by measuring peak level of the emission and correcting them with the duty cycle.

From Figure 6.

The value of the sum of the pulse widths in one period : 6.98 [msec]

[Note] : $0.49 \text{ [msec]} \times 2 + 0.12 \text{ [msec]} \times 38 + 0.24 \text{ [msec]} \times 6 = 6.98 \text{ [msec]}$

The length of the period : 100.0 [msec]

As the EUT pulse train exceeds 100ms, calculate the duty cycle by averaging the sum of the pulse widths over the width with the highest average value.

Then, Conversion Factor PEAK to AVERAGE is calculated as follows.

$$\begin{aligned} \text{Conversion Factor} & & & 6.98 \text{ [msec]} \\ \text{PEAK to AVERAGE} & (\text{dB}) = 20 \text{ Log (Duty cycle) } = 20 \text{ Log} & \frac{\quad}{100.0 \text{ [msec]}} \\ & = -23.1 \text{ (dB)} \end{aligned}$$

$$\text{Duty cycle} = \frac{\text{The value of the sum of the pulse widths in one period } \sum_{n=1}^n t_n}{\text{The length of period (T)}}$$

[Sample Calculation at conversion Peak to Average]

Field Strength (dB μ V/m)

= Meter Reading (at Maximum level of horizontal or vertical) (dB μ V)
+ Antenna Factor (dB/m) + Conversion Factor (dB)

- Continued -

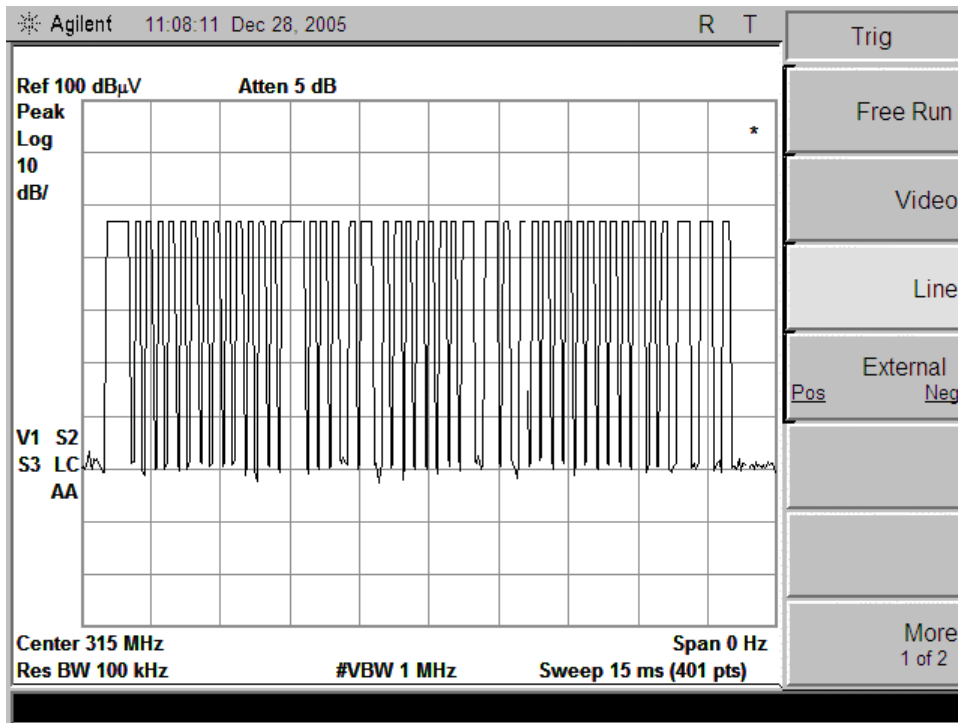

Figure 6

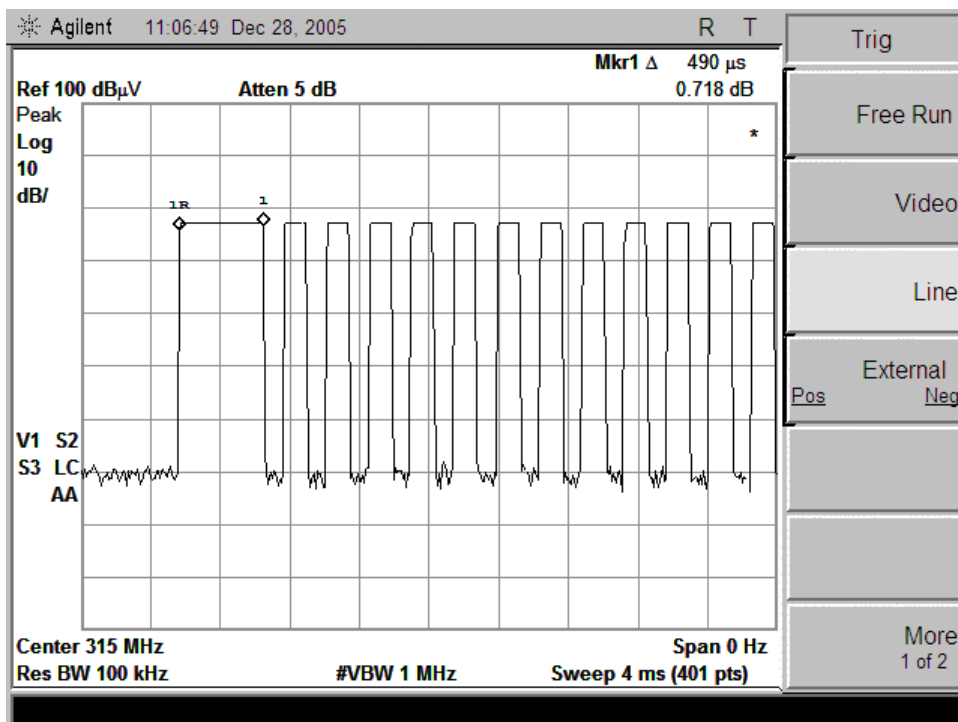

Figure 7

- Continued -

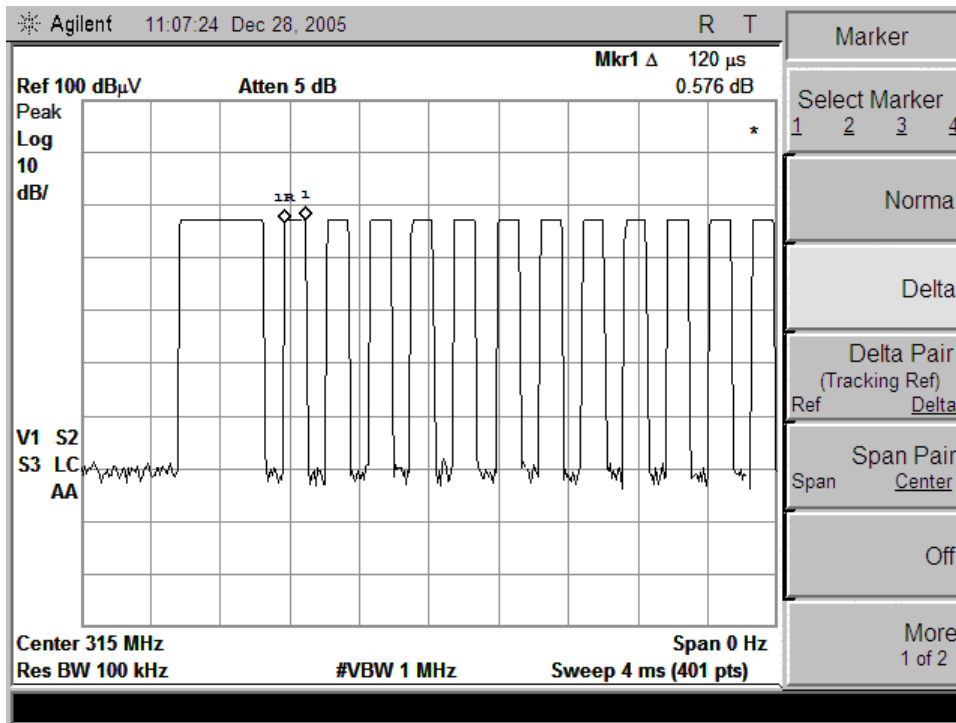

Figure 8

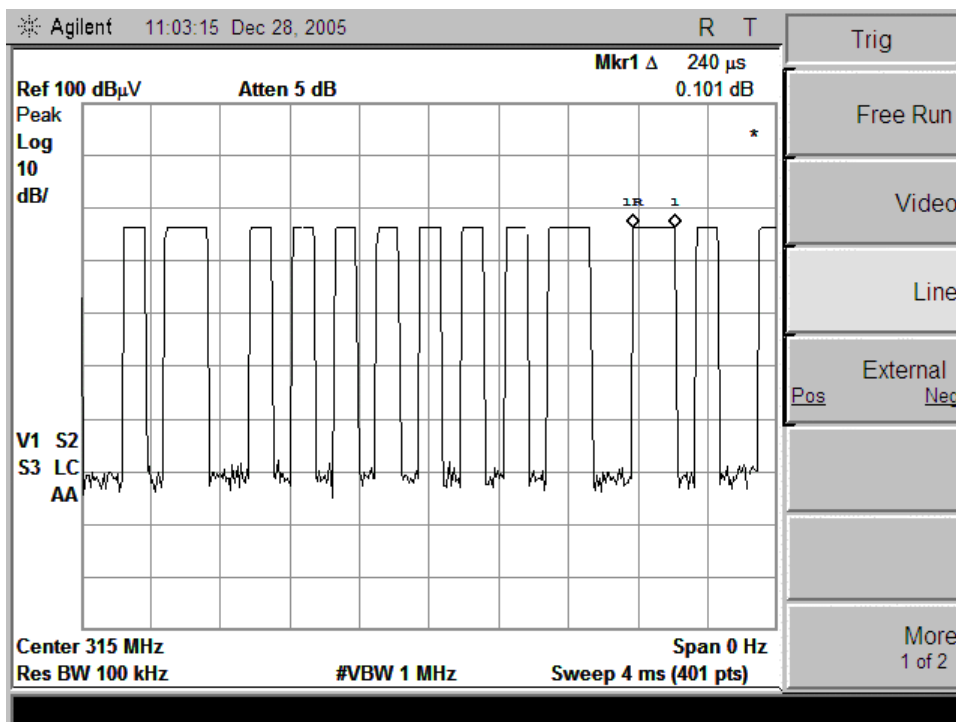
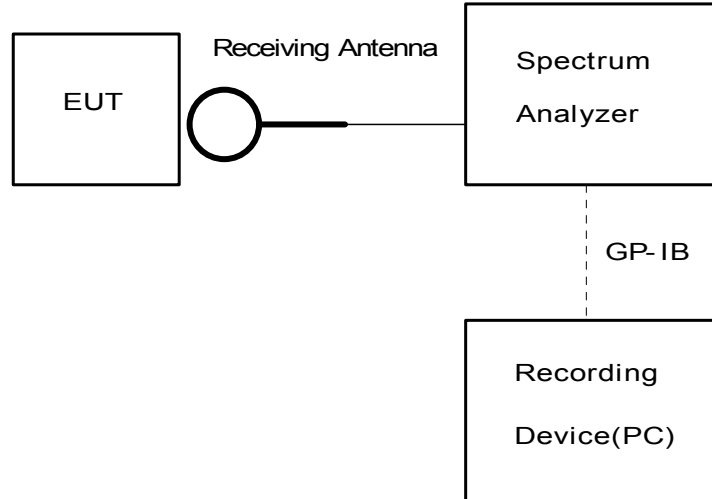

Figure 9

5. EMISSION BANDWIDTH MEASUREMENT

5.1. Test Configuration



5.2. Test Results

Measured emission bandwidth = 370kHz
 See next Figure 8 (the picture of spectrum analyzer)

[Note]

Emission Bandwidth was determined at the points 20dB down from the modulated carrier.

Spectrum Analyzer Setting:

Center Frequency = 315.00MHz
 Frequency Span = 200kHz/div.
 Resolution Bandwidth = 100kHz
 Video Bandwidth = 100kHz
 Sweep Time = 5m sec
 Trace Mode : MAX. HOLD

[Environment]

Temperature: 20°C Humidity: 40%

[Calculation of Limit]

Limit of Emission bandwidth = 315.00MHz × 0.25% = 787.50kHz

[Tested Date / Tester]

20 December 2005

Signature

Hironobu Matsuyama

- Continued -

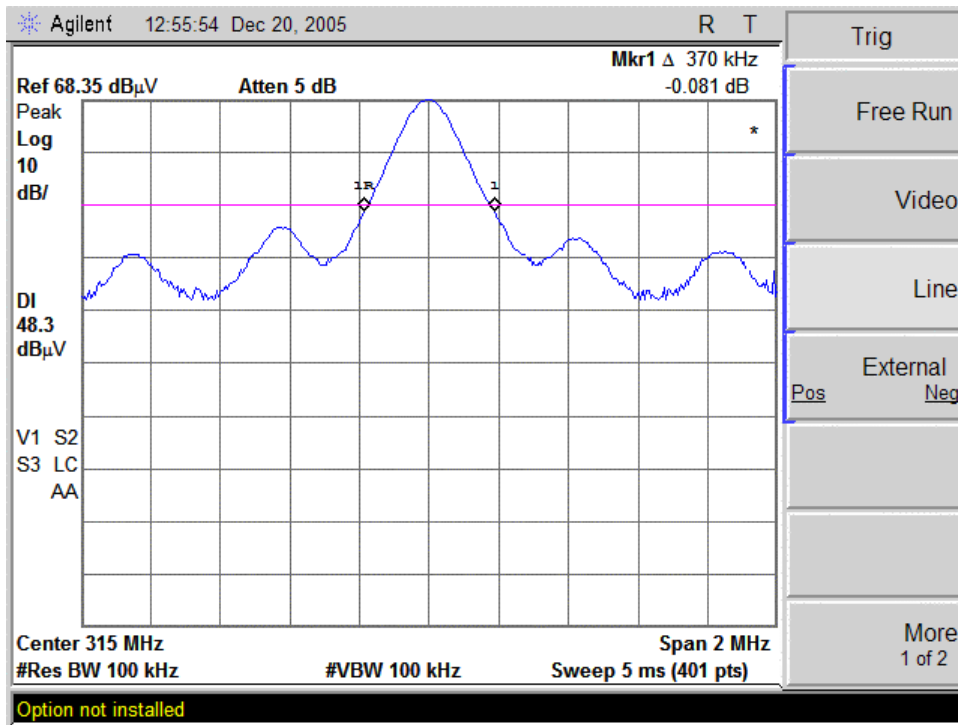

Figure 10

6. USED TEST EQUIPMENTS AND CALIBRATION STATUS

Equipment	Manufacturer	Model No.	Specifications	KEC Control No.	Test Item (*)	Last Cal.	Next Cal.
Test Receiver	Rohde & Schwarz	ESHS10	Frequency Range 9kHz – 30MHz	FS-83	N/A	2005/2	2006/2
		ESVS10	Frequency Range 20MHz – 1.0GHz	FS-66	2	2005/3	2006/3
Spectrum Analyzer	Hewlett Packard	8564E	Frequency Range 30Hz – 40GHz	SA-39	2,3	2005/4	2006/4
Pre-amplifier	Hewlett Packard	8449B	Frequency Range 1GHz – 26.5GHz	AM-52	2	2005/2	2006/2
Biconical Antenna	Schwarzbeck	BBA9106	Frequency Range 30MHz – 300MHz	AN-180	2	2005/2	2006/2
Log-Periodic Antenna	Schwarzbeck	UHALP9108A	Frequency Range 300MHz – 1GHz	AN-215	2	2005/2	2006/2
Tuned Dipole Antenna	Kyoritsu	KBA-511AS	Frequency Range 25MHz – 500MHz	AN-135	2	2005/2	2007/2
		KBA-611S	Frequency Range 500MHz – 1GHz	AN-137	2	2005/2	2007/2
Horn Antenna	Raven	91888-2	Frequency Range 1GHz – 2GHz	AN-211	2	2005/10	2007/10
		91889-2	Frequency Range 2GHz – 5GHz	AN-212	2	2005/10	2007/10
LISN for EUT	Kyoritsu	KNW-407	Frequency Range 150kHz – 30MHz	FL-107	N/A	2005/7	2006/7
LISN for Peripheral	Kyoritsu	KNW-242	Frequency Range 10kHz – 30MHz	FL-110	N/A	2005/7	2006/7

[Note]

Test Item (*): 1: Conducted Emission Measurement
 2: Radiated Emission Measurement
 3: Bandwidth Measurement
 N/A: Not Applicable

The overall program of calibration and verification of equipment is designed and operated so as to ensure that measurements made by KEC are traceable to national standards of measurement or equivalent abroad.