



TEST REPORT

Report Number : A-001-12-C

Date of Issue: 21 September 2012

FCC Rules and Regulations Part 15 Subpart C Intentional Radiators.

This test report is to certify that the device was tested according to the requirements of the above.
The results of this report should not be construed to imply compliance of devices other than the sample tested.
Without the laboratory approval by the documents, this report should not be copied in part.

1. Applicant

Company Name : PACIFIC Industrial Co., Ltd.
Mailing Address : Godo cho, Anpachi, Gifu 503-2397 JAPAN

2. Identification of Tested Device

Type of Device : Transmitter
FCC ID : PAXPMV107J
Device Name : TPMS
Model Number : PMV-107J
Serial Number : N3
Trade Name : PACIFIC
Type of Test : Production Pre-production Prototype

3. Test Items

AC Power Line Conducted Emission Measurement	<input type="checkbox"/> Pass	<input type="checkbox"/> Fail	<input checked="" type="checkbox"/> N/A(*1)
Radiated Emission Measurement	<input checked="" type="checkbox"/> Pass	<input type="checkbox"/> Fail	<input type="checkbox"/> N/A
Emission Bandwidth Measurement	<input checked="" type="checkbox"/> Pass	<input type="checkbox"/> Fail	<input type="checkbox"/> N/A

Refer the below reason(s) with respect to the decision and justification not to test.

(*1) EUT Specifications (*2) Request of Applicant (*3) According to Test Plan

KEC Electronic Industry Development Center Testing Division
3-2-2, Hikari-dai, Seika-cho, Soraku-gun, Kyoto 619-0237 Japan

Test Engineer(s)

Naoki Norimoto

Approved by Ikuya Minematsu / Group Manager



Table of Contents

1. LABORATORY INFORMATION..... 3
1.1. Laboratory Accreditation..... 3
1.2. Test Facility..... 3
1.3. Measurement Uncertainty..... 3

2. GENERAL INFORMATION 4
2.1. Product Description..... 4

3. TESTED SYSTEM..... 4
3.1. Reference Rule and Specification 4
3.2. Date of Test 4
3.3. Deviation of Standard..... 4
3.4. Test Mode 5
3.5. Characteristics of transmitting train 5

4. RADIATED EMISSION MEASUREMENT 8
4.1. Test Procedure 8
4.2. Test Results 9

5. EMISSION BANDWIDTH MEASUREMENT..... 13
5.1. Test Configuration..... 13
5.2. Test Results 13

6. TEST EQUIPMENT 15



1. LABORATORY INFORMATION

1.1. Laboratory Accreditation

The KEC has been accredited by the following organizations based on their criteria for testing laboratory (ISO/IEC 17025).

- | | |
|---|----------------------------------|
| (1) American Association for Laboratory Accreditation (A2LA) | : Accreditation Number: 2070.01 |
| (2) Japan Accreditation Board for Conformity Assessment (JAB) | : Accreditation Number: RTL02810 |
| (3) Voluntary EMC Laboratory Accreditation Center Inc. (VLAC) | : Accreditation Number: VLAC-005 |

1.2. Test Facility

All tests described in this report were performed by:

Name: KEC Electronic Industry Development Center
Testing Division

Address: 3-2-2, Hikari-dai, Seika-cho, Soraku-gun, Kyoto 619-0237 Japan

Anechoic Chamber	:	<input type="checkbox"/> No.1	<input type="checkbox"/> No.2	<input checked="" type="checkbox"/> No.3	<input type="checkbox"/> No.6	<input type="checkbox"/> No.7
		<input type="checkbox"/> No.8	<input type="checkbox"/> No.9	<input type="checkbox"/> No.10	<input type="checkbox"/> No.11	<input type="checkbox"/> No.12
Shielded Room	:	<input type="checkbox"/> No.1	<input type="checkbox"/> No.7	<input type="checkbox"/> No.8	<input type="checkbox"/> No.9	<input type="checkbox"/> No.10
Harmonic Current Meas. Room	:	<input type="checkbox"/>				

1.3. Measurement Uncertainty

The result of a measurement is only an approximation or estimate of the value of a specific quantity. And thus the measurand is complete only when a statement of uncertainty is given. KEC quotes Measurement Uncertainty (U) as follows.

Conducted Disturbance at Mains Ports	+2.9/-3.4 dB
Conducted Disturbance at Telecommunication Ports ISN method	+2.6/-2.9 dB
Conducted Disturbance at Telecommunication Ports Current Probe method	+2.2/-2.7 dB
Conducted Disturbance at Telecommunication Ports 150Ω load voltage method	+1.8/-2.3 dB
Conducted Disturbance at Lead Terminals and Additional Terminals	+1.8/-2.2 dB
Disturbance Power	+2.6/-3.6 dB
Radiated Disturbance at Frequency Range (9 kHz – 30 MHz) 60cm Loop Antenna method	+3.6/-4.2 dB
Radiated Disturbance at Frequency Range (9 kHz – 30 MHz) Large Loop Antenna method	+1.6/-1.8 dB
Radiated Disturbance at Frequency Range (30 MHz – 1000 MHz)	+3.2/-4.5 dB
Radiated Disturbance at Frequency Range (1 GHz – 6 GHz)	+4.4/-5.1 dB
Radiated Disturbance at Frequency Range (6 GHz – 26.5 GHz)	+5.6/-6.3 dB
Harmonic Currents Emissions	+4.3/-4.3 %
Voltage Changes, Voltage Fluctuations and Flicker	+6.4/-6.4 %

Expiration Date : 2012/9/30

The above values are calculated as Expanded Uncertainty (k=2 [95%]).

[Note]

If the measured result is below the specification limit and a margin is less than the above measurement uncertainty, it is impossible to determine compliance at a level of confidence of 95%. However, the measured result indicates high probability that the tested device complies with the specification limit.



2. GENERAL INFORMATION

2.1. Product Description

(1) Technical Specifications

- Operating frequency range : 315MHz
- Type of antenna : Interval Antenna

(2) Rated Power Supply : DC3V (Test for DC3V)

3. TESTED SYSTEM

3.1. Reference Rule and Specification

(1) Reference Rule and Regulation	: FCC Rule Part 15 Subpart C, Section 15.231 Periodic operation in the band 40.66 – 40.70MHz and above 70MHz <input type="checkbox"/> Section 15.207 <input checked="" type="checkbox"/> Section 15.209 <input checked="" type="checkbox"/> Section 15.231 (c) <input checked="" type="checkbox"/> Section 15.231 (e)
(2) Test Procedure	: ANSI C63.4-2003

3.2. Date of Test

Receipt of Test Sample : 7 September 2012
Condition of Test Sample : Damage is not found on the set.
 Damage is found on the set. (Details are described in this report)

Test Completed on : 11 September 2012
Condition of Test Sample : Damage is not found on the set.
 Damage is found on the set. (Details are described in this report)

3.3. Deviation of Standard

without deviation, with deviation (details are found inside of this report)

3.4. Test Mode

Continuously transmitted mode.

[Note]

The EUT was operated continuously in measurement. In the measurement of radiated emission. The EUT was placed horizontally or vertically on the test table. The data of operation modes that produce the maximum emission were reported at each frequency.

3.5. Characteristics of transmitting train

The transmission of EUT is less than 1.0 second and the intervals are greater than 10 seconds. See plot figure 1 to figure 4.

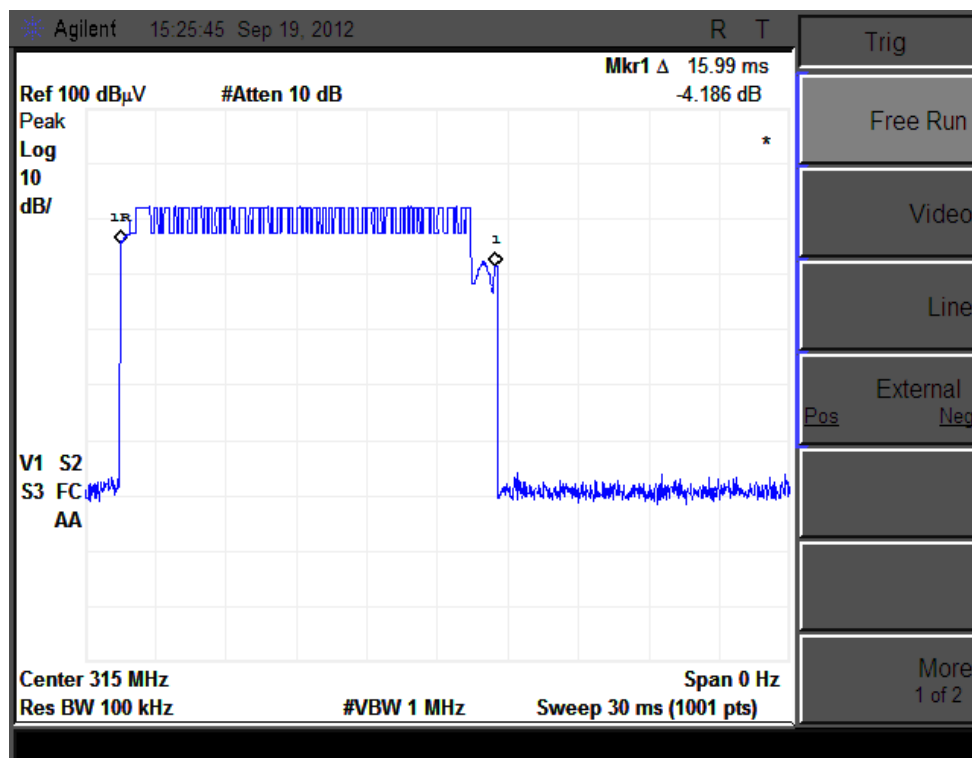

Figure 1. normal transmission

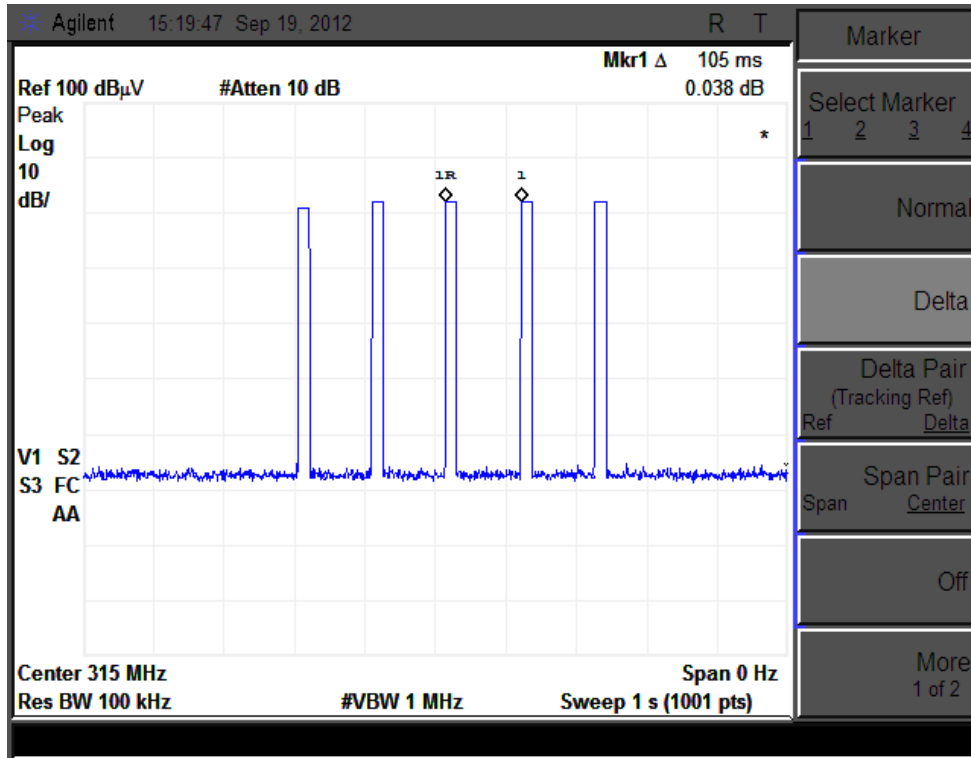

Figure 2. Pressure alert transmission

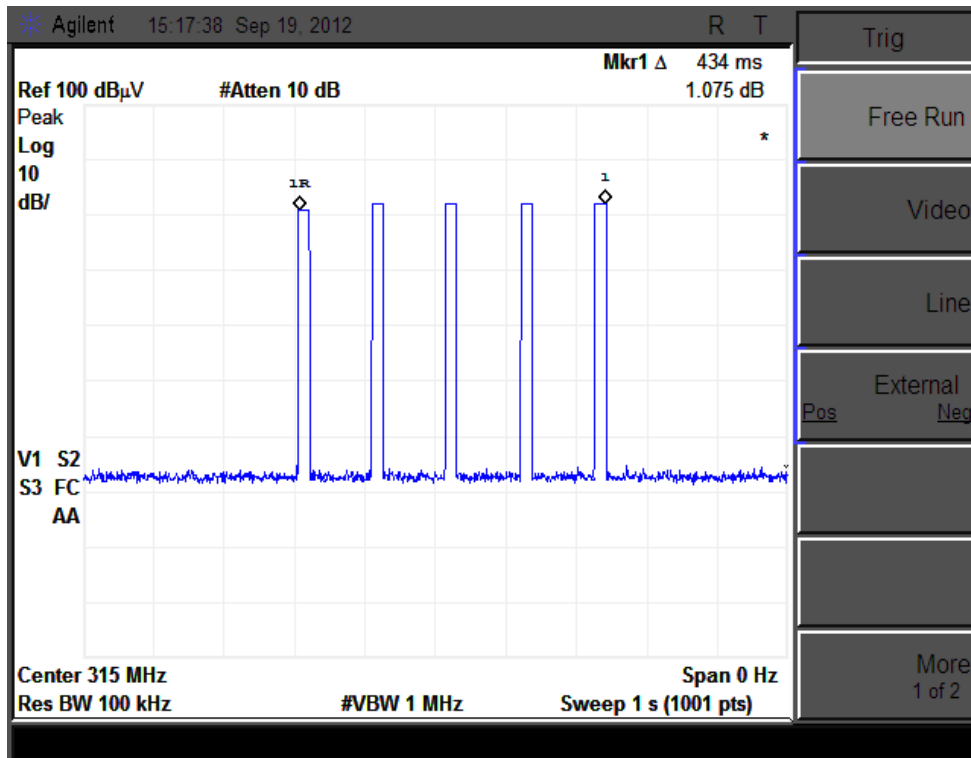

Figure 3. Pressure alert transmission

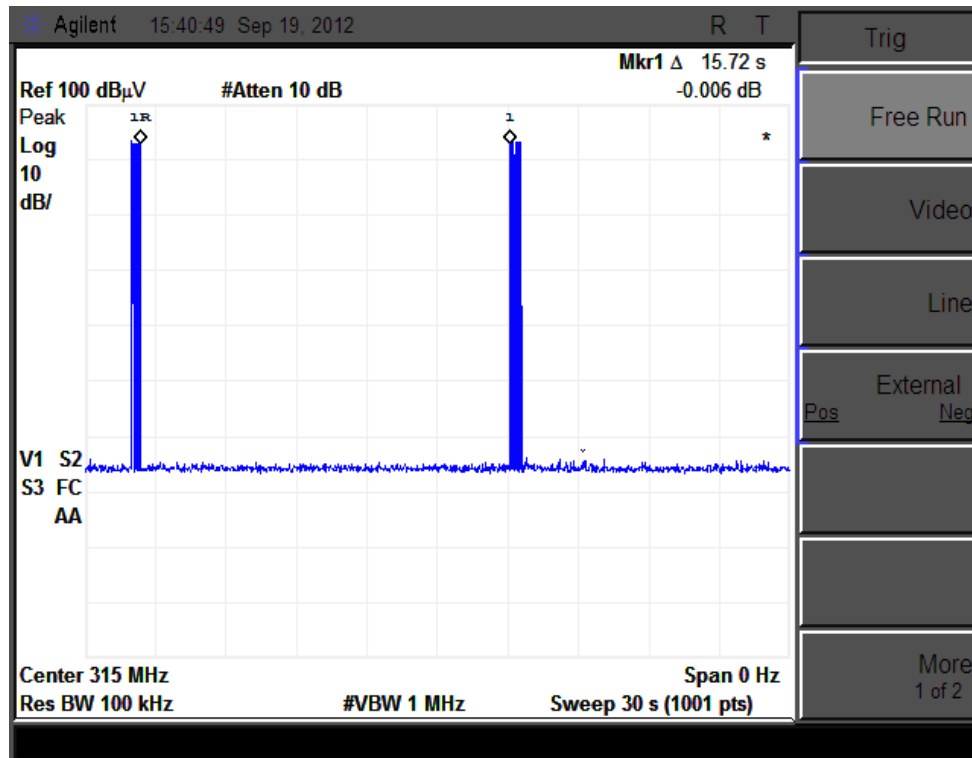

Figure 4. Pressure alert transmission interval

[Note]

- (1) In figure 3, the duration of each transmission is not greater than one second.
- (2) In figure 4, the silent period between transmissions shall be at least 30 times the duration of the transmission but in no case less than 10 seconds.



4. RADIATED EMISSION MEASUREMENT

4.1. Test Procedure

- (1) Configure the EUT System in accordance with ANSI C63.4-2003 section 8.
See also the block diagram and the photographs of EUT System configuration in this report.
- (2) If the EUT system is connected to a public power network, all power cords for the EUT System are connected the receptacle on the turntable.
- (3) Warm up the EUT System.
- (4) Activate the EUT System and run the prepared software for the test, if necessary.
- (5) To find out the emissions of the EUT System, preliminary radiated measurement are performed at a closer distance than that specified for final radiated measurement using the spectrum analyzer (*1) and the broad band antenna.
In the frequency above 1GHz, it is performed using the spectrum analyzer (*2) and the horn antenna.
- (6) To find out an EUT System condition, which produces the maximum emission, the configuration of EUT System, the position of the cables, and the operation mode, are changed under normal usage of the EUT.
- (7) The spectrums are scanned from 30MHz to the upper frequency of measurement range, and collect the six highest emissions minimum on the spectrum analyzer relative to the limits in the whole range.
- (8) In final compliance test, the six highest emissions minimum, recorded above, are measured at the specified distance using the broad band antenna or the tuned dipole antenna and the test receiver (*3).
In the frequency above 1GHz, the measurements are performed by the horn antenna and
 - the test receiver (*4).
 - the spectrum analyzer (*5) with pre-amplifier.

[Note]

(*1) Spectrum Analyzer Set Up Conditions

Frequency range : 30 – 1000MHz
Resolution bandwidth : 100kHz
Detector function : Peak mode

(*2) Spectrum Analyzer Set Up Conditions (Peak detector Measurement)

Frequency range : 1GHz – Upper frequency of measurement range
Resolution bandwidth : 1MHz
Video bandwidth : 1MHz
Attenuator : 10dB
Detector function : Peak mode

(*3) Test Receiver Set Up Conditions

Detector function : Quasi – Peak / Peak
IF bandwidth : 120kHz

(*4) Test Receiver Set Up Conditions

Detector function : Average
IF bandwidth : 1MHz

(*5) Spectrum Analyzer Set Up Conditions (Average detector Measurement)

Frequency range : 1GHz – Upper frequency of measurement range
Resolution bandwidth : 1MHz
Video bandwidth : 10Hz or 30Hz
Attenuator : 10dB
Y axis : Linear



4.2. Test Results

Measured Frequency (MHz)	Antenna Factor (*1) (dB/m)	Conversion Factor (*2) (dB)	Meter Reading		Maximum Field Strength (dBµV/m)	Limit		Margin for Limit (dB)
			Horizontal Polarization (dBµV)	Vertical Polarization (dBµV)		Peak (dBµV/m)	Average (dBµV/m)	
[Peak Detector Measurement]								
[Fundamental]								
315.00	22.2	-	55.5	52.1	77.7	87.7	-	10.0
[Harmonics]								
630.00	28.9	-	21.5	16.2	50.4	67.7	-	17.3
945.00	34.1	-	8.4	9.1	43.2	67.7	-	24.5
[Average Detector Measurement]								
[Fundamental]								
315.00	22.2	-15.9	55.5	52.1	61.8	-	67.7	5.9
[Harmonics]								
630.00	28.9	-15.9	21.5	16.2	34.5	-	47.7	13.2
945.00	34.1	-15.9	8.4	9.1	27.3	-	47.7	20.4

Restricted Band Above 1GHz

Measured Frequency (MHz)	Antenna Factor (*1) (dB/m)	Conversion Factor (*2) (dB)	Meter Reading		Maximum Field Strength (dBµV/m)	Limit		Margin for Limit (dB)
			Horizontal Polarization (dBµV)	Vertical Polarization (dBµV)		Peak (dBµV/m)	Average (dBµV/m)	
[Peak Detector Measurement]								
[Harmonics]								
1260.00	-9.8	-	51.7	50.1	41.9	74.0	54.0	32.1
1575.00	-9.3	-	70.4	66.0	61.1	74.0	54.0	12.9
1890.00	-7.3	-	72.5	64.7	65.2	74.0	54.0	8.8
2205.00	-5.9	-	63.2	55.2	57.3	74.0	54.0	16.7
2520.00	-5.0	-	59.6	56.6	54.6	74.0	54.0	19.4
2835.00	-3.8	-	53.9	53.1	50.1	74.0	54.0	23.9
3150.00	-3.6	-	54.9	53.7	51.3	74.0	54.0	22.7
[Average Detector Measurement]								
[Harmonics]								
1260.00	-9.8	-15.9	51.7	50.1	26.0	-	54.0	28.0
1575.00	-9.3	-15.9	70.4	66.0	45.2	-	54.0	8.8
1890.00	-7.3	-15.9	72.5	64.7	49.3	-	54.0	4.7
2205.00	-5.9	-15.9	63.2	55.2	41.4	-	54.0	12.6
2520.00	-5.0	-15.9	59.6	56.6	38.7	-	54.0	15.3
2835.00	-3.8	-15.9	53.9	53.1	34.2	-	54.0	19.8
3150.00	-3.6	-15.9	54.9	53.7	35.4	-	54.0	18.6

**[Remark]**

- (*1) : Antenna Factor includes the cable loss, above 1GHz, antenna factor includes both of the cable loss and pre-amplifier gain.
- (*2) : Conversion Factor, See figure 1 and 4 (the picture of spectrum analyzer) and See Page 12, Calculation of Conversion Factor (Peak detector to Average).
- (*3) : If the measurement value with the peak detector meets the average limits, the measurement with average detector is omitted.
- In FCC rule, the limit of measurement of radiated emission above 1GHz is regulated on the average value. Therefore, the average value above 1GHz was determined by using a reduced the video bandwidth of spectrum analyzer to obtain the average value in this case spectrum analyzer set up condition.

Resolution Bandwidth : 1MHz
 Video Bandwidth : 30Hz
 Detector function : Peak detector

[Note]

- (1) * mark in Measured Frequency : Measured with the tuned dipole antenna.
 No mark in Measured Frequency : Measured with the broadband antenna.
- (2) All emission not reported were less than 10dB μ V at meter reading.
- (3) Measurement Distance : <below 1GHz> 3m 10m
 <above 1GHz> 3m 10m

[Calculation method]

Maximum Field Strength (dB μ V/m)
 = Meter Reading (at maximum level of Horizontal or Vertical) (dB μ V) + Antenna Factor (dB/m)

[Calculation of Limit (Average detector)]Fundamental

$L = 20\log(16.67 \times F - 2833.33)$ Where, L: Limit [dB μ V/m], F: Frequency [MHz]

$L = 67.7$ [dB μ V/m] at $F = 314.98$ [MHz]

Spurious Emission

$L = 67.7 - 20 = 47.7$ [dB μ V/m]

Above 1000MHz, the limit is replaced at 54dB μ V/m.

Tested Date	Environment	
	Temperature	Humidity
11 September 2012	24 °C	54 %



[Calculation of Conversion Factor (Peak detector to Average)]

In accordance with ANSI C63.4-2003 section 13.1.4.2, The EUT's transmitting pulse modulated emissions, therefore the average level of emissions are found by measuring peak level of the emission and correcting them with the duty cycle.

From Figure 1.

The value of the sum of the pulse widths in one period : 15.99 [msec]

The length of the period : 100.0 [msec]

As the EUT pulse train exceeds 100ms, calculate the duty cycle by averaging the sum of the pulse widths over the width with the highest average value.

Then, Conversion Factor PEAK to AVERAGE is calculated as follows.

Conversion Factor

$$(\text{dB}) = 20\text{Log}(\text{Duty cycle}) = 20\text{Log} \frac{15.99[\text{msec}]}{100.0[\text{msec}]}$$

PEAK to AVERAGE

$$= -15.9 (\text{dB})$$

$$\text{Duty cycle} = \frac{\text{The value of the sum of the pulse widths in one period } \sum_{n=1}^n t_n}{\text{The length of period (T)}}$$

[Sample Calculation at conversion Peak to Average]

Field Strength (dB μ V/m)

$$= \text{Meter Reading (at Maximum level of horizontal or vertical) (dB}\mu\text{V)} \\ + \text{Antenna Factor (dB/m)} + \text{Conversion Factor (dB)}$$

Test data in Graph

30 – 1000MHz

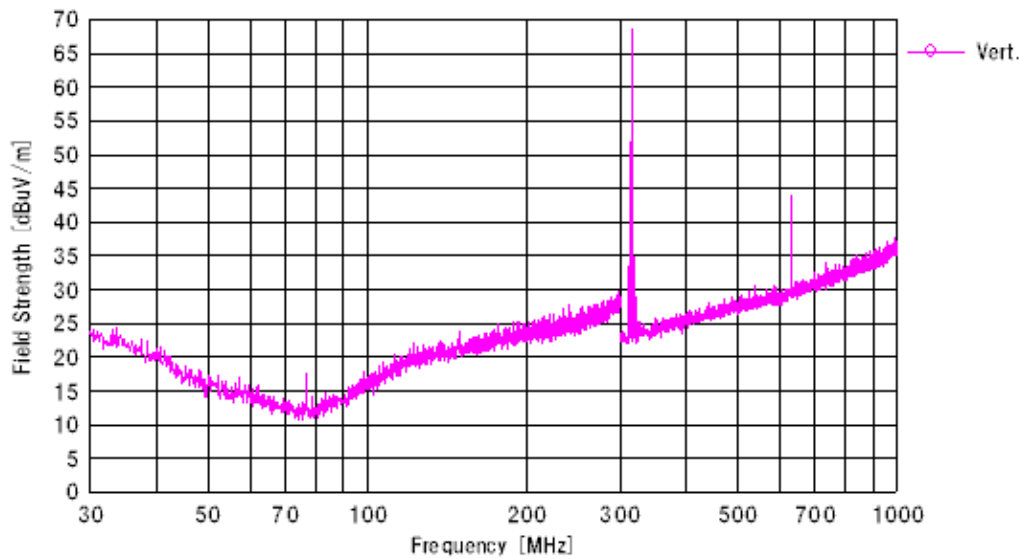
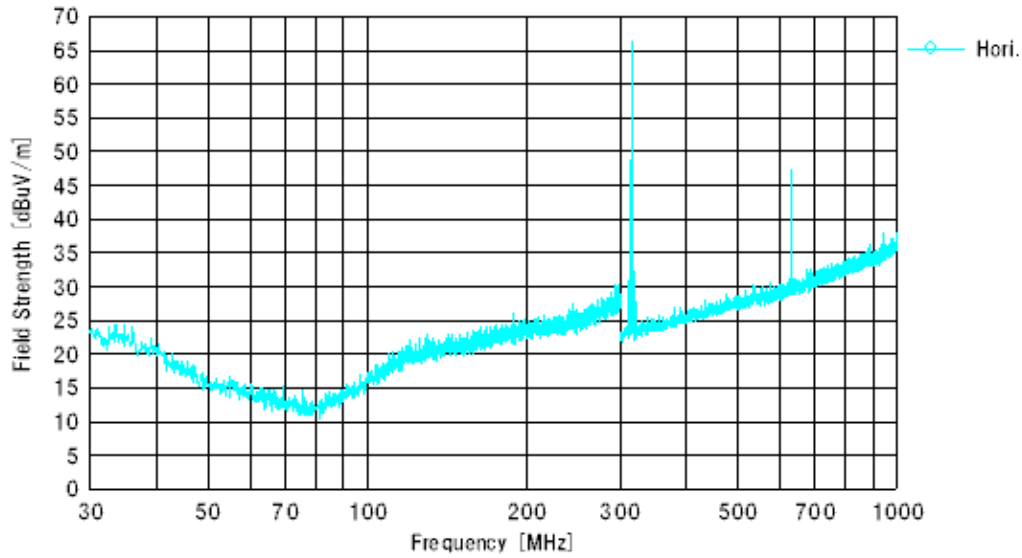

[Note]

This spectrum chart is the result of Exploratory radiated emission measurement by using the spectrum analyzer. The result of Final radiated emission measurement is shown in the table of previous page.

5. EMISSION BANDWIDTH MEASUREMENT

5.1. Test Configuration

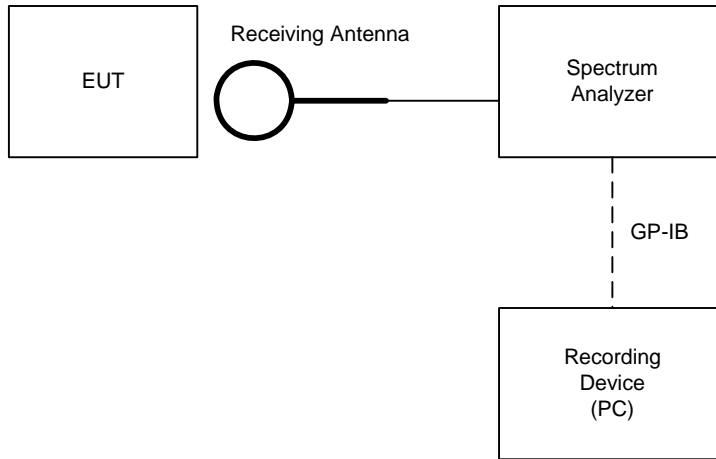

5.2. Test Results

Measured emission bandwidth = 27.22kHz
 See next Figure 5 (the picture of spectrum analyzer)

[Note]

Emission Bandwidth was determined at the points 20dB down from the modulated carrier.

Spectrum Analyzer Setting:

Center Frequency = 315.00MHz
 Frequency Span = 1MHz
 Resolution Bandwidth = 10kHz
 Video Bandwidth = 100kHz

[Calculation of Limit]

Limit of Emission bandwidth = $315.00\text{MHz} \times 0.25\% = 787.5\text{kHz}$

Tested Date	Environment	
	Temperature	Humidity
11 September 2012	24 °C	54 %

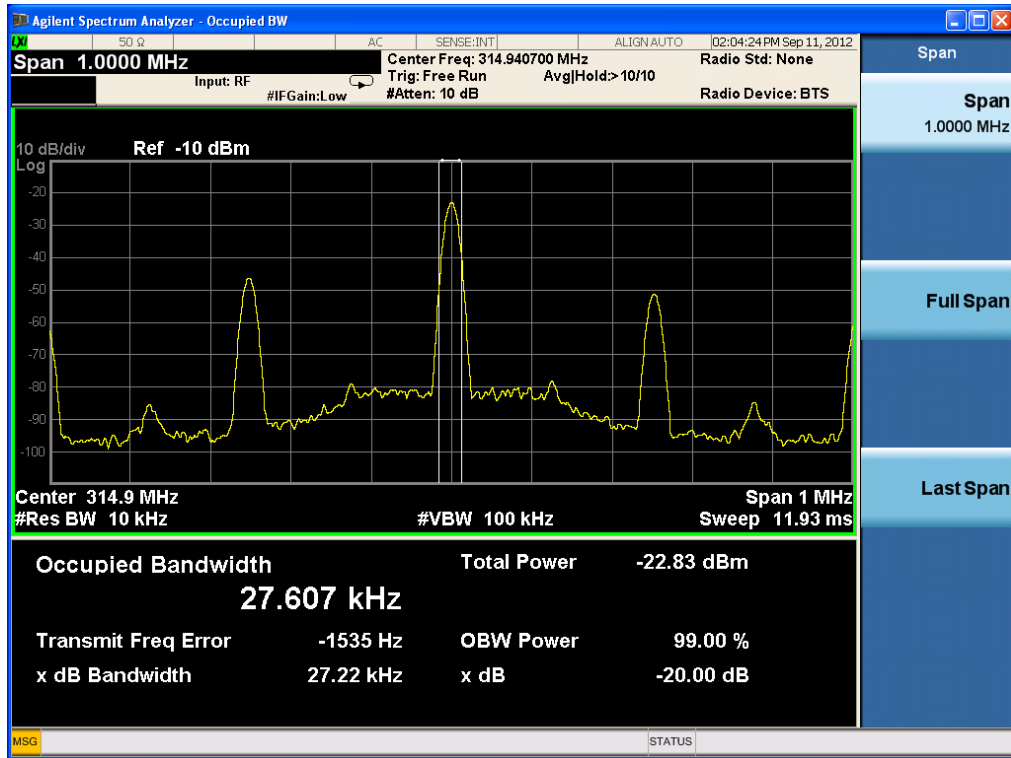

Figure 5



6. TEST EQUIPMENT

· Radiated Emission Measurement / · Emission Bandwidth Measurement

KEC No.	Equipment	Manufacturer	Model No.	Last Cal.	Next Cal.
AM-53	Pre-Amplifier	HP	8449B	2012/03	2013/03
AM-105	Pre-Amplifier	SONOMA	310N	2012/03	2013/03
AN-216	LPDA Antenna	Schwarzbeck	UHALP 9108A	2012/03	2013/03
AN-219	Biconical Antenna	Schwarzbeck	VHA9103/BBA9106	2012/03	2013/03
AN-298	DRG Horn Antenna	Schwarzbeck	BBHA9120LF(A)	2012/05	2013/05
AN-312	Tri-Log Antenna	Schwarzbeck	VULB9168	2012/03	2013/03
AT-102	3dB Attenuator	JFW	50HF-003	2012/03	2013/03
AT-115	Fixed Attenuator	JFW	50HF-006N	2012/03	2013/03
AX-064	RF Relay Matrix Unit	TSJ	RFM-E21	2012/03	2013/03
FS-079	Test Receiver	ROHDE & SCHWARZ	ESVD	2011/11	2012/11
SA-050	Spectrum Analyzer	Agilent	E4404B	2012/05	2013/05
SA-052	Spectrum Analyzer	Agilent	E4446A	2011/10	2012/10

Note : (*1) We check the performance, before using this device.

The overall program of calibration and verification of equipment is designed and operated so as to ensure that measurements made by KEC are traceable to national standards of measurement or equivalent abroad.