



FCC TEST REPORT

REPORT NO.: RF921027R04

MODEL NO.: WL-1402

RECEIVED: Oct. 27, 2003

TESTED: Mar. 1 ~ Mar. 5, 2004

APPLICANT: CC&C TECHNOLOGIES INC.

ADDRESS: 8F, 150, Jian Yi Road, Chung Ho City, Taipei
County, Taiwan 235, R.O.C.

ISSUED BY: Advance Data Technology Corporation

LAB LOCATION: 47 14th Lin, Chiapau Tsun, Linko, Taipei,
Taiwan, R.O.C.

This test report consists of 66 pages in total. It may be duplicated completely for legal use with the approval of the applicant. It should not be reproduced except in full, without the written approval of our laboratory. The client should not use it to claim product endorsement by CNLA or any government agencies. The test results in the report only apply to the tested sample.



0528
ILAC MRA



Table of Contents

1	CERTIFICATION	4
2	SUMMARY OF TEST RESULTS	5
3	GENERAL INFORMATION	6
3.1	GENERAL DESCRIPTION OF EUT	6
3.2	DESCRIPTION OF TEST MODES	7
3.3	GENERAL DESCRIPTION OF APPLIED STANDARDS	7
3.4	DESCRIPTION OF SUPPORT UNITS	8
3.5	CONFIGURATION OF SYSTEM UNDER TEST	8
4	TEST TYPES AND RESULTS	9
4.1	CONDUCTED EMISSION MEASUREMENT	9
4.1.1	LIMITS OF CONDUCTED EMISSION MEASUREMENT	9
4.1.2	TEST INSTRUMENTS	9
4.1.3	TEST PROCEDURES	10
4.1.4	DEVIATION FROM TEST STANDARD	10
4.1.5	TEST SETUP	10
4.1.6	EUT OPERATING CONDITIONS	11
4.1.7	TEST RESULTS	12
4.2	RADIATED EMISSION MEASUREMENT	24
4.2.1	LIMITS OF RADIATED EMISSION MEASUREMENT	24
4.2.2	TEST INSTRUMENTS	25
4.2.3	TEST PROCEDURES	26
4.2.4	DEVIATION FROM TEST STANDARD	27
4.2.5	TEST SETUP	27
4.2.6	EUT OPERATING CONDITIONS	27
4.2.7	TEST RESULTS	28
4.3	6dB BANDWIDTH MEASUREMENT	38
4.3.1	LIMITS OF 6dB BANDWIDTH MEASUREMENT	38
4.3.2	TEST INSTRUMENTS	38
4.3.3	TEST PROCEDURE	39
4.3.4	DEVIATION FROM TEST STANDARD	39
4.3.5	TEST SETUP	39



4.3.6 EUT OPERATING CONDITIONS..... 39

4.3.7 TEST RESULTS..... 40

4.4 MAXIMUM PEAK OUTPUT POWER 44

4.4.1 LIMITS OF MAXIMUM PEAK OUTPUT POWER MEASUREMENT 44

4.4.2 TEST INSTRUMENTS 44

4.4.3 TEST PROCEDURES..... 45

4.4.4 DEVIATION FROM TEST STANDARD 45

4.4.5 TEST SETUP 45

4.4.6 EUT OPERATING CONDITIONS..... 45

4.4.7 TEST RESULTS..... 46

4.5 POWER SPECTRAL DENSITY MEASUREMENT 47

4.5.1 LIMITS OF POWER SPECTRAL DENSITY MEASUREMENT 47

4.5.2 TEST INSTRUMENTS 47

4.5.3 TEST PROCEDURE 48

4.5.4 DEVIATION FROM TEST STANDARD 48

4.5.5 TEST SETUP..... 48

4.5.6 EUT OPERATING CONDITIONS..... 48

4.5.7 TEST RESULTS..... 49

4.6 BAND EDGES MEASUREMENT 53

4.6.1 LIMITS OF BAND EDGES MEASUREMENT 53

4.6.2 TEST INSTRUMENTS 53

4.6.3 TEST PROCEDURE 53

4.6.4 DEVIATION FROM TEST STANDARD 53

4.6.5 EUT OPERATING CONDITION 53

4.6.6 TEST RESULTS..... 54

4.7 ANTENNA REQUIREMENT 59

4.7.1 STANDARD APPLICABLE 59

4.7.2 ANTENNA CONNECTED CONSTRUCTION..... 59

5 PHOTOGRAPHS OF THE TEST CONFIGURATION..... 60

6 INFORMATION ON THE TESTING LABORATORIES 66



1 CERTIFICATION

PRODUCT : 802.11b Mini PCI Card
MODEL NO. : WL-1402
BRAND : CC&C
TEST ITEM: ENGINEERING SAMPLE
APPLICANT : CC&C TECHNOLOGIES INC.
STANDARDS : FCC Part 15, Subpart C (Section 15.247),
ANSI C63.4-1992

We, **Advance Data Technology Corporation**, hereby certify that one sample of the designation has been tested in our facility from Mar. 1 to Mar. 5, 2004. The test record, data evaluation and Equipment Under Test (EUT) configurations represented herein are true and accurate accounts of the measurements of the sample's EMC characteristics under the conditions herein specified.

PREPARED BY:  , **DATE:** Mar. 8, 2004
Stephanie Hung

APPROVED BY:  , **DATE:** Mar. 8, 2004
Ellis Wu, Manager



2 SUMMARY OF TEST RESULTS

The EUT has been tested according to the following specifications:

APPLIED STANDARD: FCC Part 15, Subpart C			
Standard Section	Test Type and Limit	Result	REMARK
15.207	AC Power Conducted Emission	PASS	Meet the requirement of limit Minimum passing margin is -5.85dB at 0.173MHz
15.247(a)(2)	Spectrum Bandwidth of a Direct Sequence Spread Spectrum System Limit: min. 500kHz	PASS	Meet the requirement of limit
15.247(b)	Maximum Peak Output Power Limit: max. 30dBm	PASS	Meet the requirement of limit
15.247(c)	Transmitter Radiated Emissions Limit: Table 15.209	PASS	Meet the requirement of limit Minimum passing margin is -0.50dB at 100.41MHz
15.247(d)	Power Spectral Density Limit: max. 8dBm	PASS	Meet the requirement of limit
15.247(c)	Band Edge Measurement Limit: 20 dB less than the peak value of fundamental frequency	PASS	Meet the requirement of limit

NOTE: The information of measurement uncertainty is available upon the customer's request.



3 GENERAL INFORMATION

3.1 GENERAL DESCRIPTION OF EUT

PRODUCT	802.11b Mini PCI Card
MODEL NO.	WL-1402
POWER SUPPLY	3.3Vdc from host equipment
MODULATION TYPE	BPSK, QPSK, CCK
RADIO TECHNOLOGY	DSSS
TRANSFER RATE	1/2/5.5/11Mbps
FREQUENCY RANGE	2412MHz ~ 2462MHz
NUMBER OF CHANNEL	11
OUTPUT POWER	17.22dBm
ANTENNA TYPE	PIFA
ANTENNA GAIN	-1.97dBi for antenna 1 -2.63dBi for antenna 2
DATA CABLE	NA
I/O PORTS	NA
ASSOCIATED DEVICES	NA

NOTE:

1. The EUT operates in the 2.4GHz frequency spectrum with throughput of up to 11Mbps.
2. The EUT is specified to s notebook PC which brand is Uniwill and model is 258SAO.
3. The notebook is powered by the following adapter:

BRAND :	LITEON
MODEL :	PA-1161-02
INPUT :	100~240Vac, 50~60Hz, 2.25A
OUTPUT :	20Vdc, 8.0A

4. For more detailed features description, please refer to the manufacturer's specifications or User's Manual.



3.2 DESCRIPTION OF TEST MODES

Eleven channels are provided to this EUT.

Channel	Frequency	Channel	Frequency
1	2412 MHz	7	2442 MHz
2	2417 MHz	8	2447 MHz
3	2422 MHz	9	2452 MHz
4	2427 MHz	10	2457 MHz
5	2432 MHz	11	2462 MHz
6	2437 MHz		

NOTE:

1. Below 1 GHz, the channel 1, 6, and 11 were pre-tested in chamber. The channel 11, worst case one, was chosen for final test.
2. Above 1 GHz, the channel 1, 6, and 11 were tested individually.
3. Data rate 11Mbps, the worst case, was chosen for final test.
4. There are two antennas provided to this EUT. Both of them are PIFA antennas and the only difference is their antenna gain.
5. For Conducted Emission Test and Radiated Emission Test, there are two test modes provided to this EUT. The test mode A is for Antenna 1 with -1.97dBi gain and the test mode B is for Antenna 2 with -2.63dBi gain.

3.3 GENERAL DESCRIPTION OF APPLIED STANDARDS

The EUT is a 802.11b Mini PCI Card. According to the specifications of the manufacturer, it must comply with the requirements of the following standards:

FCC Part 15, Subpart C. (15.247)

ANSI C63.4 : 1992

All test items have been performed and recorded as per the above standards.

NOTE: The EUT is also considered as a kind of computer peripheral, because the connection to computer is necessary for typical use. It has been verified to comply with the requirements of FCC Part 15, Subpart B, Class B (DoC). The test report has been issued separately.



3.4 DESCRIPTION OF SUPPORT UNITS

The EUT has been tested as an independent unit together with other necessary accessories or support units. The following support units or accessories were used to form a representative test configuration during the tests.

NO.	PRODUCT	BRAND	MODEL NO.	SERIAL NO.	FCC ID
1	NOTEBOOK	DELL	PP01L	TW-0791UH-12800-123-5423	FCC DoC Approved
2	PRINTER	EPSON	LQ-300+	DCGY038835	FCC DoC Approved
3	MODEM	ACEEX	1414	980020516	IFAXDM1414

NO.	SIGNAL CABLE DESCRIPTION OF THE ABOVE SUPPORT UNITS
1	NA
2	1.2m braid shielded wire, terminated with DB25 and Centronics connector via metallic frame, w/o core
3	1.2 m braid shielded wire, terminated with DB25 and DB9 connector via metallic frame, w/o core.

NOTE: All power cords of the above support units are non shielded (1.8m).

3.5 CONFIGURATION OF SYSTEM UNDER TEST

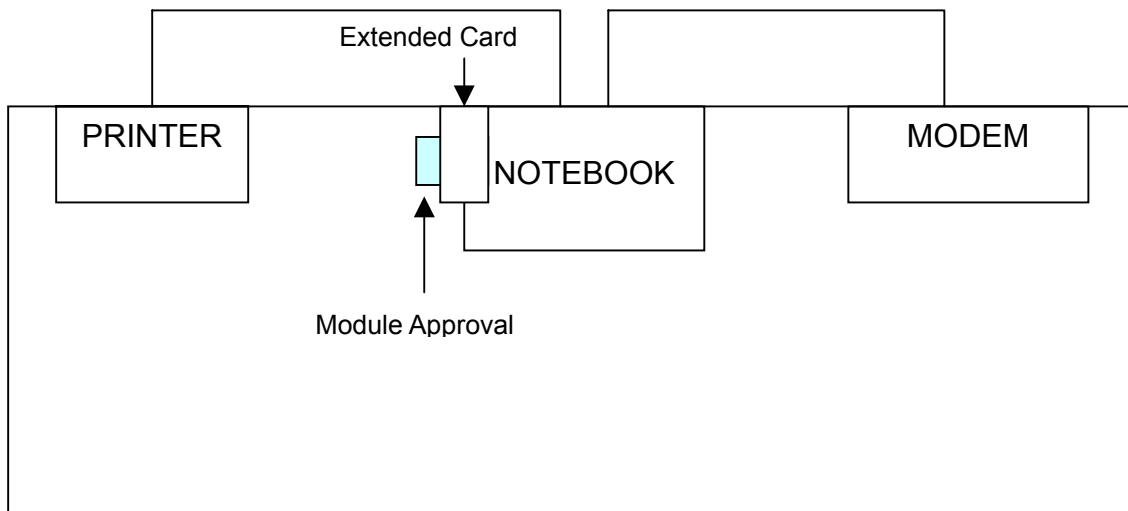



4 TEST TYPES AND RESULTS

4.1 CONDUCTED EMISSION MEASUREMENT

4.1.1 LIMITS OF CONDUCTED EMISSION MEASUREMENT

FREQUENCY OF EMISSION (MHz)	CONDUCTED LIMIT (dB μ V)	
	Quasi-peak	Average
0.15-0.5	66 to 56	56 to 46
0.5-5	56	46
5-30	60	50

- NOTE:**
1. The lower limit shall apply at the transition frequencies.
 2. The limit decreases in line with the logarithm of the frequency in the range of 0.15 to 0.50 MHz.
 3. All emanations from a class A/B digital device or system, including any network of conductors and apparatus connected thereto, shall not exceed the level of field strengths specified above.

4.1.2 TEST INSTRUMENTS

DESCRIPTION & MANUFACTURER	MODEL NO.	SERIAL NO.	CALIBRATED UNTIL
ROHDE & SCHWARZ Test Receiver	ESCS 30	838251/021	Jan. 04, 2005
ROHDE & SCHWARZ Artificial Mains Network (for EUT)	ESH3-Z5	100218	Dec. 09, 2004
ROHDE & SCHWARZ Artificial Mains Network (for peripherals)	ESH3-Z5	100219	Dec. 09, 2004
ROHDE & SCHWARZ Artificial Mains Network (for peripherals)	ESH3-Z5	100220	Dec. 09, 2004
*ROHDE & SCHWARZ 4-wire ISN	ENY41	837032/016	Nov. 19, 2004
*ROHDE & SCHWARZ 2-wire ISN	ENY22	837497/016	Nov. 19, 2004
Software	Cond-V2M3	NA	NA
RF cable (JYEBAO)	5D-FB	Cable-C10.01	May 01, 2004
SUHNER Terminator (For ROHDE & SCHWARZ LISN)	65BNC-5001	E1-010770	Mar. 24, 2004
SUHNER Terminator (For ROHDE & SCHWARZ LISN)	65BNC-5001	E1-010773	Apr. 06, 2004

- NOTE:**
1. The calibration interval of the above test instruments is 12 months and the calibrations are traceable to NML/ROC and NIST/USA.
 2. “*”: These equipment are used for conducted telecom port test only (if tested).
 3. The test was performed in ADT Shielded Room No. 10.
 4. The VCCI Site Registration No. is C-1312.

4.1.3 TEST PROCEDURES

- a. The EUT was placed 0.4 meters from the conducting wall of the shielded room with EUT being connected to the power mains through a line impedance stabilization network (LISN). Other support units were connected to the power mains through another LISN. The two LISNs provide 50 ohm/ 50uH of coupling impedance for the measuring instrument.
- b. Both lines of the power mains connected to the EUT were checked for maximum conducted interference.
- c. The frequency range from 150kHz to 30MHz was searched. Emission levels under (Limit - 20dB) was not recorded.

4.1.4 DEVIATION FROM TEST STANDARD

No deviation

4.1.5 TEST SETUP

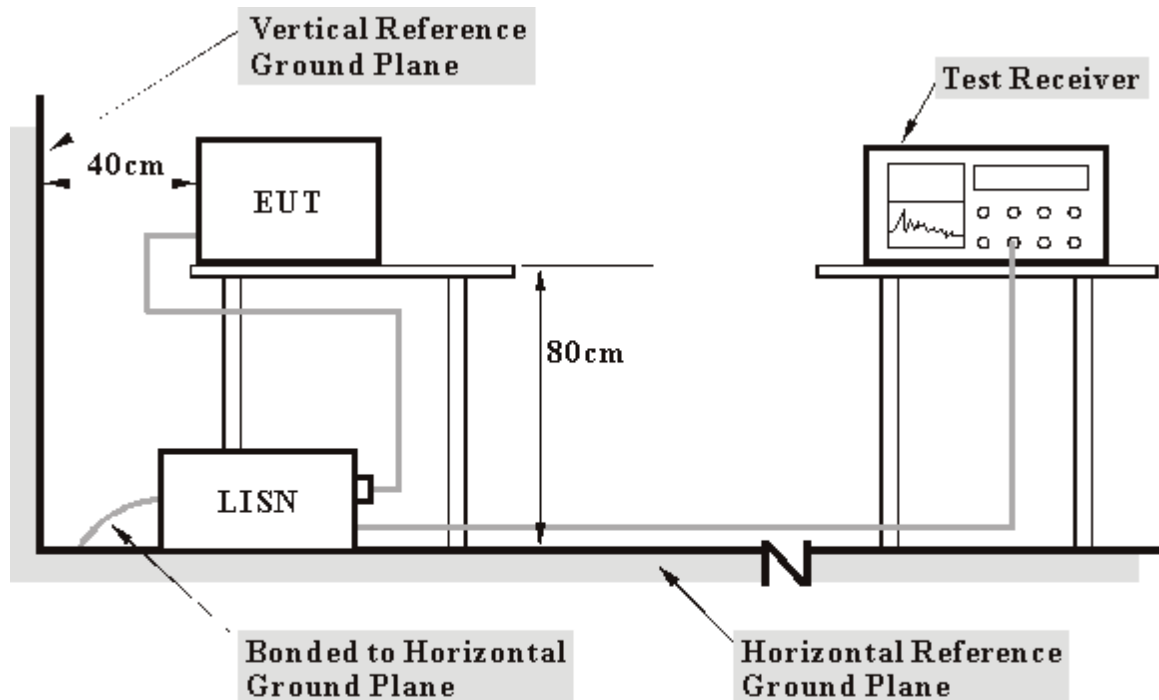

- Note:**
- 1. Support units were connected to second LISN.
 - 2. Both of LISNs (AMN) 80 cm from EUT and at the least 80 cm from other units and other metal planes support units.

For the actual test configuration, please refer to the related item – Photographs of the Test Configuration.



4.1.6 EUT OPERATING CONDITIONS

- a. Plug the EUT into a notebook computer system placed on a testing table.
- b. The computer system ran a test program to enable EUT under transmission/receiving condition continuously at specific channel frequency.
- c. The computer system sent "H" messages to its screen.
- d. The computer system sent "H" messages to modem.
- e. The computer system sent "H" messages to printer, and the printer prints them on paper.
- f. Steps c~e are repeated.



4.1.7 TEST RESULTS

EUT	802.11b Mini PCI Card	MODEL	WL-1402
CHANNEL	1	6dB BANDWIDTH	9 kHz
INPUT POWER (SYSTEM)	120Vac, 60Hz	PHASE	Line (L)
ENVIRONMENTAL CONDITIONS	20deg. C, 65%RH, 991hPa	MODE	A
TESTED BY: Jun Wu			

No	Freq. [MHz]	Corr. Factor (dB)	Reading Value		Emission Level		Limit		Margin	
			[dB (uV)]		[dB (uV)]		[dB (uV)]		(dB)	
			Q.P.	AV.	Q.P.	AV.	Q.P.	AV.	Q.P.	AV.
1	0.173	0.06	54.98	48.23	55.04	48.29	64.79	54.79	-9.76	-6.51
2	0.232	0.06	47.54	-	47.60	-	62.38	52.38	-14.78	-
3	0.525	0.08	28.95	-	29.03	-	56.00	46.00	-26.97	-
4	3.785	0.22	27.18	-	27.40	-	56.00	46.00	-28.60	-
5	19.582	0.63	27.85	-	28.48	-	60.00	50.00	-31.52	-
6	27.746	0.89	27.13	-	28.02	-	60.00	50.00	-31.98	-

- REMARKS:**
1. Q.P. and AV. are abbreviations of quasi-peak and average individually.
 2. "-": The Quasi-peak reading value also meets average limit and measurement with the average detector is unnecessary.
 3. The emission levels of other frequencies were very low against the limit.
 4. Margin value = Emission level - Limit value
 5. Correction factor = Insertion loss + Cable loss
 6. Emission Level = Correction Factor + Reading Value.

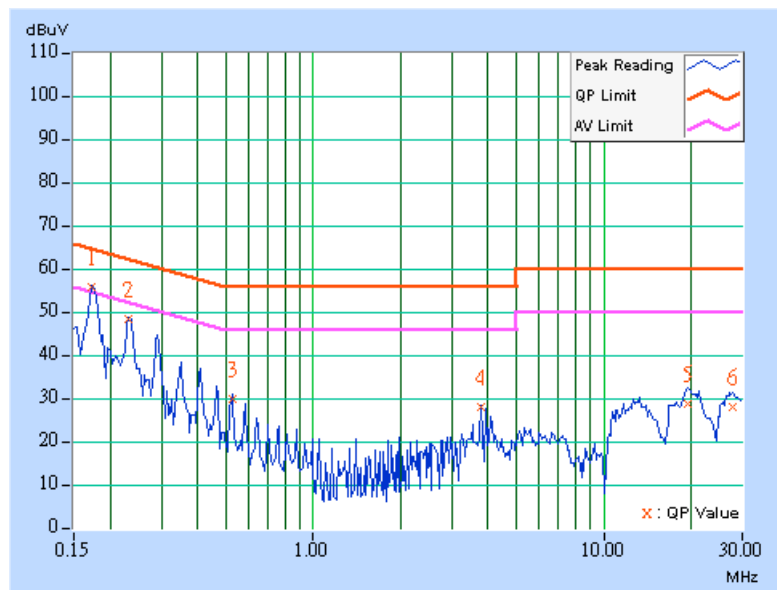



EUT	802.11b Mini PCI Card	MODEL	WL-1402
CHANNEL	1	6dB BANDWIDTH	9 kHz
INPUT POWER (SYSTEM)	120Vac, 60Hz	PHASE	Neutral (N)
ENVIRONMENTAL CONDITIONS	20deg. C, 65%RH, 991hPa	MODE	A
TESTED BY: Jun Wu			

No	Freq. [MHz]	Corr. Factor (dB)	Reading Value		Emission Level		Limit		Margin	
			[dB (uV)]		[dB (uV)]		[dB (uV)]		(dB)	
			Q.P.	AV.	Q.P.	AV.	Q.P.	AV.	Q.P.	AV.
1	0.173	0.05	55.62	48.89	55.67	48.94	64.79	54.79	-9.12	-5.85
2	0.232	0.05	48.12	-	48.17	-	62.38	52.38	-14.21	-
3	0.525	0.07	29.14	-	29.21	-	56.00	46.00	-26.79	-
4	3.789	0.20	27.29	-	27.49	-	56.00	46.00	-28.51	-
5	19.281	0.51	26.83	-	27.34	-	60.00	50.00	-32.66	-
6	27.875	0.72	26.45	-	27.17	-	60.00	50.00	-32.83	-

- REMARKS:**
1. Q.P. and AV. are abbreviations of quasi-peak and average individually.
 2. "-": The Quasi-peak reading value also meets average limit and measurement with the average detector is unnecessary.
 3. The emission levels of other frequencies were very low against the limit.
 4. Margin value = Emission level - Limit value
 5. Correction factor = Insertion loss + Cable loss
 6. Emission Level = Correction Factor + Reading Value.

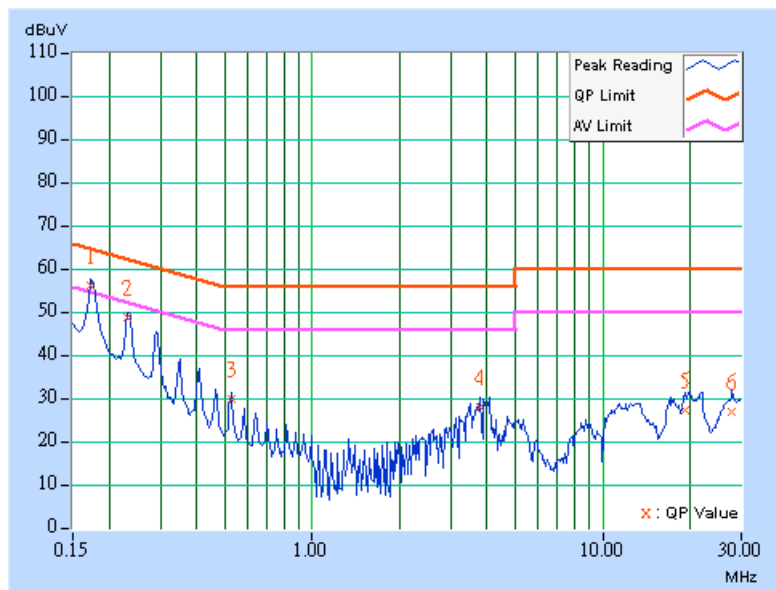



EUT	802.11b Mini PCI Card	MODEL	WL-1402
CHANNEL	6	6dB BANDWIDTH	9 kHz
INPUT POWER (SYSTEM)	120Vac, 60Hz	PHASE	Line (L)
ENVIRONMENTAL CONDITIONS	20deg. C, 65%RH, 991hPa	MODE	A
TESTED BY: Jun Wu			

No	Freq. [MHz]	Corr. Factor [dB]	Reading Value [dB (uV)]		Emission Level [dB (uV)]		Limit [dB (uV)]		Margin (dB)	
			Q.P.	AV.	Q.P.	AV.	Q.P.	AV.	Q.P.	AV.
			1	0.173	0.06	54.20	-	54.26	-	64.79
2	0.232	0.06	47.81	-	47.87	-	62.38	52.38	-14.51	-
3	0.524	0.08	28.93	-	29.01	-	56.00	46.00	-26.99	-
4	3.785	0.22	26.32	-	26.54	-	56.00	46.00	-29.46	-
5	19.582	0.63	28.49	-	29.12	-	60.00	50.00	-30.88	-
6	27.163	0.89	26.77	-	27.66	-	60.00	50.00	-32.34	-

- REMARKS:**
1. Q.P. and AV. are abbreviations of quasi-peak and average individually.
 2. "-": The Quasi-peak reading value also meets average limit and measurement with the average detector is unnecessary.
 3. The emission levels of other frequencies were very low against the limit.
 4. Margin value = Emission level - Limit value
 5. Correction factor = Insertion loss + Cable loss
 6. Emission Level = Correction Factor + Reading Value.

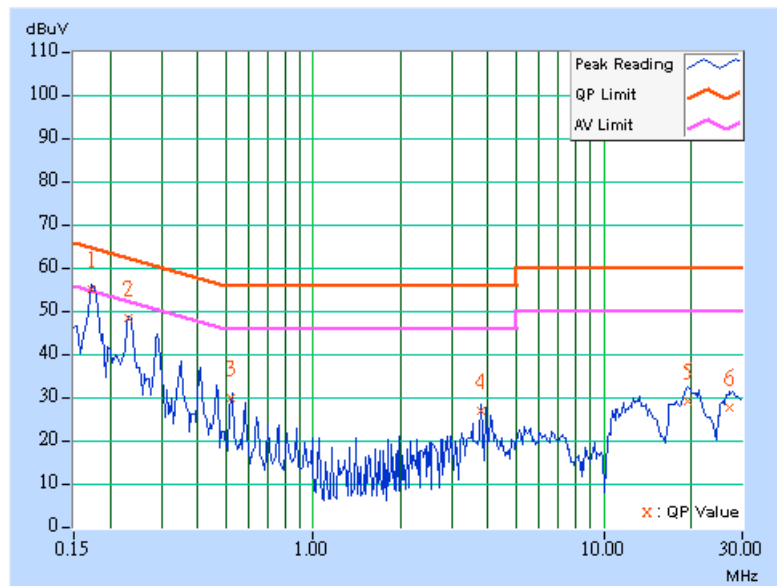



EUT	802.11b Mini PCI Card	MODEL	WL-1402
CHANNEL	6	6dB BANDWIDTH	9 kHz
INPUT POWER (SYSTEM)	120Vac, 60Hz	PHASE	Neutral (N)
ENVIRONMENTAL CONDITIONS	20deg. C, 65%RH, 991hPa	MODE	A
TESTED BY: Jun Wu			

No	Freq. [MHz]	Corr. Factor (dB)	Reading Value		Emission Level		Limit		Margin	
			[dB (uV)]		[dB (uV)]		[dB (uV)]		(dB)	
			Q.P.	AV.	Q.P.	AV.	Q.P.	AV.	Q.P.	AV.
1	0.173	0.05	54.31	-	54.36	-	64.79	54.79	-10.43	-
2	0.232	0.05	46.70	-	46.75	-	62.38	52.38	-15.63	-
3	0.525	0.07	28.07	-	28.14	-	56.00	46.00	-27.86	-
4	4.078	0.21	25.57	-	25.78	-	56.00	46.00	-30.22	-
5	19.180	0.51	27.19	-	27.70	-	60.00	50.00	-32.30	-
6	27.332	0.72	25.92	-	26.64	-	60.00	50.00	-33.36	-

- REMARKS:**
1. Q.P. and AV. are abbreviations of quasi-peak and average individually.
 2. "-": The Quasi-peak reading value also meets average limit and measurement with the average detector is unnecessary.
 3. The emission levels of other frequencies were very low against the limit.
 4. Margin value = Emission level - Limit value
 5. Correction factor = Insertion loss + Cable loss
 6. Emission Level = Correction Factor + Reading Value.

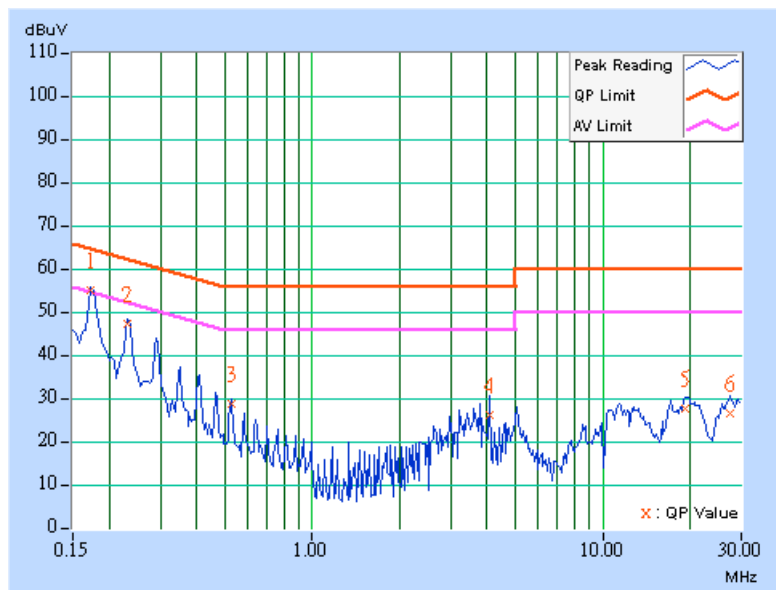



EUT	802.11b Mini PCI Card	MODEL	WL-1402
CHANNEL	11	6dB BANDWIDTH	9 kHz
INPUT POWER (SYSTEM)	120Vac, 60Hz	PHASE	Line (L)
ENVIRONMENTAL CONDITIONS	20deg. C, 65%RH, 991hPa	MODE	A
TESTED BY: Jun Wu			

No	Freq. [MHz]	Corr. Factor (dB)	Reading Value		Emission Level		Limit		Margin	
			[dB (uV)]		[dB (uV)]		[dB (uV)]		(dB)	
			Q.P.	AV.	Q.P.	AV.	Q.P.	AV.	Q.P.	AV.
1	0.173	0.05	53.24	-	53.29	-	64.79	54.79	-11.50	-
2	0.232	0.05	46.20	-	46.25	-	62.38	52.38	-16.13	-
3	0.525	0.07	28.60	-	28.67	-	56.00	46.00	-27.33	-
4	4.027	0.21	27.14	-	27.35	-	56.00	46.00	-28.65	-
5	19.137	0.51	27.86	-	28.37	-	60.00	50.00	-31.63	-
6	27.195	0.72	27.43	-	28.15	-	60.00	50.00	-31.85	-

- REMARKS:**
1. Q.P. and AV. are abbreviations of quasi-peak and average individually.
 2. "-": The Quasi-peak reading value also meets average limit and measurement with the average detector is unnecessary.
 3. The emission levels of other frequencies were very low against the limit.
 4. Margin value = Emission level - Limit value
 5. Correction factor = Insertion loss + Cable loss
 6. Emission Level = Correction Factor + Reading Value.

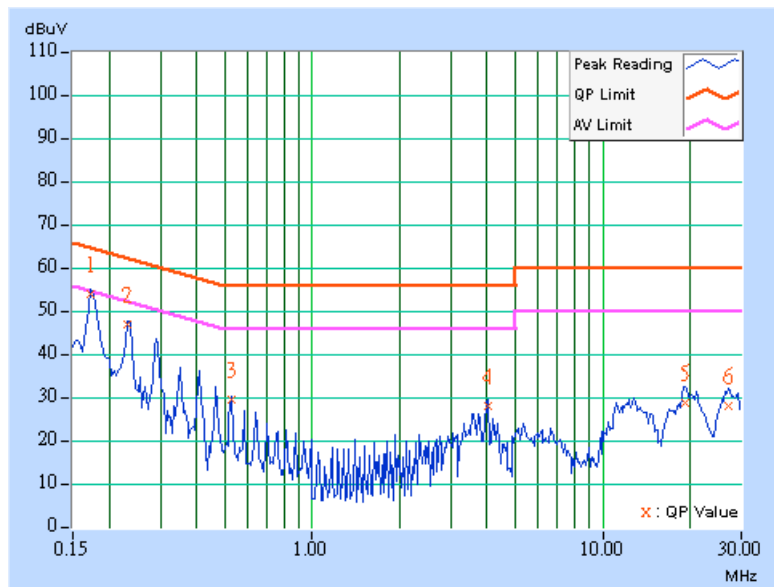



EUT	802.11b Mini PCI Card	MODEL	WL-1402
CHANNEL	11	6dB BANDWIDTH	9 kHz
INPUT POWER (SYSTEM)	120Vac, 60Hz	PHASE	Neutral (N)
ENVIRONMENTAL CONDITIONS	20deg. C, 65%RH, 991hPa	MODE	A
TESTED BY: Jun Wu			

No	Freq. [MHz]	Corr. Factor (dB)	Reading Value		Emission Level		Limit		Margin	
			[dB (uV)]		[dB (uV)]		[dB (uV)]		(dB)	
			Q.P.	AV.	Q.P.	AV.	Q.P.	AV.	Q.P.	AV.
1	0.173	0.05	53.29	-	53.34	-	64.79	54.79	-11.45	-
2	0.231	0.05	45.94	-	45.99	-	62.42	52.42	-16.43	-
3	0.525	0.07	27.69	-	27.76	-	56.00	46.00	-28.24	-
4	4.080	0.21	25.34	-	25.55	-	56.00	46.00	-30.45	-
5	19.430	0.51	26.72	-	27.23	-	60.00	50.00	-32.77	-
6	27.535	0.72	26.14	-	26.86	-	60.00	50.00	-33.14	-

- REMARKS:**
1. Q.P. and AV. are abbreviations of quasi-peak and average individually.
 2. "-": The Quasi-peak reading value also meets average limit and measurement with the average detector is unnecessary.
 3. The emission levels of other frequencies were very low against the limit.
 4. Margin value = Emission level - Limit value
 5. Correction factor = Insertion loss + Cable loss
 6. Emission Level = Correction Factor + Reading Value.

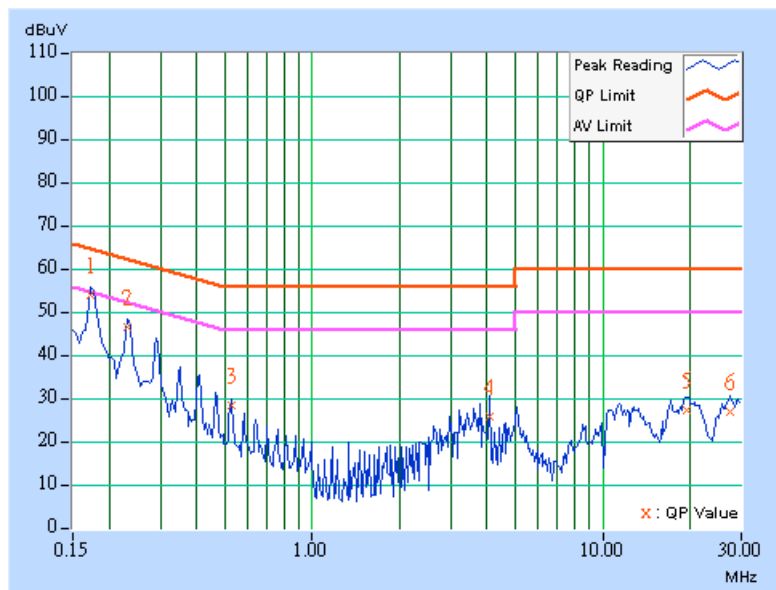



EUT	802.11b Mini PCI Card	MODEL	WL-1402
CHANNEL	1	6dB BANDWIDTH	9 kHz
INPUT POWER (SYSTEM)	120Vac, 60Hz	PHASE	Line (L)
ENVIRONMENTAL CONDITIONS	20deg. C, 65%RH, 991hPa	MODE	B
TESTED BY: Jun Wu			

No	Freq. [MHz]	Corr. Factor (dB)	Reading Value		Emission Level		Limit		Margin	
			[dB (uV)]		[dB (uV)]		[dB (uV)]		(dB)	
			Q.P.	AV.	Q.P.	AV.	Q.P.	AV.	Q.P.	AV.
1	0.175	0.06	51.57	-	51.63	-	64.73	54.73	-13.11	-
2	0.232	0.06	45.02	-	45.08	-	62.38	52.38	-17.30	-
3	0.525	0.08	27.62	-	27.70	-	56.00	46.00	-28.30	-
4	3.802	0.22	25.77	-	25.99	-	56.00	46.00	-30.01	-
5	19.348	0.63	26.64	-	27.27	-	60.00	50.00	-32.73	-
6	26.711	0.89	25.36	-	26.25	-	60.00	50.00	-33.75	-

- REMARKS:**
1. Q.P. and AV. are abbreviations of quasi-peak and average individually.
 2. "-": The Quasi-peak reading value also meets average limit and measurement with the average detector is unnecessary.
 3. The emission levels of other frequencies were very low against the limit.
 4. Margin value = Emission level - Limit value
 5. Correction factor = Insertion loss + Cable loss
 6. Emission Level = Correction Factor + Reading Value.

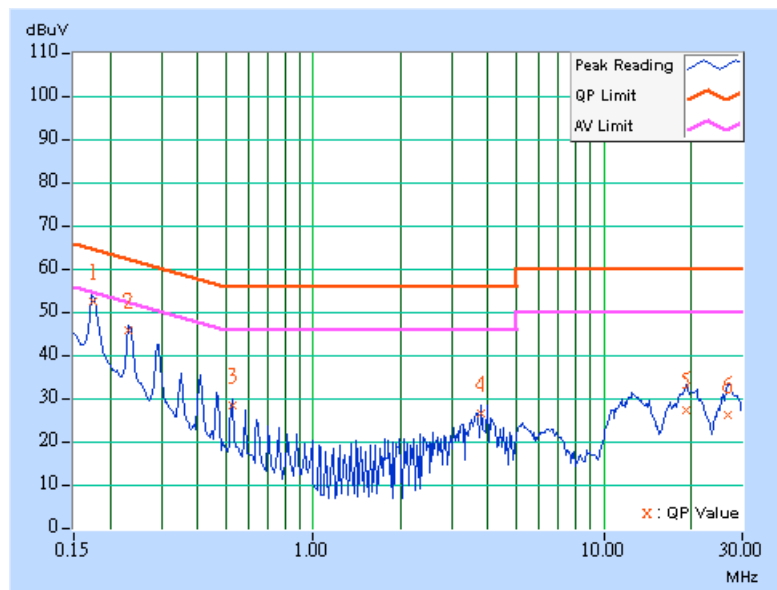



EUT	802.11b Mini PCI Card	MODEL	WL-1402
CHANNEL	1	6dB BANDWIDTH	9 kHz
INPUT POWER (SYSTEM)	120Vac, 60Hz	PHASE	Neutral (N)
ENVIRONMENTAL CONDITIONS	20deg. C, 65%RH, 991hPa	MODE	B
TESTED BY: Jun Wu			

No	Freq. [MHz]	Corr. Factor (dB)	Reading Value		Emission Level		Limit		Margin	
			[dB (uV)]		[dB (uV)]		[dB (uV)]		(dB)	
			Q.P.	AV.	Q.P.	AV.	Q.P.	AV.	Q.P.	AV.
1	0.177	0.05	51.42	-	51.47	-	64.61	54.61	-13.14	-
2	0.236	0.05	43.98	-	44.03	-	62.24	52.24	-18.21	-
3	0.529	0.07	25.17	-	25.24	-	56.00	46.00	-30.76	-
4	3.805	0.20	27.39	-	27.59	-	56.00	46.00	-28.41	-
5	18.672	0.50	26.28	-	26.78	-	60.00	50.00	-33.22	-
6	27.344	0.72	25.14	-	25.86	-	60.00	50.00	-34.14	-

- REMARKS:**
1. Q.P. and AV. are abbreviations of quasi-peak and average individually.
 2. "-": The Quasi-peak reading value also meets average limit and measurement with the average detector is unnecessary.
 3. The emission levels of other frequencies were very low against the limit.
 4. Margin value = Emission level - Limit value
 5. Correction factor = Insertion loss + Cable loss
 6. Emission Level = Correction Factor + Reading Value.

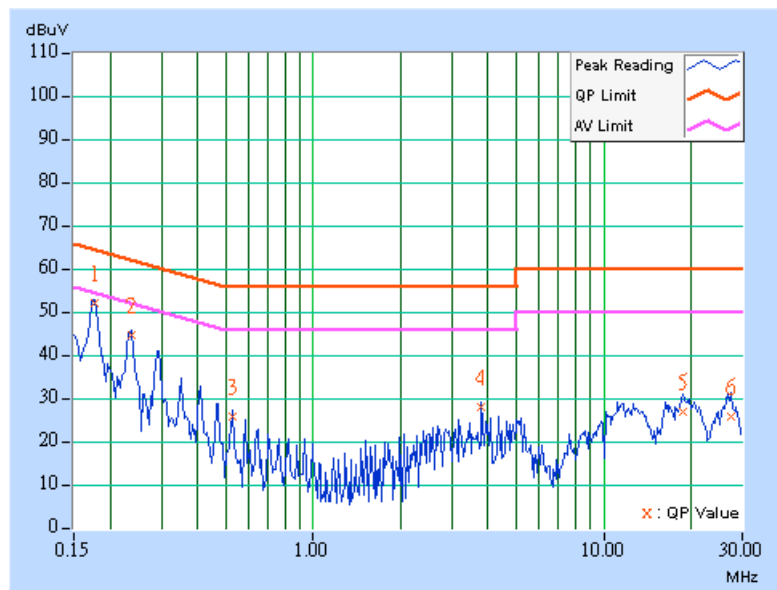



EUT	802.11b Mini PCI Card	MODEL	WL-1402
CHANNEL	6	6dB BANDWIDTH	9 kHz
INPUT POWER (SYSTEM)	120Vac, 60Hz	PHASE	Line (L)
ENVIRONMENTAL CONDITIONS	20deg. C, 65%RH, 991hPa	MODE	B
TESTED BY: Jun Wu			

No	Freq. [MHz]	Corr. Factor [dB]	Reading Value [dB (uV)]		Emission Level [dB (uV)]		Limit [dB (uV)]		Margin (dB)	
			Q.P.	AV.	Q.P.	AV.	Q.P.	AV.	Q.P.	AV.
			1	0.173	0.06	51.87	-	51.93	-	64.79
2	0.232	0.06	44.74	-	44.80	-	62.38	52.38	-17.58	-
3	0.525	0.08	28.21	-	28.29	-	56.00	46.00	-27.71	-
4	3.801	0.22	26.72	-	26.94	-	56.00	46.00	-29.06	-
5	19.348	0.63	27.16	-	27.79	-	60.00	50.00	-32.21	-
6	26.711	0.89	27.39	-	28.28	-	60.00	50.00	-31.72	-

- REMARKS:**
1. Q.P. and AV. are abbreviations of quasi-peak and average individually.
 2. "-": The Quasi-peak reading value also meets average limit and measurement with the average detector is unnecessary.
 3. The emission levels of other frequencies were very low against the limit.
 4. Margin value = Emission level - Limit value
 5. Correction factor = Insertion loss + Cable loss
 6. Emission Level = Correction Factor + Reading Value.

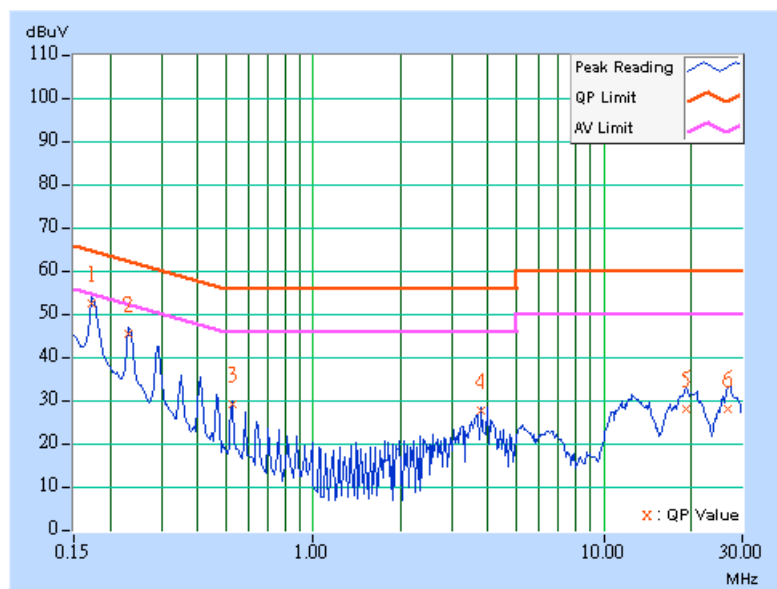



EUT	802.11b Mini PCI Card	MODEL	WL-1402
CHANNEL	6	6dB BANDWIDTH	9 kHz
INPUT POWER (SYSTEM)	120Vac, 60Hz	PHASE	Neutral (N)
ENVIRONMENTAL CONDITIONS	20deg. C, 65%RH, 991hPa	MODE	B
TESTED BY: Jun Wu			

No	Freq. [MHz]	Corr. Factor (dB)	Reading Value		Emission Level		Limit		Margin	
			[dB (uV)]		[dB (uV)]		[dB (uV)]		(dB)	
			Q.P.	AV.	Q.P.	AV.	Q.P.	AV.	Q.P.	AV.
1	0.176	0.05	52.16	-	52.21	-	64.67	54.67	-12.46	-
2	0.232	0.05	45.67	-	45.72	-	62.38	52.38	-16.66	-
3	0.525	0.07	26.64	-	26.71	-	56.00	46.00	-29.29	-
4	3.621	0.20	26.56	-	26.76	-	56.00	46.00	-29.24	-
5	19.043	0.51	26.31	-	26.82	-	60.00	50.00	-33.18	-
6	27.180	0.72	26.36	-	27.08	-	60.00	50.00	-32.92	-

- REMARKS:**
1. Q.P. and AV. are abbreviations of quasi-peak and average individually.
 2. "-": The Quasi-peak reading value also meets average limit and measurement with the average detector is unnecessary.
 3. The emission levels of other frequencies were very low against the limit.
 4. Margin value = Emission level - Limit value
 5. Correction factor = Insertion loss + Cable loss
 6. Emission Level = Correction Factor + Reading Value.

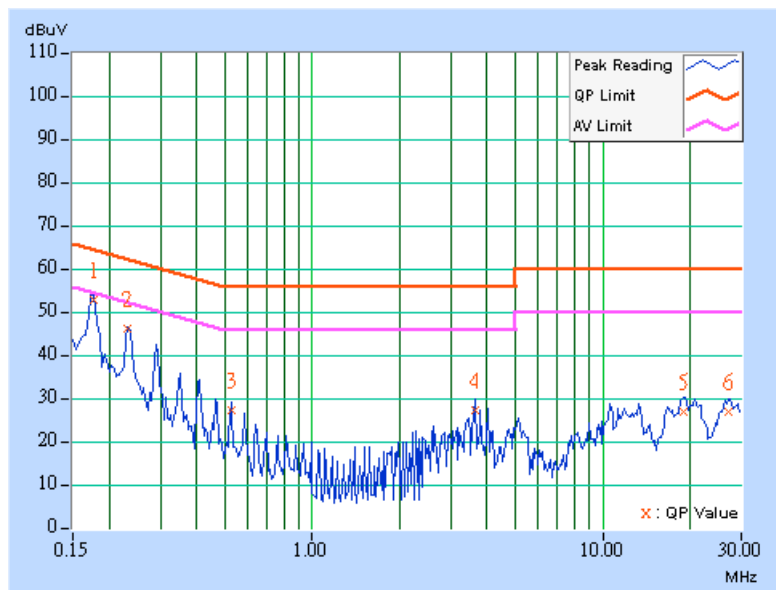



EUT	802.11b Mini PCI Card	MODEL	WL-1402
CHANNEL	11	6dB BANDWIDTH	9 kHz
INPUT POWER (SYSTEM)	120Vac, 60Hz	PHASE	Line (L)
ENVIRONMENTAL CONDITIONS	20deg. C, 65%RH, 991hPa	MODE	B
TESTED BY: Jun Wu			

No	Freq. [MHz]	Corr. Factor (dB)	Reading Value		Emission Level		Limit		Margin	
			[dB (uV)]		[dB (uV)]		[dB (uV)]		(dB)	
			Q.P.	AV.	Q.P.	AV.	Q.P.	AV.	Q.P.	AV.
1	0.173	0.06	52.48	-	52.54	-	64.79	54.79	-12.26	-
2	0.232	0.06	46.43	-	46.49	-	62.38	52.38	-15.89	-
3	0.525	0.08	28.15	-	28.23	-	56.00	46.00	-27.77	-
4	4.027	0.22	24.31	-	24.53	-	56.00	46.00	-31.47	-
5	19.023	0.62	27.42	-	28.04	-	60.00	50.00	-31.96	-
6	27.194	0.89	27.35	-	28.24	-	60.00	50.00	-31.76	-

- REMARKS:**
1. Q.P. and AV. are abbreviations of quasi-peak and average individually.
 2. "-": The Quasi-peak reading value also meets average limit and measurement with the average detector is unnecessary.
 3. The emission levels of other frequencies were very low against the limit.
 4. Margin value = Emission level - Limit value
 5. Correction factor = Insertion loss + Cable loss
 6. Emission Level = Correction Factor + Reading Value.

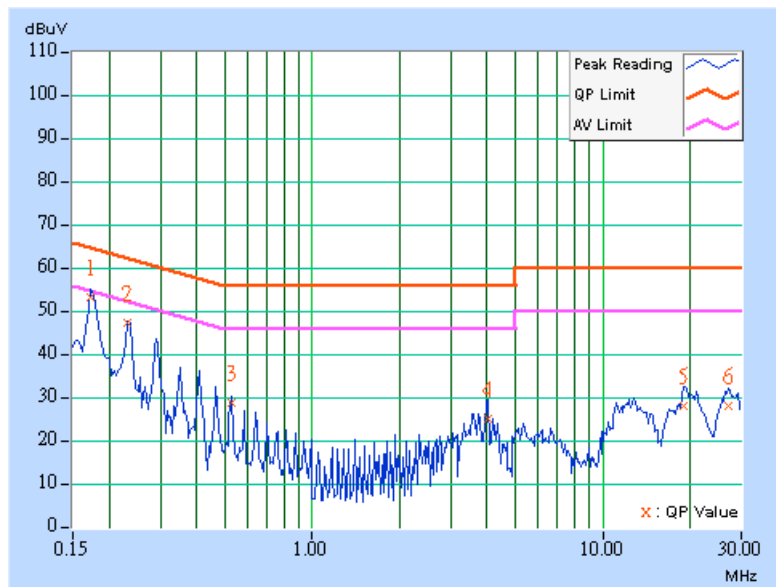



EUT	802.11b Mini PCI Card	MODEL	WL-1402
CHANNEL	11	6dB BANDWIDTH	9 kHz
INPUT POWER (SYSTEM)	120Vac, 60Hz	PHASE	Neutral (N)
ENVIRONMENTAL CONDITIONS	20deg. C, 65%RH, 991hPa	MODE	B
TESTED BY: Jun Wu			

No	Freq. [MHz]	Corr. Factor (dB)	Reading Value		Emission Level		Limit		Margin	
			[dB (uV)]		[dB (uV)]		[dB (uV)]		(dB)	
			Q.P.	AV.	Q.P.	AV.	Q.P.	AV.	Q.P.	AV.
1	0.177	0.05	52.29	-	52.34	-	64.61	54.61	-12.27	-
2	0.232	0.05	45.17	-	45.22	-	62.38	52.38	-17.16	-
3	0.525	0.07	26.91	-	26.98	-	56.00	46.00	-29.02	-
4	3.621	0.20	27.30	-	27.50	-	56.00	46.00	-28.50	-
5	19.043	0.51	27.26	-	27.77	-	60.00	50.00	-32.23	-
6	27.180	0.72	26.34	-	27.06	-	60.00	50.00	-32.94	-

- REMARKS:**
1. Q.P. and AV. are abbreviations of quasi-peak and average individually.
 2. "-": The Quasi-peak reading value also meets average limit and measurement with the average detector is unnecessary.
 3. The emission levels of other frequencies were very low against the limit.
 4. Margin value = Emission level - Limit value
 5. Correction factor = Insertion loss + Cable loss
 6. Emission Level = Correction Factor + Reading Value.

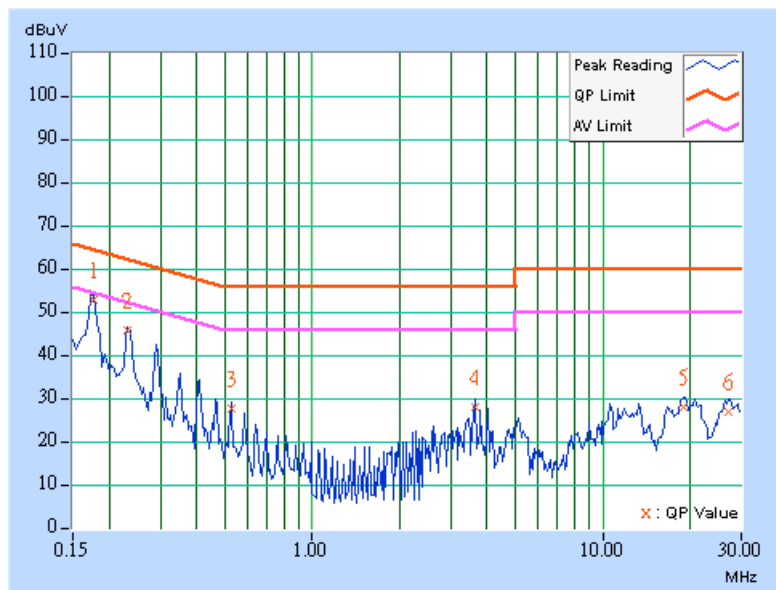



4.2 RADIATED EMISSION MEASUREMENT

4.2.1 LIMITS OF RADIATED EMISSION MEASUREMENT

Emissions radiated outside of the specified bands, shall be according to the general radiated limits in 15.209 as following:

Frequencies (MHz)	Field strength (microvolts/meter)	Measurement distance (meters)
0.009-0.490	2400/F(kHz)	300
0.490-1.705	24000/F(kHz)	30
1.705-30.0	30	30
30-88	100	3
88-216	150	3
216-960	200	3
Above 960	500	3

NOTE:

1. The lower limit shall apply at the transition frequencies.
2. Emission level (dBuV/m) = 20 log Emission level (uV/m).
3. As shown in 15.35(b), for frequencies above 1000MHz, the field strength limits are based on average detector, however, the peak field strength of any emission shall not exceed the maximum permitted average limits, specified above by more than 20dB under any condition of modulation.



4.2.2 TEST INSTRUMENTS

DESCRIPTION & MANUFACTURER	MODEL NO.	SERIAL NO.	CALIBRATED UNTIL
*HP Spectrum Analyzer	8593E	3911A07465	Jul. 07, 2004
*HP Preamplifier	8447D	2944A10386	Aug. 12, 2004
* HP Preamplifier	8449B	3008A01292	Aug. 11, 2004
SCHAFFNER Tunable Dipole Antenna	VHBA 9123	459	Jun. 26, 2004
SCHWARZBECK Tunable Dipole Antenna	UHA 9105	977	
*SCHAFFNER TEST RECEIVER	SCR 3501	409	Nov. 06, 2004
* SCHAFFNER BILOG Antenna	CBL6111C	2727	Jul. 15, 2004
* SCHWARZBECK Horn Antenna	BBHA9120-D1	D130	Jun. 30, 2004
* ADT. Turn Table	TT100	0201	NA
* ADT. Tower	AT100	0201	NA
* Software	ADT_Radiated_V5.14	NA	NA
* ANRITSU RF Switches	MP59B	6100237246	Oct. 17, 2004
* TIMES RF cable	LMR-600	CABLE-ST10-01	Oct. 17, 2004

- NOTE:**
1. The calibration interval of the above test instruments is 12 months. And the calibrations are traceable to NML/ROC and NIST/USA.
 2. "*" = These equipment are used for the final measurement.
 3. The horn antenna and HP preamplifier (model: 8449B) are used only for the measurement of emission frequency above 1GHz if tested.
 4. The test was performed in ADT Open Site No. 10.
 5. The VCCI Site Registration No. is R-1625.



4.2.3 TEST PROCEDURES

- a. The EUT was placed on the top of a rotating table 0.8 meters above the ground at a 10 meter open area test site. The table was rotated 360 degrees to determine the position of the highest radiation.
- b. The EUT was set 3 meters away from the interference-receiving antenna, which was mounted on the top of a variable-height antenna tower.
- c. The antenna is a broadband antenna, and its height is varied from one meter to four meters above the ground to determine the maximum value of the field strength. Both horizontal and vertical polarizations of the antenna are set to make the measurement.
- d. For each suspected emission, the EUT was arranged to its worst case and then the antenna was tuned to heights from 1 meter to 4 meters and the rotatable table was turned from 0 degrees to 360 degrees to find the maximum reading.
- e. The test-receiver system was set to Peak Detect Function and Specified Bandwidth with Maximum Hold Mode.
- f. If the emission level of the EUT in peak mode was 10 dB lower than the limit specified, then testing could be stopped and the peak values of the EUT would be reported. Otherwise the emissions that did not have 10 dB margin would be re-tested one by one using peak, quasi-peak or average method as specified and then reported in a data sheet.

NOTE:

1. The resolution bandwidth and video bandwidth of test receiver/spectrum analyzer is 120kHz for Peak detection (PK) and Quasi-peak detection (QP) at frequency below 1GHz.
2. The resolution bandwidth and video bandwidth of test receiver/spectrum analyzer is 1 MHz for Peak detection at frequency above 1GHz.
3. The resolution bandwidth of test receiver/spectrum analyzer is 1 MHz and the video bandwidth is 10 Hz for Average detection (AV) at frequency above 1GHz.

4.2.4 DEVIATION FROM TEST STANDARD

No deviation

4.2.5 TEST SETUP

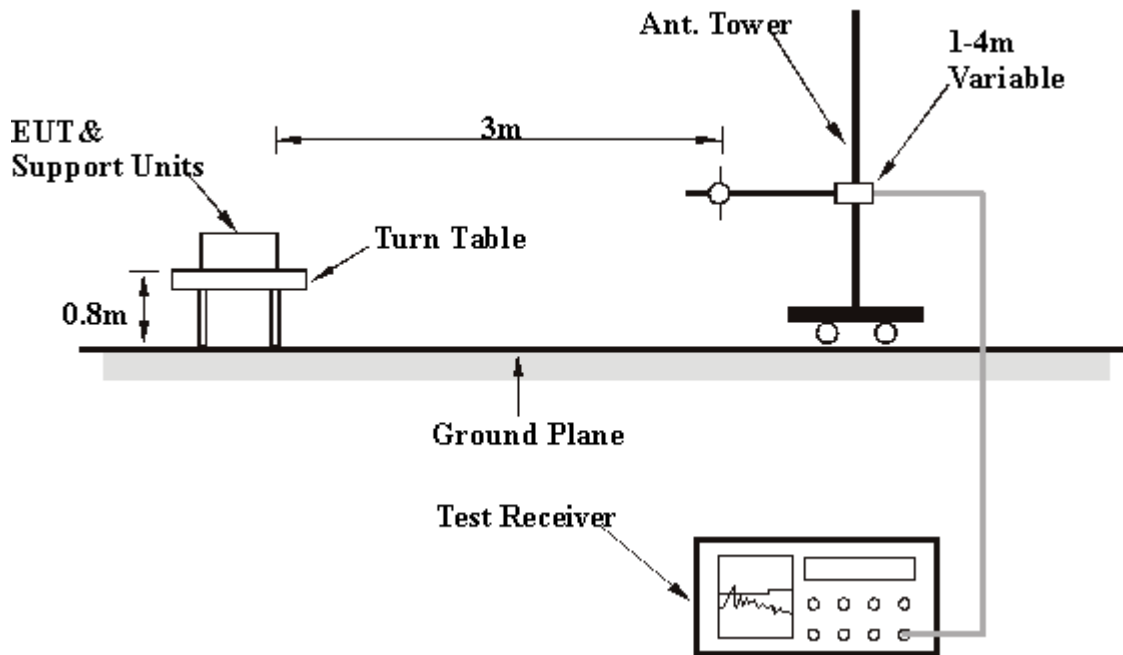

For the actual test configuration, please refer to the related item – Photographs of the Test Configuration.

4.2.6 EUT OPERATING CONDITIONS

Same as 4.1.6



4.2.7 TEST RESULTS

EUT	802.11b Mini PCI Card	MODEL	WL-1402
CHANNEL	11	FREQUENCY RANGE	Below 1000 MHz
INPUT POWER (SYSTEM)	120Vac, 60Hz	DETECTOR FUNCTION	Quasi-Peak
ENVIRONMENTAL CONDITIONS	15deg. C, 65%RH, 991hPa	MODE	A
TESTED BY: Steven Lu			

ANTENNA POLARITY & TEST DISTANCE: HORIZONTAL AT 3 M								
No.	Freq. (MHz)	Emission Level (dBuV/m)	Limit (dBuV/m)	Margin (dB)	Antenna Height (m)	Table Angle (Degree)	Raw Value (dBuV)	Correction Factor (dB/m)
1	67.09	39.24 QP	40.00	-0.76	3.00 H	67	27.56	11.68
2	99.98	40.58 QP	43.50	-2.92	2.00 H	169	31.73	8.85
3	218.56	41.88 QP	46.00	-4.12	1.25 H	46	30.80	11.08
4	350.74	36.65 QP	46.00	-9.35	1.00 H	139	20.58	16.07
5	401.28	43.80 QP	46.00	-2.20	1.00 H	127	26.27	17.53
6	457.66	39.74 QP	46.00	-6.26	2.00 H	130	21.08	18.66
7	566.51	44.82 QP	46.00	-1.18	2.00 H	124	23.70	21.13
8	601.50	36.38 QP	46.00	-9.62	1.50 H	112	14.40	21.97
9	702.59	41.58 QP	46.00	-4.42	1.25 H	160	18.56	23.02
10	834.77	33.86 QP	46.00	-12.14	4.00 H	238	8.86	25.00

- REMARKS:**
1. Emission level(dBuV/m)=Raw Value(dBuV) + Correction Factor(dB)
 2. Correction Factor(dB/m) = Antenna Factor (dB/m) + Cable Factor (dB)
 3. The other emission levels were very low against the limit.
 4. Margin value = Emission level – Limit value.



EUT	802.11b Mini PCI Card	MODEL	WL-1402
CHANNEL	11	FREQUENCY RANGE	Below 1000 MHz
INPUT POWER (SYSTEM)	120Vac, 60Hz	DETECTOR FUNCTION	Quasi-Peak
ENVIRONMENTAL CONDITIONS	15deg. C, 65%RH, 991hPa	MODE	A
TESTED BY: Steven Lu			

ANTENNA POLARITY & TEST DISTANCE: VERTICAL AT 3 M								
No.	Freq. (MHz)	Emission Level (dBuV/m)	Limit (dBuV/m)	Margin (dB)	Antenna Height (m)	Table Angle (Degree)	Raw Value (dBuV)	Correction Factor (dB/m)
1	64.99	38.54 QP	40.00	-1.46	1.00 V	64	26.49	12.04
2	98.04	30.48 QP	43.50	-13.02	4.00 V	112	21.78	8.70
3	218.56	35.25 QP	46.00	-10.75	1.00 V	19	24.17	11.08
4	298.26	34.04 QP	46.00	-11.96	1.75 V	136	18.83	15.21
5	401.28	40.87 QP	46.00	-5.13	1.25 V	40	23.34	17.53
6	455.71	41.84 QP	46.00	-4.16	1.00 V	136	23.23	18.61
7	521.80	35.54 QP	46.00	-10.46	1.00 V	352	15.31	20.23
8	566.51	39.26 QP	46.00	-6.74	1.25 V	76	18.14	21.13
9	634.55	35.25 QP	46.00	-10.75	1.75 V	124	13.19	22.06
10	702.59	35.97 QP	46.00	-10.03	1.75 V	178	12.95	23.02
11	768.68	37.05 QP	46.00	-8.95	1.75 V	127	12.55	24.50
12	834.77	33.34 QP	46.00	-12.66	1.75 V	127	8.34	25.00

- REMARKS:**
1. Emission level(dBuV/m)=Raw Value(dBuV) + Correction Factor(dB)
 2. Correction Factor(dB/m) = Antenna Factor (dB/m) + Cable Factor (dB)
 3. The other emission levels were very low against the limit.
 4. Margin value = Emission level – Limit value.



EUT	802.11b Mini PCI Card	MODEL	WL-1402
CHANNEL	11	FREQUENCY RANGE	Below 1000 MHz
INPUT POWER (SYSTEM)	120Vac, 60Hz	DETECTOR FUNCTION	Quasi-Peak
ENVIRONMENTAL CONDITIONS	15deg. C, 65%RH, 991hPa	MODE	B
TESTED BY: Steven Lu			

ANTENNA POLARITY & TEST DISTANCE: HORIZONTAL AT 3 M								
No.	Freq. (MHz)	Emission Level (dBuV/m)	Limit (dBuV/m)	Margin (dB)	Antenna Height (m)	Table Angle (Degree)	Raw Value (dBuV)	Correction Factor (dB/m)
1	100.41	43.00 QP	43.50	-0.50	2.00 H	12	34.10	8.90
2	133.03	39.95 QP	43.50	-3.55	3.00 H	172	27.45	12.49
3	232.16	40.25 QP	46.00	-5.75	1.50 H	118	28.73	11.52
4	263.27	38.56 QP	46.00	-7.44	1.50 H	154	25.70	12.86
5	333.25	36.71 QP	46.00	-9.29	1.00 H	130	20.92	15.79
6	401.28	39.76 QP	46.00	-6.24	1.00 H	220	22.22	17.53
7	457.66	39.54 QP	46.00	-6.46	1.00 H	136	20.88	18.66
8	567.17	43.61 QP	46.00	-2.39	1.50 H	120	22.47	21.14
9	601.50	36.84 QP	46.00	-9.16	1.50 H	97	14.87	21.97
10	634.55	36.69 QP	46.00	-9.31	1.50 H	118	14.63	22.06
11	702.59	41.09 QP	46.00	-4.91	1.25 H	166	18.07	23.02
12	768.68	36.14 QP	46.00	-9.86	4.00 H	310	11.64	24.50
13	834.77	32.41 QP	46.00	-13.59	4.00 H	223	7.41	25.00

- REMARKS:**
1. Emission level(dBuV/m)=Raw Value(dBuV) + Correction Factor(dB)
 2. Correction Factor(dB/m) = Antenna Factor (dB/m) + Cable Factor (dB)
 3. The other emission levels were very low against the limit.
 4. Margin value = Emission level – Limit value.



EUT	802.11b Mini PCI Card	MODEL	WL-1402
CHANNEL	11	FREQUENCY RANGE	Below 1000 MHz
INPUT POWER (SYSTEM)	120Vac, 60Hz	DETECTOR FUNCTION	Quasi-Peak
ENVIRONMENTAL CONDITIONS	15deg. C, 65%RH, 991hPa	MODE	B
TESTED BY: Steven Lu			

ANTENNA POLARITY & TEST DISTANCE: VERTICAL AT 3 M								
No.	Freq. (MHz)	Emission Level (dBuV/m)	Limit (dBuV/m)	Margin (dB)	Antenna Height (m)	Table Angle (Degree)	Raw Value (dBuV)	Correction Factor (dB/m)
1	45.55	30.42 QP	40.00	-9.58	1.00 H	304	16.67	13.75
2	99.98	38.08 QP	43.50	-5.42	4.00 H	97	29.24	8.85
3	133.03	34.31 QP	43.50	-9.19	2.00 H	295	21.82	12.49
4	263.27	34.16 QP	46.00	-11.84	1.75 H	157	21.30	12.86
5	298.26	33.60 QP	46.00	-12.40	1.75 H	157	18.39	15.21
6	401.28	39.34 QP	46.00	-6.66	1.25 H	187	21.81	17.53
7	434.33	35.32 QP	46.00	-10.68	1.00 H	172	17.17	18.16
8	457.66	41.00 QP	46.00	-5.00	1.25 H	121	22.33	18.66
9	521.80	35.94 QP	46.00	-10.06	1.75 H	319	15.72	20.23
10	566.51	42.17 QP	46.00	-3.83	1.00 H	139	21.04	21.13
11	587.90	33.20 QP	46.00	-12.80	1.00 H	346	11.54	21.66
12	634.55	34.74 QP	46.00	-11.26	1.00 H	139	12.68	22.06
13	700.64	36.48 QP	46.00	-9.52	1.00 H	142	13.52	22.96
14	768.68	32.62 QP	46.00	-13.38	2.50 H	70	8.12	24.50
15	834.77	34.01 QP	46.00	-11.99	1.00 H	139	9.01	25.00

- REMARKS:**
1. Emission level(dBuV/m)=Raw Value(dBuV) + Correction Factor(dB)
 2. Correction Factor(dB/m) = Antenna Factor (dB/m) + Cable Factor (dB)
 3. The other emission levels were very low against the limit.
 4. Margin value = Emission level – Limit value.



EUT	802.11b Mini PCI Card	MODEL	WL-1402
CHANNEL	1	FREQUENCY RANGE	1~25GHz
INPUT POWER (SYSTEM)	120Vac, 60Hz	DETECTOR FUNCTION	Peak(PK) Average (AV)
ENVIRONMENTAL CONDITIONS	20deg. C, 80%RH, 991hPa	MODE	A
TESTED BY: Jun Wu			

ANTENNA POLARITY & TEST DISTANCE: HORIZONTAL AT 3 M								
No.	Freq. (MHz)	Emission Level (dBuV/m)	Limit (dBuV/m)	Margin (dB)	Antenna Height (m)	Table Angle (Degree)	Raw Value (dBuV)	Correction Factor (dB/m)
1	2390.00	51.59 PK	74.00	-22.41	1.10 H	19	21.80	29.79
1	2390.00	42.73 AV	54.00	-11.27	1.10 H	19	12.94	29.79
2	*2412.00	107.18 PK			1.10 H	19	77.43	29.75
2	*2412.00	98.32 AV			1.10 H	19	68.57	29.75
3	3216.00	50.88 PK	74.00	-23.12	1.08 H	224	18.85	32.03
4	4824.00	49.30 PK	74.00	-24.70	1.12 H	302	14.35	34.96

ANTENNA POLARITY & TEST DISTANCE: VERTICAL AT 3 M								
No.	Freq. (MHz)	Emission Level (dBuV/m)	Limit (dBuV/m)	Margin (dB)	Antenna Height (m)	Table Angle (Degree)	Raw Value (dBuV)	Correction Factor (dB/m)
1	2390.00	48.54 PK	74.00	-25.46	1.00 V	160	18.75	29.79
2	*2412.00	104.13 PK			1.00 V	160	74.38	29.75
2	*2412.00	96.16 AV			1.00 V	160	66.41	29.75
3	3216.00	46.28 PK	74.00	-27.72	1.00 V	24	14.25	32.03
4	4824.00	48.67 PK	74.00	-25.33	1.06 V	116	13.72	34.96
5	7235.00	56.55 PK	74.00	-17.45	1.24 V	360	15.10	41.46
5	7235.00	43.33 AV	54.00	-10.67	1.24 V	360	1.88	41.46

REMARKS:

1. Emission level(dBuV/m)=Raw Value(dBuV) + Correction Factor(dB)
2. Correction Factor(dB/m) = Antenna Factor (dB/m) + Cable Factor (dB)
3. The other emission levels were very low against the limit.
4. Margin value = Emission level – Limit value.
5. " * " : Fundamental frequency



EUT	802.11b Mini PCI Card	MODEL	WL-1402
CHANNEL	6	FREQUENCY RANGE	1~25GHz
INPUT POWER (SYSTEM)	120Vac, 60Hz	DETECTOR FUNCTION	Peak(PK) Average (AV)
ENVIRONMENTAL CONDITIONS	20deg. C, 80%RH, 991hPa	MODE	A
TESTED BY: Jun Wu			

ANTENNA POLARITY & TEST DISTANCE: HORIZONTAL AT 3 M								
No.	Freq. (MHz)	Emission Level (dBuV/m)	Limit (dBuV/m)	Margin (dB)	Antenna Height (m)	Table Angle (Degree)	Raw Value (dBuV)	Correction Factor (dB/m)
1	*2437.00	105.01 PK			1.26 H	321	75.17	29.84
1	*2437.00	97.34 AV			1.26 H	321	67.50	29.84
2	3249.00	46.13 PK	74.00	-27.87	1.26 H	320	14.03	32.10
3	4874.00	44.04 PK	74.00	-29.96	1.25 H	141	8.90	35.14

ANTENNA POLARITY & TEST DISTANCE: VERTICAL AT 3 M								
No.	Freq. (MHz)	Emission Level (dBuV/m)	Limit (dBuV/m)	Margin (dB)	Antenna Height (m)	Table Angle (Degree)	Raw Value (dBuV)	Correction Factor (dB/m)
1	*2437.00	73.09 PK			1.00 V	340	43.24	29.84
1	*2437.00	64.26 AV			1.00 V	340	34.41	29.84
2	3249.00	44.47 PK	74.00	-29.53	1.00 V	185	12.37	32.10
3	4874.00	42.74 PK	74.00	-31.26	1.14 V	84	7.60	35.14
4	7310.00	51.35 PK	74.00	-22.65	1.36 V	210	9.81	41.55
4	7310.00	46.50 AV	54.00	-7.50	1.36 V	210	4.95	41.55

REMARKS:

1. Emission level(dBuV/m)=Raw Value(dBuV) + Correction Factor(dB)
2. Correction Factor(dB/m) = Antenna Factor (dB/m) + Cable Factor (dB)
3. The other emission levels were very low against the limit.
4. Margin value = Emission level – Limit value.
5. “ * “ : Fundamental frequency



EUT	802.11b Mini PCI Card	MODEL	WL-1402
CHANNEL	11	FREQUENCY RANGE	1~25GHz
INPUT POWER (SYSTEM)	120Vac, 60Hz	DETECTOR FUNCTION	Peak(PK) Average (AV)
ENVIRONMENTAL CONDITIONS	20deg. C, 80%RH, 991hPa	MODE	A

TESTED BY: Jun Wu

ANTENNA POLARITY & TEST DISTANCE: HORIZONTAL AT 3 M								
No.	Freq. (MHz)	Emission Level (dBuV/m)	Limit (dBuV/m)	Margin (dB)	Antenna Height (m)	Table Angle (Degree)	Raw Value (dBuV)	Correction Factor (dB/m)
1	*2462.00	104.43 PK			1.18 H	349	74.50	29.93
1	*2462.00	97.43 AV			1.18 H	349	67.50	29.93
2	2483.50	49.51 PK	74.00	-24.49	1.18 H	349	19.50	30.01
3	3280.00	45.21 PK	74.00	-28.79	1.12 H	224	13.05	32.16
4	4924.00	44.42 PK	74.00	-29.58	1.19 H	354	9.10	35.32

ANTENNA POLARITY & TEST DISTANCE: VERTICAL AT 3 M								
No.	Freq. (MHz)	Emission Level (dBuV/m)	Limit (dBuV/m)	Margin (dB)	Antenna Height (m)	Table Angle (Degree)	Raw Value (dBuV)	Correction Factor (dB/m)
1	*2462.00	109.26 PK			1.13 V	311	79.33	29.93
1	*2462.00	101.76 AV			1.13 V	311	71.83	29.93
2	2483.50	54.34 PK	74.00	-19.66	1.13 V	311	24.33	30.01
2	2483.50	46.84 AV	54.00	-7.16	1.13 V	311	16.83	30.01
3	3282.00	39.98 PK	74.00	-34.02	1.08 V	128	7.82	32.16
4	4924.00	43.92 PK	74.00	-30.08	1.24 V	142	8.60	35.32
5	7385.00	49.18 PK	74.00	-24.82	1.37 V	179	7.45	41.73

REMARKS:

1. Emission level(dBuV/m)=Raw Value(dBuV) + Correction Factor(dB)
2. Correction Factor(dB/m) = Antenna Factor (dB/m) + Cable Factor (dB)
3. The other emission levels were very low against the limit.
4. Margin value = Emission level – Limit value.
5. “ * “ : Fundamental frequency



EUT	802.11b Mini PCI Card	MODEL	WL-1402
CHANNEL	1	FREQUENCY RANGE	1~25GHz
INPUT POWER (SYSTEM)	120Vac, 60Hz	DETECTOR FUNCTION	Peak(PK) Average (AV)
ENVIRONMENTAL CONDITIONS	21deg. C, 70%RH, 991hPa	MODE	B
TESTED BY: Martin Lee			

ANTENNA POLARITY & TEST DISTANCE: HORIZONTAL AT 3 M								
No.	Freq. (MHz)	Emission Level (dBuV/m)	Limit (dBuV/m)	Margin (dB)	Antenna Height (m)	Table Angle (Degree)	Raw Value (dBuV)	Correction Factor (dB/m)
1	2390.00	50.15PK	74.00	-23.85	1.17 H	356	19.85	30.30
1	2390.00	42.07 AV	54.00	-11.93	1.17 H	356	11.77	30.30
2	*2412.00	105.74 PK	74.00		1.17 H	356	75.50	30.24
2	*2412.00	97.66 AV	54.00		1.17 H	356	67.42	30.24
3	3216.00	49.44 PK	74.00	-24.56	1.42 H	247	15.81	33.63
3	3216.00	39.37 AV	54.00	-14.63	1.42 H	247	5.74	33.63
4	7236.00	51.12 PK	74.00	-22.88	1.00 H	20	9.71	41.41
4	7236.00	37.89 AV	54.00	-16.11	1.00 H	20	-3.52	41.41

ANTENNA POLARITY & TEST DISTANCE: VERTICAL AT 3 M								
No.	Freq. (MHz)	Emission Level (dBuV/m)	Limit (dBuV/m)	Margin (dB)	Antenna Height (m)	Table Angle (Degree)	Raw Value (dBuV)	Correction Factor (dB/m)
1	2390.00	52.74 PK	74.00	-21.26	1.16 V	7	22.44	29.79
1	2390.00	44.35 AV	54.00	-9.65	1.16 V	7	14.05	
2	*2412.00	108.33 PK			1.16 V	7	78.09	29.75
2	*2412.00	99.94 AV			1.16 V	7	69.70	29.75
3	3216.00	49.81 PK	74.00	-24.19	1.17 V	356	16.18	32.03
3	3216.00	44.14 AV	54.00	-9.86	1.17 V	356	10.51	
4	4824.00	46.89 PK	74.00	-27.11	1.36 V	157	10.37	34.96
4	4824.00	33.92 AV	54.00	-20.08	1.36 V	157	-2.60	
5	7261.00	53.52 PK	74.00	-20.48	1.18 V	25	12.09	41.46
5	7261.00	39.27 AV	54.00	-14.73	1.18 V	25	-2.16	41.46

REMARKS:

1. Emission level(dBuV/m)=Raw Value(dBuV) + Correction Factor(dB)
2. Correction Factor(dB/m) = Antenna Factor (dB/m) + Cable Factor (dB)
3. The other emission levels were very low against the limit.
4. Margin value = Emission level – Limit value.
5. “ * “ : Fundamental frequency



EUT	802.11b Mini PCI Card	MODEL	WL-1402
CHANNEL	6	FREQUENCY RANGE	1~25GHz
INPUT POWER (SYSTEM)	120Vac, 60Hz	DETECTOR FUNCTION	Peak(PK) Average (AV)
ENVIRONMENTAL CONDITIONS	21deg. C, 70%RH, 991hPa	MODE	B
TESTED BY: Martin Lee			

ANTENNA POLARITY & TEST DISTANCE: HORIZONTAL AT 3 M								
No.	Freq. (MHz)	Emission Level (dBuV/m)	Limit (dBuV/m)	Margin (dB)	Antenna Height (m)	Table Angle (Degree)	Raw Value (dBuV)	Correction Factor (dB/m)
1	*2437.00	104.99 PK			1.00 H	254	74.68	30.31
1	*2437.00	96.72 AV			1.00 H	254	66.41	30.31
2	3249.00	50.27 PK	74.00	-23.73	1.37 H	52	16.67	33.60
2	3249.00	45.69 AV	54.00	-8.31	1.37 H	52	12.09	33.60
3	4874.00	45.93 PK	74.00	-28.07	1.25 H	54	9.24	36.69
3	4874.00	33.45 AV	54.00	-20.55	1.25 H	54	-3.24	36.69

ANTENNA POLARITY & TEST DISTANCE: VERTICAL AT 3 M								
No.	Freq. (MHz)	Emission Level (dBuV/m)	Limit (dBuV/m)	Margin (dB)	Antenna Height (m)	Table Angle (Degree)	Raw Value (dBuV)	Correction Factor (dB/m)
1	*2437.00	107.46 PK			1.00 V	154	77.15	30.31
1	*2437.00	99.70 AV			1.00 V	154	69.39	30.31
2	3249.00	49.30 PK	74.00	-24.70	1.37 V	52	15.70	33.60
2	3249.00	44.03 PK	54.00	-9.97	1.37 V	52	10.43	33.60
3	7311.00	53.20 PK	74.00	-20.80	1.00 V	154	11.71	41.49
3	7311.00	38.97 AV	54.00	-15.03	1.00 V	154	-2.52	41.49

REMARKS:

1. Emission level(dBuV/m)=Raw Value(dBuV) + Correction Factor(dB)
2. Correction Factor(dB/m) = Antenna Factor (dB/m) + Cable Factor (dB)
3. The other emission levels were very low against the limit.
4. Margin value = Emission level – Limit value.
5. “ * “ : Fundamental frequency



EUT	802.11b Mini PCI Card	MODEL	WL-1402
CHANNEL	11	FREQUENCY RANGE	1~25GHz
INPUT POWER (SYSTEM)	120Vac, 60Hz	DETECTOR FUNCTION	Peak(PK) Average (AV)
ENVIRONMENTAL CONDITIONS	21deg. C, 70%RH, 991hPa	MODE	B

TESTED BY: Martin Lee

ANTENNA POLARITY & TEST DISTANCE: HORIZONTAL AT 3 M								
No.	Freq. (MHz)	Emission Level (dBuV/m)	Limit (dBuV/m)	Margin (dB)	Antenna Height (m)	Table Angle (Degree)	Raw Value (dBuV)	Correction Factor (dB/m)
1	*2462.00	103.75 PK			1.14 H	36	73.38	30.37
1	*2462.00	95.85 AV			1.14 H	36	65.48	30.37
2	2483.50	48.83 PK	74.00	-25.17	1.14 H	36	18.40	30.43
2	2483.50	40.93 AV	54.00	-13.07	1.14 H	36	10.50	30.43
3	3280.00	50.54 PK	74.00	-23.46	1.00 H	298	16.97	33.57
3	3282.00	43.61 AV	54.00	-10.39	1.00 H	298	10.04	33.57
4	4924.00	47.09 PK	74.00	-26.91	1.00 H	0	10.24	36.85
	4924.00	33.45 AV	54.00	-20.55	1.00 H	0	-3.40	36.85

ANTENNA POLARITY & TEST DISTANCE: VERTICAL AT 3 M								
No.	Freq. (MHz)	Emission Level (dBuV/m)	Limit (dBuV/m)	Margin (dB)	Antenna Height (m)	Table Angle (Degree)	Raw Value (dBuV)	Correction Factor (dB/m)
1	*2462.00	108.65 PK			1.00 V	354	78.28	30.37
1	*2462.00	100.30 AV			1.00 V	354	69.93	30.37
2	2483.50	53.73 PK	74.00	-20.27	1.00 V	354	23.30	30.43
2	2483.50	45.38 AV	54.00	-8.62	1.00 V	354	14.95	30.43
3	3282.00	50.31 PK	74.00	-23.69	1.15 V	222	33.57	33.57
3	3282.00	45.91 AV	54.00	-8.09	1.15 V	222	16.74	33.57
4	7386.00	52.05 PK	74.00	-21.95	1.31 V	18	41.66	41.66
5	7386.00	38.66 PK	54.00	-15.34	1.31 V	18	10.39	41.66

REMARKS:

1. Emission level(dBuV/m)=Raw Value(dBuV) + Correction Factor(dB)
2. Correction Factor(dB/m) = Antenna Factor (dB/m) + Cable Factor (dB)
3. The other emission levels were very low against the limit.
4. Margin value = Emission level – Limit value.
5. “ * “ : Fundamental frequency



4.3 6dB BANDWIDTH MEASUREMENT

4.3.1 LIMITS OF 6dB BANDWIDTH MEASUREMENT

The minimum of 6dB Bandwidth Measurement is 0.5 MHz.

4.3.2 TEST INSTRUMENTS

Description & Manufacturer	Model No.	Serial No.	Calibrated Until
SPECTRUM ANALYZER	FSEK30	100049	August 12, 2004

NOTE:

The calibration interval of the above test instruments is 12 months and the calibrations are traceable to NML/ROC and NIST/USA.

4.3.3 TEST PROCEDURE

The transmitter output was connected to the spectrum analyzer through an attenuator. The bandwidth of the fundamental frequency was measured by spectrum analyzer with 100 kHz RBW and 100 kHz VBW. The 6 dB bandwidth is defined as the total spectrum the power of which is higher than peak power minus 6 dB.

4.3.4 DEVIATION FROM TEST STANDARD

No deviation

4.3.5 TEST SETUP

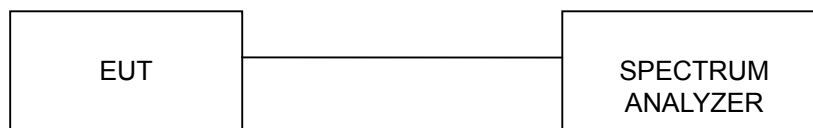

For the actual test configuration, please refer to the related Item – Photographs of the Test Configuration.

4.3.6 EUT OPERATING CONDITIONS

The software provided by client to enable the EUT under transmission condition continuously at lowest, middle and highest channel frequencies individually.



4.3.7 TEST RESULTS

EUT	802.11b Mini PCI Card	MODEL	WL-1402
INPUT POWER (SYSTEM)	120Vac, 60Hz	ENVIRONMENTAL CONDITIONS	20deg. C, 63%RH, 991hPa
TESTED BY: Stanely Hsu			

CHANNEL	CHANNEL FREQUENCY (MHz)	6dB BANDWIDTH (MHz)	MINIMUM LIMIT (MHz)	PASS/FAIL
1	2412	8.76	0.5	PASS
6	2437	8.68	0.5	PASS
11	2462	8.68	0.5	PASS



CH1

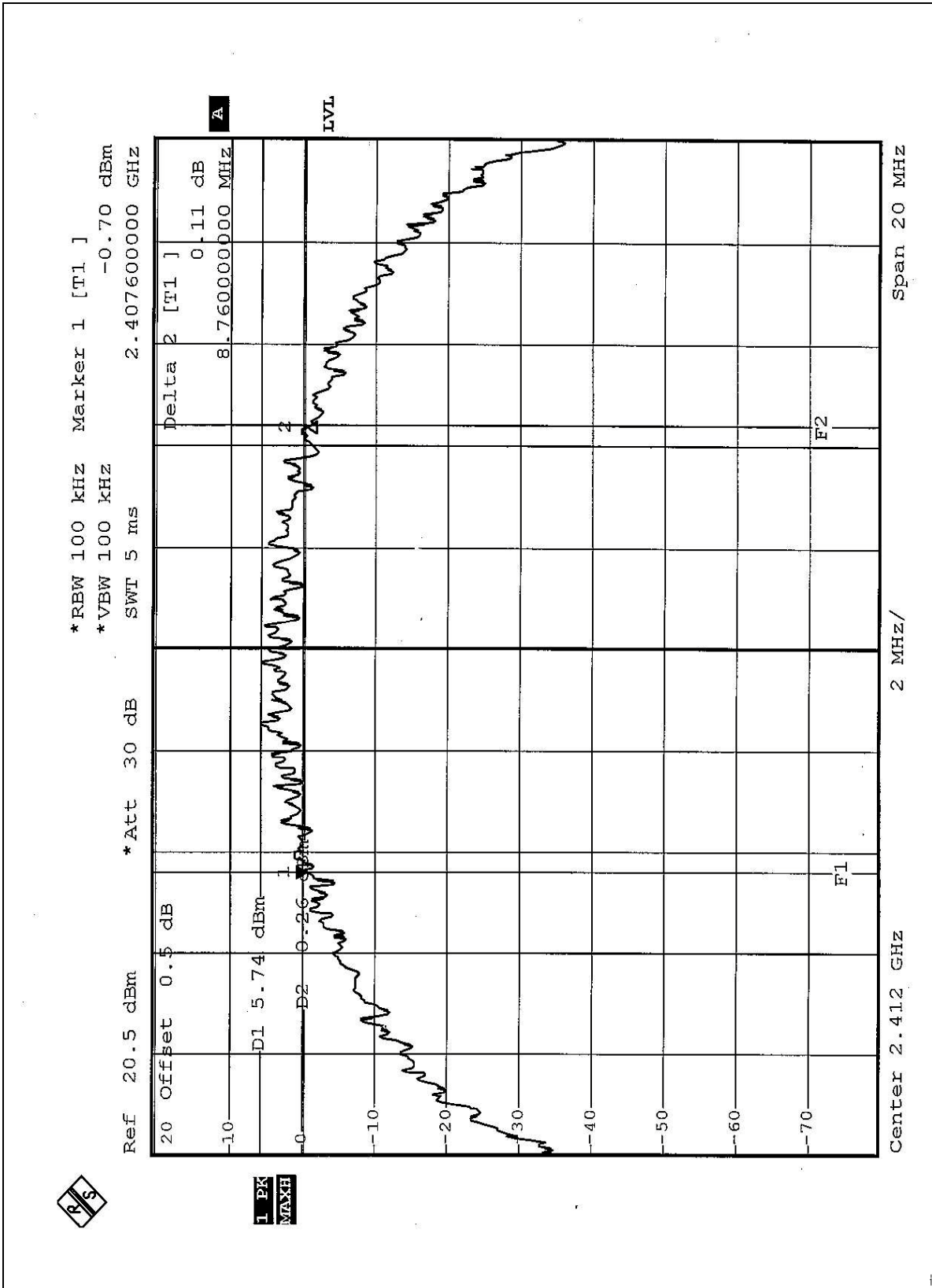



CH6

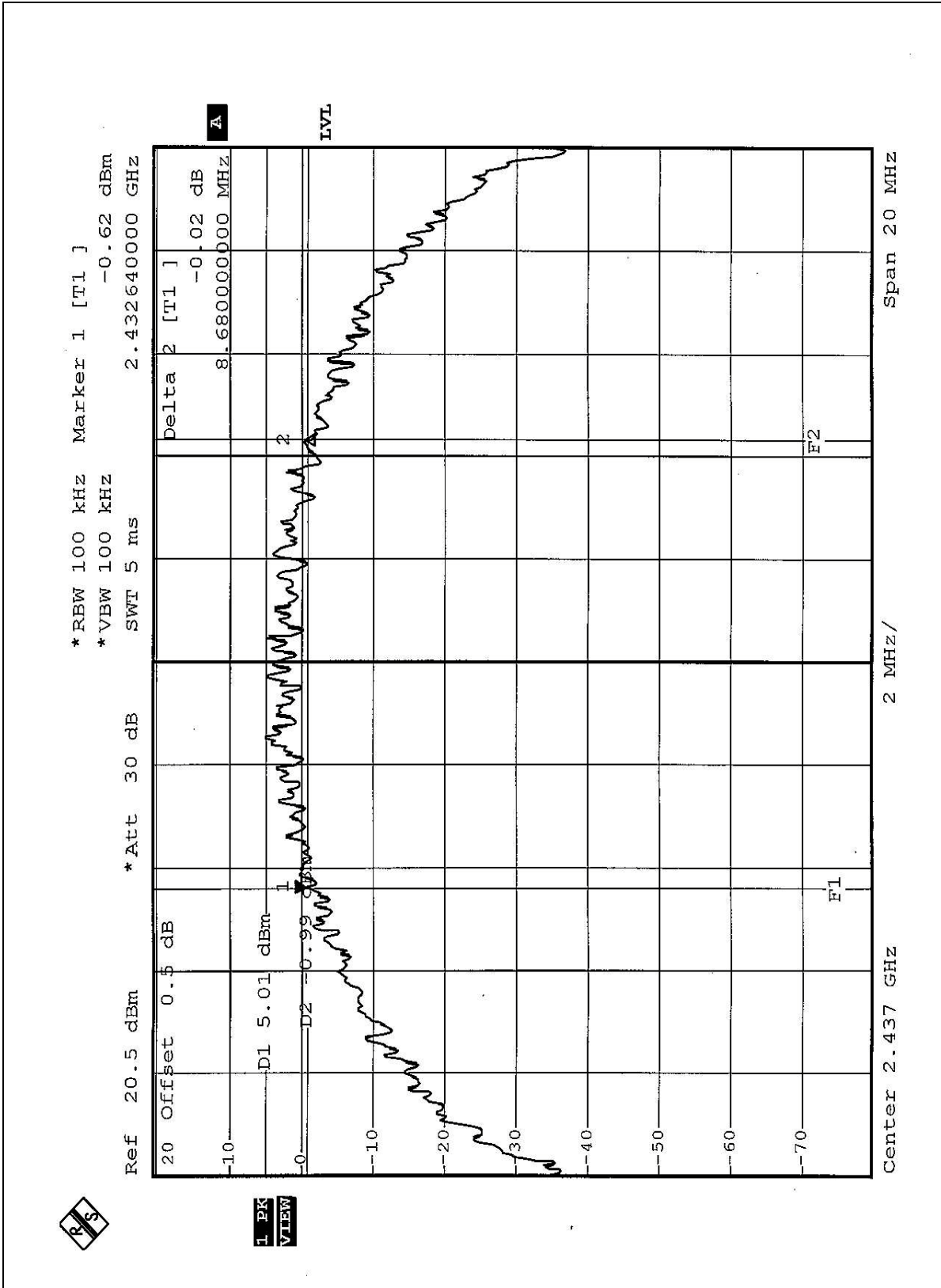



CH11

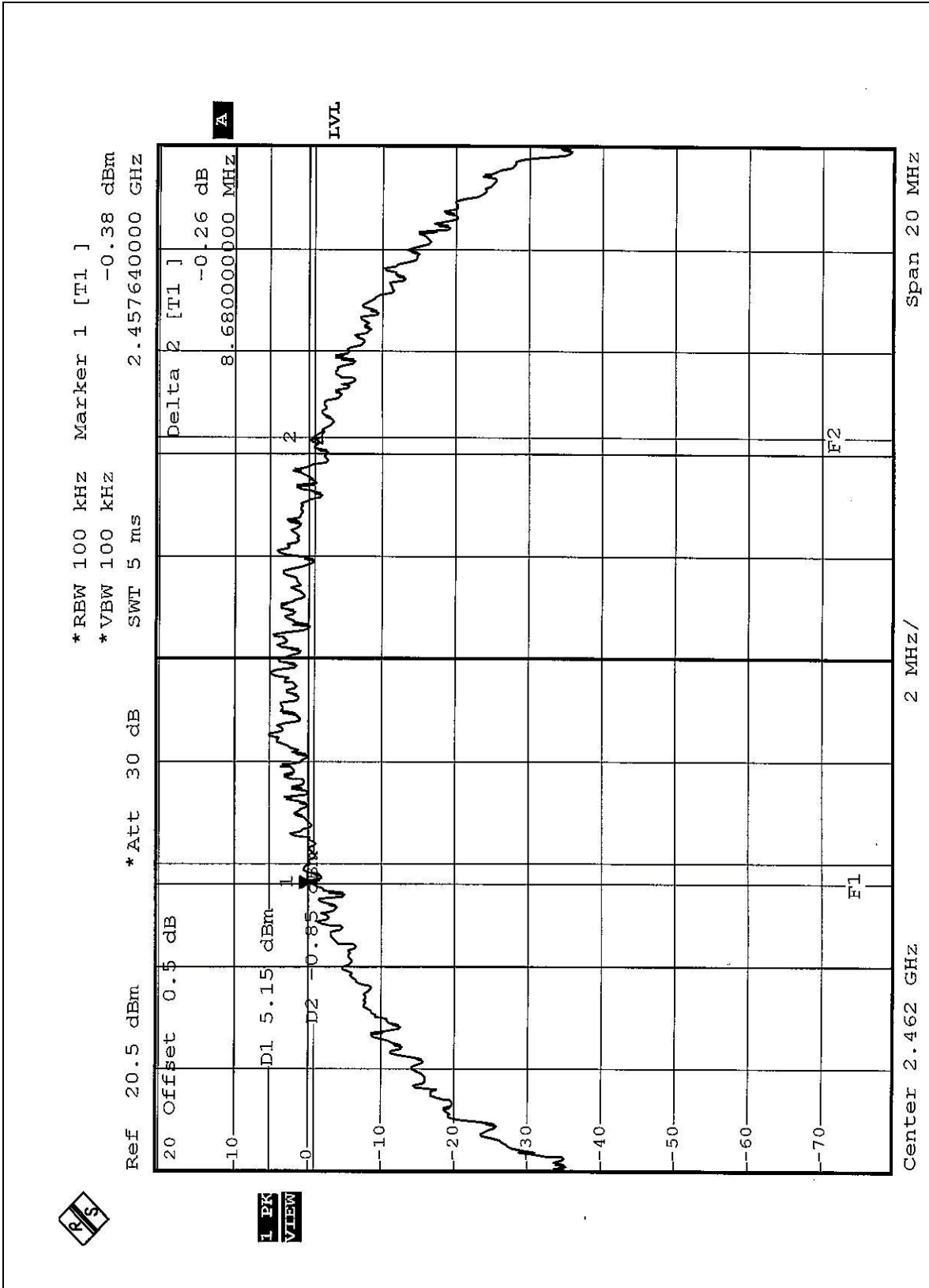



4.4 MAXIMUM PEAK OUTPUT POWER

4.4.1 LIMITS OF MAXIMUM PEAK OUTPUT POWER MEASUREMENT

The Maximum Peak Output Power Measurement is 30dBm.

4.4.2 TEST INSTRUMENTS

Description & Manufacturer	Model No.	Serial No.	Calibrated Until
R&S SPECTRUM ANALYZER	FSEK30	100049	August 12, 2004
R&S SIGNAL GENERATOR	SMP04	100011	May 28, 2004
TEKTRONIX OSCILLOSCOPE	TDS 1012	C30657	Mar. 19, 2004
NARDA DETECTOR	4503A	FSCM99899	NA

NOTE:

The calibration interval of the above test instruments is 12 months and the calibrations are traceable to NML/ROC and NIST/USA.



4.4.3 TEST PROCEDURES

1. A detector was used on the output port of the EUT. An oscilloscope was used to read the response of the detector.
2. Replaced the EUT by the signal generator. The center frequency of the S.G was adjusted to the center frequency of the measured channel.
3. Adjusted the power to have the same reading on oscilloscope. Record the power level.

4.4.4 DEVIATION FROM TEST STANDARD

No deviation

4.4.5 TEST SETUP

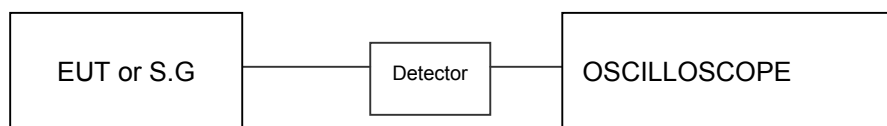

4.4.6 EUT OPERATING CONDITIONS

Same as Item 4.3.6



4.4.7 TEST RESULTS

EUT	802.11b Mini PCI Card	MODEL	WL-1402
INPUT POWER (SYSTEM)	120Vac, 60Hz	ENVIRONMENTAL CONDITIONS	20deg. C, 63RH, 991hPa
TESTED BY: Stanely Hsu			

CHANNEL	CHANNEL FREQUENCY (MHz)	PEAK POWER OUTPUT (dBm)	PEAK POWER LIMIT (dBm)	PASS/FAIL
1	2412	17.22	30	PASS
6	2437	17.10	30	PASS
11	2462	17.14	30	PASS



4.5 POWER SPECTRAL DENSITY MEASUREMENT

4.5.1 LIMITS OF POWER SPECTRAL DENSITY MEASUREMENT

The Maximum of Power Spectral Density Measurement is 8dBm.

4.5.2 TEST INSTRUMENTS

Description & Manufacturer	Model No.	Serial No.	Calibrated Until
SPECTRUM ANALYZER	FSEK30	100049	August 12, 2004

NOTE:

The calibration interval of the above test instruments is 12 months and the calibrations are traceable to NML/ROC and NIST/USA.

4.5.3 TEST PROCEDURE

The transmitter output was connected to the spectrum analyzer through an attenuator, the bandwidth of the fundamental frequency was measured with the spectrum analyzer using 3 kHz RBW and 30 kHz VBW, set sweep time=span/3kHz. The power spectral density was measured and recorded. The sweep time is allowed to be longer than span/3KHz for a full response of the mixer in the spectrum analyzer.

4.5.4 DEVIATION FROM TEST STANDARD

No deviation

4.5.5 TEST SETUP

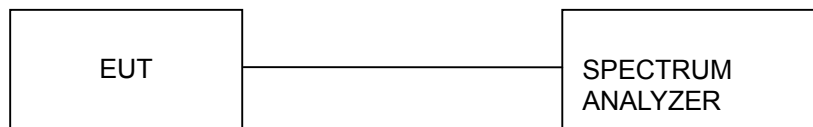

4.5.6 EUT OPERATING CONDITIONS

Same as 4.3.6



4.5.7 TEST RESULTS

EUT	802.11b Mini PCI Card	MODEL	WL-1402
INPUT POWER (SYSTEM)	120Vac, 60 Hz	ENVIRONMENTAL CONDITIONS	20deg. C, 63%RH, 991hPa
TESTED BY: Stanely Hsu			

CHANNEL NUMBER	CHANNEL FREQUENCY (MHz)	RF POWER LEVEL IN 3KHz BW (dBm)	MAXIMUM LIMIT (dBm)	PASS/FAIL
1	2412	-5.18	8	PASS
6	2437	-5.88	8	PASS
11	2462	-5.88	8	PASS



CH1

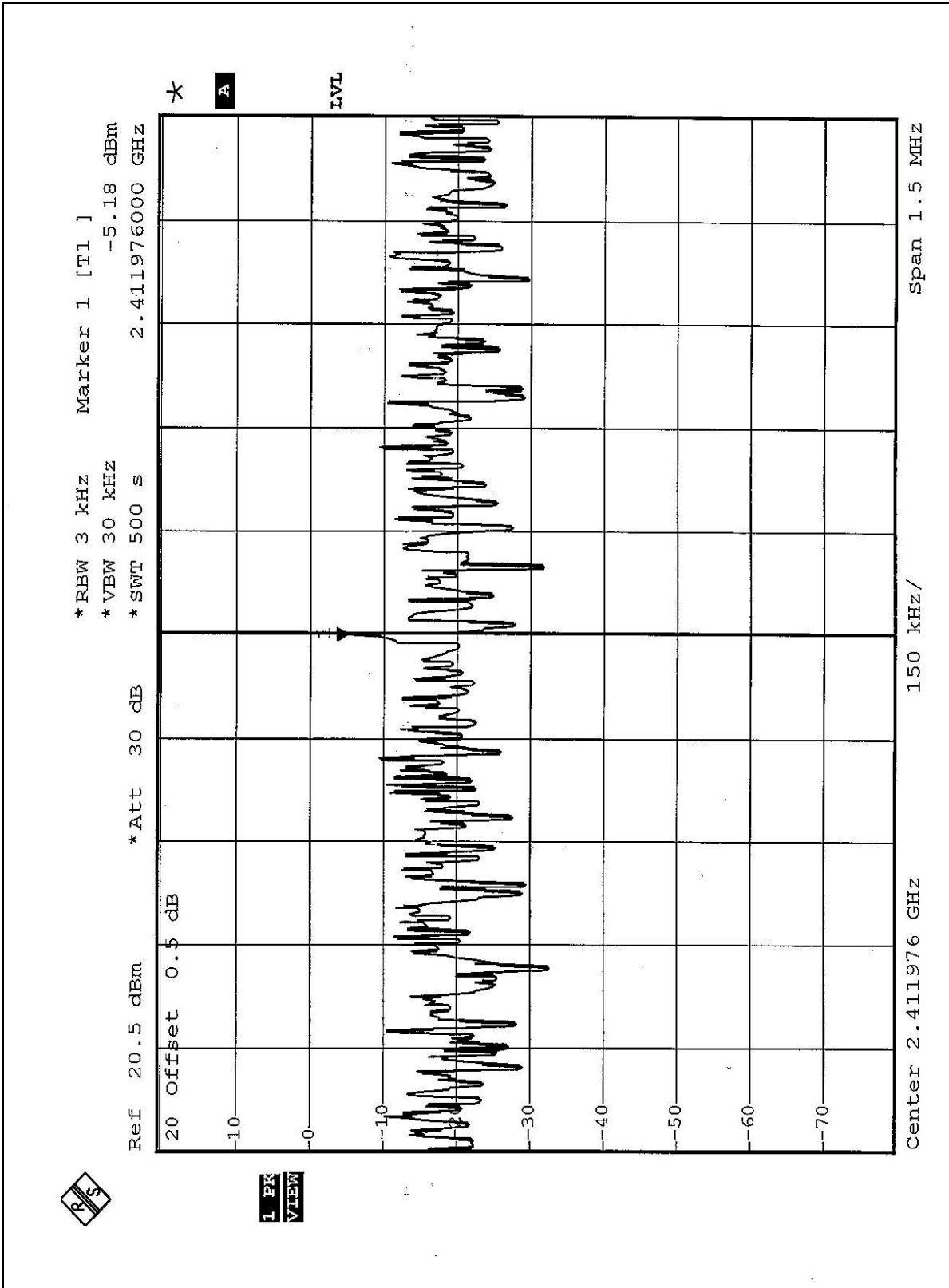



CH6

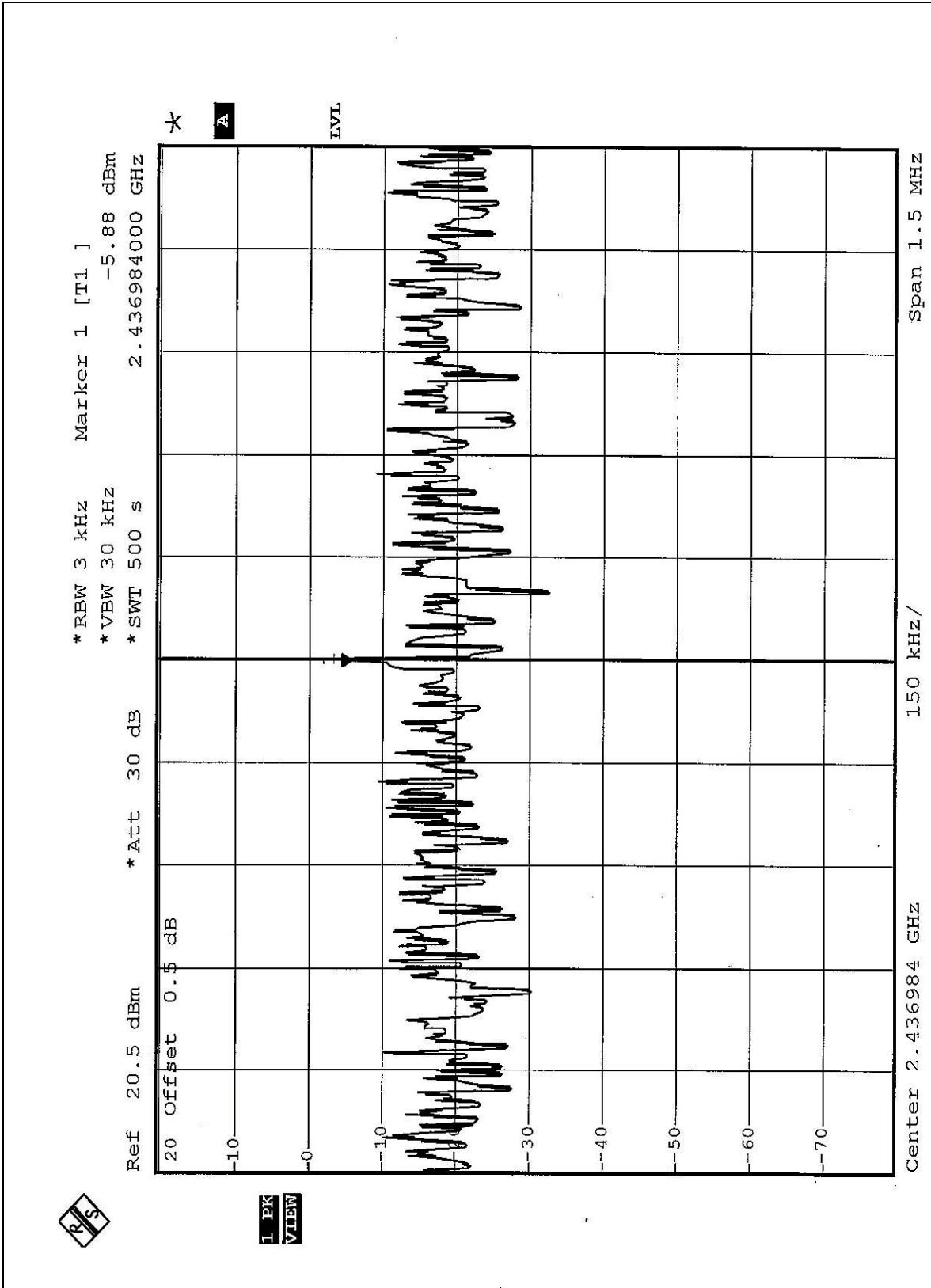



CH11

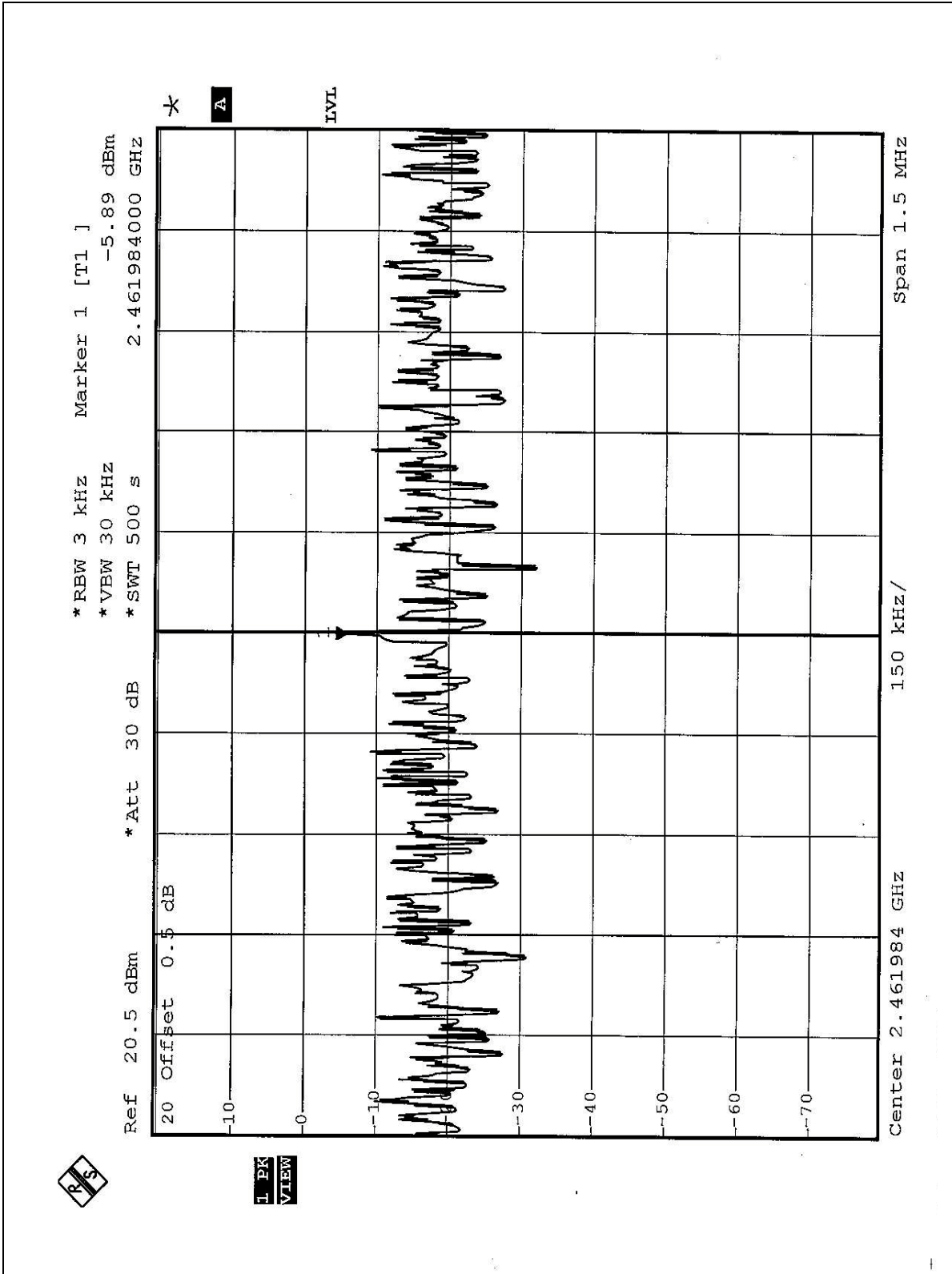



4.6 BAND EDGES MEASUREMENT

4.6.1 LIMITS OF BAND EDGES MEASUREMENT

Below -20dB of the highest emission level of operating band (in 100KHz Resolution Bandwidth).

4.6.2 TEST INSTRUMENTS

Description & Manufacturer	Model No.	Serial No.	Calibrated Until
SPECTRUM ANALYZER	FSEK30	100049	August 12, 2004

NOTE:

The calibration interval of the above test instruments is 12 months and the calibrations are traceable to NML/ROC and NIST/USA.

4.6.3 TEST PROCEDURE

The transmitter output was connected to the spectrum analyzer via a low lose cable. Set both RBW and VBW of spectrum analyzer to 100kHz with suitable frequency span including 100MHz bandwidth from band edge. The band edges was measured and recorded.

4.6.4 DEVIATION FROM TEST STANDARD

No deviation

4.6.5 EUT OPERATING CONDITION

Same as Item 4.3.6



4.6.6 TEST RESULTS

The spectrum plots are attached on the following 4 pages. D2 line indicates the highest level, D1 line indicates the 20dB offset below D2. It shows compliance with the requirement in part 15.247(C).

NOTE 1 (FOR ANTENNA 1):

The band edge emission plot on the following 1~2 pages show 52.52dB delta between carrier maximum power and local maximum emission in restrict band (2.3898GHz). The emission of carrier strength list in the test result of channel 1 at the item 4.2.6 is 98.32dBuV/m, so the maximum field strength in restrict band is $98.32-52.52=45.80$ dBuV/m which is under 54 dBuV/m limit.

The band edge emission plot on the following 3~4 pages show 50.17dB delta between carrier maximum power and local maximum emission in restrict band (2.4838GHz). The emission of carrier strength list in the test result of channel 11 at the item 4.2.6 is 101.76dBuV/m, so the maximum field strength in restrict band is $101.76-50.17=51.59$ dBuV/m which is under 54 dBuV/m limit.

NOTE 2 (FOR ANTENNA 2):

The band edge emission plot on the following 1~2 pages show 52.52dB delta between carrier maximum power and local maximum emission in restrict band (2.3898GHz). The emission of carrier strength list in the test result of channel 1 at the item 4.2.6 is 99.94dBuV/m, so the maximum field strength in restrict band is $99.94-52.52=47.42$ dBuV/m which is under 54 dBuV/m limit.

The band edge emission plot on the following 3~4 pages show 50.17dB delta between carrier maximum power and local maximum emission in restrict band (2.4838GHz). The emission of carrier strength list in the test result of channel 11 at the item 4.2.6 is 100.30dBuV/m, so the maximum field strength in restrict band is $100.30-50.17=50.13$ dBuV/m which is under 54 dBuV/m limit.

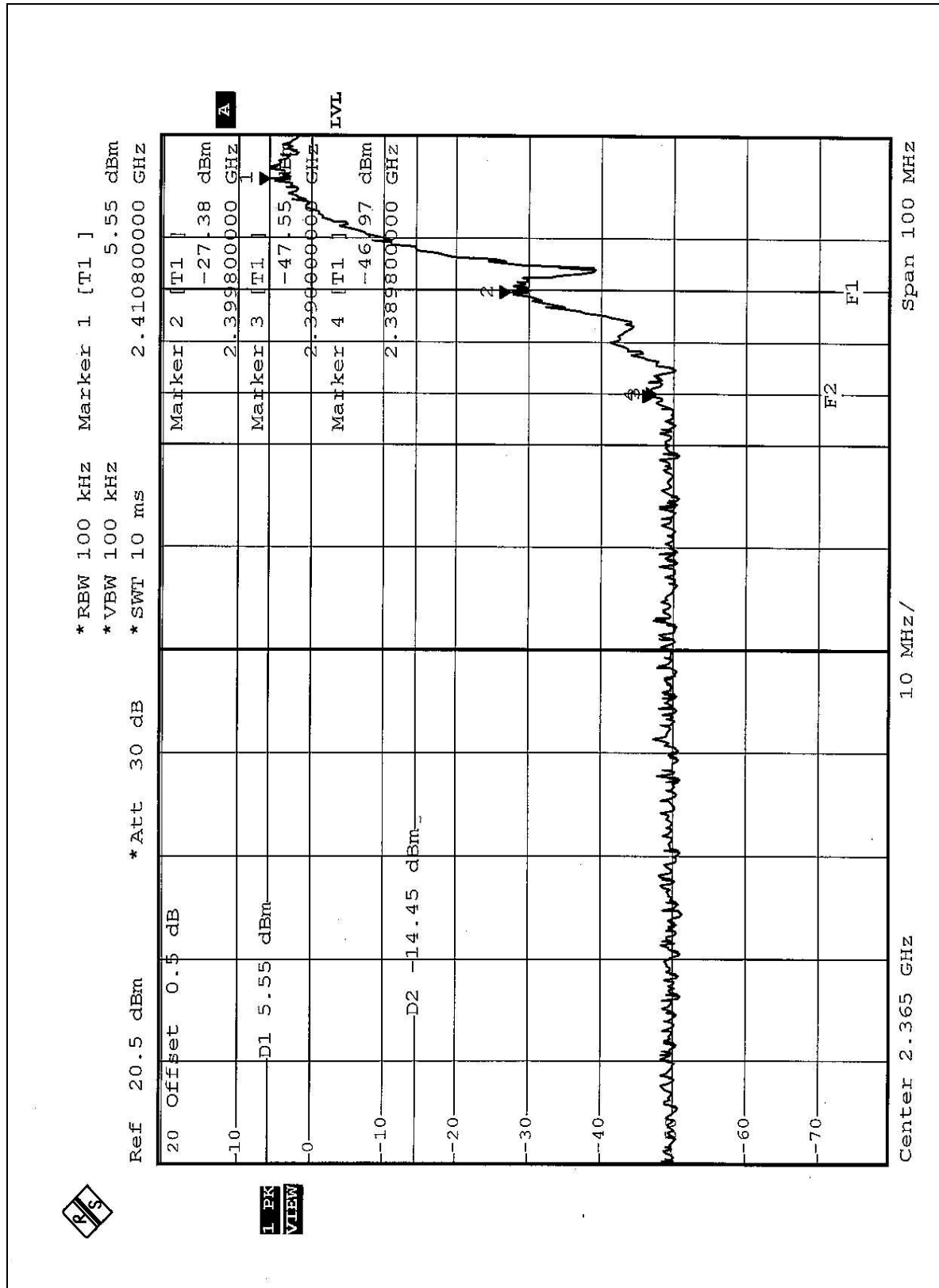

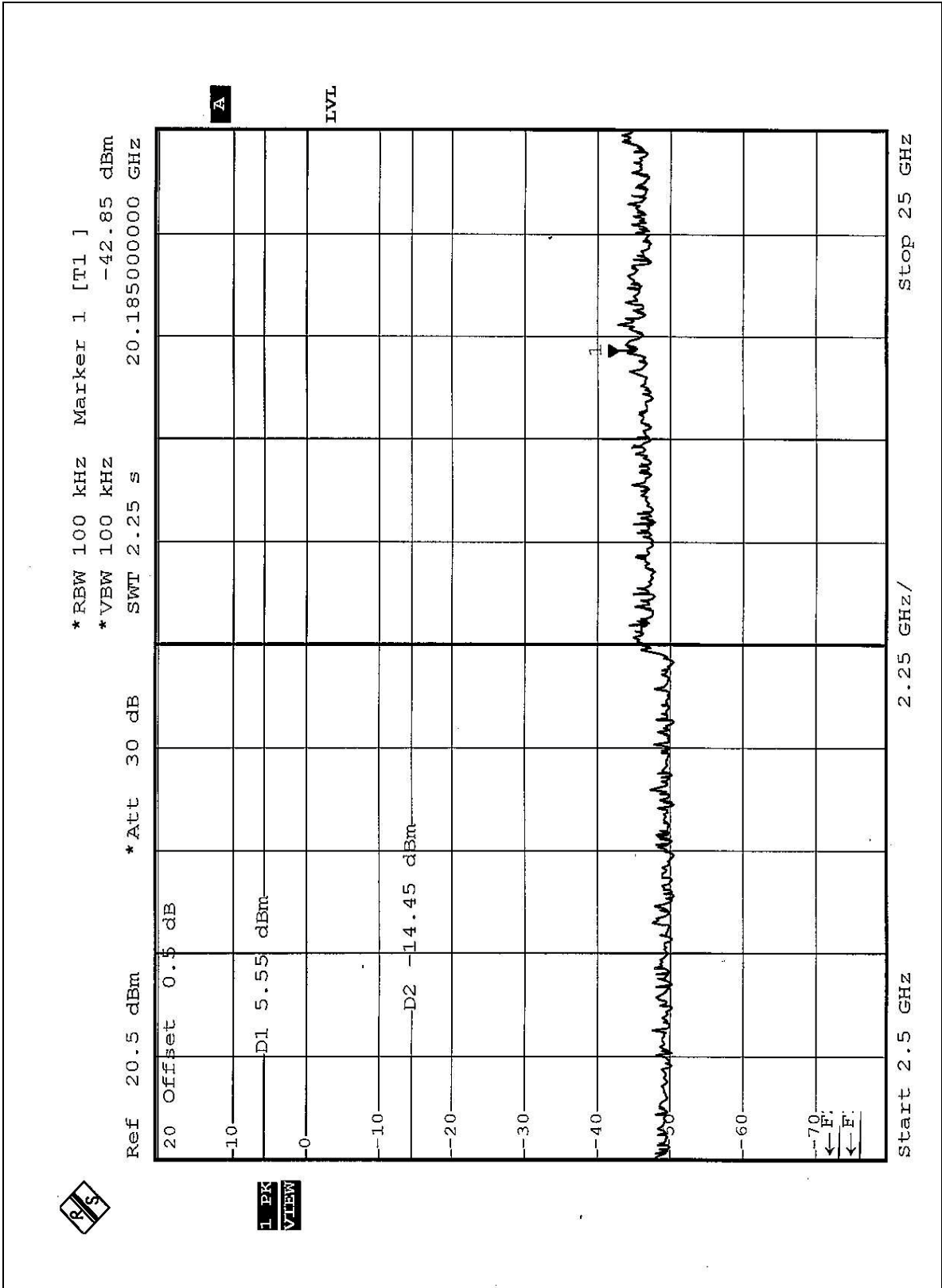

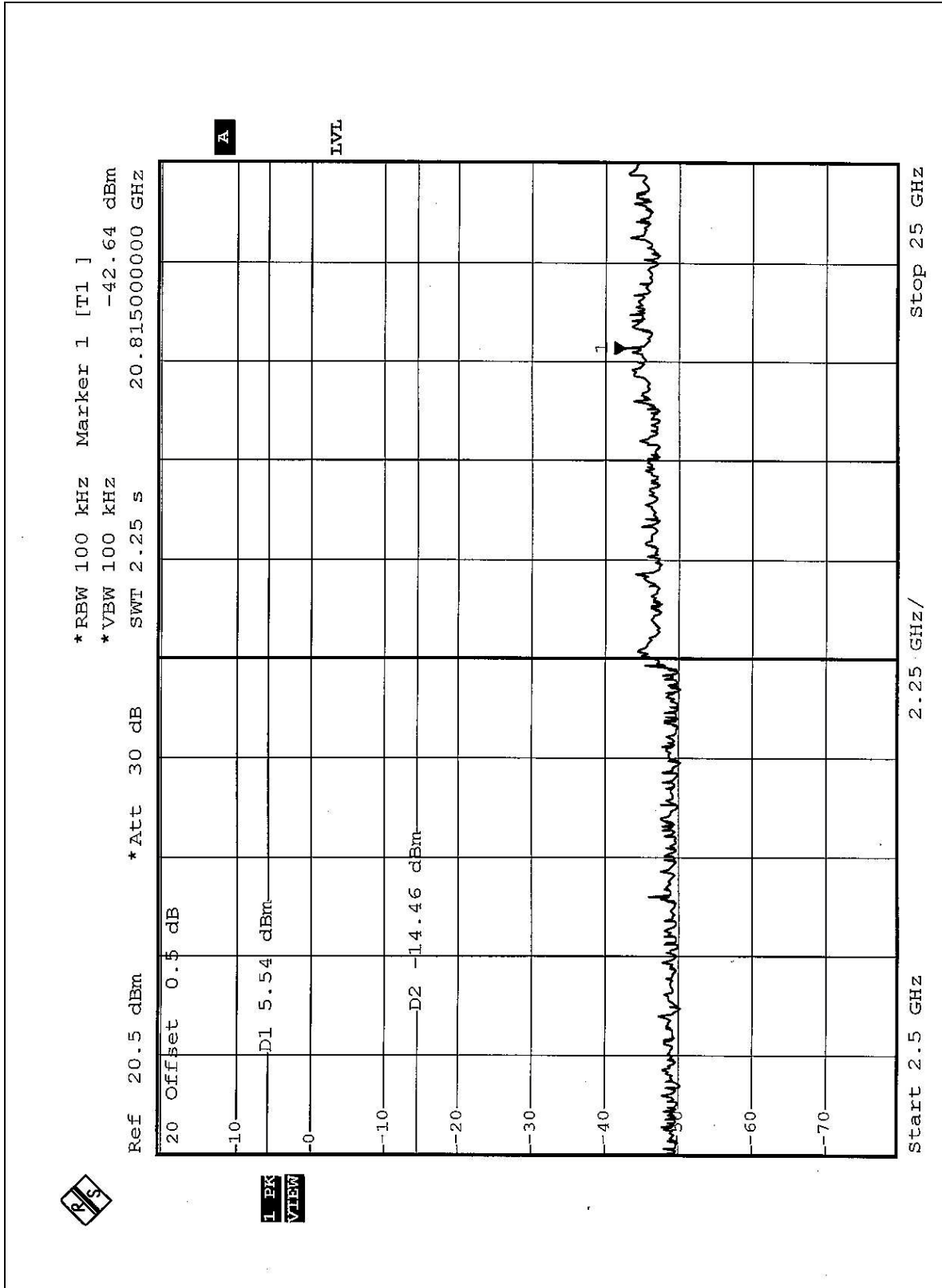



4.7 ANTENNA REQUIREMENT

4.7.1 STANDARD APPLICABLE

For intentional device, according to FCC 47 CFR Section 15.203, an intentional radiator shall be designed to ensure that no antenna other than that furnished by the responsible party shall be used with the device.

And according to FCC 47 CFR Section 15.247 (b), if transmitting antennas of directional gain greater than 6dBi are used, the power shall be reduced by the amount in dB that the directional gain of the antenna exceeds 6dBi.

4.7.2 ANTENNA CONNECTED CONSTRUCTION

The antennas used in this product are PIFA with UFL antenna connector. And the maximum gain of the antennas is -1.97dBi .

5 PHOTOGRAPHS OF THE TEST CONFIGURATION

CONDUCTED EMISSION TEST
Test Mode: Antenna 1



Test Mode: Antenna 2



RADIATED EMISSION TEST
Test Mode: Antenna 1



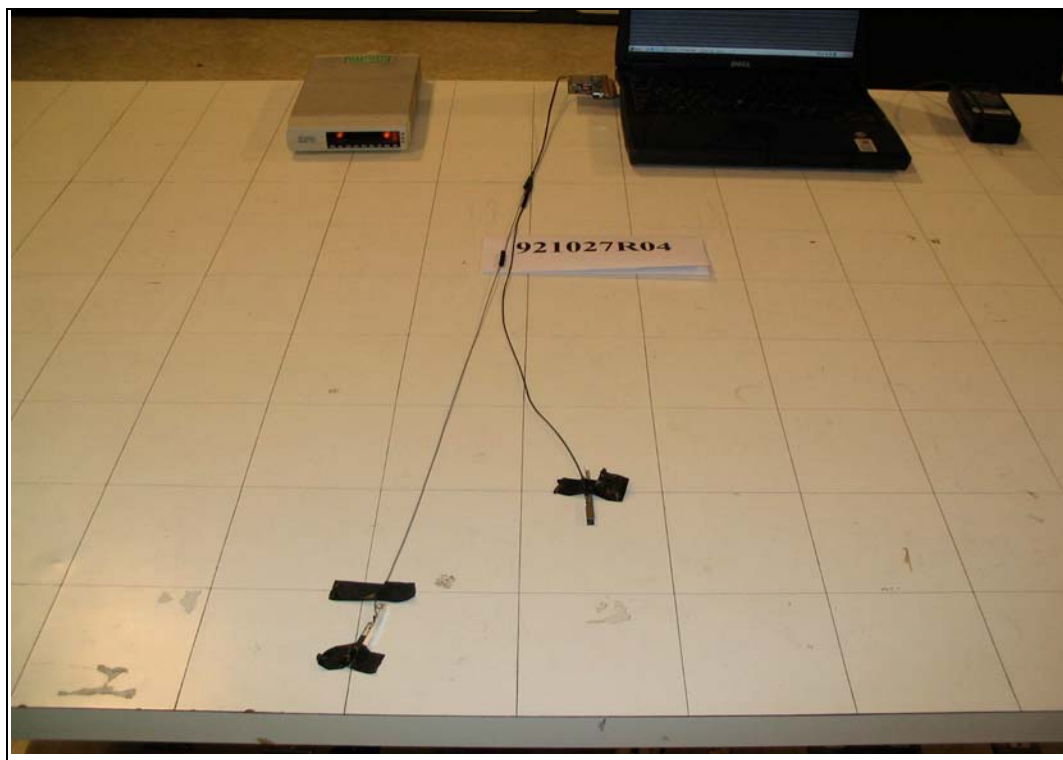

Test Mode: Antenna 2

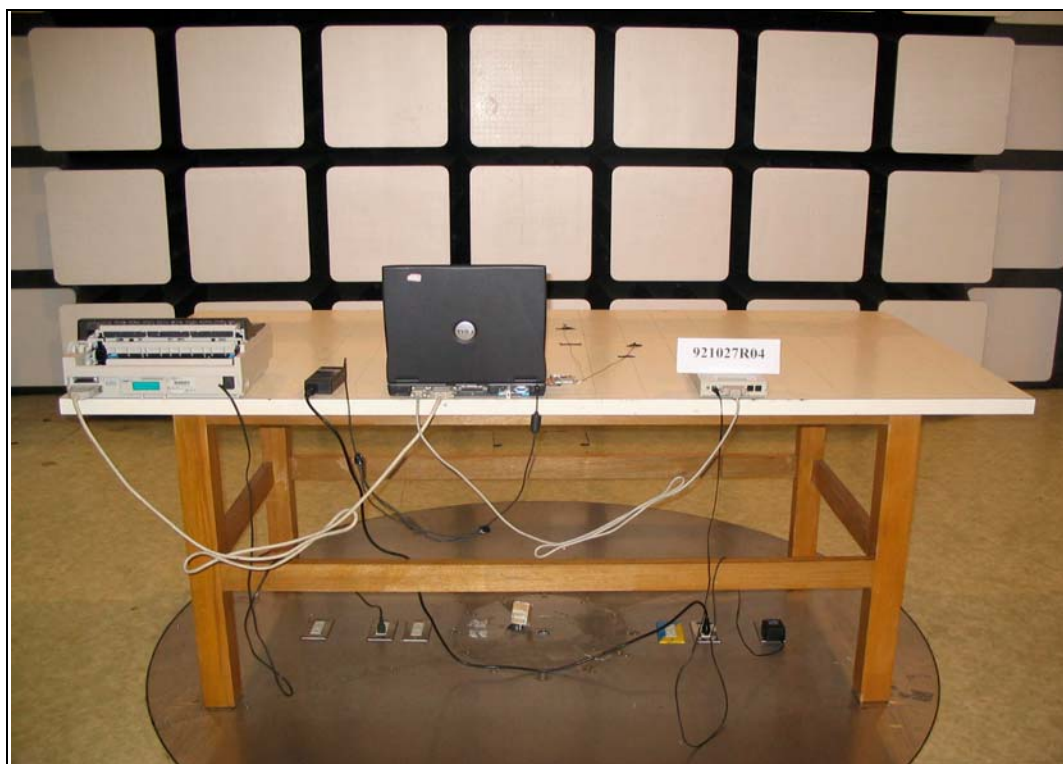





6 INFORMATION ON THE TESTING LABORATORIES

We, ADT Corp., were founded in 1988 to provide our best service in EMC, Radio, Telecom and Safety consultation. Our laboratories are accredited and approved by the following approval agencies according to ISO/IEC 17025, Guide 25 or EN 45001:

USA	FCC, NVLAP, UL
Germany	TUV Rheinland
Japan	VCCI
Norway	NEMKO
Canada	INDUSTRY CANADA , CSA
R.O.C.	CNLA, BSMI, DGT
Netherlands	Telefication
Singapore	PSB , GOST-ASIA(MOU)
Russia	CERTIS(MOU)

Copies of accreditation certificates of our laboratories obtained from approval agencies can be downloaded from our web site:

www.adt.com.tw/index.5/phtml. If you have any comments, please feel free to contact us at the following:

Linko EMC/RF Lab

Tel: 886-2-26052180

Fax: 886-2-26052943

Hsin Chu EMC/RF Lab

Tel: 886-3-5935343

Fax: 886-3-5935342

Hwa Ya EMC/RF/Safety Lab

Tel: 886-3-3183232

Fax: 886-3-3185050

Linko RF & Telecom Lab

Tel: 886-3-3270910

Fax: 886-3-3270892

Email: service@mail.adt.com.tw

Web Site: www.adt.com.tw

The address and road map of all our labs can be found in our web site also.