

IEEE 802.11b mode Mid CH chain 0

Reference Level of PSD in 100kHz



Spurious Emission 30MHz-25GHz



IEEE 802.11b mode High CH chain 0

Reference Level of PSD in 100kHz

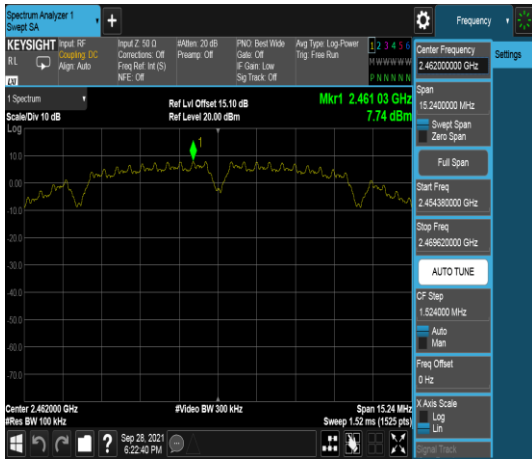

Band Edge



Spurious Emission 30MHz-25GHz

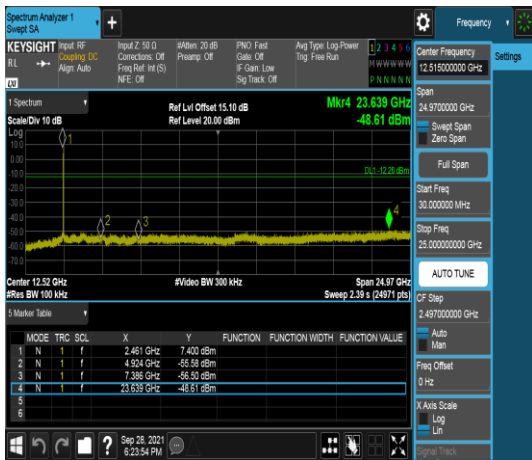

IEEE 802.11g mode Low CH chain 0

Reference Level of PSD in 100kHz

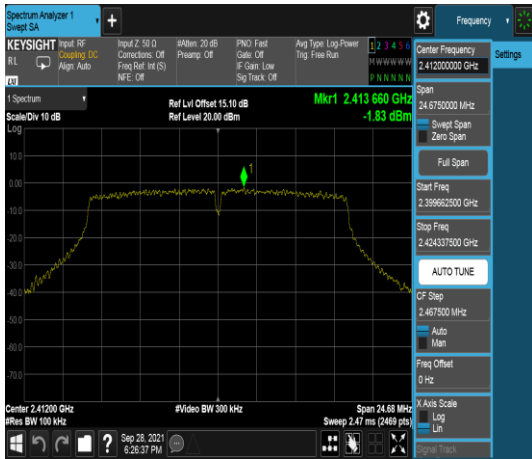

Band Edge

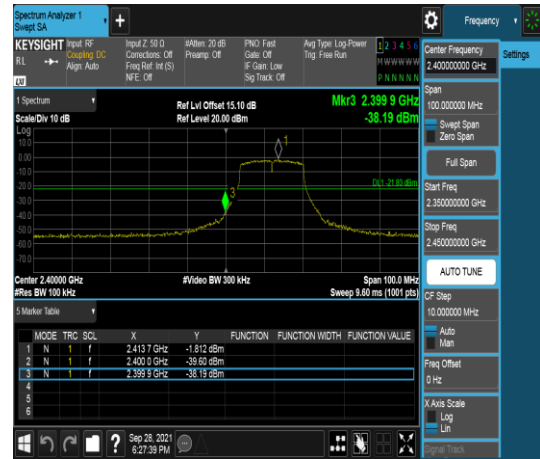

Spurious Emission 30MHz-25GHz



IEEE 802.11g mode Mid CH chain 0

Reference Level of PSD in 100kHz

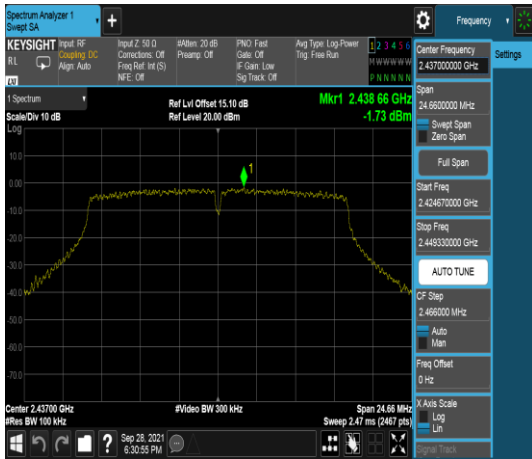

Spurious Emission 30MHz-25GHz

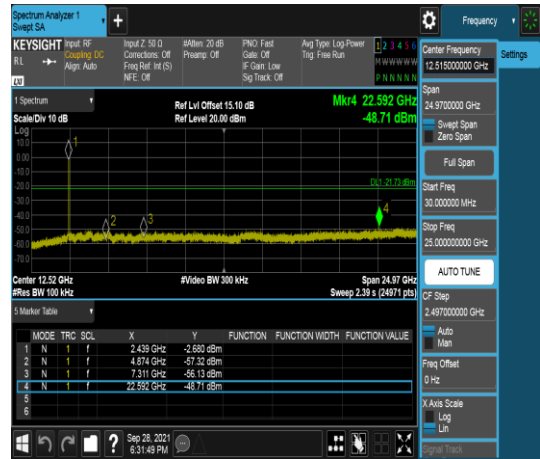

IEEE 802.11g mode High CH chain 0

Reference Level of PSD in 100kHz

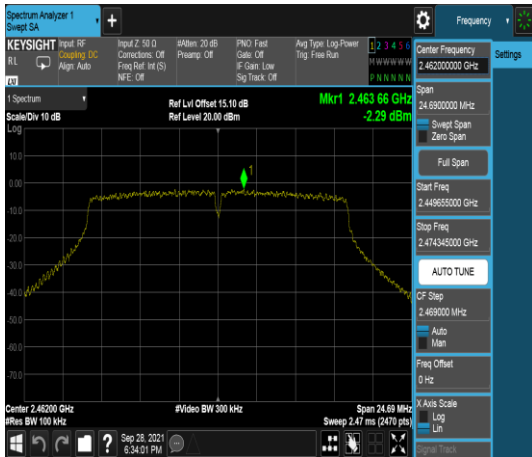

Band Edge



Spurious Emission 30MHz-25GHz

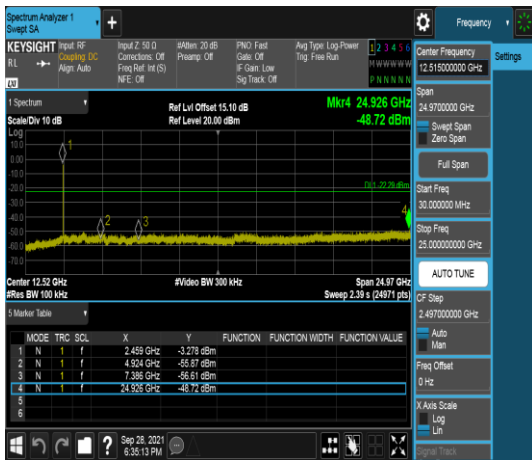

IEEE 802.11 n HT20 mode Low CH chain 0

Reference Level of PSD in 100kHz

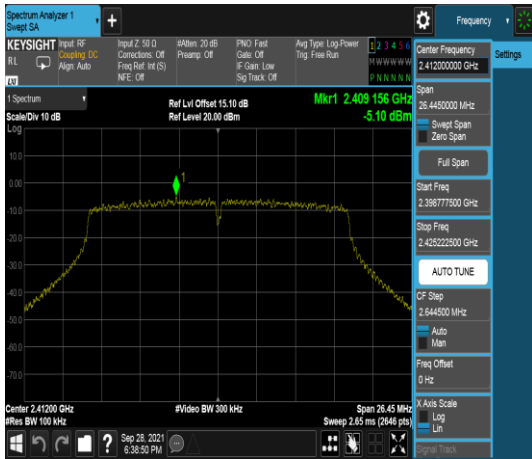

Band Edge

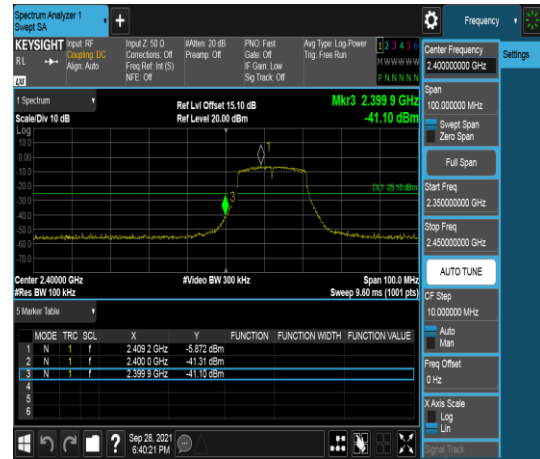

Spurious Emission 30MHz-25GHz

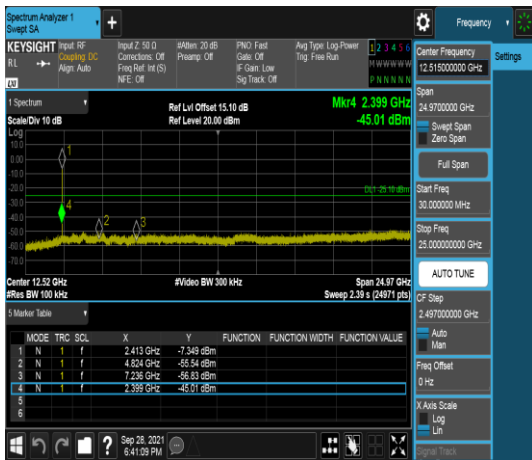

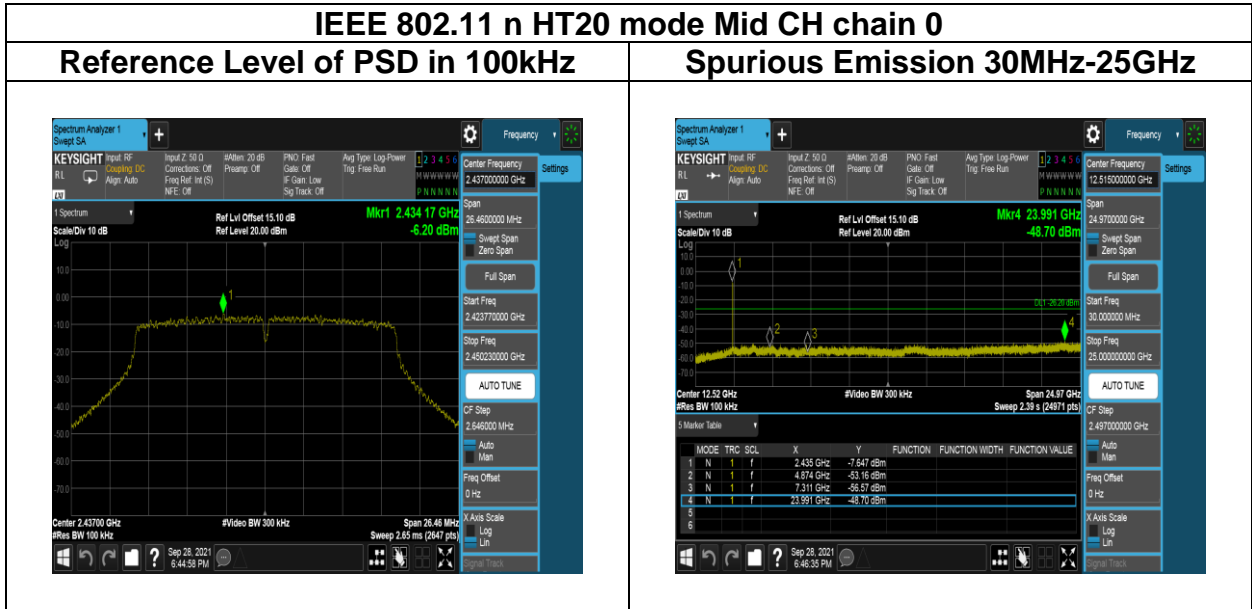

IEEE 802.11n HT20 mode High CH chain 0

Reference Level of PSD in 100kHz

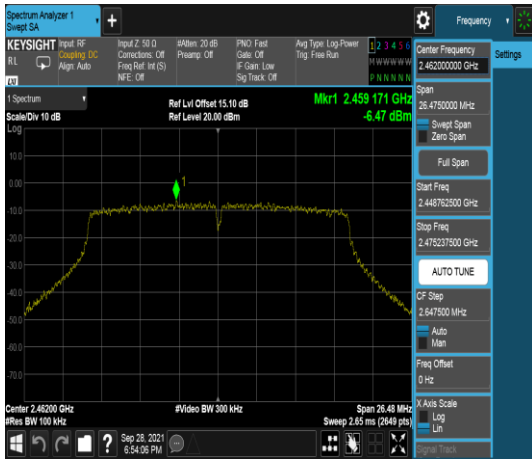

Band Edge



Spurious Emission 30MHz-25GHz

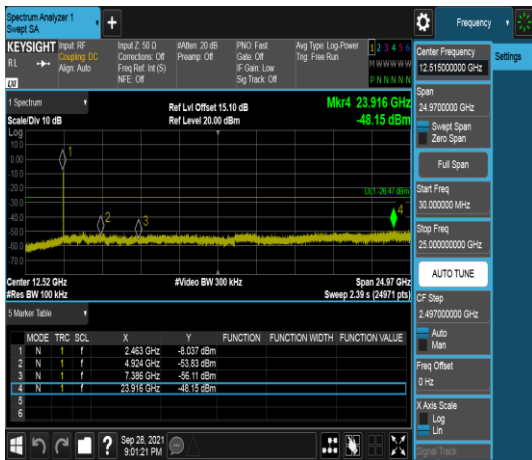

IEEE 802.11 n HT20 mode Low CH chain 1

Reference Level of PSD in 100kHz

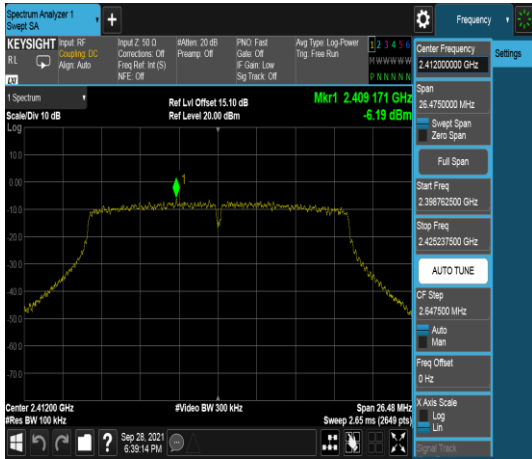

Band Edge



Spurious Emission 30MHz-25GHz



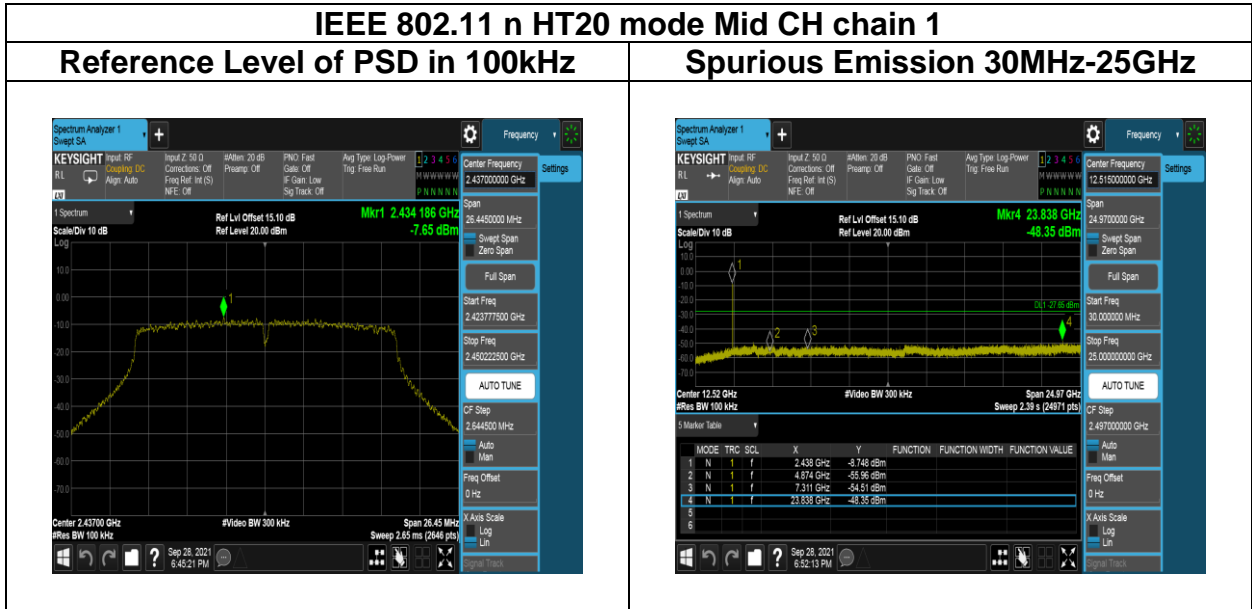

IEEE 802.11n HT20 mode High CH chain 1

Reference Level of PSD in 100kHz

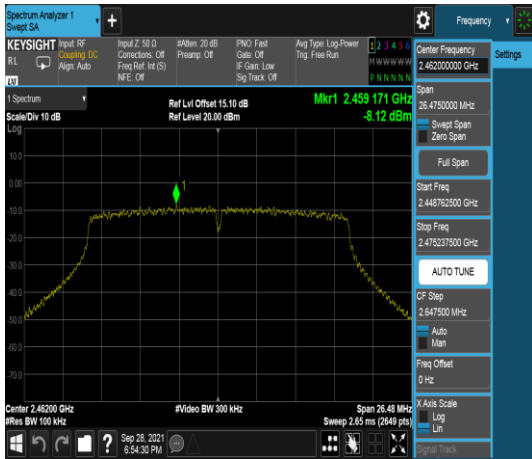

Band Edge



Spurious Emission 30MHz-25GHz

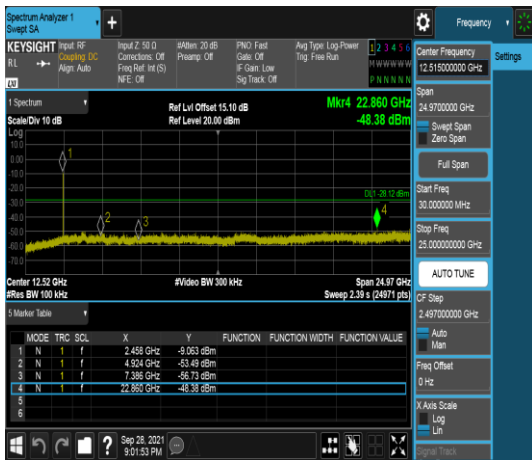

IEEE 802.11 n HT40 mode Low CH chain 0

Reference Level of PSD in 100kHz

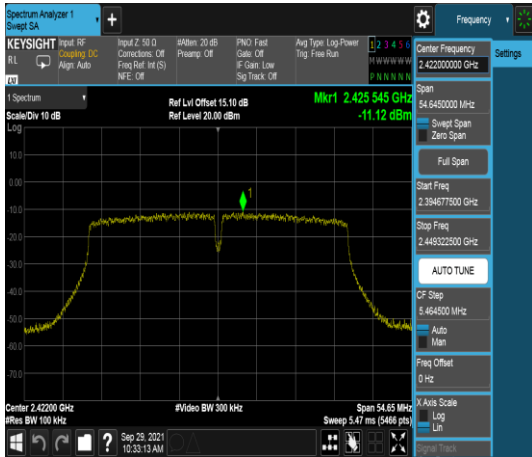

Band Edge



Spurious Emission 30MHz-25GHz

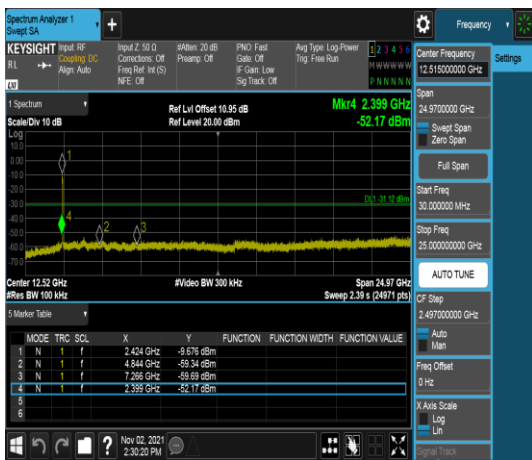

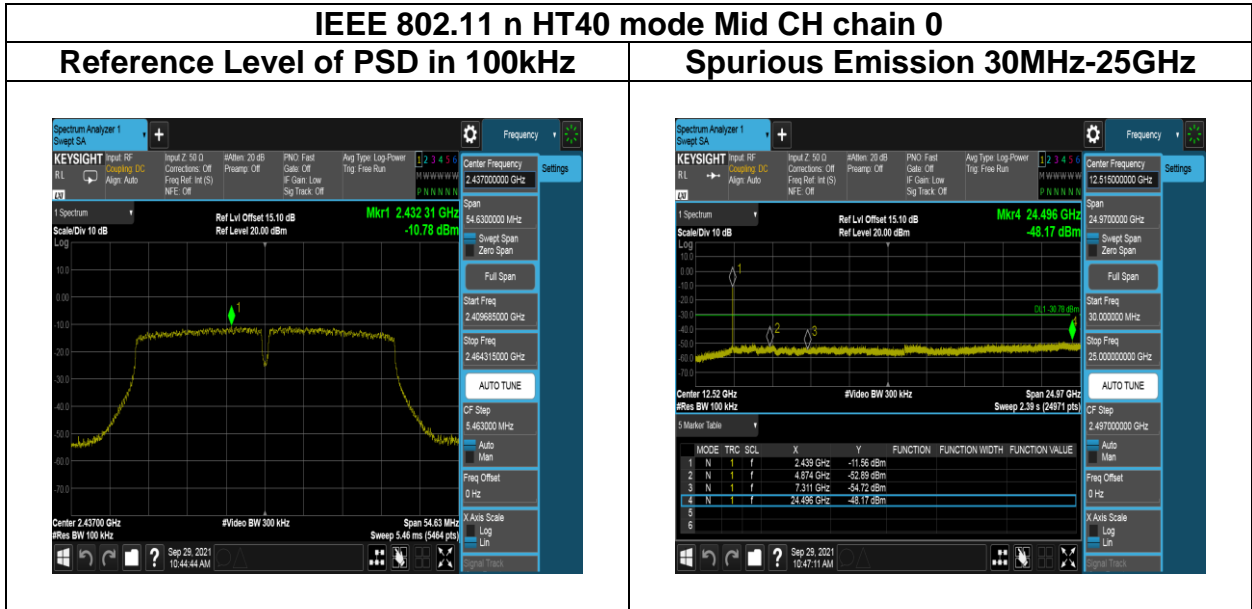

IEEE 802.11n HT40 mode High CH chain 0

Reference Level of PSD in 100kHz

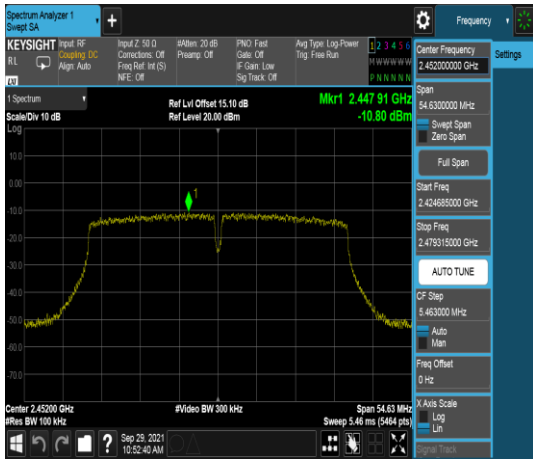

Band Edge



Spurious Emission 30MHz-25GHz



IEEE 802.11 n HT40 mode Low CH chain 1

Reference Level of PSD in 100kHz

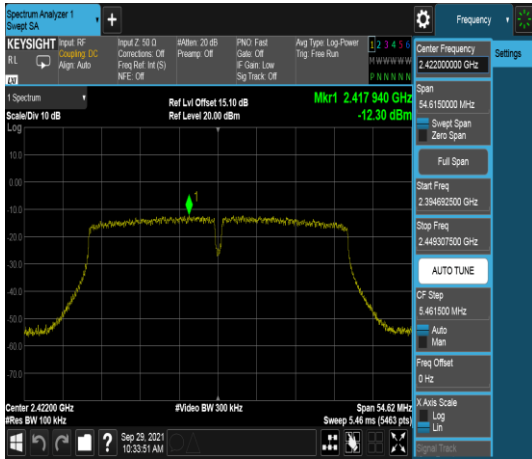

Band Edge



Spurious Emission 30MHz-25GHz

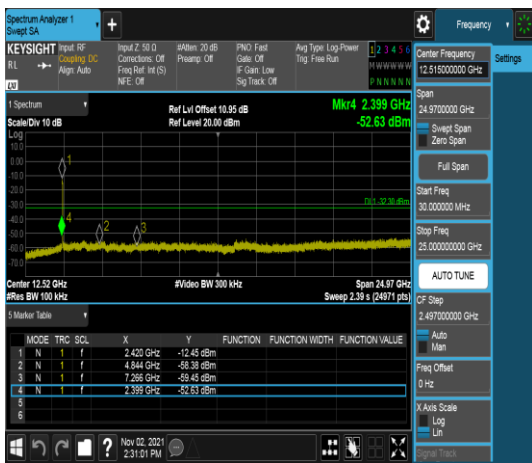

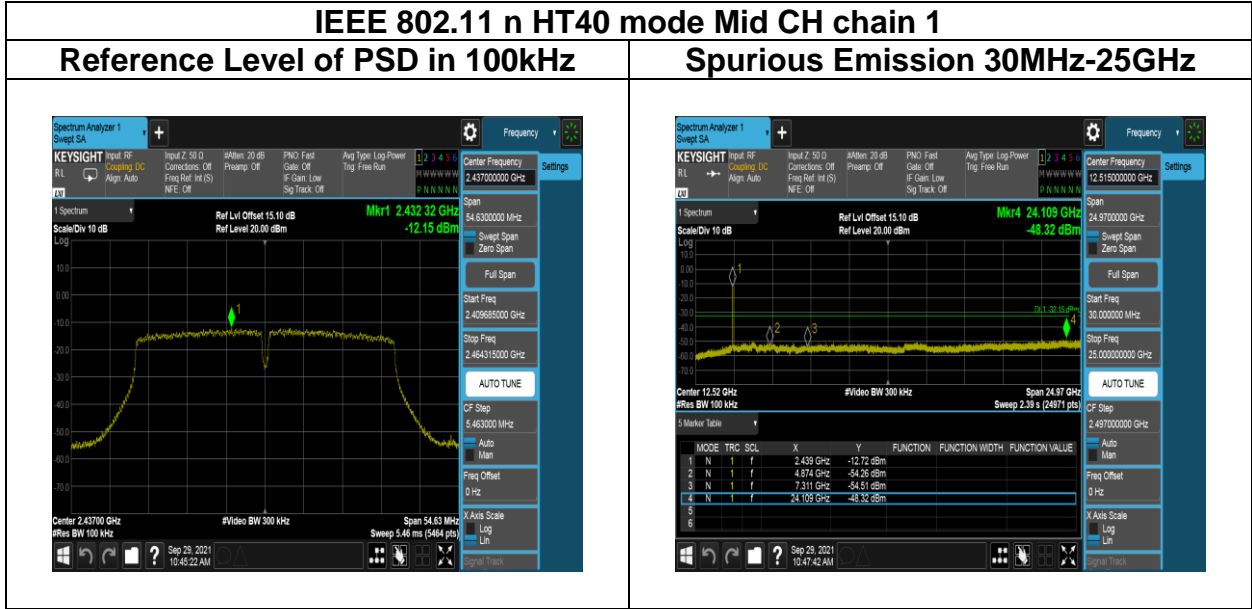

IEEE 802.11n HT40 mode High CH chain 1

Reference Level of PSD in 100kHz

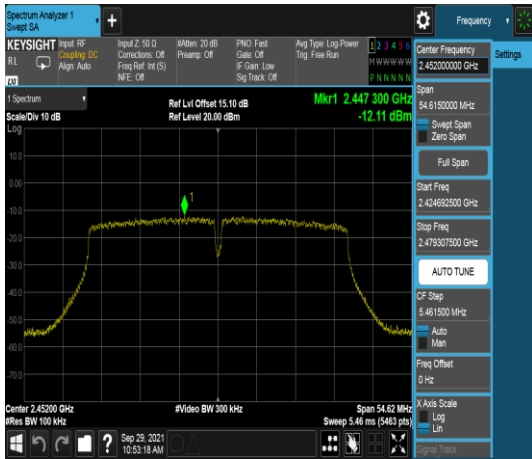

Band Edge



Spurious Emission 30MHz-25GHz

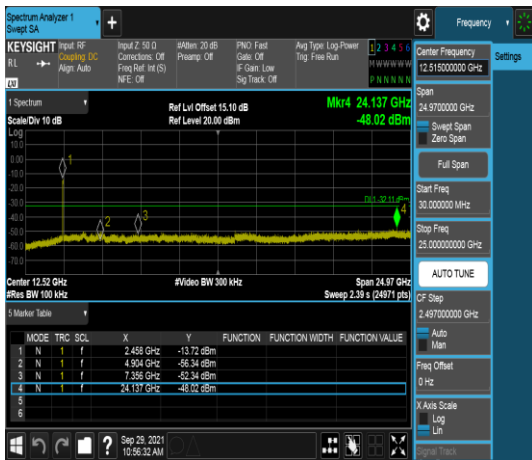

5.6 RADIATION BANDEDGE AND SPURIOUS EMISSION

5.6.1 Test Limit

FCC according to §15.247(d), §15.209 and §15.205,

IC according to RSS-247 section 5.5, RSS-Gen, Section 8.9 and 8.10

In any 100 kHz bandwidth outside the authorized frequency band, all harmonic and spurious must be least 20 dB below the highest emission level with the authorized frequency band. Radiation emission which fall in the restricted bands must also follow the FCC section 15.209 as below limit in table.

Below 30 MHz

Frequency	Field Strength (microvolts/m)	Magnetic H-Field (microamperes/m)	Measurement Distance (metres)
9-490 kHz	2,400/F (F in kHz)	2,400/F (F in kHz)	300
490-1,705 kHz	24,000/F (F in kHz)	24,000/F (F in kHz)	30
1.705-30 MHz	30	N/A	30

Above 30 MHz

Frequency	Field Strength (microvolts/m)	Measurement Distance (metres)
30-88	100	3
88-216	150	3
216-960	200	3
Above 960	500	3

Remark:

Although these tests were performed other than open area test site, adequate comparison measurements were confirmed against 30 m open are test site. Therefore sufficient tests were made to demonstrate that the alternative site produces results that correlate with the ones of tests made in an open field based on KDB 414788.

IC according to RSS-247 section 5.5, RSS-Gen, Section 8.9 and 8.10

RSS-Gen Table 3 and Table 5 – General Field Strength Limits for Transmitters and Receivers at Frequencies Above 30 MHz ^(Note)

Frequency (MHz)	Field Strength microvolts/m at 3 metres (watts, e.i.r.p.)	
	Transmitters	Receivers
30-88	100 (3 nW)	100 (3 nW)
88-216	150 (6.8 nW)	150 (6.8 nW)
216-960	200 (12 nW)	200 (12 nW)
Above 960	500 (75 nW)	500 (75 nW)

Note: Measurements for compliance with the limits in table 3 may be performed at distances other than 3 metres, in accordance with Section 6.6.

RSS-Gen Table 6: General Field Strength Limits for Transmitters at Frequencies Below 30 MHz (Transmit)

Frequency	Magnetic field strength (H-Field) (µA/m)	Measurement Distance (m)
9-490 kHz ^{Note}	6.37/F (F in kHz)	300
490-1,705 kHz	63.7/F (F in kHz)	30
1.705-30 MHz	0.08	30

Note: The emission limits for the ranges 9-90 kHz and 110-490 kHz are based on measurements employing a linear average detector.

Report No.: TMWK2109000573KR

5.6.2 Test Procedure

Test method Refer as ANSI C63.10:2013.

1. The EUT is placed on a turntable, Above 1 GHz is 1.5m and below 1 GHz is 0.8m above ground plane. The EUT Configured un accordance with ANSI C63.10: 2013, and the EUT set in a continuous mode.
2. The turntable shall be rotated for 360 degrees to determine the position of maximum emission level. And EUT is set 3m away from the receiving antenna, which is scanned from 1m to 4m above the ground plane to find out the highest emissions. Measurement are made polarized in both the vertical and the horizontal positions with antenna.
3. Span shall wide enough to full capture the emission measured. The SA from 9kHz to 26.5GHz set to the low, Mid and High channels with the EUT transmit.

Note: No emission found between lowest internal used/generated frequency to 30MHz (9KHz~30MHz)

Remark:

Although these tests were performed other than open area test site, adequate comparison measurements were confirmed against 30 m open are test site. Therefore sufficient tests were made to demonstrate that the alternative site produces results that correlate with the ones of tests made in an open field based on KDB 414788.

4. The SA setting following :

- (1) Below 1G : RBW = 100kHz, VBW \geq 3 RBW, Sweep = Auto, Detector = Peak, Trace = Max hold.
- (2) Above 1G :
 - (2.1) For Peak measurement : RBW = 1MHz, VBW \geq 3 RBW, Sweep = Auto, Detector = Peak, Trace = Max hold.
 - (2.2) For Average measurement : RBW = 1MHz, VBW
 - 'If Duty Cycle \geq 98%, VBW=10Hz.
 - 'If Duty Cycle < 98%, VBW=1/T.

5. Data result

Actual FS=Spectrum Reading Level + Factor

Margin=Actual FS- Limit

5.6.3 Test Setup

9kHz ~ 30MHz

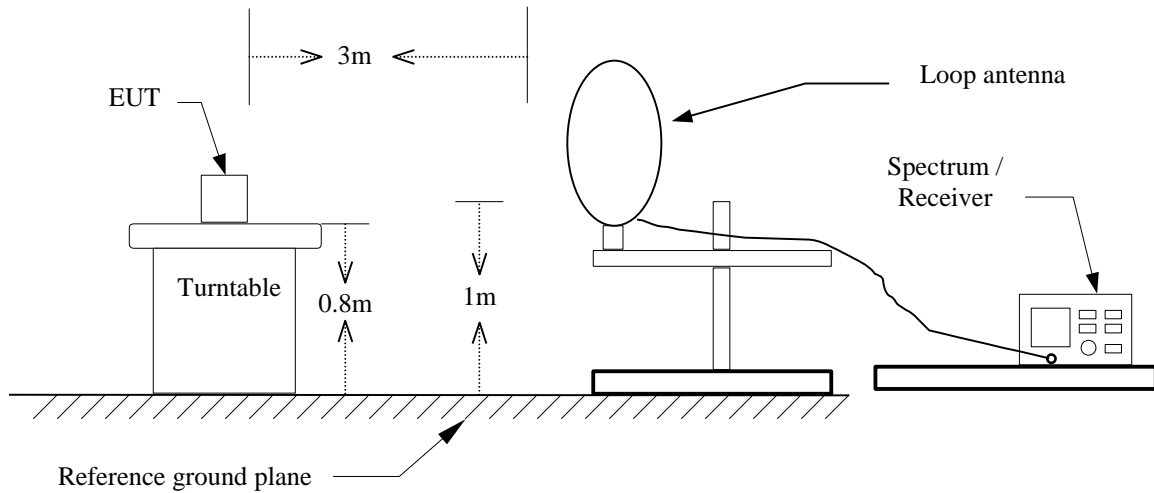

30MHz ~ 1GHz

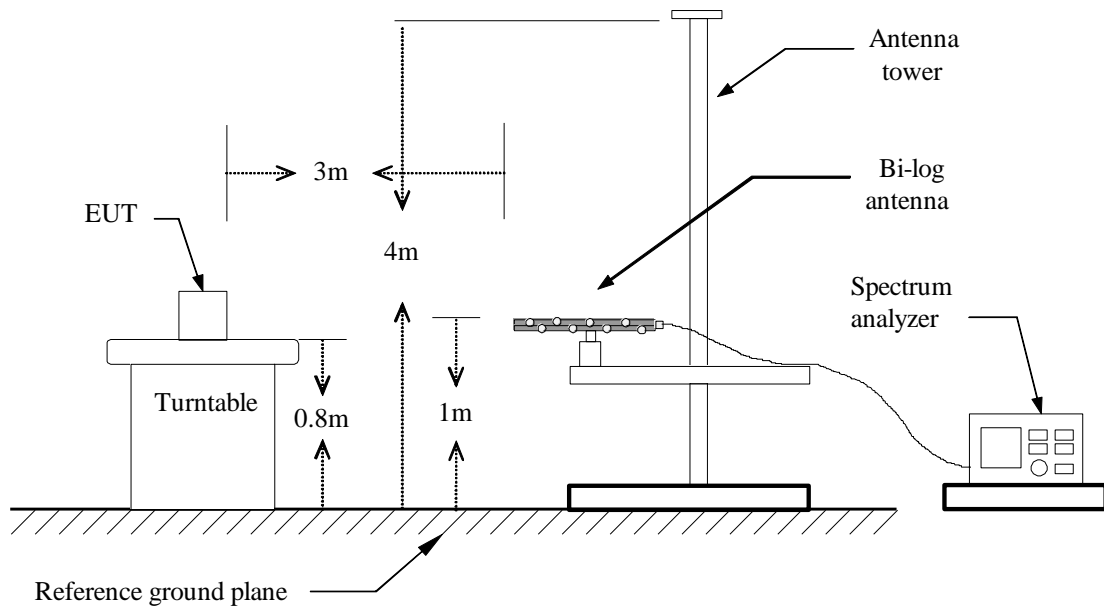

Above 1 GHz

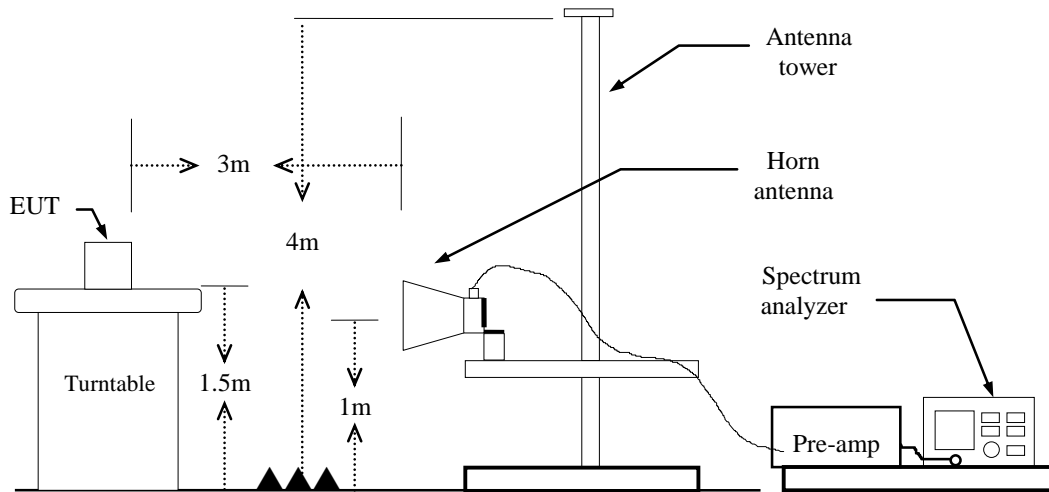

5.6.4 Test Result

Band Edge Test Data

Test Mode	IEEE 802.11b Low CH 2412MHz	Temp/Hum	23.1(°C)/ 55%RH
Test Item	Band Edge	Test Date	October 1, 2021
Polarize	Vertical	Test Engineer	Ray Li
Detector	Peak / Average		

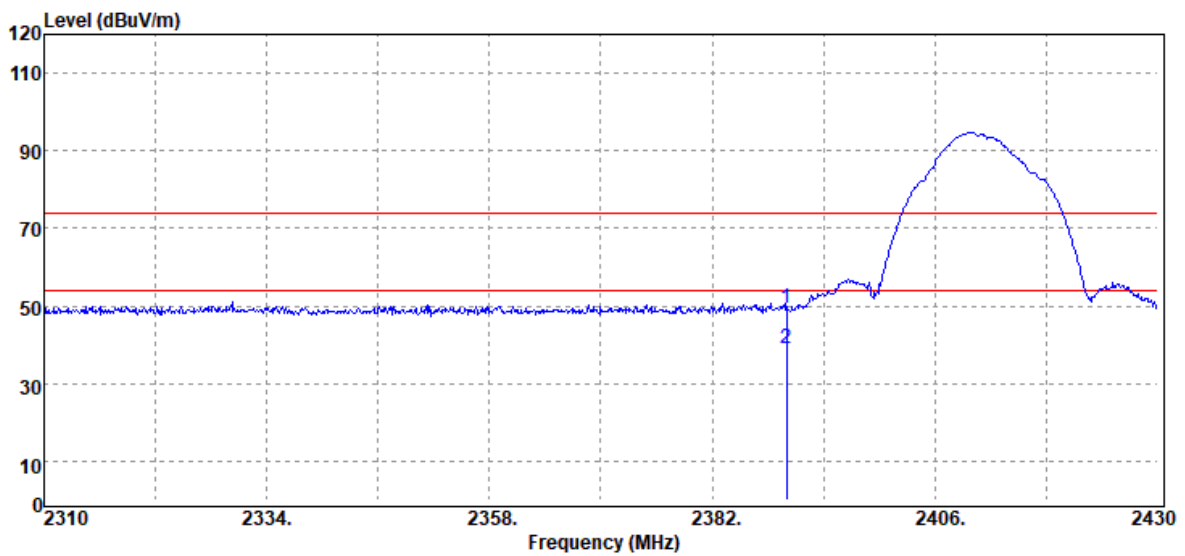

Frequency (MHz)	Detector Mode (PK/QP/AV)	Spectrum Reading Level (dBμV)	Factor (dB)	Actual FS (dBμV/m)	Limit @3m (dBμV/m)	Margin (dB)
2390.00	Peak	50.07	-0.78	49.29	74.00	-24.71
2390.00	Average	39.76	-0.78	38.98	54.00	-15.02

Test Mode	IEEE 802.11b Low CH 2412MHz	Temp/Hum	23.1(°C)/ 55%RH
Test Item	Band Edge	Test Date	October 1, 2021
Polarize	Horizontal	Test Engineer	Ray Li
Detector	Peak / Average		

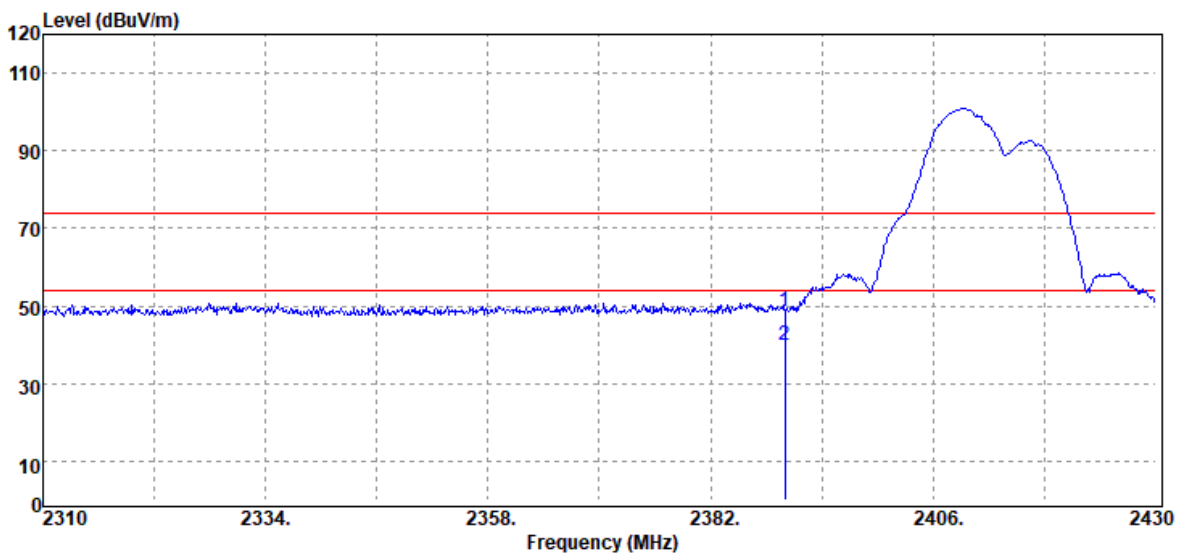

Frequency (MHz)	Detector Mode (PK/QP/AV)	Spectrum Reading Level (dBµV)	Factor (dB)	Actual FS (dBµV/m)	Limit @3m (dBµV/m)	Margin (dB)
2390.00	Peak	49.48	-0.78	48.70	74.00	-25.30
2390.00	Average	40.56	-0.78	39.78	54.00	-14.22

Report No.: TMWK2109000573KR

Test Mode	IEEE 802.11b High CH 2462MHz	Temp/Hum	23.1(°C)/ 55%RH
Test Item	Band Edge	Test Date	October 1, 2021
Polarize	Vertical	Test Engineer	Ray Li
Detector	Peak / Average		

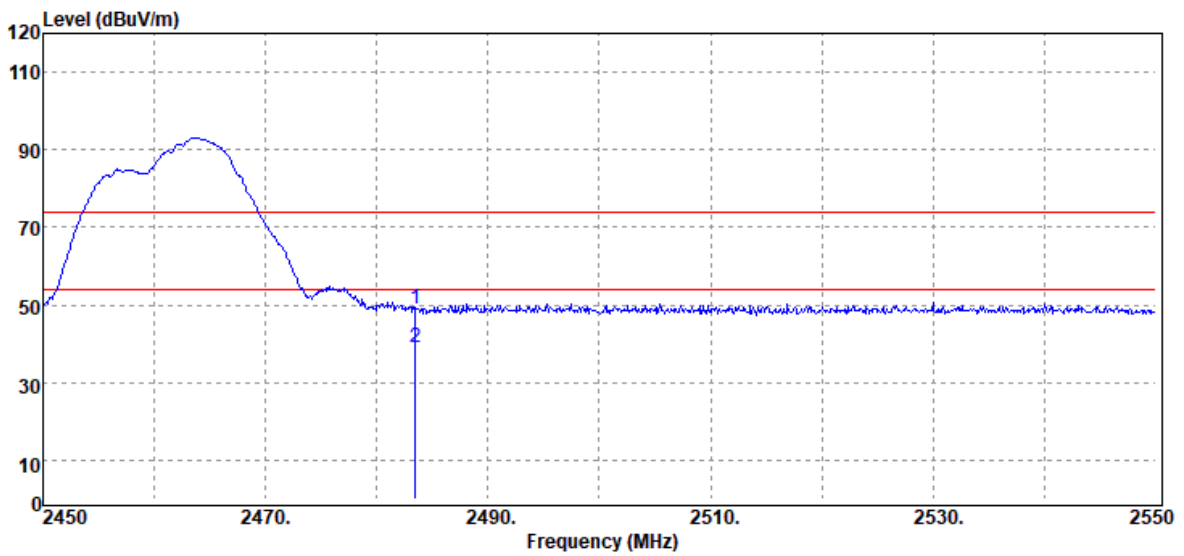

Frequency (MHz)	Detector Mode (PK/QP/AV)	Spectrum Reading Level (dBµV)	Factor (dB)	Actual FS (dBµV/m)	Limit @3m (dBµV/m)	Margin (dB)
2483.50	Peak	49.62	-0.43	49.19	74.00	-24.81
2483.50	Average	39.31	-0.43	38.88	54.00	-15.12

Test Mode	IEEE 802.11b High CH 2462MHz	Temp/Hum	23.1(°C)/ 55%RH
Test Item	Band Edge	Test Date	October 1, 2021
Polarize	Horizontal	Test Engineer	Ray Li
Detector	Peak / Average		

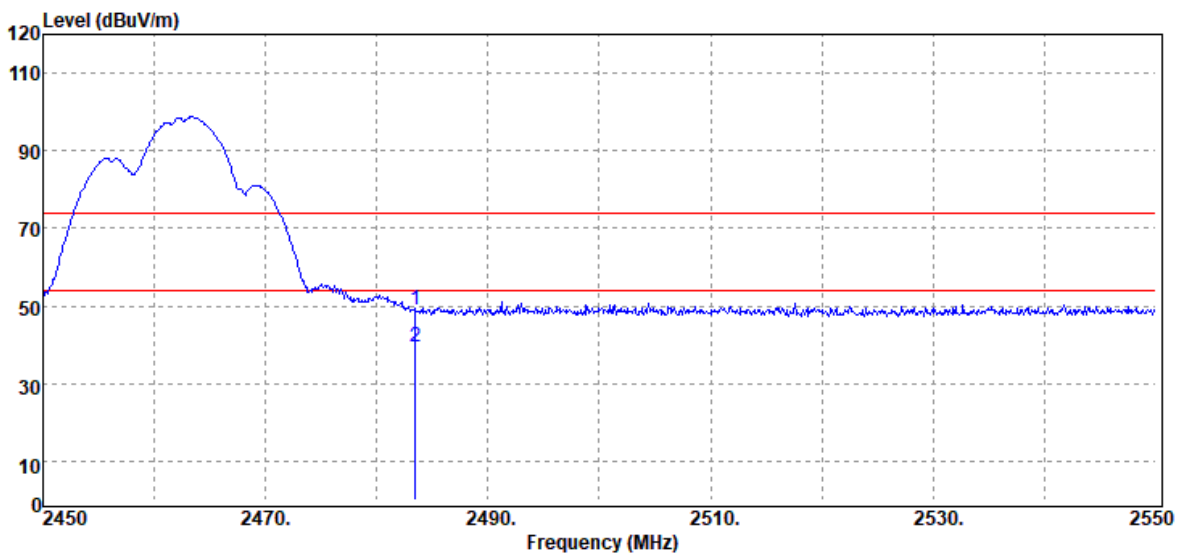

Frequency (MHz)	Detector Mode (PK/QP/AV)	Spectrum Reading Level (dBµV)	Factor (dB)	Actual FS (dBµV/m)	Limit @3m (dBµV/m)	Margin (dB)
2483.50	Peak	49.42	-0.43	48.99	74.00	-25.01
2483.50	Average	39.77	-0.43	39.34	54.00	-14.66

Test Mode	IEEE 802.11g Low CH 2412MHz	Temp/Hum	23.1(°C)/ 55%RH
Test Item	Band Edge	Test Date	October 1, 2021
Polarize	Vertical	Test Engineer	Ray Li
Detector	Peak / Average		

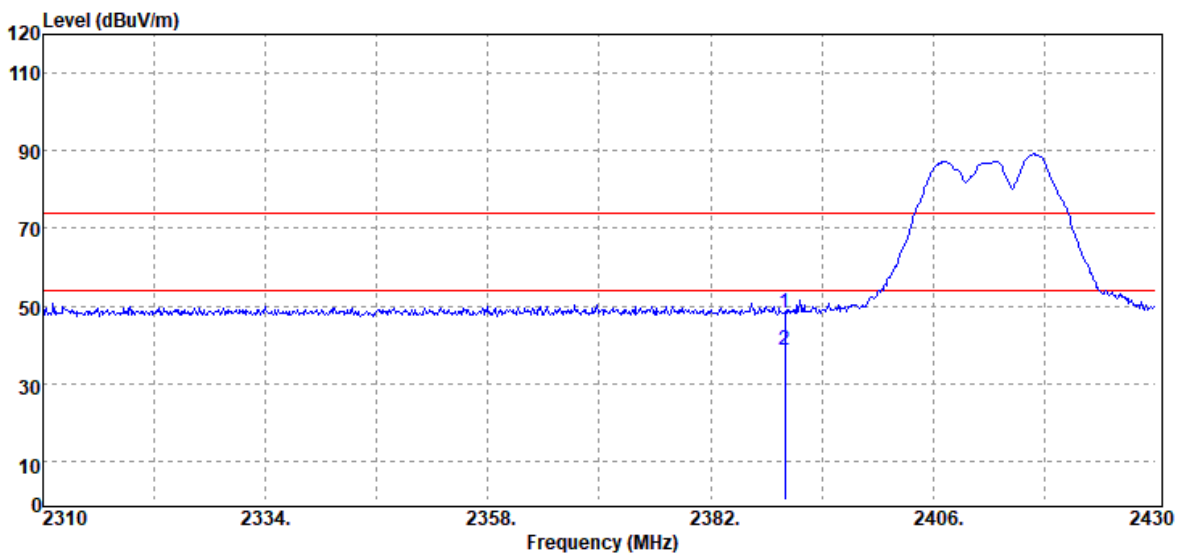

Frequency (MHz)	Detector Mode (PK/QP/AV)	Spectrum Reading Level (dBμV)	Factor (dB)	Actual FS (dBμV/m)	Limit @3m (dBμV/m)	Margin (dB)
2390.00	Peak	48.97	-0.78	48.19	74.00	-25.81
2390.00	Average	39.29	-0.78	38.51	54.00	-15.49

Test Mode	IEEE 802.11g Low CH 2412MHz	Temp/Hum	23.1(°C)/ 55%RH
Test Item	Band Edge	Test Date	October 1, 2021
Polarize	Horizontal	Test Engineer	Ray Li
Detector	Peak / Average		

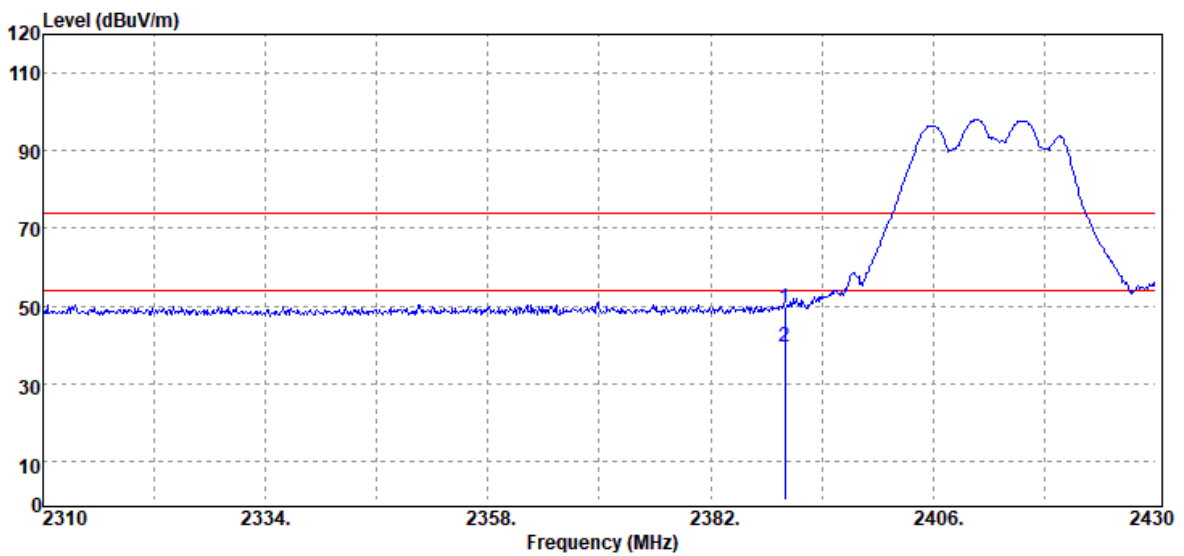

Frequency (MHz)	Detector Mode (PK/QP/AV)	Spectrum Reading Level (dBµV)	Factor (dB)	Actual FS (dBµV/m)	Limit @3m (dBµV/m)	Margin (dB)
2390.00	Peak	50.38	-0.78	49.60	74.00	-24.40
2390.00	Average	40.25	-0.78	39.47	54.00	-14.53

Test Mode	IEEE 802.11g High CH 2462MHz	Temp/Hum	23.1(°C)/ 55%RH
Test Item	Band Edge	Test Date	October 1, 2021
Polarize	Vertical	Test Engineer	Ray Li
Detector	Peak / Average		

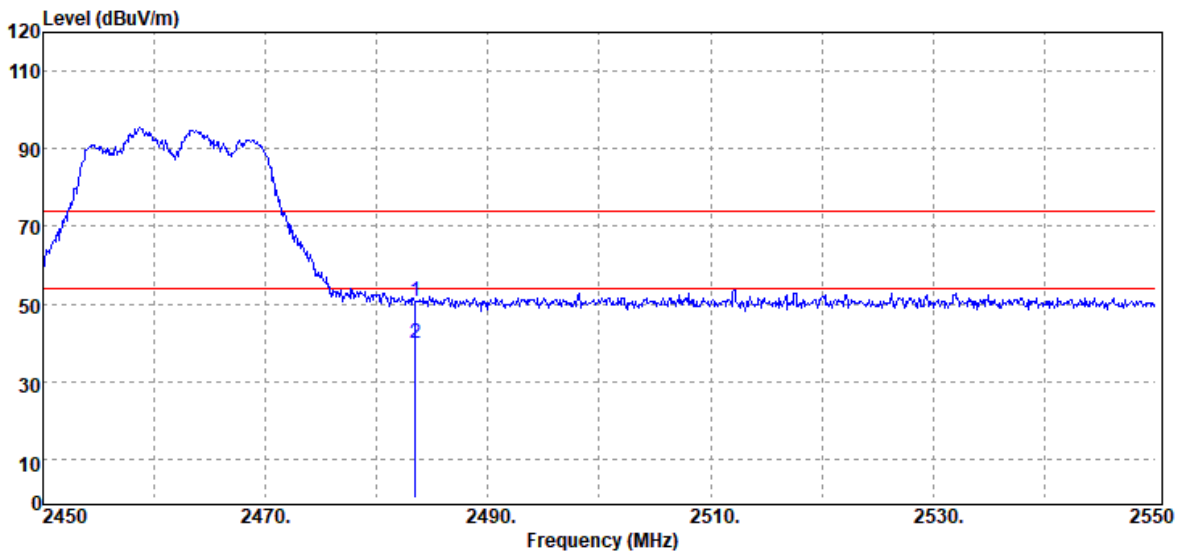

Frequency (MHz)	Detector Mode (PK/QP/AV)	Spectrum Reading Level (dBμV)	Factor (dB)	Actual FS (dBμV/m)	Limit @3m (dBμV/m)	Margin (dB)
2483.50	Peak	46.81	4.04	50.85	74.00	-23.15
2483.50	Average	35.67	4.04	39.71	54.00	-14.29

Test Mode	IEEE 802.11g High CH 2462MHz	Temp/Hum	23.1(°C)/ 55%RH
Test Item	Band Edge	Test Date	October 1, 2021
Polarize	Horizontal	Test Engineer	Ray Li
Detector	Peak / Average		

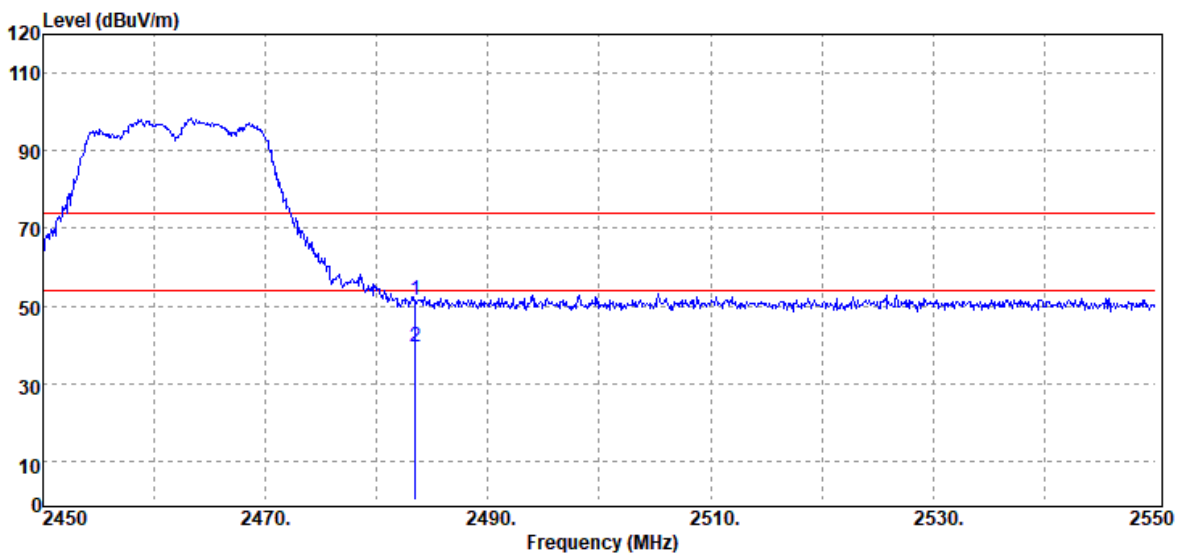

Frequency (MHz)	Detector Mode (PK/QP/AV)	Spectrum Reading Level (dBμV)	Factor (dB)	Actual FS (dBμV/m)	Limit @3m (dBμV/m)	Margin (dB)
2483.50	Peak	47.24	4.04	51.28	74.00	-22.72
2483.50	Average	35.59	4.04	39.63	54.00	-14.37

Test Mode	IEEE 802.11n HT20 Low CH 2412MHz	Temp/Hum	23.1(°C)/ 55%RH
Test Item	Band Edge	Test Date	October 1, 2021
Polarize	Vertical	Test Engineer	Ray Li
Detector	Peak / Average		

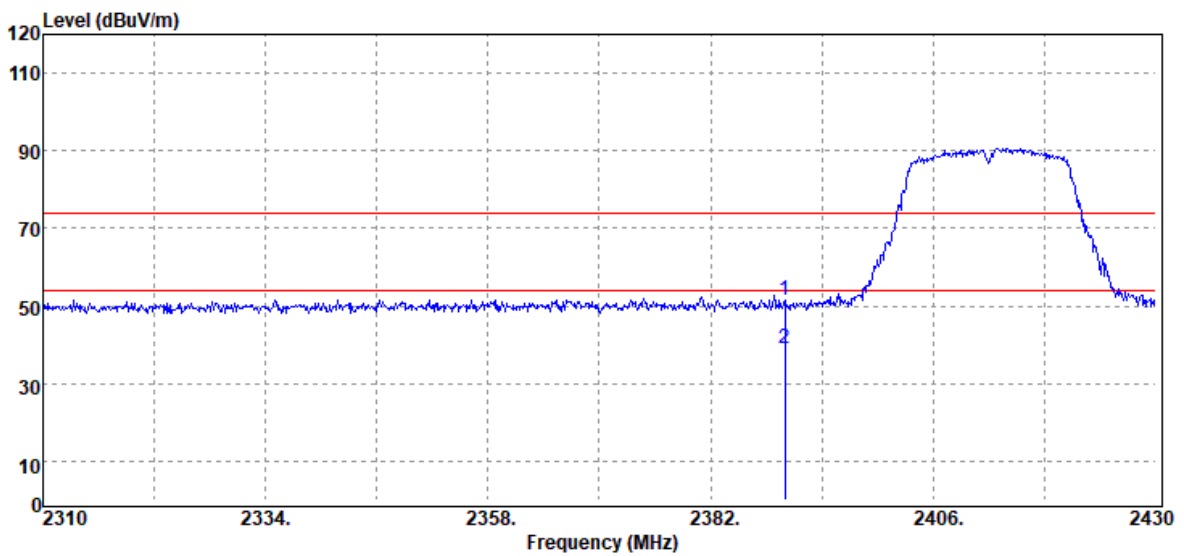

Frequency (MHz)	Detector Mode (PK/QP/AV)	Spectrum Reading Level (dBµV)	Factor (dB)	Actual FS (dBµV/m)	Limit @3m (dBµV/m)	Margin (dB)
2390.00	Peak	47.67	3.70	51.37	74.00	-22.63
2390.00	Average	35.35	3.70	39.05	54.00	-14.95

Test Mode	IEEE 802.11 n20 Low CH 2412MHz	Temp/Hum	23.1(°C)/ 55%RH
Test Item	Band Edge	Test Date	October 1, 2021
Polarize	Horizontal	Test Engineer	Ray Li
Detector	Peak / Average		

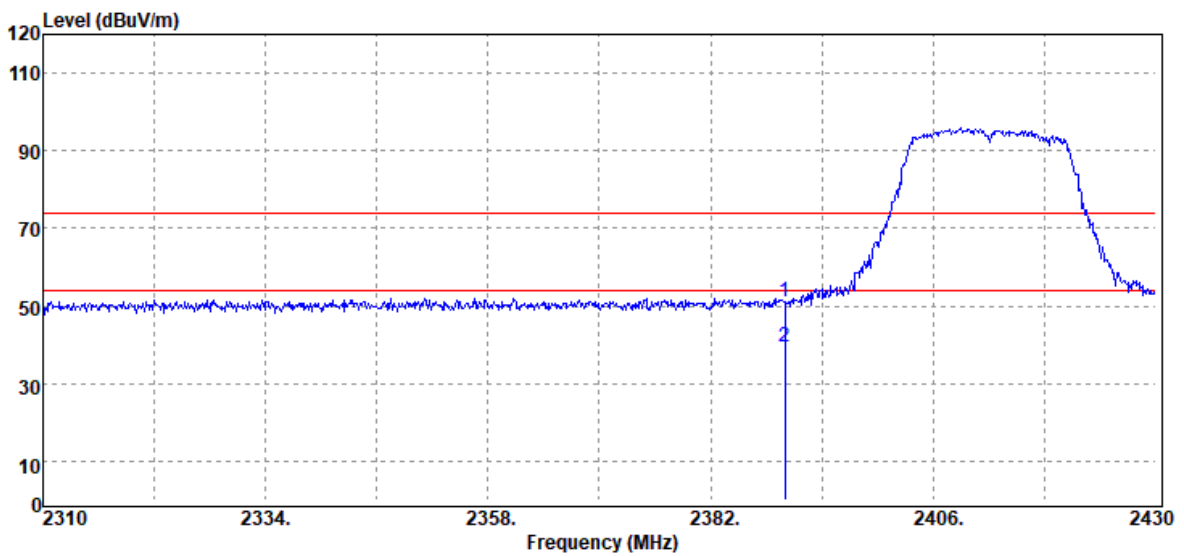

Frequency (MHz)	Detector Mode (PK/QP/AV)	Spectrum Reading Level (dBμV)	Factor (dB)	Actual FS (dBμV/m)	Limit @3m (dBμV/m)	Margin (dB)
2390.00	Peak	47.26	3.70	50.96	74.00	-23.04
2390.00	Average	35.83	3.70	39.53	54.00	-14.47

Report No.: TMWK2109000573KR

Test Mode	IEEE 802.11n HT20 High CH 2462MHz	Temp/Hum	23.1(°C)/ 55%RH
Test Item	Band Edge	Test Date	October 1, 2021
Polarize	Vertical	Test Engineer	Ray Li
Detector	Peak / Average		

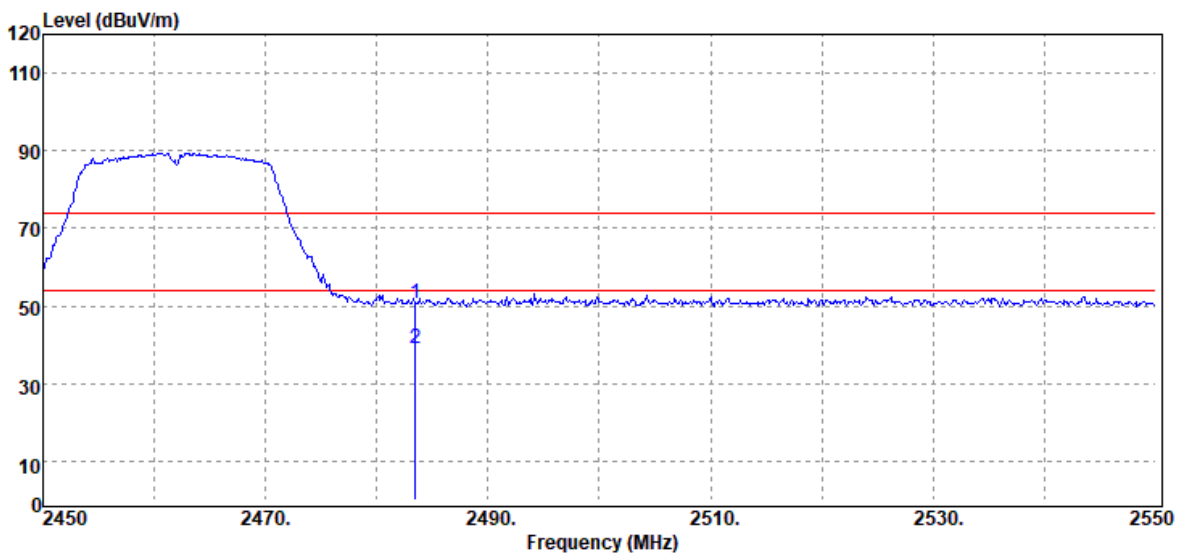

Frequency (MHz)	Detector Mode (PK/QP/AV)	Spectrum Reading Level (dBµV)	Factor (dB)	Actual FS (dBµV/m)	Limit @3m (dBµV/m)	Margin (dB)
2483.50	Peak	46.65	4.04	50.69	74.00	-23.31
2483.50	Average	35.04	4.04	39.08	54.00	-14.92

Test Mode	IEEE 802.11n20 High CH 2462MHz	Temp/Hum	23.1(°C)/ 55%RH
Test Item	Band Edge	Test Date	October 1, 2021
Polarize	Horizontal	Test Engineer	Ray Li
Detector	Peak / Average		

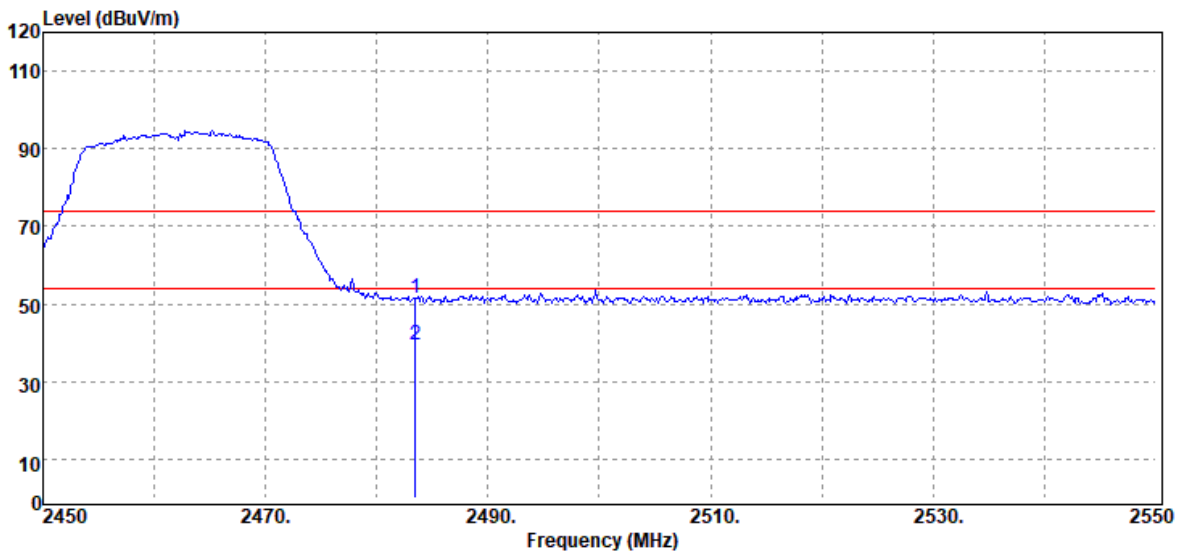

Frequency (MHz)	Detector Mode (PK/QP/AV)	Spectrum Reading Level (dBµV)	Factor (dB)	Actual FS (dBµV/m)	Limit @3m (dBµV/m)	Margin (dB)
2483.50	Peak	47.29	4.04	51.33	74.00	-22.67
2483.50	Average	35.47	4.04	39.51	54.00	-14.49

Test Mode	IEEE 802.11n HT40 Low CH 2422MHz	Temp/Hum	23.1(°C)/ 55%RH
Test Item	Band Edge	Test Date	October 1, 2021
Polarize	Vertical	Test Engineer	Ray Li
Detector	Peak / Average		

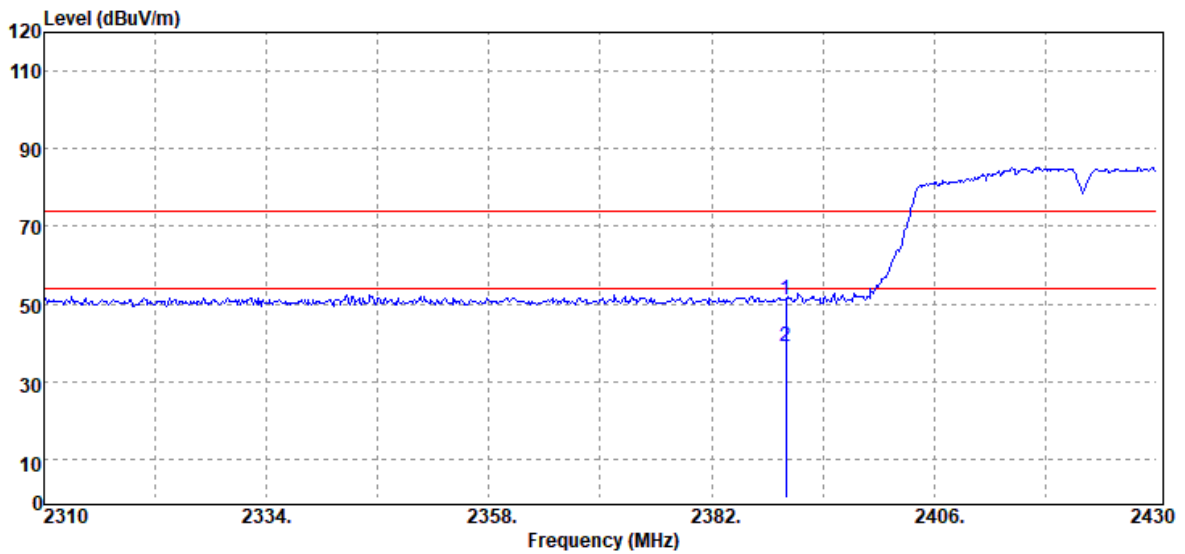

Frequency (MHz)	Detector Mode (PK/QP/AV)	Spectrum Reading Level (dB μ V)	Factor (dB)	Actual FS (dB μ V/m)	Limit @3m (dB μ V/m)	Margin (dB)
2390.00	Peak	47.20	3.70	50.90	74.00	-23.10
2390.00	Average	35.52	3.70	39.22	54.00	-14.78

Test Mode	IEEE 802.11 n40 Low CH 2422MHz	Temp/Hum	23.1(°C)/ 55%RH
Test Item	Band Edge	Test Date	October 1, 2021
Polarize	Horizontal	Test Engineer	Ray Li
Detector	Peak / Average		

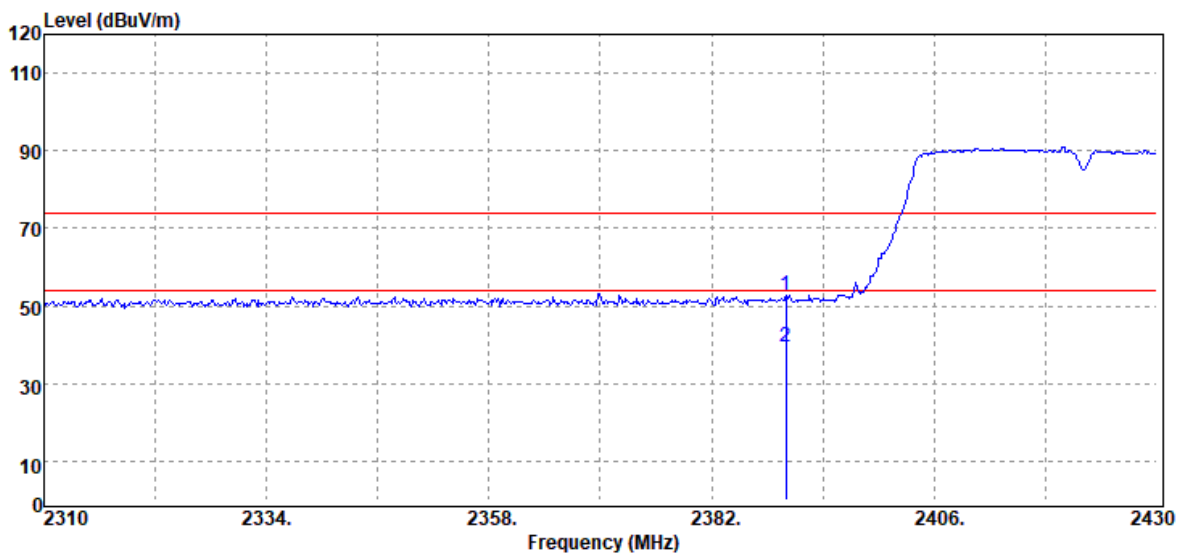

Frequency (MHz)	Detector Mode (PK/QP/AV)	Spectrum Reading Level (dBμV)	Factor (dB)	Actual FS (dBμV/m)	Limit @3m (dBμV/m)	Margin (dB)
2390.00	Peak	48.93	3.70	52.63	74.00	-21.37
2390.00	Average	35.65	3.70	39.35	54.00	-14.65

Test Mode	IEEE 802.11n HT40 High CH 2452MHz	Temp/Hum	23.1(°C)/ 55%RH
Test Item	Band Edge	Test Date	October 1, 2021
Polarize	Vertical	Test Engineer	Ray Li
Detector	Peak / Average		

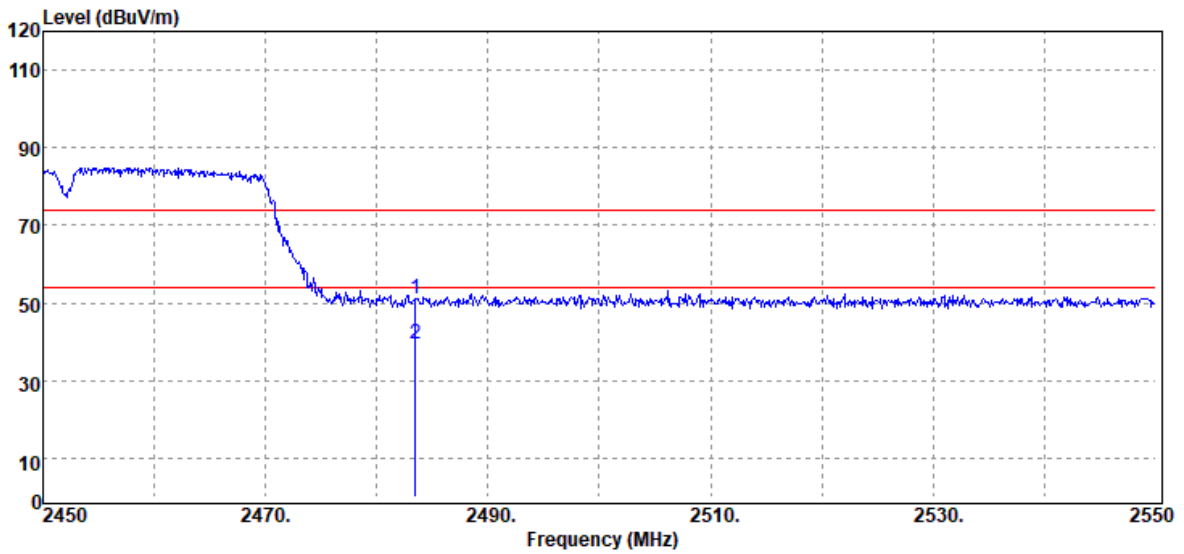

Frequency (MHz)	Detector Mode (PK/QP/AV)	Spectrum Reading Level (dBµV)	Factor (dB)	Actual FS (dBµV/m)	Limit @3m (dBµV/m)	Margin (dB)
2483.50	Peak	47.18	4.04	51.22	74.00	-22.78
2483.50	Average	35.28	4.04	39.32	54.00	-14.68

Test Mode	IEEE 802.11n40 High CH 2452MHz	Temp/Hum	23.1(°C)/ 55%RH
Test Item	Band Edge	Test Date	October 1, 2021
Polarize	Horizontal	Test Engineer	Ray Li
Detector	Peak / Average		

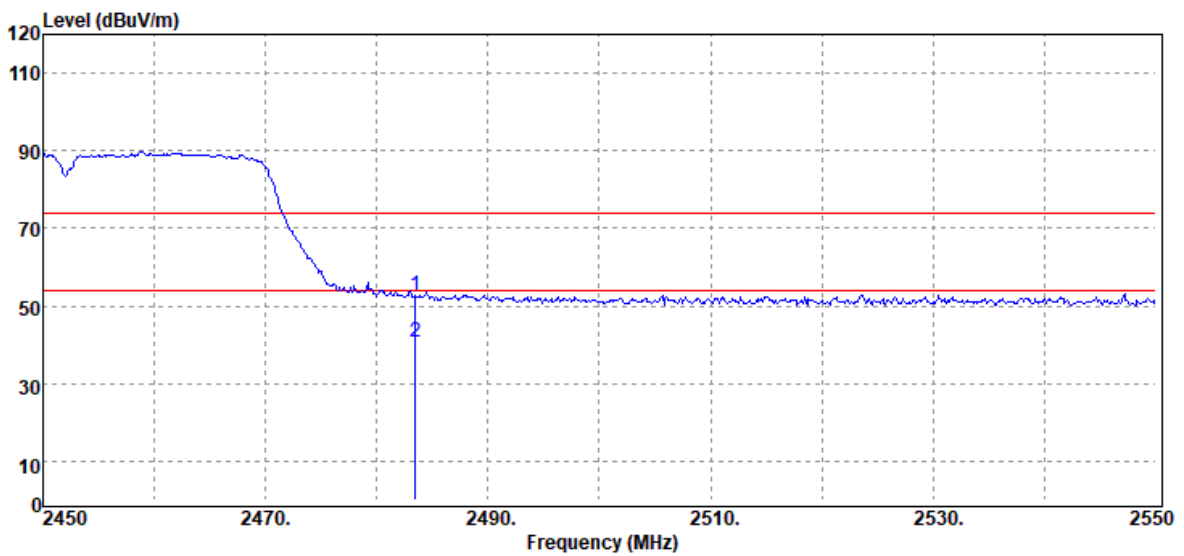

Frequency (MHz)	Detector Mode (PK/QP/AV)	Spectrum Reading Level (dBμV)	Factor (dB)	Actual FS (dBμV/m)	Limit @3m (dBμV/m)	Margin (dB)
2483.50	Peak	48.51	4.04	52.55	74.00	-21.45
2483.50	Average	36.50	4.04	40.54	54.00	-13.46

Below 1G Test Data

Test Mode	Mode 1	Temp/Hum	23.1(°C)/ 55%RH
Test Item	30MHz-1GHz	Test Date	October 1, 2021
Polarize	Vertical	Test Engineer	Ray Li
Detector	Peak	Test Voltage	

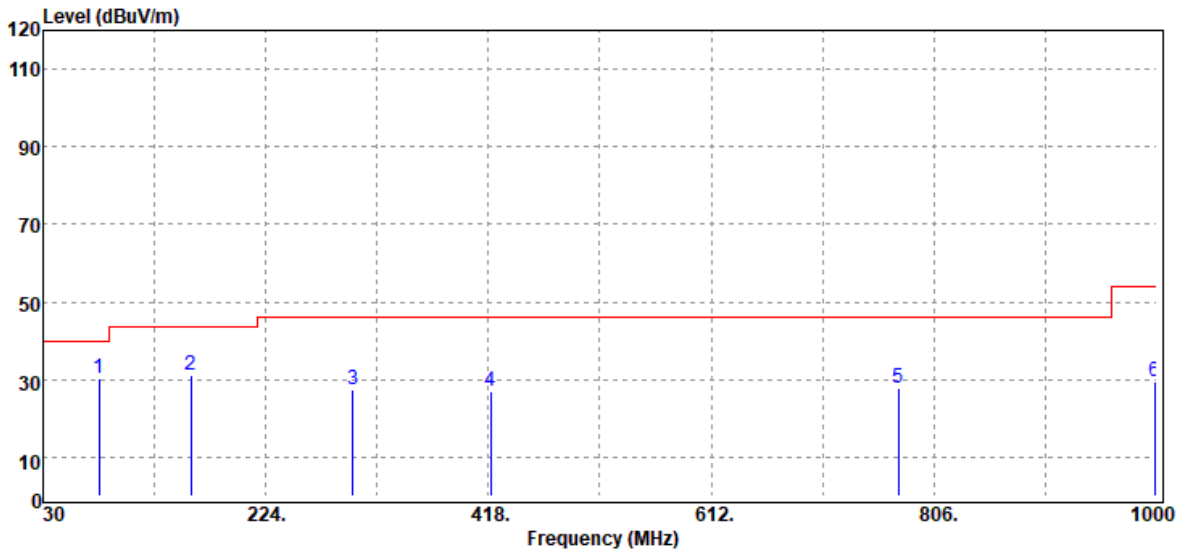

Freq. (MHz)	Detector Mode (PK/QP/AV)	Spectrum Reading Level (dBμV)	Factor (dB)	Actual FS (dBμV/m)	Limit @3m (dBμV/m)	Margin (dB)
78.50	Peak	45.73	-15.53	30.20	40.00	-9.80
159.01	Peak	41.58	-10.51	31.07	43.50	-12.43
299.66	Peak	36.37	-8.80	27.57	46.00	-18.43
419.94	Peak	32.18	-5.26	26.92	46.00	-19.08
774.96	Peak	26.64	1.20	27.84	46.00	-18.16
998.06	Peak	25.02	4.41	29.43	54.00	-24.57

Note: No emission found between lowest internal used/generated frequency to 30MHz(9KHz~30MHz)

Test Mode	Mode 1	Temp/Hum	23.1(°C)/ 55%RH
Test Item	30MHz-1GHz	Test Date	October 1, 2021
Polarize	Horizontal	Test Engineer	Ray Li
Detector	Peak	Test Voltage	

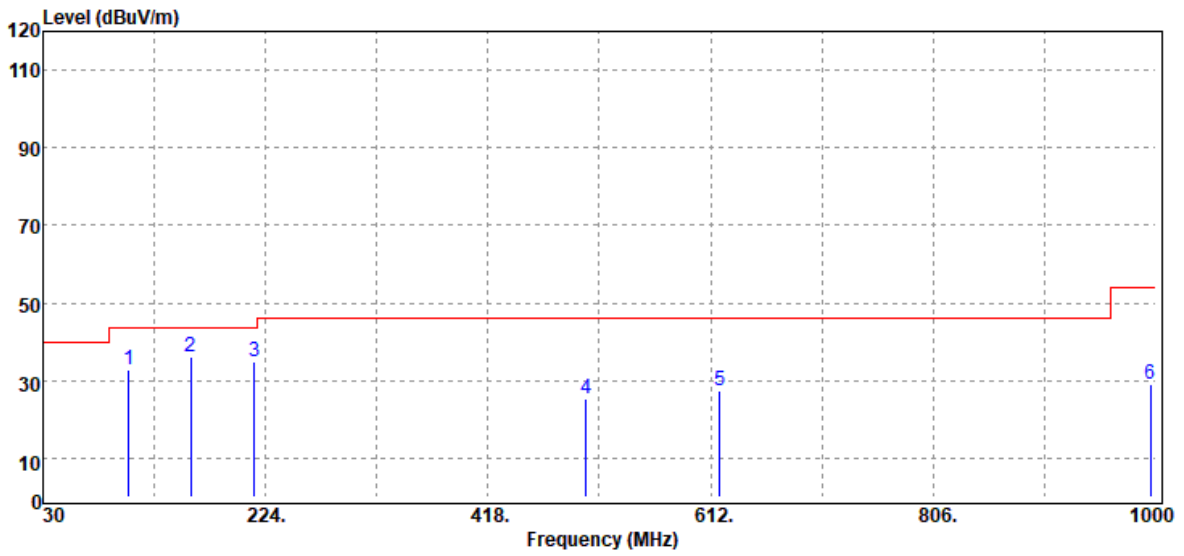

Freq. (MHz)	Detector Mode (PK/QP/AV)	Spectrum Reading Level (dBμV)	Factor (dB)	Actual FS (dBμV/m)	Limit @3m (dBμV/m)	Margin (dB)
104.69	Peak	44.26	-11.31	32.95	43.50	-10.55
159.01	Peak	46.52	-10.51	36.01	43.50	-7.49
214.30	Peak	46.64	-11.93	34.71	43.50	-8.79
503.36	Peak	28.57	-3.38	25.19	46.00	-20.81
619.76	Peak	28.99	-1.41	27.58	46.00	-18.42
995.15	Peak	24.79	4.33	29.12	54.00	-24.88

Note: No emission found between lowest internal used/generated frequency to 30MHz(9KHz~30MHz)

Above 1G Test Data

Test Mode	IEEE 802.11b Low CH	Temp/Hum	23.1(°C)/ 55%RH
Test Item	Harmonic	Test Date	October 1, 2021
Polarize	Vertical	Test Engineer	Ray Li
Detector	Peak		

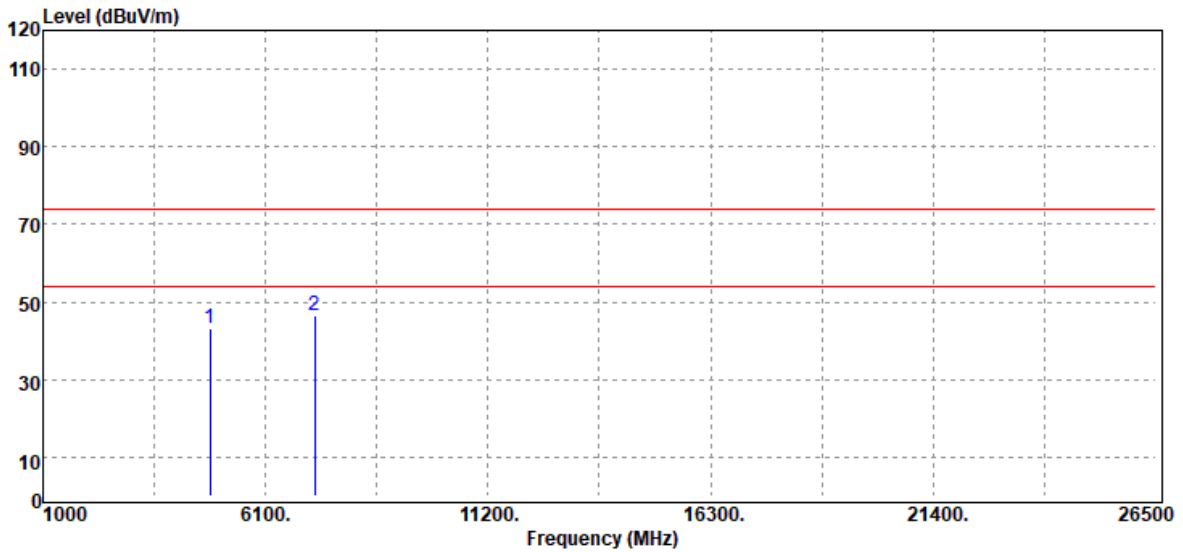

Freq. (MHz)	Detector Mode (PK/QP/AV)	Spectrum Reading Level (dB μ V)	Factor (dB)	Actual FS (dB μ V/m)	Limit @3m (dB μ V/m)	Margin (dB)
4824.00	Peak	33.65	9.38	43.03	74.00	-30.97
7236.00	Peak	33.05	13.48	46.53	74.00	-27.47
N/A						

Remark:

1. Measuring frequencies from 1 GHz to the 10th harmonic of highest fundamental frequency.
2. For above 1GHz, the EUT peak value was under average limit, therefore the Average value compliance with the average limit

Test Mode	IEEE 802.11b Low CH	Temp/Hum	23.1(°C)/ 55%RH
Test Item	Harmonic	Test Date	October 1, 2021
Polarize	Horizontal	Test Engineer	Ray Li
Detector	Peak		

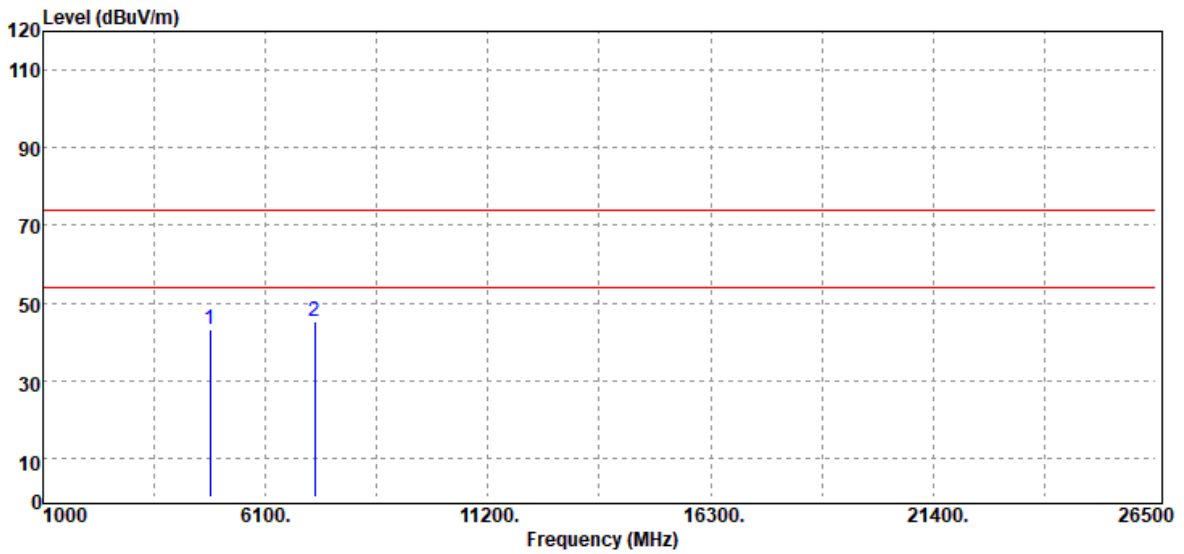

Freq. (MHz)	Detector Mode (PK/QP/AV)	Spectrum Reading Level (dBμV)	Factor (dB)	Actual FS (dBμV/m)	Limit @3m (dBμV/m)	Margin (dB)
4824.00	Peak	33.61	9.38	42.99	74.00	-31.01
7236.00	Peak	31.77	13.48	45.25	74.00	-28.75
N/A						

Remark:

1. Measuring frequencies from 1 GHz to the 10th harmonic of highest fundamental frequency.
2. For above 1GHz,the EUT peak value was under average limit, therefore the Average value compliance with the average limit

Test Mode	IEEE 802.11b Mid CH	Temp/Hum	23.1(°C)/ 55%RH
Test Item	Harmonic	Test Date	October 1, 2021
Polarize	Vertical	Test Engineer	Ray Li
Detector	Peak		

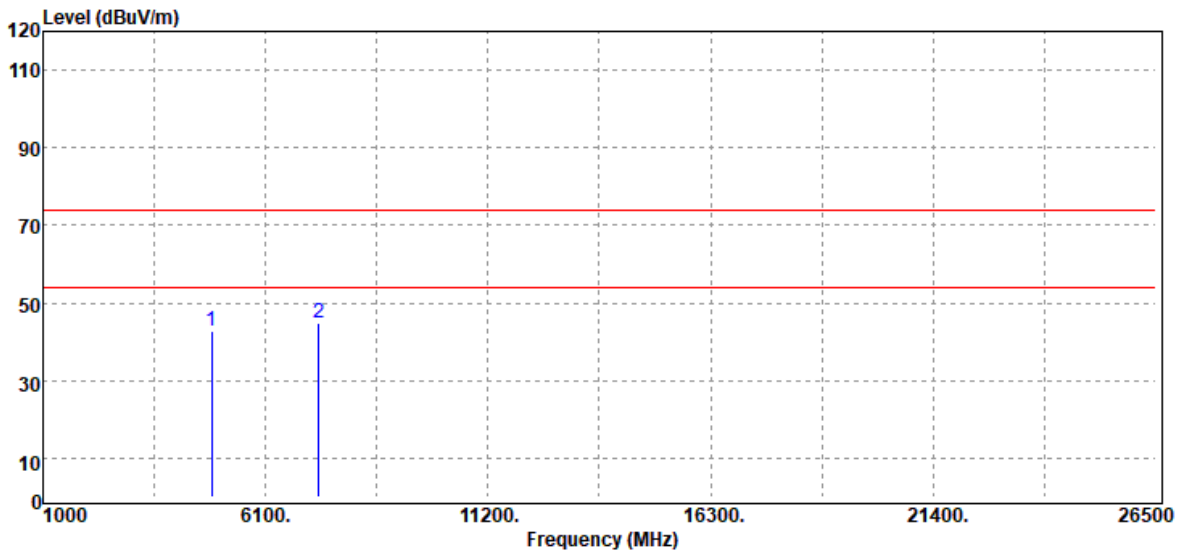

Freq. (MHz)	Detector Mode (PK/QP/AV)	Spectrum Reading Level (dBµV)	Factor (dB)	Actual FS (dBµV/m)	Limit @3m (dBµV/m)	Margin (dB)
4874.00	Peak	33.17	9.49	42.66	74.00	-31.34
7311.00	Peak	31.37	13.46	44.83	74.00	-29.17
N/A						

Remark:

1. Measuring frequencies from 1 GHz to the 10th harmonic of highest fundamental frequency.
2. For above 1GHz,the EUT peak value was under average limit, therefore the Average value compliance with the average limit

Test Mode	IEEE 802.11b Mid CH	Temp/Hum	23.1(°C)/ 55%RH
Test Item	Harmonic	Test Date	October 1, 2021
Polarize	Horizontal	Test Engineer	Ray Li
Detector	Peak		

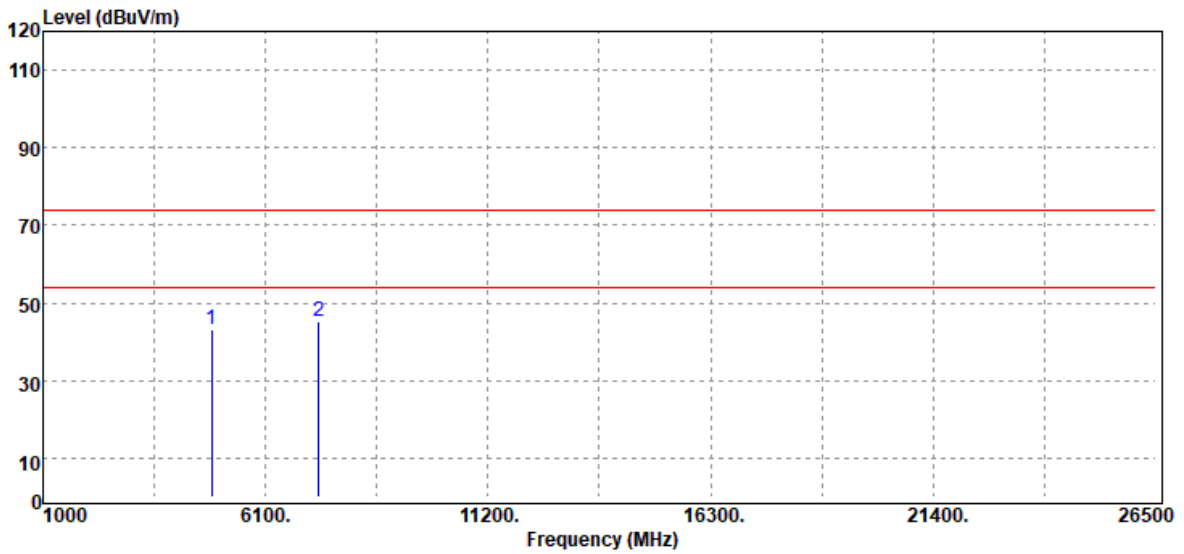

Freq. (MHz)	Detector Mode (PK/QP/AV)	Spectrum Reading Level (dBµV)	Factor (dB)	Actual FS (dBµV/m)	Limit @3m (dBµV/m)	Margin (dB)
4874.00	Peak	33.83	9.49	43.32	74.00	-30.68
7311.00	Peak	31.81	13.46	45.27	74.00	-28.73
N/A						

Remark:

1. Measuring frequencies from 1 GHz to the 10th harmonic of highest fundamental frequency.
2. For above 1GHz, the EUT peak value was under average limit, therefore the Average value compliance with the average limit

Report No.: TMWK2109000573KR

Test Mode	IEEE 802.11b High CH	Temp/Hum	23.1(°C)/ 55%RH
Test Item	Harmonic	Test Date	October 1, 2021
Polarize	Vertical	Test Engineer	Ray Li
Detector	Peak		

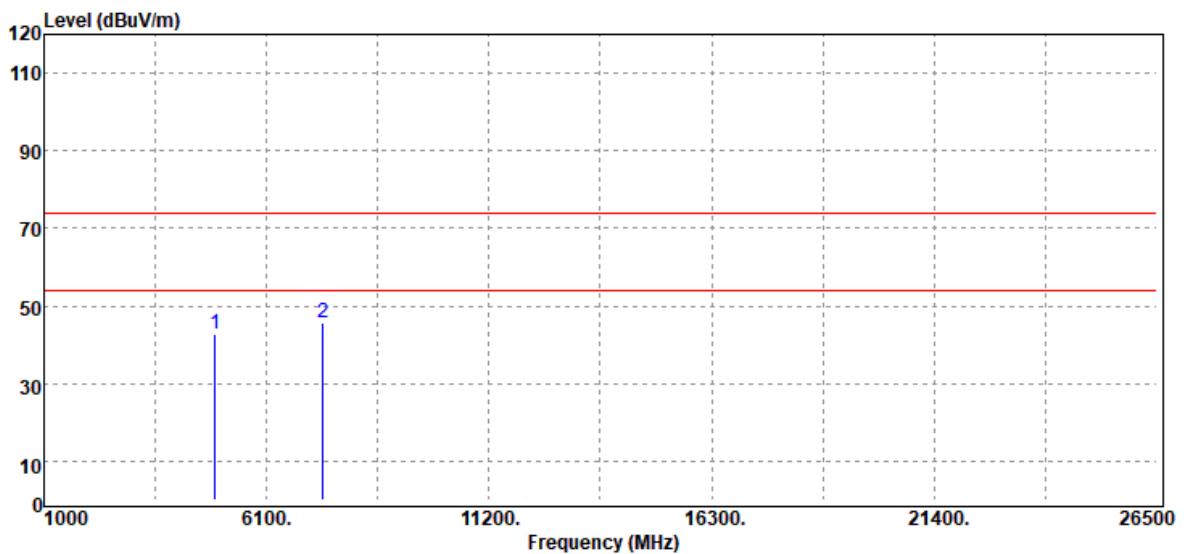

Freq. (MHz)	Detector Mode (PK/QP/AV)	Spectrum Reading Level (dB μ V)	Factor (dB)	Actual FS (dB μ V/m)	Limit @3m (dB μ V/m)	Margin (dB)
4924.00	Peak	33.31	9.63	42.94	74.00	-31.06
7386.00	Peak	32.13	13.59	45.72	74.00	-28.28
N/A						

Remark:

1. Measuring frequencies from 1 GHz to the 10th harmonic of highest fundamental frequency.
2. For above 1GHz,the EUT peak value was under average limit, therefore the Average value compliance with the average limit

Test Mode	IEEE 802.11b High CH	Temp/Hum	23.1(°C)/ 55%RH
Test Item	Harmonic	Test Date	October 1, 2021
Polarize	Horizontal	Test Engineer	Ray Li
Detector	Peak		

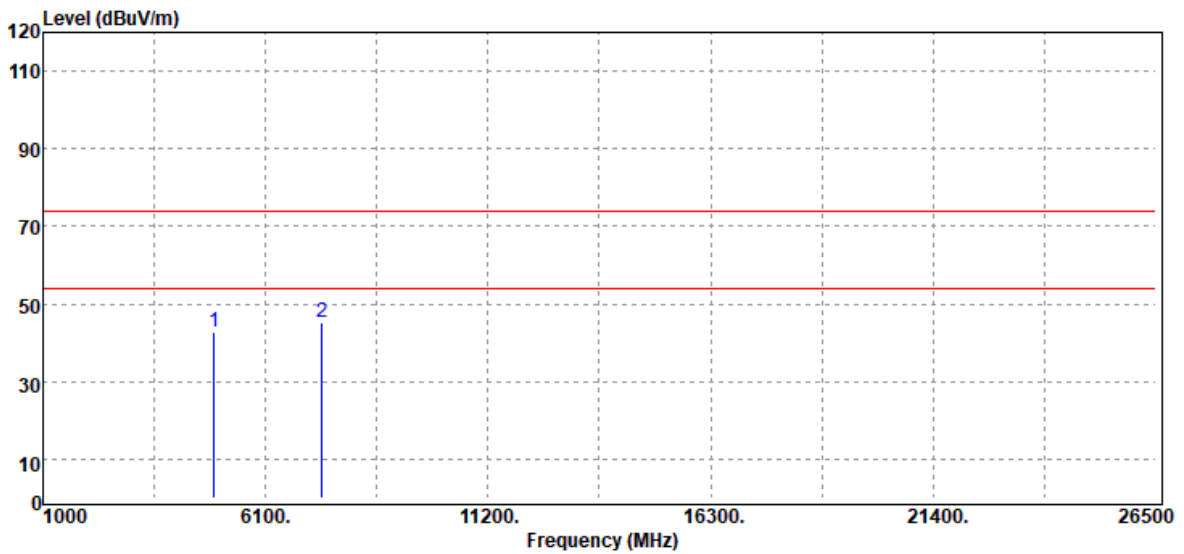

Freq. (MHz)	Detector Mode (PK/QP/AV)	Spectrum Reading Level (dBµV)	Factor (dB)	Actual FS (dBµV/m)	Limit @3m (dBµV/m)	Margin (dB)
4924.00	Peak	33.06	9.63	42.69	74.00	-31.31
7386.00	Peak	31.84	13.59	45.43	74.00	-28.57
N/A						

Remark:

1. Measuring frequencies from 1 GHz to the 10th harmonic of highest fundamental frequency.
2. For above 1GHz, the EUT peak value was under average limit, therefore the Average value compliance with the average limit

Test Mode	IEEE 802.11g Low CH	Temp/Hum	23.1(°C)/ 55%RH
Test Item	Harmonic	Test Date	October 1, 2021
Polarize	Vertical	Test Engineer	Ray Li
Detector	Peak		

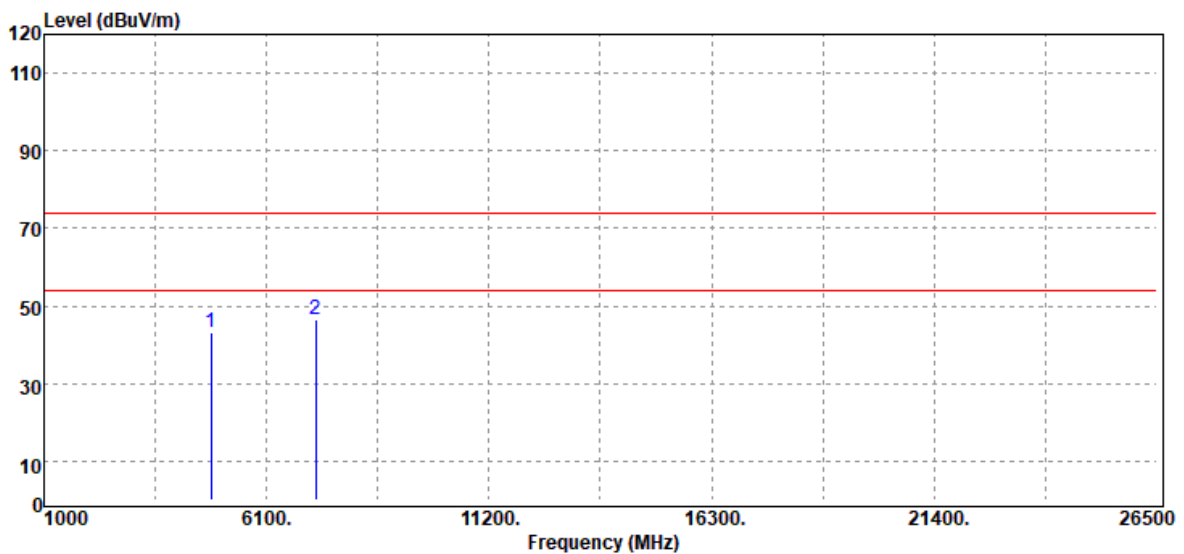

Freq. (MHz)	Detector Mode (PK/QP/AV)	Spectrum Reading Level (dBμV)	Factor (dB)	Actual FS (dBμV/m)	Limit @3m (dBμV/m)	Margin (dB)
4824.00	Peak	33.96	9.38	43.34	74.00	-30.66
7236.00	Peak	32.86	13.48	46.34	74.00	-27.66
N/A						

Remark:

1. Measuring frequencies from 1 GHz to the 10th harmonic of highest fundamental frequency.
2. For above 1GHz, the EUT peak value was under average limit, therefore the Average value compliance with the average limit

Test Mode	IEEE 802.11g Low CH	Temp/Hum	23.1(°C)/ 55%RH
Test Item	Harmonic	Test Date	October 1, 2021
Polarize	Horizontal	Test Engineer	Ray Li
Detector	Peak		

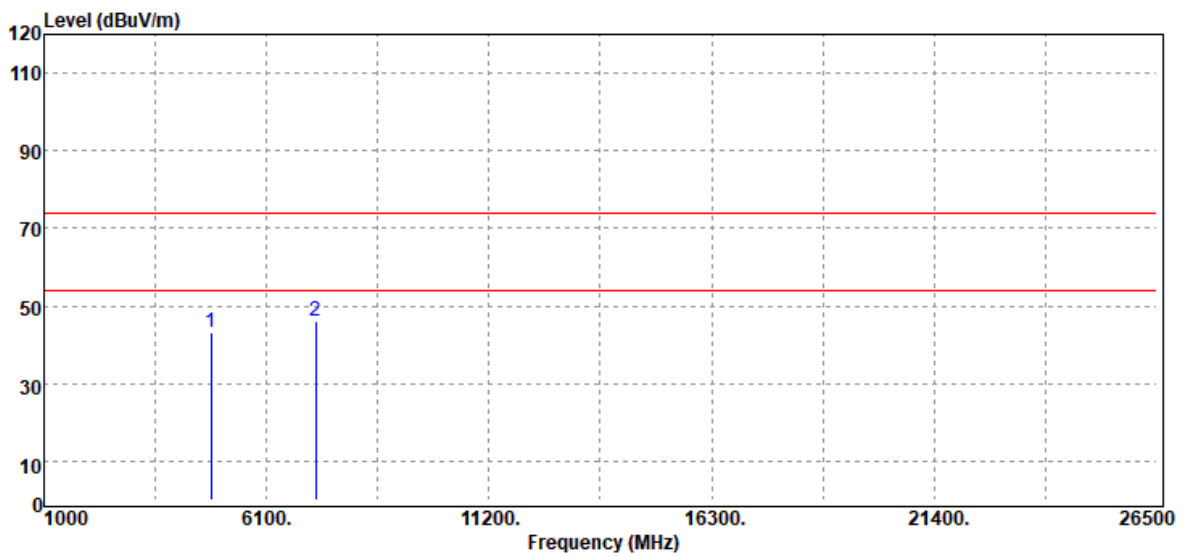

Freq. (MHz)	Detector Mode (PK/QP/AV)	Spectrum Reading Level (dB μ V)	Factor (dB)	Actual FS (dB μ V/m)	Limit @3m (dB μ V/m)	Margin (dB)
4824.00	Peak	33.63	9.38	43.01	74.00	-30.99
7236.00	Peak	32.46	13.48	45.94	74.00	-28.06
N/A						

Remark:

1. Measuring frequencies from 1 GHz to the 10th harmonic of highest fundamental frequency.
2. For above 1GHz,the EUT peak value was under average limit, therefore the Average value compliance with the average limit

Test Mode	IEEE 802.11g Mid CH	Temp/Hum	23.1(°C)/ 55%RH
Test Item	Harmonic	Test Date	October 1, 2021
Polarize	Vertical	Test Engineer	Ray Li
Detector	Peak		

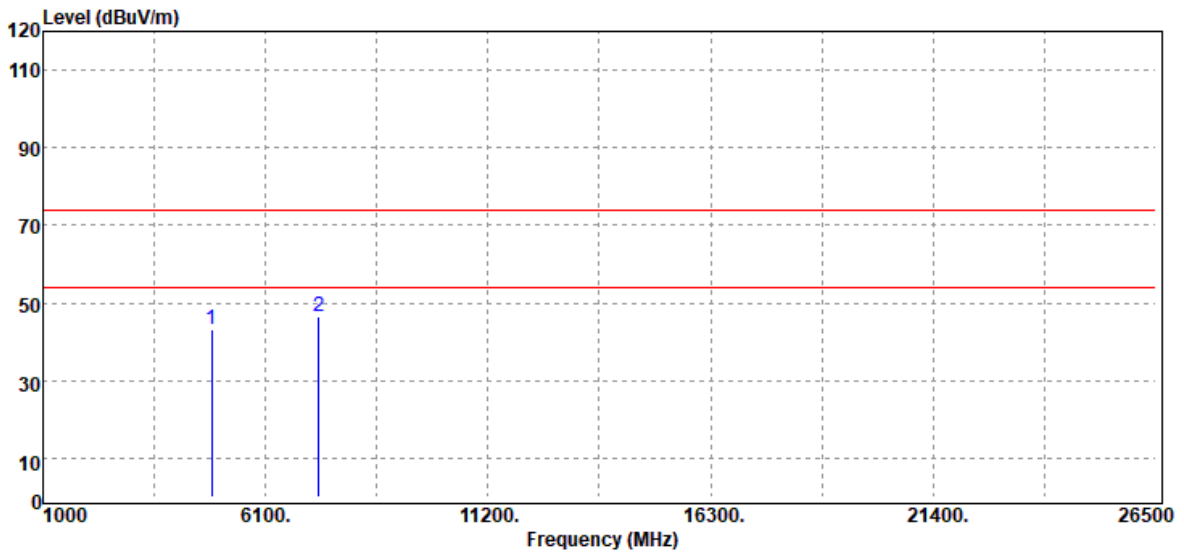

Freq. (MHz)	Detector Mode (PK/QP/AV)	Spectrum Reading Level (dBµV)	Factor (dB)	Actual FS (dBµV/m)	Limit @3m (dBµV/m)	Margin (dB)
4874.00	Peak	33.64	9.49	43.13	74.00	-30.87
7311.00	Peak	32.87	13.46	46.33	74.00	-27.67
N/A						

Remark:

1. Measuring frequencies from 1 GHz to the 10th harmonic of highest fundamental frequency.
2. For above 1GHz,the EUT peak value was under average limit, therefore the Average value compliance with the average limit

Test Mode	IEEE 802.11g Mid CH	Temp/Hum	23.1(°C)/ 55%RH
Test Item	Harmonic	Test Date	October 1, 2021
Polarize	Horizontal	Test Engineer	Ray Li
Detector	Peak		

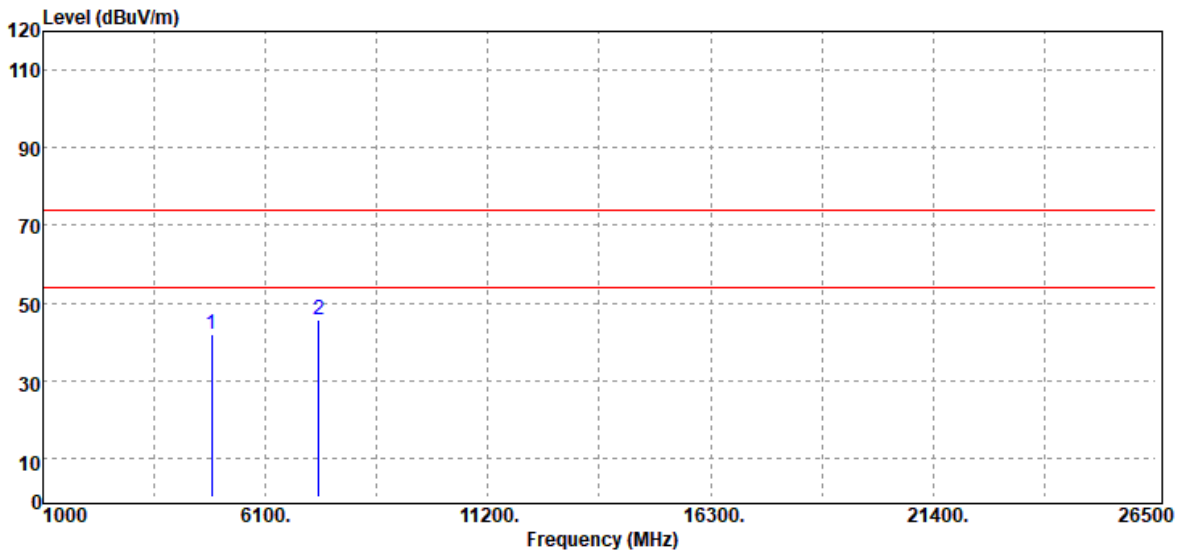

Freq. (MHz)	Detector Mode (PK/QP/AV)	Spectrum Reading Level (dBµV)	Factor (dB)	Actual FS (dBµV/m)	Limit @3m (dBµV/m)	Margin (dB)
4874.00	Peak	32.42	9.49	41.91	74.00	-32.09
7311.00	Peak	32.26	13.46	45.72	74.00	-28.28
N/A						

Remark:

1. Measuring frequencies from 1 GHz to the 10th harmonic of highest fundamental frequency.
2. For above 1GHz, the EUT peak value was under average limit, therefore the Average value compliance with the average limit

Test Mode	IEEE 802.11g High CH	Temp/Hum	23.1(°C)/ 55%RH
Test Item	Harmonic	Test Date	October 1, 2021
Polarize	Vertical	Test Engineer	Ray Li
Detector	Peak		

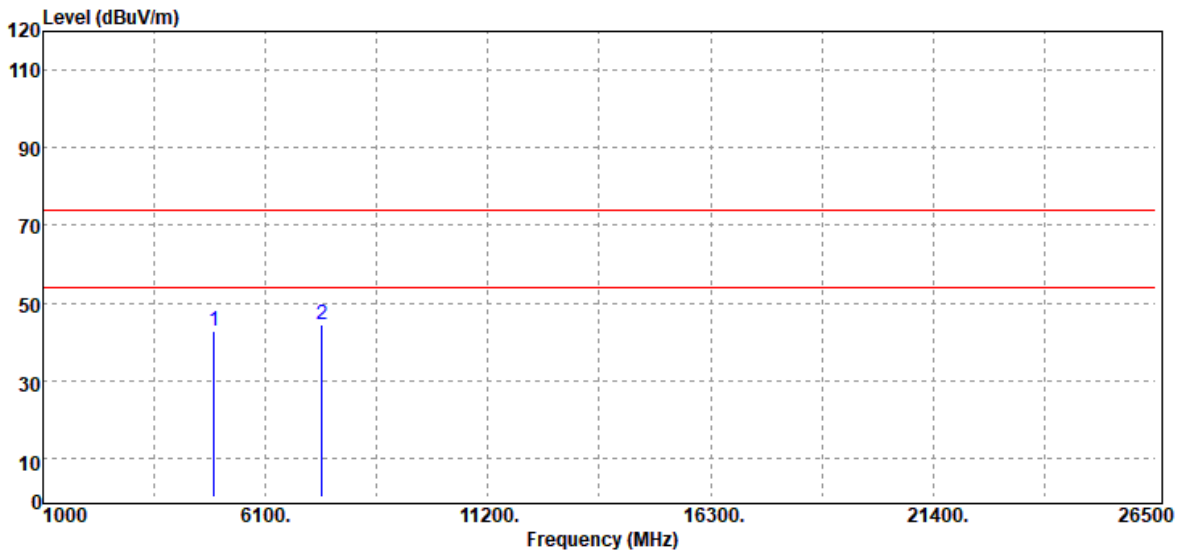

Freq. (MHz)	Detector Mode (PK/QP/AV)	Spectrum Reading Level (dBµV)	Factor (dB)	Actual FS (dBµV/m)	Limit @3m (dBµV/m)	Margin (dB)
4924.00	Peak	33.07	9.63	42.70	74.00	-31.30
7386.00	Peak	30.94	13.59	44.53	74.00	-29.47
N/A						

Remark:

1. Measuring frequencies from 1 GHz to the 10th harmonic of highest fundamental frequency.
2. For above 1GHz,the EUT peak value was under average limit, therefore the Average value compliance with the average limit

Test Mode	IEEE 802.11g High CH	Temp/Hum	23.1(°C)/ 55%RH
Test Item	Harmonic	Test Date	October 1, 2021
Polarize	Horizontal	Test Engineer	Ray Li
Detector	Peak		

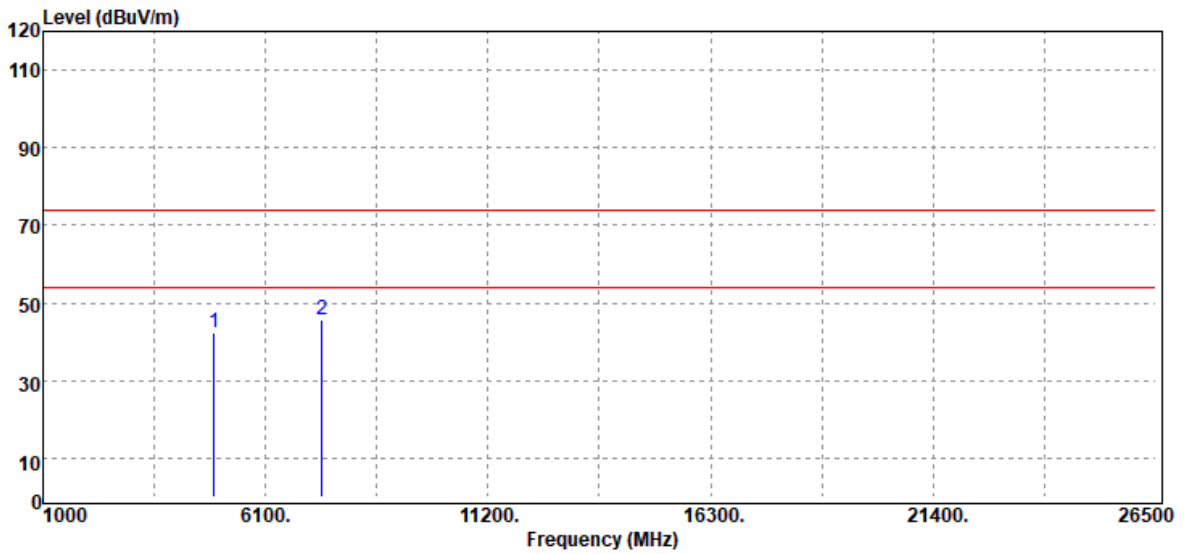

Freq. (MHz)	Detector Mode (PK/QP/AV)	Spectrum Reading Level (dBµV)	Factor (dB)	Actual FS (dBµV/m)	Limit @3m (dBµV/m)	Margin (dB)
4924.00	Peak	32.63	9.63	42.26	74.00	-31.74
7386.00	Peak	32.00	13.59	45.59	74.00	-28.41
N/A						

Remark:

1. Measuring frequencies from 1 GHz to the 10th harmonic of highest fundamental frequency.
2. For above 1GHz, the EUT peak value was under average limit, therefore the Average value compliance with the average limit

Test Mode	IEEE 802.11n HT20 Low CH	Temp/Hum	23.1(°C)/ 55%RH
Test Item	Harmonic	Test Date	October 1, 2021
Polarize	Vertical	Test Engineer	Ray Li
Detector	Peak		

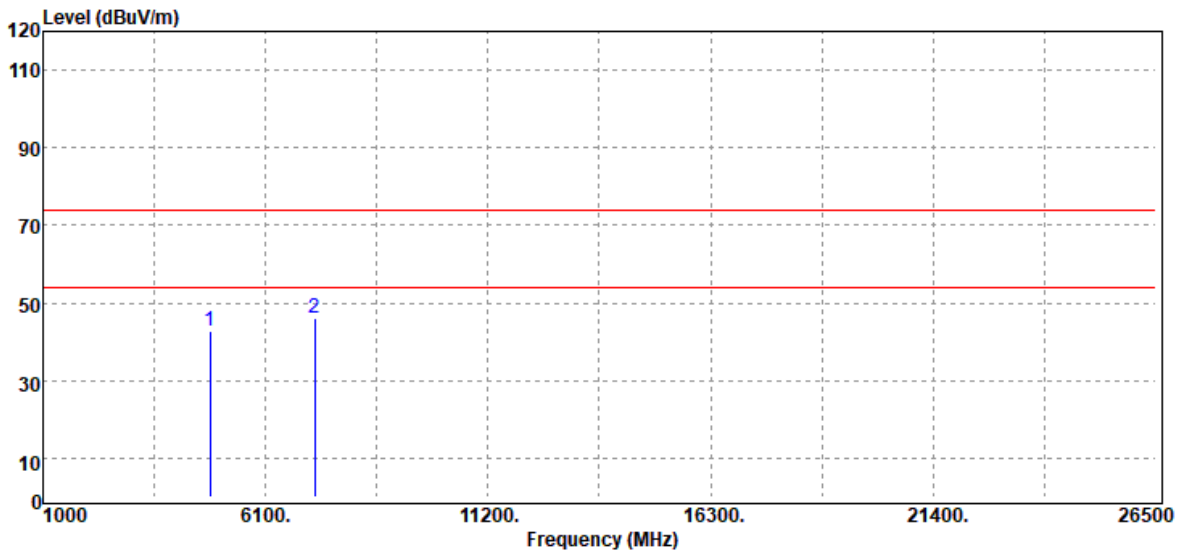

Freq. (MHz)	Detector Mode (PK/QP/AV)	Spectrum Reading Level (dBμV)	Factor (dB)	Actual FS (dBμV/m)	Limit @3m (dBμV/m)	Margin (dB)
4824.00	Peak	33.59	9.38	42.97	74.00	-31.03
7236.00	Peak	32.76	13.48	46.24	74.00	-27.76
N/A						

Remark:

1. Measuring frequencies from 1 GHz to the 10th harmonic of highest fundamental frequency.
2. For above 1GHz,the EUT peak value was under average limit, therefore the Average value compliance with the average limit

Test Mode	IEEE 802.11n HT20 Low CH	Temp/Hum	23.1(°C)/ 55%RH
Test Item	Harmonic	Test Date	October 1, 2021
Polarize	Horizontal	Test Engineer	Ray Li
Detector	Peak		

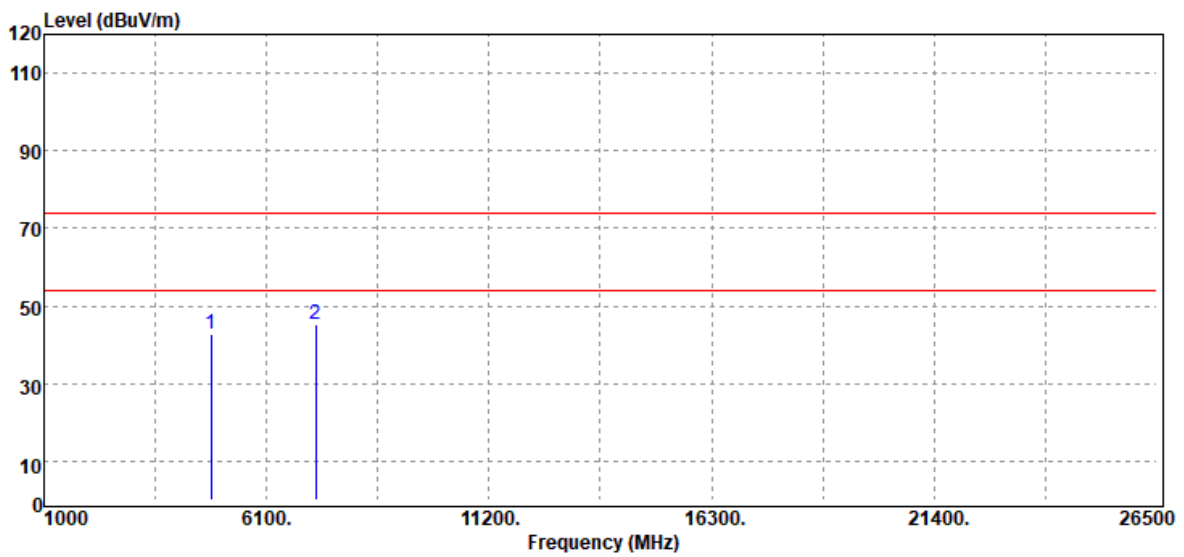

Freq. (MHz)	Detector Mode (PK/QP/AV)	Spectrum Reading Level (dB μ V)	Factor (dB)	Actual FS (dB μ V/m)	Limit @3m (dB μ V/m)	Margin (dB)
4824.00	Peak	33.58	9.38	42.96	74.00	-31.04
7236.00	Peak	31.91	13.48	45.39	74.00	-28.61
N/A						

Remark:

1. Measuring frequencies from 1 GHz to the 10th harmonic of highest fundamental frequency.
2. For above 1GHz,the EUT peak value was under average limit, therefore the Average value compliance with the average limit

Test Mode	IEEE 802.11n HT20 Mid CH	Temp/Hum	23.1(°C)/ 55%RH
Test Item	Harmonic	Test Date	October 1, 2021
Polarize	Vertical	Test Engineer	Ray Li
Detector	Peak		

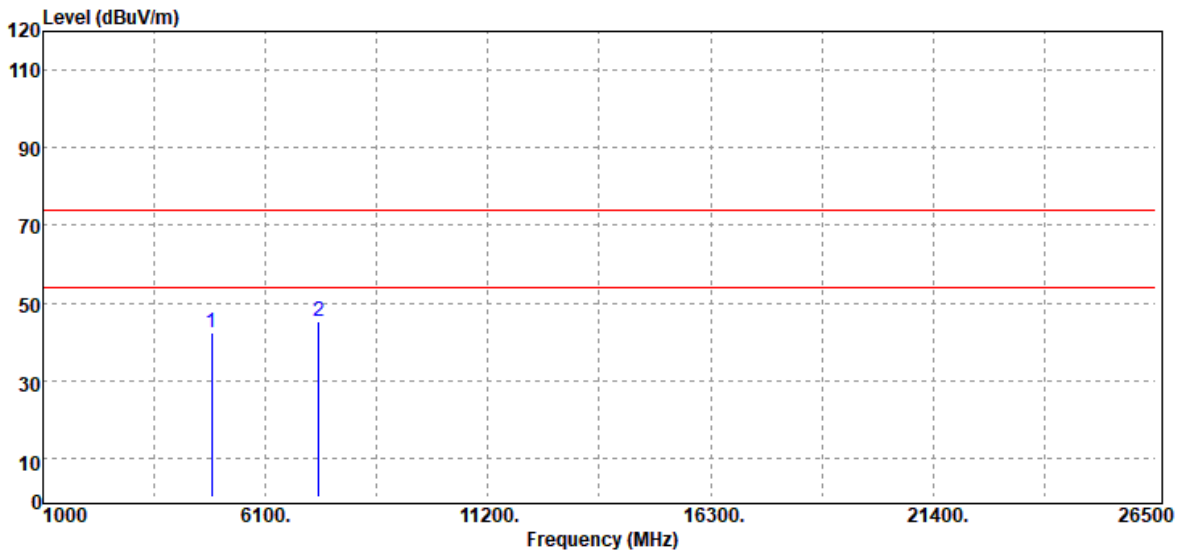

Freq. (MHz)	Detector Mode (PK/QP/AV)	Spectrum Reading Level (dB μ V)	Factor (dB)	Actual FS (dB μ V/m)	Limit @3m (dB μ V/m)	Margin (dB)
4874.00	Peak	32.95	9.49	42.44	74.00	-31.56
7311.00	Peak	31.98	13.46	45.44	74.00	-28.56
N/A						

Remark:

1. Measuring frequencies from 1 GHz to the 10th harmonic of highest fundamental frequency.
2. For above 1GHz, the EUT peak value was under average limit, therefore the Average value compliance with the average limit

Test Mode	IEEE 802.11n HT20 Mid CH	Temp/Hum	23.1(°C)/ 55%RH
Test Item	Harmonic	Test Date	October 1, 2021
Polarize	Horizontal	Test Engineer	Ray Li
Detector	Peak		

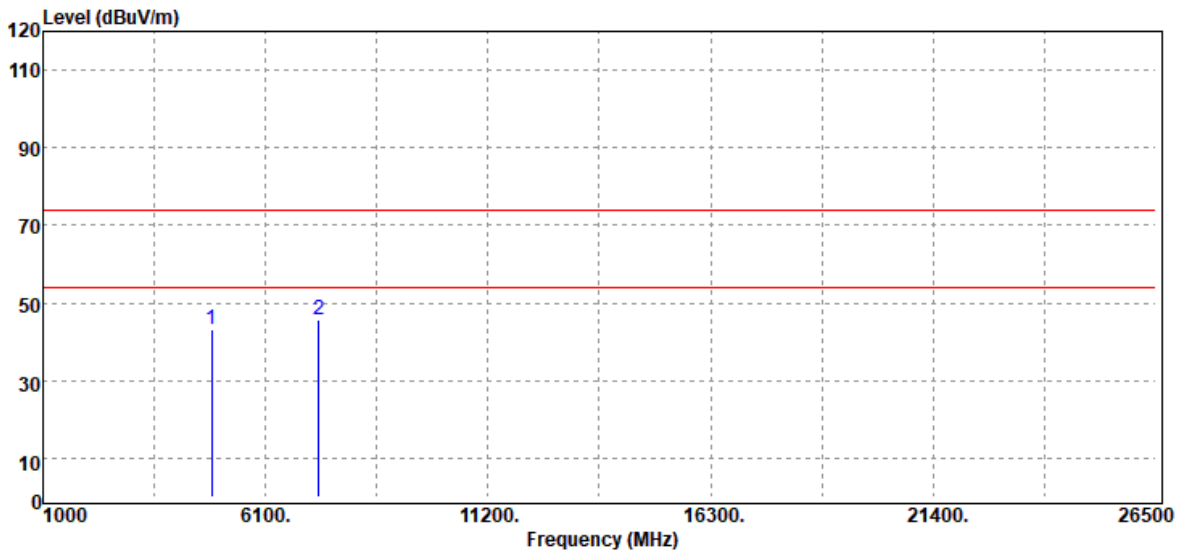

Freq. (MHz)	Detector Mode (PK/QP/AV)	Spectrum Reading Level (dBµV)	Factor (dB)	Actual FS (dBµV/m)	Limit @3m (dBµV/m)	Margin (dB)
4874.00	Peak	33.58	9.49	43.07	74.00	-30.93
7311.00	Peak	32.34	13.46	45.80	74.00	-28.20
N/A						

Remark:

1. Measuring frequencies from 1 GHz to the 10th harmonic of highest fundamental frequency.
2. For above 1GHz,the EUT peak value was under average limit, therefore the Average value compliance with the average limit

Test Mode	IEEE 802.11n HT20 High CH	Temp/Hum	23.1(°C)/ 55%RH
Test Item	Harmonic	Test Date	October 1, 2021
Polarize	Vertical	Test Engineer	Ray Li
Detector	Peak		

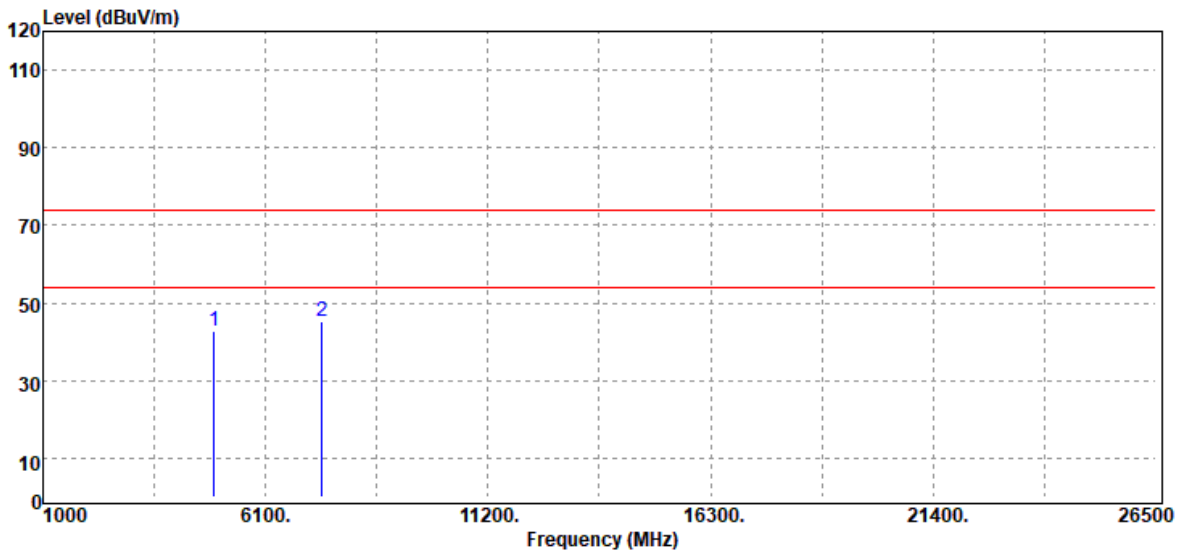

Freq. (MHz)	Detector Mode (PK/QP/AV)	Spectrum Reading Level (dB μ V)	Factor (dB)	Actual FS (dB μ V/m)	Limit @3m (dB μ V/m)	Margin (dB)
4924.00	Peak	32.97	9.63	42.60	74.00	-31.40
7386.00	Peak	31.66	13.59	45.25	74.00	-28.75
N/A						

Remark:

1. Measuring frequencies from 1 GHz to the 10th harmonic of highest fundamental frequency.
2. For above 1GHz, the EUT peak value was under average limit, therefore the Average value compliance with the average limit