

RADIO TEST REPORT

FCC 47 CFR PART 15 SUBPART C INDUSTRY CANADA RSS-247

Test Standard	FCC Part 15.247 RSS-247 issue 2 and RSS-GEN issue 5
Product name	ac2x2+BT5.0 USB2.0
Brand Name	CC&C
Model No.	P31ASUS
Test Result	Pass
Statements of Conformity	Determination of compliance is based on the results of the compliance measurement, not taking into account measurement instrumentation uncertainty.

The test Result was tested by Compliance Certification Services Inc. The test data, data evaluation, test procedures, and equipment configurations shown in this report were given in ANSI C63.10: 2013 and compliance standards.

The test results of this report relate only to the tested sample (EUT) identified in this report.

The test Report of full or partial shall not copy. Without written approval of Compliance Certification Services Inc. (Wugu Laboratory)

Approved by:



Kevin Tsai
Deputy Manager

Unless otherwise stated the results shown in this test report refer only to the sample(s) tested and such sample(s) are retained for 90 days only.
除非另有說明，此報告結果僅對測試之樣品負責，同時此樣品僅保留90天。本報告未經本公司書面許可，不可部份複製。

This document is issued by the Company subject to its General Conditions of Service printed overleaf, available on request or accessible at <http://www.sgs.com.tw/Terms-and-Conditions> and, for electronic format documents, subject to Terms and Conditions for Electronic Documents at <http://www.sgs.com.tw/Terms-and-Conditions>. Attention is drawn to the limitation of liability, indemnification and jurisdiction issues defined therein. Any holder of this document is advised that information contained hereon reflects the Company's findings at the time of its intervention only and within the limits of client's instruction, if any. The Company's sole responsibility is to its Client and this document does not exonerate parties to a transaction from exercising all their rights and obligations under the transaction documents. This document cannot be reproduced, except in full, without prior written approval of the Company. Any unauthorized alteration, forgery or falsification of the content or appearance of this document is unlawful and offenders may be prosecuted to the fullest extent of the law.

Revision History

Rev.	Issue Date	Revisions	Effect Page	Revised By
00	November 25, 2021	Initial Issue	ALL	Doris Chu

Report No.: TMWK2109000572KR

Table of contents

1.	GENERAL INFORMATION	4
1.1	EUT INFORMATION	4
1.2	EUT CHANNEL INFORMATION	5
1.3	ANTENNA INFORMATION	5
1.4	MEASUREMENT UNCERTAINTY.....	6
1.5	FACILITIES AND TEST LOCATION	7
1.6	INSTRUMENT CALIBRATION	7
1.7	SUPPORT AND EUT ACCESSORIES EQUIPMENT	9
1.8	TEST METHODOLOGY AND APPLIED STANDARDS	9
2.	TEST SUMMARY	10
3.	DESCRIPTION OF TEST MODES.....	11
3.1	THE WORST MODE OF OPERATING CONDITION	11
3.2	THE WORST MODE OF MEASUREMENT	12
3.3	EUT DUTY CYCLE.....	13
4.	TEST RESULT	14
4.1	AC POWER LINE CONDUCTED EMISSION	14
4.2	6DB BANDWIDTH AND OCCUPIED BANDWIDTH (99%)	19
4.3	OUTPUT POWER MEASUREMENT	25
4.4	POWER SPECTRAL DENSITY.....	29
4.5	CONDUCTED BAND EDGE AND SPURIOUS EMISSION	33
4.6	RADIATION BANDEDGE AND SPURIOUS EMISSION	40
APPENDIX 1 - PHOTOGRAPHS OF EUT		

Report No.: TMWK2109000572KR

1. GENERAL INFORMATION

1.1 EUT INFORMATION

Applicant	CC&C Technologies, Inc. 8F, No.150, Jian Yi Rd, Zhonghe District, New Taipei City, 235, Taiwan
Manufacturer	CC&C Technologies, Inc. 8F, No.150, Jian Yi Rd, Zhonghe District, New Taipei City, 235, Taiwan
Equipment	ac2x2+BT5.0 USB2.0
Model No.	P31ASUS
Model Discrepancy	N/A
Trade Name	CC&C
Received Date	September 10, 2021
Date of Test	September 28 ~ October 4, 2021
Power Supply	Power from host device.
HW Version	V.A
SW Version	V15
EUT Serial #	CCCP312145001

Remark:

1. For more details, please refer to the User's manual of the EUT.
2. Disclaimer: Antenna information is provided by the applicant, test results of this report are applicable to the sample EUT received.

Report No.: TMWK2109000572KR

1.2 EUT CHANNEL INFORMATION

Frequency Range	2402MHz-2480MHz
Modulation Type	GFSK for BLE 1 Mbps & BLE 2 Mbps
Number of channels	40 Channels

Remark:

Refer as ANSI C63.10: 2013 clause 5.6.1 Table 4 for test channels

Number of frequencies to be tested		
Frequency range in which device operates	Number of frequencies	Location in frequency range of operation
<input type="checkbox"/> 1 MHz or less	1	Middle
<input type="checkbox"/> 1 MHz to 10 MHz	2	1 near top and 1 near bottom
<input checked="" type="checkbox"/> More than 10 MHz	3	1 near top, 1 near middle, and 1 near bottom

1.3 ANTENNA INFORMATION

Antenna Type	<input type="checkbox"/> FPC <input checked="" type="checkbox"/> PCB <input type="checkbox"/> Dipole <input type="checkbox"/> Coils
Antenna Gain	Main: WA-P-LB-02-914: Gain :2.93 dBi

Remark:

1.The antenna(s) of the EUT are permanently attached and there are no provisions for connection to an external antenna. So the EUT complies with the requirements of §15.203 and RSS-Gen 6.8.

Report No.: TMWK2109000572KR

1.4 MEASUREMENT UNCERTAINTY

PARAMETER	UNCERTAINTY
AC Powerline Conducted Emission	+/- 1.2575
Emission bandwidth, 20dB bandwidth	+/- 0.0014
RF output power, conducted	+/- 1.14
Power density, conducted	+/- 1.40
3M Semi Anechoic Chamber / 30M~1G (Horizontally)	+/- 3.91
3M Semi Anechoic Chamber / 30M~1G (Vertically)	+/- 4.57
3M Semi Anechoic Chamber / 1G~6G	+/- 5.20
3M Semi Anechoic Chamber / 6G~18G	+/- 5.18
3M Semi Anechoic Chamber / 18G~40G	+/- 3.68

Remark:

1. This uncertainty represents an expanded uncertainty expressed at approximately the 95% confidence level using a coverage factor of $k=2$
2. ISO/IEC 17025 requires that an estimate of the measurement uncertainties associated with the emissions test results be included in the report.

Report No.: TMWK2109000572KR

1.5 FACILITIES AND TEST LOCATION

All measurement facilities used to collect the measurement data are located at No.11, Wugong 6th Rd., Wugu Dist., New Taipei City, Taiwan. (R.O.C.)

CAB identifier: TW1309

Test site	Test Engineer	Remark
AC Conduction Room	Jack Chen	-
Radiation	Ray Li	-
RF Conducted	Lance Chen	-

Remark: The lab has been recognized as the FCC accredited lab under the KDB 974614 D01 and is listed in the FCC public Access Link (PAL) database, FCC Registration No. :444940, the FCC Designation No.:TW1309

1.6 INSTRUMENT CALIBRATION

RF Conducted Test Site					
Name of Equipment	Manufacturer	Model	Serial Number	Calibration Date	Calibration Due
Coaxial Cable	Woken	WC12	CC003	06/28/2021	06/27/2022
Coaxial Cable	Woken	WC12	CC001	06/28/2021	06/27/2022
Power Meter	Anritsu	ML2487A	6K00003260	05/24/2021	05/23/2022
Power Sensor	Anritsu	MA2490A	032910	05/24/2021	05/23/2022
EXA Signal Analyzer	KEYSIGHT	N9010B	MY55460167	09/07/2021	09/06/2022
Software	Radio Test Software Ver. 21				

Conducted Emission Room					
Name of Equipment	Manufacturer	Model	Serial Number	Calibration Date	Calibration Due
CABLE	EMCI	CFD300-NL	CERF	06/28/2021	06/27/2022
EMI Test Receiver	R&S	ESCI	100064	07/05/2021	07/04/2022
LISN	SCHAFFNER	NNB 41	03/10013	02/02/2021	02/01/2022
Software	EZ-EMC(CCS-3A1-CE)				

Report No.: TMWK2109000572KR

3M 966 Chamber Test Site					
Equipment	Manufacturer	Model	Serial Number	Cal Date	Cal Due
Band Reject Filters	MICRO TRONICS	BRM 50702	120	02/08/2021	02/07/2022
Bilog Antenna	Sunol Sciences	JB3	A030105	07/19/2021	07/18/2022
Coaxial Cable	HUBER SUHNER	SUCOFLEX 104PEA	20995	02/24/2021	02/23/2022
Coaxial Cable	EMCI	EMC105	190914+327109/4	09/17/2021	09/16/2022
Digital Thermo-Hygro Meter	WISEWIND	1206	D07	01/06/2021	01/05/2022
Horn Antenna	ETS LINDGREN	3116	00026370	12/11/2020	12/10/2021
Horn Antenna	ETS LINDGREN	3117	00055165	07/29/2021	07/28/2022
K Type Cable	Huber+Suhner	SUCOFLEX 102	29406/2	12/09/2020	12/08/2021
K Type Cable	Huber+Suhner	SUCOFLEX 102	22470/2	12/09/2020	12/08/2021
Pre-Amplifier	EMEC	EM330	060609	02/24/2021	02/23/2022
Pre-Amplifier	HP	8449B	3008A00965	12/25/2020	12/24/2021
Pre-Amplifier	MITEQ	AMF-6F-18004000-37-8P	985646	09/08/2021	09/07/2022
PSA Series Spectrum Analyzer	Agilent	E4446A	US42510268	09/23/2021	09/22/2022
Antenna Tower	CCS	CC-A-1F	N/A	N.C.R	N.C.R
Controller	CCS	CC-C-1F	N/A	N.C.R	N.C.R
Turn Table	CCS	CC-T-1F	N/A	N.C.R	N.C.R
Software	e3 6.11-20180413				

Remark: Each piece of equipment is scheduled for calibration once a year.

Report No.: TMWK2109000572KR

1.7 SUPPORT AND EUT ACCESSORIES EQUIPMENT

EUT Accessories Equipment					
No.	Equipment	Brand	Model	Series No.	FCC ID
	N/A				

Support Equipment						
No.	Equipment	Brand	Model	Series No.	FCC ID	IC
1	NB(G)	Lenovo	IBM 1951	N/A	CJ6UPA3489WL	N/A
2	NB(J)	TOSHIBA	PT345T-00L002	N/A	PD97260H	1000M-7260H

1.8 TEST METHODOLOGY AND APPLIED STANDARDS

The test methodology, setups and results comply with all requirements in accordance with ANSI C63.10:2013, FCC Part 2, FCC Part 15.247, RSS-247 Issue 2 and RSS-GEN Issue 5

2. TEST SUMMARY

FCC Standard Section	IC Standard Section	Report Section	Test Item	Result
15.203	RSS-Gen 6.8	1.3	Antenna Requirement	Pass
15.207(a)	RSS-GEN 8.8	4.1	AC Conducted Emission	Pass
15.247(a)(2)	RSS-247(5.2)(a)	4.2	6 dB Bandwidth	Pass
-	RSS-GEN 6.7	4.2	Occupied Bandwidth (99%)	Pass
15.247(b)(3)	RSS-247(5.4)(d)	4.3	Output Power Measurement	Pass
15.247(e)	RSS-247(5.2)(b)	4.4	Power Spectral Density	Pass
15.247(d)	RSS-247(5.5)	4.5	Conducted Band Edge	Pass
15.247(d)	RSS-247(5.5)	4.5	Conducted Spurious Emission	Pass
15.247(d)	RSS-GEN 8.9, 8.10	4.6	Radiation Band Edge	Pass
15.247(d)	RSS-GEN 8.9, 8.10	4.6	Radiation Spurious Emission	Pass

Report No.: TMWK2109000572KR

3. DESCRIPTION OF TEST MODES

3.1 THE WORST MODE OF OPERATING CONDITION

Operation mode	BLE Mode (1Mbps) BLE Mode (2Mbps)
Test Channel Frequencies	1.Lowest Channel : 2402MHz 2.Middle Channel : 2442MHz 3.Highest Channel : 2480MHz

Remark:

1. EUT pre-scanned data rate of output power for each mode, the worst data rate were recorded in this report.

Report No.: TMWK2109000572KR

3.2 THE WORST MODE OF MEASUREMENT

AC Power Line Conducted Emission	
Test Condition	AC Power line conducted emission for line and neutral
Power supply Mode	Mode 1: EUT power by Host System
Worst Mode	<input checked="" type="checkbox"/> Mode 1 <input type="checkbox"/> Mode 2 <input type="checkbox"/> Mode 3 <input type="checkbox"/> Mode 4

Radiated Emission Measurement Above 1G	
Test Condition	Radiated Emission Above 1G
Power supply Mode	Mode 1: EUT power by Host System
Worst Mode	<input checked="" type="checkbox"/> Mode 1 <input type="checkbox"/> Mode 2 <input type="checkbox"/> Mode 3 <input type="checkbox"/> Mode 4
Worst Position	<input type="checkbox"/> Placed in fixed position. <input checked="" type="checkbox"/> Placed in fixed position at X-Plane (E2-Plane) <input type="checkbox"/> Placed in fixed position at Y-Plane (E1-Plane) <input type="checkbox"/> Placed in fixed position at Z-Plane (H-Plane)

Radiated Emission Measurement Below 1G	
Test Condition	Radiated Emission Below 1G
Power supply Mode	Mode 1: EUT power by Host System
Worst Mode	<input checked="" type="checkbox"/> Mode 1 <input type="checkbox"/> Mode 2 <input type="checkbox"/> Mode 3 <input type="checkbox"/> Mode 4

Remark:

1. The worst mode was record in this test report.
2. EUT pre-scanned in three axis ,X,Y, Z and two polarity, for radiated measurement. The worst case(X-Plane) were recorded in this report
3. AC power line conducted emission and for below 1G radiation emission were performed the EUT transmit at the highest output power channel as worse case.

Report No.: TMWK2109000572KR

3.3 EUT DUTY CYCLE

Temperature: 23.6°C

Humidity: 58% RH

Tested by: Lance Chen

Test date: September 28, 2021

Duty Cycle				
Configuration	Duty Cycle (%)	Duty Factor (dB)	1/T (kHz)	VBW Setting (kHz)
BLE-1Mbps	85.00	0.71	0.47	1.00
BLE-2Mbps	58.00	2.37	0.93	1.00

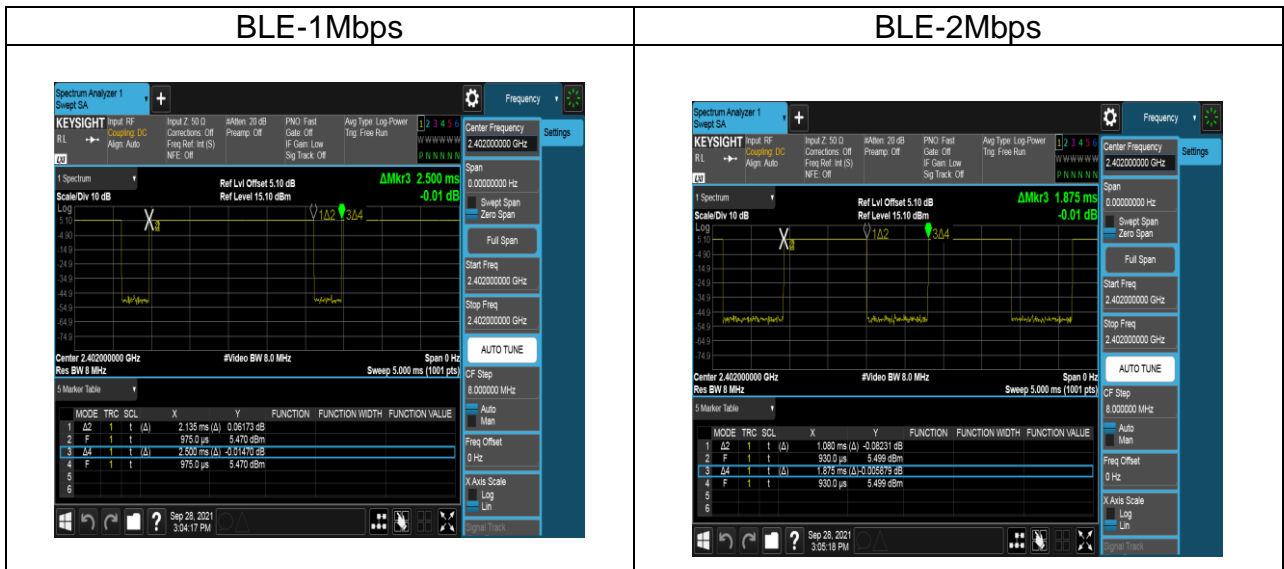

Report No.: TMWK2109000572KR

4. TEST RESULT

4.1 AC POWER LINE CONDUCTED EMISSION

4.1.1 Test Limit

According to §15.207(a) and RSS-GEN section 8.8,

Frequency Range (MHz)	Limits(dBμV)	
	Quasi-peak	Average
0.15 to 0.50	66 to 56*	56 to 46*
0.50 to 5	56	46
5 to 30	60	50

* Decreases with the logarithm of the frequency.

4.1.2 Test Procedure

Test method Refer as ANSI C63.10: 2013 clause 6.2,

1. The EUT was placed above horizontal ground plane and 0.4m above vertical ground plane
2. EUT connected to the line impedance stabilization network (LISN)
3. Receiver set RBW of 9kHz and Detector Peak, and note as quasi-peak and average.
4. Maximum procedure was performed on the six highest emissions to ensure EUT compliance.
5. Recorded Line for Neutral and Line.

4.1.3 Test Setup

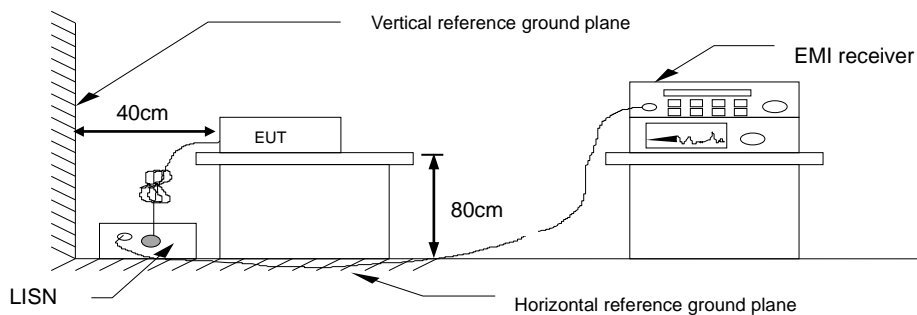

4.1.4 Test Result

PASS

Report No.: TMWK2109000572KR

Test Data

Test Mode:	Mode 1	Temp/Hum	24.6(°C)/ 51%RH
Phase:	Line	Test Date	September 28, 2021
Configuration	BLE-1Mbps	Test Engineer	Jack Chen

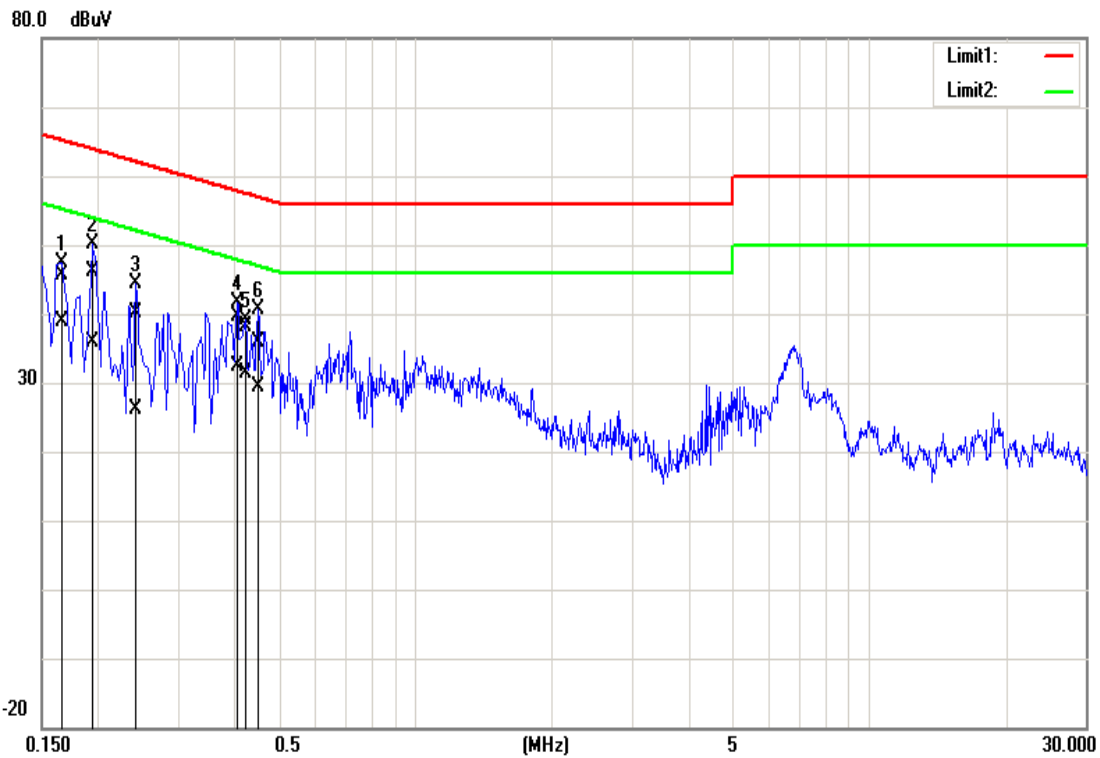

Frequency (MHz)	Quasi Peak reading (dBuV)	Average reading (dBuV)	Correction factor (dB)	Quasi Peak result (dBuV)	Average result (dBuV)	Quasi Peak limit (dBuV)	Average limit (dBuV)	Quasi Peak margin (dB)	Average margin (dB)	Remark
0.1660	35.36	28.66	10.29	45.65	38.95	65.16	55.16	-19.51	-16.21	Pass
0.1940	35.90	25.64	10.29	46.19	35.93	63.86	53.86	-17.67	-17.93	Pass
0.2420	29.94	15.85	10.29	40.23	26.14	62.03	52.03	-21.80	-25.89	Pass
0.4060	29.24	22.03	10.29	39.53	32.32	57.73	47.73	-18.20	-15.41	Pass
0.4220	27.93	21.05	10.29	38.22	31.34	57.41	47.41	-19.19	-16.07	Pass
0.4500	25.58	19.00	10.29	35.87	29.29	56.88	46.88	-21.01	-17.59	Pass

Note: Correction factor = LISN loss + Cable loss.

Report No.: TMWK2109000572KR

Test Mode:	Mode 1	Temp/Hum	24.6(°C)/ 51%RH
Phase:	Neutral	Test Date	September 28, 2021
Configuration	BLE-1Mbps	Test Engineer	Jack Chen

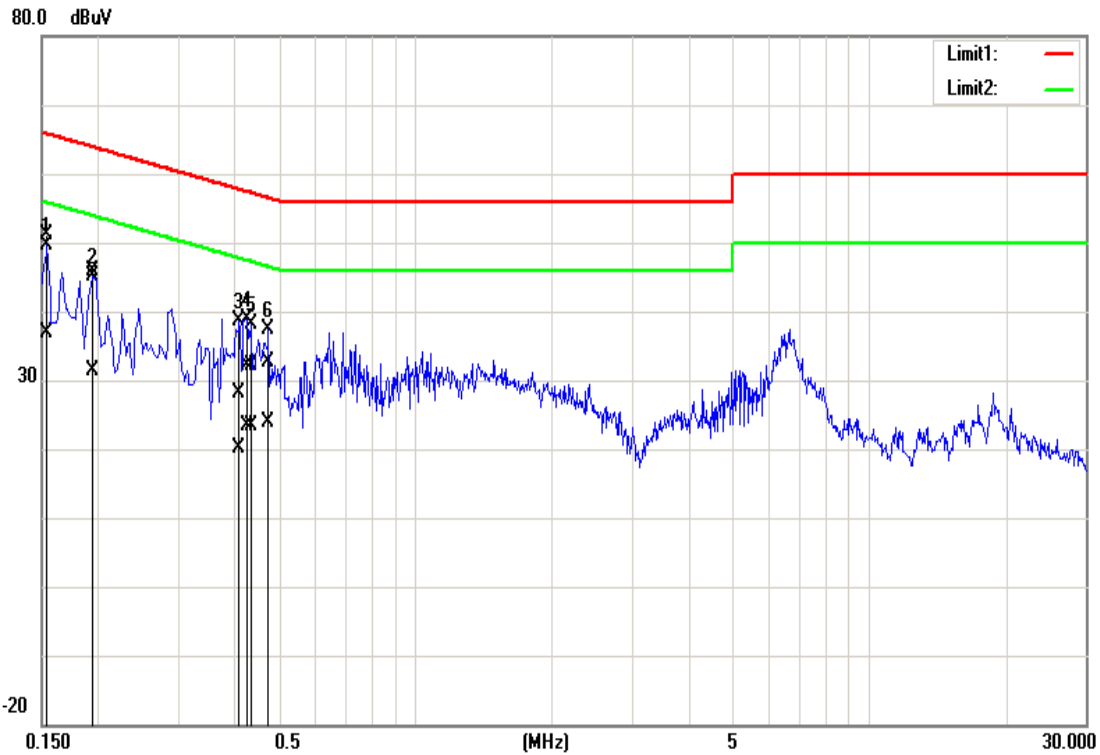

Frequency (MHz)	Quasi Peak reading (dBuV)	Average reading (dBuV)	Correction factor (dB)	Quasi Peak result (dBuV)	Average result (dBuV)	Quasi Peak limit (dBuV)	Average limit (dBuV)	Quasi Peak margin (dB)	Average margin (dB)	Remark
0.1540	40.93	26.69	10.29	51.22	36.98	65.78	55.78	-14.56	-18.80	Pass
0.1940	35.49	21.16	10.29	45.78	31.45	63.86	53.86	-18.08	-22.41	Pass
0.4100	17.96	9.86	10.29	28.25	20.15	57.65	47.65	-29.40	-27.50	Pass
0.4260	21.72	13.18	10.29	32.01	23.47	57.33	47.33	-25.32	-23.86	Pass
0.4340	21.82	13.17	10.29	32.11	23.46	57.18	47.18	-25.07	-23.72	Pass
0.4740	22.25	13.52	10.29	32.54	23.81	56.44	46.44	-23.90	-22.63	Pass

Note: Correction factor = LISN loss + Cable loss.

Report No.: TMWK2109000572KR

Test Mode:	Mode 1	Temp/Hum	24.6(°C)/ 51%RH
Phase:	Line	Test Date	September 28, 2021
Configuration	BLE-2Mbps	Test Engineer	Jack Chen

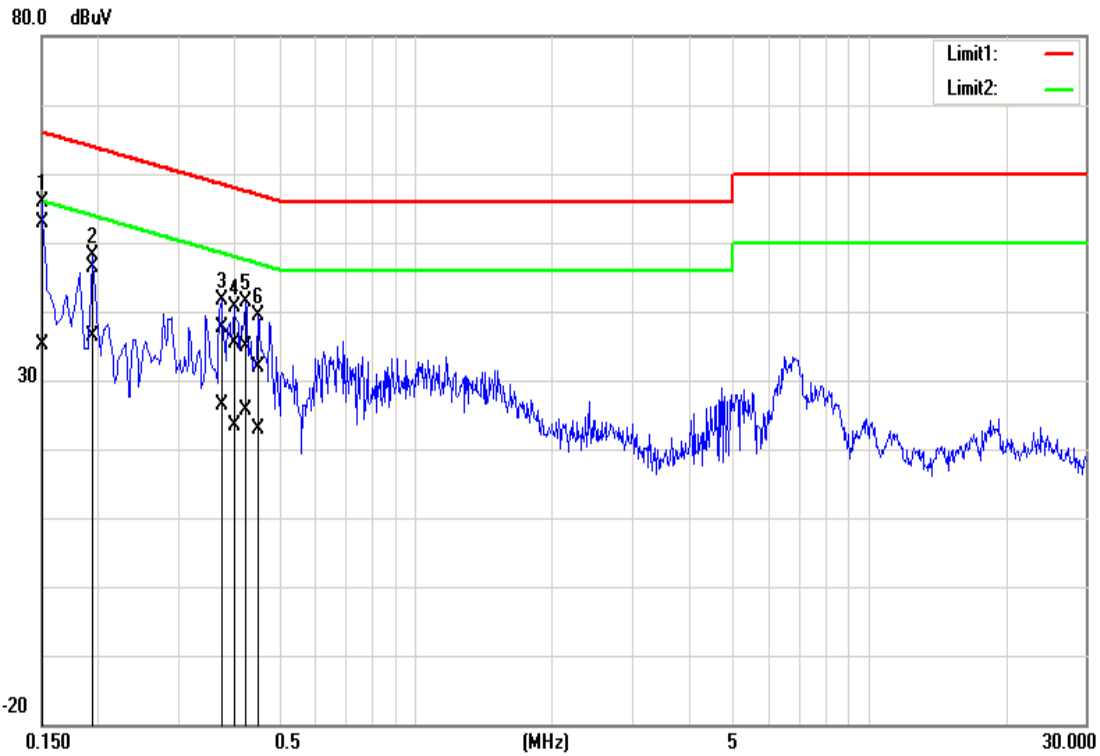

Frequency (MHz)	Quasi Peak reading (dBuV)	Average reading (dBuV)	Correction factor (dB)	Quasi Peak result (dBuV)	Average result (dBuV)	Quasi Peak limit (dBuV)	Average limit (dBuV)	Quasi Peak margin (dB)	Average margin (dB)	Remark
0.1500	42.59	24.72	10.29	52.88	35.01	66.00	56.00	-13.12	-20.99	Pass
0.1940	36.13	26.04	10.29	46.42	36.33	63.86	53.86	-17.44	-17.53	Pass
0.3740	27.30	16.04	10.29	37.59	26.33	58.41	48.41	-20.82	-22.08	Pass
0.3980	25.18	12.98	10.29	35.47	23.27	57.90	47.90	-22.43	-24.63	Pass
0.4220	24.69	15.28	10.29	34.98	25.57	57.41	47.41	-22.43	-21.84	Pass
0.4500	21.59	12.56	10.29	31.88	22.85	56.88	46.88	-25.00	-24.03	Pass

Note: Correction factor = LISN loss + Cable loss.

Report No.: TMWK2109000572KR

Test Mode:	Mode 1	Temp/Hum	24.6(°C)/ 51%RH
Phase:	Neutral	Test Date	September 28, 2021
Configuration	BLE-2Mbps	Test Engineer	Jack Chen

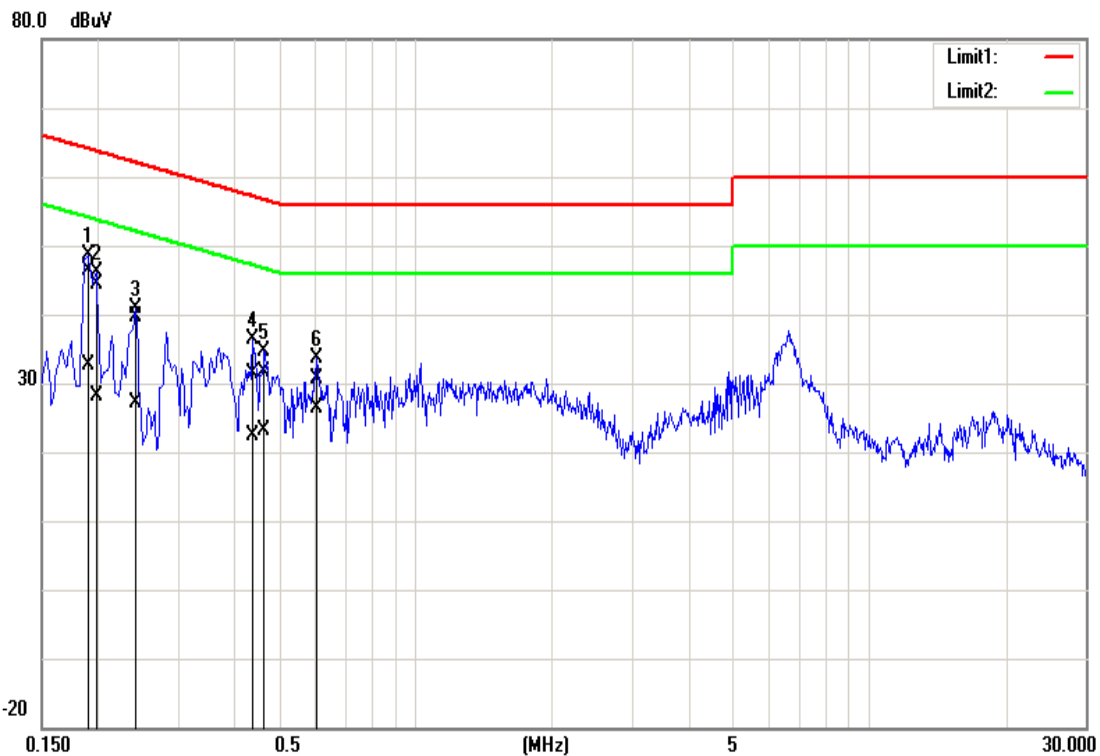

Frequency (MHz)	Quasi Peak reading (dBuV)	Average reading (dBuV)	Correction factor (dB)	Quasi Peak result (dBuV)	Average result (dBuV)	Quasi Peak limit (dBuV)	Average limit (dBuV)	Quasi Peak margin (dB)	Average margin (dB)	Remark
0.1900	36.11	22.33	10.29	46.40	32.62	64.04	54.04	-17.64	-21.42	Pass
0.1980	34.00	17.88	10.29	44.29	28.17	63.69	53.69	-19.40	-25.52	Pass
0.2420	29.45	16.74	10.29	39.74	27.03	62.03	52.03	-22.29	-25.00	Pass
0.4380	21.05	12.21	10.29	31.34	22.50	57.10	47.10	-25.76	-24.60	Pass
0.4660	21.28	12.89	10.29	31.57	23.18	56.58	46.58	-25.01	-23.40	Pass
0.6060	20.26	16.02	10.29	30.55	26.31	56.00	46.00	-25.45	-19.69	Pass

Note: Correction factor = LISN loss + Cable loss.

Report No.: TMWK2109000572KR

4.2 6dB BANDWIDTH AND OCCUPIED BANDWIDTH (99%)

4.2.1 Test Limit

According to §15.247(a)(2) and RSS-247 section 5.2(a)

6 dB Bandwidth :

Limit	Shall be at least 500kHz
-------	--------------------------

Occupied Bandwidth(99%) : For reporting purposes only.

4.2.2 Test Procedure

Test method Refer as ANSI C63.10: 2013,

1. The EUT RF output connected to the spectrum analyzer by RF cable.
2. Setting maximum power transmit of EUT.
3. SA set RBW =100KHz, VBW = 300KHz and Detector = Peak, to measurement 6dB Bandwidth.
4. SA set RBW = 1% ~ 5% OBW, VBW = three times the RBW and Detector = Peak, to measurement 99% Bandwidth.
5. Measure and record the result of 6 dB Bandwidth and 99% Bandwidth. in the test report.

4.2.3 Test Setup

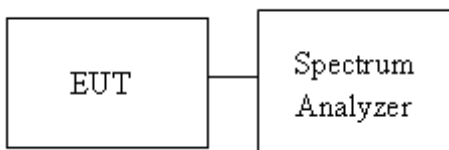

Report No.: TMWK2109000572KR

4.2.4 Test Result

Temperature: 23.6°C

Humidity: 58% RH

Tested by: Lance Chen

Test date: September 28, 2021

Test mode: BLE-1Mbps mode / 2402-2480 MHz				
Channel	Frequency (MHz)	OBW (99%) (MHz)	6dB BW (MHz)	6dB limit (kHz)
Low	2402	1.0174	0.6792	≥500
Mid	2442	1.0232	0.6832	
High	2480	1.0225	0.6903	

Test mode: BLE-2Mbps mode / 2402-2480 MHz				
Channel	Frequency (MHz)	OBW (99%) (MHz)	6dB BW (MHz)	6dB limit (kHz)
Low	2402	2.0445	1.154	≥500
Mid	2442	2.0387	1.149	
High	2480	2.0569	1.261	

Report No.: TMWK2109000572KR

Test Data

6dB BANDWIDTH

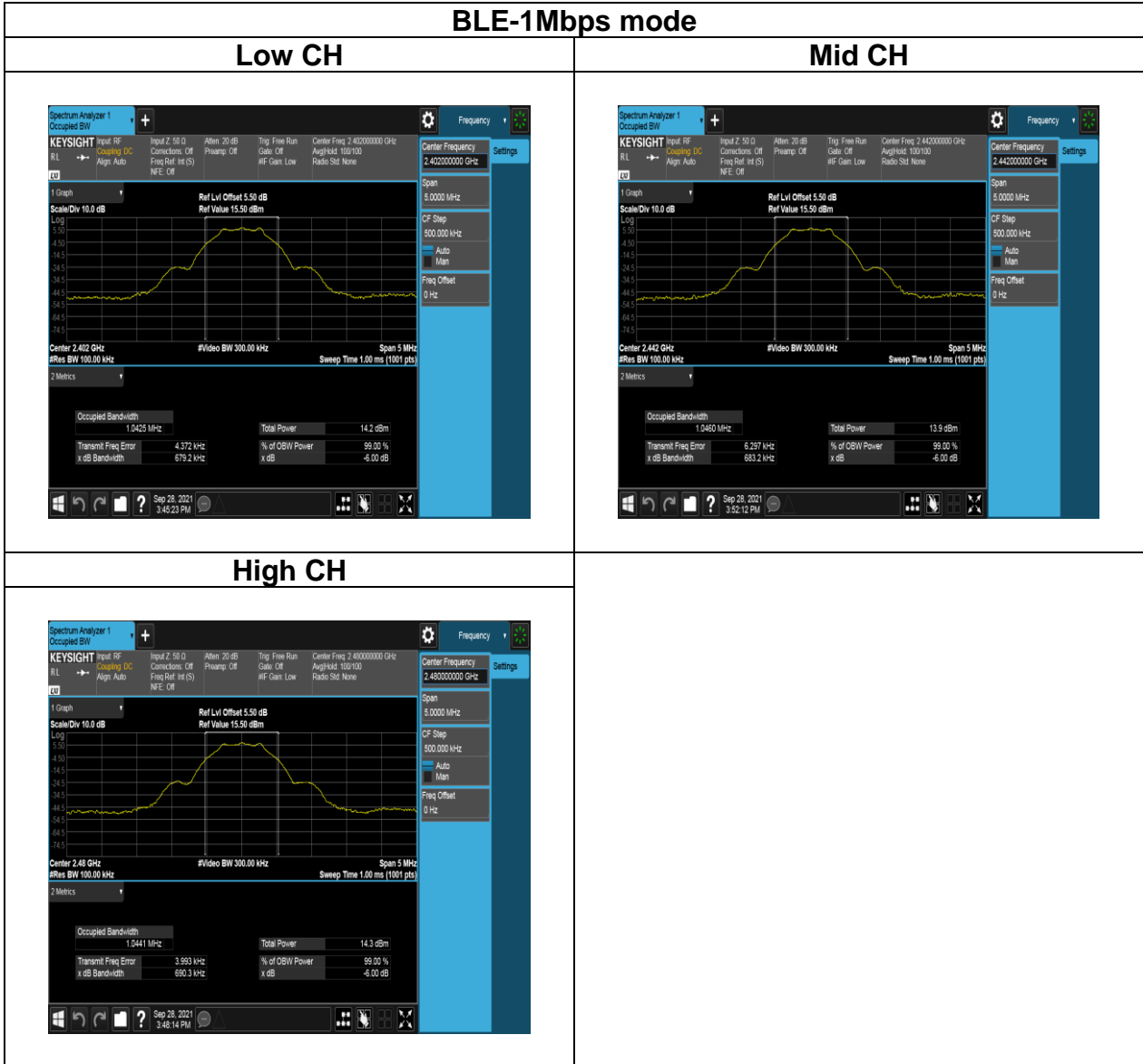

Report No.: TMWK2109000572KR

BLE-2Mbps mode

Low CH

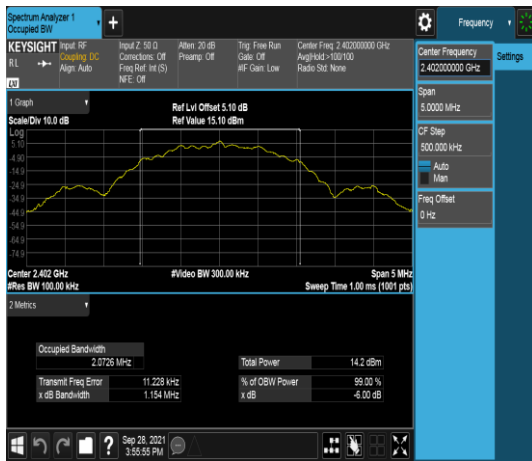

Mid CH

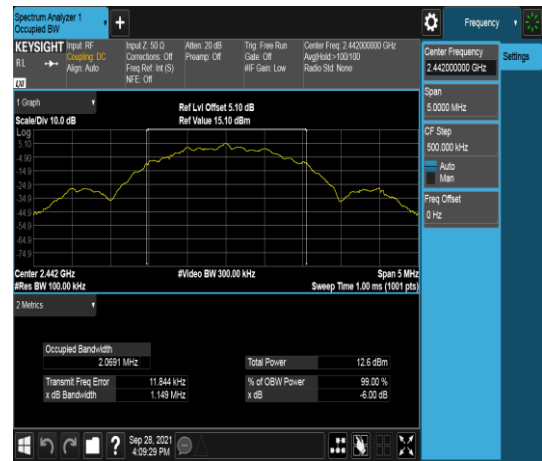

High CH

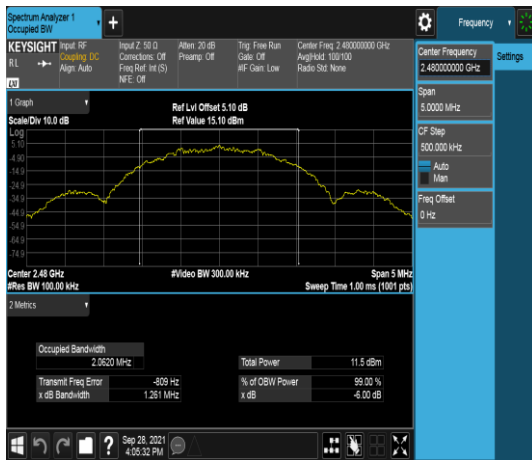

Report No.: TMWK2109000572KR

Test Data

BANDWIDTH (99%)

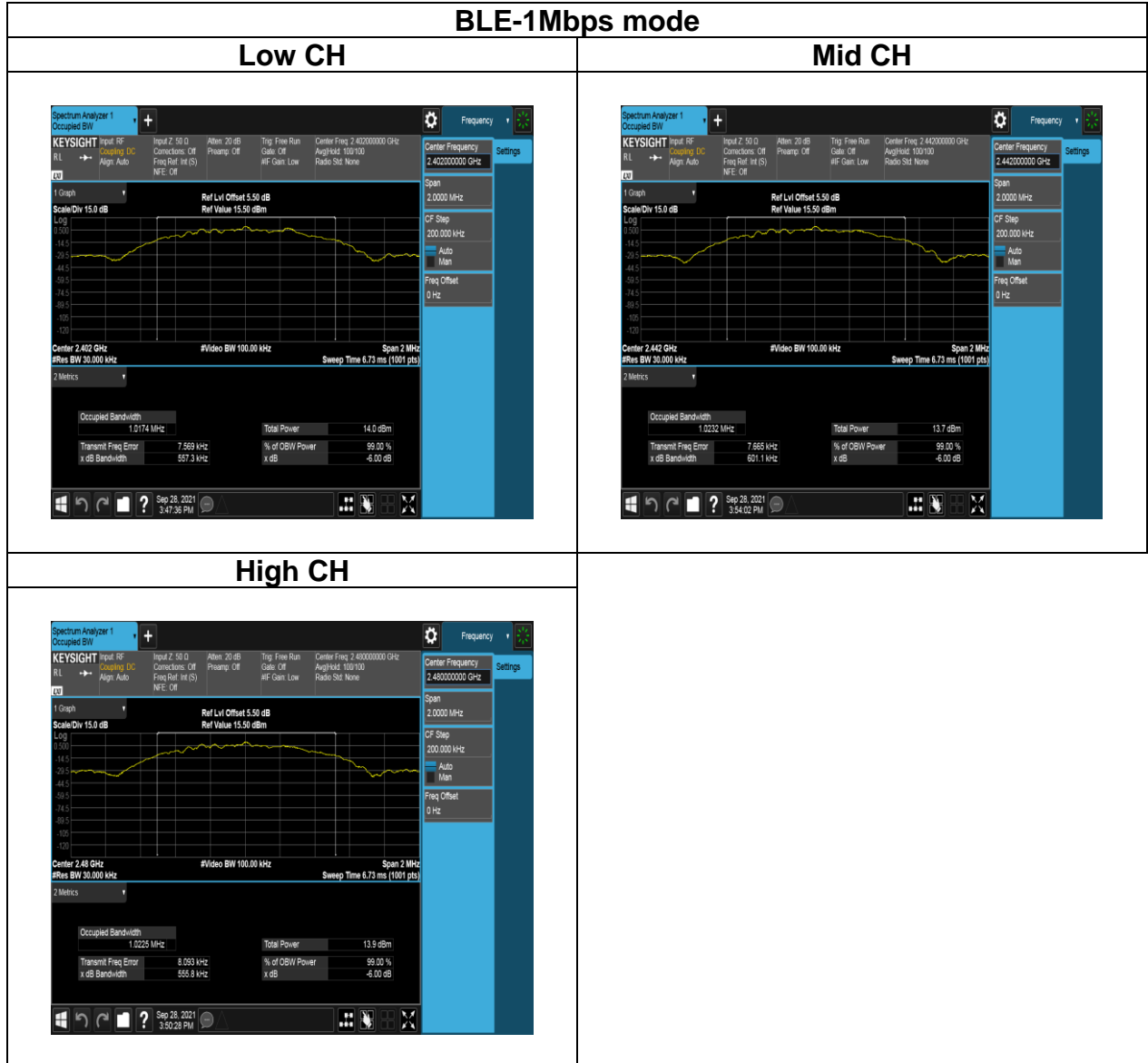

Report No.: TMWK2109000572KR

BLE-2Mbps mode

Low CH

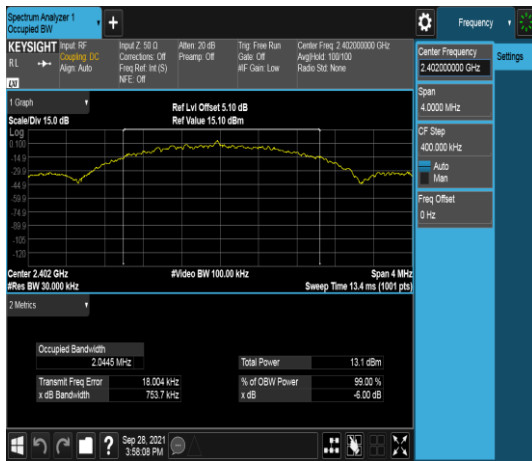

Mid CH

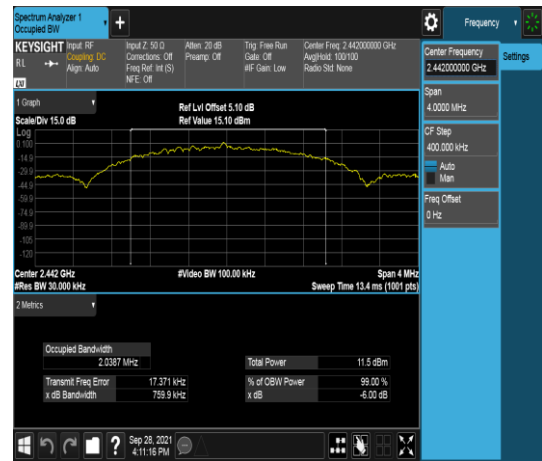

High CH

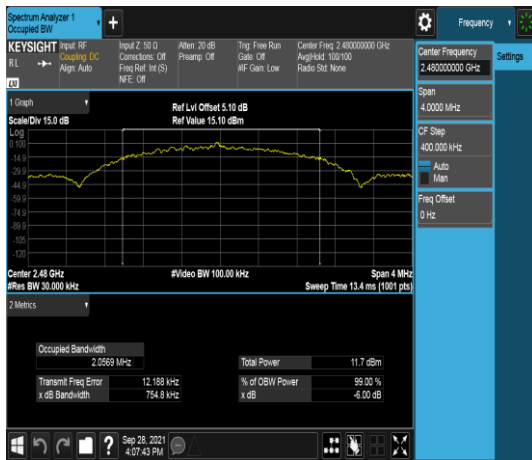

Report No.: TMWK2109000572KR

4.3 OUTPUT POWER MEASUREMENT

4.3.1 Test Limit

According to §15.247(b)(3) and RSS-247 section 5.4(d)

Peak output power :

FCC

For systems using digital modulation in the 902-928 MHz, 2400-2483.5 MHz, and 5725-5850 MHz bands: 1 Watt. As an alternative to a peak power measurement,

IC

For DTSs employing digital modulation techniques operating in the bands 902-928 MHz and 2400-2483.5 MHz, the maximum peak conducted output power shall not exceed 1 W. The e.i.r.p. shall not exceed 4 W, except as provided in section 5.4(e), base on the use of antennas with directional gain not exceed 6 dBi If transmitting antennas of directional gain greater than 6dBi are used the peak output power the conducted output power from the intentional radiator shall be reduced by the amount in dB that the directional gain of the antenna exceeds 6 dBi. In case of point-to-point operation, the limit has to be reduced by 1dB for every 3 dB that the directional gain of the antenna exceeds 6 dBi.

Limit	<input checked="" type="checkbox"/> Antenna not exceed 6 dBi : 30dBm <input type="checkbox"/> Antenna with DG greater than 6 dBi [Limit = 30 – (DG – 6)] <input type="checkbox"/> Point-to-point operation
-------	---

Average output power : For reporting purposes only.

Report No.: TMWK2109000572KR

4.3.2 Test Procedure

Test method Refer as ANSI C63.10:2013.

1. The EUT RF output connected to the power meter by RF cable.
2. Setting maximum power transmit of EUT.
3. The path loss was compensated to the results for each measurement.
4. Measure and record the result of Peak output power and Average output power. in the test report.

4.3.3 Test Setup

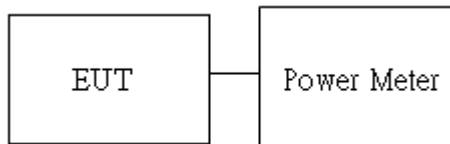

Report No.: TMWK2109000572KR

4.3.4 Test Result

Temperature: 23.6°C

Humidity: 58% RH

Tested by: Lance Chen

Test date: September 28, 2021

Peak output power :

BLE 1M mode:

CH	Frequency (MHz)	Power set	Peak Power Output (dBm)	Required Limit (dBm)
Low	2402	default	6.50	30
Mid	2442	default	6.25	30
High	2480	default	6.62	30

BLE 2M mode:

CH	Frequency (MHz)	Power set	Peak Power Output (dBm)	Required Limit (dBm)
Low	2402	default	6.13	30
Mid	2442	default	6.25	30
High	2480	default	6.61	30

Average output power :

BLE 1M mode:

CH	Frequency (MHz)	Power set	Max. Avg. Output include tune up tolerance Power (dBm)	Required Limit (dBm)
Low	2402	default	6.02	30
Mid	2442	default	6.00	30
High	2480	default	6.34	30

BLE 2M mode:

CH	Frequency (MHz)	Power set	Max. Avg. Output include tune up tolerance Power (dBm)	Required Limit (dBm)
Low	2402	default	6.11	30
Mid	2442	default	6.24	30
High	2480	default	6.59	30

Report No.: TMWK2109000572KR

EIRP power :
EIRP BLE 1M mode

CH	Frequency (MHz)	Power set	Max. Avg. Output include tune up tolerance Power (dBm)	Antenna Gain (dBi)	EIRP (dBm)	Limit
Low	2402	default	6.02	2.93	8.95	4W= 36 dBm
Mid	2442	default	6.00	2.93	8.93	4W= 36 dBm
High	2480	default	6.34	2.93	9.27	4W= 36 dBm

EIRP BLE 2M mode

CH	Frequency (MHz)	Power set	Max. Avg. Output include tune up tolerance Power (dBm)	Antenna Gain (dBi)	EIRP (dBm)	Limit
Low	2402	default	6.11	2.93	9.04	4W= 36 dBm
Mid	2442	default	6.24	2.93	9.17	4W= 36 dBm
High	2480	default	6.59	2.93	9.52	4W= 36 dBm

Report No.: TMWK2109000572KR

4.4 POWER SPECTRAL DENSITY

4.4.1 Test Limit

According to §15.247(e) and RSS-247 section 5.2(b)

For digitally modulated systems, the power spectral density conducted from the intentional radiator to the antenna shall not be greater than 8 dBm in any 3 kHz band during any time interval of continuous transmission.

Limit	<input checked="" type="checkbox"/> Antenna not exceed 6 dBi : 8dBm <input type="checkbox"/> Antenna with DG greater than 6 dBi [Limit = 8 – (DG – 6)] <input type="checkbox"/> Point-to-point operation :
-------	---

4.4.2 Test Procedure

Test method Refer as ANSI C63.10:2013.

1. The EUT RF output connected to the spectrum analyzer by RF cable.
2. Setting maximum power transmit of EUT
3. SA set RBW = 3kHz, VBW = 10kHz, Span = 1.5 times DTS Bandwidth (6 dB BW), Detector = Peak, Sweep Time = Auto and Trace = Max hold.
4. The path loss and Duty Factor were compensated to the results for each measurement by SA.
5. Mark the maximum level.
6. Measure and record the result of power spectral density. in the test report.

4.4.3 Test Setup



Report No.: TMWK2109000572KR

4.4.4 Test Result

Temperature: 23.6°C

Humidity: 58% RH

Tested by: Lance Chen

Test date: September 28, 2021

BLE 1M mode

Frequency (MHz)	RF Power Density (dBm/3kHz)	Maximum Limit (dBm/3kHz)	Result
2402	-8.890	8	PASS
2442	-9.090	8	PASS
2480	-8.590	8	PASS

BLE 2M mode

Frequency (MHz)	RF Power Density (dBm/3kHz)	Maximum Limit (dBm/3kHz)	Result
2402	-9.990	8	PASS
2442	-12.450	8	PASS
2480	-11.360	8	PASS

Report No.: TMWK2109000572KR

Test Data

BLE-1Mbps mode

Low CH

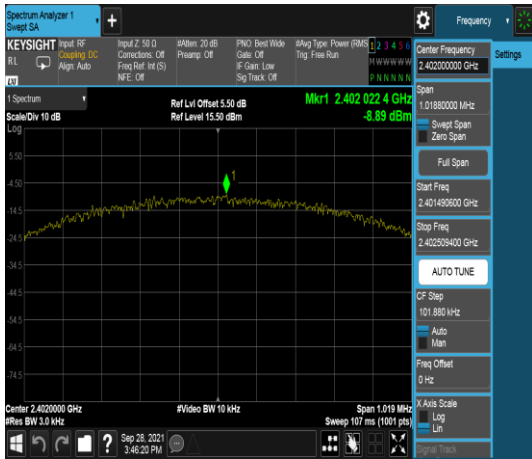

Mid CH

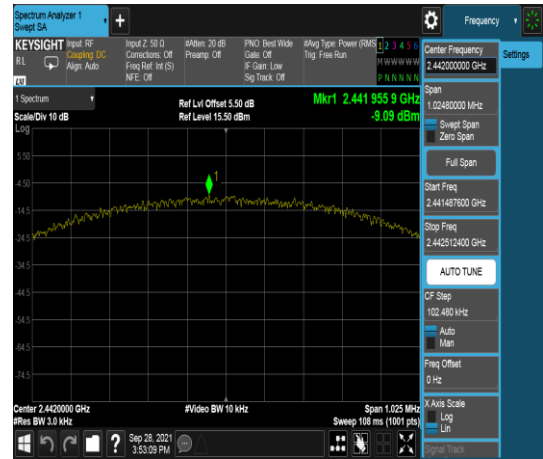

High CH

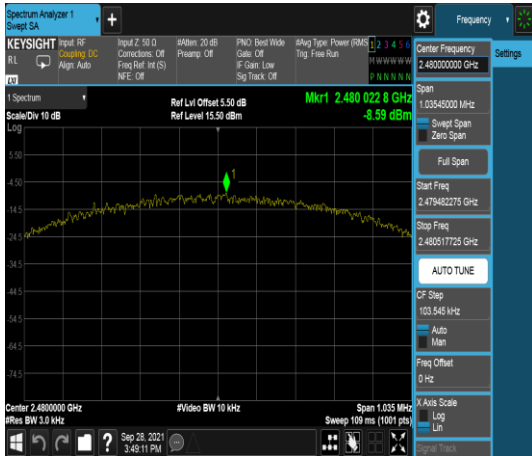

Report No.: TMWK2109000572KR

BLE-2Mbps mode

Low CH

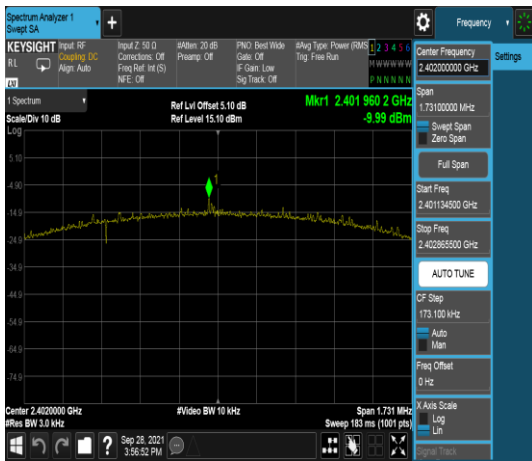

Mid CH

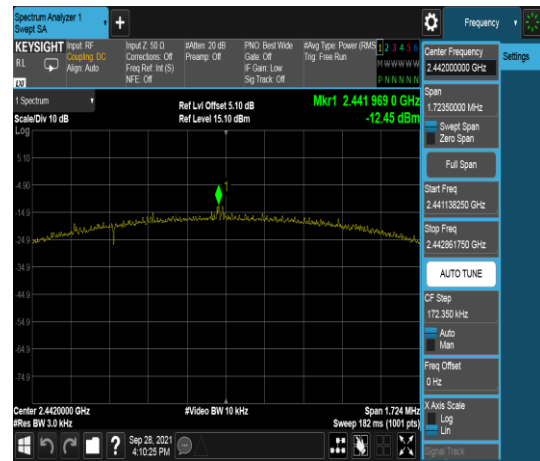

High CH

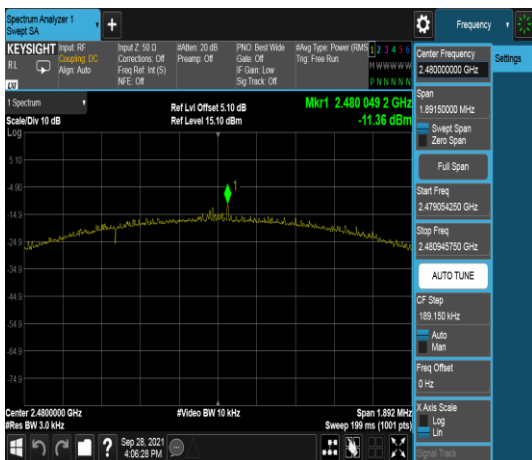

Report No.: TMWK2109000572KR

4.5 CONDUCTED BAND EDGE AND SPURIOUS EMISSION

4.5.1 Test Limit

According to §15.247(d) and RSS-247 section 5.5

FCC: In any 100 kHz bandwidth outside the authorized frequency band,

Non-restricted bands shall be attenuated at least 20 dB/30 dB relative to the maximum PSD level in 100 kHz by RF conducted or a radiated measurement which fall in the restricted bands, as defined in §15.205(a), must also comply with the radiated emission limits specified in §15.209(a).

IC: In any 100 kHz bandwidth outside the frequency band in which the spread spectrum or digitally modulated device is operating, the RF power that is produced shall be at least 20 dB below that in the 100 kHz bandwidth within the band that contains the highest level of the desired power, based on either an RF conducted or a radiated measurement, provided that the transmitter demonstrates compliance with the peak conducted power limits. If the transmitter complies with the conducted power limits based on the use of root-mean-square averaging over a time interval, as permitted under section 5.4(d), the attenuation required shall be 30 dB instead of 20 dB. Attenuation below the general field strength limits specified in RSS-Gen is not required.

4.5.2 Test Procedure

Test method Refer as ANSI C63.10:2013.

1. EUT RF output port connected to the SA by RF cable, and the path loss was compensated to result.
2. SA setting, RBW=100kHz, VBW=300kHz, Detector=Peak, Trace mode = max hold, SWT = Auto.
3. In any 100 kHz bandwidth outside the authorized frequency band, shall be attenuated at least 20 dB relative to the maximum in-band peak PSD level in 100 kHz when conducted power procedure is used. If the transmitter complies with the conducted power limits based on the use of RMS averaging over a time interval, the attenuation required under this paragraph shall be 30 dB instead of 20 dB.

4.5.3 Test Setup

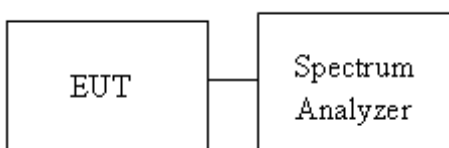

Report No.: TMWK2109000572KR

4.5.4 Test Result

Test Data

Temperature: 23.6°C

Humidity: 58% RH

Tested by: Lance Chen

Test date: September 28, 2021

BLE-1Mbps mode Low CH

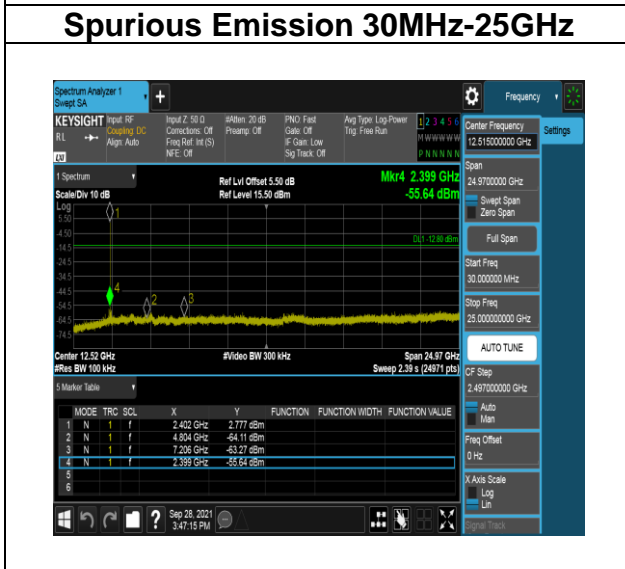
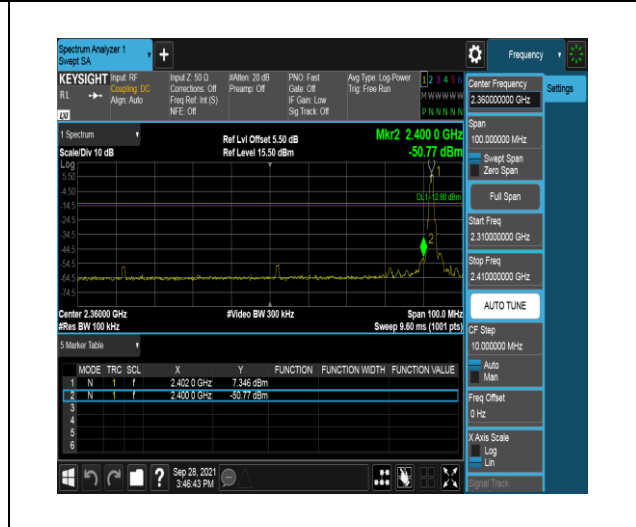
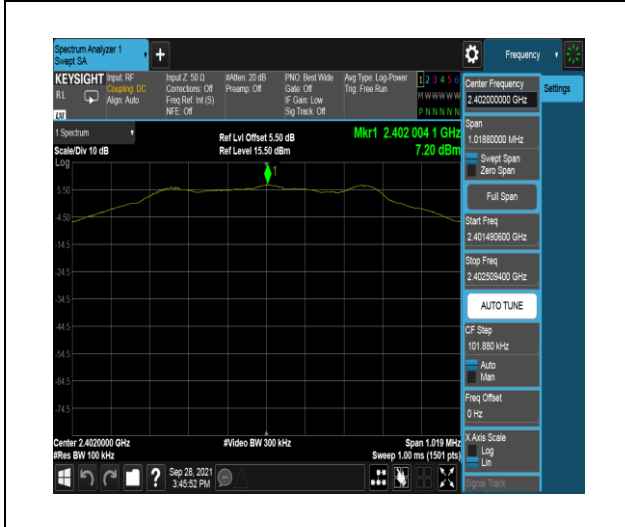

Report No.: TMWK2109000572KR

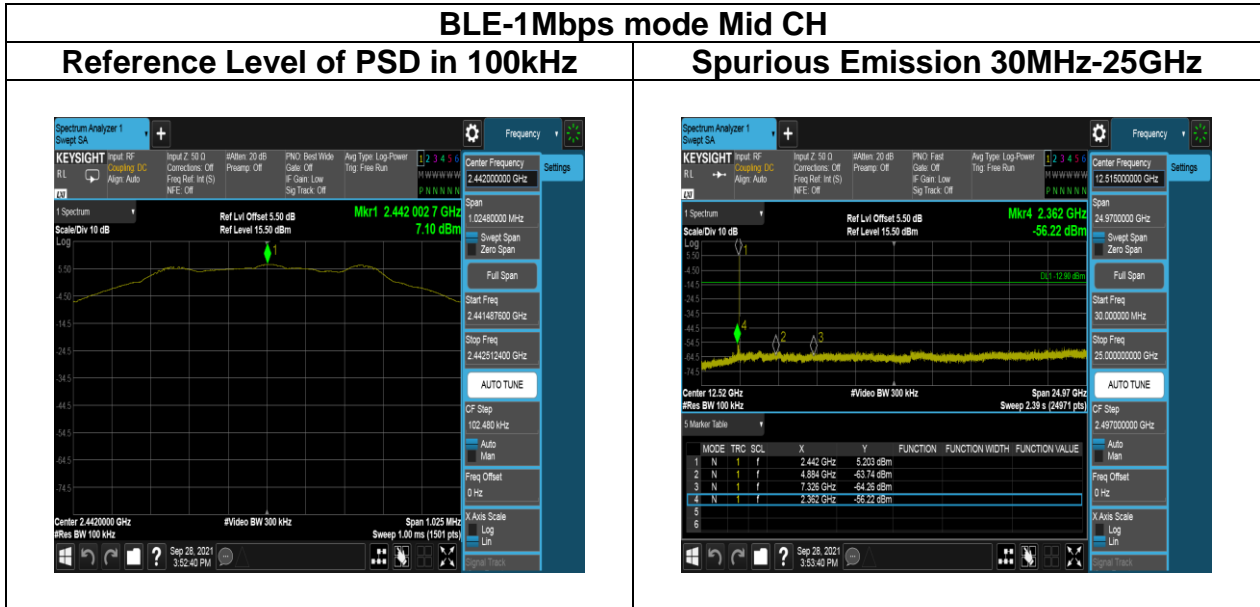

Report No.: TMWK2109000572KR

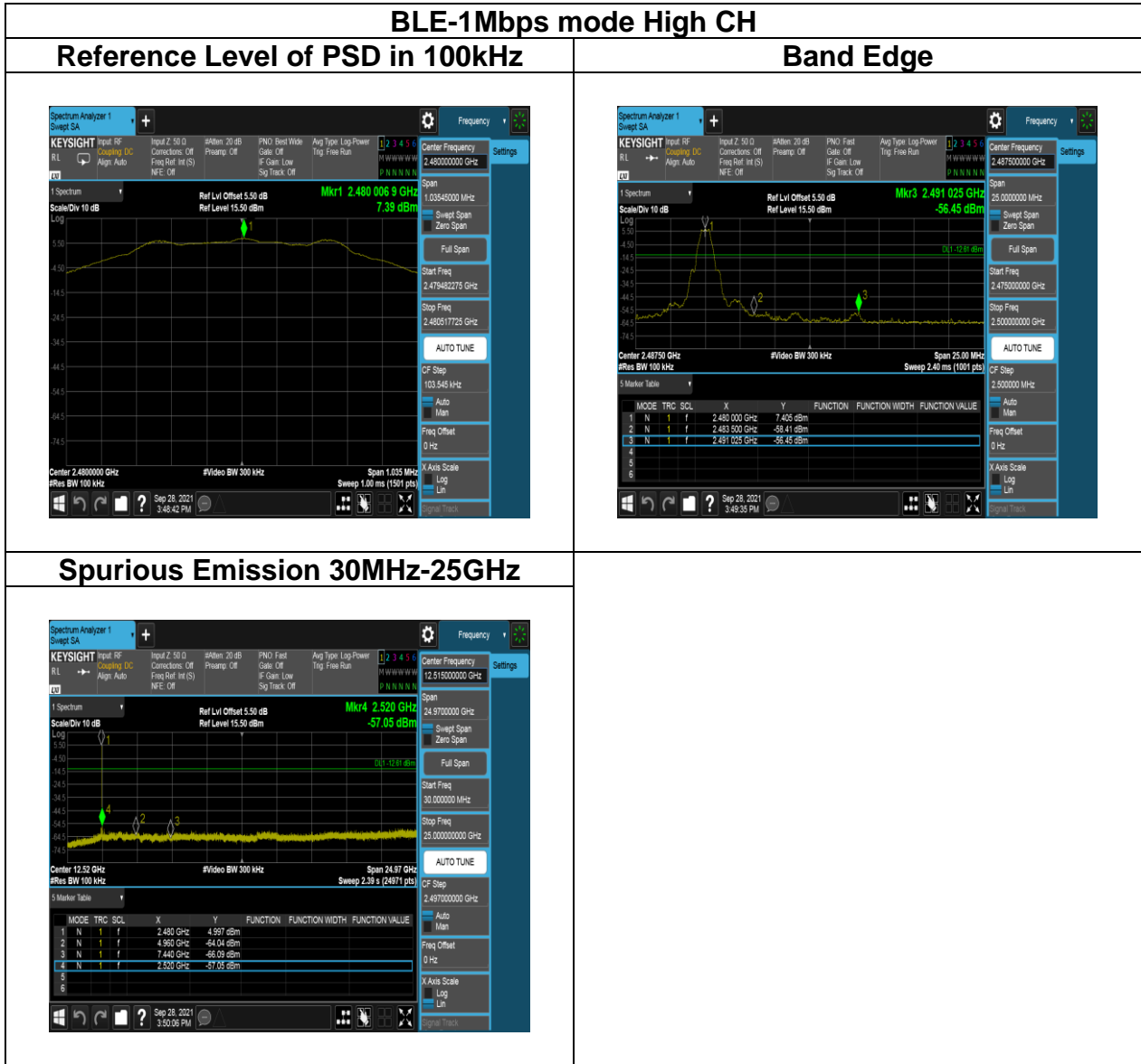

BLE-2Mbps mode Low CH

Reference Level of PSD in 100kHz



Band Edge

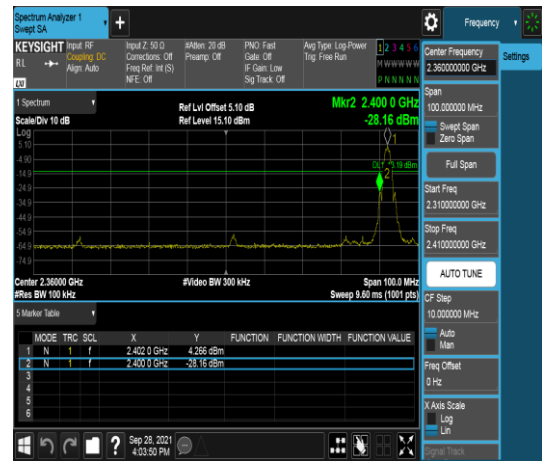

Spurious Emission 30MHz-25GHz

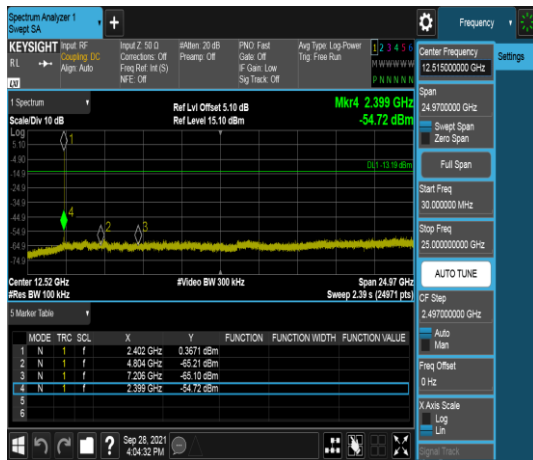

Report No.: TMWK2109000572KR

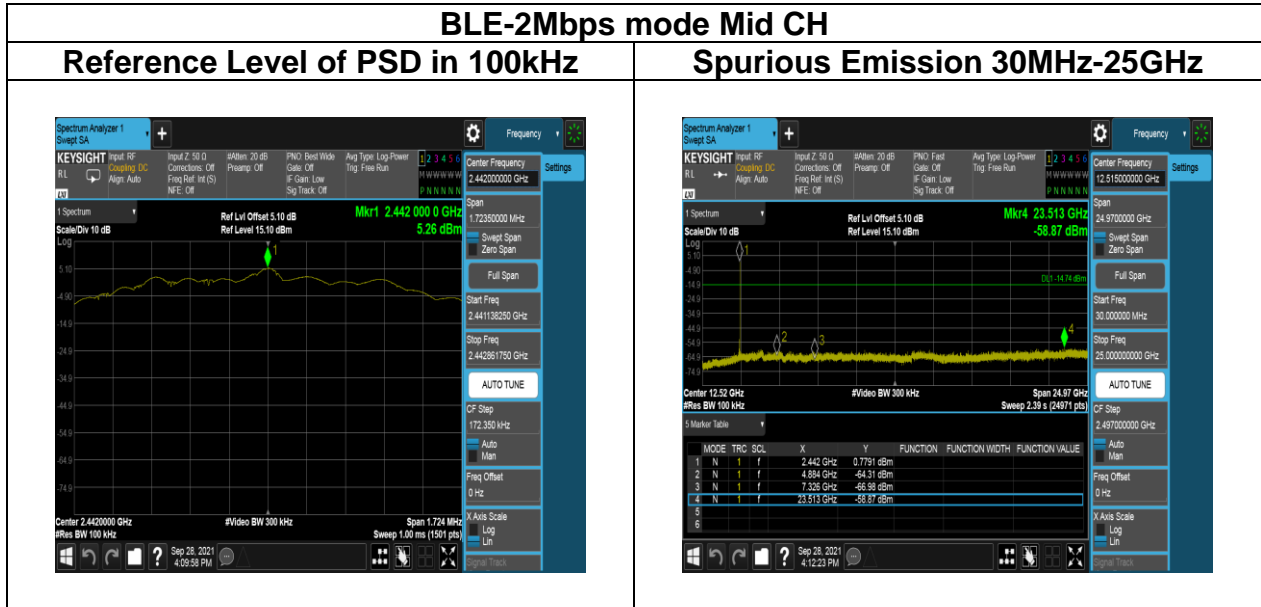

Report No.: TMWK2109000572KR

BLE-2Mbps mode High CH

Reference Level of PSD in 100kHz



Band Edge



Spurious Emission 30MHz-25GHz

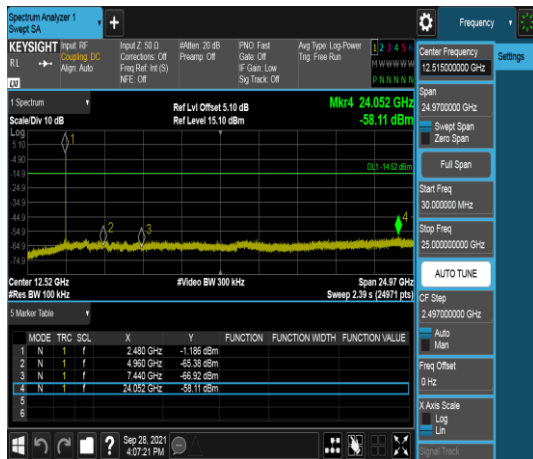

Report No.: TMWK2109000572KR

4.6 RADIATION BANDEGE AND SPURIOUS EMISSION

4.6.1 Test Limit

FCC according to §15.247(d), §15.209 and §15.205,

IC according to RSS-247 section 5.5, RSS-Gen, Section 8.9 and 8.10

In any 100 kHz bandwidth outside the authorized frequency band, all harmonic and spurious must be least 20 dB below the highest emission level with the authorized frequency band. Radiation emission which fall in the restricted bands must also follow the FCC section 15.209 as below limit in table.

Below 30 MHz

Frequency	Field Strength (microvolts/m)	Magnetic H-Field (microamperes/m)	Measurement Distance (metres)
9-490 kHz	2,400/F (F in kHz)	2,400/F (F in kHz)	300
490-1,705 kHz	24,000/F (F in kHz)	24,000/F (F in kHz)	30
1.705-30 MHz	30	N/A	30

Above 30 MHz

Frequency (MHz)	Field Strength microvolts/m at 3 metres (watts, e.i.r.p.)	
	Transmitters	Receivers
30-88	100 (3 nW)	100 (3 nW)
88-216	150 (6.8 nW)	150 (6.8 nW)
216-960	200 (12 nW)	200 (12 nW)
Above 960	500 (75 nW)	500 (75 nW)

Remark:

Although these tests were performed other than open area test site, adequate comparison measurements were confirmed against 30 m open are test site. Therefore sufficient tests were made to demonstrate that the alternative site produces results that correlate with the ones of tests made in an open field based on KDB 414788.

Report No.: TMWK2109000572KR

IC according to RSS-247 section 5.5, RSS-Gen, Section 8.9 and 8.10

RSS-Gen Table 3 and Table 5 – General Field Strength Limits for Transmitters and Receivers at Frequencies Above 30 MHz (Note)

Frequency (MHz)	Field Strength microvolts/m at 3 metres (watts, e.i.r.p.)	
	Transmitters	Receivers
30-88	100 (3 nW)	100 (3 nW)
88-216	150 (6.8 nW)	150 (6.8 nW)
216-960	200 (12 nW)	200 (12 nW)
Above 960	500 (75 nW)	500 (75 nW)

Note: Measurements for compliance with the limits in table 3 may be performed at distances other than 3 metres, in accordance with Section 6.6.

RSS-Gen Table 6: General Field Strength Limits for Transmitters at Frequencies Below 30 MHz (Transmit)

Frequency	Magnetic field strength (H-Field) (µA/m)	Measurement Distance (m)
9-490 kHz ^{Note}	6.37/F (F in kHz)	300
490-1,705 kHz	63.7/F (F in kHz)	30
1.705-30 MHz	0.08	30

Note: The emission limits for the ranges 9-90 kHz and 110-490 kHz are based on measurements employing a linear average detector.

Report No.: TMWK2109000572KR

4.6.2 Test Procedure

Test method Refer as ANSI C63.10:2013.

1. The EUT is placed on a turntable, Above 1 GHz is 1.5m and below 1 GHz is 0.8m above ground plane. The EUT Configured un accordance with ANSI C63.10: 2013, and the EUT set in a continuous mode.
2. The turntable shall be rotated for 360 degrees to determine the position of maximum emission level. And EUT is set 3m away from the receiving antenna, which is scanned from 1m to 4m above the ground plane to find out the highest emissions. Measurement are made polarized in both the vertical and the horizontal positions with antenna.
3. Span shall wide enough to full capture the emission measured. The SA from 9KHz to 26.5GHz set to the low, Mid and High channels with the EUT transmit.

Remark:

1. Although these tests were performed other than open area test site, adequate comparison measurements were confirmed against 30 m open are test site. Therefore sufficient tests were made to demonstrate that the alternative site produces results that correlate with the ones of tests made in an open field based on KDB 414788.
2. No emission found between lowest internal used/generated frequency to 30MHz (9kHz~30MHz).
3. The SA setting following :
 - (1) Below 1G : RBW = 100kHz, VBW \geq 3 RBW, Sweep = Auto, Detector = Peak, Trace = Max hold.
 - (2) Above 1G :
 - (2.1) For Peak measurement : RBW = 1MHz, VBW \geq 3 RBW, Sweep = Auto, Detector = Peak, Trace = Max hold.
 - (2.2) For Average measurement : RBW = 1MHz, VBW
 - If Duty Cycle \geq 98%, VBW=10Hz.
 - If Duty Cycle < 98%, VBW=1/T.

4. Data result

Actual FS=Spectrum Reading Level+Factor

Margin=Actual FS- Limit

Report No.: TMWK2109000572KR

4.6.3 Test Setup

9kHz ~ 30MHz

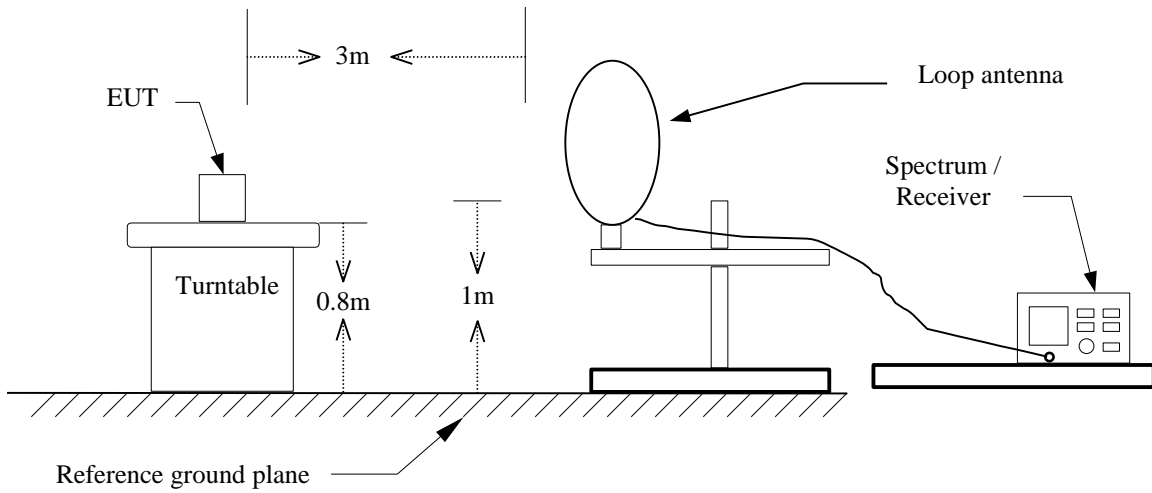

30MHz ~ 1GHz

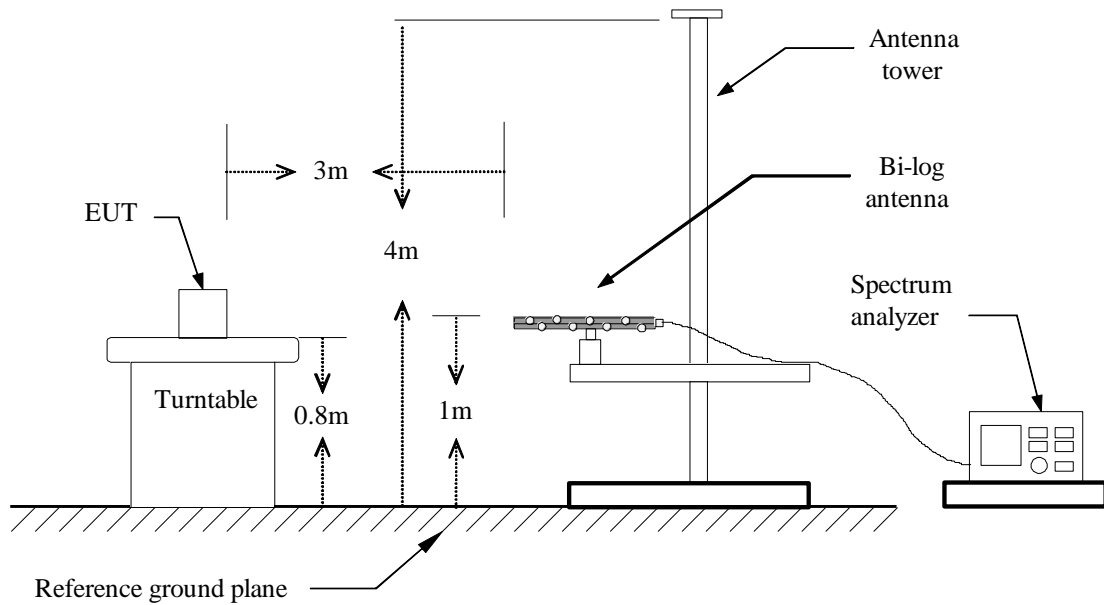

Above 1 GHz

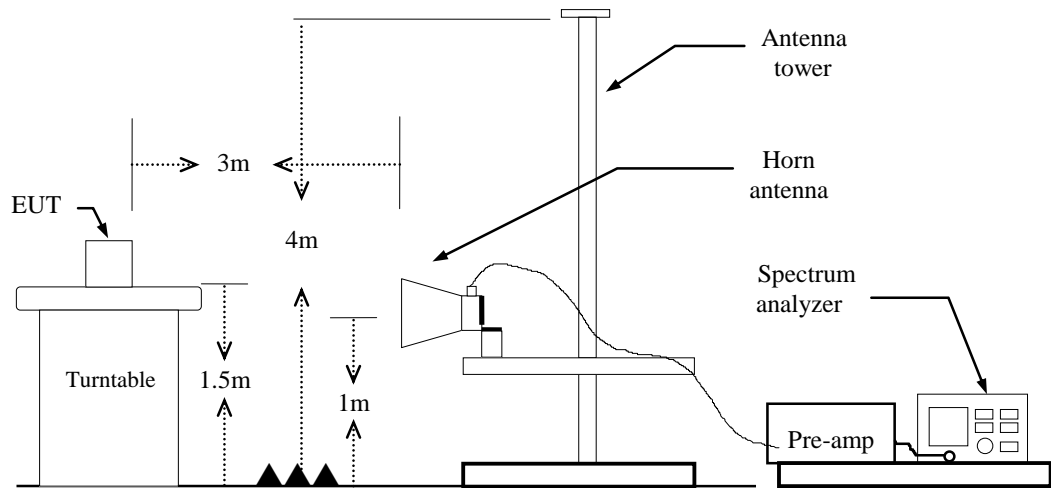

Report No.: TMWK2109000572KR

4.6.4 Test Result

Band Edge Test Data

Test Mode:	BLE-1Mbps Low CH	Temp/Hum	22(°C)/ 50%RH
Test Item	Band Edge	Test Date	October 4, 2021
Polarize	Vertical	Test Engineer	Ray Li
Detector	Peak / Average		

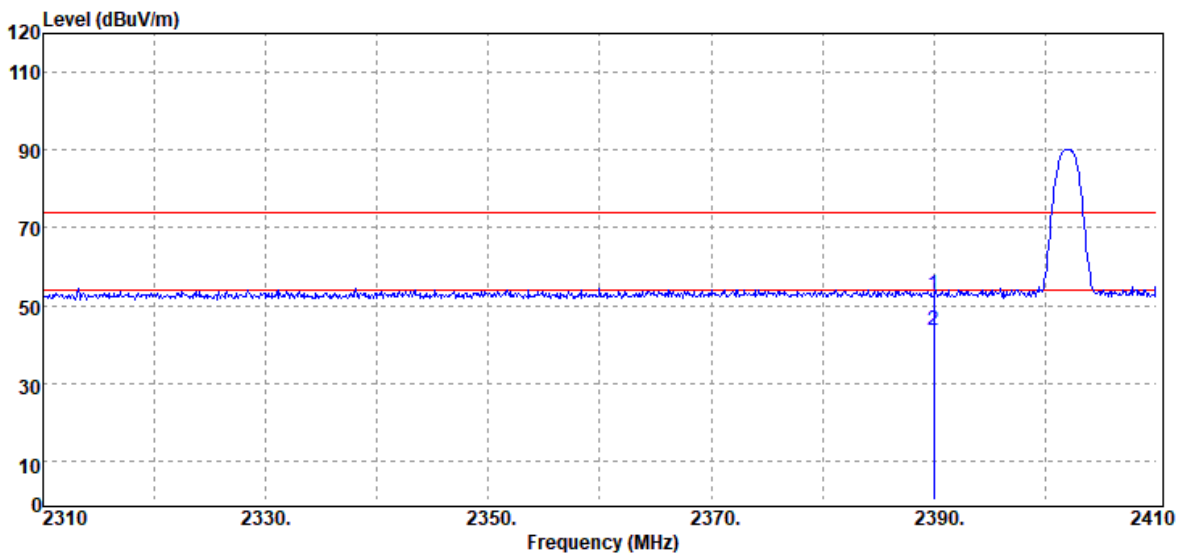

Freq. MHz	Detector Mode PK/QP/AV	Spectrum Reading Level dB μ V	Factor dB	Actual FS dB μ V/m	Limit @3m dB μ V/m	Margin dB
2390.00	Peak	49.11	3.70	52.81	74.00	-21.19
2390.00	Average	39.85	3.70	43.55	54.00	-10.45

Report No.: TMWK2109000572KR

Test Mode:	BLE-1Mbps Low CH	Temp/Hum	22(°C)/ 50%RH
Test Item	Band Edge	Test Date	October 4, 2021
Polarize	Horizontal	Test Engineer	Ray Li
Detector	Peak / Average		

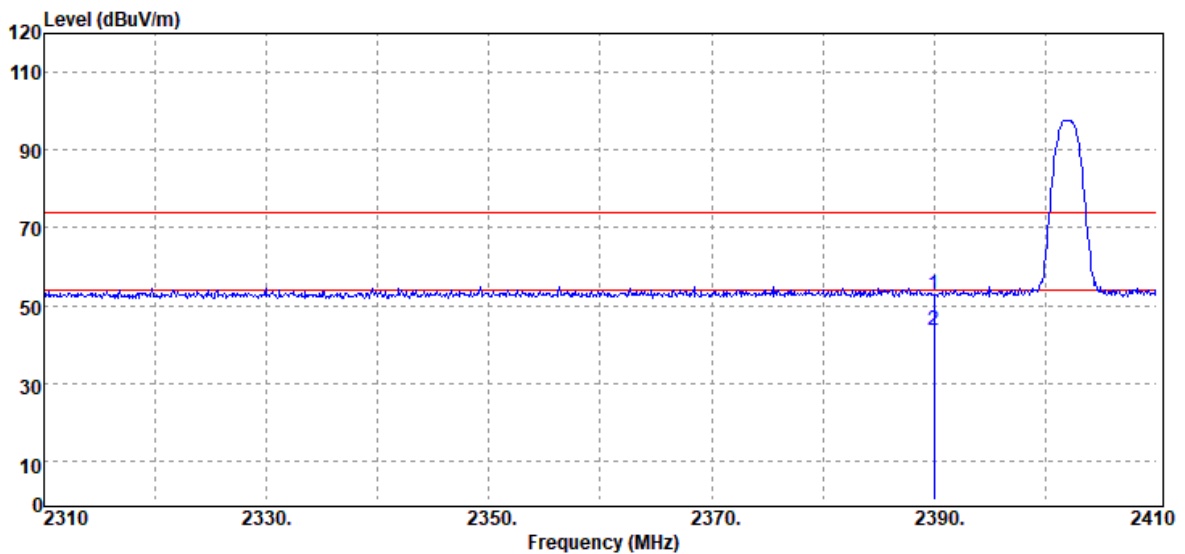

Freq. MHz	Detector Mode PK/QP/AV	Spectrum Reading Level dB μ V	Factor dB	Actual FS dB μ V/m	Limit @3m dB μ V/m	Margin dB
2390.00	Peak	49.00	3.70	52.70	74.00	-21.30
2390.00	Average	40.01	3.70	43.71	54.00	-10.29

Report No.: TMWK2109000572KR

Test Mode:	BLE-1Mbps High CH	Temp/Hum	22(°C)/ 50%RH
Test Item	Band Edge	Test Date	October 4, 2021
Polarize	Vertical	Test Engineer	Ray Li
Detector	Peak / Average		

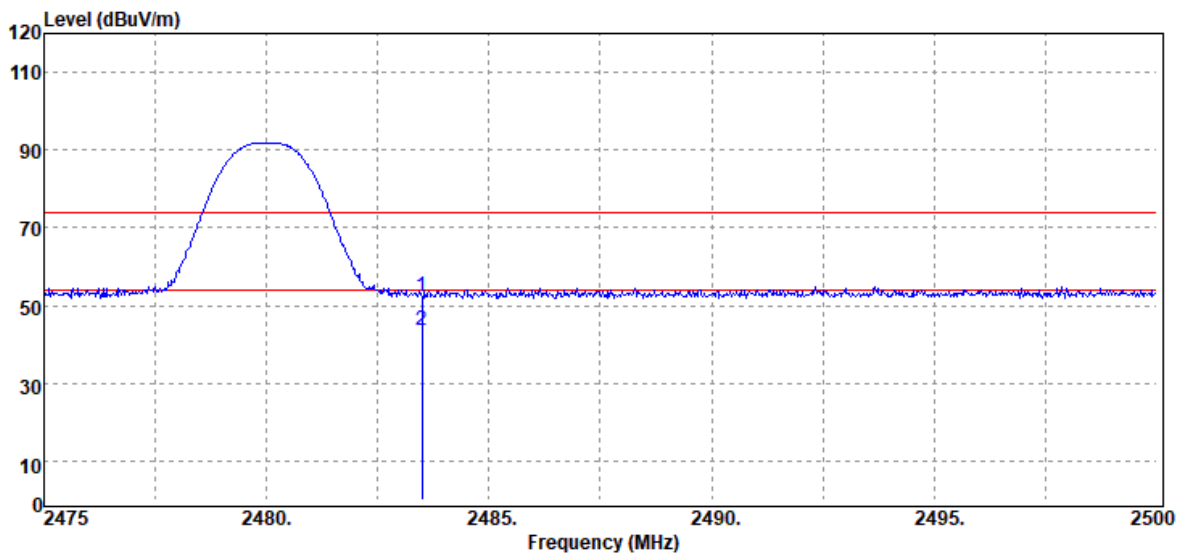

Freq. MHz	Detector Mode PK/QP/AV	Spectrum Reading Level dB μ V	Factor dB	Actual FS dB μ V/m	Limit @3m dB μ V/m	Margin dB
2483.50	Peak	48.43	4.04	52.47	74.00	-21.53
2483.50	Average	39.70	4.04	43.74	54.00	-10.26

Report No.: TMWK2109000572KR

Test Mode:	BLE-1Mbps High CH	Temp/Hum	22(°C)/ 50%RH
Test Item	Band Edge	Test Date	October 4, 2021
Polarize	Horizontal	Test Engineer	Ray Li
Detector	Peak / Average		

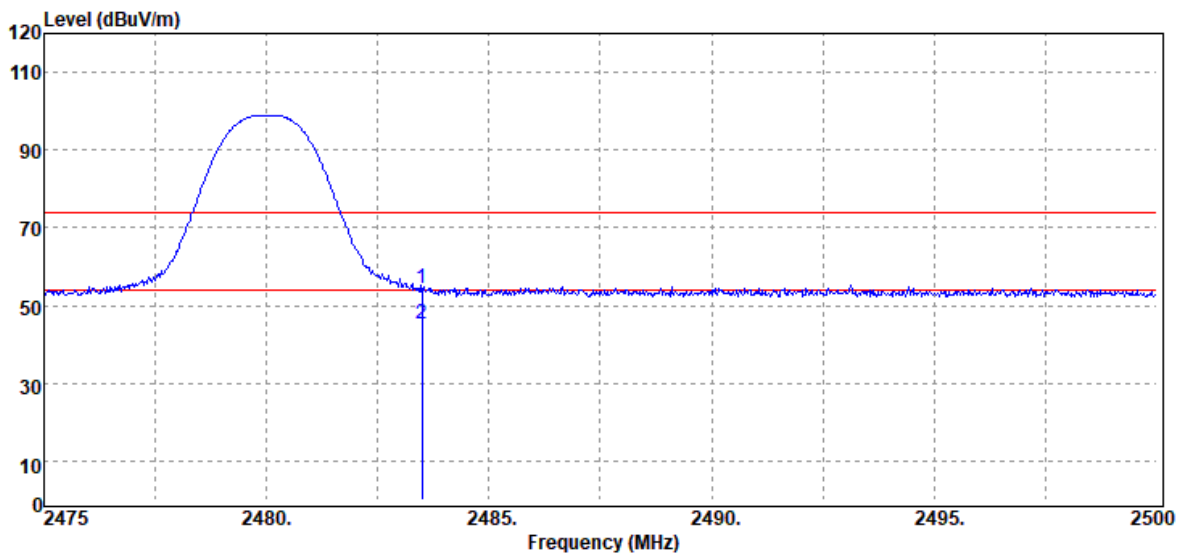

Freq. MHz	Detector Mode PK/QP/AV	Spectrum Reading Level dB μ V	Factor dB	Actual FS dB μ V/m	Limit @3m dB μ V/m	Margin dB
2483.50	Peak	50.36	4.04	54.40	74.00	-19.60
2483.50	Average	41.13	4.04	45.17	54.00	-8.83

Report No.: TMWK2109000572KR

Test Mode:	BLE-2Mbps Low CH	Temp/Hum	22(°C)/ 50%RH
Test Item	Band Edge	Test Date	October 4, 2021
Polarize	Vertical	Test Engineer	Ray Li
Detector	Peak / Average		

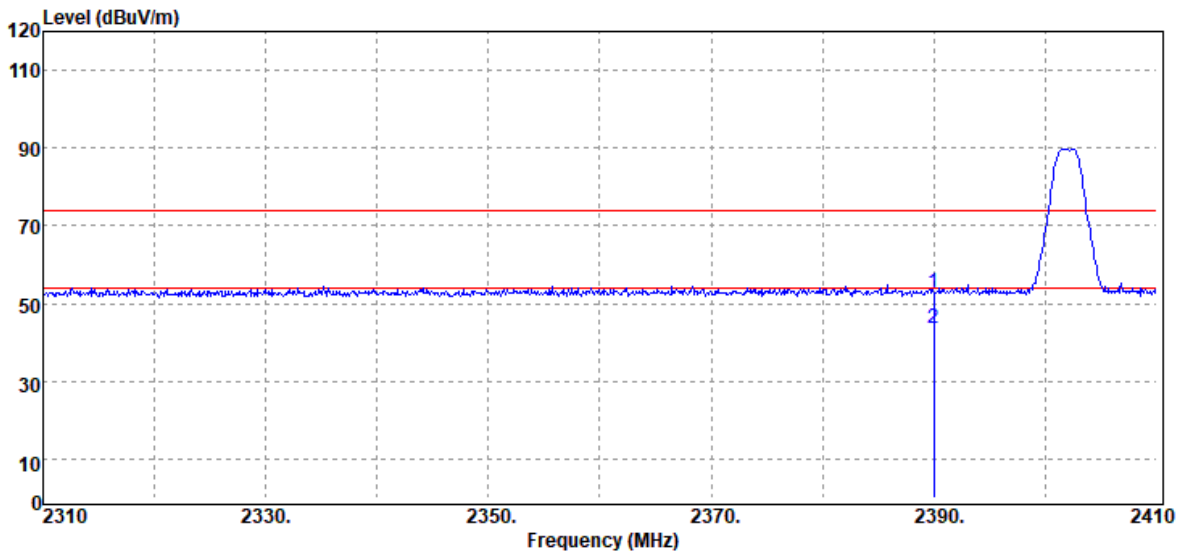

Freq. MHz	Detector Mode PK/QP/AV	Spectrum Reading Level dB μ V	Factor dB	Actual FS dB μ V/m	Limit @3m dB μ V/m	Margin dB
2390.00	Peak	48.87	3.70	52.57	74.00	-21.43
2390.00	Average	39.80	3.70	43.50	54.00	-10.50

Report No.: TMWK2109000572KR

Test Mode:	BLE-2Mbps Low CH	Temp/Hum	22(°C)/ 50%RH
Test Item	Band Edge	Test Date	October 4, 2021
Polarize	Horizontal	Test Engineer	Ray Li
Detector	Peak / Average		

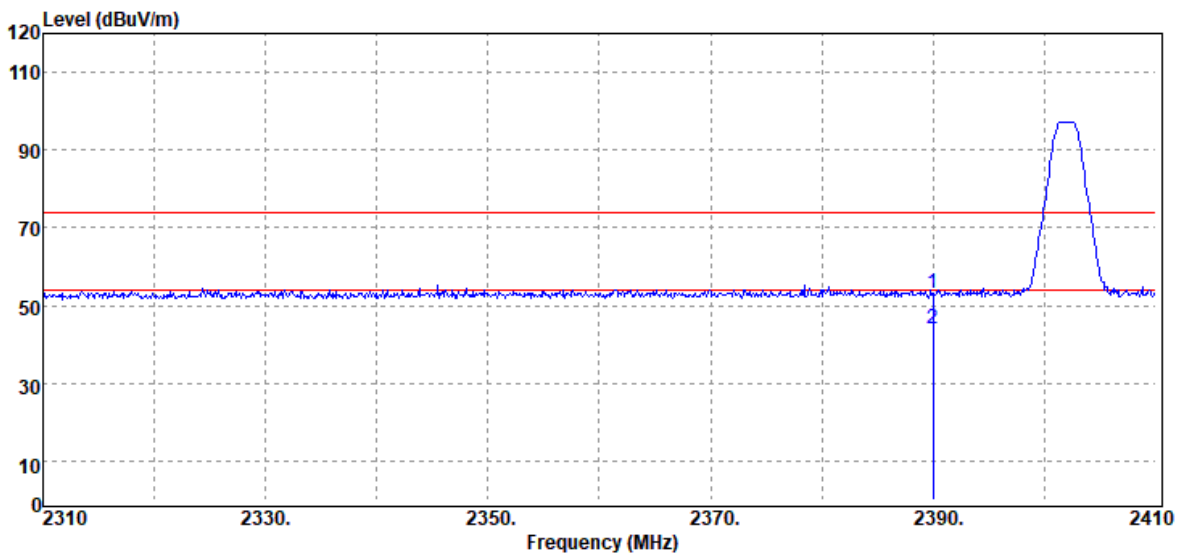

Freq. MHz	Detector Mode PK/QP/AV	Spectrum Reading Level dB μ V	Factor dB	Actual FS dB μ V/m	Limit @3m dB μ V/m	Margin dB
2390.00	Peak	49.40	3.70	53.10	74.00	-20.90
2390.00	Average	40.19	3.70	43.89	54.00	-10.11

Report No.: TMWK2109000572KR

Test Mode:	BLE-2Mbps High CH	Temp/Hum	22(°C)/ 50%RH
Test Item	Band Edge	Test Date	October 4, 2021
Polarize	Vertical	Test Engineer	Ray Li
Detector	Peak / Average		

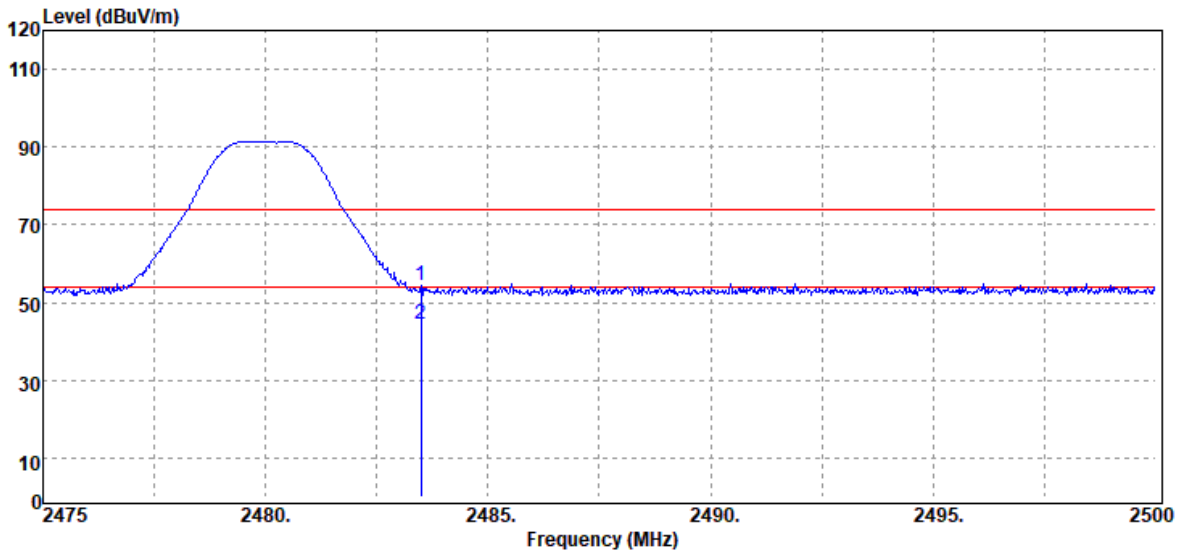

Freq. MHz	Detector Mode PK/QP/AV	Spectrum Reading Level dB μ V	Factor dB	Actual FS dB μ V/m	Limit @3m dB μ V/m	Margin dB
2483.50	Peak	50.19	4.04	54.23	74.00	-19.77
2483.50	Average	40.52	4.04	44.56	54.00	-9.44

Report No.: TMWK2109000572KR

Test Mode:	BLE-2Mbps High CH	Temp/Hum	22(°C)/ 50%RH
Test Item	Band Edge	Test Date	October 4, 2021
Polarize	Horizontal	Test Engineer	Ray Li
Detector	Peak / Average		

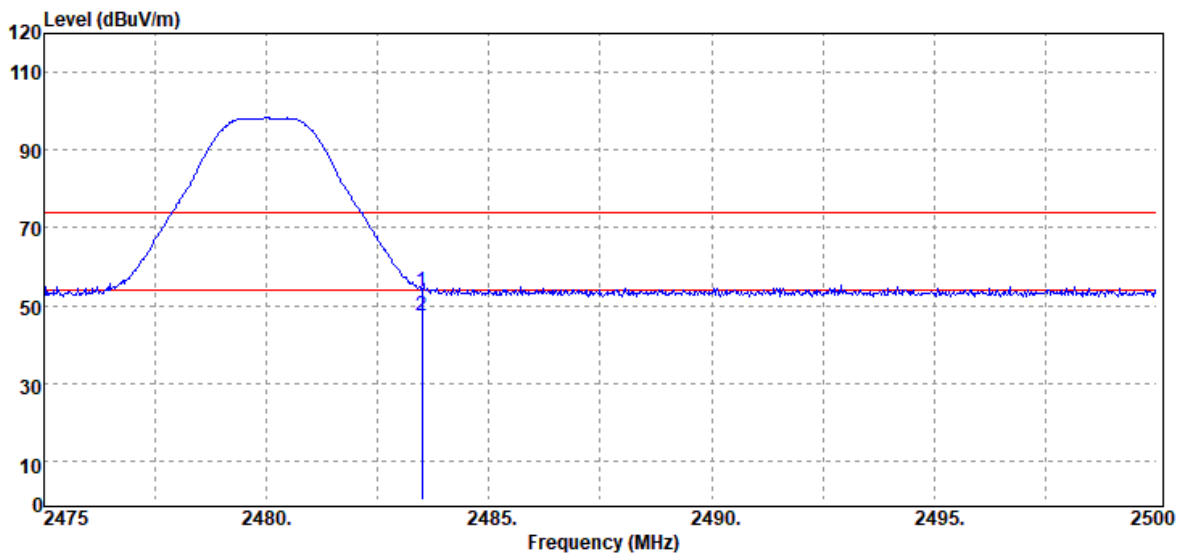

Freq. MHz	Detector Mode PK/QP/AV	Spectrum Reading Level dB μ V	Factor dB	Actual FS dB μ V/m	Limit @3m dB μ V/m	Margin dB
2483.50	Peak	49.69	4.04	53.73	74.00	-20.27
2483.50	Average	43.23	4.04	47.27	54.00	-6.73

Report No.: TMWK2109000572KR

Below 1G Test Data

Test Mode:	BLE-1Mbps Mode	Temp/Hum	23.1(°C)/ 55%RH
Test Item	30MHz-1GHz	Test Date	October 1, 2021
Polarize	Vertical	Test Engineer	Ray Li
Detector	Peak		

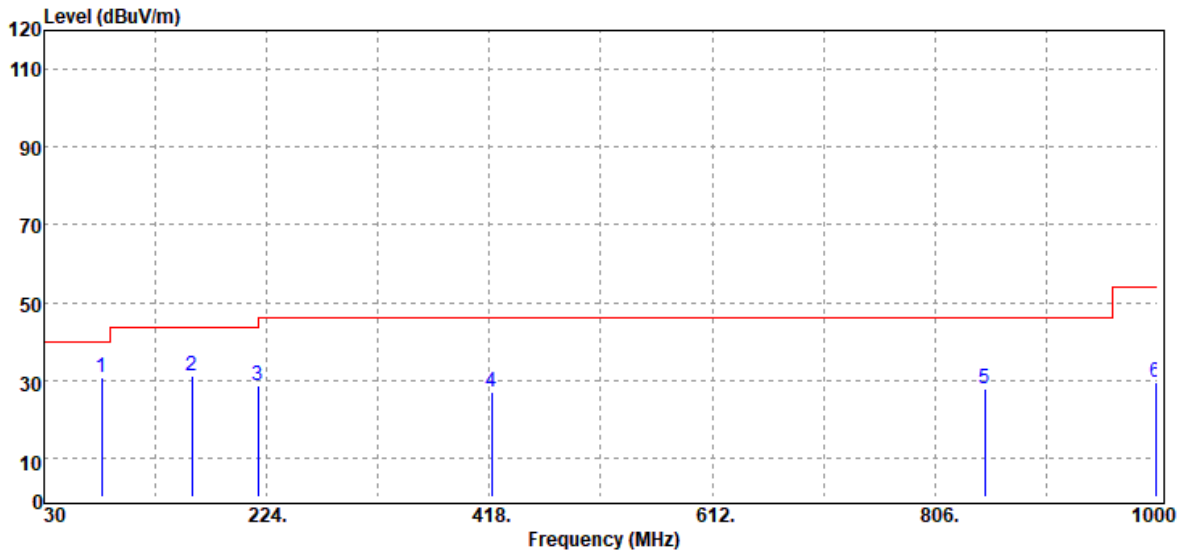

Freq. MHz	Detector Mode PK/QP/AV	Spectrum Reading Level dBμV	Factor dB	Actual FS dBμV/m	Limit @3m dBμV/m	Margin dB
80.44	Peak	46.47	-15.72	30.75	40.00	-9.25
159.01	Peak	41.86	-10.51	31.35	43.50	-12.15
216.24	Peak	40.75	-11.90	28.85	46.00	-17.15
419.94	Peak	32.44	-5.26	27.18	46.00	-18.82
849.65	Peak	25.61	2.23	27.84	46.00	-18.16
998.06	Peak	25.24	4.41	29.65	54.00	-24.35

Note: No emission found between lowest internal used/generated frequency to 30MHz (9kHz~30MHz).

Report No.: TMWK2109000572KR

Test Mode:	BLE-1Mbps Mode	Temp/Hum	23.1(°C)/ 55%RH
Test Item	30MHz-1GHz	Test Date	October 1, 2021
Polarize	Horizontal	Test Engineer	Ray Li
Detector	Peak		

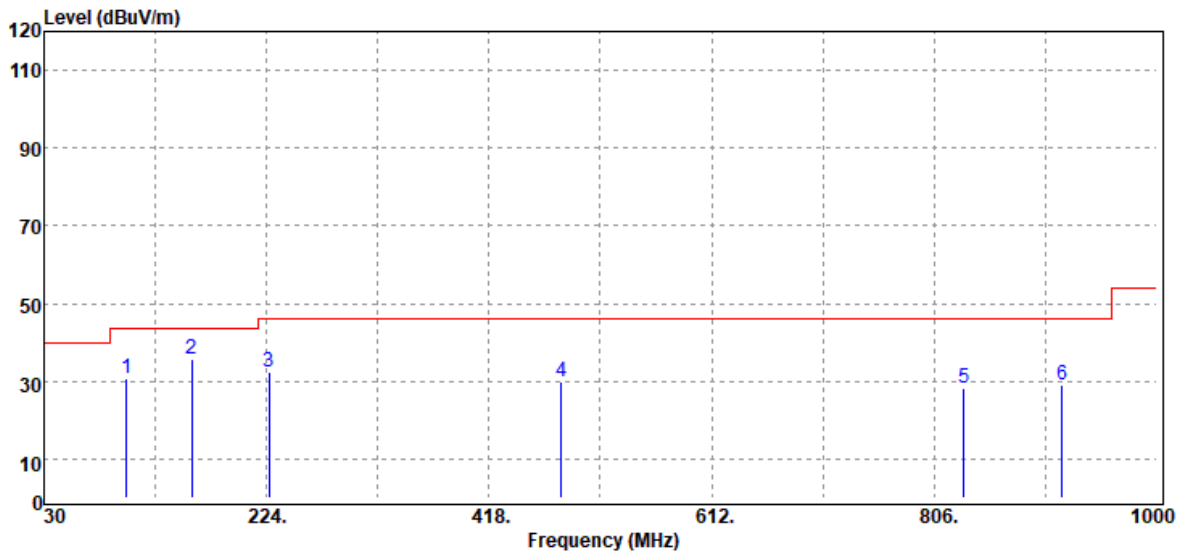

Freq. MHz	Detector Mode PK/QP/AV	Spectrum Reading Level dBμV	Factor dB	Actual FS dBμV/m	Limit @3m dBμV/m	Margin dB
101.78	Peak	42.92	-12.23	30.69	43.50	-12.81
159.01	Peak	46.32	-10.51	35.81	43.50	-7.69
225.94	Peak	44.12	-11.61	32.51	46.00	-13.49
481.05	Peak	33.35	-3.39	29.96	46.00	-16.04
832.19	Peak	26.10	2.00	28.10	46.00	-17.90
917.55	Peak	25.94	3.28	29.22	46.00	-16.78

Note: No emission found between lowest internal used/generated frequency to 30MHz (9kHz~30MHz).

Report No.: TMWK2109000572KR

Test Mode:	BLE-2Mbps Mode	Temp/Hum	23.1(°C)/ 55%RH
Test Item	30MHz-1GHz	Test Date	October 1, 2021
Polarize	Vertical	Test Engineer	Ray Li
Detector	Peak		

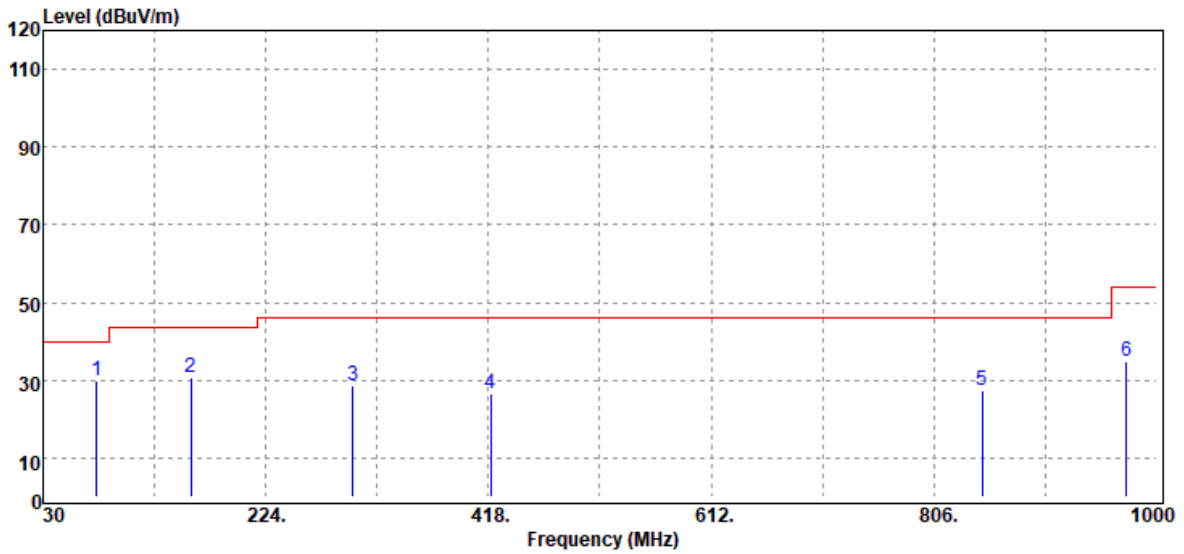

Freq. MHz	Detector Mode PK/QP/AV	Spectrum Reading Level dB μ V	Factor dB	Actual FS dB μ V/m	Limit @3m dB μ V/m	Margin dB
76.56	Peak	45.13	-15.35	29.78	40.00	-10.22
159.01	Peak	41.28	-10.51	30.77	43.50	-12.73
299.66	Peak	37.48	-8.80	28.68	46.00	-17.32
419.94	Peak	32.04	-5.26	26.78	46.00	-19.22
847.71	Peak	25.29	2.24	27.53	46.00	-18.47
973.81	Peak	31.03	3.94	34.97	54.00	-19.03

Note: No emission found between lowest internal used/generated frequency to 30MHz (9kHz~30MHz).

Report No.: TMWK2109000572KR

Test Mode:	BLE-2Mbps Mode	Temp/Hum	23.1(°C)/ 55%RH
Test Item	30MHz-1GHz	Test Date	October 1, 2021
Polarize	Horizontal	Test Engineer	Ray Li
Detector	Peak		

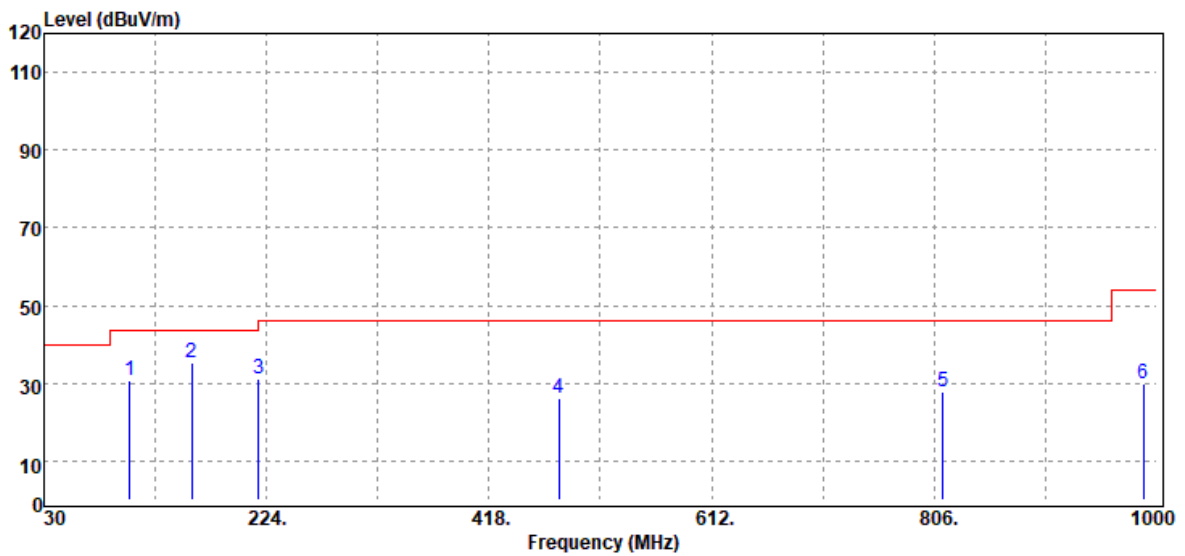

Freq. MHz	Detector Mode PK/QP/AV	Spectrum Reading Level dB μ V	Factor dB	Actual FS dB μ V/m	Limit @3m dB μ V/m	Margin dB
104.69	Peak	42.10	-11.31	30.79	43.50	-12.71
159.01	Peak	45.91	-10.51	35.40	43.50	-8.10
217.21	Peak	43.21	-11.89	31.32	46.00	-14.68
479.11	Peak	29.72	-3.39	26.33	46.00	-19.67
813.76	Peak	25.91	1.83	27.74	46.00	-18.26
988.36	Peak	25.47	4.35	29.82	54.00	-24.18

Note: No emission found between lowest internal used/generated frequency to 30MHz (9kHz~30MHz).

Report No.: TMWK2109000572KR

Above 1G Test Data

Test Mode:	BLE-1Mbps Low CH	Temp/Hum	23.1(°C)/ 55%RH
Test Item	Harmonic	Test Date	October 1, 2021
Polarize	Vertical	Test Engineer	Ray Li
Detector	Peak		

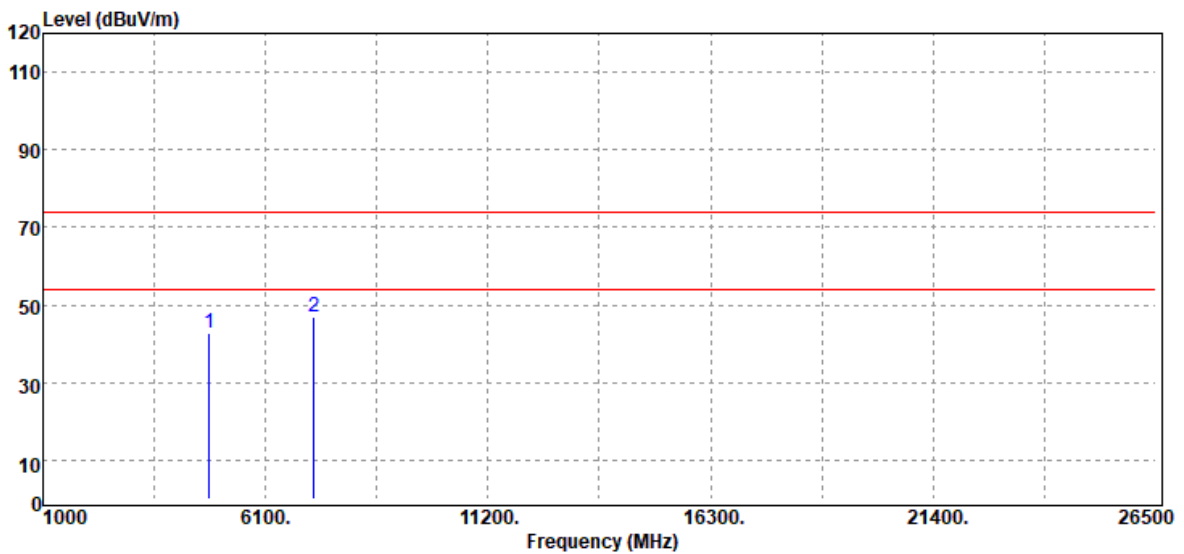

Freq. MHz	Detector Mode PK/QP/AV	Spectrum Reading Level dB μ V	Factor dB	Actual FS dB μ V/m	Limit @3m dB μ V/m	Margin dB
4804.00	Peak	33.47	9.28	42.75	74.00	-31.25
7206.00	Peak	33.21	13.52	46.73	74.00	-27.27
N/A						

Remark:

1. Measuring frequencies from 1 GHz to the 10th harmonic of highest fundamental frequency.
2. For above 1GHz, the EUT peak value was under average limit, therefore the Average value compliance with the average limit

Report No.: TMWK2109000572KR

Test Mode:	BLE-1Mbps Low CH	Temp/Hum	23.1(°C)/ 55%RH
Test Item	Harmonic	Test Date	October 1, 2021
Polarize	Horizontal	Test Engineer	Ray Li
Detector	Peak		

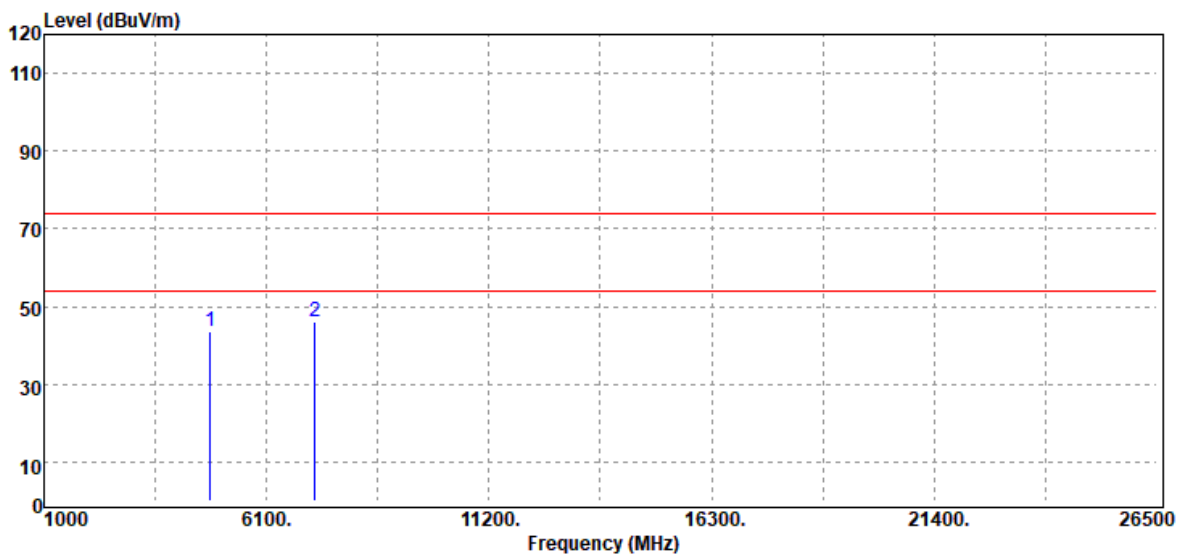

Freq. MHz	Detector Mode PK/QP/AV	Spectrum Reading Level dB μ V	Factor dB	Actual FS dB μ V/m	Limit @3m dB μ V/m	Margin dB
4804.00	Peak	34.20	9.28	43.48	74.00	-30.52
7206.00	Peak	32.40	13.52	45.92	74.00	-28.08
N/A						

Remark:

1. Measuring frequencies from 1 GHz to the 10th harmonic of highest fundamental frequency.
2. For above 1GHz, the EUT peak value was under average limit, therefore the Average value compliance with the average limit

Report No.: TMWK2109000572KR

Test Mode:	BLE-1Mbps Mid CH	Temp/Hum	23.1(°C)/ 55%RH
Test Item	Harmonic	Test Date	October 1, 2021
Polarize	Vertical	Test Engineer	Ray Li
Detector	Peak		

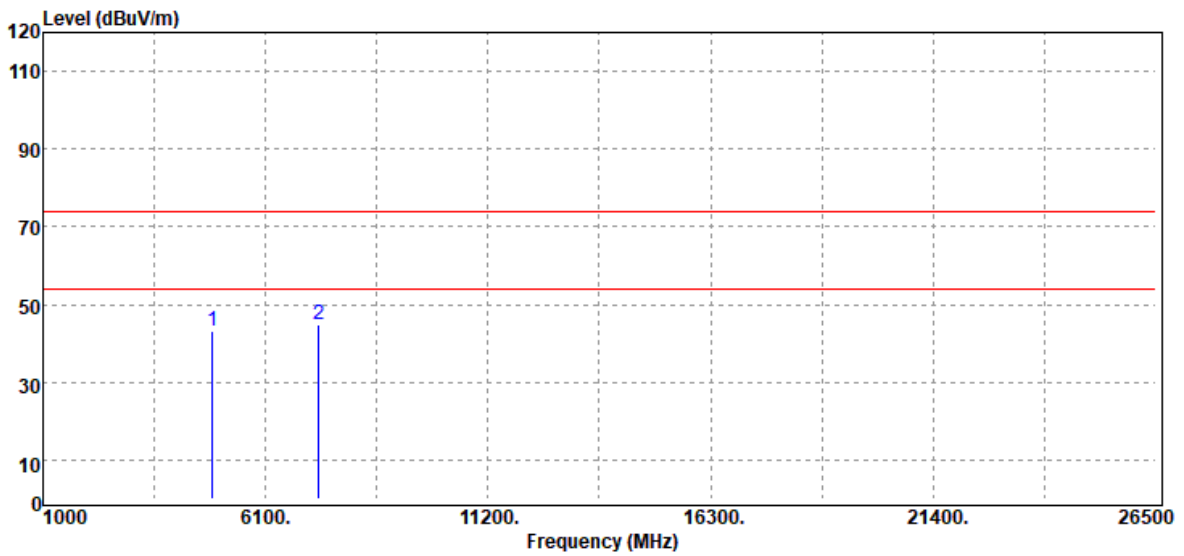

Freq. MHz	Detector Mode PK/QP/AV	Spectrum Reading Level dBµV	Factor dB	Actual FS dBµV/m	Limit @3m dBµV/m	Margin dB
4884.00	Peak	33.68	9.49	43.17	74.00	-30.83
7326.00	Peak	31.46	13.49	44.95	74.00	-29.05
N/A						

Remark:

1. Measuring frequencies from 1 GHz to the 10th harmonic of highest fundamental frequency.
2. For above 1GHz, the EUT peak value was under average limit, therefore the Average value compliance with the average limit

Report No.: TMWK2109000572KR

Test Mode:	BLE-1Mbps Mid CH	Temp/Hum	23.1(°C)/ 55%RH
Test Item	Harmonic	Test Date	October 1, 2021
Polarize	Horizontal	Test Engineer	Ray Li
Detector	Peak		

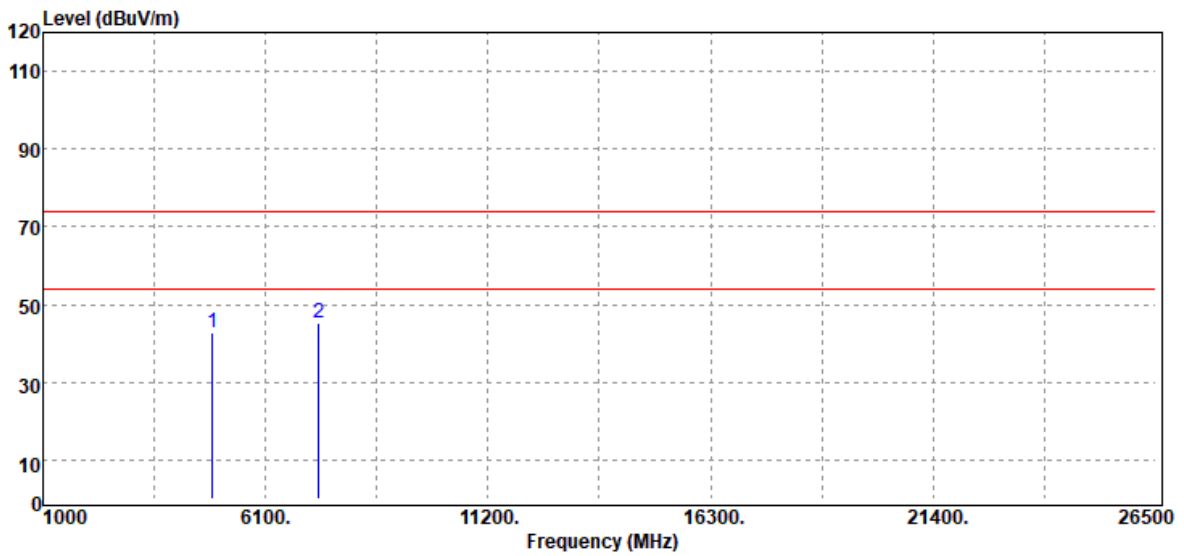

Freq. MHz	Detector Mode PK/QP/AV	Spectrum Reading Level dBµV	Factor dB	Actual FS dBµV/m	Limit @3m dBµV/m	Margin dB
4884.00	Peak	33.11	9.49	42.60	74.00	-31.40
7326.00	Peak	31.88	13.49	45.37	74.00	-28.63
N/A						

Remark:

1. Measuring frequencies from 1 GHz to the 10th harmonic of highest fundamental frequency.
2. For above 1GHz, the EUT peak value was under average limit, therefore the Average value compliance with the average limit

Report No.: TMWK2109000572KR

Test Mode:	BLE-1Mbps High CH	Temp/Hum	23.1(°C)/ 55%RH
Test Item	Harmonic	Test Date	October 1, 2021
Polarize	Vertical	Test Engineer	Ray Li
Detector	Peak		

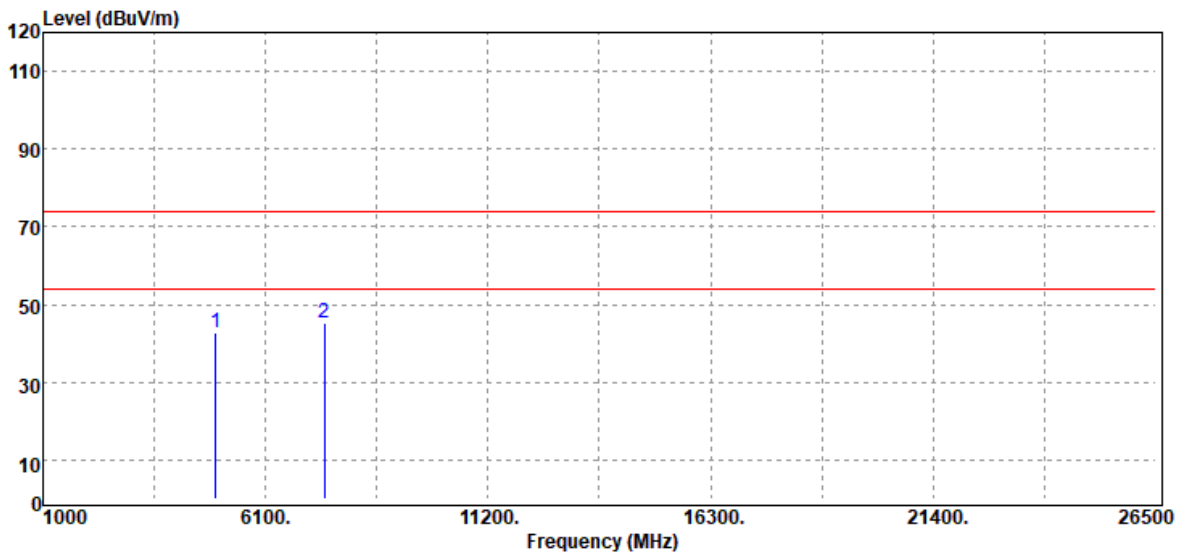

Freq. MHz	Detector Mode PK/QP/AV	Spectrum Reading Level dBµV	Factor dB	Actual FS dBµV/m	Limit @3m dBµV/m	Margin dB
4960.00	Peak	33.08	9.81	42.89	74.00	-31.11
7440.00	Peak	31.79	13.64	45.43	74.00	-28.57
N/A						

Remark:

1. Measuring frequencies from 1 GHz to the 10th harmonic of highest fundamental frequency.
2. For above 1GHz, the EUT peak value was under average limit, therefore the Average value compliance with the average limit

Report No.: TMWK2109000572KR

Test Mode:	BLE-1Mbps High CH	Temp/Hum	23.1(°C)/ 55%RH
Test Item	Harmonic	Test Date	October 1, 2021
Polarize	Horizontal	Test Engineer	Ray Li
Detector	Peak		

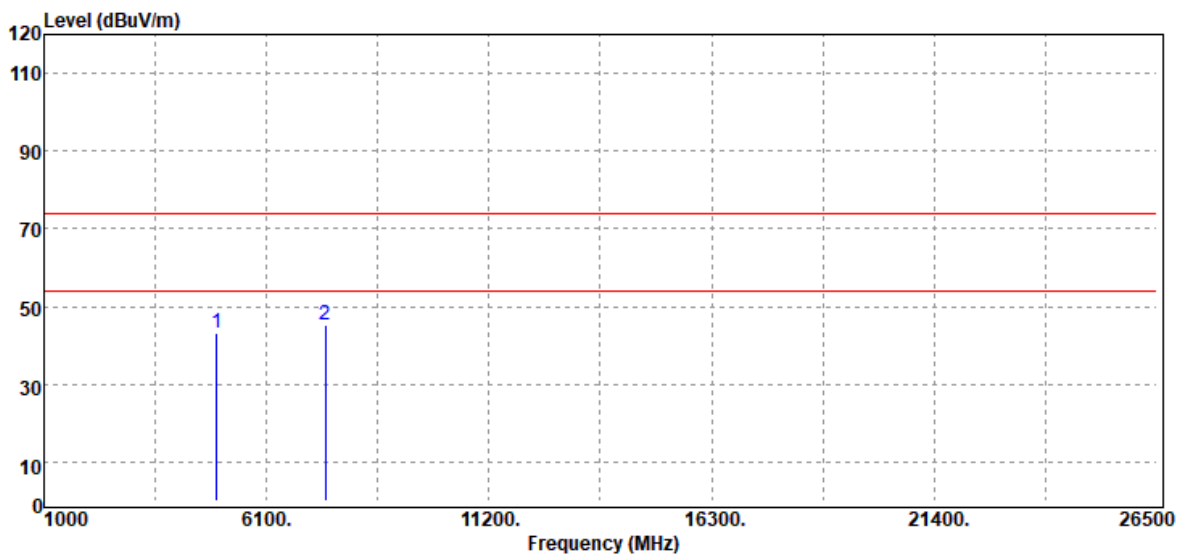

Freq. MHz	Detector Mode PK/QP/AV	Spectrum Reading Level dBµV	Factor dB	Actual FS dBµV/m	Limit @3m dBµV/m	Margin dB
4960.00	Peak	33.19	9.81	43.00	74.00	-31.00
7440.00	Peak	31.47	13.64	45.11	74.00	-28.89
N/A						

Remark:

1. Measuring frequencies from 1 GHz to the 10th harmonic of highest fundamental frequency.
2. For above 1GHz, the EUT peak value was under average limit, therefore the Average value compliance with the average limit

Report No.: TMWK2109000572KR

Test Mode:	BLE-2Mbps Low CH	Temp/Hum	23.1(°C)/ 55%RH
Test Item	Harmonic	Test Date	October 1, 2021
Polarize	Vertical	Test Engineer	Ray Li
Detector	Peak		

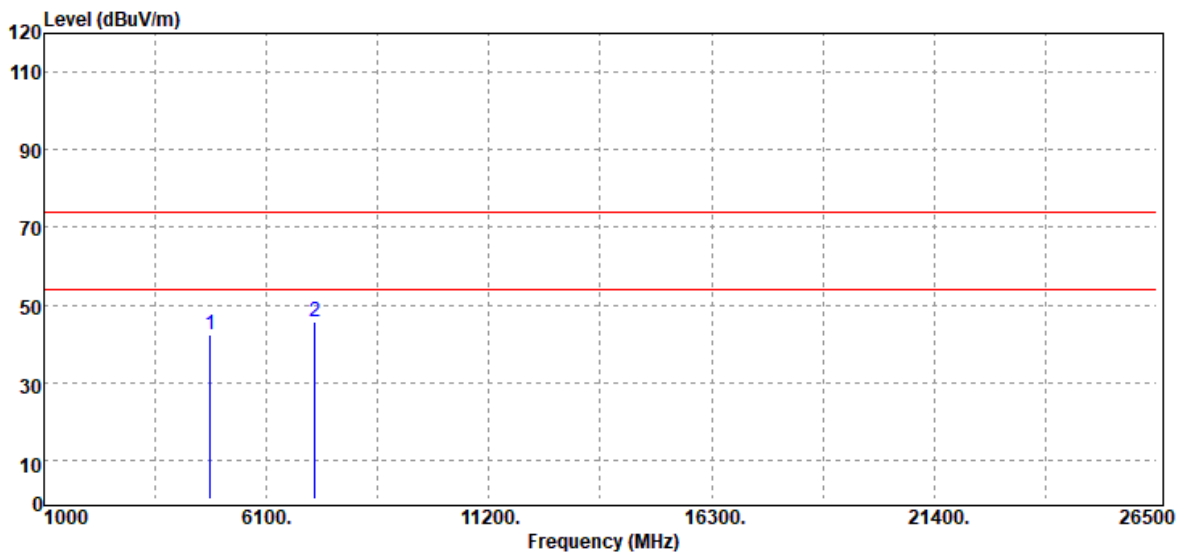

Freq. MHz	Detector Mode PK/QP/AV	Spectrum Reading Level dB μ V	Factor dB	Actual FS dB μ V/m	Limit @3m dB μ V/m	Margin dB
4804.00	Peak	33.27	9.28	42.55	74.00	-31.45
7206.00	Peak	32.28	13.52	45.80	74.00	-28.20
N/A						

Remark:

1. Measuring frequencies from 1 GHz to the 10th harmonic of highest fundamental frequency.
2. For above 1GHz, the EUT peak value was under average limit, therefore the Average value compliance with the average limit

Report No.: TMWK2109000572KR

Test Mode:	BLE-2Mbps Low CH	Temp/Hum	23.1(°C)/ 55%RH
Test Item	Harmonic	Test Date	October 1, 2021
Polarize	Horizontal	Test Engineer	Ray Li
Detector	Peak		

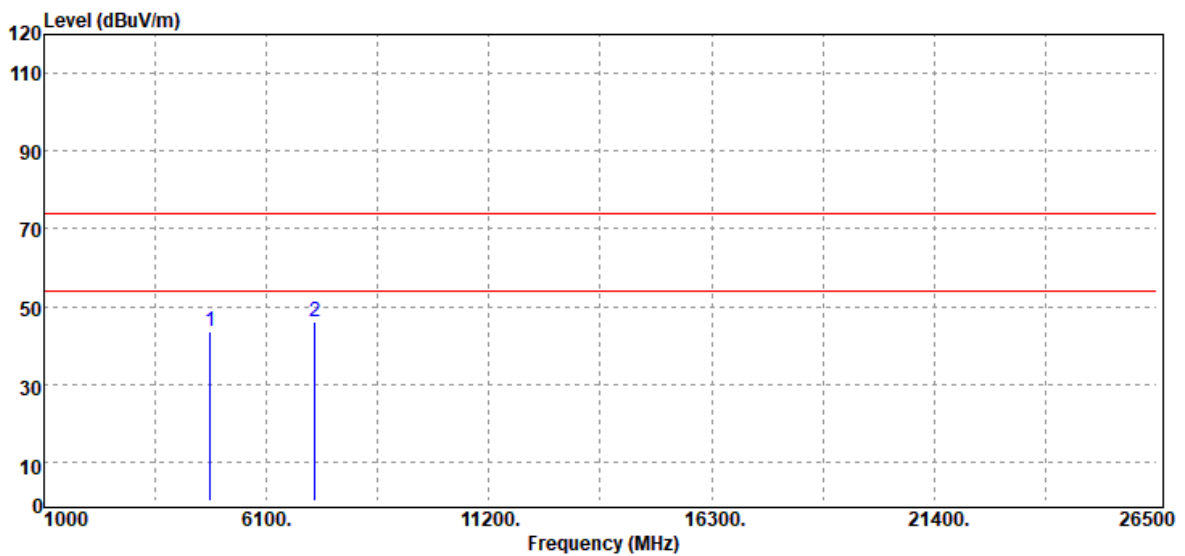

Freq. MHz	Detector Mode PK/QP/AV	Spectrum Reading Level dBµV	Factor dB	Actual FS dBµV/m	Limit @3m dBµV/m	Margin dB
4804.00	Peak	34.17	9.28	43.45	74.00	-30.55
7206.00	Peak	32.57	13.52	46.09	74.00	-27.91
N/A						

Remark:

1. Measuring frequencies from 1 GHz to the 10th harmonic of highest fundamental frequency.
2. For above 1GHz, the EUT peak value was under average limit, therefore the Average value compliance with the average limit

Report No.: TMWK2109000572KR

Test Mode:	BLE-2Mbps Mid CH	Temp/Hum	23.1(°C)/ 55%RH
Test Item	Harmonic	Test Date	October 1, 2021
Polarize	Vertical	Test Engineer	Ray Li
Detector	Peak		

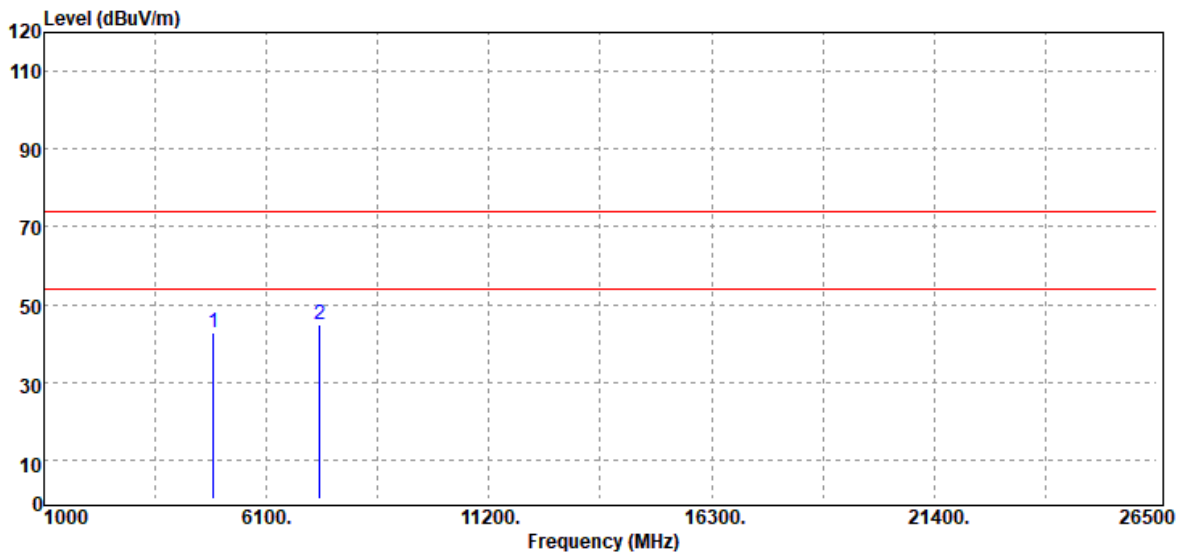

Freq. MHz	Detector Mode PK/QP/AV	Spectrum Reading Level dBµV	Factor dB	Actual FS dBµV/m	Limit @3m dBµV/m	Margin dB
4884.00	Peak	33.31	9.49	42.80	74.00	-31.20
7326.00	Peak	31.43	13.49	44.92	74.00	-29.08
N/A						

Remark:

1. Measuring frequencies from 1 GHz to the 10th harmonic of highest fundamental frequency.
2. For above 1GHz, the EUT peak value was under average limit, therefore the Average value compliance with the average limit

Report No.: TMWK2109000572KR

Test Mode:	BLE-2Mbps Mid CH	Temp/Hum	23.1(°C)/ 55%RH
Test Item	Harmonic	Test Date	October 1, 2021
Polarize	Horizontal	Test Engineer	Ray Li
Detector	Peak		

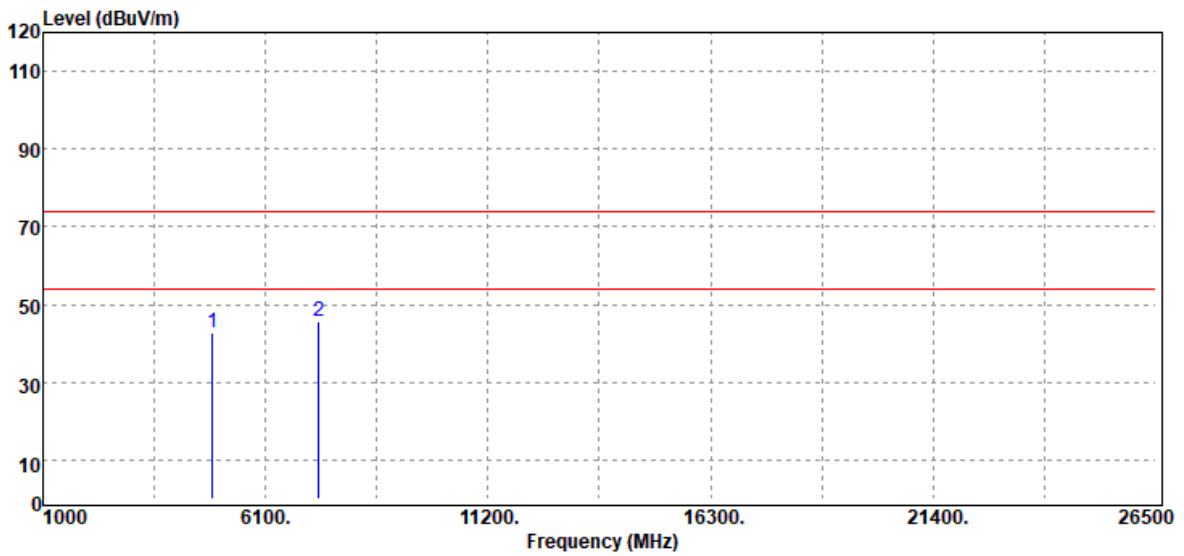

Freq. MHz	Detector Mode PK/QP/AV	Spectrum Reading Level dBµV	Factor dB	Actual FS dBµV/m	Limit @3m dBµV/m	Margin dB
4884.00	Peak	33.35	9.49	42.84	74.00	-31.16
7326.00	Peak	32.05	13.49	45.54	74.00	-28.46
N/A						

Remark:

1. Measuring frequencies from 1 GHz to the 10th harmonic of highest fundamental frequency.
2. For above 1GHz, the EUT peak value was under average limit, therefore the Average value compliance with the average limit

Report No.: TMWK2109000572KR

Test Mode:	BLE-2Mbps High CH	Temp/Hum	23.1(°C)/ 55%RH
Test Item	Harmonic	Test Date	October 1, 2021
Polarize	Vertical	Test Engineer	Ray Li
Detector	Peak		

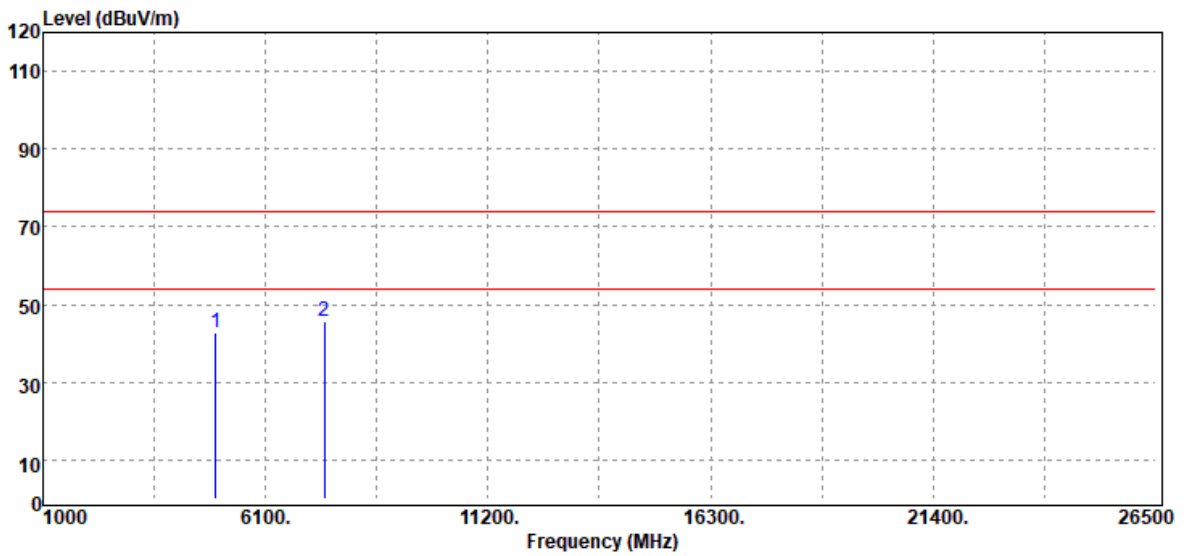

Freq. MHz	Detector Mode PK/QP/AV	Spectrum Reading Level dBµV	Factor dB	Actual FS dBµV/m	Limit @3m dBµV/m	Margin dB
4960.00	Peak	32.89	9.81	42.70	74.00	-31.30
7440.00	Peak	32.03	13.64	45.67	74.00	-28.33
N/A						

Remark:

1. Measuring frequencies from 1 GHz to the 10th harmonic of highest fundamental frequency.
2. For above 1GHz, the EUT peak value was under average limit, therefore the Average value compliance with the average limit

Report No.: TMWK2109000572KR

Test Mode:	BLE-2Mbps High CH	Temp/Hum	23.1(°C)/ 55%RH
Test Item	Harmonic	Test Date	October 1, 2021
Polarize	Horizontal	Test Engineer	Ray Li
Detector	Peak		

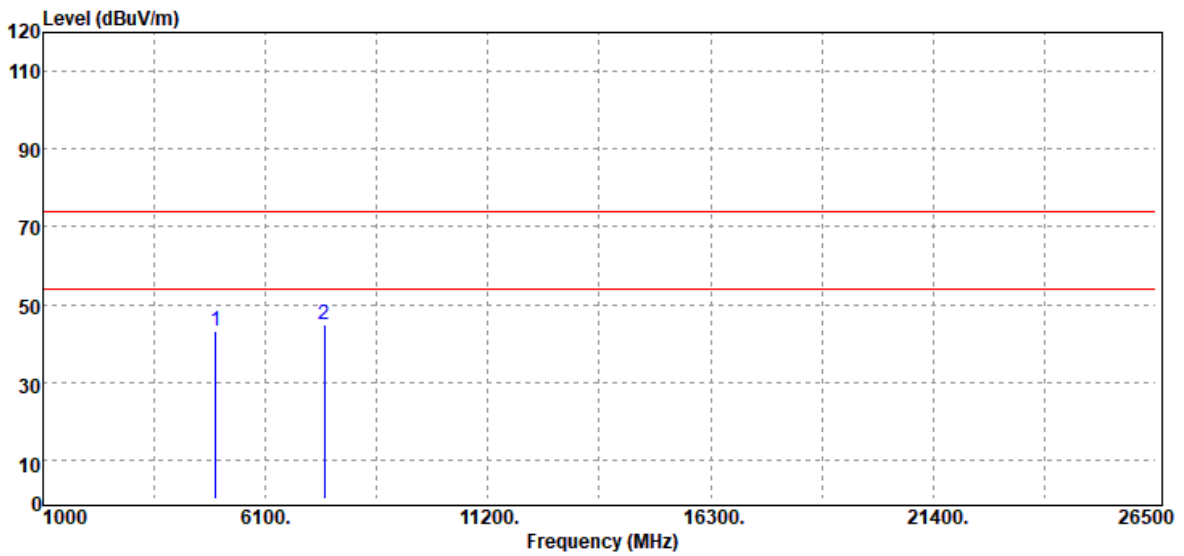

Freq. MHz	Detector Mode PK/QP/AV	Spectrum Reading Level dBµV	Factor dB	Actual FS dBµV/m	Limit @3m dBµV/m	Margin dB
4960.00	Peak	33.31	9.81	43.12	74.00	-30.88
7440.00	Peak	31.02	13.64	44.66	74.00	-29.34
N/A						

Remark:

1. Measuring frequencies from 1 GHz to the 10th harmonic of highest fundamental frequency.
2. For above 1GHz, the EUT peak value was under average limit, therefore the Average value compliance with the average limit

--End of Test Report--