

FCC ID: PANP31ASUS
Report No.: TMWK2109000560KR

IC: 6225A-P31ASUS

Page: 1 / 88
Rev.: 00

RADIO TEST REPORT

FCC 47 CFR PART 15 SUBPART C

INDUSTRY CANADA RSS-247

Test Standard	FCC Part 15.247 RSS-247 issue 2 and RSS-GEN issue 5
Product name	ac2x2+BT5.0 USB2.0
Brand Name	CC&C
Model No.	P31ASUS
Test Result	Pass
Statements of Conformity	Determination of compliance is based on the results of the compliance measurement, not taking into account measurement instrumentation uncertainty.

The test Result was tested by Compliance Certification Services Inc. The test data, data evaluation, test procedures, and equipment configurations shown in this report were given in ANSI C63.10: 2013 and compliance standards.

The test results of this report relate only to the tested sample (EUT) identified in this report.

The test Report of full or partial shall not copy. Without written approval of Compliance Certification Services Inc.(Wugu Laboratory)

Approved by:



Kevin Tsai
Deputy Manager

Unless otherwise stated the results shown in this test report refer only to the sample(s) tested and such sample(s) are retained for 90 days only.
除非另有說明，此報告結果僅對測試之樣品負責，同時此樣品僅保留90天。本報告未經本公司書面許可，不可部份複製。

This document is issued by the Company subject to its General Conditions of Service printed overleaf, available on request or accessible at <http://www.sgs.com.tw/Terms-and-Conditions> and, for electronic format documents, subject to Terms and Conditions for Electronic Documents at <http://www.sgs.com.tw/Terms-and-Conditions>. Attention is drawn to the limitation of liability, indemnification and jurisdiction issues defined therein. Any holder of this document is advised that information contained hereon reflects the Company's findings at the time of its intervention only and within the limits of client's instruction, if any. The Company's sole responsibility is to its Client and this document does not exonerate parties to a transaction from exercising all their rights and obligations under the transaction documents. This document cannot be reproduced, except in full, without prior written approval of the Company. Any unauthorized alteration, forgery or falsification of the content or appearance of this document is unlawful and offenders may be prosecuted to the fullest extent of the law.

Report No.: TMWK2109000560KR

Page: 2 / 88

Rev.: 00

Revision History

Rev.	Issue Date	Revisions	Effect Page	Revised By
00	November 25, 2021	Initial Issue	ALL	Doris Chu

Report No.: TMWK2109000560KR

Table of contents

1. GENERAL INFORMATION.....	4
1.1 EUT INFORMATION.....	4
1.2 INFORMATION ABOUT THE FHSS CHARACTERISTICS.....	5
1.3 EUT CHANNEL INFORMATION.....	6
1.4 ANTENNA INFORMATION.....	6
1.5 MEASUREMENT UNCERTAINTY.....	7
1.6 FACILITIES AND TEST LOCATION.....	8
1.7 INSTRUMENT CALIBRATION.....	8
1.8 SUPPORT AND EUT ACCESSORIES EQUIPMENT.....	10
1.9 TEST METHODOLOGY AND APPLIED STANDARDS.....	10
2. TEST SUMMARY.....	11
3. DESCRIPTION OF TEST MODES.....	12
3.1 THE WORST MODE OF OPERATING CONDITION.....	12
3.2 THE WORST MODE OF MEASUREMENT.....	13
3.3 EUT DUTY CYCLE.....	14
4. TEST RESULT.....	18
4.1 AC POWER LINE CONDUCTED EMISSION.....	18
4.2 20DB BANDWIDTH AND OCCUPIED BANDWIDTH (99%).....	21
4.3 OUTPUT POWER MEASUREMENT.....	29
4.4 FREQUENCY SEPARATION.....	33
4.5 NUMBER OF HOPPING.....	38
4.6 CONDUCTED BANDEDGE AND SPURIOUS EMISSION.....	41
4.7 TIME OF OCCUPANCY (DWELL TIME).....	49
4.8 RADIATION BANDEDGE AND SPURIOUS EMISSION.....	54
APPENDIX 1 - PHOTOGRAPHS OF EUT	

Report No.: TMWK2109000560KR

1. GENERAL INFORMATION

1.1 EUT INFORMATION

Applicant	CC&C Technologies, Inc. 8F, No.150, Jian Yi Rd, Zhonghe District, New Taipei City, 235, Taiwan
Manufacturer	CC&C Technologies, Inc. 8F, No.150, Jian Yi Rd, Zhonghe District, New Taipei City, 235, Taiwan
Equipment	ac2x2+BT5.0 USB2.0
Model No.	P31ASUS
Model Discrepancy	N/A
Trade Name	CC&C
Received Date	September 10, 2021
Date of Test	September 28 ~ October 4, 2021
Power Supply	Power from host device.
HW Version	V.A
SW Version	V15
EUT Serial #	CCCP312145001

Remark:

1. For more details, please refer to the User's manual of the EUT.
2. Disclaimer: Antenna information is provided by the applicant, test results of this report are applicable to the sample EUT received.

Report No.: TMWK2109000560KR

1.2 INFORMATION ABOUT THE FHSS CHARACTERISTICS

1.2.1 Pseudorandom Frequency Hopping Sequence

The channel is represented by a pseudo-random hopping sequence hopping through the 79 RF channels. The hopping sequence is unique for the piconet and is determined by the Bluetooth device address of the master; the phase in the hopping sequence is determined by the Bluetooth clock of the master. The channel is divided into time slots where each slot corresponds to an RF hop frequency. Consecutive hops correspond to different RF hop frequencies. The nominal hop rate is 1 600 hops/s.

1.2.2 Equal Hopping Frequency Use

The channels of this system will be used equally over the long-term distribution of the hopsets.

1.2.3 Example of a 79 hopping sequence in data mode:

02, 05, 31, 24, 20, 10, 43, 36, 30, 23, 40, 06, 21, 50, 44, 09, 71, 78, 01, 13, 73, 07, 70, 72, 35, 62, 42, 11, 41, 08, 16, 29, 60, 15, 34, 61, 58, 04, 67, 12, 22, 53, 57, 18, 27, 76, 39, 32, 17, 77, 52, 33, 56, 46, 37, 47, 64, 49, 45, 38, 69, 14, 51, 26, 79, 19, 28, 65, 75, 54, 48, 03, 25, 66, 05, 16, 68, 74, 59, 63, 55

1.2.4 System Receiver Input Bandwidth

Each channel bandwidth is 1MHz.

The system receivers have input bandwidths that match the hopping channel bandwidths of their corresponding transmitters and shift frequencies in synchronization with the transmitted signals.

1.2.5 Equipment Description

RSS-247, 5.1 (a): The system shall hop to channel frequencies that are selected at the system hopping rate from a pseudo randomly ordered list of hopping frequencies. The system receivers shall have input bandwidths that match the hopping channel bandwidths of their corresponding transmitters and shall shift frequencies in synchronization with the transmitted signals.

Report No.: TMWK2109000560KR

1.3 EUT CHANNEL INFORMATION

Frequency Range	2402MHz-2480MHz
Modulation Type	1. GFSK for BDR-1Mbps 2. $\pi/4$ -DQPSK for EDR-2Mbps 3. 8DPSK for EDR-3Mbps
Number of channel	79 Channels

Remark:

Refer as ANSI C63.10: 2013 clause 5.6.1 Table 4 and RSS-GEN Table 1 for test channels

Number of frequencies to be tested		
Frequency range in which device operates	Number of frequencies	Location in frequency range of operation
<input type="checkbox"/> 1 MHz or less	1	Middle
<input type="checkbox"/> 1 MHz to 10 MHz	2	1 near top and 1 near bottom
<input checked="" type="checkbox"/> More than 10 MHz	3	1 near top, 1 near middle, and 1 near bottom

1.4 ANTENNA INFORMATION

Antenna Type	<input type="checkbox"/> FPC <input checked="" type="checkbox"/> PCB <input type="checkbox"/> Dipole <input type="checkbox"/> Coils
Antenna Gain	Main: WA-P-LB-02-914: Gain :2.93 dBi

Remark:

1.The antenna(s) of the EUT are permanently attached and there are no provisions for connection to an external antenna. So the EUT complies with the requirements of §15.203 and RSS-Gen 6.8.

Report No.: TMWK2109000560KR

1.5 MEASUREMENT UNCERTAINTY

PARAMETER	UNCERTAINTY
AC Powerline Conducted Emission	+/- 1.2575
Emission bandwidth, 20dB bandwidth	+/- 0.0014
RF output power, conducted	+/- 1.14
Power density, conducted	+/- 1.40
3M Semi Anechoic Chamber / 30M~1G (Horizontally)	+/- 3.91
3M Semi Anechoic Chamber / 30M~1G (Vertically)	+/- 4.57
3M Semi Anechoic Chamber / 1G~6G	+/- 5.20
3M Semi Anechoic Chamber / 6G~18G	+/- 5.18
3M Semi Anechoic Chamber / 18G~40G	+/- 3.68

Remark:

- 1.This uncertainty represents an expanded uncertainty expressed at approximately the 95% confidence level using a coverage factor of k=2
2. ISO/IEC 17025 requires that an estimate of the measurement uncertainties associated with the emissions test results be included in the report.

Report No.: TMWK2109000560KR

1.6 FACILITIES AND TEST LOCATION

All measurement facilities used to collect the measurement data are located at No.11, Wugong 6th Rd., Wugu Dist., New Taipei City, Taiwan. (R.O.C.)
CAB identifier: TW1309

Test site	Test Engineer	Remark
AC Conduction Room	Jack Chen	-
Radiation	Ray Li	-
RF Conducted	Lance Chen	-

Remark: The lab has been recognized as the FCC accredited lab under the KDB 974614 D01 and is listed in the FCC public Access Link (PAL) database, FCC Registration No. :444940, the FCC Designation No.:TW1309”

1.7 INSTRUMENT CALIBRATION

RF Conducted Test Site					
Name of Equipment	Manufacturer	Model	Serial Number	Calibration Date	Calibration Due
Coaxial Cable	Woken	WC12	CC003	06/28/2021	06/27/2022
Coaxial Cable	Woken	WC12	CC001	06/28/2021	06/27/2022
Power Meter	Anritsu	ML2487A	6K00003260	05/24/2021	05/23/2022
Power Seneor	Anritsu	MA2490A	032910	05/24/2021	05/23/2022
EXA Signal Analyzer	KEYSIGHT	N9010B	MY55460167	09/07/2021	09/06/2022
Software	Radio Test Software Ver. 21				

Conducted Emission Room					
Name of Equipment	Manufacturer	Model	Serial Number	Calibration Date	Calibration Due
CABLE	EMCI	CFD300-NL	CERF	06/28/2021	06/27/2022
EMI Test Receiver	R&S	ESCI	100064	07/05/2021	07/04/2022
LISN	SCHAFFNER	NNB 41	03/10013	02/02/2021	02/01/2022
Software	EZ-EMC(CCS-3A1-CE)				

Report No.: TMWK2109000560KR

3M 966 Chamber Test Site					
Equipment	Manufacturer	Model	Serial Number	Cal Date	Cal Due
Band Reject Filters	MICRO TRONICS	BRM 50702	120	02/08/2021	02/07/2022
Bilog Antenna	Sunol Sciences	JB3	A030105	07/19/2021	07/18/2022
Coaxial Cable	HUBER SUHNER	SUCOFLEX 104PEA	20995	02/24/2021	02/23/2022
Coaxial Cable	EMCI	EMC105	190914+327109/4	09/17/2021	09/16/2022
Digital Thermo-Hygro Meter	WISEWIND	1206	D07	01/06/2021	01/05/2022
Horn Antenna	ETS LINDGREN	3116	00026370	12/11/2020	12/10/2021
Horn Antenna	ETS LINDGREN	3117	00055165	07/29/2021	07/28/2022
K Type Cable	Huber+Suhner	SUCOFLEX 102	29406/2	12/09/2020	12/08/2021
K Type Cable	Huber+Suhner	SUCOFLEX 102	22470/2	12/09/2020	12/08/2021
Pre-Amplifier	EMEC	EM330	060609	02/24/2021	02/23/2022
Pre-Amplifier	HP	8449B	3008A00965	12/25/2020	12/24/2021
Pre-Amplifier	MITEQ	AMF-6F-18004000-37-8P	985646	09/08/2021	09/07/2022
PSA Series Spectrum Analyzer	Agilent	E4446A	US42510268	09/23/2021	09/22/2022
Antenna Tower	CCS	CC-A-1F	N/A	N.C.R	N.C.R
Controller	CCS	CC-C-1F	N/A	N.C.R	N.C.R
Turn Table	CCS	CC-T-1F	N/A	N.C.R	N.C.R
Software	e3 6.11-20180413				

Remark: Each piece of equipment is scheduled for calibration once a year.

Report No.: TMWK2109000560KR

1.8 SUPPORT AND EUT ACCESSORIES EQUIPMENT

EUT Accessories Equipment					
No.	Equipment	Brand	Model	Series No.	FCC ID
	N/A				

Support Equipment						
No.	Equipment	Brand	Model	Series No.	FCC ID	IC
1	NB(G)	Lenovo	IBM 1951	N/A	CJ6UPA3489WL	N/A
2	NB(J)	TOSHIBA	PT345T-00L002	N/A	PD97260H	1000M-7260H

1.9 TEST METHODOLOGY AND APPLIED STANDARDS

The test methodology, setups and results comply with all requirements in accordance with ANSI C63.10:2013, FCC Part 2, FCC Part 15.247, RSS-247 Issue 2 and RSS-GEN Issue 5.

Report No.: TMWK2109000560KR

2. TEST SUMMARY

FCC Standard Section	IC Standard Section	Report Section	Test Item	Result
15.203	RSS-Gen 6.8	1.3	Antenna Requirement	Pass
15.207(a)	RSS-GEN 8.8	4.1	AC Conducted Emission	Pass
15.247(a)(1)	RSS-247(5.1)(a)	4.2	20 dB Bandwidth	Pass
-	RSS-GEN 6.7	4.2	Occupied Bandwidth (99%)	Pass
15.247(b)(1)	RSS-247(5.4)(b)	4.3	Output Power Measurement	Pass
15.247(a)(1)	RSS-247(5.1)(b)	4.4	Frequency Separation	Pass
15.247(a)(1)(iii)	RSS-247(5.1)(d)	4.5	Number of Hopping	Pass
15.247(d)	RSS-247(5.5)	4.6	Conducted Band Edge	Pass
15.247(d)	RSS-247(5.5)	4.6	Conducted Spurious Emission	Pass
15.247(a)(1)(iii)	RSS-247(5.1)(d)	4.7	Time of Occupancy	Pass
15.247(d)	RSS-GEN 8.9, 8.10	4.8	Radiation Band Edge	Pass
15.247(d)	RSS-GEN 8.9, 8.10	4.8	Radiation Spurious Emission	Pass

Report No.: TMWK2109000560KR

3. DESCRIPTION OF TEST MODES

3.1 THE WORST MODE OF OPERATING CONDITION

Operation mode	GFSK for BDR-1Mbps (DH5) $\pi/4$ -DQPSK for EDR-2Mbps (2DH5) 8DPSK for EDR-3Mbps (3DH5)
Test Channel Frequencies	<p>GFSK for BDR-1Mbps: 1.Lowest Channel: 2402MHz 2.Middle Channel: 2441MHz 3.Highest Channel: 2480MHz</p> <p>$\pi/4$-DQPSK for EDR-2Mbps (2DH5) 1.Lowest Channel: 2402MHz 2.Middle Channel: 2441MHz 3.Highest Channel: 2480MHz</p> <p>8DPSK for EDR-3Mbps: 1.Lowest Channel: 2402MHz 2.Middle Channel: 2441MHz 3.Highest Channel: 2480MHz</p>

Remark:

1. EUT pre-scanned data rate of output power for each mode, the worst data rate were recorded in this report.
2. For EDR-2/3Mbps, because the characteristics are the same, so choose the high power as a hopping test.

Report No.: TMWK2109000560KR

3.2 THE WORST MODE OF MEASUREMENT

AC Power Line Conducted Emission	
Test Condition	AC Power line conducted emission for line and neutral
Power supply Mode	Mode 1: EUT power by Host System
Worst Mode	<input checked="" type="checkbox"/> Mode 1 <input type="checkbox"/> Mode 2 <input type="checkbox"/> Mode 3 <input type="checkbox"/> Mode 4

Radiated Emission Measurement Above 1G	
Test Condition	Radiated Emission Above 1G
Power supply Mode	Mode 1: EUT power by Host System
Worst Mode	<input checked="" type="checkbox"/> Mode 1 <input type="checkbox"/> Mode 2 <input type="checkbox"/> Mode 3 <input type="checkbox"/> Mode 4
Worst Position	<input type="checkbox"/> Placed in fixed position. <input checked="" type="checkbox"/> Placed in fixed position at X-Plane (E2-Plane) <input type="checkbox"/> Placed in fixed position at Y-Plane (E1-Plane) <input type="checkbox"/> Placed in fixed position at Z-Plane (H-Plane)

Radiated Emission Measurement Below 1G	
Test Condition	Radiated Emission Below 1G
Power supply Mode	Mode 1: EUT power by Host System
Worst Mode	<input checked="" type="checkbox"/> Mode 1 <input type="checkbox"/> Mode 2 <input type="checkbox"/> Mode 3 <input type="checkbox"/> Mode 4

Remark:

- 1. The worst mode was record in this test report.*
- 2. EUT pre-scanned in three axis ,X,Y, Z and two polarity, for radiated measurement. The worst case(X-Plane) were recorded in this report*
- 3. AC power line conducted emission and for below 1G radiation emission were performed the EUT transmit at the highest output power channel as worse case.*

Report No.: TMWK2109000560KR

3.3 EUT DUTY CYCLE

Temperature: 23.6°C

Humidity: 58% RH

Tested by: Lance Chen

Test date: September 28, 2021

For GFSK (1Mbps)

PACKET TYPE	Duty Cycle (%) = Ton / (Ton+Toff)	Duty Factor (dB) =10*log (1/Duty Cycle)	1/T (kHz)	VBW setting (kHz)
DH1	31.02	5.08	2.63	3.00
DH3	66.13	1.80	0.61	1.00
DH5	77.11	1.13	0.35	1.00

For π/4 DQPSK (2Mbps)

PACKET TYPE	Duty Cycle (%) = Ton / (Ton+Toff)	Duty Factor (dB) =10*log (1/Duty Cycle)	1/T (kHz)	VBW setting (kHz)
2DH1	31.58	5.01	2.56	3.00
2DH3	66.13	1.80	0.61	1.00
2DH5	77.11	1.13	0.35	1.00

For 8-DPSK (3Mbps)

PACKET TYPE	Duty Cycle (%) = Ton / (Ton+Toff)	Duty Factor (dB) =10*log (1/Duty Cycle)	1/T (kHz)	VBW setting (kHz)
3DH1	31.58	5.01	2.56	3.00
3DH3	65.73	1.82	0.61	1.00
3DH5	77.51	1.11	0.35	1.00

Report No.: TMWK2109000560KR

For GFSK (1Mbps)



Report No.: TMWK2109000560KR

For $\pi/4$ DQPSK (2Mbps)



Report No.: TMWK2109000560KR

For 8-DPSK (3Mbps)



Report No.: TMWK2109000560KR

4. TEST RESULT

4.1 AC POWER LINE CONDUCTED EMISSION

4.1.1 Test Limit

According to §15.207(a) and RSS-GEN section 8.8,

Frequency Range (MHz)	Limits(dBμV)	
	Quasi-peak	Average
0.15 to 0.50	66 to 56*	56 to 46*
0.50 to 5	56	46
5 to 30	60	50

* Decreases with the logarithm of the frequency.

4.1.2 Test Procedure

Test method Refer as ANSI C63.10: 2013 clause 6.2,

1. The EUT was placed on a non-conducted table, which is 0.8m above horizontal ground plane and 0.4m above vertical ground plane.
2. EUT connected to the line impedance stabilization network (LISN)
3. Receiver set RBW of 9kHz and Detector Peak, and note as quasi-peak and average.
4. Maximum procedure was performed on the six highest emissions to ensure EUT compliance.
5. Recorded Line for Neutral and Line.

4.1.3 Test Setup

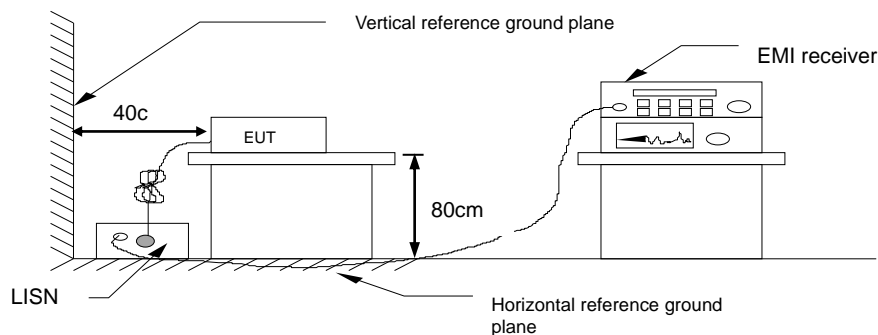

4.1.4 Test Result

PASS

Report No.: TMWK2109000560KR

Test Data

Test Mode:	Mode 1	Temp/Hum	24.6(°C)/ 51%RH
Phase:	Line	Test Date	September 28, 2021
		Test Engineer	Jack Chen

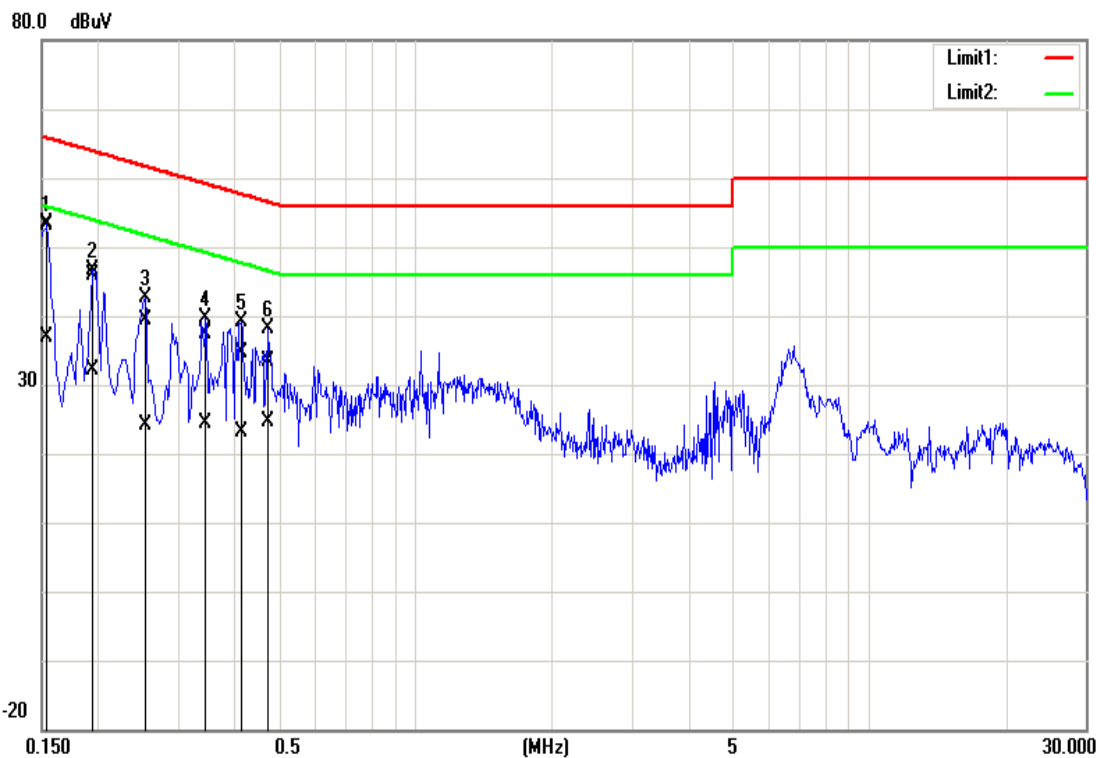

Frequency (MHz)	Quasi Peak reading (dBuV)	Average reading (dBuV)	Correction factor (dB)	Quasi Peak result (dBuV)	Average result (dBuV)	Quasi Peak limit (dBuV)	Average limit (dBuV)	Quasi Peak margin (dB)	Average margin (dB)	Remark
0.1540	42.86	26.65	10.29	53.15	36.94	65.78	55.78	-12.63	-18.84	Pass
0.1940	35.55	21.74	10.29	45.84	32.03	63.86	53.86	-18.02	-21.83	Pass
0.2540	29.04	13.91	10.29	39.33	24.20	61.63	51.63	-22.30	-27.43	Pass
0.3460	27.06	14.13	10.29	37.35	24.42	59.06	49.06	-21.71	-24.64	Pass
0.4140	24.32	12.83	10.29	34.61	23.12	57.57	47.57	-22.96	-24.45	Pass
0.4740	23.06	14.24	10.29	33.35	24.53	56.44	46.44	-23.09	-21.91	Pass

Note: Correction factor = LISN loss + Cable loss.

Report No.: TMWK2109000560KR

Test Mode:	Mode 1	Temp/Hum	24.6(°C)/ 51%RH
Phase:	Neutral	Test Date	September 28, 2021
		Test Engineer	Jack Chen



Frequency (MHz)	Quasi Peak reading (dBuV)	Average reading (dBuV)	Correction factor (dB)	Quasi Peak result (dBuV)	Average result (dBuV)	Quasi Peak limit (dBuV)	Average limit (dBuV)	Quasi Peak margin (dB)	Average margin (dB)	Remark
0.1540	42.50	24.38	10.29	52.79	34.67	65.78	55.78	-12.99	-21.11	Pass
0.1940	35.59	21.35	10.29	45.88	31.64	63.86	53.86	-17.98	-22.22	Pass
0.3380	24.61	14.63	10.29	34.90	24.92	59.25	49.25	-24.35	-24.33	Pass
0.4260	22.24	13.08	10.29	32.53	23.37	57.33	47.33	-24.80	-23.96	Pass
0.4500	23.23	14.81	10.29	33.52	25.10	56.88	46.88	-23.36	-21.78	Pass
0.4700	21.72	13.11	10.29	32.01	23.40	56.51	46.51	-24.50	-23.11	Pass

Note: Correction factor = LISN loss + Cable loss.

Report No.: TMWK2109000560KR

4.2 20dB BANDWIDTH AND OCCUPIED BANDWIDTH (99%)

4.2.1 Test Limit

According to §15.247(a) (1), RSS-247 section 5.1(a) and RSS-GEN 6.7,

20 dB Bandwidth : For reporting purposes only.

Occupied Bandwidth(99%) : For reporting purposes only.

4.2.2 Test Procedure

Test method Refer as ANSI C63.10: 2013 clause 7.8.7,

1. The EUT RF output connected to the spectrum analyzer by RF cable.
2. Setting maximum power transmit of EUT
3. SA set RBW = 1% ~ 5% OBW, VBW $\geq 3 \times$ RBW and Detector = Peak, to measurement 20 dB Bandwidth.
4. SA set RBW = 1% ~ 5% OBW, VBW \geq three times the RBW and Detector = Peak, to measurement 99% Bandwidth
5. Measure and record the result of 20 dB Bandwidth and 99% Bandwidth. in the test report.

4.2.3 Test Setup

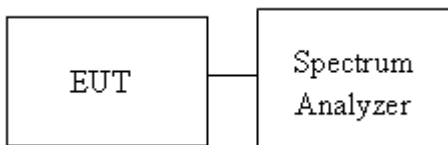

Report No.: TMWK2109000560KR

4.2.4 Test Result

Temperature: 23.6°C

Humidity: 58% RH

Tested by: Lance Chen

Test date: September 28, 2021

Test mode: GFSK_BDR-1Mbps mode / 2402-2480 MHz			
Channel	Frequency (MHz)	OBW(99%) (MHz)	20dB BW (MHz)
Low	2402	0.86032	0.9612
Mid	2441	0.85734	0.9605
High	2480	0.85606	0.9602

Test mode: $\pi/4$ -DQPSK_EDR -2Mbps mode / 2402-2480 MHz			
Channel	Frequency (MHz)	OBW(99%) (MHz)	20dB BW (MHz)
Low	2402	1.1557	1.275
Mid	2441	1.1576	1.275
High	2480	1.1566	1.277

Test mode: 8DPSK_EDR-3Mbps mode / 2402-2480 MHz			
Channel	Frequency (MHz)	OBW(99%) (MHz)	20dB BW (MHz)
Low	2402	1.1588	1.295
Mid	2441	1.1604	1.293
High	2480	1.1593	1.294

Report No.: TMWK2109000560KR

Test Data

20dB BANDWIDTH

GFSK_BDR-1Mbps mode

Low CH

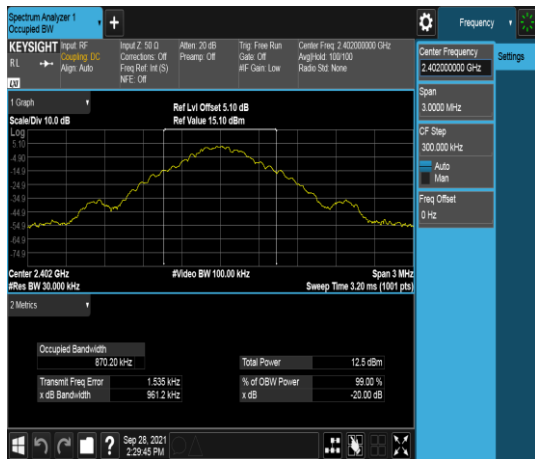

Mid CH

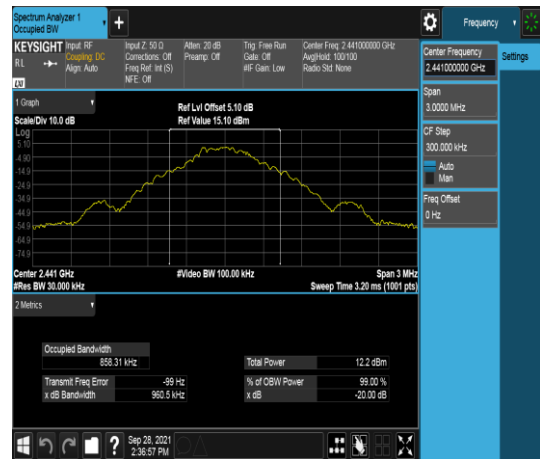

High CH

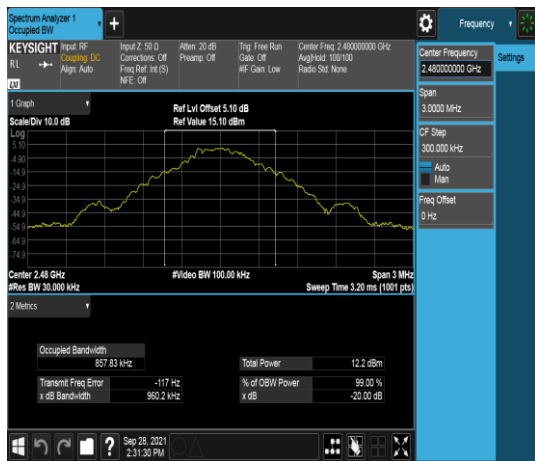

Report No.: TMWK2109000560KR

π/4-DQPSK_EDR -2Mbps mode

Low CH



Mid CH

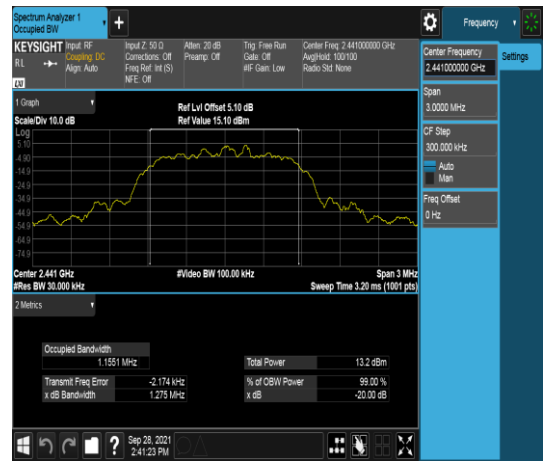

High CH

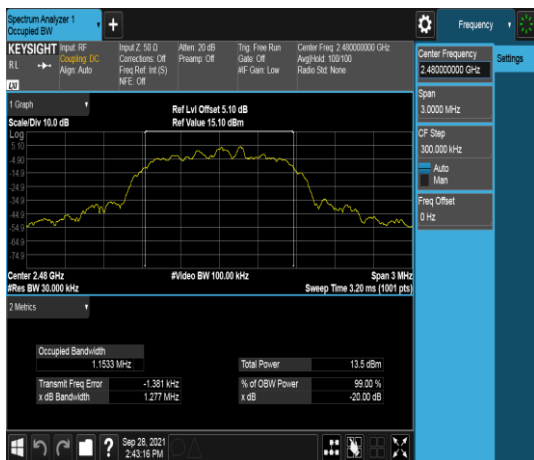

Report No.: TMWK2109000560KR

8DPSK_EDR-3Mbps mode

Low CH

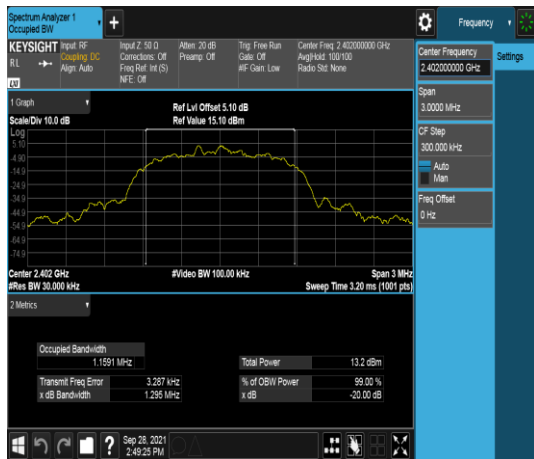

Mid CH

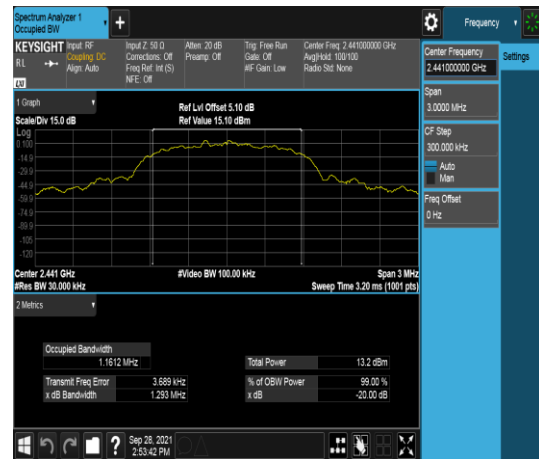

High CH

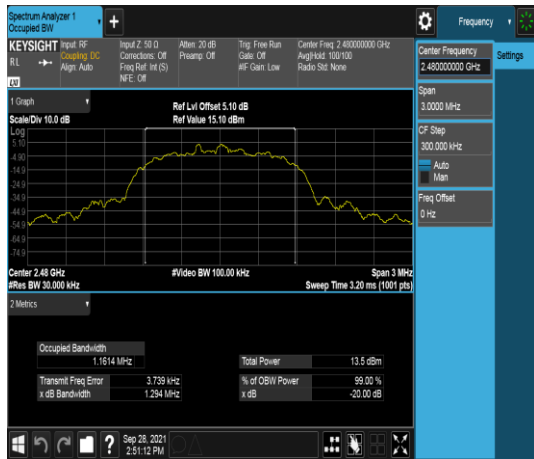

Report No.: TMWK2109000560KR

Test Data

BANDWIDTH 99%

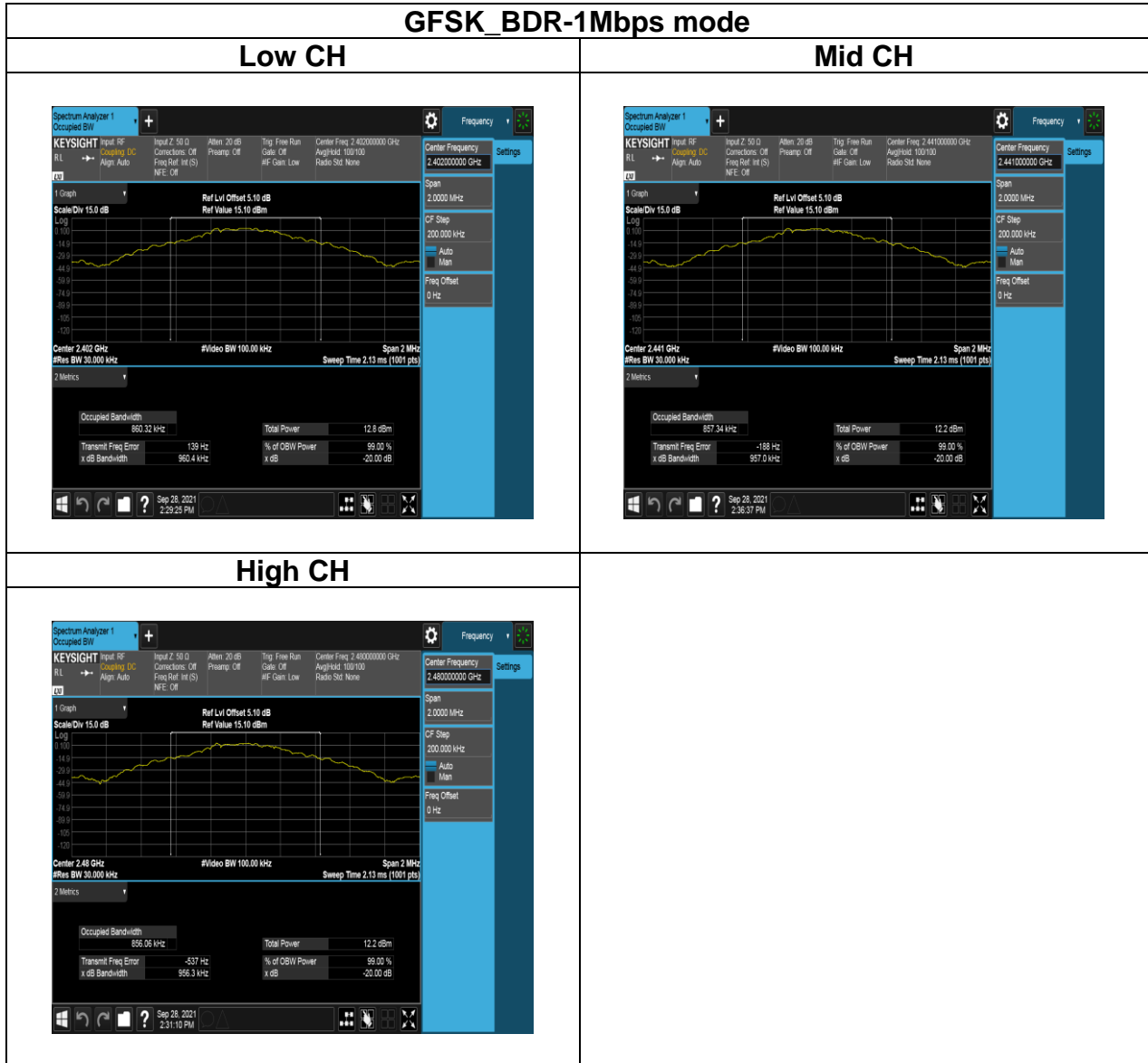

Report No.: TMWK2109000560KR

π/4-DQPSK_EDR -2Mbps mode

Low CH

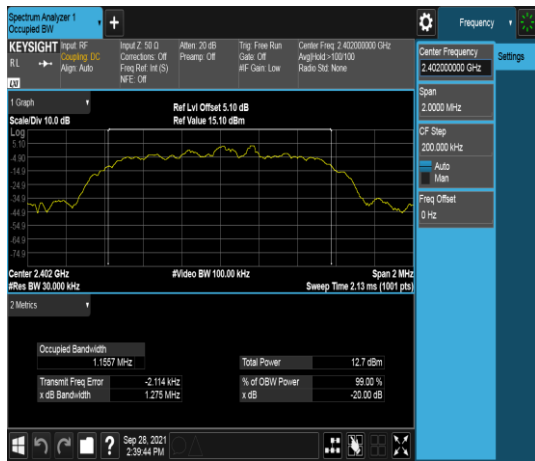

Mid CH

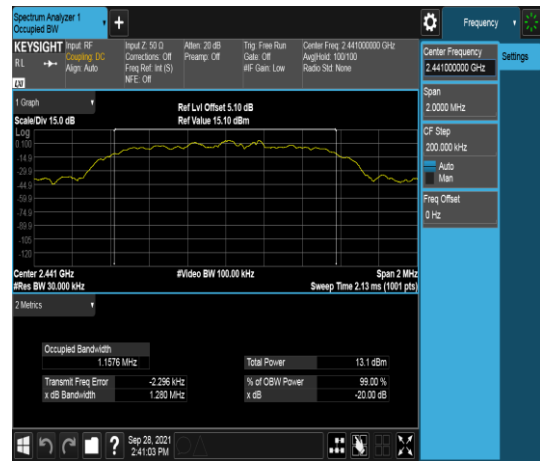

High CH

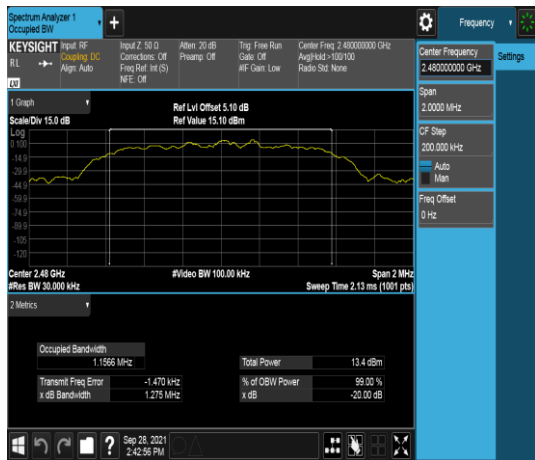

Report No.: TMWK2109000560KR

8DPSK_EDR-3Mbps mode

Low CH

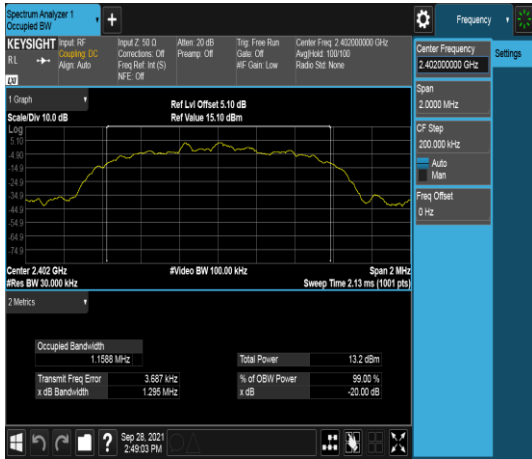

Mid CH

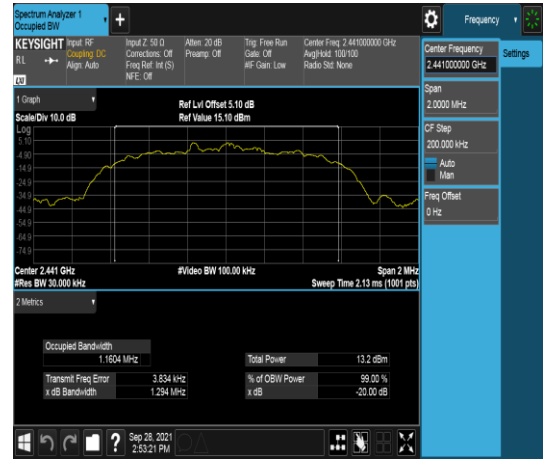

High CH

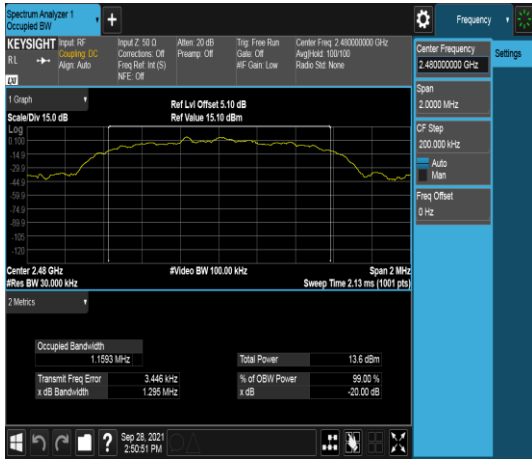

Report No.: TMWK2109000560KR

4.3 OUTPUT POWER MEASUREMENT

4.3.1 Test Limit

According to §15.247(a)(1) and RSS-247 section 5.4(b)

Peak output power :

FCC

Alternatively, frequency hopping systems operating in the 2400-2483.5 MHz band may have hopping channel carrier frequencies that are separated by 25 kHz or two-thirds of the 20 dB bandwidth of the hopping channel, whichever is greater, provided the systems operate with an output power no greater than 125 mW.

IC

According to RSS-247 section 5.4(b), For FHSs operating in the band 2400-2483.5 MHz, the maximum peak conducted output power shall not exceed 1.0 W if the hopset uses 75 or more hopping channels; the maximum peak conducted output power shall not exceed 0.125 W if the hopset uses less than 75 hopping channels. The e.i.r.p. shall not exceed 4 W, except as provided in section 5.4(e).

Limit	<input checked="" type="checkbox"/> Antenna not exceed 6 dBi : 21dBm <input type="checkbox"/> Antenna with DG greater than 6 dBi : 21dBm [Limit = 30 – (DG – 6)]
-------	--

Average output power : For reporting purposes only.

4.3.2 Test Procedure

1. The EUT RF output connected to the power meter by RF cable.
2. Setting maximum power transmit of EUT.
3. The path loss was compensated to the results for each measurement.
4. Measure and record the result of Peak output power and Average output power. in the test report.

4.3.3 Test Setup

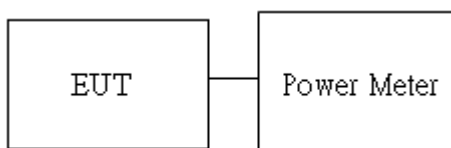

Report No.: TMWK2109000560KR

4.3.4 Test Result

Temperature: 23.6°C

Humidity: 58% RH

Tested by: Lance Chen

Test date: September 28, 2021

Peak output power :

1M BR mode (Peak):

CH	Freq. (MHz)	Power set	Peak Output Power (dBm)	Output Power (mW)	Limit (mW)
Low	2402	default	6.54	4.508	125
Mid	2441	default	5.80	3.802	125
High	2480	default	5.97	3.954	125

2M EDR mode (Peak):

CH	Freq. (MHz)	Power set	Peak Output Power (dBm)	Output Power (mW)	Limit (mW)
Low	2402	default	8.01	6.324	125
Mid	2441	default	7.63	5.794	125
High	2480	default	8.50	7.079	125

3M EDR mode (Peak):

CH	Freq. (MHz)	Power set	Peak Output Power (dBm)	Output Power (mW)	Limit (mW)
Low	2402	default	8.53	7.129	125
Mid	2441	default	8.25	6.683	125
High	2480	default	8.57	7.194	125

Report No.: TMWK2109000560KR

Average output power :
1M BR mode (Average):

CH	Freq. (MHz)	Power set	Max. Avg.Output include tune up tolerance Power (dBm)	Output Power (mW)	Limit (mW)
Low	2402	default	5.90	3.889	125
Mid	2441	default	5.72	3.732	125
High	2480	default	5.67	3.689	125

2M EDR mode (Average):

CH	Freq. (MHz)	Power set	Max. Avg.Output include tune up tolerance Power (dBm)	Output Power (mW)	Limit (mW)
Low	2402	default	5.50	3.547	125
Mid	2441	default	5.15	3.273	125
High	2480	default	6.04	4.017	125

3M EDR mode (Average):

CH	Freq. (MHz)	Power set	Max. Avg.Output include tune up tolerance Power (dBm)	Output Power (mW)	Limit (mW)
Low	2402	default	5.45	3.505	125
Mid	2441	default	5.18	3.293	125
High	2480	default	5.59	3.619	125

Report No.: TMWK2109000560KR

EIRP power :

1M BR mode EIRP

Channel	Frequency (MHz)	Power set	Max. Avg. Output include tune up tolerance Power (dBm)	Antenna Gain (dBi)	EIRP (mW)	Limit (mW)
Low	2402	default	5.90	2.93	7.636	4000
Mid	2441	default	5.72	2.93	7.326	4000
High	2480	default	5.67	2.93	7.243	4000

2M EDR mode EIRP

Channel	Frequency (MHz)	Power set	Max. Avg. Output include tune up tolerance Power (dBm)	Antenna Gain (dBi)	EIRP (mW)	Limit (mW)
Low	2402	default	5.50	2.93	6.964	4000
Mid	2441	default	5.15	2.93	6.425	4000
High	2480	default	6.04	2.93	7.887	4000

3M EDR mode EIRP

Channel	Frequency (MHz)	Power set	Max. Avg. Output include tune up tolerance Power (dBm)	Antenna Gain (dBi)	EIRP (mW)	Limit (mW)
Low	2402	default	5.45	2.93	6.881	4000
Mid	2441	default	5.18	2.93	6.466	4000
High	2480	default	5.59	2.93	7.106	4000

Report No.: TMWK2109000560KR

4.4 FREQUENCY SEPARATION

4.4.1 Test Limit

According to §15.247(a)(1) and RSS-247 section 5.1(b)

Alternatively, frequency hopping systems operating in the 2400-2483.5 MHz band may have hopping channel carrier frequencies that are separated by 25 kHz or two-thirds of the 20 dB bandwidth of the hopping channel, whichever is greater, provided the systems operate with an output power no greater than 125 mW.

Limit	> two-thirds of the 20 dB bandwidth
-------	-------------------------------------

4.4.2 Test Procedure

1. Place the EUT on the table and set it in transmitting mode.
2. EUT RF output port connected to the SA by RF cable.
3. Set the spectrum analyzer as RBW = 300kHz, VBW = 300kHz, Sweep = auto.
Max hold, mark 3 peaks of hopping channel and record the 3 peaks frequency

4.4.3 Test Setup

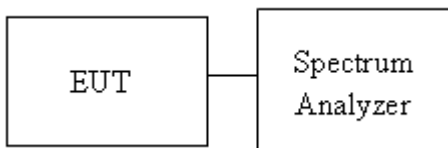

Report No.: TMWK2109000560KR

4.4.4 Test Result

Temperature: 23.6°C

Humidity: 58% RH

Tested by: Lance Chen

Test date: September 28, 2021

Test mode: GFSK_BDR-1Mbps mode / 2402-2480 MHz				
Channel	Frequency (MHz)	Channel Separation (MHz)	Channel Separation Limits (MHz)	Result
Low	2402	1.000	0.64	PASS
Mid	2441	1.000	0.64	PASS
High	2480	1.000	0.64	PASS

Test mode: $\pi/4$ -DQPSK_EDR -2Mbps mode / 2402-2480 MHz				
Channel	Frequency (MHz)	Channel Separation (MHz)	Channel Separation Limits (MHz)	Result
Low	2402	1.000	0.85	PASS
Mid	2441	1.000	0.85	PASS
High	2480	1.000	0.85	PASS

Test mode: 8DPSK_EDR-3Mbps mode / 2402-2480 MHz				
Channel	Frequency (MHz)	Channel Separation (MHz)	Channel Separation Limits (MHz)	Result
Low	2402	1.000	0.86	PASS
Mid	2441	1.000	0.86	PASS
High	2480	1.000	0.86	PASS

Report No.: TMWK2109000560KR

Test Data

GFSK_BDR-1Mbps mode

CH Low



CH Mid

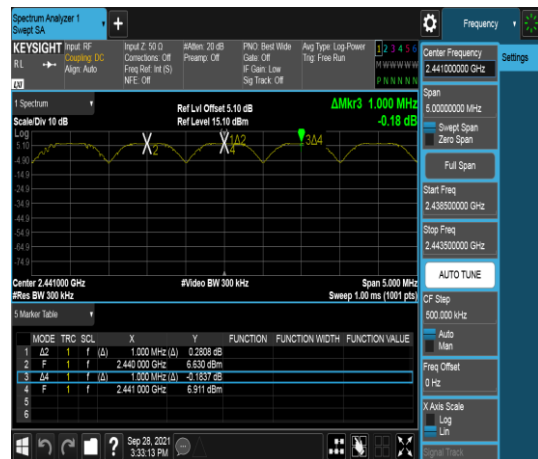

CH High

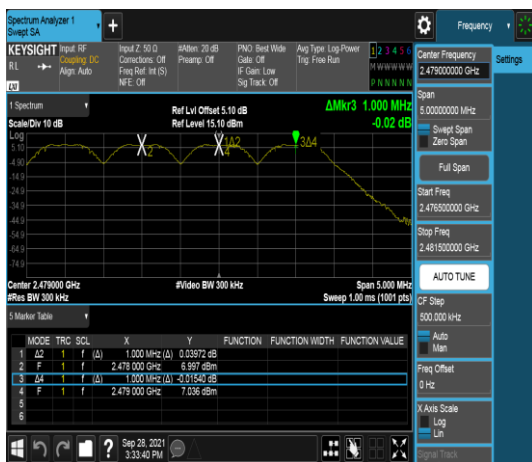

Report No.: TMWK2109000560KR

π/4-DQPSK_EDR -2Mbps mode

CH Low

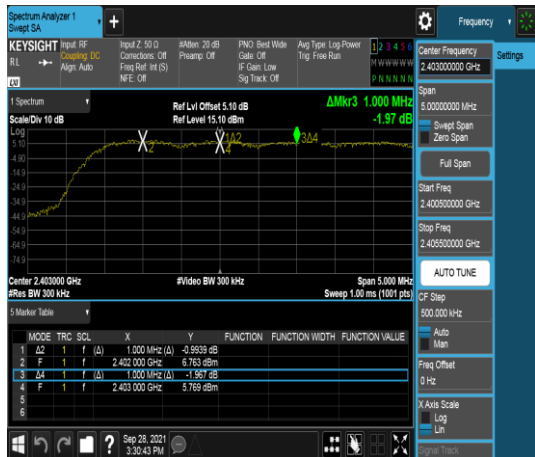

CH Mid

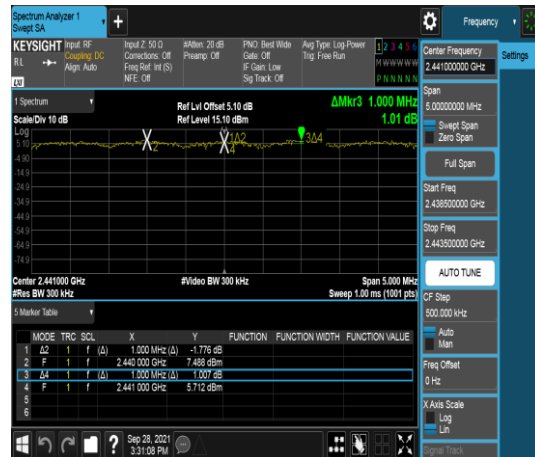

CH High



Report No.: TMWK2109000560KR

8DPSK_EDR-3Mbps mode

CH Low

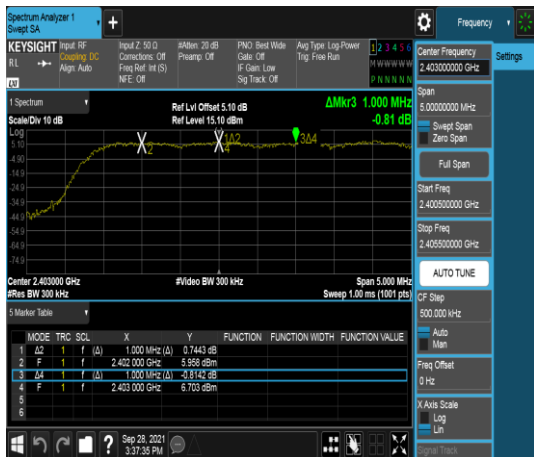

CH Mid

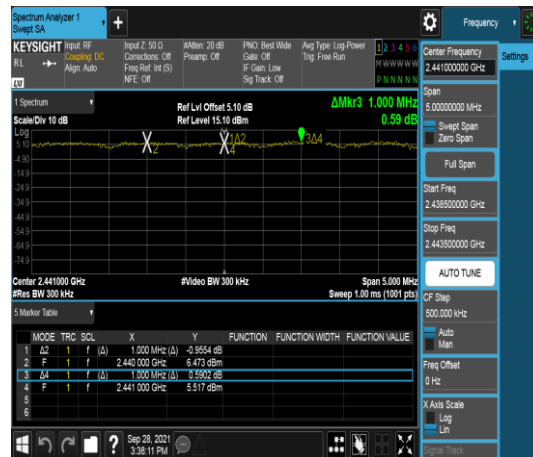

CH High

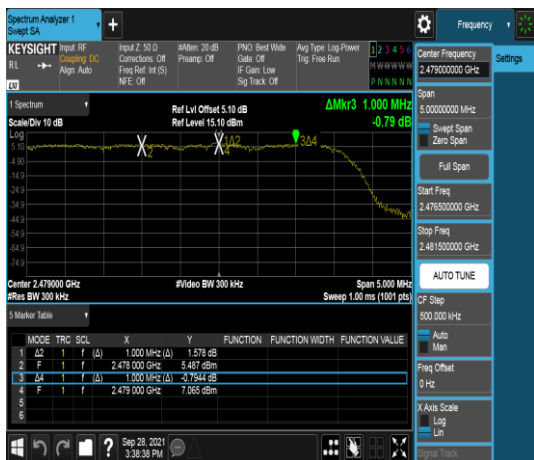

Report No.: TMWK2109000560KR

4.5 NUMBER OF HOPPING

4.5.1 Test Limit

According to §15.247(a)(1)(iii) and RSS-247 section 5.1(d)

Frequency hopping systems in the 2400-2483.5 MHz band shall use at least 15 channels.

4.5.2 Test Procedure

Test method Refer as ANSI C63.10: 2013 clause 7.8.3

1. Place the EUT on the table and set it in transmitting mode.
2. EUT RF output port connected to the SA by RF cable.
3. Set spectrum analyzer Start Freq. = 2400 MHz, Stop Freq. = 2441 MHz for Low range, Start Freq. = 2441 MHz, Stop Freq. = 2483.5 MHz for High range ; RBW=430KHz, VBW = 1.5MHz.
4. Max hold, view and count how many channel in the band.

4.5.3 Test Setup

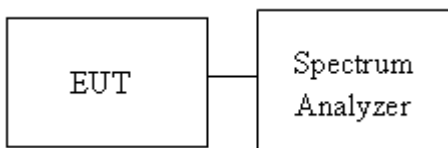

Report No.: TMWK2109000560KR

4.5.4 Test Result

Temperature: 23.6°C **Humidity:** 58% RH
Tested by: Lance Chen **Test date:** September 28, 2021

Number of Hopping				
Mode	Frequency (MHz)	Hopping Channel Number	Hopping Channel Number Limits	Result
BDR-1Mbps	2402-2480	79	15	Pass
EDR-3Mbps	2402-2480	79	15	

Report No.: TMWK2109000560KR

Test Data

Number of Hopping GFSK_BDR-1Mbps mode	
Low	High
8DPSK_EDR-3Mbps mode	
Low	High

Report No.: TMWK2109000560KR

4.6 CONDUCTED BANDEDGE AND SPURIOUS EMISSION

4.6.1 Test Limit

According to §15.247(d) and RSS-247 section 5.5

Limit	-20 dBc
-------	---------

4.6.2 Test Procedure

1. EUT RF output port connected to the SA by RF cable, and the path loss was compensated to result.
2. SA setting, RBW=100kHz, VBW=300kHz, Detector=Peak, Trace mode = max hold, SWT = Auto.
3. The Band Edge at 2.4GHz and 2.4835GHz are investigated with both hopping "ON" and "OFF" modes ".

4.6.3 Test Setup

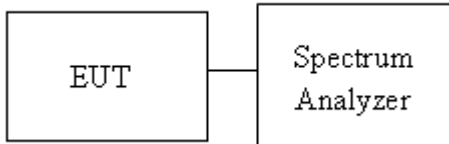

Report No.: TMWK2109000560KR

4.6.4 Test Result

Temperature: 23.6°C

Humidity: 58% RH

Tested by: Lance Chen

Test date: September 28, 2021

Test Data

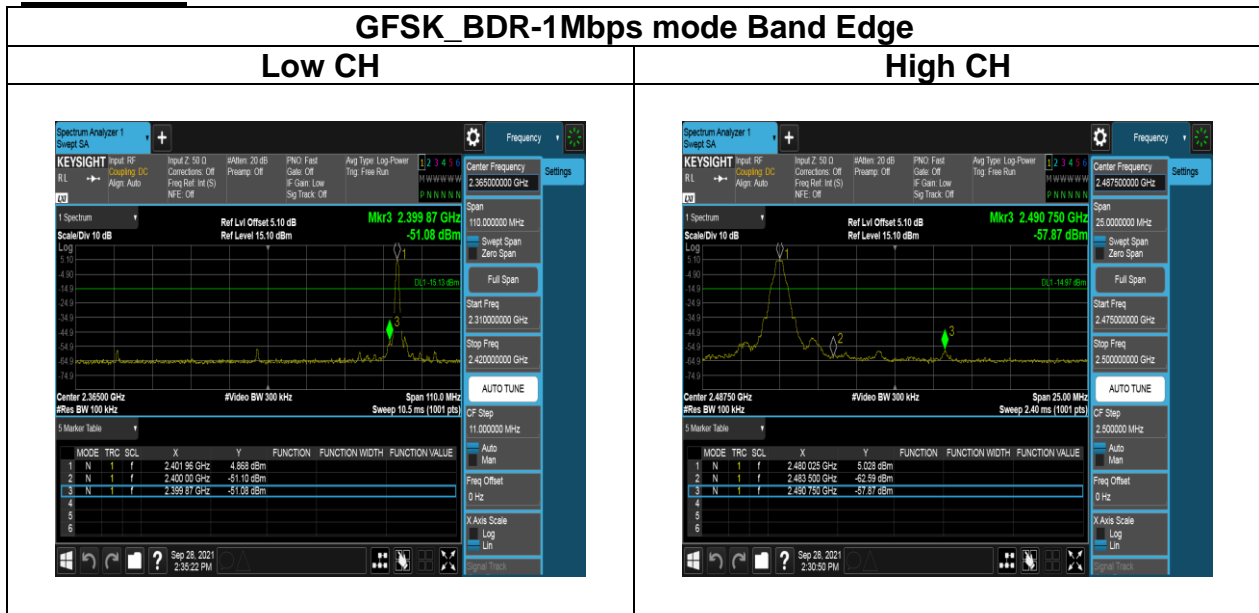

Report No.: TMWK2109000560KR

GFSK_BDR-1Mbps mode Spurious Emission 30MHz-25GHz

Low CH

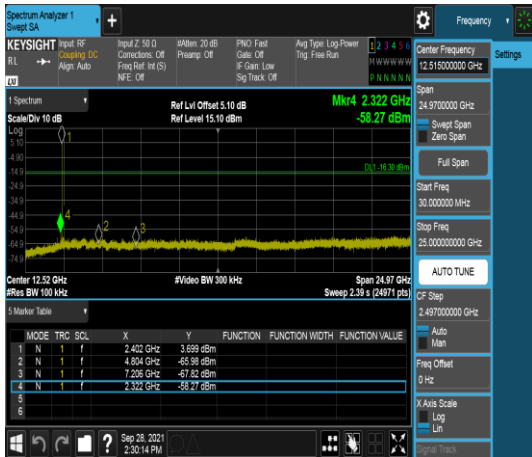

Mid CH

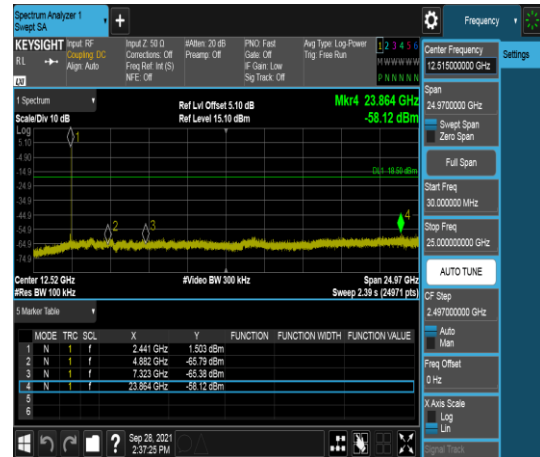

High CH

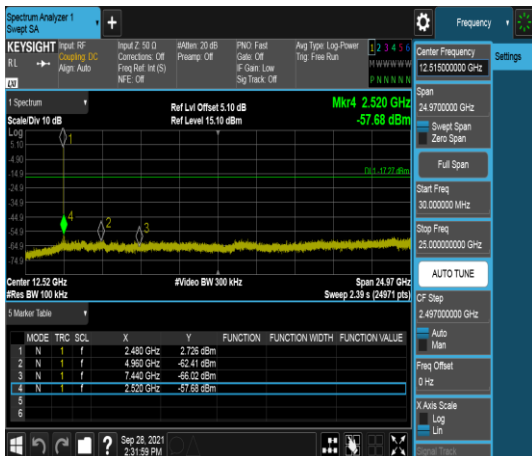

Report No.: TMWK2109000560KR

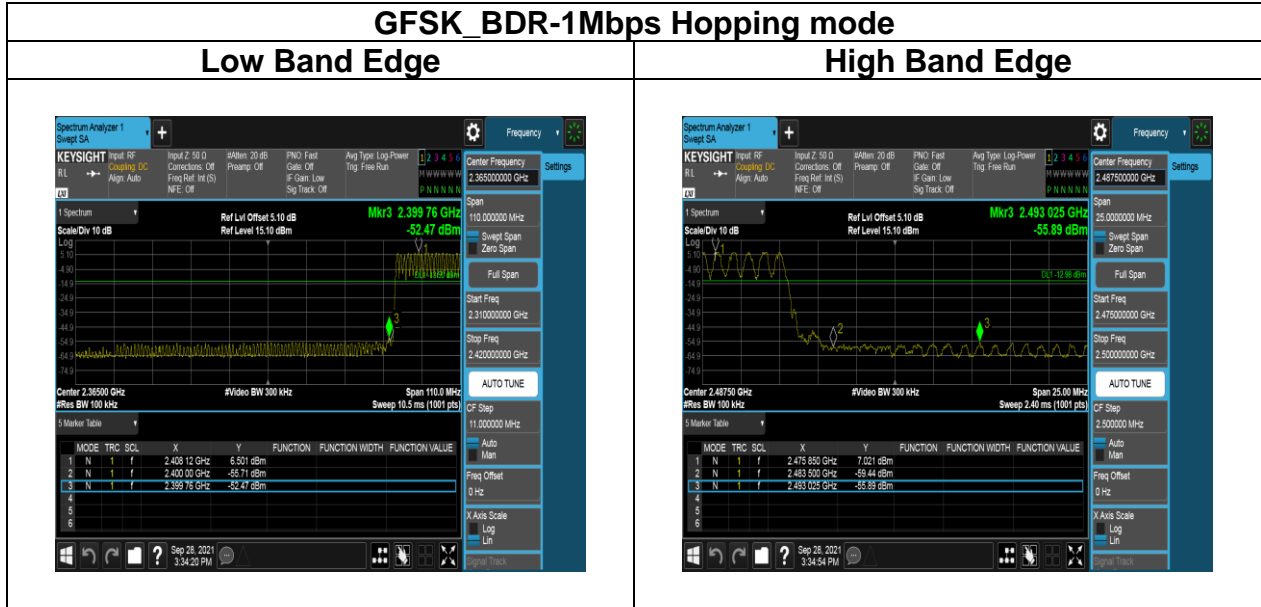

Report No.: TMWK2109000560KR

$\pi/4$ -DQPSK_EDR-2Mbps mode Spurious Emission 30MHz-25GHz

Low CH

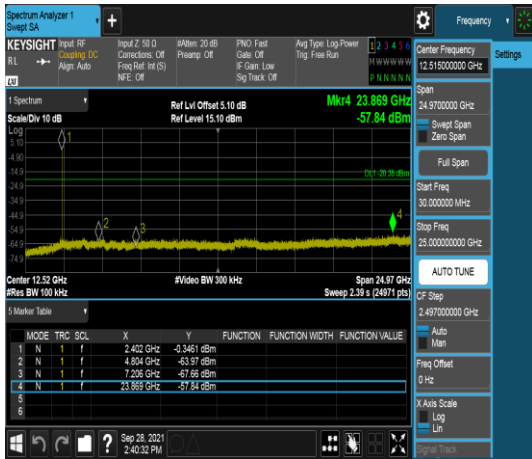

Mid CH

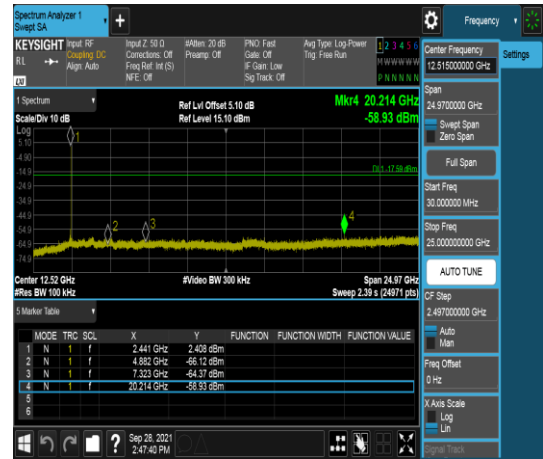

High CH

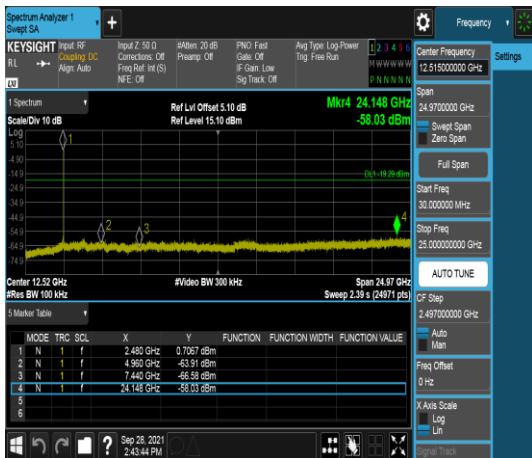

Report No.: TMWK2109000560KR

8DPSK_EDR-3Mbps mode Band Edge

Low CH

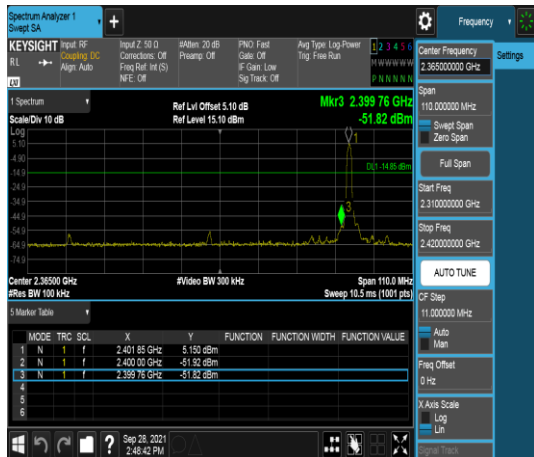

High CH



Report No.: TMWK2109000560KR

8DPSK_EDR-3Mbps mode Spurious Emission 30MHz-25GHz

Low CH

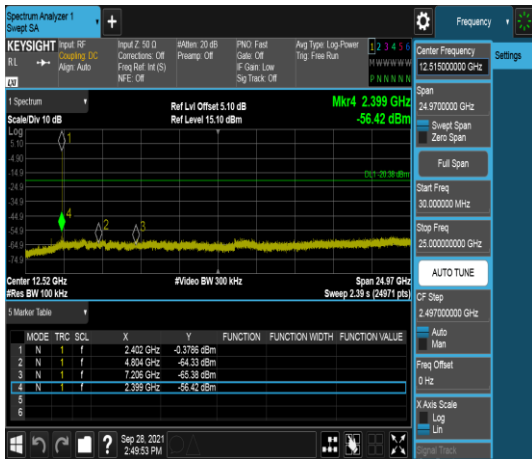

Mid CH



High CH

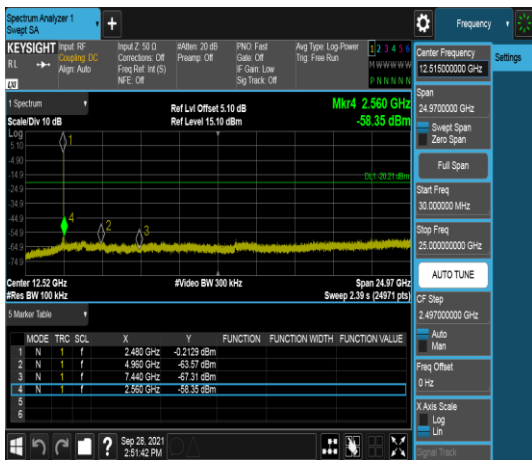

Report No.: TMWK2109000560KR

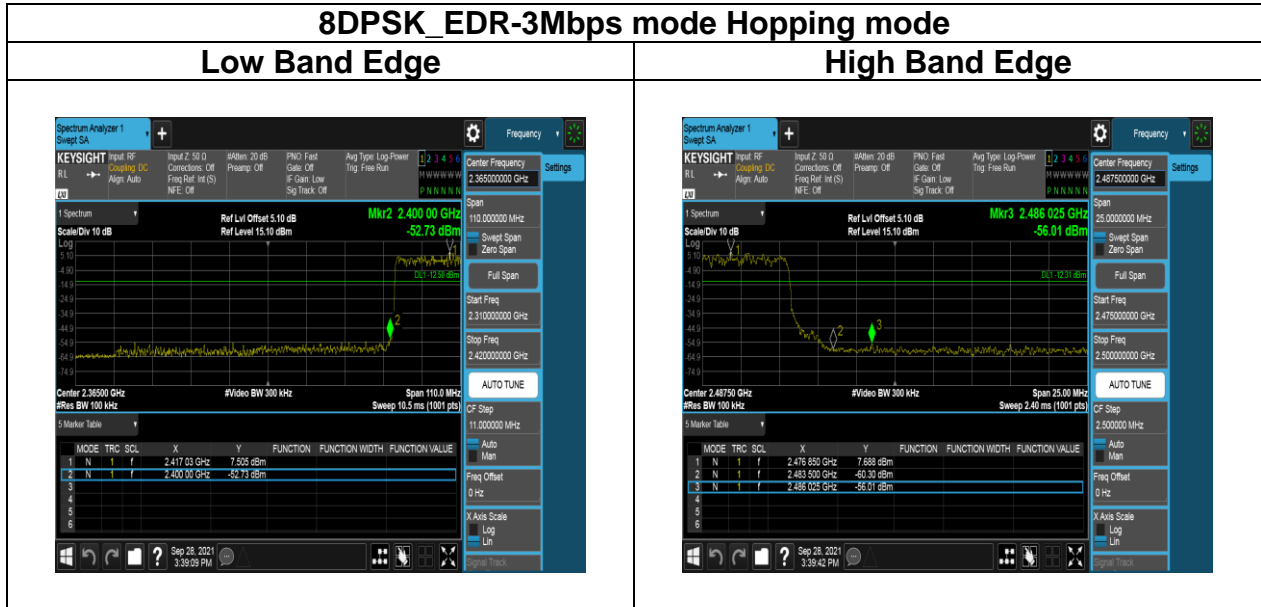

Report No.: TMWK2109000560KR

4.7 TIME OF OCCUPANCY (DWELL TIME)

4.7.1 Test Limit

According to §15.247(a)(1)(iii) and RSS-247 section 5.1(d)

The average time of occupancy on any channel shall not be greater than 0.4 seconds within a period of 0.4 seconds multiplied by the number of hopping channels employed.

4.7.2 Test Procedure

1. EUT RF output port connected to the SA by RF cable.
2. Set center frequency of spectrum analyzer = operating frequency.
3. Set the spectrum analyzer as RBW, VBW=1MHz, Sweep = 1 ms

4.7.3 Test Setup

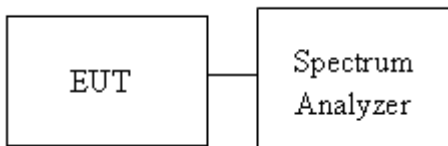

4.7.4 Test Result

Temperature: 23.6°C

Humidity: 58% RH

Tested by: Lance Chen

Test date: September 28, 2021

Report No.: TMWK2109000560KR

For GFSK (1Mbps)

Channel	PACKET TYPE	Measurement Result (ms)	Limit (ms)	1/T (kHz)
Mid	DH1	121.60	400ms	3.00
	DH3	262.40	400ms	1.00
	DH5	307.20	400ms	1.00

CH Mid DH1 time slot = 0.380 * (1600/2/79) * 31.6 = 121.60 (ms)
 DH3 time slot = 1.640 * (1600/4/79) * 31.6 = 262.40 (ms)
 DH5 time slot = 2.880 * (1600/6/79) * 31.6 = 307.20 (ms)

For $\pi/4$ DQPSK (2Mbps)

Channel	PACKET TYPE	Measurement Result (ms)	Limit (ms)	1/T (kHz)
Mid	2DH1	124.80	400ms	3.00
	2DH3	262.40	400ms	1.00
	2DH5	307.20	400ms	1.00

CH Mid 2DH1 time slot = 0.390 * (1600/2/79) * 31.6 = 124.80 (ms)
 2DH3 time slot = 1.640 * (1600/4/79) * 31.6 = 262.40 (ms)
 2DH5 time slot = 2.880 * (1600/6/79) * 31.6 = 307.20 (ms)

For 8-DPSK (3Mbps)

Channel	PACKET TYPE	Measurement Result (ms)	Limit (ms)	1/T (kHz)
Mid	3DH1	124.80	400ms	3.00
	3DH3	260.80	400ms	1.00
	3DH5	308.80	400ms	1.00

CH Mid 3DH1 time slot = 0.390 * (1600/2/79) * 31.6 = 124.80 (ms)
 3DH3 time slot = 1.630 * (1600/4/79) * 31.6 = 260.80 (ms)
 3DH5 time slot = 2.895 * (1600/6/79) * 31.6 = 308.80 (ms)

Report No.: TMWK2109000560KR

For GFSK (1Mbps)



Report No.: TMWK2109000560KR

For $\pi/4$ DQPSK (2Mbps)



Report No.: TMWK2109000560KR

For 8-DPSK (3Mbps)



Report No.: TMWK2109000560KR

4.8 RADIATION BANDEDGE AND SPURIOUS EMISSION

4.8.1 Test Limit

FCC according to §15.247(d), §15.209 and §15.205,

In any 100 kHz bandwidth outside the authorized frequency band, all harmonic and spurious must be least 20 dB below the highest emission level with the authorized frequency band. Radiation emission which fall in the restricted bands must also follow the FCC section 15.209 as below limit in table.

Below 30 MHz

Frequency	Field Strength (microvolts/m)	Magnetic H-Field (microamperes/m)	Measurement Distance (metres)
9-490 kHz	2,400/F (F in kHz)	2,400/F (F in kHz)	300
490-1,705 kHz	24,000/F (F in kHz)	24,000/F (F in kHz)	30
1.705-30 MHz	30	N/A	30

Above 30 MHz

Frequency (MHz)	Field Strength microvolts/m at 3 metres (watts, e.i.r.p.)	
	Transmitters	Receivers
30-88	100 (3 nW)	100 (3 nW)
88-216	150 (6.8 nW)	150 (6.8 nW)
216-960	200 (12 nW)	200 (12 nW)
Above 960	500 (75 nW)	500 (75 nW)

Remark:

Although these tests were performed other than open area test site, adequate comparison measurements were confirmed against 30 m open are test site. Therefore sufficient tests were made to demonstrate that the alternative site produces results that correlate with the ones of tests made in an open field based on KDB 414788.

Report No.: TMWK2109000560KR

IC according to RSS-247 section 5.5, RSS-Gen, Section 8.9 and 8.10

RSS-Gen Table 3 and Table 5 – General Field Strength Limits for Transmitters and Receivers at Frequencies Above 30 MHz ^(Note)

Frequency (MHz)	Field Strength microvolts/m at 3 metres (watts, e.i.r.p.)	
	Transmitters	Receivers
30-88	100 (3 nW)	100 (3 nW)
88-216	150 (6.8 nW)	150 (6.8 nW)
216-960	200 (12 nW)	200 (12 nW)
Above 960	500 (75 nW)	500 (75 nW)

Note: Measurements for compliance with the limits in table 3 may be performed at distances other than 3 metres, in accordance with Section 6.6.

RSS-Gen Table 6: General Field Strength Limits for Transmitters at Frequencies Below 30 MHz (Transmit)

Frequency	Magnetic field strength (H-Field) (µA/m)	Measurement Distance (m)
9-490 kHz ^{Note}	6.37/F (F in kHz)	300
490-1,705 kHz	63.7/F (F in kHz)	30
1.705-30 MHz	0.08	30

Note: The emission limits for the ranges 9-90 kHz and 110-490 kHz are based on measurements employing a linear average detector.

Report No.: TMWK2109000560KR

4.8.2 Test Procedure

1. The EUT is placed on a turntable, Above 1 GHz is 1.5m and below 1 GHz is 0.8m above ground plane. The EUT Configured un accordance with ANSI C63.10: 2013, and the EUT set in a continuous mode.

2. The turntable shall be rotated for 360 degrees to determine the position of maximum emission level. And EUT is set 3m away from the receiving antenna, which is scanned from 1m to 4m above the ground plane to find out the highest emissions. Measurement are made polarized in both the vertical and the horizontal positions with antenna.

3. Span shall wide enough to full capture the emission measured. The SA from 9kHz to 26.5GHz set to the low, Mid and High channels with the EUT transmit.

Note: No emission found between lowest internal used/generated frequency to 30MHz(9KHz~30MHz)

4. For harmonic, the worst case of output power was BDR-1Mbps. Therefore only BDR-1Mbps record in the report.

5. The SA setting following :

(1) Below 1G : RBW = 100kHz, VBW \geq 3 RBW, Sweep = Auto, Detector = Peak, Trace = Max hold.

(2) Above 1G :

(2.1) For Peak measurement : RBW = 1MHz, VBW \geq 3 RBW, Sweep = Auto, Detector = Peak, Trace = Max hold.

(2.2) For Average measurement : RBW = 1MHz, VBW

·If Duty Cycle \geq 98%, VBW=10Hz.

·If Duty Cycle < 98%, VBW \geq 1/T.

6. Data result

Actual FS=Spectrum Reading Level + Factor

Margin=Actual FS- Limit

Report No.: TMWK2109000560KR

4.8.3 Test Setup

9kHz ~ 30MHz

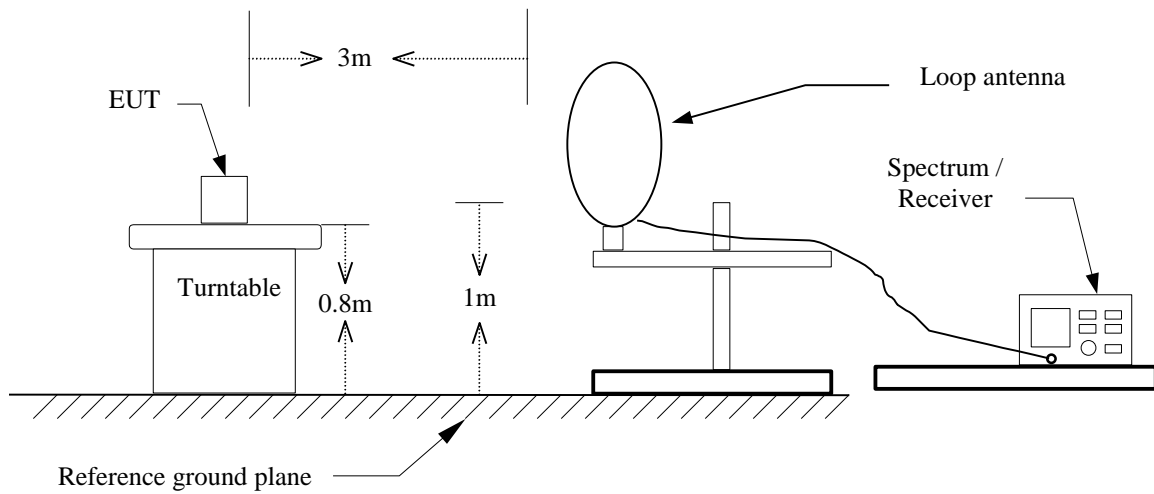

30MHz ~ 1GHz

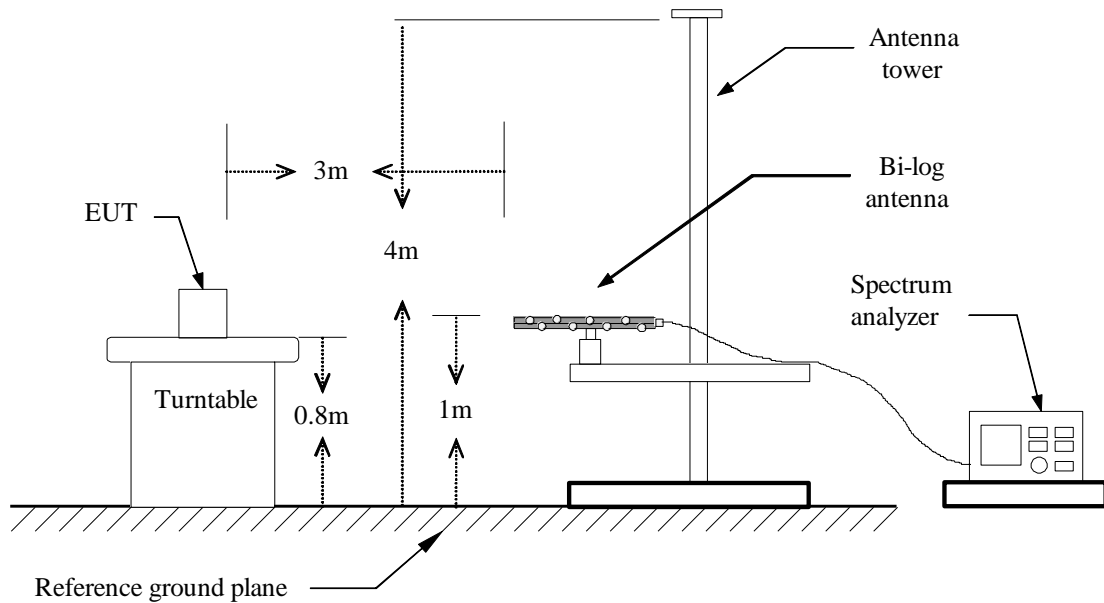

Report No.: TMWK2109000560KR

Above 1 GHz

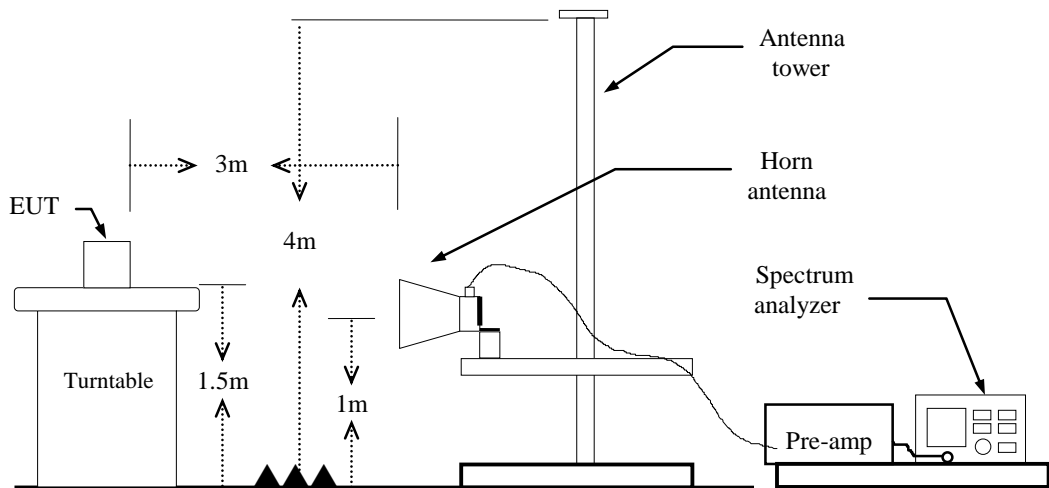

Report No.: TMWK2109000560KR

4.8.4 Test Result

Band Edge Test Data

Test Mode:	GFSK_BDR-1Mbps Low CH	Temp/Hum	22(°C)/ 50%RH
Test Item	Band Edge	Test Date	October 4, 2021
Polarize	Vertical	Test Engineer	Ray Li
Detector	Peak / Average		

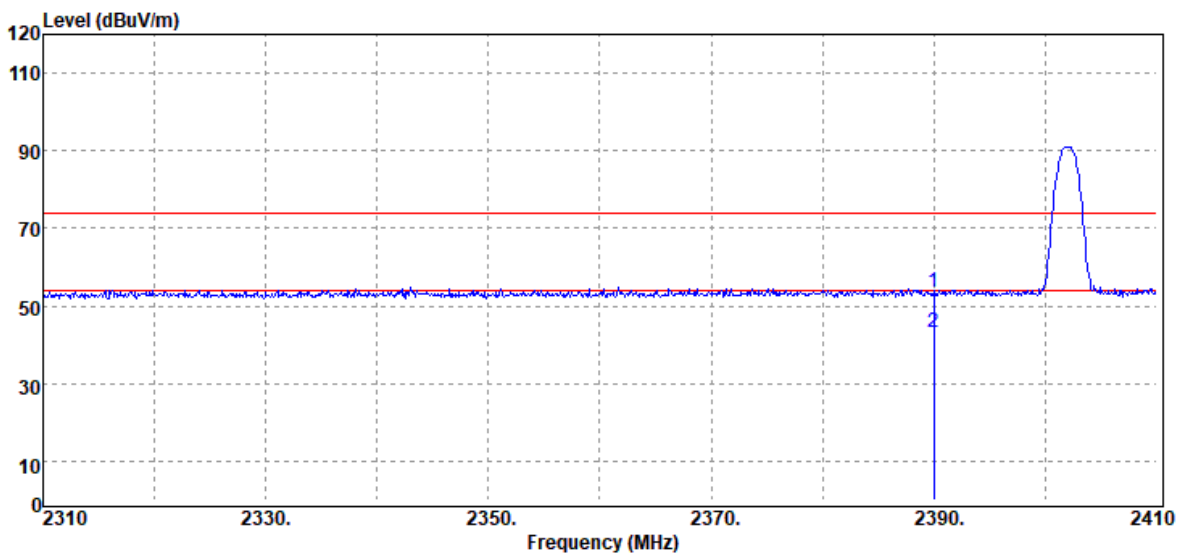

Freq. MHz	Detector Mode PK/QP/AV	Spectrum Reading Level dB μ V	Factor dB	Actual FS dB μ V/m	Limit @3m dB μ V/m	Margin dB
2390.00	Peak	49.68	3.70	53.38	74.00	-20.62
2390.00	Average	39.58	3.70	43.28	54.00	-10.72

Report No.: TMWK2109000560KR

Test Mode:	GFSK_BDR-1Mbps Low CH	Temp/Hum	22(°C)/ 50%RH
Test Item	Band Edge	Test Date	October 4, 2021
Polarize	Horizontal	Test Engineer	Ray Li
Detector	Peak / Average		

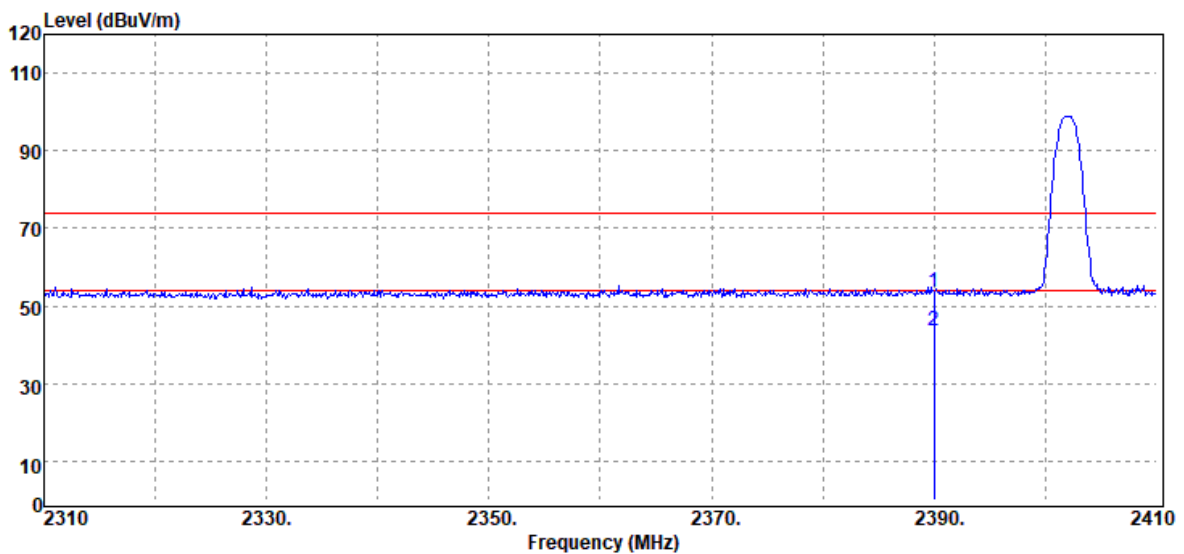

Freq. MHz	Detector Mode PK/QP/AV	Spectrum Reading Level dBμV	Factor dB	Actual FS dBμV/m	Limit @3m dBμV/m	Margin dB
2390.00	Peak	49.67	3.70	53.37	74.00	-20.63
2390.00	Average	39.91	3.70	43.61	54.00	-10.39

Report No.: TMWK2109000560KR

Test Mode:	GFSK_BDR-1Mbps High CH	Temp/Hum	22(°C)/ 50%RH
Test Item	Band Edge	Test Date	October 4, 2021
Polarize	Vertical	Test Engineer	Ray Li
Detector	Peak / Average		

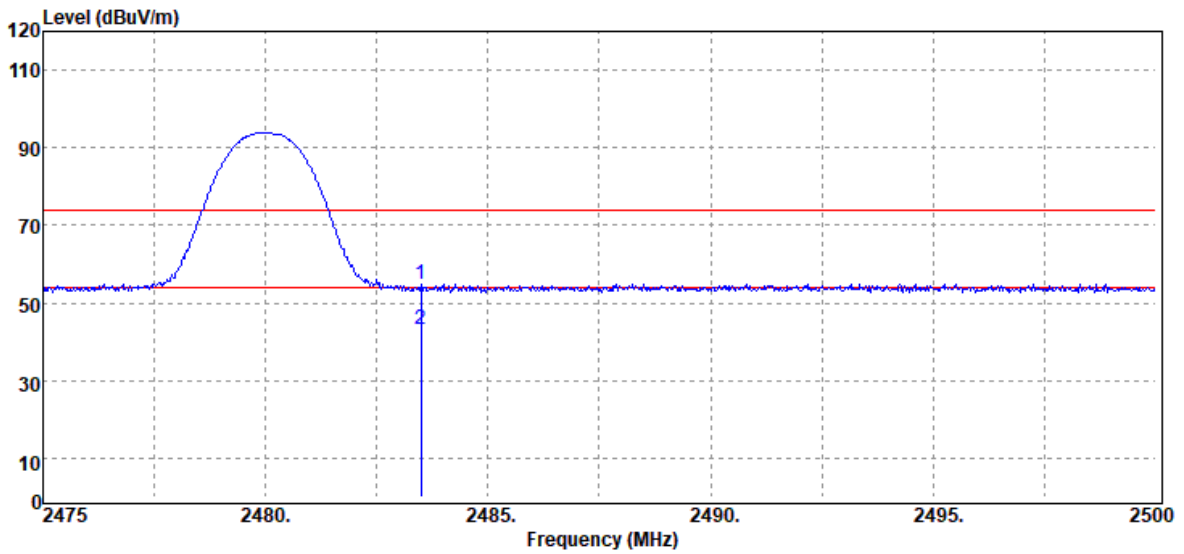

Freq. MHz	Detector Mode PK/QP/AV	Spectrum Reading Level dB μ V	Factor dB	Actual FS dB μ V/m	Limit @3m dB μ V/m	Margin dB
2483.50	Peak	50.61	4.04	54.65	74.00	-19.35
2483.50	Average	39.13	4.04	43.17	54.00	-10.83

Report No.: TMWK2109000560KR

Test Mode:	GFSK_BDR-1Mbps High CH	Temp/Hum	22(°C)/ 50%RH
Test Item	Band Edge	Test Date	October 4, 2021
Polarize	Horizontal	Test Engineer	Ray Li
Detector	Peak / Average		

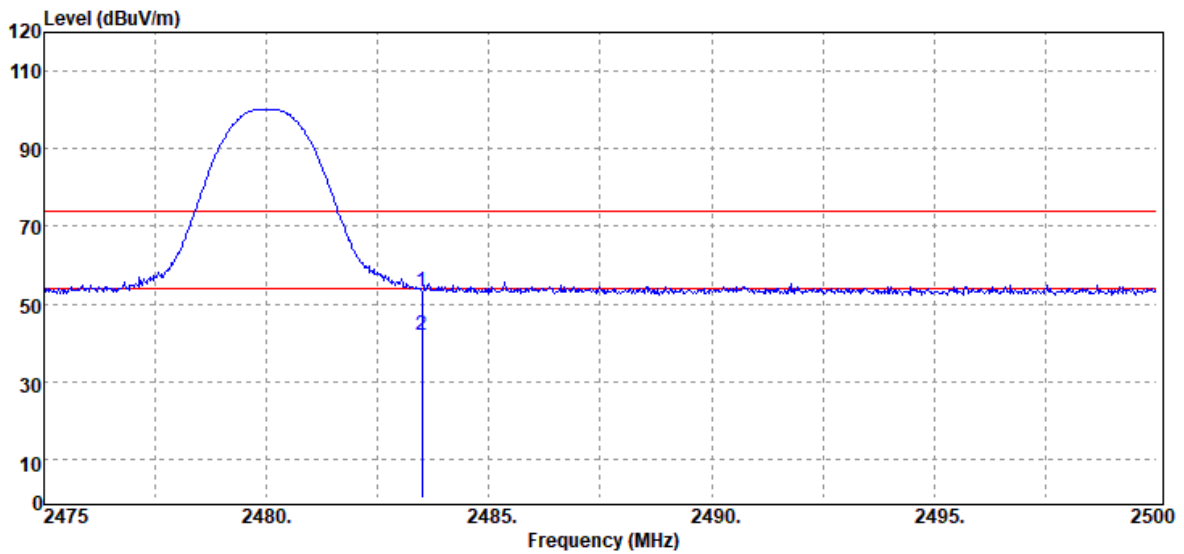

Freq. MHz	Detector Mode PK/QP/AV	Spectrum Reading Level dB μ V	Factor dB	Actual FS dB μ V/m	Limit @3m dB μ V/m	Margin dB
2483.50	Peak	49.04	4.04	53.08	74.00	-20.92
2483.50	Average	37.81	4.04	41.85	54.00	-12.15

Report No.: TMWK2109000560KR

Test Mode:	GFSK_BDR-1Mbps Low CH Hopping	Temp/Hum	22(°C)/ 50%RH
Test Item	Band Edge	Test Date	October 4, 2021
Polarize	Vertical	Test Engineer	Ray Li
Detector	Peak / Average		

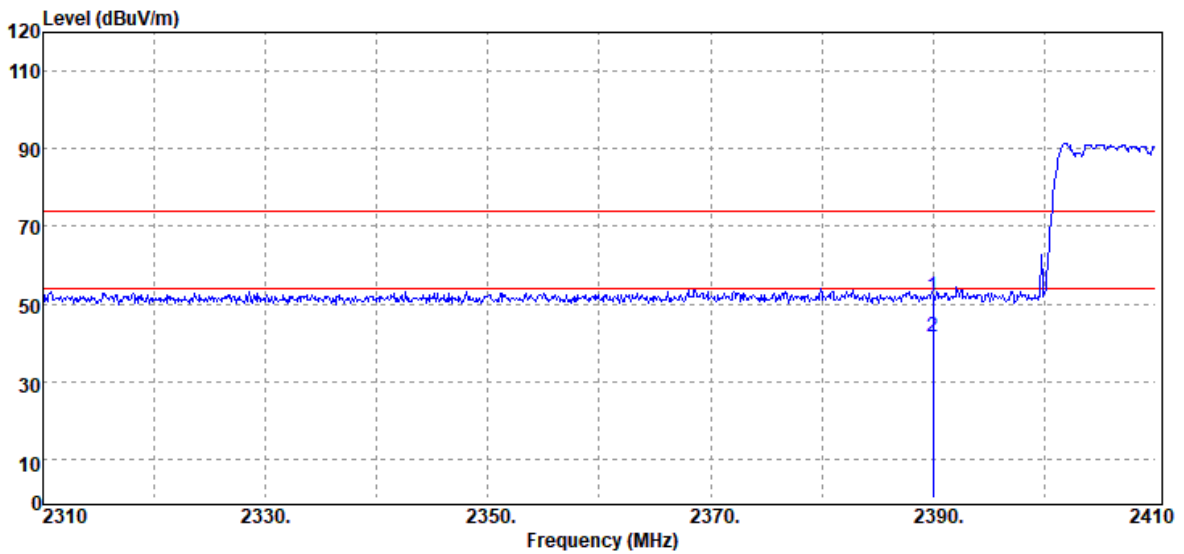

Freq. MHz	Detector Mode PK/QP/AV	Spectrum Reading Level dB μ V	Factor dB	Actual FS dB μ V/m	Limit @3m dB μ V/m	Margin dB
2390.00	Peak	48.36	3.70	52.06	74.00	-21.94
2390.00	Average	37.74	3.70	41.44	54.00	-12.56

Report No.: TMWK2109000560KR

Test Mode:	GFSK_BDR-1Mbps Low CH Hopping	Temp/Hum	22(°C)/ 50%RH
Test Item	Band Edge	Test Date	October 4, 2021
Polarize	Horizontal	Test Engineer	Ray Li
Detector	Peak / Average		

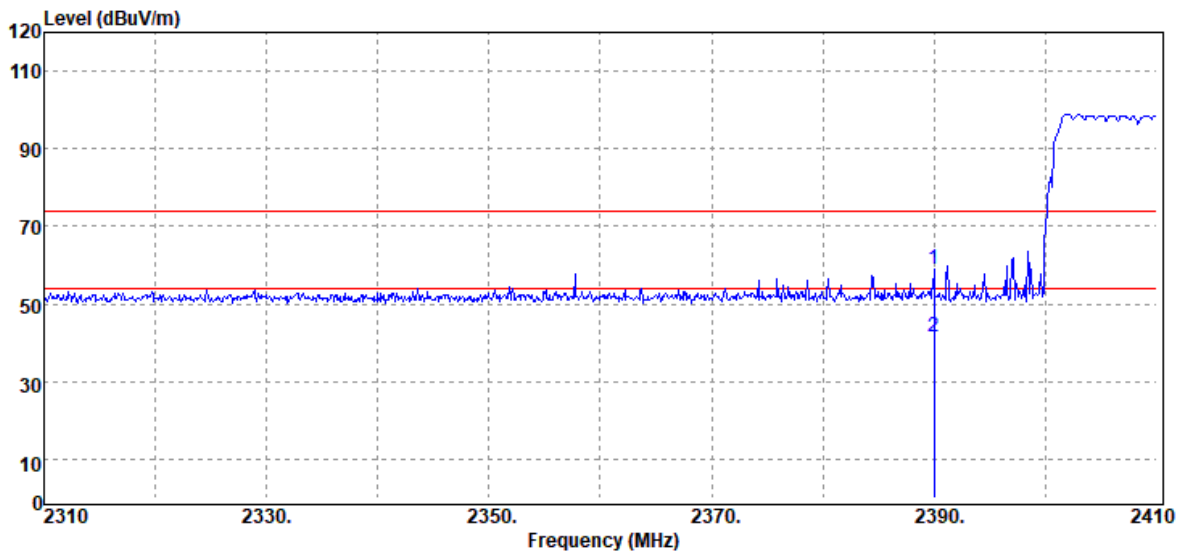

Freq. MHz	Detector Mode PK/QP/AV	Spectrum Reading Level dB μ V	Factor dB	Actual FS dB μ V/m	Limit @3m dB μ V/m	Margin dB
2390.00	Peak	55.35	3.70	59.05	74.00	-14.95
2390.00	Average	37.64	3.70	41.34	54.00	-12.66

Report No.: TMWK2109000560KR

Test Mode:	GFSK_BDR-1Mbps High CH Hopping	Temp/Hum	22(°C)/ 50%RH
Test Item	Band Edge	Test Date	October 4, 2021
Polarize	Vertical	Test Engineer	Ray Li
Detector	Peak / Average		

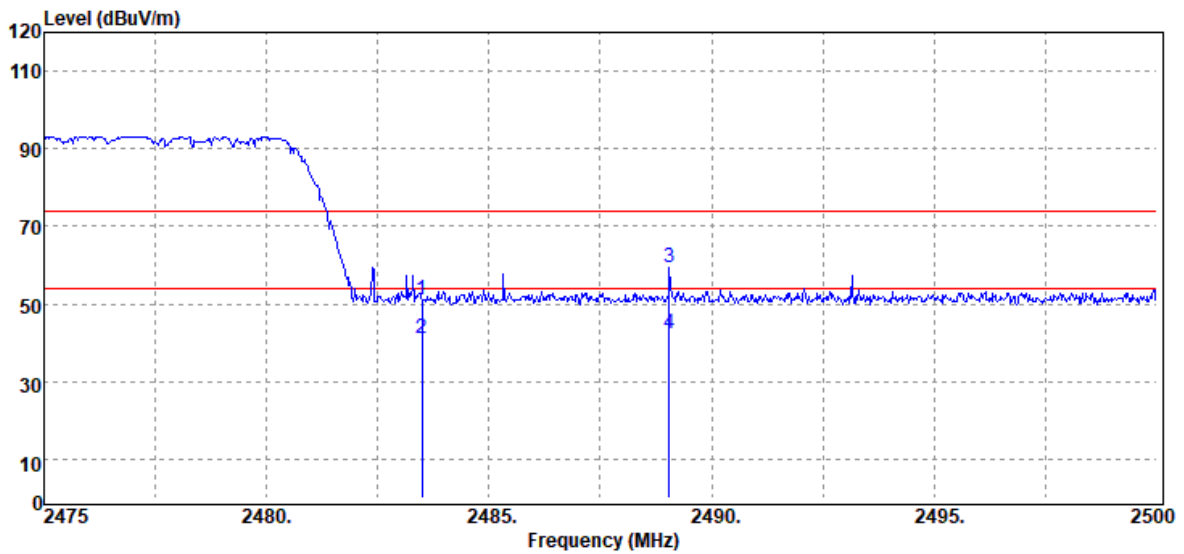

Freq. MHz	Detector Mode PK/QP/AV	Spectrum Reading Level dB μ V	Factor dB	Actual FS dB μ V/m	Limit @3m dB μ V/m	Margin dB
2483.50	Peak	47.07	4.04	51.11	74.00	-22.89
2483.50	Average	37.21	4.04	41.25	54.00	-12.75
2489.05	Peak	55.21	4.12	59.33	74.00	-14.67
2489.05	Average	38.07	4.12	42.19	54.00	-11.81

Report No.: TMWK2109000560KR

Test Mode:	GFSK_BDR-1Mbps High CH Hopping	Temp/Hum	22(°C)/ 50%RH
Test Item	Band Edge	Test Date	October 4, 2021
Polarize	Horizontal	Test Engineer	Ray Li
Detector	Peak / Average		

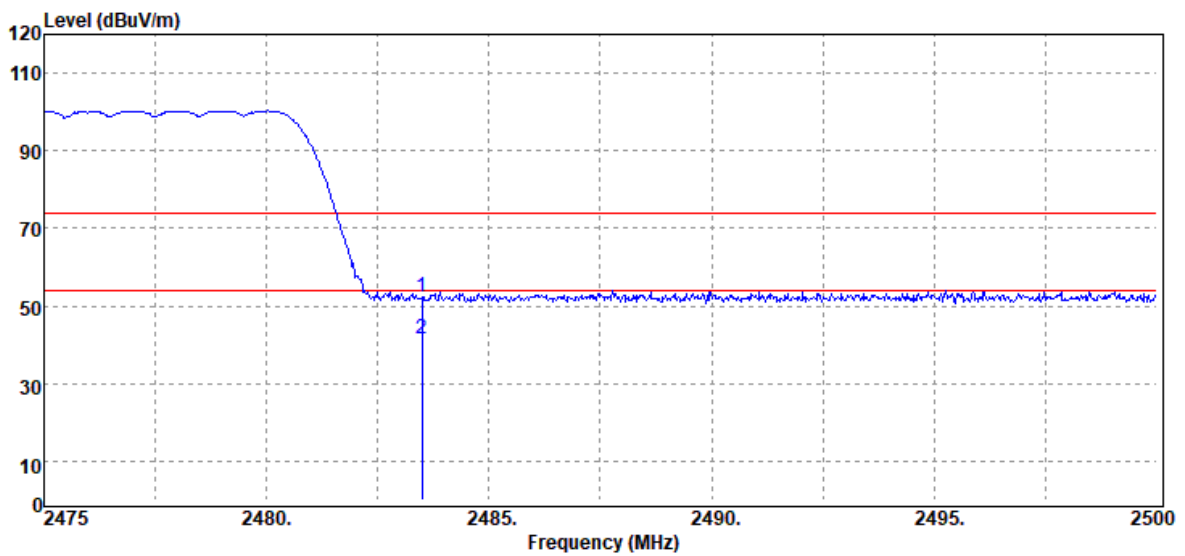

Freq. MHz	Detector Mode PK/QP/AV	Spectrum Reading Level dB μ V	Factor dB	Actual FS dB μ V/m	Limit @3m dB μ V/m	Margin dB
2483.50	Peak	48.16	4.04	52.20	74.00	-21.80
2483.50	Average	37.35	4.04	41.39	54.00	-12.61

Report No.: TMWK2109000560KR

Test Mode:	8DPSK_EDR-3Mbps Low CH	Temp/Hum	22(°C)/ 50%RH
Test Item	Band Edge	Test Date	October 4, 2021
Polarize	Vertical	Test Engineer	Ray Li
Detector	Peak / Average		

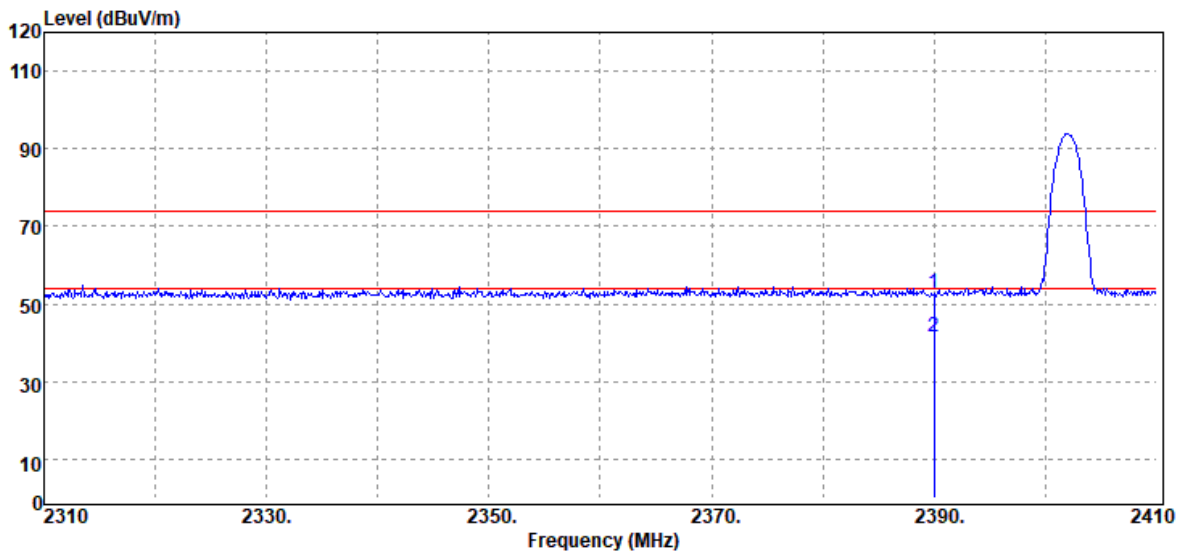

Freq. MHz	Detector Mode PK/QP/AV	Spectrum Reading Level dBμV	Factor dB	Actual FS dBμV/m	Limit @3m dBμV/m	Margin dB
2390.00	Peak	49.01	3.70	52.71	74.00	-21.29
2390.00	Average	37.71	3.70	41.41	54.00	-12.59

Report No.: TMWK2109000560KR

Test Mode:	8DPSK_EDR-3Mbps Low CH	Temp/Hum	22(°C)/ 50%RH
Test Item	Band Edge	Test Date	October 4, 2021
Polarize	Horizontal	Test Engineer	Ray Li
Detector	Peak / Average		

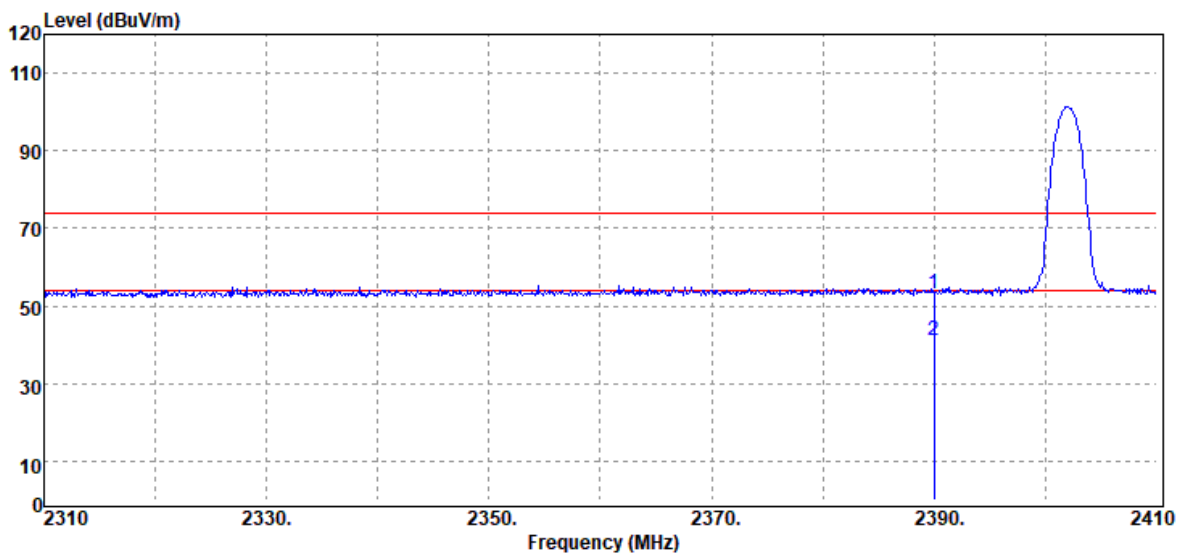

Freq. MHz	Detector Mode PK/QP/AV	Spectrum Reading Level dB μ V	Factor dB	Actual FS dB μ V/m	Limit @3m dB μ V/m	Margin dB
2390.00	Peak	49.53	3.70	53.23	74.00	-20.77
2390.00	Average	37.61	3.70	41.31	54.00	-12.69

Report No.: TMWK2109000560KR

Test Mode:	8DPSK_EDR-3Mbps High CH	Temp/Hum	22(°C)/ 50%RH
Test Item	Band Edge	Test Date	October 4, 2021
Polarize	Vertical	Test Engineer	Ray Li
Detector	Peak / Average		

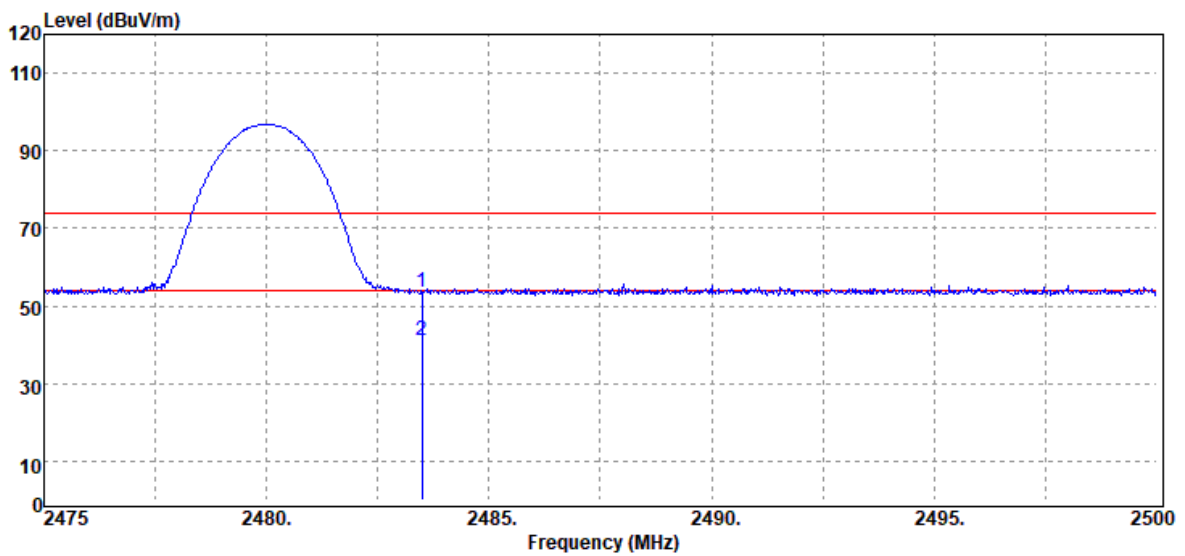

Freq. MHz	Detector Mode PK/QP/AV	Spectrum Reading Level dBμV	Factor dB	Actual FS dBμV/m	Limit @3m dBμV/m	Margin dB
2483.50	Peak	49.62	4.04	53.66	74.00	-20.34
2483.50	Average	36.90	4.04	40.94	54.00	-13.06

Report No.: TMWK2109000560KR

Test Mode:	8DPSK_EDR-3Mbps High CH	Temp/Hum	22(°C)/ 50%RH
Test Item	Band Edge	Test Date	October 4, 2021
Polarize	Horizontal	Test Engineer	Ray Li
Detector	Peak / Average		

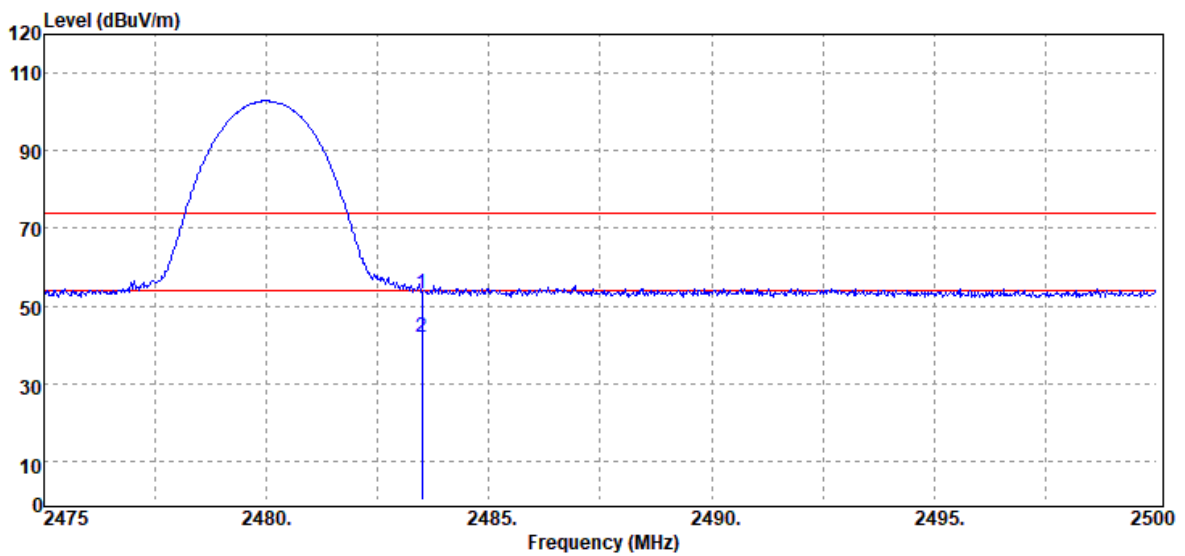

Freq. MHz	Detector Mode PK/QP/AV	Spectrum Reading Level dB μ V	Factor dB	Actual FS dB μ V/m	Limit @3m dB μ V/m	Margin dB
2483.50	Peak	49.30	4.04	53.34	74.00	-20.66
2483.50	Average	38.05	4.04	42.09	54.00	-11.91

Report No.: TMWK2109000560KR

Test Mode:	8DPSK_EDR-3Mbps Low CH Hopping	Temp/Hum	22(°C)/ 50%RH
Test Item	Band Edge	Test Date	October 4, 2021
Polarize	Vertical	Test Engineer	Ray Li
Detector	Peak / Average		

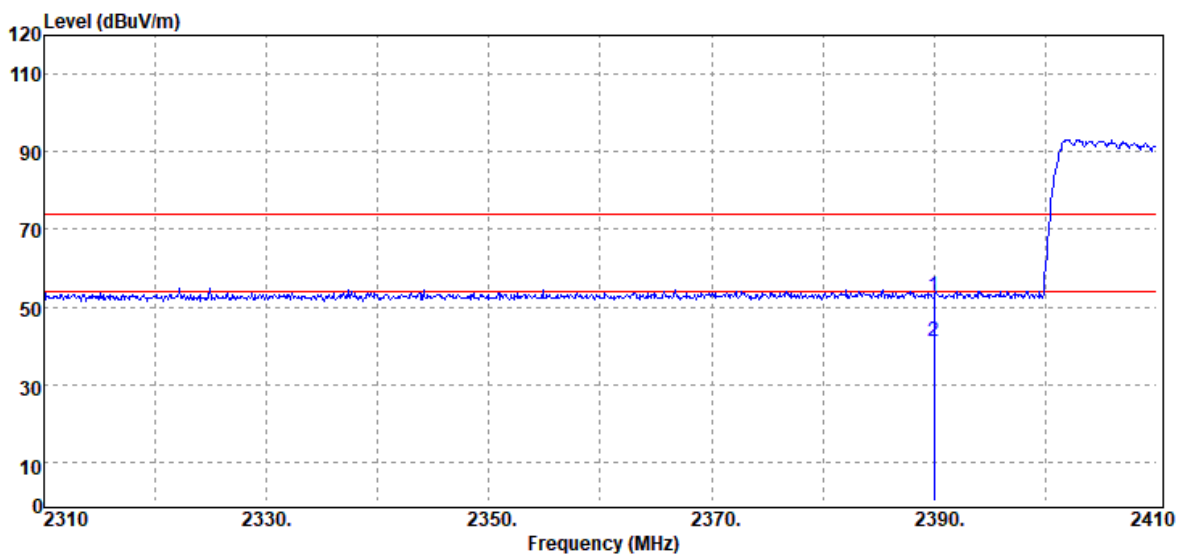

Freq. MHz	Detector Mode PK/QP/AV	Spectrum Reading Level dB μ V	Factor dB	Actual FS dB μ V/m	Limit @3m dB μ V/m	Margin dB
2390.00	Peak	49.14	3.70	52.84	74.00	-21.16
2390.00	Average	37.52	3.70	41.22	54.00	-12.78

Report No.: TMWK2109000560KR

Test Mode:	8DPSK_EDR-3Mbps Low CH Hopping	Temp/Hum	22(°C)/ 50%RH
Test Item	Band Edge	Test Date	October 4, 2021
Polarize	Horizontal	Test Engineer	Ray Li
Detector	Peak / Average		

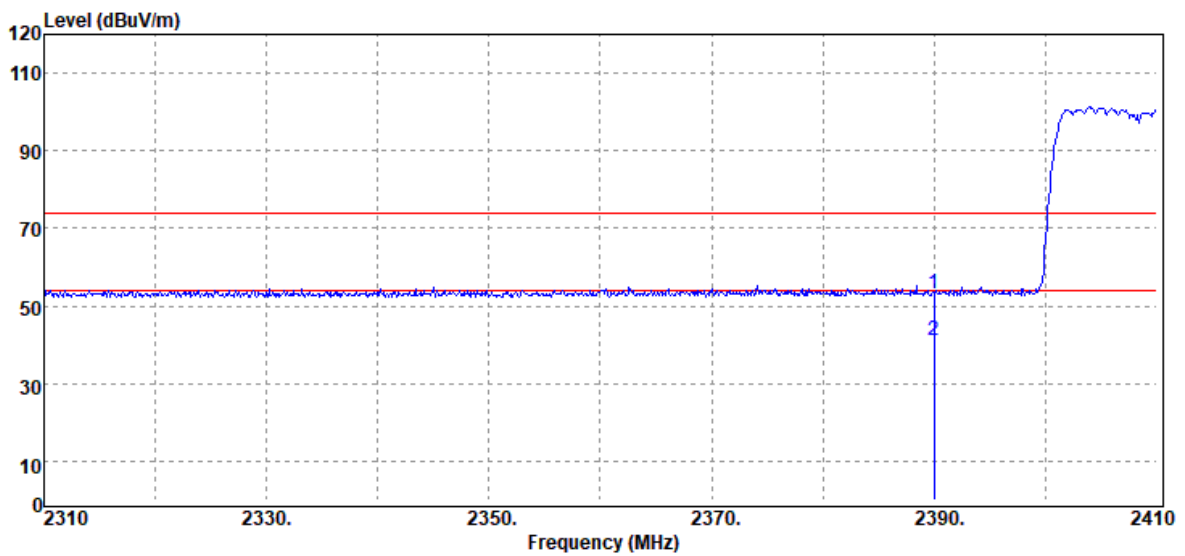

Freq. MHz	Detector Mode PK/QP/AV	Spectrum Reading Level dBµV	Factor dB	Actual FS dBµV/m	Limit @3m dBµV/m	Margin dB
2390.00	Peak	49.55	3.70	53.25	74.00	-20.75
2390.00	Average	37.57	3.70	41.27	54.00	-12.73

Report No.: TMWK2109000560KR

Test Mode:	8DPSK_EDR-3Mbps High CH Hopping	Temp/Hum	22(°C)/ 50%RH
Test Item	Band Edge	Test Date	October 4, 2021
Polarize	Vertical	Test Engineer	Ray Li
Detector	Peak / Average		

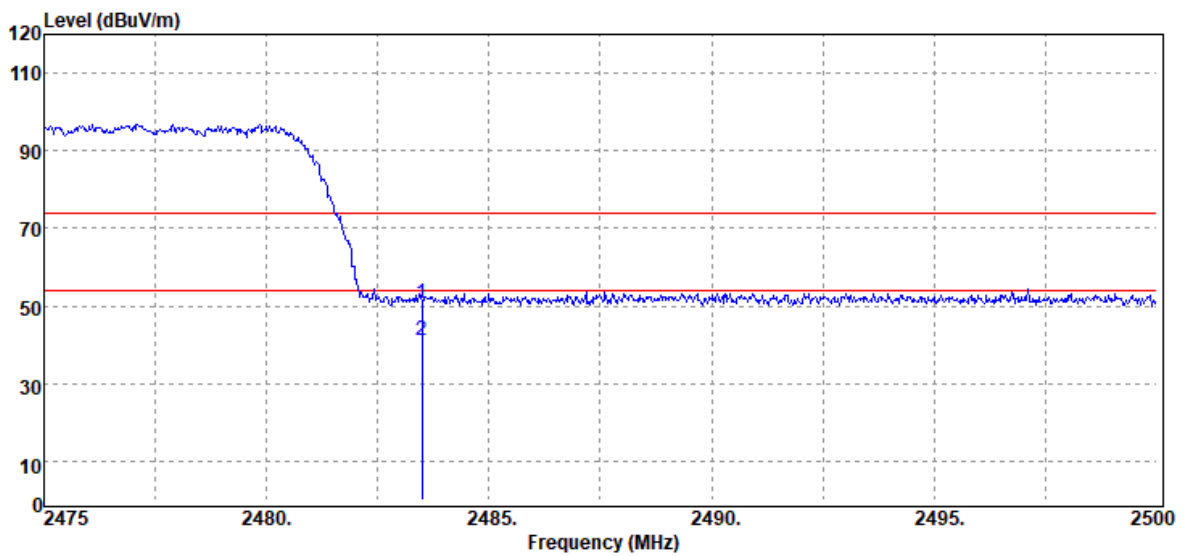

Freq. MHz	Detector Mode PK/QP/AV	Spectrum Reading Level dB μ V	Factor dB	Actual FS dB μ V/m	Limit @3m dB μ V/m	Margin dB
2483.50	Peak	46.66	4.04	50.70	74.00	-23.30
2483.50	Average	37.18	4.04	41.22	54.00	-12.78

Report No.: TMWK2109000560KR

Test Mode:	8DPSK_EDR-3Mbps High CH Hopping	Temp/Hum	22(°C)/ 50%RH
Test Item	Band Edge	Test Date	October 4, 2021
Polarize	Horizontal	Test Engineer	Ray Li
Detector	Peak / Average		

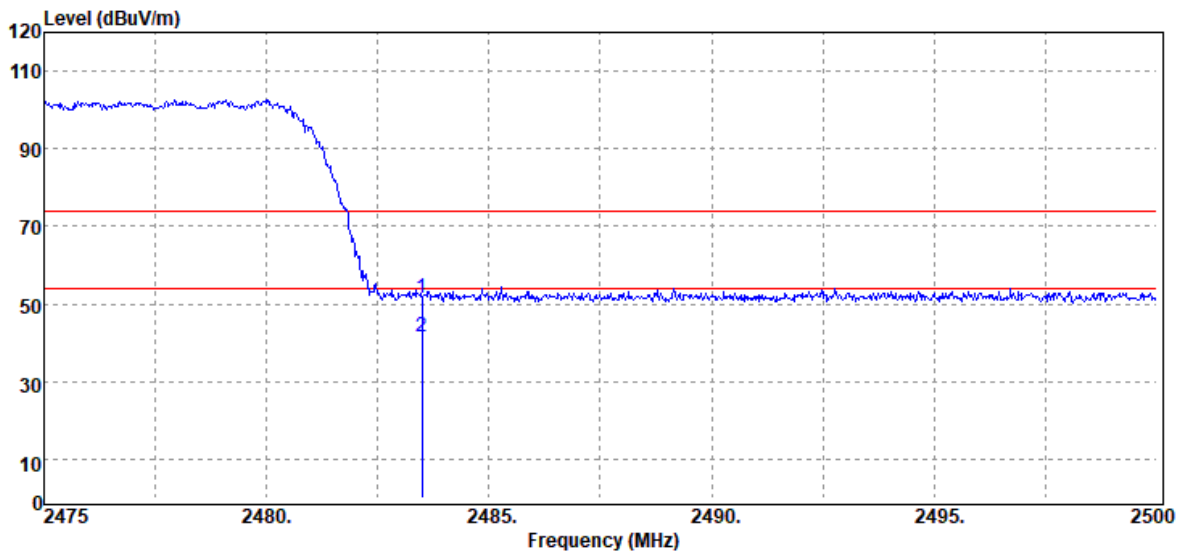

Freq. MHz	Detector Mode PK/QP/AV	Spectrum Reading Level dB μ V	Factor dB	Actual FS dB μ V/m	Limit @3m dB μ V/m	Margin dB
2483.50	Peak	47.41	4.04	51.45	74.00	-22.55
2483.50	Average	37.30	4.04	41.34	54.00	-12.66

Report No.: TMWK2109000560KR

Below 1G Test Data

Test Mode:	BT Mode	Temp/Hum	23.1(°C)/ 55%RH
Test Item	30MHz-1GHz	Test Date	October 1, 2021
Polarize	Vertical	Test Engineer	Ray Li
Detector	Peak		

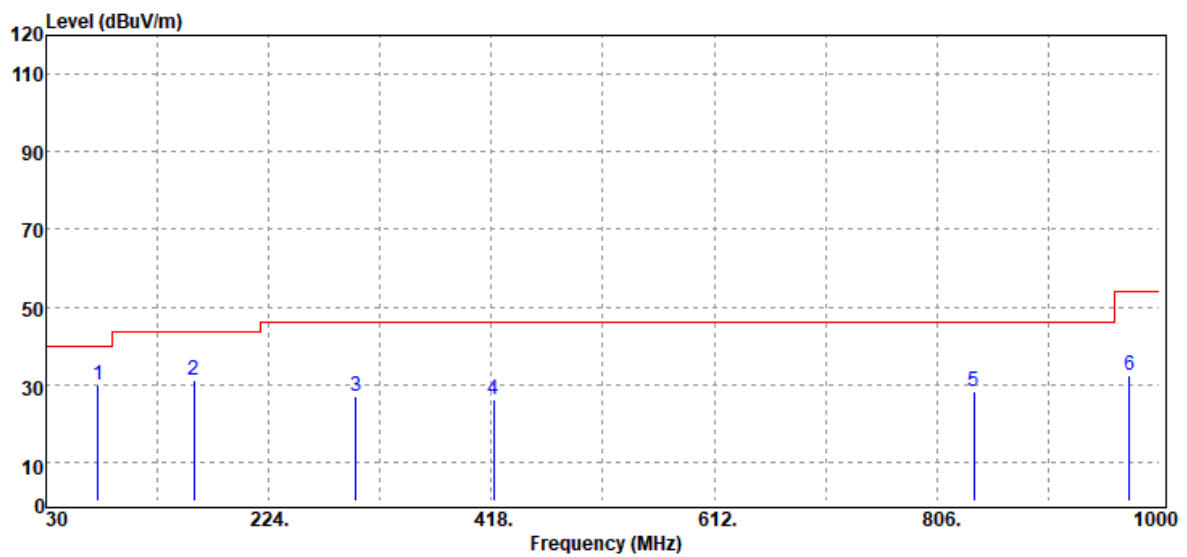

Freq. MHz	Detector Mode PK/QP/AV	Spectrum Reading Level dB μ V	Factor dB	Actual FS dB μ V/m	Limit @3m dB μ V/m	Margin dB
75.59	Peak	45.29	-15.24	30.05	40.00	-9.95
159.01	Peak	41.51	-10.51	31.00	43.50	-12.50
299.66	Peak	35.81	-8.80	27.01	46.00	-18.99
419.94	Peak	31.61	-5.26	26.35	46.00	-19.65
838.01	Peak	25.97	2.07	28.04	46.00	-17.96
973.81	Peak	28.27	3.94	32.21	54.00	-21.79

Report No.: TMWK2109000560KR

Test Mode:	BT Mode	Temp/Hum	23.1(°C)/ 55%RH
Test Item	30MHz-1GHz	Test Date	October 1, 2021
Polarize	Horizontal	Test Engineer	Ray Li
Detector	Peak		

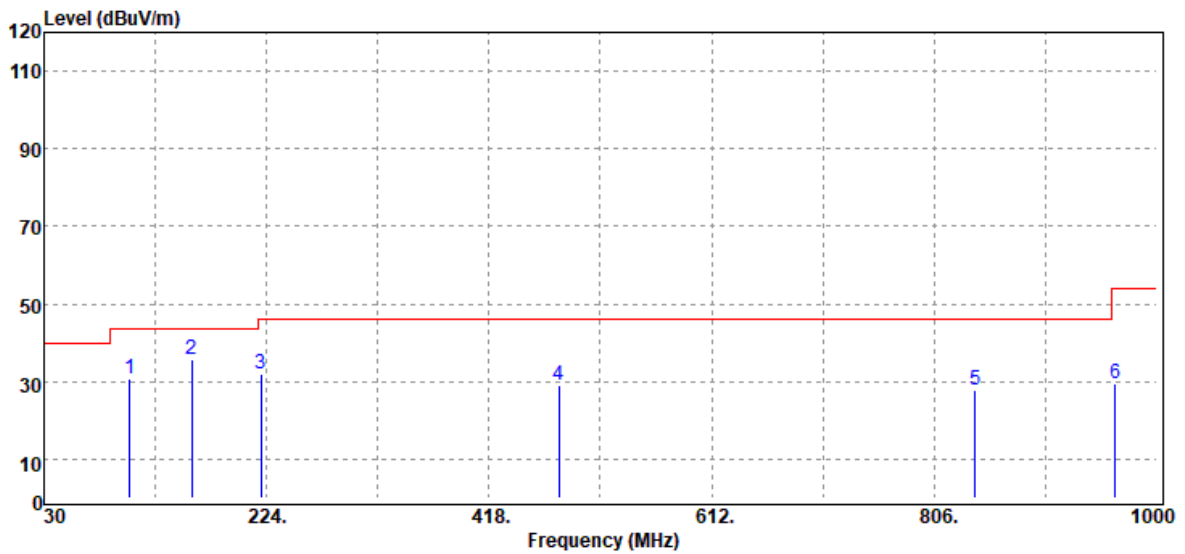

Freq. MHz	Detector Mode PK/QP/AV	Spectrum Reading Level dBμV	Factor dB	Actual FS dBμV/m	Limit @3m dBμV/m	Margin dB
104.69	Peak	42.16	-11.31	30.85	43.50	-12.65
159.01	Peak	46.09	-10.51	35.58	43.50	-7.92
219.15	Peak	43.98	-11.85	32.13	46.00	-13.87
479.11	Peak	32.53	-3.39	29.14	46.00	-16.86
841.89	Peak	25.52	2.16	27.68	46.00	-18.32
964.11	Peak	25.67	3.91	29.58	54.00	-24.42

Report No.: TMWK2109000560KR

Above 1G Test Data

Test Mode:	GFSK_BDR-1Mbps Low CH	Temp/Hum	23.1(°C)/ 55%RH
Test Item	Harmonic	Test Date	October 1, 2021
Polarize	Vertical	Test Engineer	Ray Li
Detector	Peak		

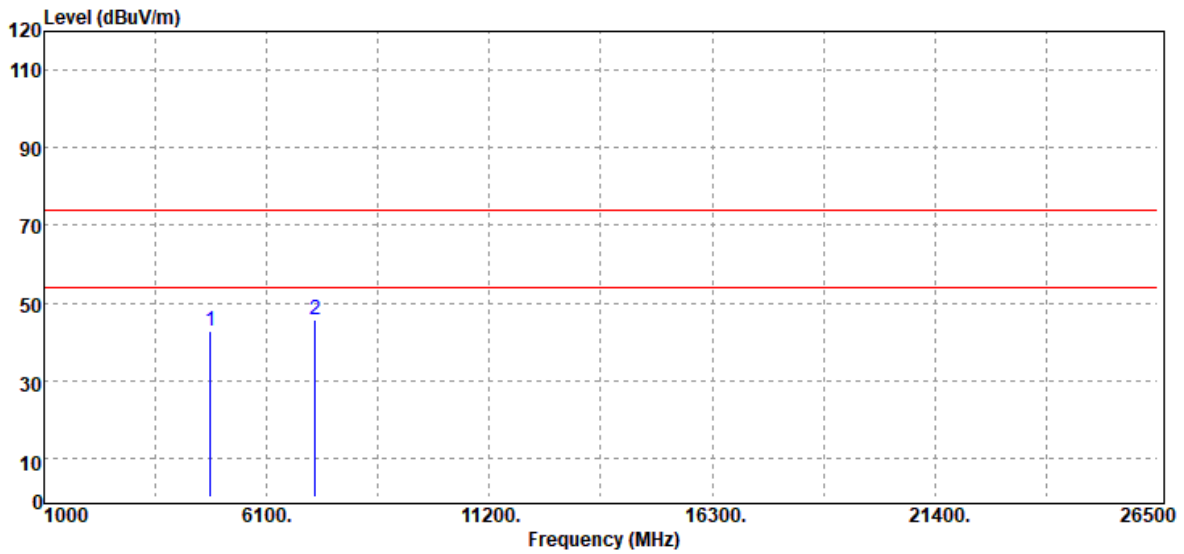

Freq. MHz	Detector Mode PK/QP/AV	Spectrum Reading Level dBµV	Factor dB	Actual FS dBµV/m	Limit @3m dBµV/m	Margin dB
4804.00	Peak	33.67	9.28	42.95	74.00	-31.05
7206.00	Peak	32.25	13.52	45.77	74.00	-28.23
N/A						

Remark:

1. Measuring frequencies from 1 GHz to the 10th harmonic of highest fundamental frequency.
2. For above 1GHz, the EUT peak value was under average limit, therefore the Average value compliance with the average limit

Report No.: TMWK2109000560KR

Test Mode:	GFSK_BDR-1Mbps Low CH	Temp/Hum	23.1(°C)/ 55%RH
Test Item	Harmonic	Test Date	October 1, 2021
Polarize	Horizontal	Test Engineer	Ray Li
Detector	Peak		

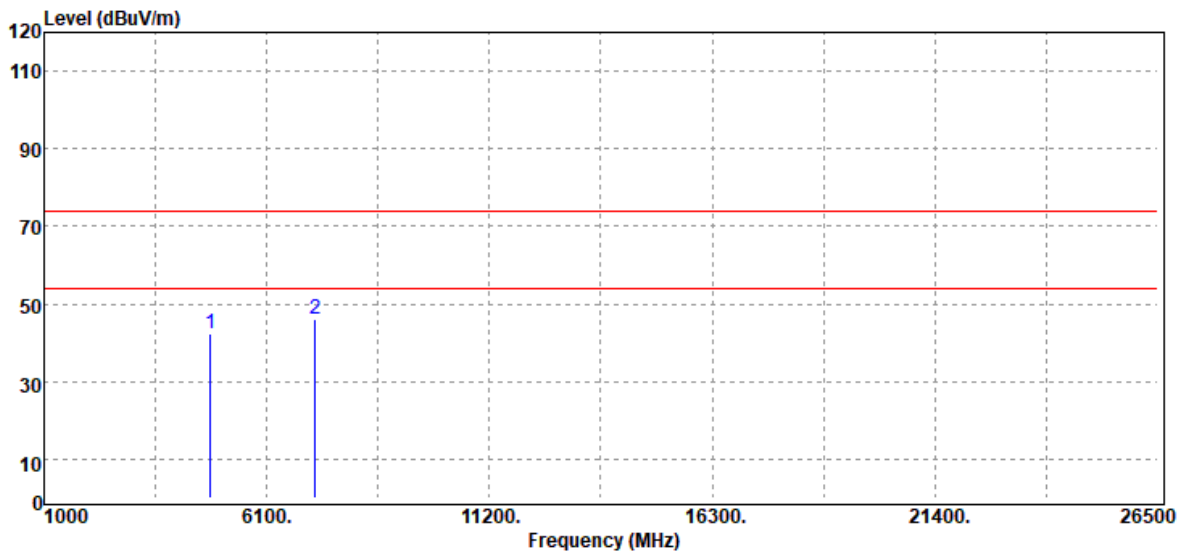

Freq. MHz	Detector Mode PK/QP/AV	Spectrum Reading Level dBµV	Factor dB	Actual FS dBµV/m	Limit @3m dBµV/m	Margin dB
4804.00	Peak	33.20	9.28	42.48	74.00	-31.52
7206.00	Peak	32.63	13.52	46.15	74.00	-27.85
N/A						

Remark:

1. Measuring frequencies from 1 GHz to the 10th harmonic of highest fundamental frequency.
2. For above 1GHz, the EUT peak value was under average limit, therefore the Average value compliance with the average limit

Report No.: TMWK2109000560KR

Test Mode:	GFSK_BDR-1Mbps Mid CH	Temp/Hum	23.1(°C)/ 55%RH
Test Item	Harmonic	Test Date	October 1, 2021
Polarize	Vertical	Test Engineer	Ray Li
Detector	Peak		

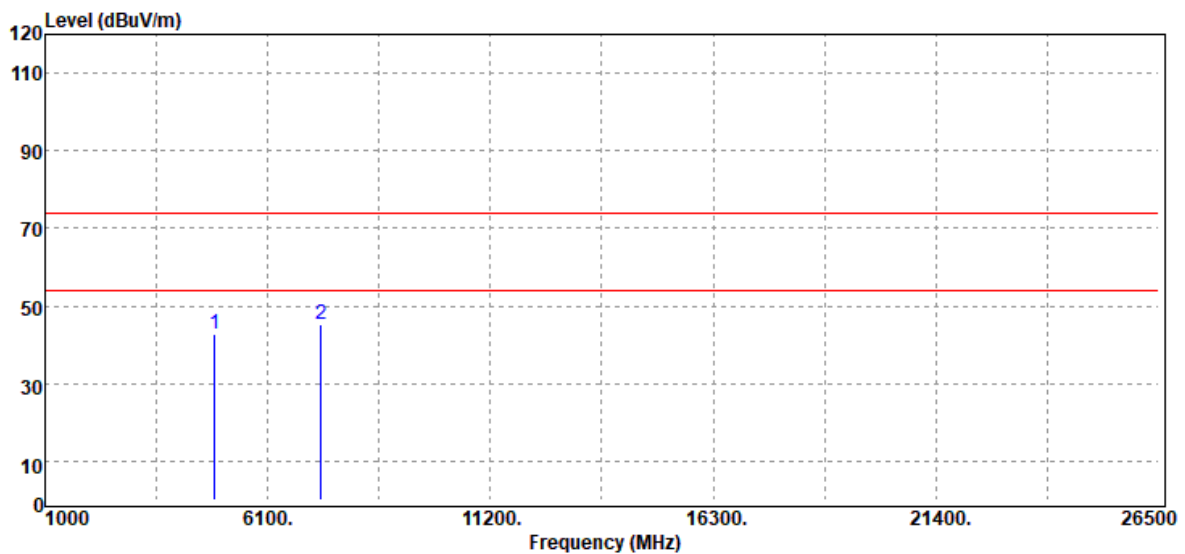

Freq. MHz	Detector Mode PK/QP/AV	Spectrum Reading Level dBµV	Factor dB	Actual FS dBµV/m	Limit @3m dBµV/m	Margin dB
4882.00	Peak	33.41	9.50	42.91	74.00	-31.09
7323.00	Peak	31.65	13.49	45.14	74.00	-28.86
N/A						

Remark:

1. Measuring frequencies from 1 GHz to the 10th harmonic of highest fundamental frequency.
2. For above 1GHz, the EUT peak value was under average limit, therefore the Average value compliance with the average limit

Report No.: TMWK2109000560KR

Test Mode:	GFSK_BDR-1Mbps Mid CH	Temp/Hum	23.1(°C)/ 55%RH
Test Item	Harmonic	Test Date	October 1, 2021
Polarize	Horizontal	Test Engineer	Ray Li
Detector	Peak		

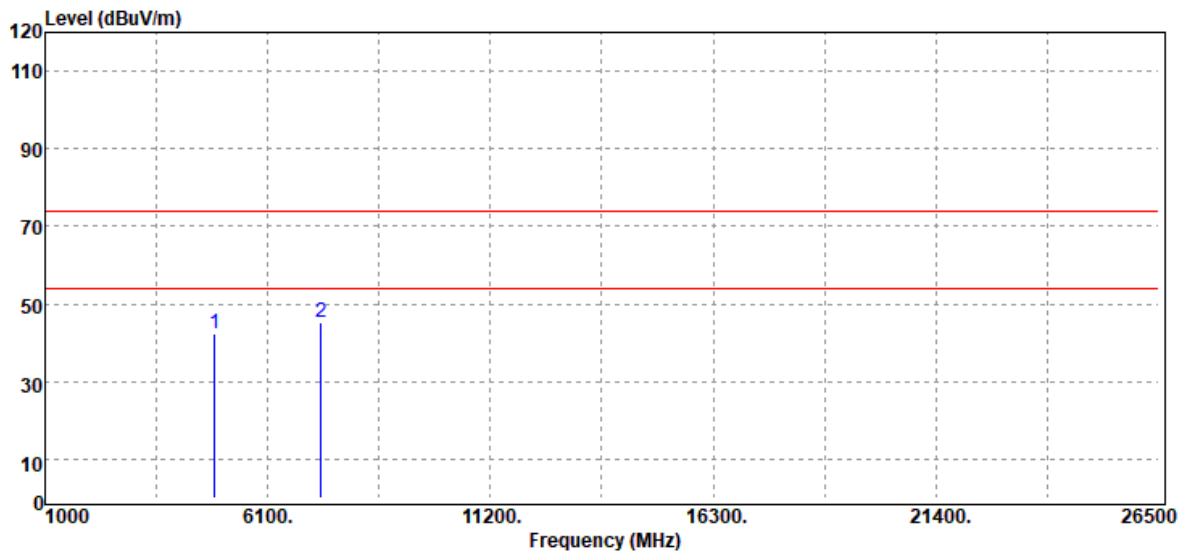

Freq. MHz	Detector Mode PK/QP/AV	Spectrum Reading Level dBµV	Factor dB	Actual FS dBµV/m	Limit @3m dBµV/m	Margin dB
4882.00	Peak	32.75	9.50	42.25	74.00	-31.75
7323.00	Peak	31.86	13.49	45.35	74.00	-28.65
N/A						

Remark:

1. Measuring frequencies from 1 GHz to the 10th harmonic of highest fundamental frequency.
2. For above 1GHz, the EUT peak value was under average limit, therefore the Average value compliance with the average limit

Report No.: TMWK2109000560KR

Test Mode:	GFSK_BDR-1Mbps High CH	Temp/Hum	23.1(°C)/ 55%RH
Test Item	Harmonic	Test Date	October 1, 2021
Polarize	Vertical	Test Engineer	Ray Li
Detector	Peak		

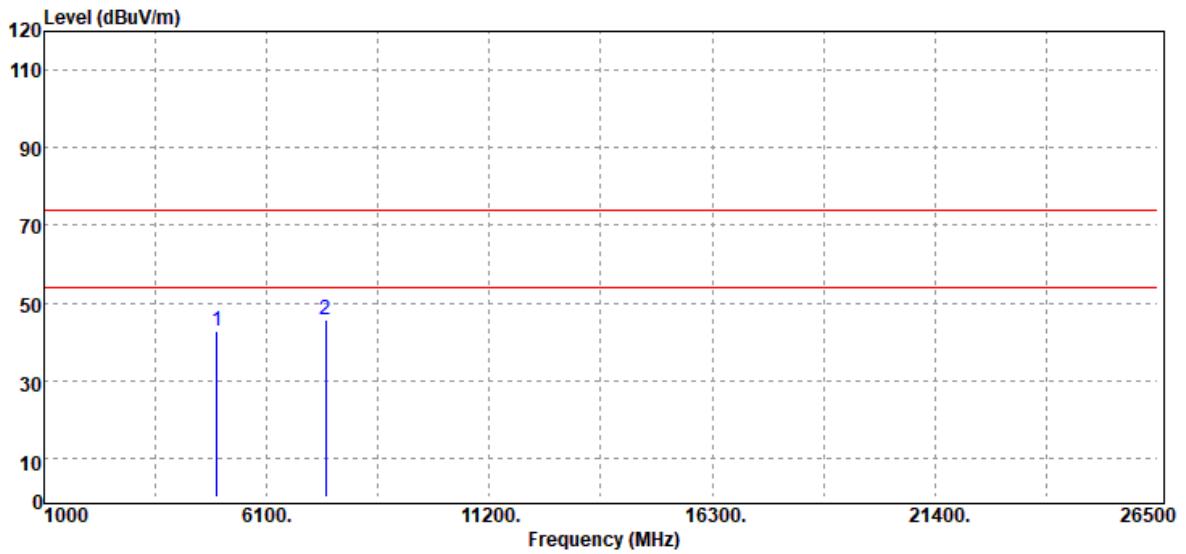

Freq. MHz	Detector Mode PK/QP/AV	Spectrum Reading Level dB μ V	Factor dB	Actual FS dB μ V/m	Limit @3m dB μ V/m	Margin dB
4960.00	Peak	33.11	9.81	42.92	74.00	-31.08
7440.00	Peak	32.07	13.64	45.71	74.00	-28.29
N/A						

Remark:

1. Measuring frequencies from 1 GHz to the 10th harmonic of highest fundamental frequency.
2. For above 1GHz,the EUT peak value was under average limit, therefore the Average value compliance with the average limit

Report No.: TMWK2109000560KR

Test Mode:	GFSK_BDR-1Mbps High CH	Temp/Hum	23.1(°C)/ 55%RH
Test Item	Harmonic	Test Date	October 1, 2021
Polarize	Horizontal	Test Engineer	Ray Li
Detector	Peak		

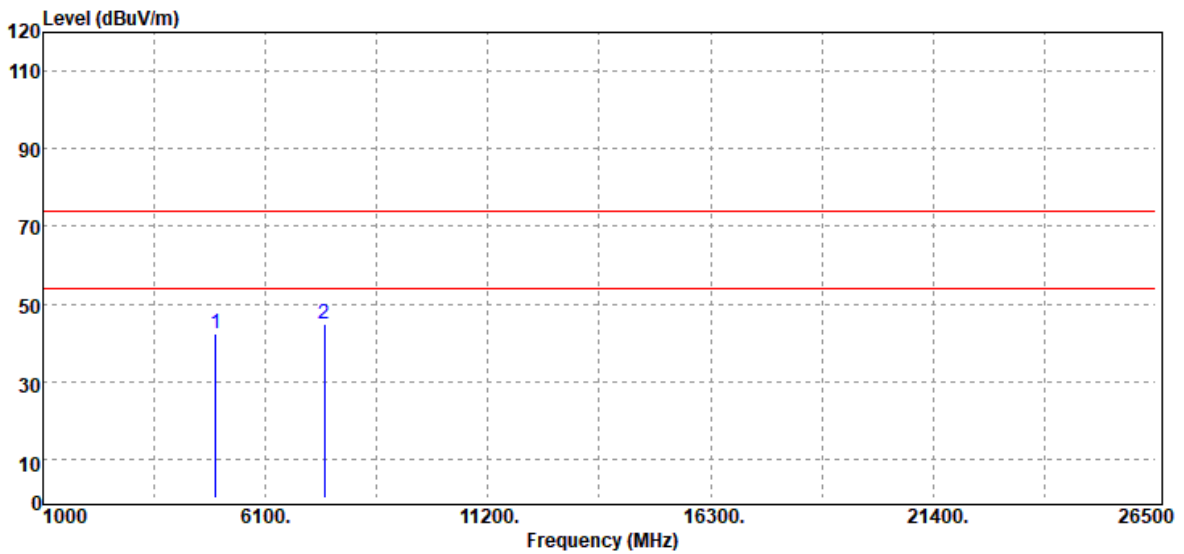

Freq. MHz	Detector Mode PK/QP/AV	Spectrum Reading Level dB μ V	Factor dB	Actual FS dB μ V/m	Limit @3m dB μ V/m	Margin dB
4960.00	Peak	32.74	9.81	42.55	74.00	-31.45
7440.00	Peak	31.26	13.64	44.90	74.00	-29.10
N/A						

Remark:

1. Measuring frequencies from 1 GHz to the 10th harmonic of highest fundamental frequency.
2. For above 1GHz, the EUT peak value was under average limit, therefore the Average value compliance with the average limit

Report No.: TMWK2109000560KR

Test Mode	8DPSK_EDR-3Mbps Low CH	Temp/Hum	23.1(°C)/ 55%RH
Test Item	Harmonic	Test Date	October 1, 2021
Polarize	Vertical	Test Engineer	Ray Li
Detector	Peak		

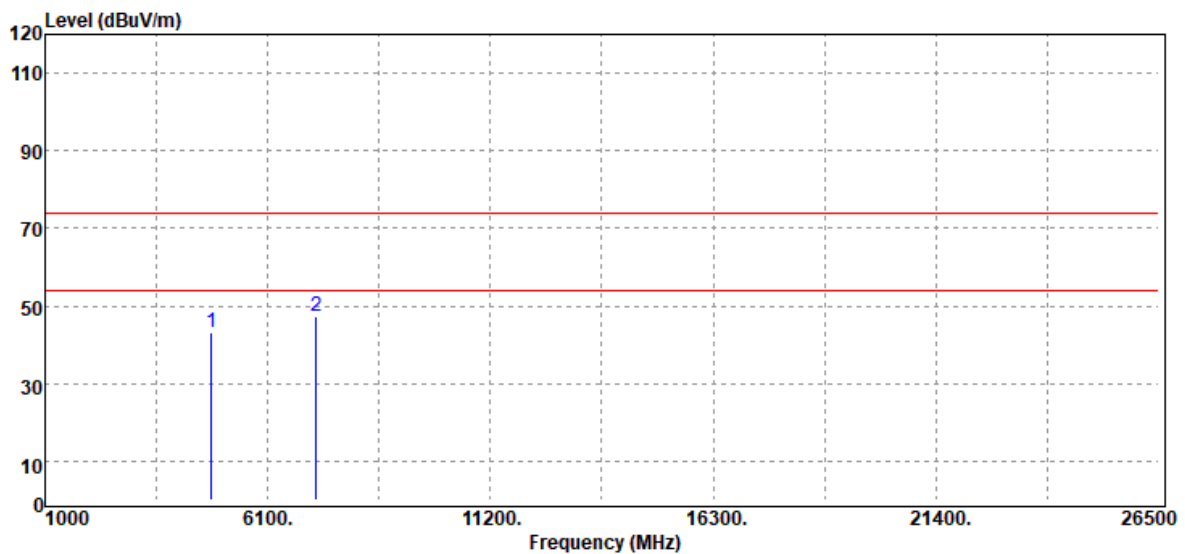

Freq. MHz	Detector Mode PK/QP/AV	Spectrum Reading Level dB μ V	Factor dB	Actual FS dB μ V/m	Limit @3m dB μ V/m	Margin dB
4804.00	Peak	33.82	9.28	43.10	74.00	-30.90
7206.00	Peak	34.00	13.52	47.52	74.00	-26.48
N/A						

Remark:

1. Measuring frequencies from 1 GHz to the 10th harmonic of highest fundamental frequency.
2. For above 1GHz, the EUT peak value was under average limit, therefore the Average value compliance with the average limit

Report No.: TMWK2109000560KR

Test Mode	8DPSK_EDR-3Mbps Low CH	Temp/Hum	23.1(°C)/ 55%RH
Test Item	Harmonic	Test Date	October 1, 2021
Polarize	Horizontal	Test Engineer	Ray Li
Detector	Peak		

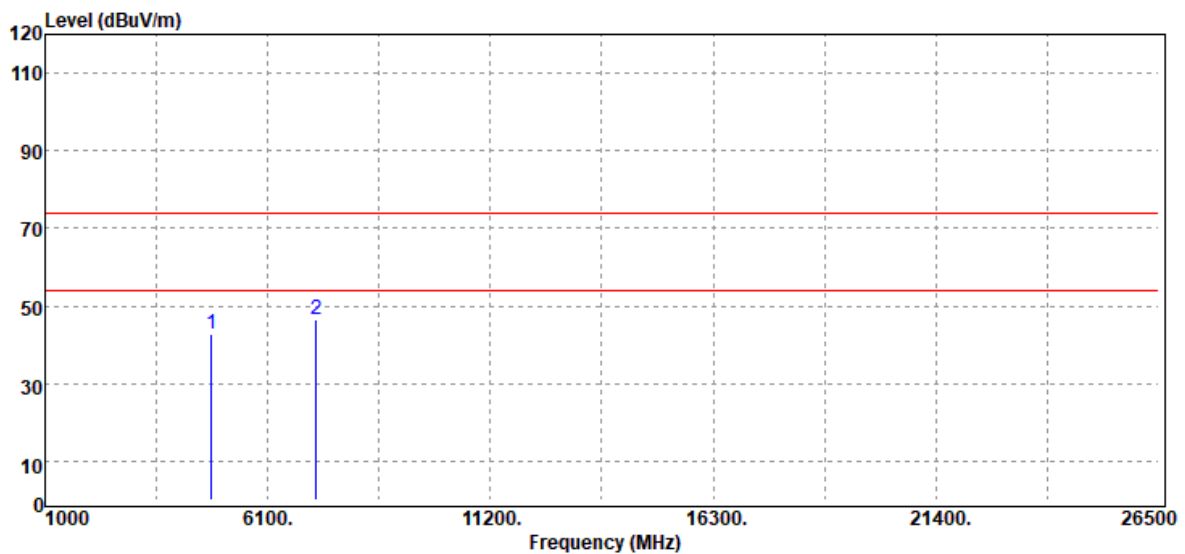

Freq. MHz	Detector Mode PK/QP/AV	Spectrum Reading Level dB μ V	Factor dB	Actual FS dB μ V/m	Limit @3m dB μ V/m	Margin dB
4804.00	Peak	33.35	9.28	42.63	74.00	-31.37
7206.00	Peak	32.86	13.52	46.38	74.00	-27.62
N/A						

Remark:

1. Measuring frequencies from 1 GHz to the 10th harmonic of highest fundamental frequency.
2. For above 1GHz, the EUT peak value was under average limit, therefore the Average value compliance with the average limit

Report No.: TMWK2109000560KR

Test Mode	8DPSK_EDR-3Mbps Mid CH	Temp/Hum	23.1(°C)/ 55%RH
Test Item	Harmonic	Test Date	October 1, 2021
Polarize	Vertical	Test Engineer	Ray Li
Detector	Peak		

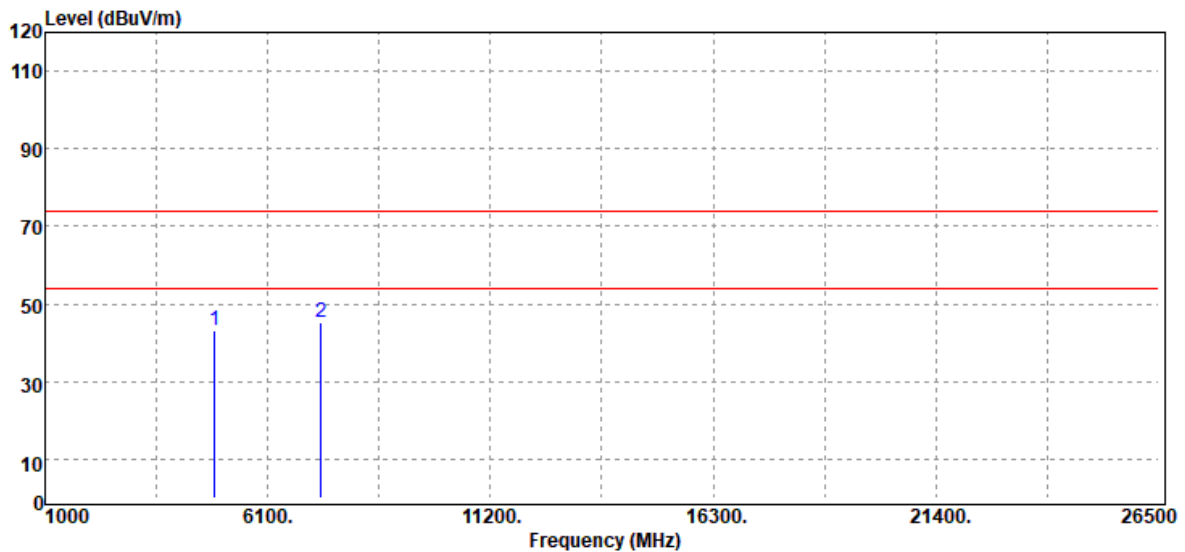

Freq. MHz	Detector Mode PK/QP/AV	Spectrum Reading Level dBμV	Factor dB	Actual FS dBμV/m	Limit @3m dBμV/m	Margin dB
4882.00	Peak	33.56	9.50	43.06	74.00	-30.94
7323.00	Peak	31.58	13.49	45.07	74.00	-28.93
N/A						

Remark:

1. Measuring frequencies from 1 GHz to the 10th harmonic of highest fundamental frequency.
2. For above 1GHz, the EUT peak value was under average limit, therefore the Average value compliance with the average limit

Report No.: TMWK2109000560KR

Test Mode	8DPSK_EDR-3Mbps Mid CH	Temp/Hum	23.1(°C)/ 55%RH
Test Item	Harmonic	Test Date	October 1, 2021
Polarize	Horizontal	Test Engineer	Ray Li
Detector	Peak		

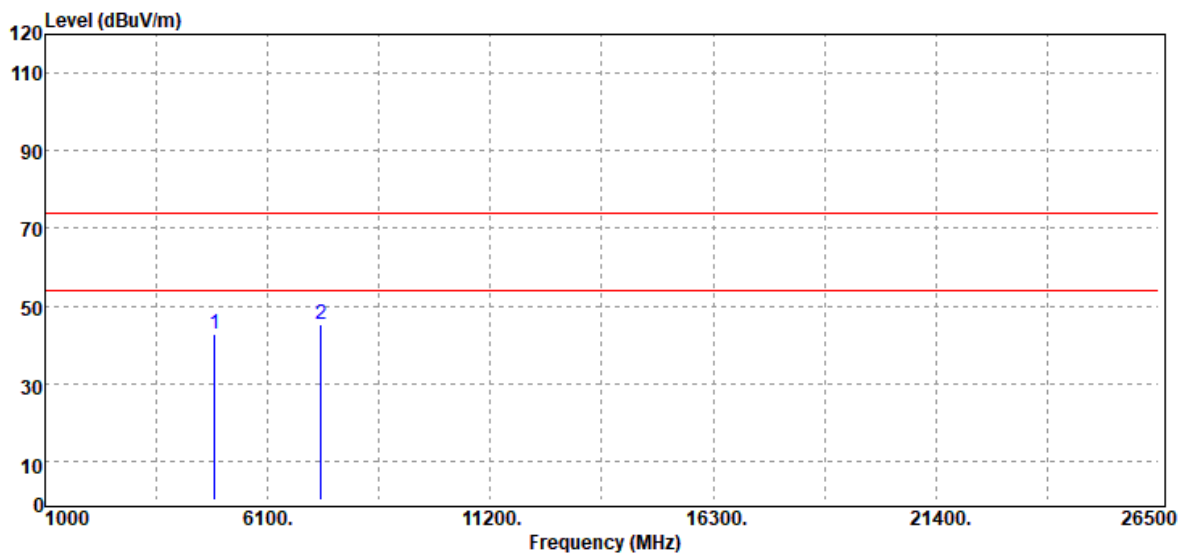

Freq. MHz	Detector Mode PK/QP/AV	Spectrum Reading Level dB μ V	Factor dB	Actual FS dB μ V/m	Limit @3m dB μ V/m	Margin dB
4882.00	Peak	33.17	9.50	42.67	74.00	-31.33
7323.00	Peak	31.80	13.49	45.29	74.00	-28.71
N/A						

Remark:

1. Measuring frequencies from 1 GHz to the 10th harmonic of highest fundamental frequency.
2. For above 1GHz, the EUT peak value was under average limit, therefore the Average value compliance with the average limit

Report No.: TMWK2109000560KR

Test Mode	8DPSK_EDR-3Mbps High CH	Temp/Hum	23.1(°C)/ 55%RH
Test Item	Harmonic	Test Date	October 1, 2021
Polarize	Vertical	Test Engineer	Ray Li
Detector	Peak		

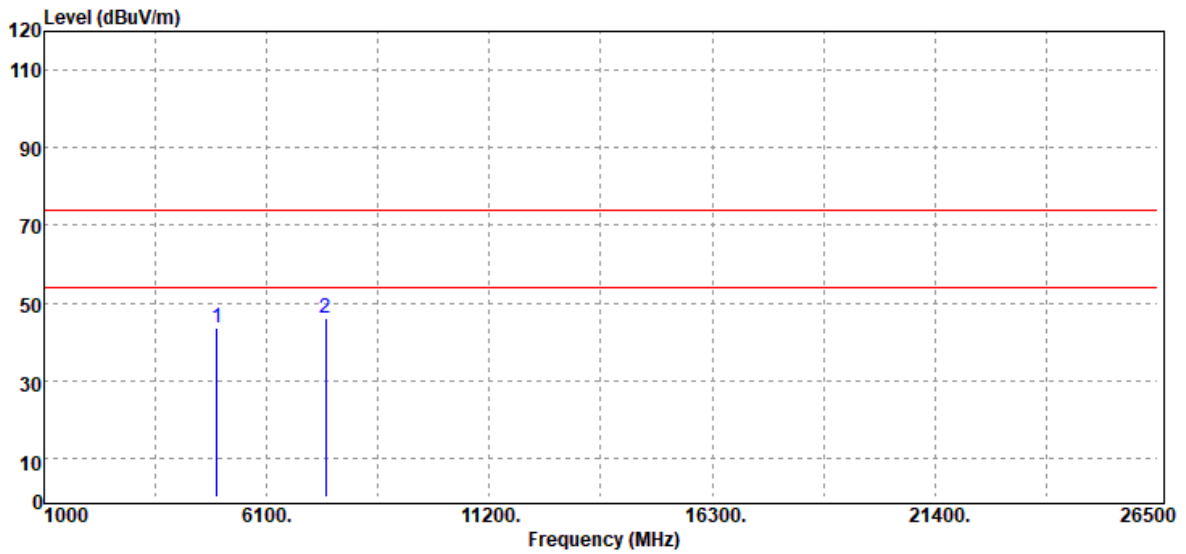

Freq. MHz	Detector Mode PK/QP/AV	Spectrum Reading Level dB μ V	Factor dB	Actual FS dB μ V/m	Limit @3m dB μ V/m	Margin dB
4960.00	Peak	33.60	9.81	43.41	74.00	-30.59
7440.00	Peak	32.33	13.64	45.97	74.00	-28.03
N/A						

Remark:

1. Measuring frequencies from 1 GHz to the 10th harmonic of highest fundamental frequency.
2. For above 1GHz,the EUT peak value was under average limit, therefore the Average value compliance with the average limit

Report No.: TMWK2109000560KR

Test Mode	8DPSK_EDR-3Mbps High CH	Temp/Hum	23.1(°C)/ 55%RH
Test Item	Harmonic	Test Date	October 1, 2021
Polarize	Horizontal	Test Engineer	Ray Li
Detector	Peak		

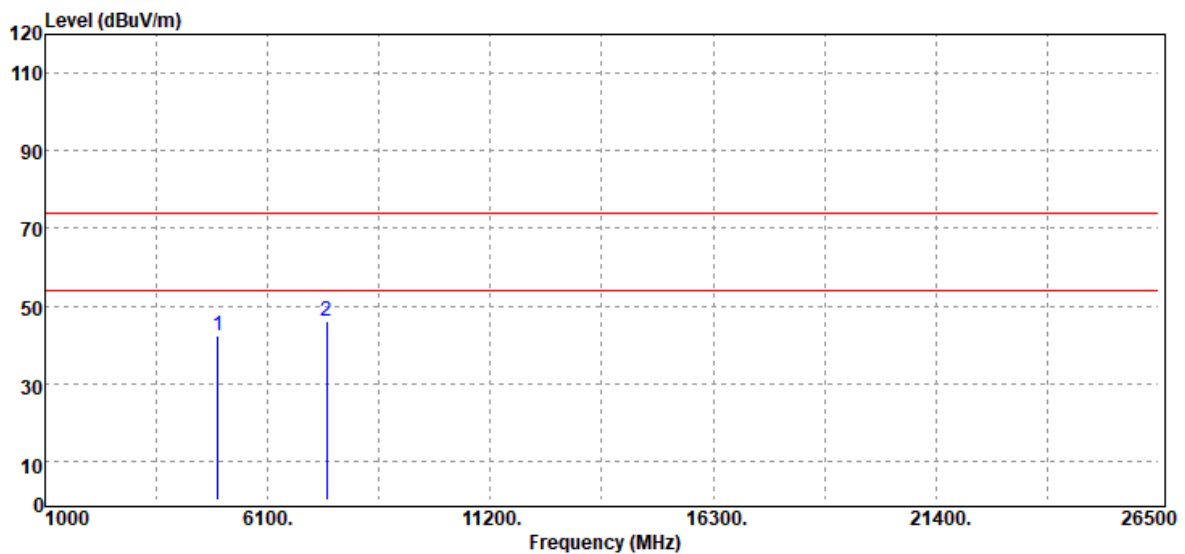

Freq. MHz	Detector Mode PK/QP/AV	Spectrum Reading Level dB μ V	Factor dB	Actual FS dB μ V/m	Limit @3m dB μ V/m	Margin dB
4960.00	Peak	32.61	9.81	42.42	74.00	-31.58
7440.00	Peak	32.45	13.64	46.09	74.00	-27.91
N/A						

Remark:

1. Measuring frequencies from 1 GHz to the 10th harmonic of highest fundamental frequency.
2. For above 1GHz, the EUT peak value was under average limit, therefore the Average value compliance with the average limit

- End of Test Report -