

TEST REPORT

Applicant: CC&C Technologies, Inc.
Address: 8F, No.150, Jian Yi Rd, Zhonghe District, New Taipei City,235, Taiwan
Equipment Type: ac2x2+BT5.0 USB2.0
Model Name: CM-8822CU-V2
Brand Name: CC&C
FCC ID: PANCM8822CUV2
Test Standard: 47 CFR Part 15 Subpart C (refer section 3.1)
Sample Arrival Date: Nov. 28, 2022
Test Date: Dec. 03, 2022 - Dec. 12, 2022
Date of Issue: Feb. 07, 2023

ISSUED BY:

Shenzhen BALUN Technology Co., Ltd.

Tested by: Julie Zhu

Checked by: Ye Hongji

Approved by: Liao Jianming
(Technical Director)

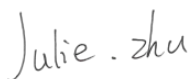

Revision History		
<u>Version</u>	<u>Issue Date</u>	<u>Revisions</u>
<u>Rev. 01</u>	<u>Jan. 05, 2023</u>	<u>Initial Issue</u>
<u>Rev. 02</u>	<u>Feb. 07, 2023</u>	<u>Updated antenna gain</u>

TABLE OF CONTENTS

1	GENERAL INFORMATION.....	4
1.1	Test Laboratory	4
1.2	Test Location	4
2	PRODUCT INFORMATION	5
2.1	Applicant Information	5
2.2	Manufacturer Information.....	5
2.3	Factory Information.....	5
2.4	General Description for Equipment under Test (EUT).....	5
2.5	Technical Information	6
3	SUMMARY OF TEST RESULTS	8
3.1	Test Standards	8
3.2	Test Verdict	9
4	GENERAL TEST CONFIGURATIONS	10
4.1	Test Environments.....	10
4.2	Test Equipment List.....	10
4.3	Test Software List.....	10
4.4	Measurement Uncertainty.....	11
4.5	Description of Test Setup	11
4.6	Measurement Results Explanation Example.....	14
5	TEST ITEMS	15
5.1	Antenna Requirements	15
5.2	Frequency Hopping Systems.....	16
5.3	Number of Hopping Frequencies	18
5.4	Peak Output Power and E.I.R.P	19

5.5	Occupied Bandwidth.....	20
5.6	Carrier Frequency Separation.....	21
5.7	Time of Occupancy (Dwell time)	22
5.8	Conducted Spurious Emission & Authorized-band band-edge.....	24
5.9	Conducted Emission.....	25
5.10	Radiated Spurious Emission.....	26
5.11	Band Edge (Restricted-band band-edge).....	28
ANNEX A	TEST RESULT	29
A.1	Number of Hopping Frequency.....	29
A.2	Peak Output Power and E.I.R.P	29
A.3	20 dB and 99% bandwidth	29
A.4	Hopping Frequency Separation	29
A.5	Average Time of Occupancy.....	29
A.6	Conducted Spurious Emissions & Authorized-band band-edge	29
A.7	Conducted Emissions	30
A.8	Radiated Spurious Emission.....	32
A.9	Band Edge (Restricted-band band-edge).....	46
ANNEX B	TEST SETUP PHOTOS	50
ANNEX C	EUT EXTERNAL PHOTOS.....	50
ANNEX D	EUT INTERNAL PHOTOS.....	50

1 GENERAL INFORMATION

1.1 Test Laboratory

Name	Shenzhen BALUN Technology Co., Ltd.
Address	Block B, 1/F, Baisha Science and Technology Park, Shahe Xi Road, Nanshan District, Shenzhen, Guangdong Province, P. R. China
Phone Number	+86 755 6685 0100

1.2 Test Location

Name	Shenzhen BALUN Technology Co., Ltd.
Location	<input checked="" type="checkbox"/> Block B, 1/F, Baisha Science and Technology Park, Shahe Xi Road, Nanshan District, Shenzhen, Guangdong Province, P. R. China
	<input type="checkbox"/> 1/F, Building B, Ganghongji High-tech Intelligent Industrial Park, No. 1008, Songbai Road, Yangguang Community, Xili Sub-district, Nanshan District, Shenzhen, Guangdong Province, P. R. China
Accreditation Certificate	The laboratory is a testing organization accredited by FCC as a accredited testing laboratory. The designation number is CN1196.

2 PRODUCT INFORMATION

2.1 Applicant Information

Applicant	CC&C Technologies, Inc.
Address	8F, No.150, Jian Yi Rd, Zhonghe District, New Taipei City,235, Taiwan

2.2 Manufacturer Information

Manufacturer	CC&C Technologies, Inc.
Address	8F, No.150, Jian Yi Rd, Zhonghe District, New Taipei City,235, Taiwan

2.3 Factory Information

Factory	Kunshan CC&C Technologies, Co., Ltd
Address	No.9 building, 3rd Main Street, Kunshan Free Trade Zone, Jiangsu Province, P. R. China

2.4 General Description for Equipment under Test (EUT)

EUT Name	ac2x2+BT5.0 USB2.0
Model Name Under Test	CM-8822CU-V2
Series Model Name	N/A
Description of Model name differentiation	N/A
Hardware Version	V. A
Software Version	V15(WIFI+BT)
Dimensions (Approx.)	N/A
Weight (Approx.)	N/A

2.5 Technical Information

Network and Wireless connectivity	Bluetooth (BR+EDR+BLE) 2.4G WIFI 802.11b, 802.11g, 802.11n(HT20/40) 5G WIFI 802.11a, 802.11n(HT20/40), 802.11ac(VHT20/40/80) U-NII-1/3
-----------------------------------	---

The requirement for the following technical information of the EUT was tested in this report:

Modulation Technology	FHSS
Modulation Type	GFSK, $\pi/4$ -DQPSK, 8-DPSK
Product Type	<input checked="" type="checkbox"/> Mobile <input type="checkbox"/> Portable <input type="checkbox"/> Fix Location
Transfer Rate	DH5: 1 Mbps 2DH5: 2 Mbps 3DH5: 3 Mbps
Frequency Range	The frequency range used is 2400 MHz to 2483.5 MHz.
Number of Channel	79 (at intervals of 1 MHz)
Tested Channel	0 (2402 MHz), 39 (2441 MHz), 78 (2480 MHz)
Antenna Type	External Antenna
Antenna Gain	2.46 dBi
Antenna Impedance	50 Ω
Antenna System (MIMO Smart Antenna)	N/A

All channel was listed on the following table:

Channel number	Freq. (MHz)	Channel number	Freq. (MHz)	Channel number	Freq. (MHz)	Channel number	Freq. (MHz)
0	2402	21	2423	42	2444	63	2465
1	2403	22	2424	43	2445	64	2466
2	2404	23	2425	44	2446	65	2467
3	2405	24	2426	45	2447	66	2468
4	2406	25	2427	46	2448	67	2469
5	2407	26	2428	47	2449	68	2470
6	2408	27	2429	48	2450	69	2471
7	2409	28	2430	49	2451	70	2472
8	2410	29	2431	50	2452	71	2473
9	2411	30	2432	51	2453	72	2474
10	2412	31	2433	52	2454	73	2475
11	2413	32	2434	53	2455	74	2476
12	2414	33	2435	54	2456	75	2477
13	2415	34	2436	55	2457	76	2478
14	2416	35	2437	56	2458	77	2479
15	2417	36	2438	57	2459	78	2480
16	2418	37	2439	58	2460	-	-
17	2419	38	2440	59	2461	-	-
18	2420	39	2441	60	2462	-	-
19	2421	40	2442	61	2463	-	-
20	2422	41	2443	62	2464	-	-

3 SUMMARY OF TEST RESULTS

3.1 Test Standards

No.	Identity	Document Title
1	47 CFR Part 15, Subpart C	Intentional radiators of radio frequency equipment
2	ANSI C63.10-2013	American National Standard for Testing Unlicensed Wireless Devices
3	KDB 558074 D01 15.247 Meas Guidance v05r02	Guidance for compliance measurements on digital transmission system, frequency hopping spread spectrum system, and hybrid system devices operating under section 15.247 of the FCC rules

3.2 Test Verdict

No.	Description	FCC Part No.	Channel	Test Result	Verdict	Remark
1	Antenna Requirement	15.203	N/A	--	Pass	Note ¹
2	Number of Hopping Frequencies	15.247(a)	Hopping Mode	ANNEX A.1	Pass	Note ^{2/4}
3	Peak Output Power and E.I.R.P	15.247(b)	Low/Middle/High	ANNEX A.2	Pass	Note ⁴
4	Occupied Bandwidth	15.247(a)	Low/Middle/High	ANNEX A.3	Pass	Note ⁴
5	Carrier Frequency Separation	15.247(a)	Hopping Mode	ANNEX A.4	Pass	Note ^{2/4}
6	Time of Occupancy (Dwell time)	15.247(a)	Hopping Mode	ANNEX A.5	Pass	Note ^{2/4}
7	Conducted Spurious Emission & Authorized-band band-edge	15.247(d)	Hopping Mode; Low/Middle/High	ANNEX A.6	Pass	Note ^{2/4}
8	Conducted Emission	15.207	Low/Middle/High	ANNEX A.7	Pass	Note ²
9	Radiated Spurious Emission	15.209 15.247(d)	Low/Middle/High	ANNEX A.8	Pass	Note ²
10	Band Edge(Restricted-band band-edge)	15.209 15.247(d)	Low/High	ANNEX A.9	Pass	Note ²
11	Receiver Spurious Emissions	--	--	--	N/A	Note ³

Note ¹: Please refer to section 5.1

Note ²: $\pi/4$ -DQPSK is the EDR 2M rate mode, 8-DPSK is the EDR 3M rate mode. The consistency of test results in $\pi/4$ -DQPSK and 8-DPSK is very high. So we chose 8-DPSK as a typical representative to appear on the report. Another we will show all the modes on the RF output power test item.

Note ³: Only radio communication receivers operating in stand-alone mode within the band 30-960 MHz, as well as scanner receivers, are subject to Industry Canada requirements, so this test is not applicable.

Note ⁴: Compared with the EUT in the test report BL-EC19A0003-601, the EUT in this report has replaced the radiation antenna, Other hardware circuits and software are the same as those mentioned in the test report BL-EC19A0003-601.

Therefore, so just radiation test of Conducted Emissions, Radiated Spurious Emissions and Band Edge (Restricted-band band-edge) were retested in this report. Other test items please refer to the report BL-EC19A0003-601 issued by Shenzhen BALUN Technology Co., Ltd. on December 12, 2019 for all test data.

4 GENERAL TEST CONFIGURATIONS

4.1 Test Environments

During the measurement, the normal environmental conditions were within the listed ranges:

Relative Humidity	43% to 55%	
Atmospheric Pressure	100 kPa to 102 kPa	
Temperature	NT (Normal Temperature)	+20.4°C to +24.2°C
Working Voltage of the EUT	NV (Normal Voltage)	DC 3.3 V

4.2 Test Equipment List

Description	Manufacturer	Model	Serial No.	Cal. Date	Cal. Due
Spectrum Analyzer	ROHDE&SCHWARZ	FSV-40	101544	2022.01.04	2023.01.03
Spectrum Analyzer	KEYSIGHT	N9020A	MY50531259	2022.09.06	2023.09.05
Signaling Unit	ROHDE&SCHWARZ	CMW500	171150	2022.06.29	2023.06.28
Test Antenna-Horn(1-18 GHz)	SCHWARZBECK	BBHA 9120D	02460	2021.05.19	2024.05.08
Test Antenna-Horn (18-40 GHz)	A-INFO	LB-180400KF	J211060273	2021.07.02	2024.07.01
Anechoic Chamber	RAINFORD	9m*6m*6m	N/A	2021.08.16	2024.08.15
EMI Receiver	ROHDE&SCHWARZ	ESRP	101036	2022.09.09	2023.09.08
Test Antenna-Bi-Log(30 MHz-1 GHz)	SCHWARZBECK	VULB 9168	00883	2022.04.01	2025.03.31
Test Antenna-Loop(9 kHz-30 MHz)	SCHWARZBECK	FMZB 1519	1519-037	2021.04.16	2024.04.15
Anechoic Chamber	EMC Electronic Co., Ltd	20.10*11.60 *7.35m	N/A	2021.08.15	2024.08.14
EMI Receiver	KEYSIGHT	N9010B	MY57110309	2022.09.09	2023.09.08
LISN	SCHWARZBECK	NSLK 8127	8127-687	2022.06.01	2023.05.31
Shielded Enclosure	YiHeng Electronic Co., Ltd	3.5m*3.1m*2.8m	N/A	2022.02.19	2025.02.18
Amplifier (1-12GHz)	COM-MV	LSCX_LNA 1-12G-01	180602	2020.09.08	2023.09.07
Amplifier (7-18GHz)	COM-MV	XKu_LNA7-18G-01	180601	2020.09.08	2023.09.07
Amplifier (18-40GHz)	COM-MV	KA_LNA18-40G-01	18050001	2020.09.08	2023.09.07

4.3 Test Software List

Description	Manufacturer	Software Version	Serial No.	Applicable test Setup
BL410R	BALUN	V2.1.1.488	N/A	The section 4.5.1
BL410E	BALUN	V19.8.28.435	N/A	The section 4.5.2&4.5.3&4.5.4&4.5.5

4.4 Measurement Uncertainty

The following measurement uncertainty levels have been estimated for tests performed on the EUT as specified in CISPR 16-4-2.

This uncertainty represents an expanded uncertainty expressed at approximately the 95% confidence level using a coverage factor of k=2.

Parameters	Uncertainty
Occupied Channel Bandwidth	2.8%
RF output power, conducted	1.28 dB
Power Spectral Density, conducted	1.30 dB
Unwanted Emissions, conducted	1.84 dB
All emissions, radiated	5.36 dB
Temperature	0.82°C
Humidity	4.1%

4.5 Description of Test Setup

4.5.1 For Antenna Port Test

Conducted value (dBm) = Measurement value (dBm) + cable loss (dB)

For example: the measurement value is 10 dBm and the cable 0.5dBm used, then the final result of EUT:
 Conducted value (dBm) = 10 dBm + 0.5 dB = 10.5 dBm

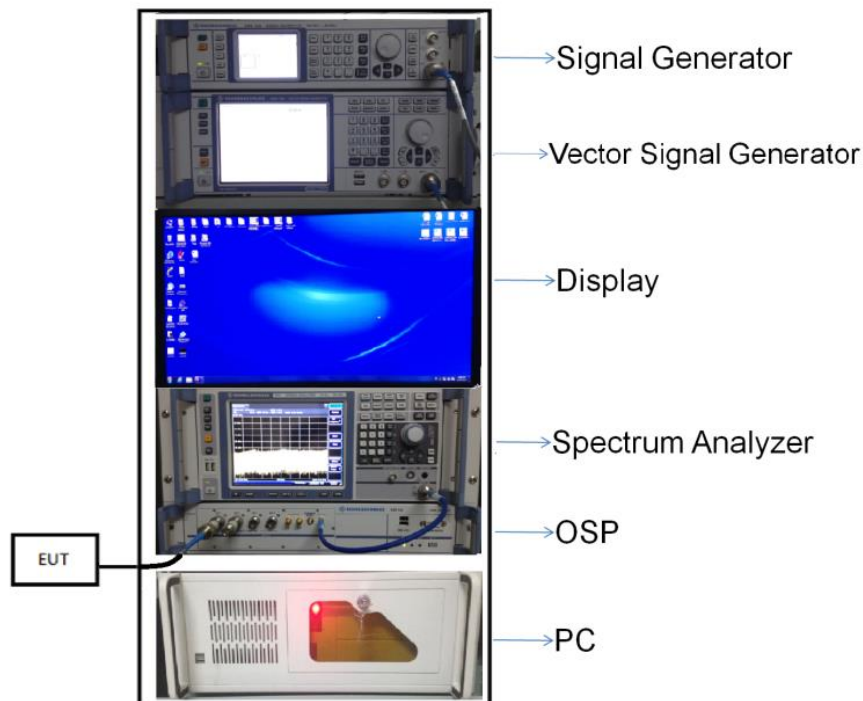

(Diagram 1)

4.5.2 For AC Power Supply Port Test

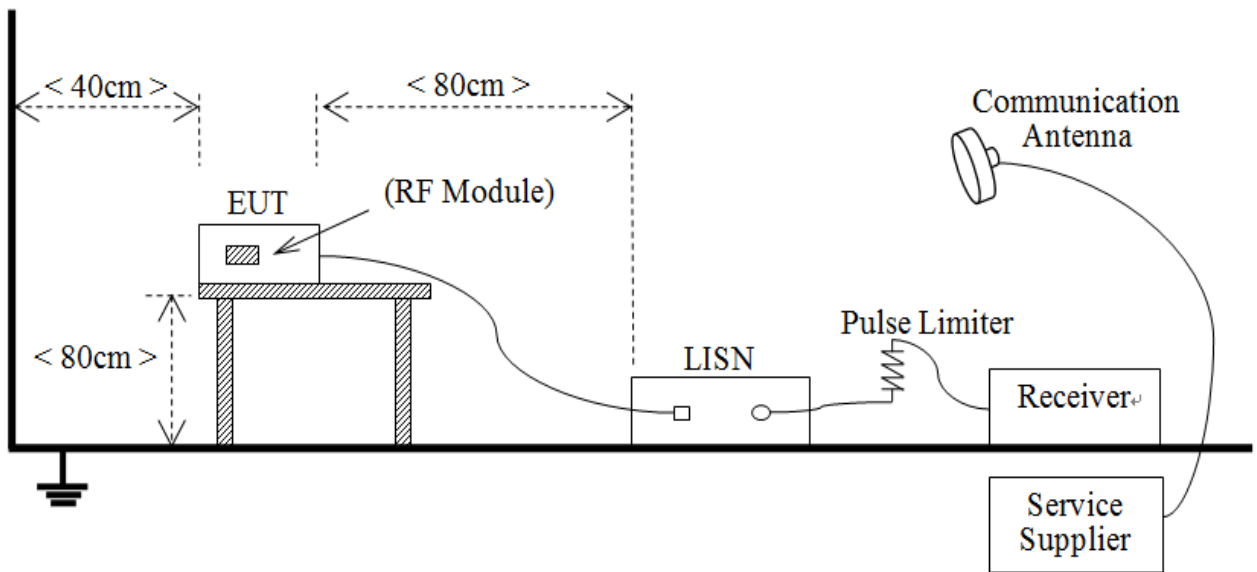

(Diagram 2)

4.5.3 For Radiated Test (Below 30 MHz)

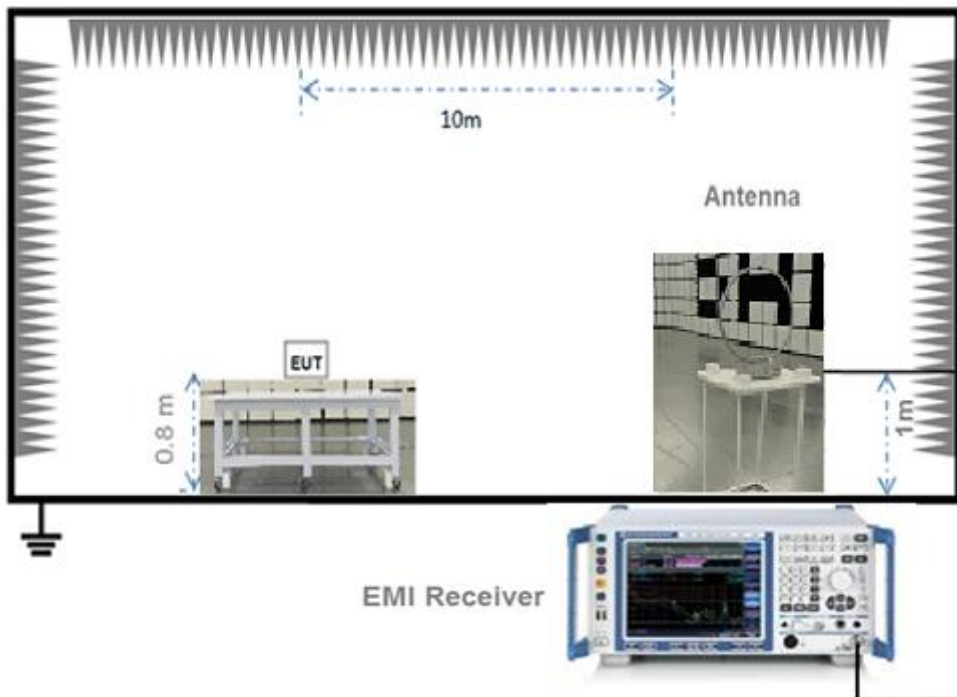

(Diagram 3)

4.5.4 For Radiated Test (30 MHz-1 GHz)

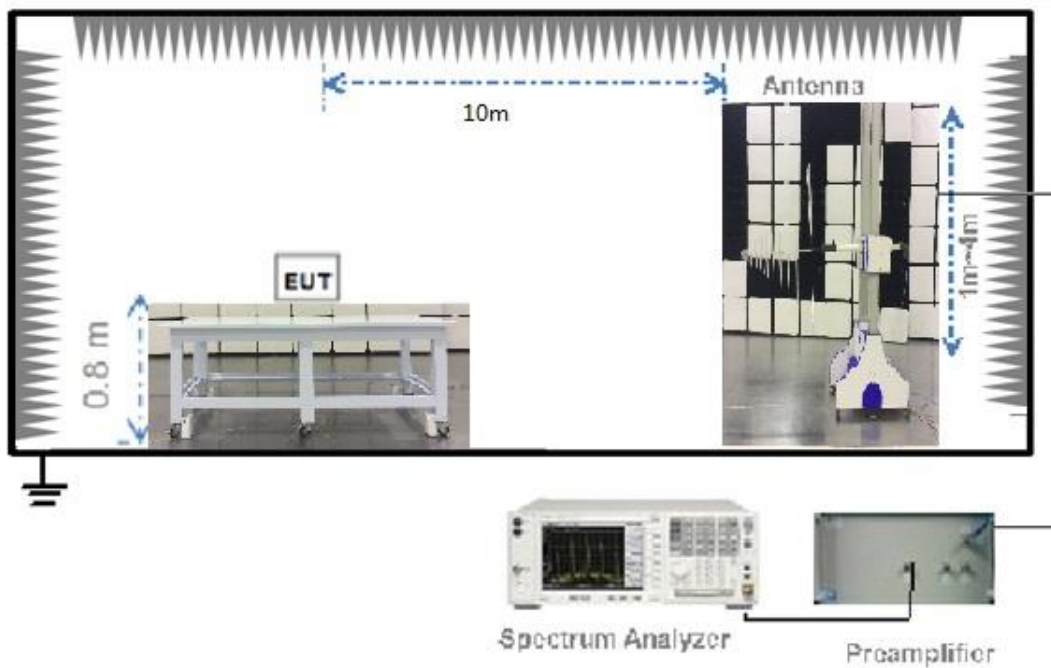

(Diagram 4)

4.5.5 For Radiated Test (Above 1 GHz)

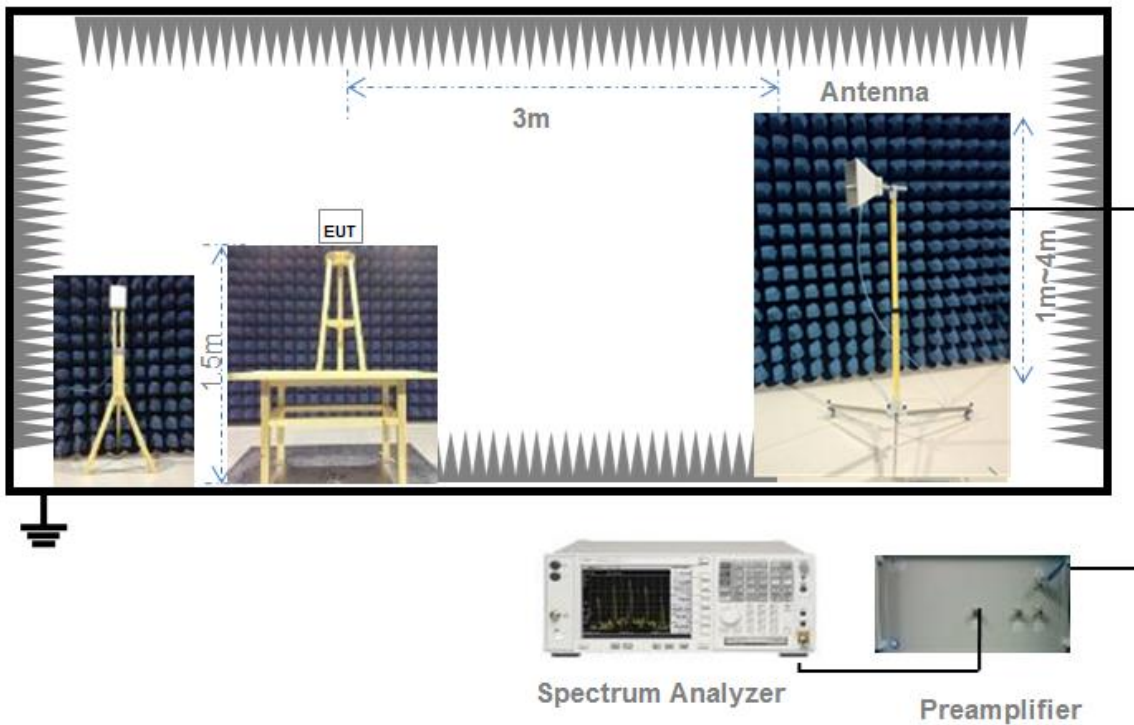

(Diagram 5)

4.6 Measurement Results Explanation Example

4.6.1 For conducted test items:

The offset level is set in the spectrum analyzer to compensate the RF cable loss and attenuator between EUT conducted output port and spectrum analyzer. With the offset compensation, the spectrum analyzer reading level is exactly the EUT RF output level.

The spectrum analyzer offset is derived from RF cable loss and attenuator factor.

Offset = RF cable loss + attenuator factor.

5 TEST ITEMS

5.1 Antenna Requirements

5.1.1 Relevant Standards

FCC §15.203 & 15.247(b)

An intentional radiator shall be designed to ensure that no antenna other than that furnished by the responsible party shall be used with the device. The use of a permanently attached antenna or of an antenna that uses a unique coupling to the intentional radiator shall be considered sufficient to comply with the provisions of this section. The manufacturer may design the unit so that a broken antenna can be replaced by the user, but the use of a standard antenna jack or electrical connector is prohibited. This requirement does not apply to carrier current devices or to devices operated under the provisions of § 15.211, § 15.213, § 15.217, § 15.219, or § 15.221. Further, this requirement does not apply to intentional radiators that must be professionally installed, such as perimeter protection systems and some field disturbance sensors, or to other intentional radiators which, in accordance with § 15.31(d), must be measured at the installation site. However, the installer shall be responsible for ensuring that the proper antenna is employed so that the limits in this part are not exceeded.

If directional gain of transmitting antennas is greater than 6 dBi, the power shall be reduced by the same level in dB comparing to gain minus 6 dBi. For the fixed point-to-point operation, the power shall be reduced by one dB for every 3 dB that the directional gain of the antenna exceeds 6 dBi. The use of a permanently attached antenna or of an antenna that uses a unique coupling to the intentional radiator shall be considered sufficient to comply with the FCC rule.

5.1.2 Antenna Anti-Replacement Construction

The Antenna Anti-Replacement as following method:

Protected Method	Description
The antenna is embedded in the product.	An embedded-in antenna design is used.

Reference Documents	Item
Photo	Please refer to the EUT Photo documents.

5.1.3 Antenna Gain

The antenna peak gain of EUT is less than 6 dBi. Therefore, it is not necessary to reduce maximum peak output power limit.

5.2 Frequency Hopping Systems

5.2.1 Relevant Standards

FCC §15.247(a) (1) (i) (ii) (iii) (iv); FCC §15.247(g); FCC §15.247(h)

Describe how the hopping sequence is generated. Provide an example of the hopping sequence channels, to demonstrate that the sequence meets the requirement specified in the definition of an FHSS system. Per the definition in Section 2.1(c), the hop set shall appear as random in the near term, shall appear as evenly distributed in the long term, and sequential hops shall be randomly distributed in both direction and magnitude of change.

Describe how each individual EUT meets the requirement that each of its hopping channels is used equally on average (e.g., that each new transmission event begins on the next channel in the hopping sequence after the final channel used in the previous transmission event).

Describe how the associated receiver(s) complies with the requirement that the input bandwidth (either RF or IF) matches the bandwidth of the transmitted signal.

Describe how the associated receiver(s) has the ability to shift frequencies in synchronization with the transmitted signals.

For short burst systems, describe how the EUT complies with the requirement that it be designed to be capable of operating as a true frequency hopping system. Specifically, the device shall comply with the equal frequency use and pseudorandom hopping sequence requirement when transmitting in short bursts, and shall be designed to comply when presented with continuous data (or information) stream.

Describe how the EUT complies with the requirement that it not have the ability to be coordinated with other FHSS systems in an effort to avoid the simultaneous occupancy of individual hopping frequencies by multiple transmitters.

5.2.2 Description of the systems

1. According to the preset procedure of the whole network, all the stations in the automatic control network synchronously change the frequency multiple times within one second, and temporarily stay on each frequency hopping channel. Periodic synchronization signaling is sent from the primary station, instructing all slaves to simultaneously change the operating frequency, then the hopping sequence is generated.
2. The hop set shall appear as random in the near term, shall appear as evenly distributed in the long term, and sequential hops shall be randomly distributed in both direction and magnitude of change.

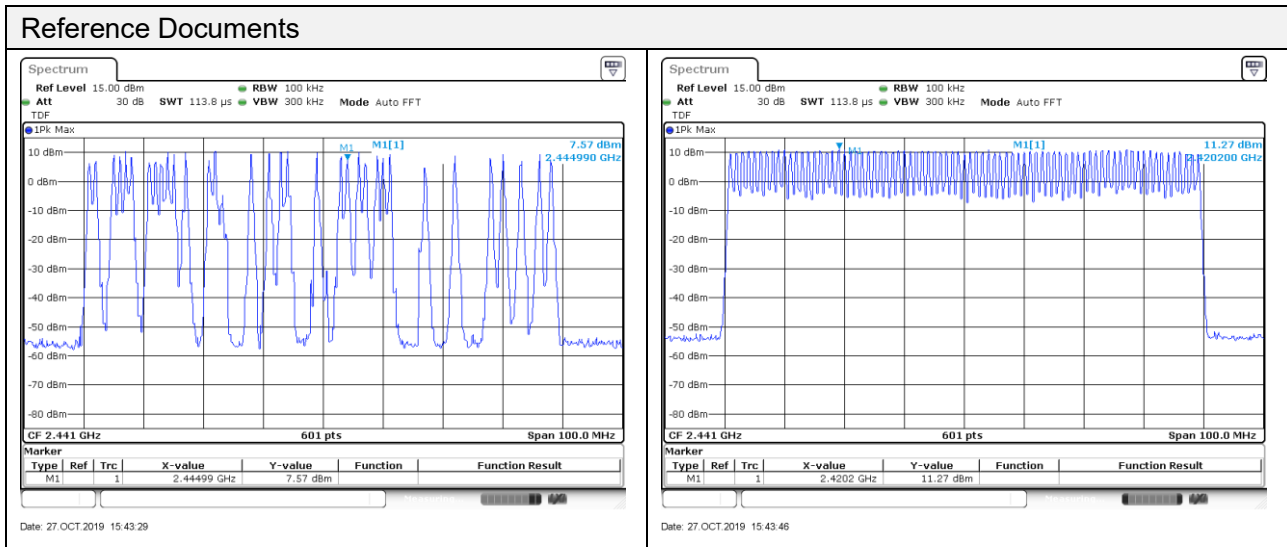

3. Channels are classified into two categories, used and unused, where used channels are part of the hopping sequence and unused channels are replaced in the hopping sequence by used channels in a pseudo-random way. Make each individual EUT meets the requirement that each of its hopping channels is used equally on average.
4. The input bandwidth and transmitted bandwidth are both 1MHz, the associated receiver(s) complies with the requirement that the input bandwidth matches the bandwidth of the transmitted signal.
5. Connected devices communicate on the same physical channel by synchronizing with a common clock and hopping sequence.
6. EUT isn't short burst systems.
7. EUT can't have the ability to be coordinated with other FHSS systems in an effort.

5.3 Number of Hopping Frequencies

5.3.1 Limit

FCC §15.247(a) (1) (iii)

Frequency hopping systems operating in the 2400 MHz to 2483.5 MHz bands shall use at least 15 hopping frequencies.

5.3.2 Test Setup

See section 4.5.1 for test setup description for the antenna port. The photo of test setup please refer to ANNEX B.

5.3.3 Test Procedure

The EUT must have its hopping function enabled. Use the following spectrum analyzer settings:

Span = The frequency band of operation

RBW = To identify clearly the individual channels, set the RBW to less than 30% of the channel spacing or the 20 dB bandwidth, whichever is smaller.

VBW \geq RBW

Sweep = auto

Detector function = peak

Trace = max hold

Allow the trace to stabilize

5.3.4 Test Result

Please refer to ANNEX A.1.

5.4 Peak Output Power and E.I.R.P

5.4.1 Test Limit

FCC § 15.247(b)

For frequency hopping systems operating in the 2400-2483.5 MHz band employing at least 75 non-overlapping hopping channels band: 1 watt. For all other frequency hopping systems in the 2400-2483.5 MHz band: 0.125 watts.

5.4.2 Test Setup

See section 4.5.1 for test setup description for the antenna port. The photo of test setup please refer to ANNEX B.

5.4.3 Test Procedure

The Module operates at hopping-off test mode. The lowest, middle and highest channels are selected to perform testing to verify the conducted RF output peak power of the Module.

Use the following spectrum analyzer settings:

Span = approximately 5 times the 20 dB bandwidth, centered on a hopping channel

RBW > the 20 dB bandwidth of the emission being measured

VBW \geq RBW

Sweep = auto

Detector function = peak

Trace = max hold

Allow the trace to stabilize.

5.4.4 Test Result

Please refer to ANNEX A.2.

5.5 Occupied Bandwidth

5.5.1 Limit

FCC §15.247(a)

Measurement of the 20dB bandwidth of the modulated signal.

5.5.2 Test Setup

See section 4.5.1 for test setup description for the antenna port. The photo of test setup please refer to ANNEX B.

5.5.3 Test Procedure

Use the following spectrum analyzer settings:

Span = approximately 2 to 5 times the 20 dB bandwidth, centered on a hopping channel

RBW = in the range of 1% to 5% of the OBW

VBW \geq RBW

Sweep = auto

Detector function = peak

Trace = max hold

The EUT should be transmitting at its maximum data rate, Allow the trace to stabilize.

5.5.4 Test Result

Please refer to ANNEX A.3.

5.6 Carrier Frequency Separation

5.6.1 Limit

FCC §15.247(a)

Frequency hopping systems shall have hopping channel carrier frequencies separated by a minimum of 25 kHz or the 2/3 of the 20 dB bandwidth of the hopping channel, whichever is greater.

5.6.2 Test Setup

See section 4.5.1 for test setup description for the antenna port. The photo of test setup please refer to ANNEX B.

5.6.3 Test Procedure

The EUT must have its hopping function enabled. Use the following spectrum analyzer settings:

Span = wide enough to capture the peaks of two adjacent channels

Resolution (or IF) Bandwidth (RBW) \geq 1% of the span

Video (or Average) Bandwidth (VBW) \geq RBW

Sweep = auto

Detector function = peak

Trace = max hold

Allow the trace to stabilize. Use the marker-delta function to determine the separation between the peaks of the adjacent channels.

5.6.4 Test Result

Please refer to ANNEX A.4.

5.7 Time of Occupancy (Dwell time)

5.7.1 Limit

FCC §15.247(a)

Frequency hopping systems in the 2400 MHz - 2483.5 MHz band shall use at least 15 non-overlapping channels. The average time of occupancy on any channel shall not be greater than 0.4 seconds within a period of 0.4 seconds multiplied by the number of hopping channels employed. Frequency hopping systems may avoid or suppress transmissions on a particular hopping frequency provided that a minimum of 15 channels are used.

5.7.2 Test Setup

See section 4.5.1 for test setup description for the antenna port. The photo of test setup please refer to ANNEX B.

5.7.3 Test Procedure

The EUT shall have its hopping function enabled. Use the following spectrum analyzer settings:

Span: Zero span, centered on a hopping channel

RBW shall be \leq channel spacing and where possible RBW should be set $\gg 1 / T$, where T is the expected dwell time per channel

Sweep: As necessary to capture the entire dwell time per hopping channel; where possible use a video trigger and trigger delay so that the transmitted signal starts a little to the right of the start of the plot. The trigger level might need slight adjustment to prevent triggering when the system hops on an adjacent channel; a second plot might be needed with a longer sweep time to show two successive hops on a channel

Detector function: Peak

Trace: Max hold

Use the marker-delta function to determine the transmit time per hop. If this value varies with different modes of operation (data rate, modulation format, number of hopping channels, etc.), then repeat this test for each variation in transmit time.

The average time of occupancy on any channel within the Period can be calculated with formulas:

For GFSK and 8-DPSK:

For DH1 package type

$$\{\text{Total of Dwell}\} = \{\text{Pulse Time}\} * (1600 / 2) / \{\text{Number of Hopping Frequency}\} * \{\text{Period}\}$$

$$\{\text{Period}\} = 0.4 \text{ s} * \{\text{Number of Hopping Frequency}\}$$

For DH3 package type

$$\{\text{Total of Dwell}\} = \{\text{Pulse Time}\} * (1600 / 4) / \{\text{Number of Hopping Frequency}\} * \{\text{Period}\}$$

$$\{\text{Period}\} = 0.4 \text{ s} * \{\text{Number of Hopping Frequency}\}$$

For DH5 package type

$$\{\text{Total of Dwell}\} = \{\text{Pulse Time}\} * (1600 / 6) / \{\text{Number of Hopping Frequency}\} * \{\text{Period}\}$$

$$\{\text{Period}\} = 0.4 \text{ s} * \{\text{Number of Hopping Frequency}\}$$

For AFH Mode:

For DH1 package type

$$\{\text{Total of Dwell}\} = \{\text{Pulse Time}\} * (800 / 2) / \{\text{Number of Hopping Frequency}\} * \{\text{Period}\}$$

{Period} = 0.4 s * {Number of Hopping Frequency}

For DH3 package type

{Total of Dwell} = {Pulse Time} * (800 / 4) / {Number of Hopping Frequency} * {Period}

{Period} = 0.4 s * {Number of Hopping Frequency}

For DH5 package type

{Total of Dwell} = {Pulse Time} * (800 / 6) / {Number of Hopping Frequency} * {Period}

{Period} = 0.4 s * {Number of Hopping Frequency}

The lowest, middle and highest channels are selected to perform testing to record the dwell time of each occupation measured in this channel, which is called Pulse Time here.

5.7.4 Test Result

Please refer to ANNEX A.5.

5.8 Conducted Spurious Emission & Authorized-band band-edge

5.8.1 Limit

FCC §15.247(d)

In any 100 kHz bandwidth outside the frequency band in which the spread spectrum or digitally modulated intentional radiator is operating, the radio frequency power that is produced by the intentional radiator shall be at least 20 dB below that in the 100 kHz bandwidth within the band that contains the highest level of the desired power, based on either an RF conducted or a radiated measurement.

5.8.2 Test Setup

See section 4.5.1 for test setup description for the antenna port. The photo of test setup please refer to ANNEX B.

5.8.3 Test Procedure

Use the following spectrum analyzer settings:

Span = wide enough to capture the peak level of the in-band emission and all spurious emissions (e.g., harmonics) from the lowest frequency generated in the EUT up through the 10th harmonic. Typically, several plots are required to cover this entire span.

RBW = 100 kHz

VBW = 300 kHz

Sweep = auto

Detector function = peak

Trace = max hold

Allow the trace to stabilize

5.8.4 Test Result

Please refer to ANNEX A.6.

5.9 Conducted Emission

5.9.1 Limit

FCC §15.207

For an intentional radiator that is designed to be connected to the public utility (AC) power line, the radio frequency voltage that is conducted back onto the AC power line on any frequency within the band 150 kHz to 30 MHz shall not exceed the limits in the following table, as measured using a 50 μ H/50 Ω line impedance stabilization network (LISN).

Frequency range (MHz)	Conducted Limit (dB μ V)	
	Quai-peak	Average
0.15 - 0.50	66 to 56	56 to 46
0.50 - 5	56	46
0.50 - 30	60	50

5.9.2 Test Setup

See section 4.5.2 for test setup description for the AC power supply port. The photo of test setup please refer to ANNEX B.

5.9.3 Test Procedure

The maximum conducted interference is searched using Peak (PK), if the emission levels more than the AV and QP limits, and that have narrow margins from the AV and QP limits will be re-measured with AV and QP detectors. Tests for both L phase and N phase lines of the power mains connected to the EUT are performed. Refer to recorded points and plots below.

Devices subject to Part 15 must be tested for all available U.S. voltages and frequencies (such as a nominal 120 VAC, 50/60 Hz and 240 VAC, 50/60 Hz) for which the device is capable of operation. A device rated for 50/60 Hz operation need not be tested at both frequencies provided the radiated and line conducted emissions are the same at both frequencies.

5.9.4 Test Result

Please refer to ANNEX A.7.

5.10 Radiated Spurious Emission

5.10.1 Limit

FCC §15.209&15.247(d)

Radiated emission outside the frequency band attenuation below the general limits specified in FCC section 15.209(a) is not required. In addition, radiated emissions which fall in the restricted bands, as defined in FCC section 15.205(a), must also comply with the radiated emission limits specified in FCC section 15.209(a).

According to FCC section 15.209 (a), except as provided elsewhere in this subpart, the emissions from an intentional radiator shall not exceed the field strength levels specified in the following table:

Frequency (MHz)	Field Strength ($\mu\text{V}/\text{m}$)	Measurement Distance (m)
0.009 - 0.490	2400/F(kHz)	300
0.490 - 1.705	24000/F(kHz)	30
1.705 - 30.0	30	30
30 - 88	100	3
88 - 216	150	3
216 - 960	200	3
Above 960	500	3

Note:

1. Field Strength (dB $\mu\text{V}/\text{m}$) = 20*log[Field Strength ($\mu\text{V}/\text{m}$)].
2. In the emission tables above, the tighter limit applies at the band edges.
3. For Above 1000 MHz, the emission limit in this paragraph is based on measurement instrumentation employing an average detector, measurement using instrumentation with a peak detector function, corresponding to 20dB above the maximum permitted average limit.
4. For above 1000 MHz, limit field strength of harmonics: 54dB $\mu\text{V}/\text{m}$ @3m (AV) and 74dB $\mu\text{V}/\text{m}$ @3m (PK).

5.10.2 Test Setup

See section 4.5.3 to 4.5.5 for test setup description for the antenna port. The photo of test setup please refer to ANNEX B.

5.10.3 Test Procedure

The measurement frequency range is from 9 kHz to the 10th harmonic of the fundamental frequency. The Turn Table is actuated to turn from 0° to 360°, and both horizontal and vertical polarizations of the Test Antenna are used to find the maximum radiated power. Mid channels on all channel bandwidth verified. Only the worst RB size/offset presented.

The power of the EUT transmitting frequency should be ignored.

All Spurious Emission tests were performed in X, Y, Z axis direction. And only the worst axis test condition was recorded in this test report.

Use the following spectrum analyzer settings:

Span = wide enough to fully capture the emission being measured

RBW = 1 MHz for $f \geq 1$ GHz, 100 kHz for $f < 1$ GHz

VBW \geq RBW

Sweep = auto

Detector function = peak

Trace = max hold

For measurement below 1GHz, If the emission level of the EUT measured by the peak detector is 3 dB lower than the applicable limit, the peak emission level will be reported, Otherwise, the emission measurement will be repeated using the quasi-peak detector and reported.

5.10.4 Test Result

Please refer to ANNEX A.8.

5.11 Band Edge (Restricted-band band-edge)

5.11.1 Limit

FCC §15.209&15.247(d)

Radiated emission outside the frequency band attenuation below the general limits specified in FCC section 15.209(a) is not required. In addition, radiated emissions which fall in the restricted bands, as defined in FCC section 15.205(a), must also comply with the radiated emission limits specified in FCC section 15.209(a).

5.11.2 Test Setup

See section 4.5.3 to 4.5.5 for test setup description for the antenna port. The photo of test setup please refer to ANNEX B.

5.11.3 Test Procedure

The measurement frequency range is from 9 kHz to the 10th harmonic of the fundamental frequency. The Turn Table is actuated to turn from 0° to 360°, and both horizontal and vertical polarizations of the Test Antenna are used to find the maximum radiated power. Mid channels on all channel bandwidth verified. Only the worst RB size/offset presented.

The power of the EUT transmitting frequency should be ignored.

All Spurious Emission tests were performed in X, Y, Z axis direction. And only the worst axis test condition was recorded in this test report.

Use the following spectrum analyzer settings:

Span = wide enough to fully capture the emission being measured

RBW = 1 MHz for $f \geq 1$ GHz, 100 kHz for $f < 1$ GHz

VBW \geq RBW

Sweep = auto

Detector function = peak

Trace = max hold

For measurement below 1GHz, If the emission level of the EUT measured by the peak detector is 3 dB lower than the applicable limit, the peak emission level will be reported, Otherwise, the emission measurement will be repeated using the quasi-peak detector and reported.

5.11.4 Test Result

Please refer to ANNEX A.9.

ANNEX A TEST RESULT

A.1 Number of Hopping Frequency

Note: The Number of Hopping Frequency please refer to report: BL-EC19A0003-601, which was issued by Shenzhen BALUN Technology Co., Ltd. on Dec. 12, 2019, **section A.1 Number of Hopping Frequency.**

A.2 Peak Output Power and E.I.R.P

Note: The Peak Output Power and E.I.R.P please refer to report: BL-EC19A0003-601, which was issued by Shenzhen BALUN Technology Co., Ltd. on Dec. 12, 2019, **section A.2 Peak Output Power and E.I.R.P.**

A.3 20 dB and 99% bandwidth

Note: The 20 dB and 99% bandwidth please refer to report: BL-EC19A0003-601, which was issued by Shenzhen BALUN Technology Co., Ltd. on Dec. 12, 2019, **section A.3 20 dB and 99% bandwidth.**

A.4 Hopping Frequency Separation

Note: The Hopping Frequency Separation please refer to report: BL-EC19A0003-601, which was issued by Shenzhen BALUN Technology Co., Ltd. on Dec. 12, 2019, **section A.4 Hopping Frequency Separation.**

A.5 Average Time of Occupancy

Note: The Average Time of Occupancy please refer to report: BL-EC19A0003-601, which was issued by Shenzhen BALUN Technology Co., Ltd. on Dec. 12, 2019, **section A.5 Average Time of Occupancy.**

A.6 Conducted Spurious Emissions & Authorized-band band-edge

Note: The Conducted Spurious Emissions & Authorized-band band-edge please refer to report: BL-EC19A0003-601, which was issued by Shenzhen BALUN Technology Co., Ltd. on Dec. 12, 2019, **section A.6 Conducted Spurious Emissions & Authorized-band band-edge.**

A.7 Conducted Emissions

Note ¹: The EUT is working in the Normal link mode. All modes have been tested and normal link mode is worst.

Note ²: Devices subject to Part 15 must be tested for all available U.S. voltages and frequencies (such as a nominal 120 VAC, 60 Hz and 240 VAC, 50 Hz) for which the device is capable of operation. So, The configuration 120 VAC, 60 Hz and 240 VAC, 50 Hz were tested respectively, but only the worst configuration (120 VAC, 60 Hz) shown here.

Note ³: Results (dBuV) = Original reading level of Spectrum Analyzer (dBuV) + Factor (dB)

Test Data and Plots

PHASE L

CE Test case_FCC_CE_FCC PART 15B_Class B

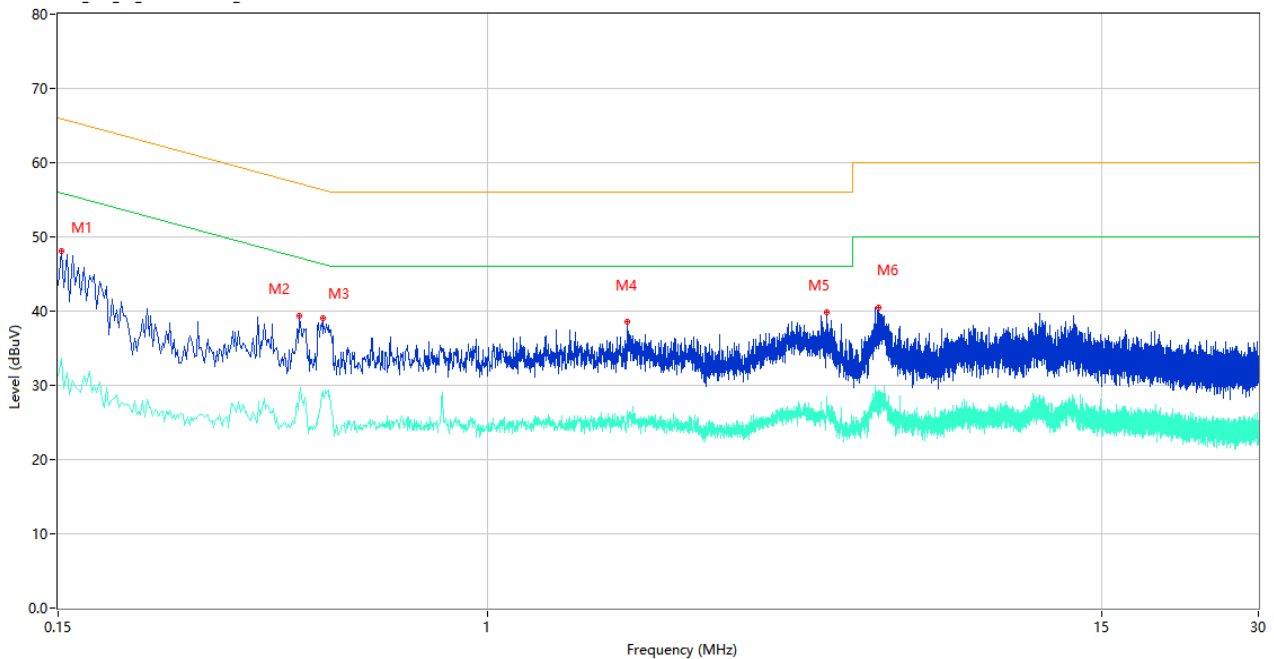

No.	Frequency (MHz)	Results (dBuV)	Factor (dB)	Limit (dBuV)	Margin (dB)	Detector	Line	Verdict
1	0.152	48.13	10.09	65.89	17.76	Peak	L	Pass
1**	0.152	33.59	10.09	55.89	22.30	AV	L	Pass
2	0.434	39.29	10.39	57.18	17.89	Peak	L	Pass
2**	0.434	28.69	10.39	47.18	18.49	AV	L	Pass
3	0.482	39.13	10.19	56.30	17.17	Peak	L	Pass
3**	0.482	29.25	10.19	46.30	17.05	AV	L	Pass
4	1.854	38.51	10.26	56.00	17.49	Peak	L	Pass
4**	1.854	26.56	10.26	46.00	19.44	AV	L	Pass
5	4.470	39.92	10.31	56.00	16.08	Peak	L	Pass
5**	4.470	28.51	10.31	46.00	17.49	AV	L	Pass
6	5.608	40.48	10.43	60.00	19.52	Peak	L	Pass
6**	5.608	27.36	10.43	50.00	22.64	AV	L	Pass

PHASE N

CE Test case_FCC_CE_FCC PART 15B_Class B

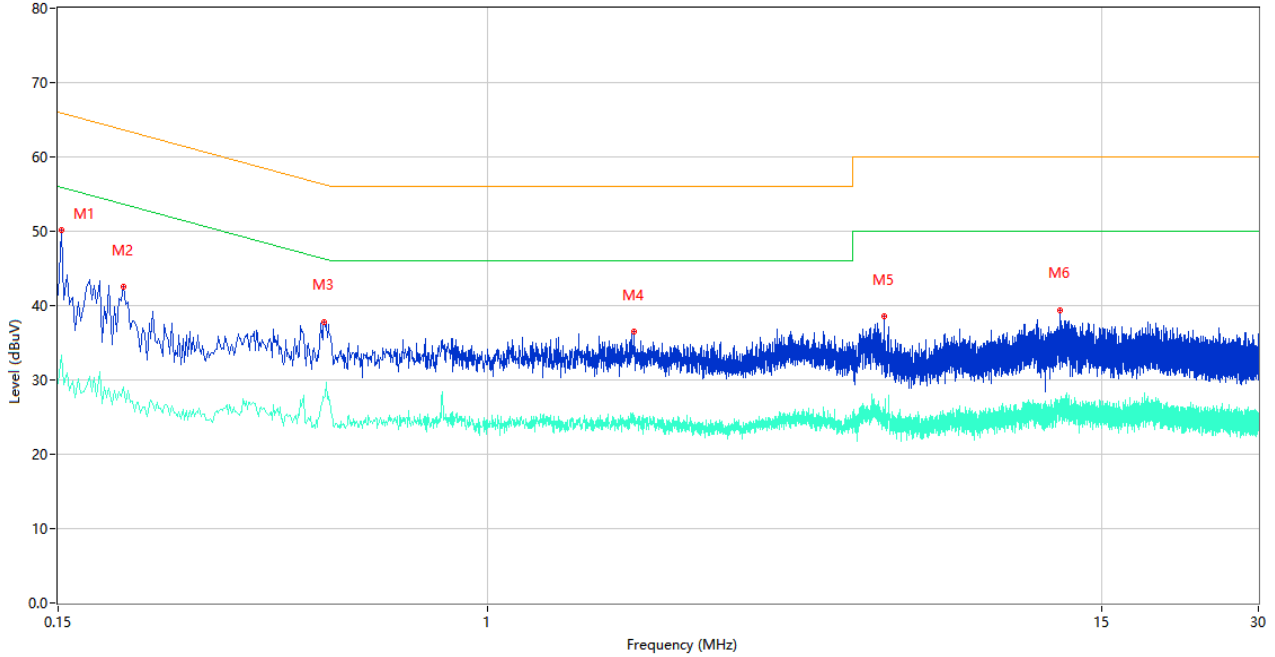

No.	Frequency (MHz)	Results (dBuV)	Factor (dB)	Limit (dBuV)	Margin (dB)	Detector	Line	Verdict
1	0.152	50.19	10.09	65.89	15.70	Peak	N	Pass
1**	0.152	33.29	10.09	55.89	22.60	AV	N	Pass
2	0.200	42.54	10.05	63.61	21.07	Peak	N	Pass
2**	0.200	29.00	10.05	53.61	24.61	AV	N	Pass
3	0.486	37.80	10.19	56.24	18.44	Peak	N	Pass
3**	0.486	27.66	10.19	46.24	18.58	AV	N	Pass
4	1.910	36.46	10.70	56.00	19.54	Peak	N	Pass
4**	1.910	24.72	10.70	46.00	21.28	AV	N	Pass
5	5.740	38.50	10.62	60.00	21.50	Peak	N	Pass
5**	5.740	25.09	10.62	50.00	24.91	AV	N	Pass
6	12.504	39.38	10.33	60.00	20.62	Peak	N	Pass
6**	12.504	26.49	10.33	50.00	23.51	AV	N	Pass

A.8 Radiated Spurious Emission

Note ¹: The symbol of "--" in the table which means not application.

Note ²: For the test data above 1 GHz, according the ANSI C63.10-2013, where limits are specified for both average and peak (or quasi-peak) detector functions, if the peak (or quasi-peak) measured value complies with the average limit, it is unnecessary to perform an average measurement.

Note ³: The EUT is working in the Normal link mode below 1 GHz. All modes have been tested and DH5-Hopping mode is the worst.

Note ⁴: Results (dBuV/m) = Original reading level of Spectrum Analyzer (dBuV/m) + Factor (dB)

The low frequency, which started from 9 kHz to 30 MHz, was pre-scanned and the result which was 20 dB lower than the limit line per 15.31(o) was not reported.

Test Data and Plots

30 MHz to 1 GHz, ANT H

10m RE Test Case_FCC Certification_FCC 15B ClassB 30MHz-1GHz

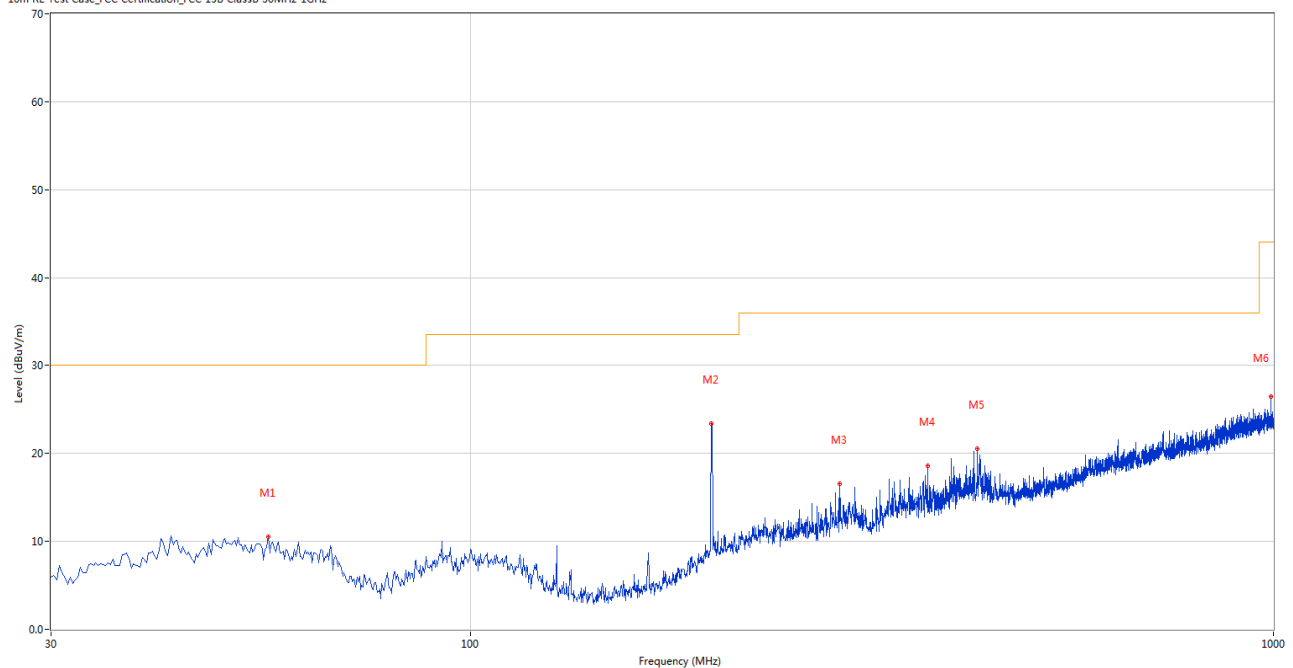

No.	Frequency (MHz)	Results (dBuV/m)	Factor (dB)	Limit (dBuV/m)	Margin (dB)	Detector	Table (Degree)	Height (cm)	Antenna	Verdict
1	55.941	10.49	-26.78	30.0	19.51	Peak	47.00	100	Horizontal	Pass
2	199.223	23.41	-27.79	33.5	10.09	Peak	205.00	200	Horizontal	Pass
3	287.956	16.57	-25.19	36.0	19.43	Peak	7.00	200	Horizontal	Pass
4	370.870	18.61	-23.40	36.0	17.39	Peak	245.00	200	Horizontal	Pass
5	427.843	20.58	-21.70	36.0	15.42	Peak	137.00	200	Horizontal	Pass
6	992.000	26.50	-11.46	44.0	17.50	Peak	242.00	100	Horizontal	Pass

30 MHz to 1 GHz, ANT V

10m RE Test Case_FCC Certification_FCC 15B ClassB 30MHz-1GHz

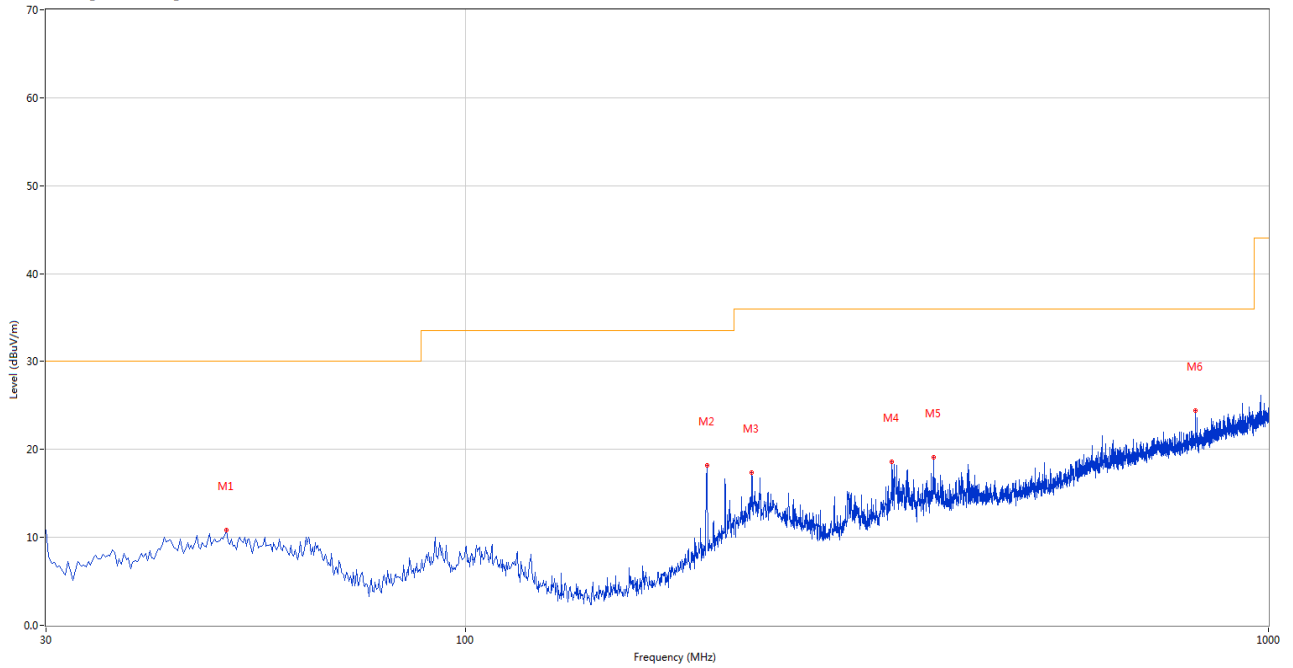

No.	Frequency (MHz)	Results (dBuV/m)	Factor (dB)	Limit (dBuV/m)	Margin (dB)	Detector	Table (Degree)	Height (cm)	Antenna	Verdict
1	50.365	10.79	-26.23	30.0	19.21	Peak	90.00	100	Vertical	Pass
2	199.708	18.21	-27.78	33.5	15.29	Peak	0.00	200	Vertical	Pass
3	227.103	17.38	-27.09	36.0	18.62	Peak	282.00	100	Vertical	Pass
4	339.595	18.61	-23.81	36.0	17.39	Peak	356.00	100	Vertical	Pass
5	382.749	19.11	-22.95	36.0	16.89	Peak	4.00	100	Vertical	Pass
6	810.897	24.40	-14.47	36.0	11.60	Peak	0.00	200	Vertical	Pass

Note 1: The marked spikes near 2400 MHz with circle should be ignored because they are Fundamental signal.

Note 2: The spurious from 18GHz-25GHz is noise only, do not show on the report.

GFSK LOW CHANNEL 1 GHz to 18 GHz, ANT H

RSE (SRD)_FCC Part 15C_FCC 15.247(2.4G)_1GHz-18GHz

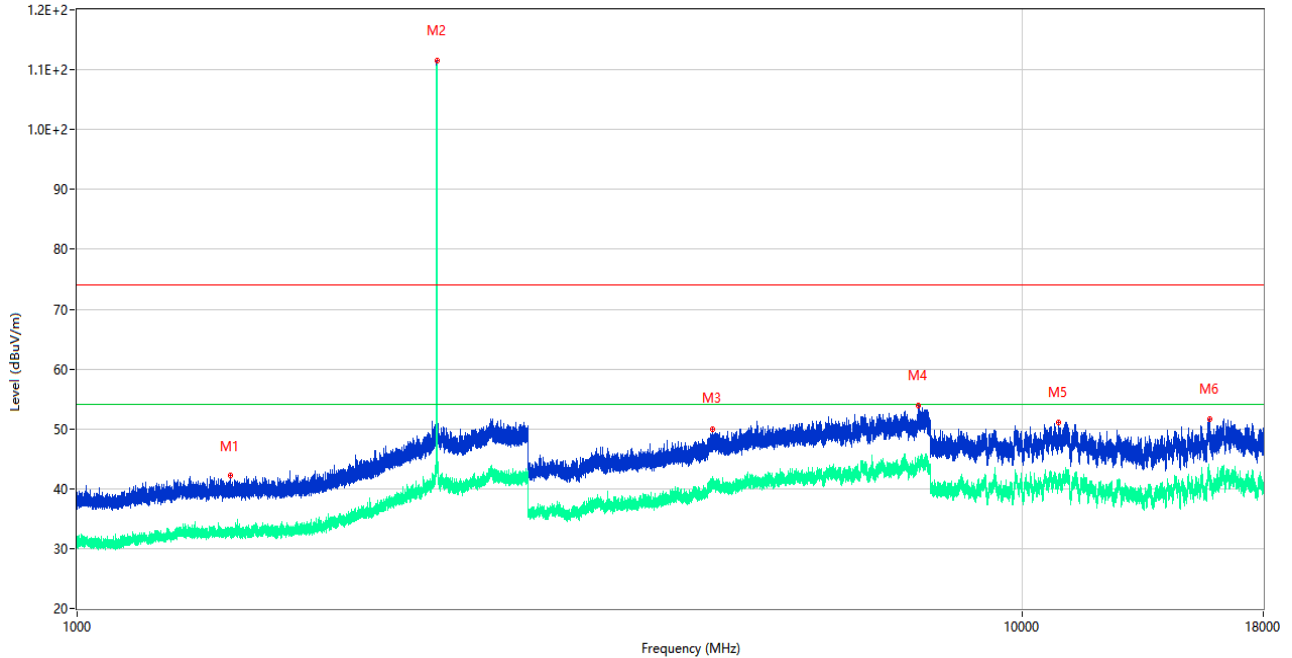

No.	Frequency (MHz)	Results (dBuV/m)	Factor (dB)	Limit (dBuV/m)	Margin (dB)	Detector	Table (Degree)	Height (cm)	Antenna	Verdict
1	1452.200	42.21	-16.70	74.0	31.79	Peak	324.00	400	Horizontal	Pass
1**	1452.200	32.46	-16.70	54.0	21.54	AV	324.00	400	Horizontal	Pass
2	2401.900	111.53	-10.12	74.0	-37.53	Peak	47.00	200	Horizontal	N/A
2**	2401.900	111.08	-10.12	54.0	-57.08	AV	47.00	200	Horizontal	N/A
3	4706.250	50.02	-2.74	74.0	23.98	Peak	117.00	100	Horizontal	Pass
3**	4706.250	40.27	-2.74	54.0	13.73	AV	117.00	100	Horizontal	Pass
4	7764.250	53.95	1.68	74.0	20.05	Peak	142.00	400	Horizontal	Pass
4**	7764.250	45.05	1.68	54.0	8.95	AV	142.00	400	Horizontal	Pass
5	10940.488	51.15	-2.65	74.0	22.85	Peak	282.00	400	Horizontal	Pass
5**	10940.488	41.02	-2.65	54.0	12.98	AV	282.00	400	Horizontal	Pass
6	15784.500	51.67	-0.57	74.0	22.33	Peak	191.00	200	Horizontal	Pass
6**	15784.500	41.61	-0.57	54.0	12.39	AV	191.00	200	Horizontal	Pass

GFSK LOW CHANNEL 1 GHz to 18 GHz, ANT V

RSE (SRD)_FCC Part 15C_FCC 15.247(2.4G)_1GHz-18GHz

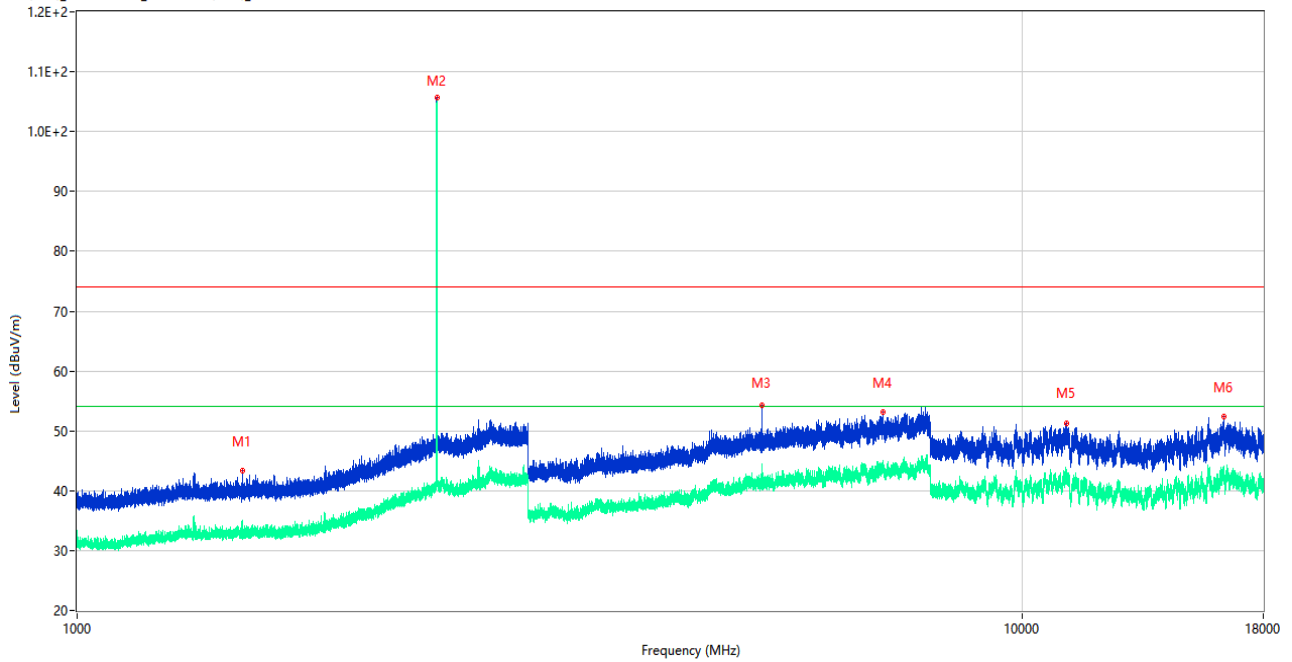

No.	Frequency (MHz)	Results (dBuV/m)	Factor (dB)	Limit (dBuV/m)	Margin (dB)	Detector	Table (Degree)	Height (cm)	Antenna	Verdict
1	1497.800	43.30	-16.63	74.0	30.70	Peak	351.00	400	Vertical	Pass
1**	1497.800	32.92	-16.63	54.0	21.08	AV	351.00	400	Vertical	Pass
2	2401.900	105.66	-10.12	74.0	-31.66	Peak	191.00	200	Vertical	N/A
2**	2401.900	105.24	-10.12	54.0	-51.24	AV	191.00	200	Vertical	N/A
3	5308.000	54.23	-2.39	74.0	19.77	Peak	127.00	150	Vertical	Pass
3**	5308.000	41.34	-2.39	54.0	12.66	AV	127.00	150	Vertical	Pass
4	7133.000	53.11	1.48	74.0	20.89	Peak	33.00	150	Vertical	Pass
4**	7133.000	43.93	1.48	54.0	10.07	AV	33.00	150	Vertical	Pass
5	11137.613	51.33	-0.96	74.0	22.67	Peak	33.00	400	Vertical	Pass
5**	11137.613	42.50	-0.96	54.0	11.50	AV	33.00	400	Vertical	Pass
6	16340.737	52.34	0.58	74.0	21.66	Peak	72.00	400	Vertical	Pass
6**	16340.737	42.69	0.58	54.0	11.31	AV	72.00	400	Vertical	Pass

GFSK MIDDLE CHANNEL 1 GHz to 18 GHz, ANT H

RSE (SRD)_FCC Part 15C_FCC 15.247(2.4G)_1GHz-18GHz

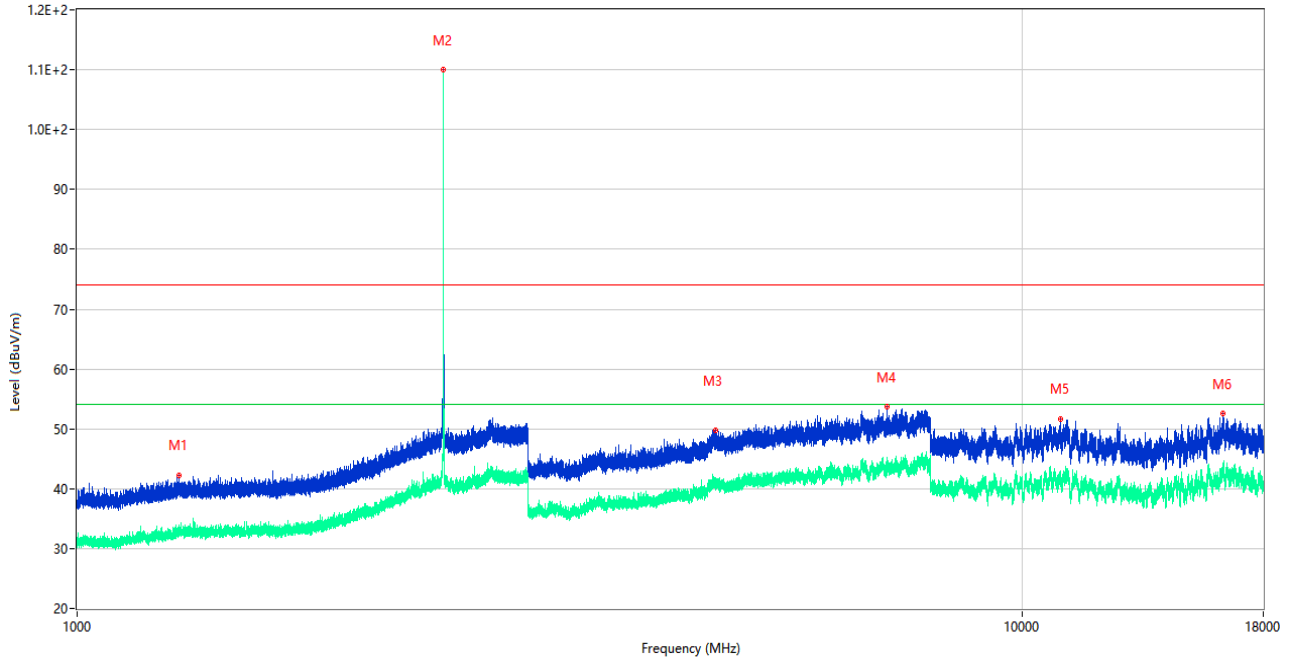

No.	Frequency (MHz)	Results (dBuV/m)	Factor (dB)	Limit (dBuV/m)	Margin (dB)	Detector	Table (Degree)	Height (cm)	Antenna	Verdict
1	1282.300	42.23	-16.46	74.0	31.77	Peak	312.00	400	Horizontal	Pass
1**	1282.300	32.93	-16.46	54.0	21.07	AV	312.00	400	Horizontal	Pass
2	2441.100	109.94	-9.40	74.0	-35.94	Peak	37.00	200	Horizontal	N/A
2**	2441.100	109.76	-9.40	54.0	-55.76	AV	37.00	200	Horizontal	N/A
3	4737.250	49.71	-3.04	74.0	24.29	Peak	101.00	100	Horizontal	Pass
3**	4737.250	40.91	-3.04	54.0	13.09	AV	101.00	100	Horizontal	Pass
4	7200.000	53.70	0.66	74.0	20.30	Peak	118.00	100	Horizontal	Pass
4**	7200.000	44.46	0.66	54.0	9.54	AV	118.00	100	Horizontal	Pass
5	10969.700	51.72	-2.14	74.0	22.28	Peak	17.00	100	Horizontal	Pass
5**	10969.700	41.76	-2.14	54.0	12.24	AV	17.00	100	Horizontal	Pass
6	16329.713	52.52	0.27	74.0	21.48	Peak	199.00	200	Horizontal	Pass
6**	16329.713	42.93	0.27	54.0	11.07	AV	199.00	200	Horizontal	Pass

GFSK MIDDLE CHANNEL 1 GHz to 18 GHz, ANT V

RSE (SRD)_FCC Part 15C_FCC 15.247(2.4G)_1GHz-18GHz

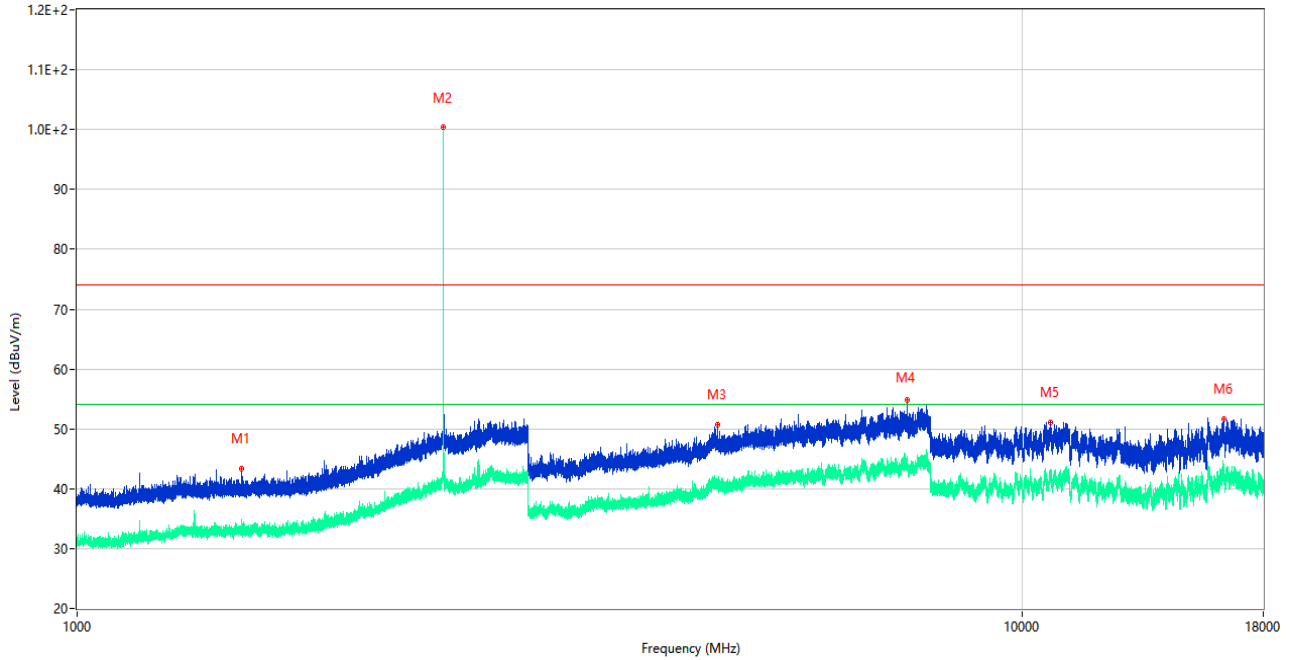

No.	Frequency (MHz)	Results (dBuV/m)	Factor (dB)	Limit (dBuV/m)	Margin (dB)	Detector	Table (Degree)	Height (cm)	Antenna	Verdict
1	1493.800	43.38	-16.89	74.0	30.62	Peak	0.00	100	Vertical	Pass
1**	1493.800	32.32	-16.89	54.0	21.68	AV	0.00	100	Vertical	Pass
2	2440.800	100.37	-9.40	74.0	-26.37	Peak	288.00	150	Vertical	N/A
2**	2440.800	99.37	-9.40	54.0	-45.37	AV	288.00	150	Vertical	N/A
3	4759.250	50.72	-2.70	74.0	23.28	Peak	161.00	100	Vertical	Pass
3**	4759.250	40.98	-2.70	54.0	13.02	AV	161.00	100	Vertical	Pass
4	7551.000	54.88	1.30	74.0	19.12	Peak	101.00	300	Vertical	Pass
4**	7551.000	42.93	1.30	54.0	11.07	AV	101.00	300	Vertical	Pass
5	10725.313	51.15	-2.04	74.0	22.85	Peak	19.00	300	Vertical	Pass
5**	10725.313	42.18	-2.04	54.0	11.82	AV	19.00	300	Vertical	Pass
6	16337.849	51.64	0.50	74.0	22.36	Peak	341.00	100	Vertical	Pass
6**	16337.849	44.01	0.50	54.0	9.99	AV	341.00	100	Vertical	Pass

GFSK HIGH CHANNEL 1 GHz to 18 GHz, ANT H

RSE (SRD)_FCC Part 15C_FCC 15.247(2.4G)_1GHz-18GHz

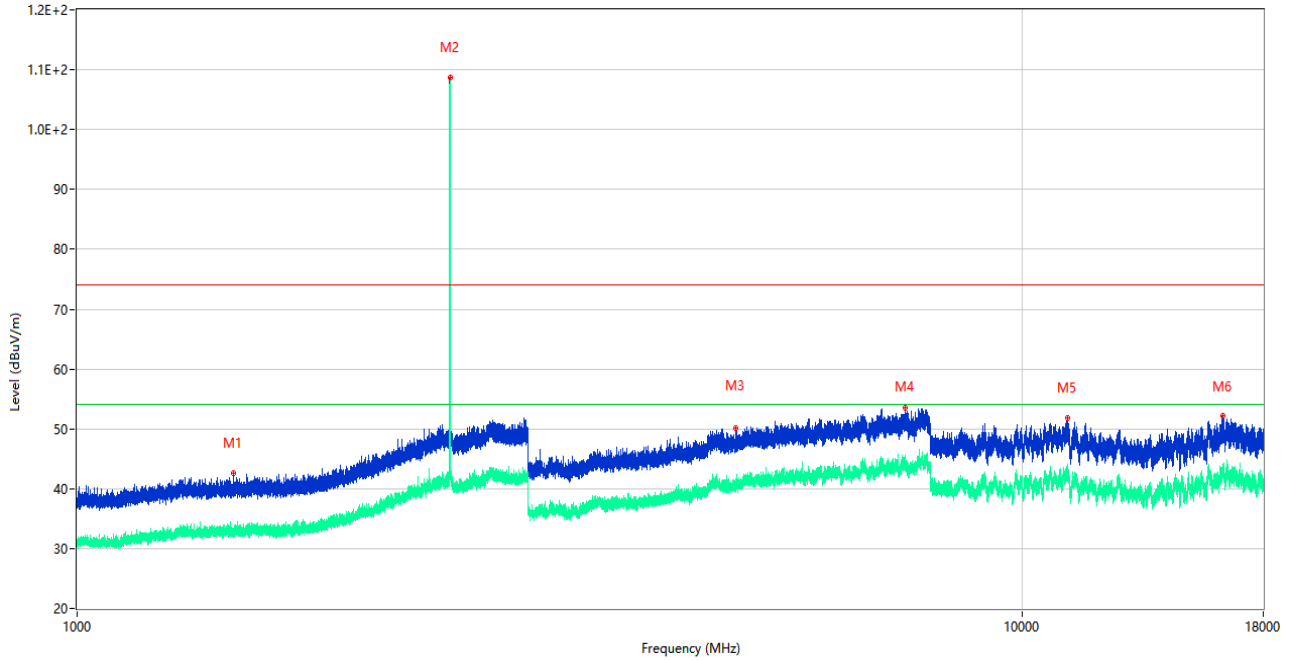

No.	Frequency (MHz)	Results (dBuV/m)	Factor (dB)	Limit (dBuV/m)	Margin (dB)	Detector	Table (Degree)	Height (cm)	Antenna	Verdict
1	1462.900	42.60	-16.84	74.0	31.40	Peak	338.00	400	Horizontal	Pass
1**	1462.900	33.03	-16.84	54.0	20.97	AV	338.00	400	Horizontal	Pass
2	2479.800	108.74	-10.55	74.0	-34.74	Peak	26.00	100	Horizontal	N/A
2**	2479.800	107.95	-10.55	54.0	-53.95	AV	26.00	100	Horizontal	N/A
3	4975.000	50.16	-2.65	74.0	23.84	Peak	124.00	150	Horizontal	Pass
3**	4975.000	41.42	-2.65	54.0	12.58	AV	124.00	150	Horizontal	Pass
4	7522.500	53.52	2.29	74.0	20.48	Peak	297.00	200	Horizontal	Pass
4**	7522.500	44.05	2.29	54.0	9.95	AV	297.00	200	Horizontal	Pass
5	11167.537	51.88	-1.25	74.0	22.12	Peak	220.00	300	Horizontal	Pass
5**	11167.537	42.06	-1.25	54.0	11.94	AV	220.00	300	Horizontal	Pass
6	16313.700	52.12	-0.19	74.0	21.88	Peak	173.00	400	Horizontal	Pass
6**	16313.700	42.71	-0.19	54.0	11.29	AV	173.00	400	Horizontal	Pass

GFSK HIGH CHANNEL 1 GHz to 18 GHz, ANT V

RSE (SRD)_FCC Part 15C_FCC 15.247(2.4G)_1GHz-18GHz

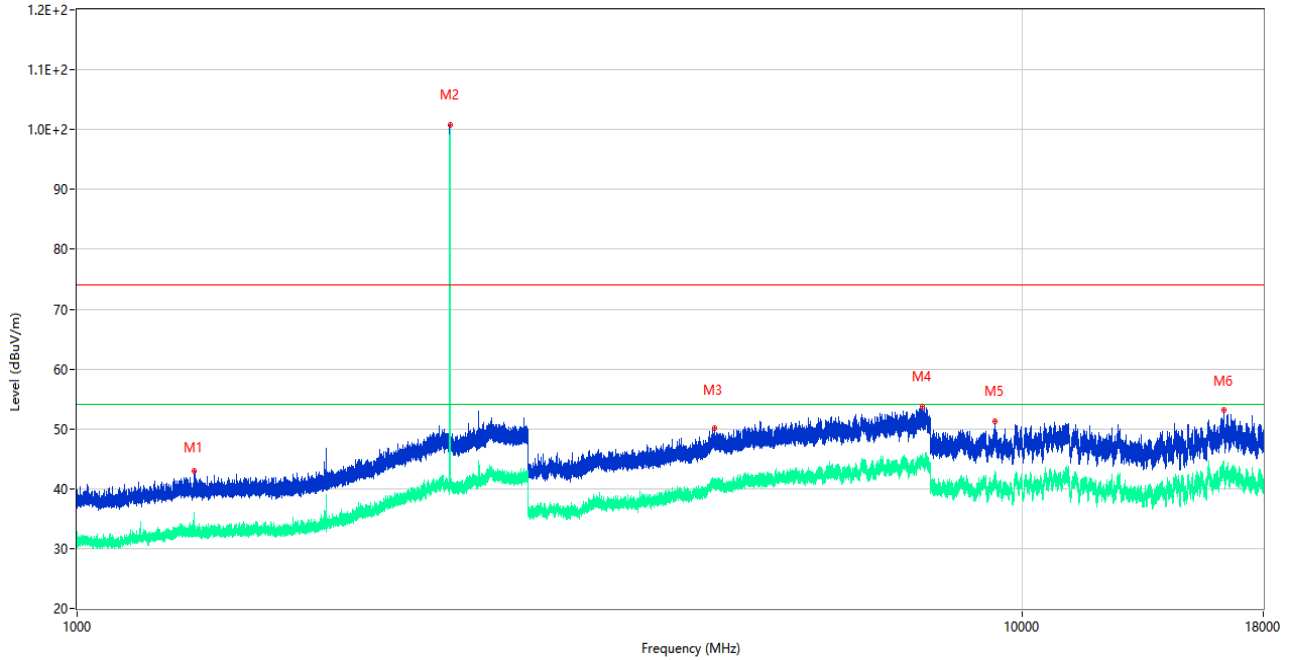

No.	Frequency (MHz)	Results (dBuV/m)	Factor (dB)	Limit (dBuV/m)	Margin (dB)	Detector	Table (Degree)	Height (cm)	Antenna	Verdict
1	1330.900	43.05	-16.68	74.0	30.95	Peak	252.00	200	Vertical	Pass
1**	1330.900	32.52	-16.68	54.0	21.48	AV	252.00	200	Vertical	Pass
2	2479.900	100.86	-10.56	74.0	-26.86	Peak	247.00	200	Vertical	N/A
2**	2479.900	100.29	-10.56	54.0	-46.29	AV	247.00	200	Vertical	N/A
3	4727.750	50.08	-2.99	74.0	23.92	Peak	232.00	100	Vertical	Pass
3**	4727.750	41.28	-2.99	54.0	12.72	AV	232.00	100	Vertical	Pass
4	7838.500	53.79	3.42	74.0	20.21	Peak	190.00	400	Vertical	Pass
4**	7838.500	45.29	3.42	54.0	8.71	AV	190.00	400	Vertical	Pass
5	9353.750	51.26	-2.27	74.0	22.74	Peak	172.00	100	Vertical	Pass
5**	9353.750	41.07	-2.27	54.0	12.93	AV	172.00	100	Vertical	Pass
6	16348.349	53.09	0.80	74.0	20.91	Peak	217.00	400	Vertical	Pass
6**	16348.349	44.12	0.80	54.0	9.88	AV	217.00	400	Vertical	Pass

8-DPSK LOW CHANNEL 1 GHz to 18 GHz, ANT H

RSE (SRD)_FCC Part 15C_FCC 15.247(2.4G)_1GHz-18GHz

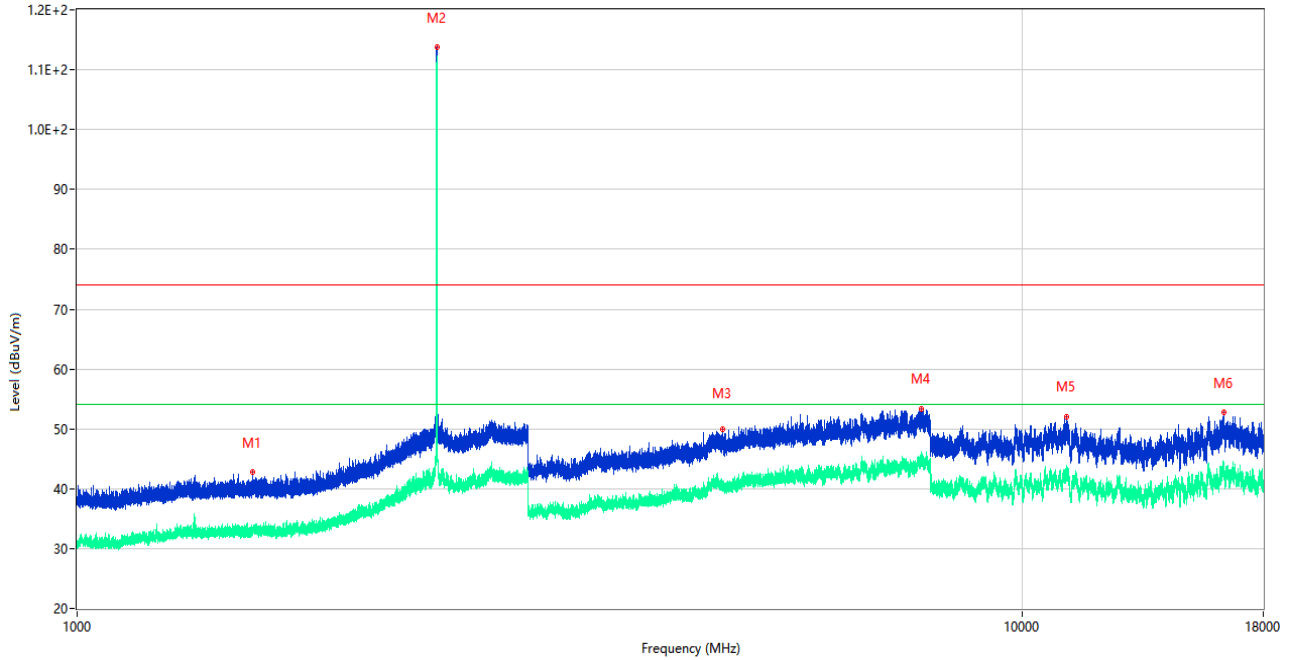

No.	Frequency (MHz)	Results (dBuV/m)	Factor (dB)	Limit (dBuV/m)	Margin (dB)	Detector	Table (Degree)	Height (cm)	Antenna	Verdict
1	1534.400	42.76	-16.45	74.0	31.24	Peak	273.00	400	Horizontal	Pass
1**	1534.400	32.51	-16.45	54.0	21.49	AV	273.00	400	Horizontal	Pass
2	2401.900	113.75	-10.12	74.0	-39.75	Peak	41.00	200	Horizontal	N/A
2**	2401.900	111.84	-10.12	54.0	-57.84	AV	41.00	200	Horizontal	N/A
3	4822.750	49.93	-1.81	74.0	24.07	Peak	137.00	200	Horizontal	Pass
3**	4822.750	40.15	-1.81	54.0	13.85	AV	137.00	200	Horizontal	Pass
4	7833.000	53.41	3.39	74.0	20.59	Peak	208.00	300	Horizontal	Pass
4**	7833.000	45.21	3.39	54.0	8.79	AV	208.00	300	Horizontal	Pass
5	11141.412	52.05	-0.96	74.0	21.95	Peak	33.00	100	Horizontal	Pass
5**	11141.412	43.00	-0.96	54.0	11.00	AV	33.00	100	Horizontal	Pass
6	16348.613	52.74	0.81	74.0	21.26	Peak	272.00	400	Horizontal	Pass
6**	16348.613	43.10	0.81	54.0	10.90	AV	272.00	400	Horizontal	Pass

8-DPSK LOW CHANNEL 1 GHz to 18 GHz, ANT V

RSE (SRD)_FCC Part 15C_FCC 15.247(2.4G)_1GHz-18GHz

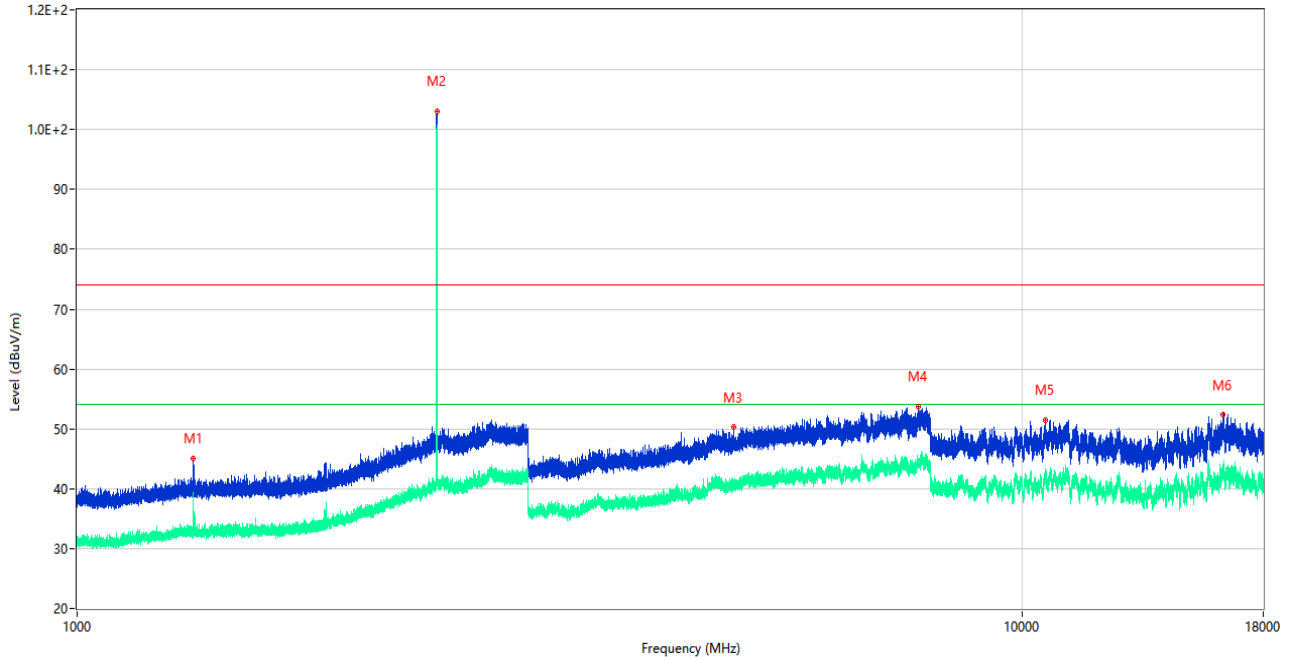

No.	Frequency (MHz)	Results (dBuV/m)	Factor (dB)	Limit (dBuV/m)	Margin (dB)	Detector	Table (Degree)	Height (cm)	Antenna	Verdict
1	1327.900	45.13	-16.70	74.0	28.87	Peak	271.00	400	Vertical	Pass
1**	1327.900	32.69	-16.70	54.0	21.31	AV	271.00	400	Vertical	Pass
2	2402.100	103.13	-10.10	74.0	-29.13	Peak	249.00	150	Vertical	N/A
2**	2402.100	100.78	-10.10	54.0	-46.78	AV	249.00	150	Vertical	N/A
3	4948.000	50.23	-2.22	74.0	23.77	Peak	288.00	100	Vertical	Pass
3**	4948.000	40.68	-2.22	54.0	13.32	AV	288.00	100	Vertical	Pass
4	7765.250	53.77	1.70	74.0	20.23	Peak	10.00	300	Vertical	Pass
4**	7765.250	44.73	1.70	54.0	9.27	AV	10.00	300	Vertical	Pass
5	10588.987	51.48	-1.58	74.0	22.52	Peak	267.00	300	Vertical	Pass
5**	10588.987	42.18	-1.58	54.0	11.82	AV	267.00	300	Vertical	Pass
6	16332.599	52.35	0.35	74.0	21.65	Peak	233.00	100	Vertical	Pass
6**	16332.599	43.36	0.35	54.0	10.64	AV	233.00	100	Vertical	Pass

8-DPSK MIDDLE CHANNEL 1 GHz to 18 GHz, ANT H

RSE (SRD)_FCC Part 15C_FCC 15.247(2.4G)_1GHz-18GHz

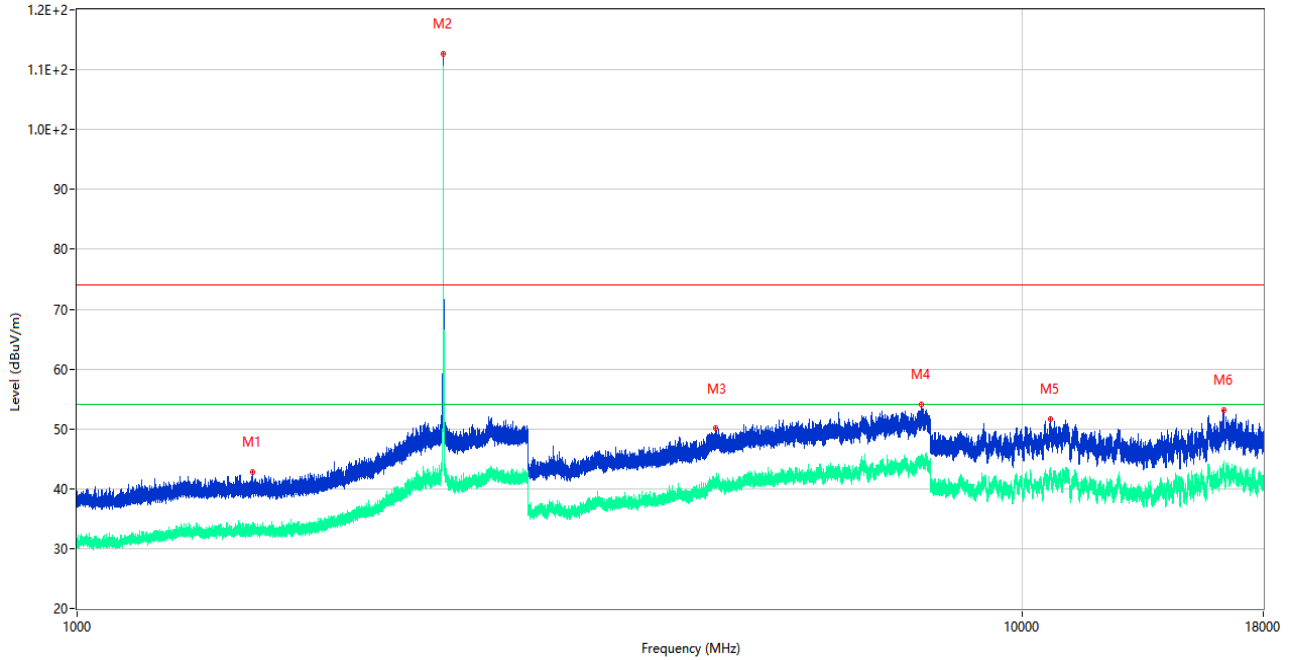

No.	Frequency (MHz)	Results (dBuV/m)	Factor (dB)	Limit (dBuV/m)	Margin (dB)	Detector	Table (Degree)	Height (cm)	Antenna	Verdict
1	1534.500	42.84	-16.45	74.0	31.16	Peak	167.00	100	Horizontal	Pass
1**	1534.500	34.28	-16.45	54.0	19.72	AV	167.00	100	Horizontal	Pass
2	2440.800	112.70	-9.40	74.0	-38.70	Peak	31.00	200	Horizontal	N/A
2**	2440.800	110.24	-9.40	54.0	-56.24	AV	31.00	200	Horizontal	N/A
3	4737.500	50.10	-3.00	74.0	23.90	Peak	47.00	150	Horizontal	Pass
3**	4737.500	41.02	-3.00	54.0	12.98	AV	47.00	150	Horizontal	Pass
4	7829.500	54.17	3.16	74.0	19.83	Peak	188.00	200	Horizontal	Pass
4**	7829.500	44.69	3.16	54.0	9.31	AV	188.00	200	Horizontal	Pass
5	10710.350	51.64	-2.27	74.0	22.36	Peak	342.00	400	Horizontal	Pass
5**	10710.350	42.16	-2.27	54.0	11.84	AV	342.00	400	Horizontal	Pass
6	16356.225	53.17	0.71	74.0	20.83	Peak	212.00	400	Horizontal	Pass
6**	16356.225	43.03	0.71	54.0	10.97	AV	212.00	400	Horizontal	Pass

8-DPSK MIDDLE CHANNEL 1 GHz to 18 GHz, ANT V

RSE (SRD)_FCC Part 15C_FCC 15.247(2.4G)_1GHz-18GHz

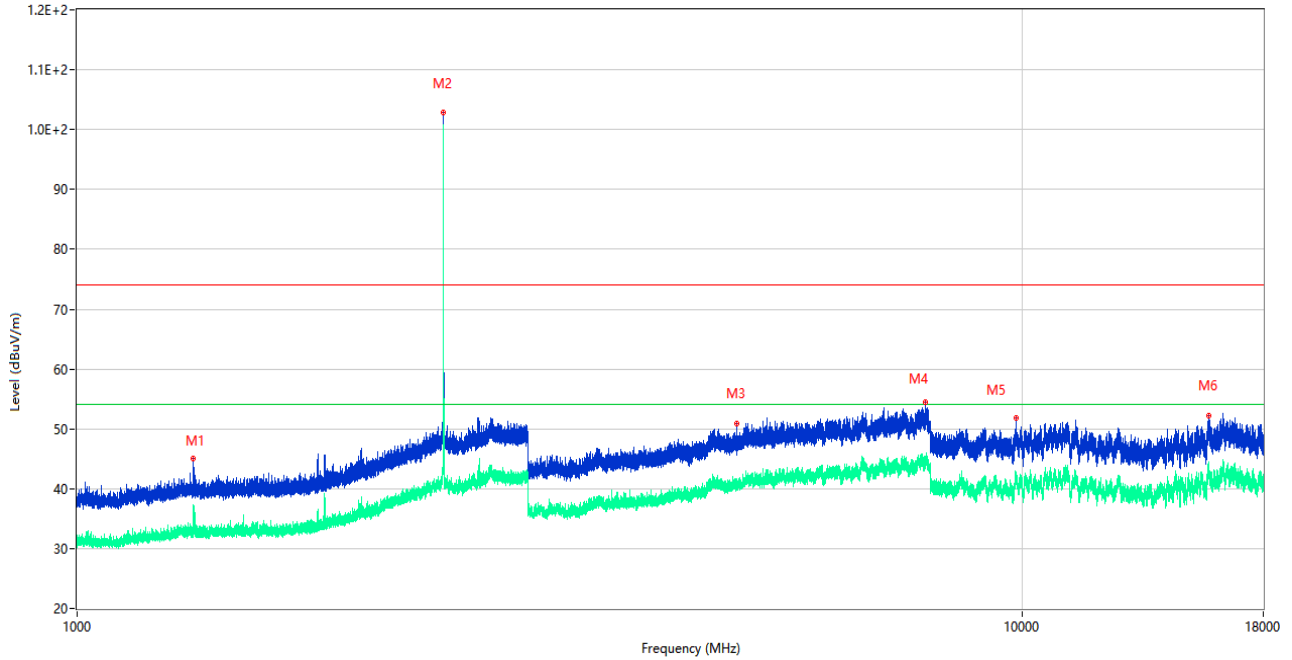

No.	Frequency (MHz)	Results (dBuV/m)	Factor (dB)	Limit (dBuV/m)	Margin (dB)	Detector	Table (Degree)	Height (cm)	Antenna	Verdict
1	1328.200	45.11	-16.68	74.0	28.89	Peak	276.00	100	Vertical	Pass
1**	1328.200	36.09	-16.68	54.0	17.91	AV	276.00	100	Vertical	Pass
2	2441.100	102.79	-9.40	74.0	-28.79	Peak	290.00	100	Vertical	N/A
2**	2441.100	100.79	-9.40	54.0	-46.79	AV	290.00	100	Vertical	N/A
3	4984.000	50.96	-2.54	74.0	23.04	Peak	69.00	150	Vertical	Pass
3**	4984.000	41.01	-2.54	54.0	12.99	AV	69.00	150	Vertical	Pass
4	7900.000	54.39	2.19	74.0	19.61	Peak	149.00	300	Vertical	Pass
4**	7900.000	45.05	2.19	54.0	8.95	AV	149.00	300	Vertical	Pass
5	9850.362	51.74	-1.89	74.0	22.26	Peak	86.00	200	Vertical	Pass
5**	9850.362	41.85	-1.89	54.0	12.15	AV	86.00	200	Vertical	Pass
6	15753.787	52.19	0.27	74.0	21.81	Peak	272.00	400	Vertical	Pass
6**	15753.787	42.75	0.27	54.0	11.25	AV	272.00	400	Vertical	Pass

8-DPSK HIGH CHANNEL 1 GHz to 18 GHz, ANT H

RSE (SRD)_FCC Part 15C_FCC 15.247(2.4G)_1GHz-18GHz

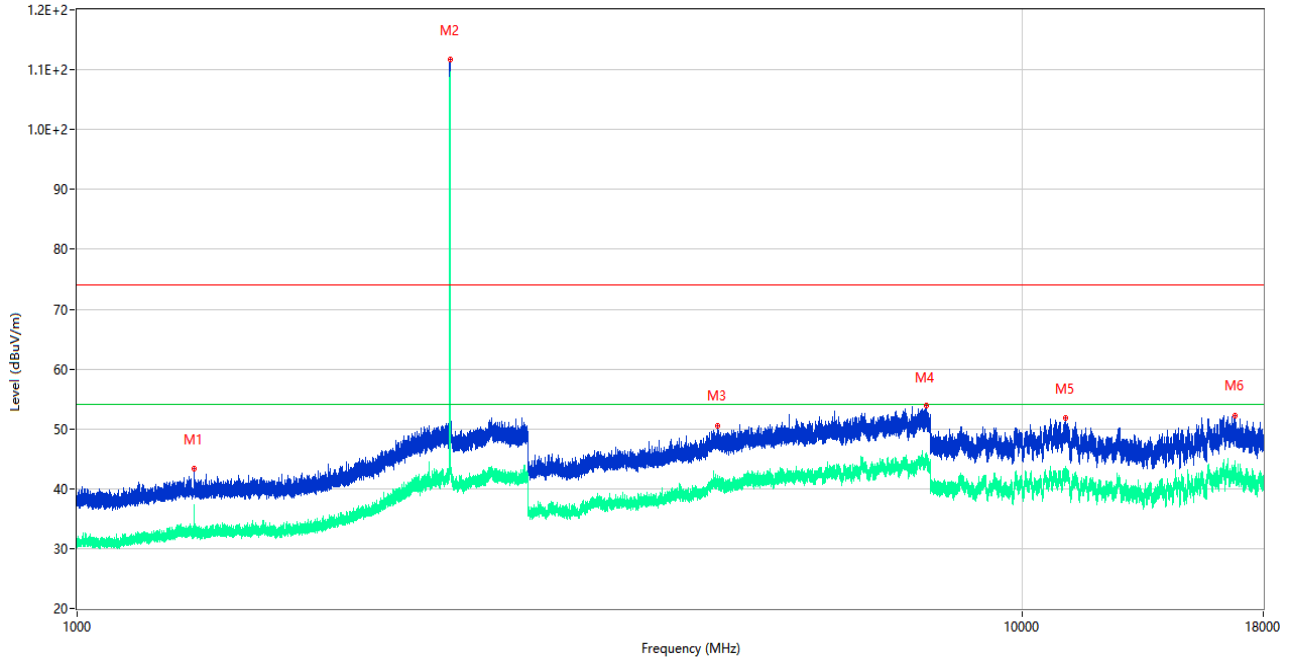

No.	Frequency (MHz)	Results (dBuV/m)	Factor (dB)	Limit (dBuV/m)	Margin (dB)	Detector	Table (Degree)	Height (cm)	Antenna	Verdict
1	1330.200	43.29	-16.66	74.0	30.71	Peak	288.00	200	Horizontal	Pass
1**	1330.200	32.70	-16.66	54.0	21.30	AV	288.00	200	Horizontal	Pass
2	2479.900	111.66	-10.56	74.0	-37.66	Peak	28.00	150	Horizontal	N/A
2**	2479.900	108.99	-10.56	54.0	-54.99	AV	28.00	150	Horizontal	N/A
3	4758.500	50.51	-2.75	74.0	23.49	Peak	360.00	150	Horizontal	Pass
3**	4758.500	41.27	-2.75	54.0	12.73	AV	360.00	150	Horizontal	Pass
4	7929.500	53.96	2.49	74.0	20.04	Peak	248.00	400	Horizontal	Pass
4**	7929.500	45.08	2.49	54.0	8.92	AV	248.00	400	Horizontal	Pass
5	11129.300	51.82	-0.97	74.0	22.18	Peak	21.00	300	Horizontal	Pass
5**	11129.300	43.14	-0.97	54.0	10.86	AV	21.00	300	Horizontal	Pass
6	16798.537	52.25	1.10	74.0	21.75	Peak	93.00	100	Horizontal	Pass
6**	16798.537	42.77	1.10	54.0	11.23	AV	93.00	100	Horizontal	Pass

8-DPSK HIGH CHANNEL 1 GHz to 18 GHz, ANT V

RSE (SRD)_FCC Part 15C_FCC 15.247(2.4G)_1GHz-18GHz

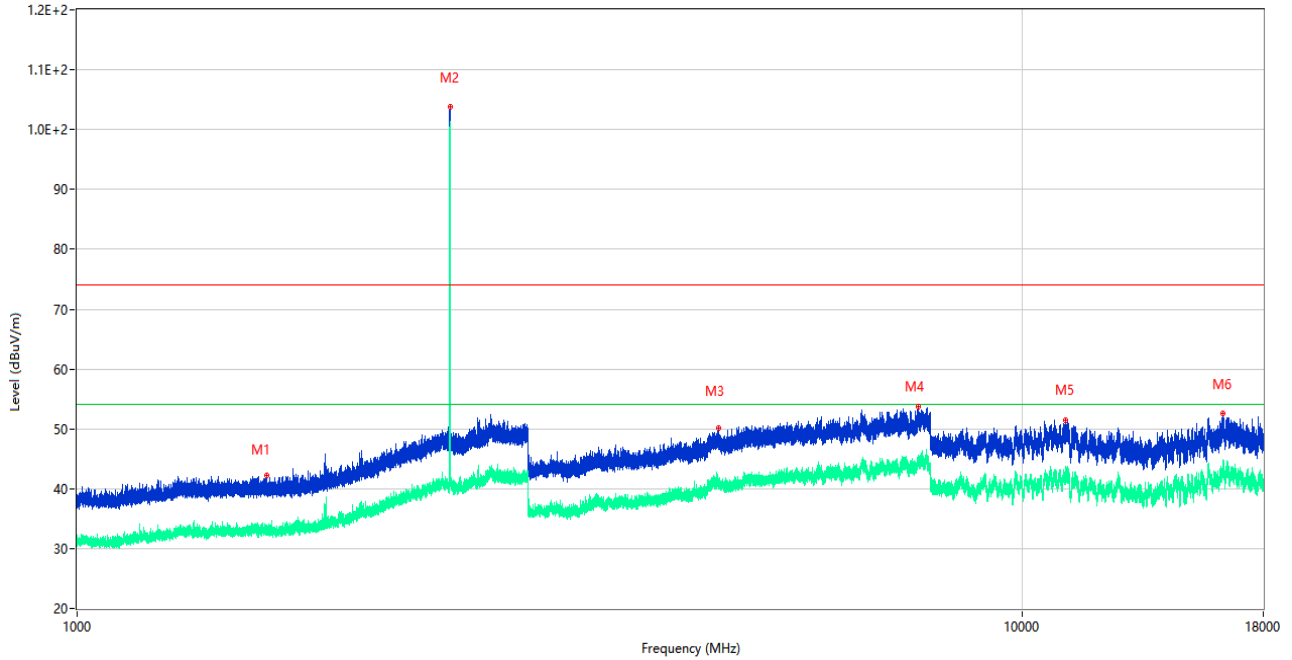

No.	Frequency (MHz)	Results (dBuV/m)	Factor (dB)	Limit (dBuV/m)	Margin (dB)	Detector	Table (Degree)	Height (cm)	Antenna	Verdict
1	1587.400	42.30	-16.68	74.0	31.70	Peak	103.00	100	Vertical	Pass
1**	1587.400	32.37	-16.68	54.0	21.63	AV	103.00	100	Vertical	Pass
2	2479.800	103.72	-10.55	74.0	-29.72	Peak	245.00	100	Vertical	N/A
2**	2479.800	100.86	-10.55	54.0	-46.86	AV	245.00	100	Vertical	N/A
3	4769.500	50.22	-2.44	74.0	23.78	Peak	207.00	100	Vertical	Pass
3**	4769.500	40.66	-2.44	54.0	13.34	AV	207.00	100	Vertical	Pass
4	7770.750	53.62	1.66	74.0	20.38	Peak	18.00	150	Vertical	Pass
4**	7770.750	45.11	1.66	54.0	8.89	AV	18.00	150	Vertical	Pass
5	11131.437	51.47	-0.97	74.0	22.53	Peak	222.00	300	Vertical	Pass
5**	11131.437	42.64	-0.97	54.0	11.36	AV	222.00	300	Vertical	Pass
6	16328.138	52.55	0.22	74.0	21.45	Peak	311.00	100	Vertical	Pass
6**	16328.138	43.56	0.22	54.0	10.44	AV	311.00	100	Vertical	Pass

A.9 Band Edge (Restricted-band band-edge)

Note ¹: The lowest and highest channels are tested to verify the band edge emissions. Please refer to the following the plots for emissions values.

Note ²: The test data all are tested in the vertical and horizontal antenna which the trace is max hold. So these plots have shown the worst case.

Note ³: According the ANSI C63.10-2013, where limits are specified for both average and peak (or quasi-peak) detector functions, if the peak (or quasi-peak) measured value complies with the average limit, it is unnecessary to perform an average measurement.

Note ⁴: The Level (dBuV/m) has been corrected by factor.

Test Data and Plots

GFSK LOW CHANNEL

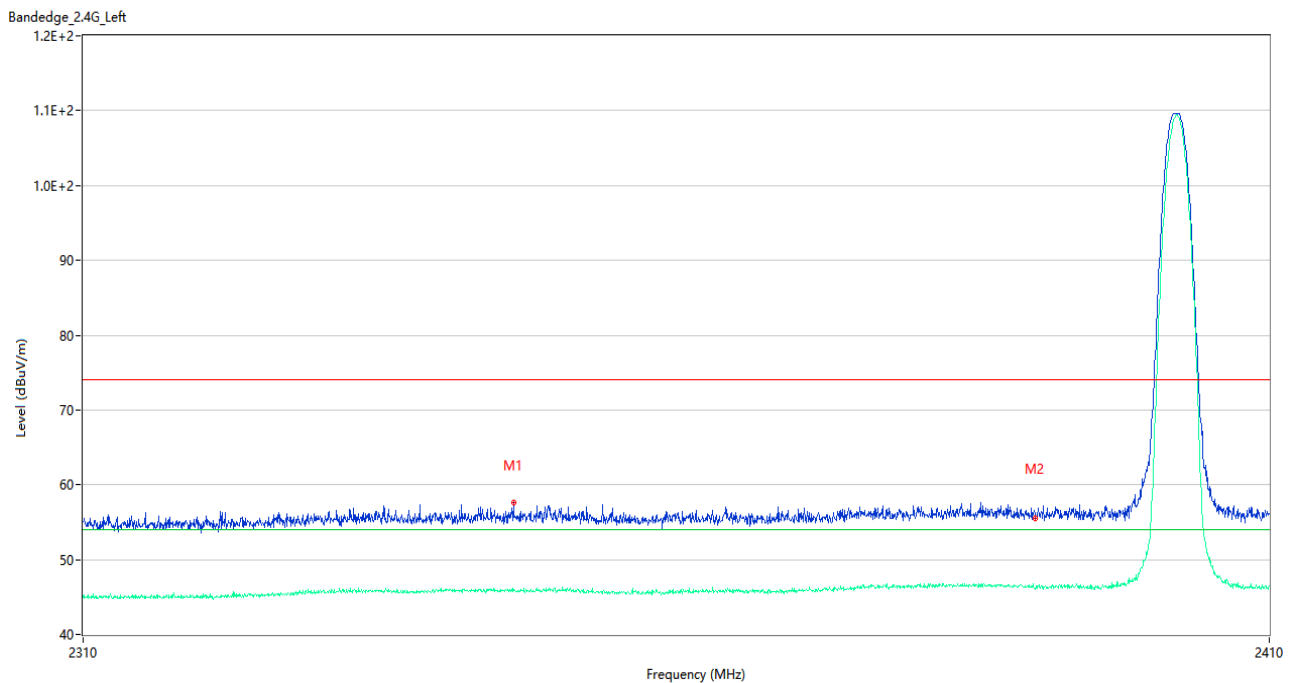

No.	Frequency (MHz)	Results (dBuV/m)	Factor (dB)	Limit (dBuV/m)	Margin (dB)	Detector	Table (Degree)	Height (cm)	Antenna	Verdict
1	2345.800	57.60	1.76	74.0	16.40	Peak	0.00	100	Horizontal	Pass
1**	2345.800	46.02	1.76	54.0	7.98	AV	0.00	100	Horizontal	Pass
2	2389.950	55.53	1.86	74.0	18.47	Peak	188.00	100	Horizontal	Pass
2**	2389.950	46.25	1.86	54.0	7.75	AV	188.00	100	Horizontal	Pass

GFSK HIGH CHANNEL

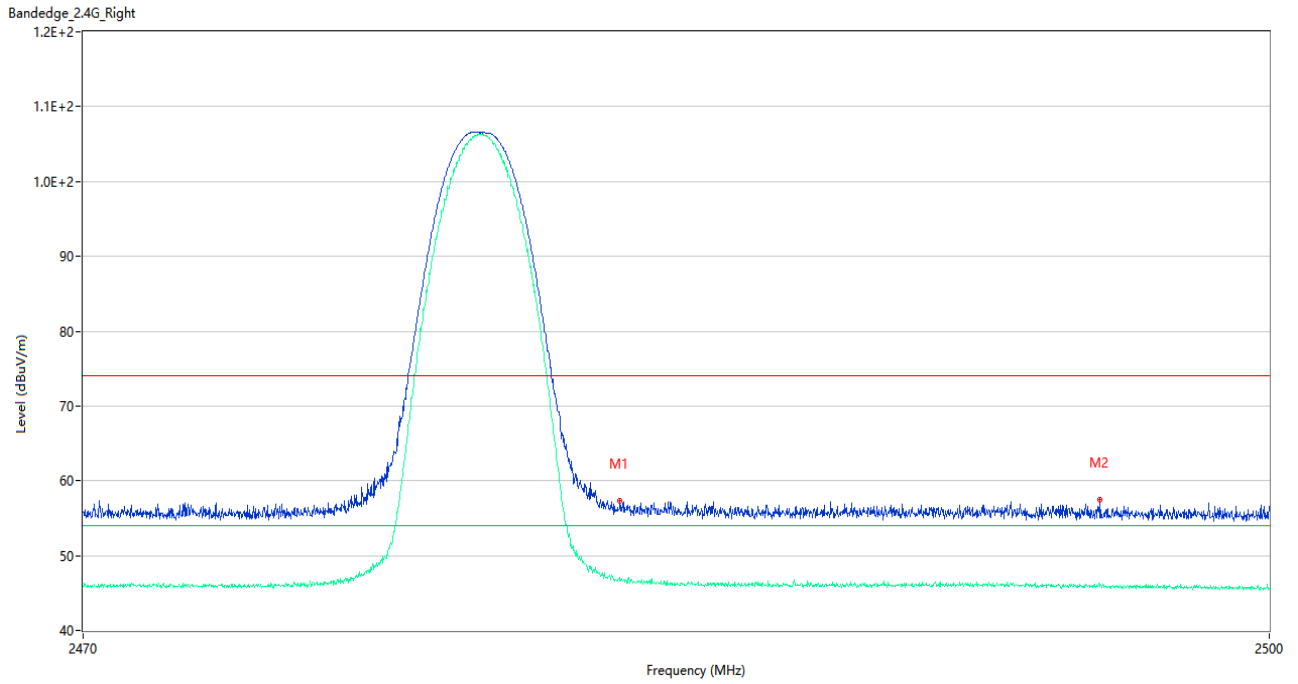

No.	Frequency (MHz)	Results (dBuV/m)	Factor (dB)	Limit (dBuV/m)	Margin (dB)	Detector	Table (Degree)	Height (cm)	Antenna	Verdict
1	2483.530	57.31	1.77	74.0	16.69	Peak	334.00	100	Horizontal	Pass
1**	2483.530	46.67	1.77	54.0	7.33	AV	334.00	100	Horizontal	Pass
2	2495.695	57.46	1.58	74.0	16.54	Peak	169.00	150	Horizontal	Pass
2**	2495.695	46.14	1.58	54.0	7.86	AV	169.00	150	Horizontal	Pass

8-DPSK LOW CHANNEL

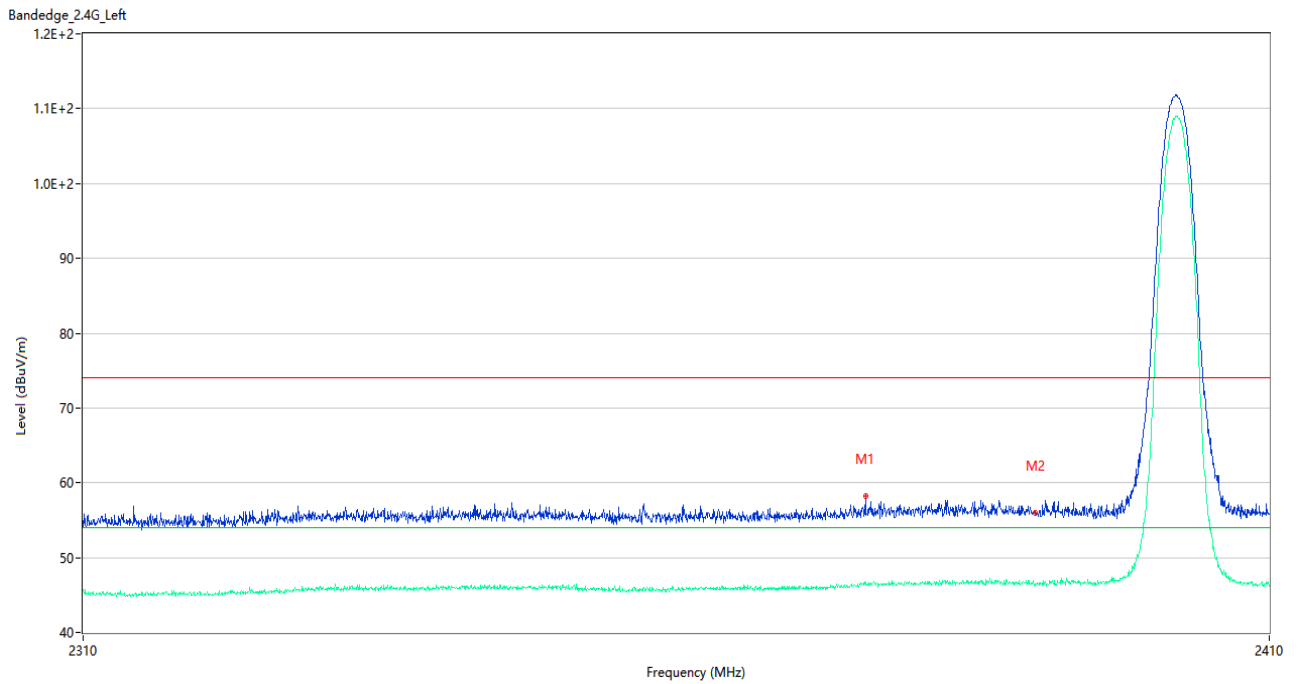

No.	Frequency (MHz)	Results (dBuV/m)	Factor (dB)	Limit (dBuV/m)	Margin (dB)	Detector	Table (Degree)	Height (cm)	Antenna	Verdict
1	2375.500	58.22	1.73	74.0	15.78	Peak	67.00	100	Horizontal	Pass
1**	2375.500	46.58	1.73	54.0	7.42	AV	67.00	100	Horizontal	Pass
2	2389.950	55.95	1.86	74.0	18.05	Peak	7.00	100	Horizontal	Pass
2**	2389.950	46.41	1.86	54.0	7.59	AV	7.00	100	Horizontal	Pass

8-DPSK HIGH CHANNEL

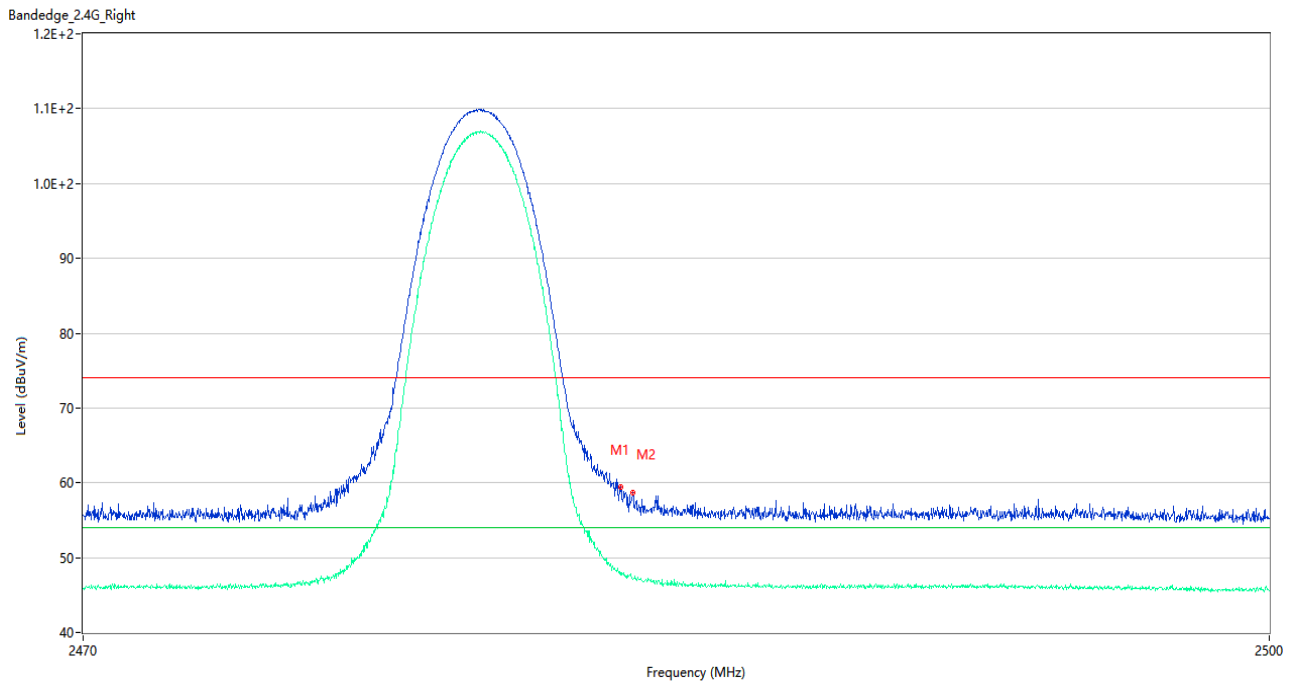

No.	Frequency (MHz)	Results (dBuV/m)	Factor (dB)	Limit (dBuV/m)	Margin (dB)	Detector	Table (Degree)	Height (cm)	Antenna	Verdict
1	2483.560	59.43	1.77	74.0	14.57	Peak	21.00	100	Horizontal	Pass
1**	2483.560	47.76	1.77	54.0	6.24	AV	21.00	100	Horizontal	Pass
2	2483.860	58.70	1.77	74.0	15.30	Peak	23.00	100	Horizontal	Pass
2**	2483.860	47.13	1.77	54.0	6.87	AV	23.00	100	Horizontal	Pass

ANNEX B TEST SETUP PHOTOS

Please refer the document “BL-EC22B1059-AR.PDF”.

ANNEX C EUT EXTERNAL PHOTOS

Please refer the document “BL-EC22B1059-AW.PDF”.

ANNEX D EUT INTERNAL PHOTOS

Please refer the document “BL-EC22B1059-AI.PDF”.

Statement

1. The laboratory guarantees the scientificity, accuracy and impartiality of the test, and is responsible for all the information in the report, except the information provided by the customer. The customer is responsible for the impact of the information provided on the validity of the results.
2. The report without China inspection body and laboratory Mandatory Approval (CMA) mark has no effect of proving to the society.
3. For the report with CNAS mark or A2LA mark, the items marked with "☆" are not within the accredited scope.
4. This report is invalid if it is altered, without the signature of the testing and approval personnel, or without the "inspection and testing dedicated stamp" or test report stamp.
5. The test data and results are only valid for the tested samples provided by the customer.
6. This report shall not be partially reproduced without the written permission of the laboratory.
7. Any objection shall be raised to the laboratory within 30 days after receiving the report.

--END OF REPORT--