



# FCC TEST REPORT

**REPORT NO.:** RF930607L13

**MODEL NO.:** BT-0260

**RECEIVED:** June 07, 2004

**TESTED:** June 16 ~ June 23, 2004

**APPLICANT:** CC&C TECHNOLOGIES INC.

**ADDRESS:** 8F, 150, Jian Yi Road, Chung Ho City, Taipei  
County, Taiwan 235, R.O.C.

**ISSUED BY:** Advance Data Technology Corporation

**LAB LOCATION:** No. 19, Hwa Ya 2nd Rd., Kueishan, Taoyuan,  
Taiwan, R.O.C.

This test report consists of 72 pages in total. It may be duplicated completely for legal use with the approval of the applicant. It should not be reproduced except in full, without the written approval of our laboratory. The client should not use it to claim product endorsement by CNLA or any government agencies. The test results in the report only apply to the tested sample.



0528  
ILAC MRA



# TABLE OF CONTENTS

1	CERTIFICATION .....	4
2	SUMMARY OF TEST RESULTS .....	5
3	GENERAL INFORMATION .....	6
3.1	GENERAL DESCRIPTION OF EUT .....	6
3.2	DESCRIPTION OF TEST MODES .....	7
3.3	GENERAL DESCRIPTION OF APPLIED STANDARDS .....	7
3.4	DESCRIPTION OF SUPPORT UNITS .....	8
3.5	CONFIGURATION OF SYSTEM UNDER TEST .....	8
4	TEST PROCEDURES AND RESULTS .....	9
4.1	CONDUCTED EMISSION MEASUREMENT .....	9
4.1.1	LIMITS OF CONDUCTED EMISSION MEASUREMENT .....	9
4.1.2	TEST INSTRUMENTS .....	9
4.1.3	TEST PROCEDURES .....	10
4.1.4	DEVIATION FROM TEST STANDARD .....	10
4.1.5	TEST SETUP .....	11
4.1.6	EUT OPERATING CONDITIONS .....	11
4.1.7	TEST RESULTS .....	12
4.2	NUMBER OF HOPPING FREQUENCY USED .....	18
4.2.1	LIMIT OF HOPPING FREQUENCY USED .....	18
4.2.2	TEST INSTRUMENTS .....	18
4.2.3	TEST PROCEDURES .....	19
4.2.4	DEVIATION FROM TEST STANDARD .....	19
4.2.5	TEST SETUP .....	20
4.2.6	TEST RESULTS .....	20
4.3	DWELL TIME ON EACH CHANNEL .....	23
4.3.1	LIMIT OF DWELL TIME USED .....	23
4.3.2	TEST INSTRUMENTS .....	23
4.3.3	TEST PROCEDURES .....	24
4.3.4	DEVIATION FROM TEST STANDARD .....	24
4.3.5	TEST SETUP .....	24
4.3.6	TEST RESULTS .....	25
4.4	CHANNEL BANDWIDTH .....	32
4.4.1	LIMITS OF CHANNEL BANDWIDTH .....	32
4.4.2	TEST INSTRUMENTS .....	32
4.4.3	TEST PROCEDURE .....	33
4.4.4	DEVIATION FROM TEST STANDARD .....	33
4.4.5	TEST SETUP .....	33
4.4.6	EUT OPERATING CONDITION .....	33
4.4.7	TEST RESULTS .....	34
4.5	HOPPING CHANNEL SEPARATION .....	38
4.5.1	LIMIT OF HOPPING CHANNEL SEPARATION .....	38
4.5.2	TEST INSTRUMENTS .....	38
4.5.3	TEST PROCEDURES .....	39
4.5.4	DEVIATION FROM TEST STANDARD .....	39



4.5.5	TEST SETUP .....	39
4.5.6	TEST RESULTS .....	40
4.6	MAXIMUM PEAK OUTPUT POWER –USING POWER METTER.....	44
4.6.1	LIMITS OF MAXIMUM PEAK OUTPUT POWER MEASUREMENT .....	44
4.6.2	INSTRUMENTS .....	44
4.6.3	TEST PROCEDURES.....	45
4.6.4	DEVIATION FROM TEST STANDARD.....	45
4.6.5	TEST SETUP .....	46
4.6.6	EUT OPERATING CONDITION .....	46
4.6.7	TEST RESULTS .....	47
4.7	RADIATED EMISSION MEASUREMENT.....	51
4.7.1	LIMITS OF RADIATED EMISSION MEASUREMENT .....	51
4.7.2	TEST INSTRUMENTS .....	52
4.7.3	TEST PROCEDURES.....	53
4.7.4	DEVIATION FROM TEST STANDARD .....	53
4.7.5	TEST SETUP .....	54
4.7.6	TEST RESULTS .....	55
4.8	BAND EDGES MEASUREMENT.....	61
4.8.1	LIMITS OF BAND EDGES MEASUREMENT .....	61
4.8.2	TEST INSTRUMENTS .....	61
4.8.3	TEST PROCEDURE .....	61
4.8.4	DEVIATION FROM TEST STANDARD.....	61
4.8.5	EUT OPERATING CONDITION .....	62
4.8.6	TEST RESULTS .....	62
4.9	ANTENNA REQUIREMENT.....	67
4.9.1	STANDARD APPLICABLE .....	67
4.9.2	ANTENNA CONNECTED CONSTRUCTION .....	67
5	PHOTOGRAPHS OF THE TEST CONFIGURATION.....	68
6	INFORMATION ON THE TESTING LABORATORIES .....	72



# 1 CERTIFICATION

**PRODUCT :** Bluetooth Print Combo Adapter  
**BRAND NAME :** CC&C  
**MODEL NO. :** BT-0260  
**APPLICANT :** CC&C TECHNOLOGIES INC.  
**TESTED DATE:** June 16 ~ June 23, 2004  
**TEST ITEM :** Engineering Sample  
**STANDARDS :** FCC Part 15, Subpart C (Section 15.247),  
ANSI C63.4-2001

The above equipment has been tested by **Advance Data Technology Corporation**, and found compliance with the requirement of the above standards. The test record, data evaluation & Equipment Under Test (EUT) configurations represented herein are true and accurate accounts of the measurements of the sample's EMC characteristics under the conditions specified in this report.

**PREPARED BY:** Windy Chou, **DATE:** June 24, 2004  
Windy Chou

**APPROVED BY:** Cody Chang, **DATE:** June 24, 2004  
Cody Chang /  
Supervisor

## 2 SUMMARY OF TEST RESULTS

The EUT has been tested according to the following specifications:

<b>APPLIED STANDARD: FCC Part 15, Subpart C</b>			
<b>Standard Section</b>	<b>Test Type and Limit</b>	<b>Result</b>	<b>REMARK</b>
15.207	AC Power Conducted Emission	PASS	Meet the requirement of limit Minimum passing margin is -23.54dB at 0.357 MHz
15.247(a)(1)(I)-(ii)	Number of Hopping Frequency Used Spec.: At least 75 channels	PASS	Meet the requirement of limit
15.247(a)(1)(ii)	Dwell Time on Each Channel Spec. : Max. 0.4 second within 30 second	PASS	Meet the requirement of limit
15.247(a)(1)(I)-(ii)	Hopping Channel Separation Spec. : Min. 25 kHz or 20 dB bandwidth	PASS	Meet the requirement of limit
15.247(a)(2)	Spectrum Bandwidth of a Frequency Hopping Sequence Spread Spectrum System Spec.: Max. 1 MHz	PASS	Meet the requirement of limit
15.247(b)	Maximum Peak Output Power Spec.: max. 30dBm	PASS	Meet the requirement of limit
15.247(c)	Transmitter Radiated Emissions Spec.: Table 15.209	PASS	Meet the requirement of limit Minimum passing margin is -1.19dB at 4882.00MHz
15.247(c)	Band Edge Measurement	PASS	Meet the requirement of limit

**Note:** The information of measurement uncertainty is available upon the customer's request.

### 3 GENERAL INFORMATION

#### 3.1 GENERAL DESCRIPTION OF EUT

<b>PRODUCT</b>	Bluetooth Print Combo Adapter
<b>MODEL NO.</b>	BT-0260
<b>POWER SUPPLY</b>	7.5Vdc from AC adapter
<b>MODULATION TYPE</b>	FHSS
<b>MODULATION TECHNOLOGY</b>	GFSK
<b>FREQUENCY RANGE</b>	2402MHz ~ 2480MHz
<b>NUMBER OF CHANNEL</b>	79
<b>OUTPUT POWER</b>	9.48dBm
<b>ANTENNA TYPE</b>	PCB Antenna with 2.0dBi Antenna gain
<b>DATA CABLE</b>	NA
<b>I/O PORTS</b>	USB, Parallel
<b>ASSOCIATED DEVICES</b>	NA

**NOTE:**

1. The EUT is powered by the following adapter:

<b>BRAND:</b>	OEM
<b>MODEL:</b>	AD-0730
<b>INPUT:</b>	120Vac, 60Hz, 7W
<b>OUTPUT:</b>	7.5Vdc, 300mA

2. Bluetooth technology is used for the EUT.
3. The above EUT information was declared by manufacturer and for more detailed features description, please refer to the manufacturer's specifications or User's Manual.

### 3.2 DESCRIPTION OF TEST MODES

Seventy-nine channels are provided to this EUT.

Channel	Freq. (MHz)	Channel	Freq. (MHz)	Channel	Freq. (MHz)	Channel	Freq. (MHz)
0	2402	20	2422	40	2442	60	2462
1	2403	21	2423	41	2443	61	2463
2	2404	22	2424	42	2444	62	2464
3	2405	23	2425	43	2445	63	2465
4	2406	24	2426	44	2446	64	2466
5	2407	25	2427	45	2447	65	2467
6	2408	26	2428	46	2448	66	2468
7	2409	27	2429	47	2449	67	2469
8	2410	28	2430	48	2450	68	2470
9	2411	29	2431	49	2451	69	2471
10	2412	30	2431	50	2452	70	2472
11	2413	31	2433	51	2453	71	2473
12	2414	32	2434	52	2454	72	2474
13	2415	33	2435	53	2455	73	2475
14	2416	34	2436	54	2456	74	2476
15	2417	35	2437	55	2457	75	2477
16	2418	36	2438	56	2458	76	2478
17	2419	37	2439	57	2459	77	2479
18	2420	38	2440	58	2460	78	2480
19	2421	39	2441	59	2461		

**NOTE:**

1. Below 1 GHz, the channel 0, 39, and 78 were pre-tested in chamber. The channel 78, worst case one, was chosen for final test.
2. Above 1 GHz, the channel 0, 39, and 78 were tested individually.
3. For radiated emission test below 1GHz, there are two test modes presented in the following section. The test mode A is for the USB port and test mode B is for Parallel port.

### 3.3 GENERAL DESCRIPTION OF APPLIED STANDARDS

The EUT is a Bluetooth Print Combo Adapter. According to the specifications of the manufacturer, it must comply with the requirements of the following standards:

**FCC Part 15, Subpart C. (15.247)  
ANSI C63.4 : 2001**

All test items have been performed and recorded as per the above standards.

**NOTE:** The EUT is also considered as a kind of computer peripheral, because the connection to computer is necessary for typical use. It has been verified to comply with the requirements of FCC Part 15, Subpart B, Class B (DoC). The test report has been issued separately.



### 3.4 DESCRIPTION OF SUPPORT UNITS

NO.	PRODUCT	BRAND	MODEL NO.	SERIAL NO.	FCC ID
1	NOTEBOOK COMPUTER	DELL	PP05L	12130898320	E2K24CLNS
2	USB PRINTER	HP	DeskJet 3550	TH3AV142PX	FCC DoC Approved
3	PRINTER	EPSON	LQ-300+	DCGY047265	FCC DoC Approved

NO.	SIGNAL CABLE DESCRIPTION OF THE ABOVE SUPPORT UNITS
1	NA
2	2.0 m foil shielded wire , terminated with USB connector via metallic frame, w/o core.
3	1.2m braid shielded wire, terminated with DB25 and Centronics connector via metallic frame, w/o core

**NOTE:** All power cords of the above support units are non shielded (1.8m).

### 3.5 CONFIGURATION OF SYSTEM UNDER TEST

#### Test Mode A

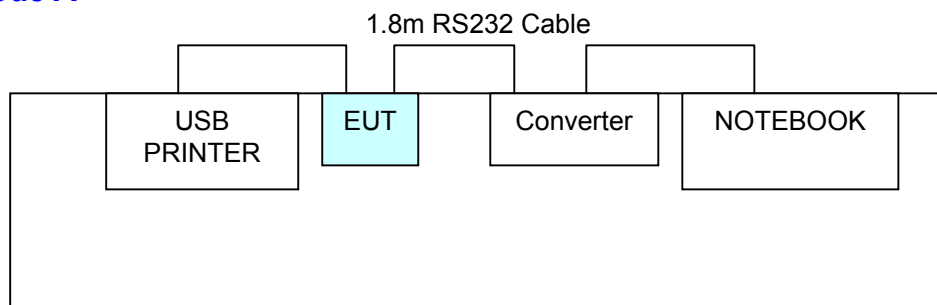

#### Test Mode B

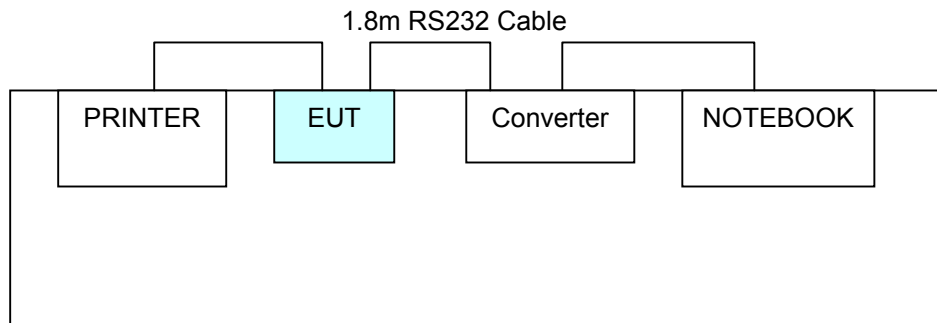



## 4 TEST PROCEDURES AND RESULTS

### 4.1 CONDUCTED EMISSION MEASUREMENT

#### 4.1.1 LIMITS OF CONDUCTED EMISSION MEASUREMENT

FREQUENCY OF EMISSION (MHz)	CONDUCTED LIMIT (dB $\mu$ V)	
	Quasi-peak	Average
0.15-0.5	66 to 56	56 to 46
0.5-5	56	46
5-30	60	50

**Notes:**

1. The lower limit shall apply at the transition frequencies.
2. All emanations from a class A/B digital device or system, including any network of conductors and apparatus connected thereto, shall not exceed the level of field strengths specified above.

#### 4.1.2 TEST INSTRUMENTS

DESCRIPTION & MANUFACTURER	MODEL NO.	SERIAL NO.	CALIBRATED UNTIL
Test Receiver ROHDE & SCHWARZ	ESCS30	100288	Dec. 11, 2004
RF signal cable Woken	5D-FB	Cable-HyC02-01	Mar. 07, 2005
LISN ROHDE & SCHWARZ	ESH2-Z5	100100	Mar. 10, 2005
LISN ROHDE & SCHWARZ	ESH3-Z5	100311	Mar. 04, 2005
Software ADT	ADT_Cond_V3	NA	NA

- NOTE:**
1. The calibration interval of the above test instruments is 12 months and the calibrations are traceable to NML/ROC and NIST/USA.
  2. The test was performed in HwaYa Shielded Room 2.
  3. The VCCI Site Registration No. is C-2047.



#### 4.1.3 TEST PROCEDURES

- a. The EUT was placed 0.4 meters from the conducting wall of the shielded room with EUT being connected to the power mains through a line impedance stabilization network (LISN). Other support units were connected to the power mains through another LISN. The two LISNs provide 50 ohm/ 50uH of coupling impedance for the measuring instrument.
- b. Both lines of the power mains connected to the EUT were checked for maximum conducted interference.
- c. The frequency range from 150kHz to 30MHz was searched. Emission levels under Limit - 20dB was not recorded.

#### 4.1.4 DEVIATION FROM TEST STANDARD

No deviation

#### 4.1.5 TEST SETUP

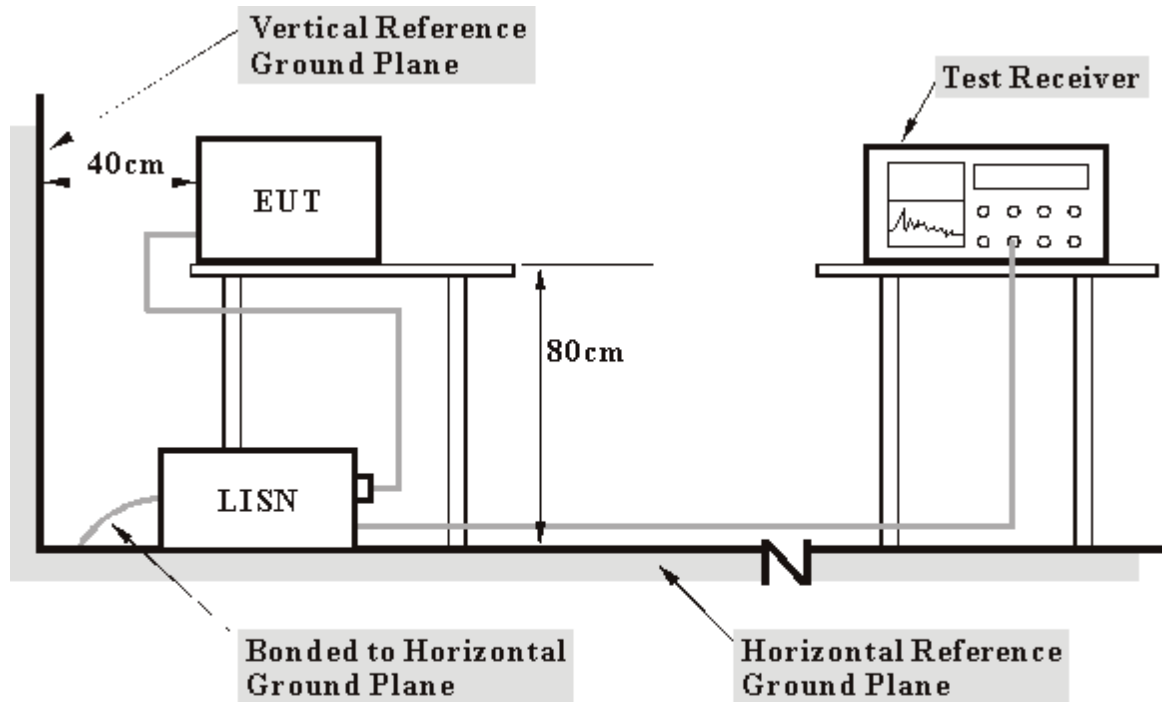

- Note:**
1. Support units were connected to second LISN.
  2. Both of LISNs (AMN) 80 cm from EUT and at the least 80 cm from other units and other metal planes support units.

For the actual test configuration, please refer to the related item – Photographs of the Test Configuration.

#### 4.1.6 EUT OPERATING CONDITIONS

- a. Plug the EUT into the Notebook system placed on a testing table.
- b. The Notebook system ran a test program (provided by manufacturer) to enable EUT under transmission/receiving condition continuously at specific channel frequency.



4.1.7 TEST RESULTS

<b>EUT</b>	Bluetooth Print Combo Adapter	<b>MODEL</b>	BT-0260
<b>CHANNEL</b>	0	<b>6dB BANDWIDTH</b>	9 kHz
<b>INPUT POWER (SYSTEM)</b>	120Vac, 60 Hz	<b>PHASE</b>	Line (L)
<b>ENVIRONMENTAL CONDITIONS</b>	28 deg. C, 70%RH, 991 hPa	<b>TESTED BY:</b> Allen Chang	

No	Freq. [MHz]	Corr. Factor (dB)	Reading Value [dB (uV)]		Emission Level [dB (uV)]		Limit [dB (uV)]		Margin (dB)	
			Q.P.	AV.	Q.P.	AV.	Q.P.	AV.	Q.P.	AV.
			1	0.162	0.10	40.58	-	40.68	-	65.37
<b>2</b>	<b>0.357</b>	<b>0.11</b>	<b>35.15</b>	-	<b>35.26</b>	-	<b>58.80</b>	<b>48.80</b>	<b>-23.54</b>	-
3	1.613	0.26	14.04	-	14.30	-	56.00	46.00	-41.70	-
4	1.773	0.26	12.93	-	13.19	-	56.00	46.00	-42.81	-
5	17.695	0.82	17.53	-	18.35	-	60.00	50.00	-41.65	-
6	20.809	0.96	15.10	-	16.06	-	60.00	50.00	-43.94	-

- REMARKS:**
1. Q.P. and AV. are abbreviations of quasi-peak and average individually.
  2. "-": The Quasi-peak reading value also meets average limit and measurement with the average detector is unnecessary.
  3. The emission levels of other frequencies were very low against the limit.
  4. Margin value = Emission level - Limit value
  5. Correction factor = Insertion loss + Cable loss
  6. Emission Level = Correction Factor + Reading Value.

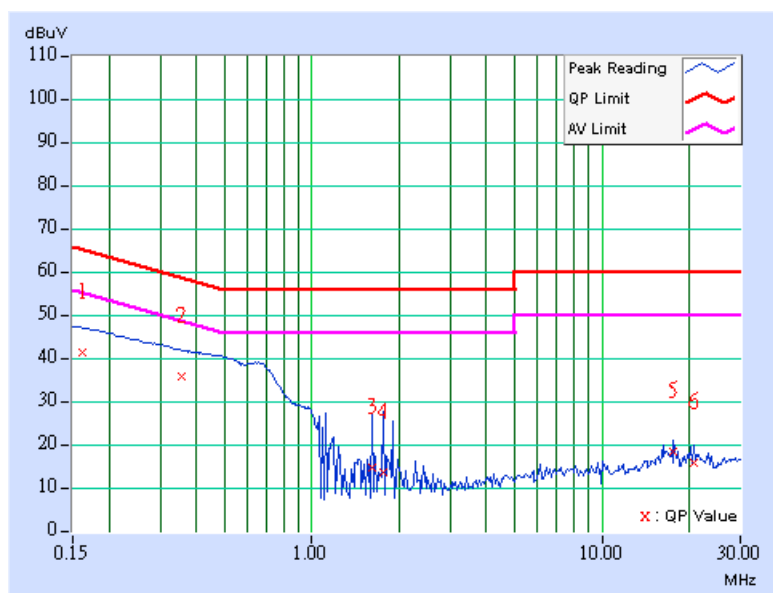



<b>EUT</b>	Bluetooth Print Combo Adapter	<b>MODEL</b>	BT-0260
<b>CHANNEL</b>	0	<b>6dB BANDWIDTH</b>	9 kHz
<b>INPUT POWER (SYSTEM)</b>	120Vac, 60 Hz	<b>PHASE</b>	Neutral (N)
<b>ENVIRONMENTAL CONDITIONS</b>	28 deg. C, 70%RH, 991 hPa	<b>TESTED BY:</b> Allen Chang	

No	Freq. [MHz]	Corr. Factor (dB)	Reading Value		Emission Level		Limit		Margin	
			[dB (uV)]		[dB (uV)]		[dB (uV)]		(dB)	
			Q.P.	AV.	Q.P.	AV.	Q.P.	AV.	Q.P.	AV.
1	0.154	0.10	38.80	-	38.90	-	65.79	55.79	-26.89	-
2	0.271	0.10	33.12	-	33.22	-	61.08	51.08	-27.86	-
3	0.599	0.15	27.72	-	27.87	-	56.00	46.00	-28.13	-
4	1.109	0.24	12.67	-	12.91	-	56.00	46.00	-43.09	-
5	16.227	0.58	23.24	-	23.82	-	60.00	50.00	-36.18	-
6	20.258	0.65	19.95	-	20.60	-	60.00	50.00	-39.40	-

- REMARKS:**
1. Q.P. and AV. are abbreviations of quasi-peak and average individually.
  2. "-": The Quasi-peak reading value also meets average limit and measurement with the average detector is unnecessary.
  3. The emission levels of other frequencies were very low against the limit.
  4. Margin value = Emission level - Limit value
  5. Correction factor = Insertion loss + Cable loss
  6. Emission Level = Correction Factor + Reading Value.

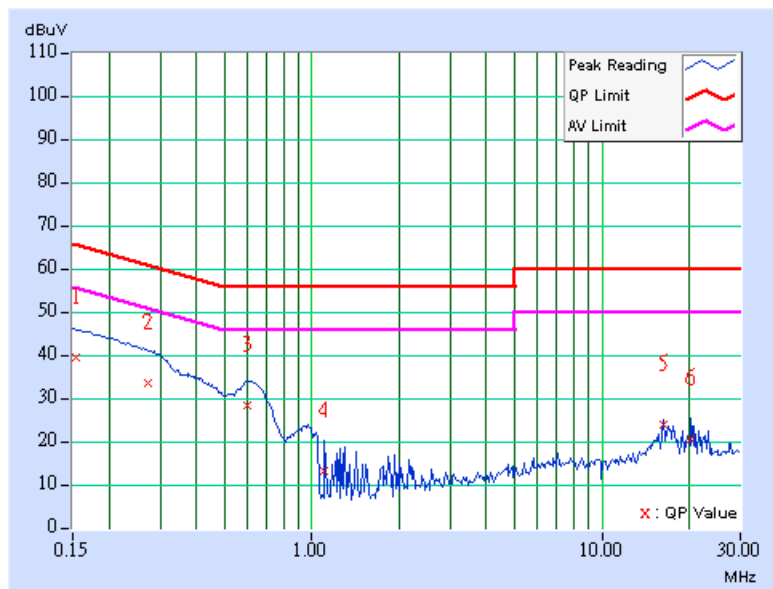



<b>EUT</b>	Bluetooth Print Combo Adapter	<b>MODEL</b>	BT-0260
<b>CHANNEL</b>	39	<b>6dB BANDWIDTH</b>	9 kHz
<b>INPUT POWER (SYSTEM)</b>	120Vac, 60 Hz	<b>PHASE</b>	Line (L)
<b>ENVIRONMENTAL CONDITIONS</b>	28 deg. C, 70%RH, 991 hPa	<b>TESTED BY:</b> Allen Chang	

No	Freq. [MHz]	Corr. Factor (dB)	Reading Value [dB (uV)]		Emission Level [dB (uV)]		Limit [dB (uV)]		Margin (dB)	
			Q.P.	AV.	Q.P.	AV.	Q.P.	AV.	Q.P.	AV.
			1	0.181	0.10	38.74	-	38.84	-	64.43
2	0.338	0.11	33.80	-	33.91	-	59.26	49.26	-25.36	-
3	0.681	0.18	31.13	-	31.31	-	56.00	46.00	-24.69	-
4	1.117	0.25	14.41	-	14.66	-	56.00	46.00	-41.34	-
5	16.777	0.78	14.35	-	15.13	-	60.00	50.00	-44.87	-
6	20.258	0.93	17.77	-	18.70	-	60.00	50.00	-41.30	-

- REMARKS:**
1. Q.P. and AV. are abbreviations of quasi-peak and average individually.
  2. "-": The Quasi-peak reading value also meets average limit and measurement with the average detector is unnecessary.
  3. The emission levels of other frequencies were very low against the limit.
  4. Margin value = Emission level - Limit value
  5. Correction factor = Insertion loss + Cable loss
  6. Emission Level = Correction Factor + Reading Value.

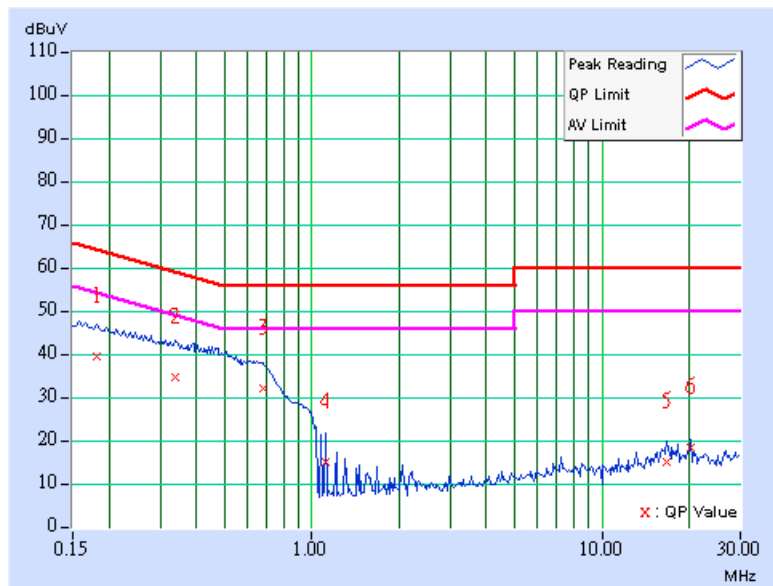



<b>EUT</b>	Bluetooth Print Combo Adapter	<b>MODEL</b>	BT-0260
<b>CHANNEL</b>	39	<b>6dB BANDWIDTH</b>	9 kHz
<b>INPUT POWER (SYSTEM)</b>	120Vac, 60 Hz	<b>PHASE</b>	Neutral (N)
<b>ENVIRONMENTAL CONDITIONS</b>	28 deg. C, 70%RH, 991 hPa	<b>TESTED BY:</b> Allen Chang	

No	Freq. [MHz]	Corr. Factor (dB)	Reading Value [dB (uV)]		Emission Level [dB (uV)]		Limit [dB (uV)]		Margin (dB)	
			Q.P.	AV.	Q.P.	AV.	Q.P.	AV.	Q.P.	AV.
			1	0.162	0.10	38.78	-	38.88	-	65.38
2	0.275	0.11	33.18	-	33.29	-	60.97	50.97	-27.68	-
3	0.619	0.16	27.76	-	27.92	-	56.00	46.00	-28.08	-
4	1.066	0.24	13.42	-	13.66	-	56.00	46.00	-42.34	-
5	19.707	0.64	17.57	-	18.21	-	60.00	50.00	-41.79	-
6	21.664	0.67	20.14	-	20.81	-	60.00	50.00	-39.19	-

- REMARKS:**
1. Q.P. and AV. are abbreviations of quasi-peak and average individually.
  2. "-": The Quasi-peak reading value also meets average limit and measurement with the average detector is unnecessary.
  3. The emission levels of other frequencies were very low against the limit.
  4. Margin value = Emission level - Limit value
  5. Correction factor = Insertion loss + Cable loss
  6. Emission Level = Correction Factor + Reading Value.

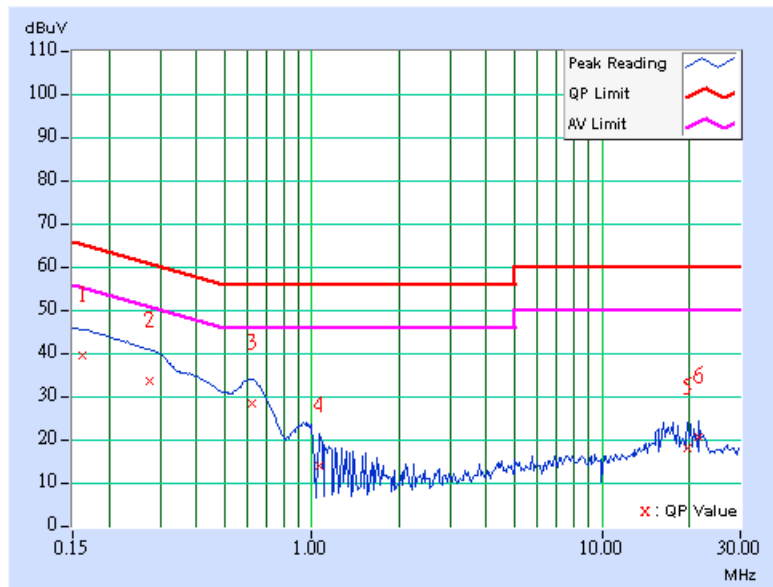



<b>EUT</b>	Bluetooth Print Combo Adapter	<b>MODEL</b>	BT-0260
<b>CHANNEL</b>	78	<b>6dB BANDWIDTH</b>	9 kHz
<b>INPUT POWER (SYSTEM)</b>	120Vac, 60 Hz	<b>PHASE</b>	Line (L)
<b>ENVIRONMENTAL CONDITIONS</b>	28 deg. C, 70%RH, 991 hPa	<b>TESTED BY:</b> Allen Chang	

No	Freq. [MHz]	Corr. Factor (dB)	Reading Value [dB (uV)]		Emission Level [dB (uV)]		Limit [dB (uV)]		Margin (dB)	
			Q.P.	AV.	Q.P.	AV.	Q.P.	AV.	Q.P.	AV.
			1	0.173	0.10	39.09	-	39.19	-	64.79
2	0.275	0.11	35.31	-	35.42	-	60.97	50.97	-25.55	-
3	0.654	0.17	31.76	-	31.93	-	56.00	46.00	-24.07	-
4	1.066	0.25	16.32	-	16.57	-	56.00	46.00	-39.43	-
5	16.840	0.78	15.57	-	16.35	-	60.00	50.00	-43.65	-
6	20.258	0.93	17.67	-	18.60	-	60.00	50.00	-41.40	-

- REMARKS:**
1. Q.P. and AV. are abbreviations of quasi-peak and average individually.
  2. "-": The Quasi-peak reading value also meets average limit and measurement with the average detector is unnecessary.
  3. The emission levels of other frequencies were very low against the limit.
  4. Margin value = Emission level - Limit value
  5. Correction factor = Insertion loss + Cable loss
  6. Emission Level = Correction Factor + Reading Value.

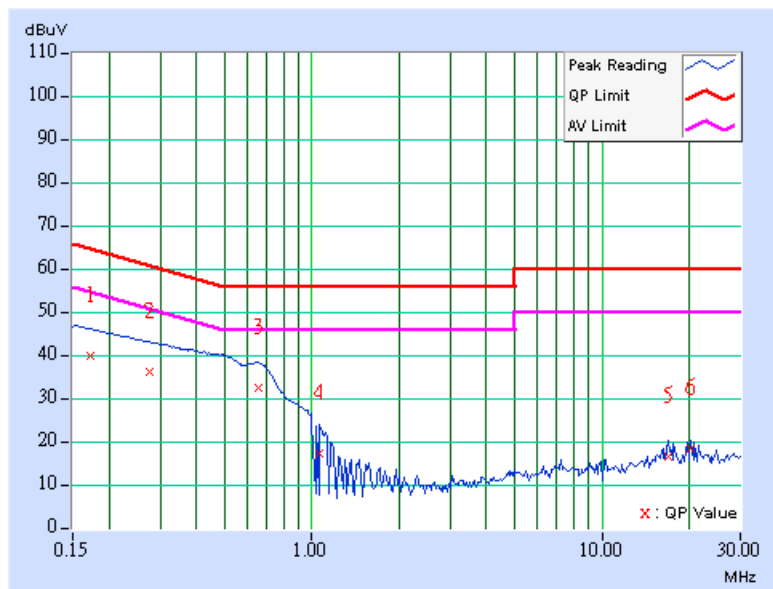





<b>EUT</b>	Bluetooth Print Combo Adapter	<b>MODEL</b>	BT-0260
<b>CHANNEL</b>	78	<b>6dB BANDWIDTH</b>	9 kHz
<b>INPUT POWER (SYSTEM)</b>	120Vac, 60 Hz	<b>PHASE</b>	Neurral (N)
<b>ENVIRONMENTAL CONDITIONS</b>	28 deg. C, 70%RH, 991 hPa	<b>TESTED BY:</b> Allen Chang	

No	Freq. [MHz]	Corr. Factor (dB)	Reading Value		Emission Level		Limit		Margin	
			[dB (uV)]		[dB (uV)]		[dB (uV)]		(dB)	
			Q.P.	AV.	Q.P.	AV.	Q.P.	AV.	Q.P.	AV.
1	0.177	0.10	38.04	-	38.14	-	64.61	54.61	-26.47	-
2	0.255	0.10	34.01	-	34.11	-	61.58	51.58	-27.46	-
3	0.603	0.15	27.86	-	28.01	-	56.00	46.00	-27.99	-
4	1.137	0.24	11.97	-	12.21	-	56.00	46.00	-43.79	-
5	16.227	0.58	23.20	-	23.78	-	60.00	50.00	-36.22	-
6	17.695	0.61	22.06	-	22.67	-	60.00	50.00	-37.33	-

- REMARKS:**
1. Q.P. and AV. are abbreviations of quasi-peak and average individually.
  2. "-": The Quasi-peak reading value also meets average limit and measurement with the average detector is unnecessary.
  3. The emission levels of other frequencies were very low against the limit.
  4. Margin value = Emission level - Limit value
  5. Correction factor = Insertion loss + Cable loss
  6. Emission Level = Correction Factor + Reading Value.

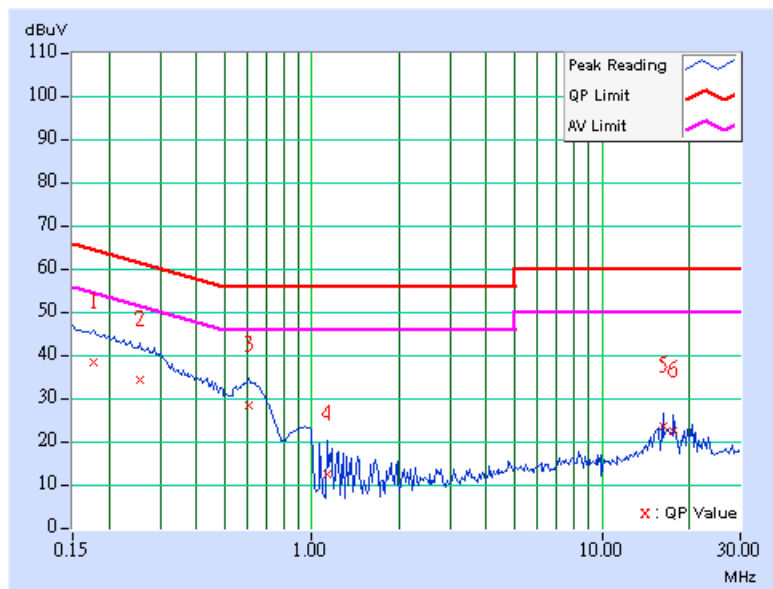



## 4.2 NUMBER OF HOPPING FREQUENCY USED

### 4.2.1 LIMIT OF HOPPING FREQUENCY USED

At least 15 hopping frequencies, and should be equally spaced.

### 4.2.2 TEST INSTRUMENTS

Description & Manufacturer	Model No.	Serial No.	Calibrated Until
SPECTRUM ANALYZER	FSEK30	100049	Aug. 12, 2004

**NOTE:**

The calibration interval of the above test instruments is 12 months. And the calibrations are traceable to NML/ROC and NIST/USA.



#### 4.2.3 TEST PROCEDURES

1. Check the calibration of the measuring instrument (SA) using either an internal calibrator or a known signal from an external generator.
2. Turn on the EUT and connect its antenna terminal to measurement via a low loss cable. Then set it to any one measured frequency within its operating range and make sure the instrument is operated in its linear range.
3. Set the SA on MaxHold Mode, and then keep the EUT in hopping mode. Record all the signals from each channel until each one has been recorded.
4. Set the SA on View mode and then plot the result on SA screen.
5. Repeat above procedures until all frequencies measured were complete.

#### 4.2.4 DEVIATION FROM TEST STANDARD

No deviation

#### 4.2.5 TEST SETUP

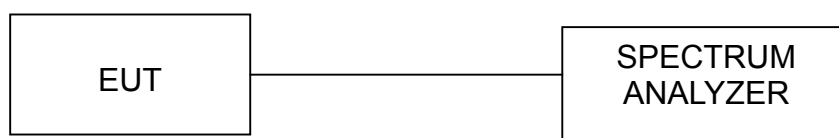

#### 4.2.6 TEST RESULTS

There are 79 hopping frequencies in the hopping mode. Please refer to next two pages for the test result. On the plots, it shows that the hopping frequencies are equally spaced.

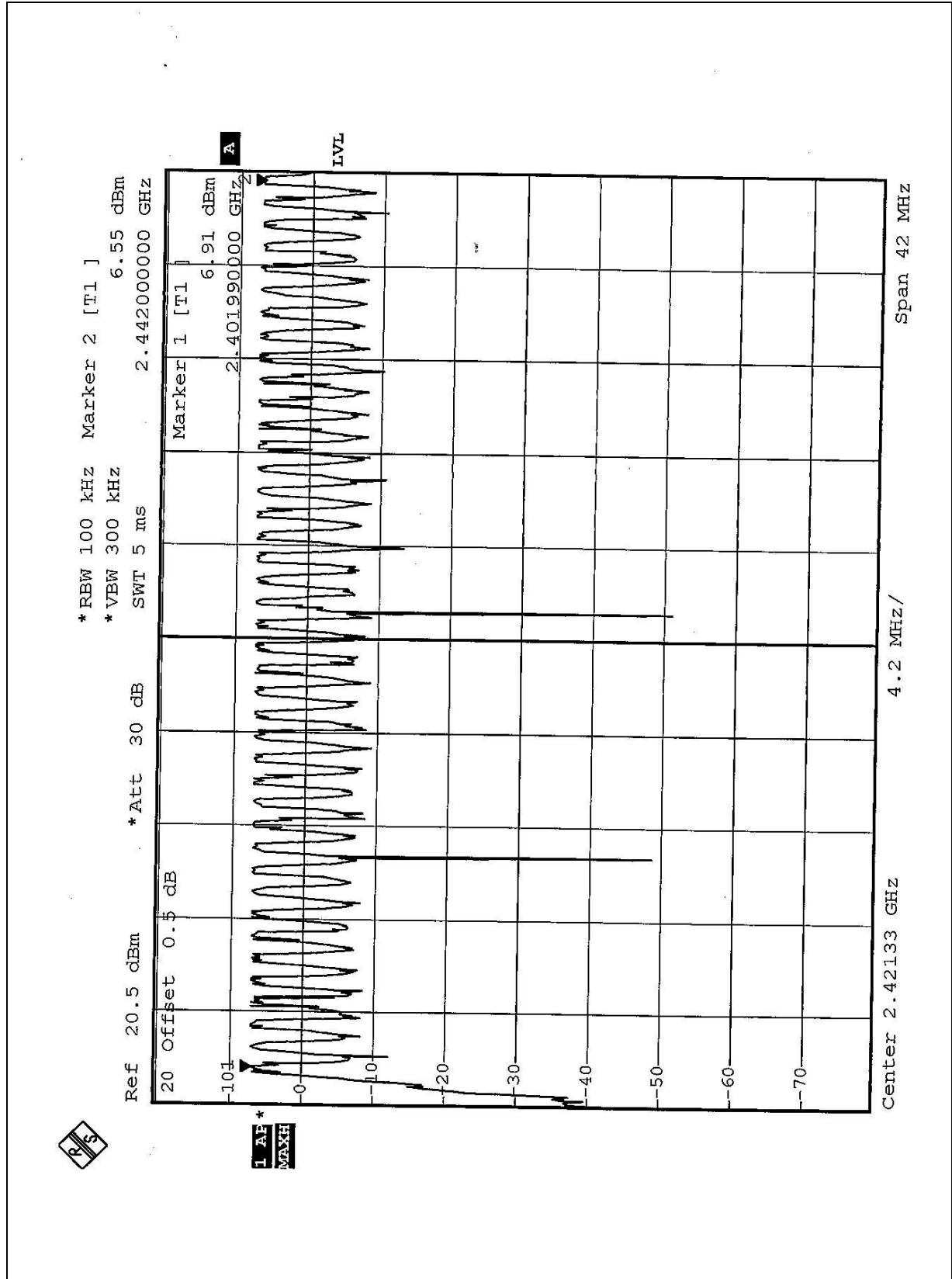

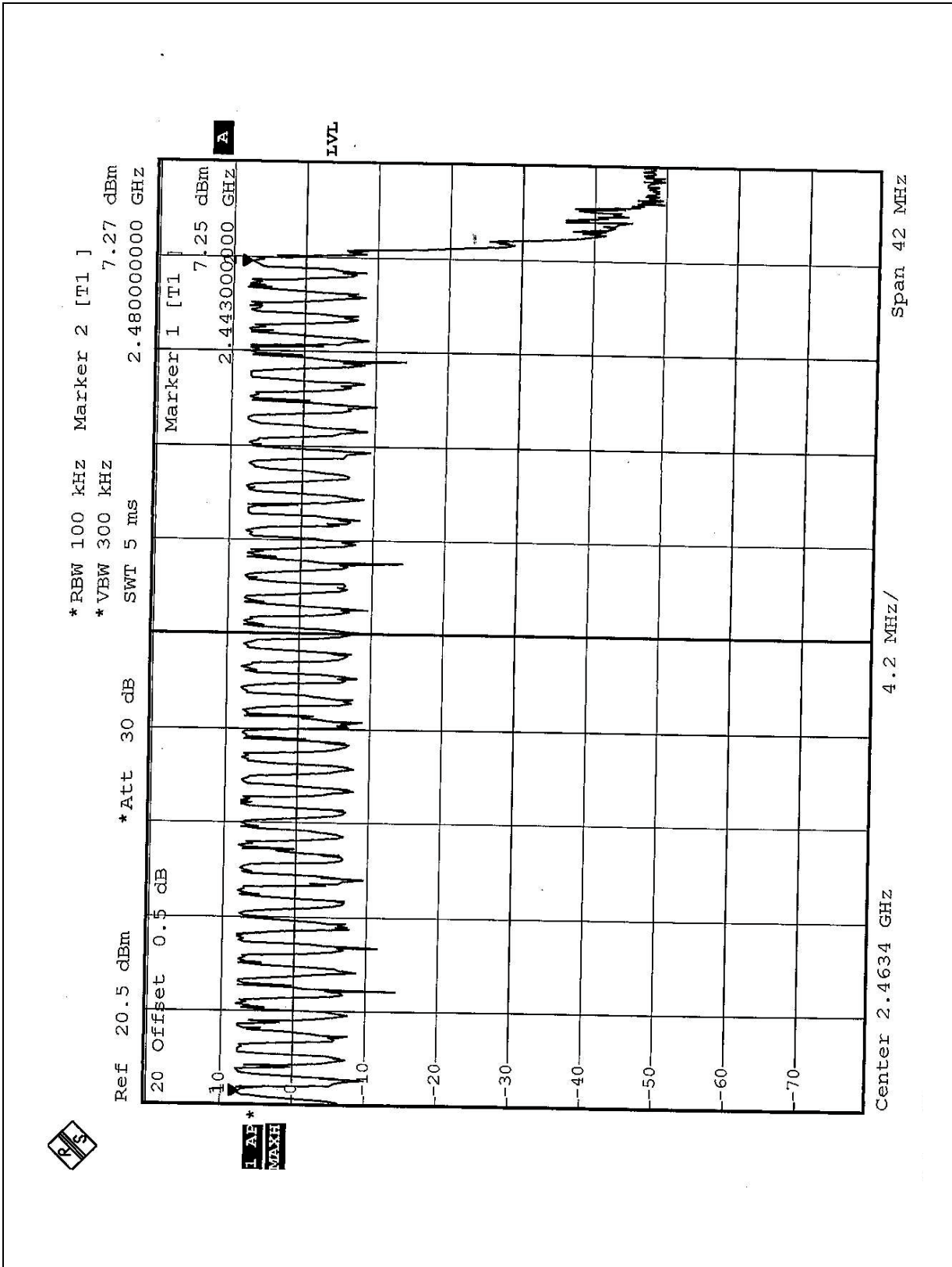



**4.3 DWELL TIME ON EACH CHANNEL**

**4.3.1 LIMIT OF DWELL TIME USED**

For FHSS, the average time of occupancy on any frequency shall not be greater than 0.4 seconds within a 31.6 second period. For hybrid systems, the average time of occupancy on any frequency should not exceed 0.4 seconds within a time period in seconds equal to the number of hopping frequencies employed multiplied by 0.4.

**4.3.2 TEST INSTRUMENTS**

Description & Manufacturer	Model No.	Serial No.	Calibrated Until
SPECTRUM ANALYZER	FSEK30	100049	Aug. 12, 2004

**NOTES:**

The calibration interval of the above test instruments is 12 months. And the calibrations are traceable to NML/ROC and NIST/USA.

#### 4.3.3 TEST PROCEDURES

1. Check the calibration of the measuring instrument (SA) using either an internal calibrator or a known signal from an external generator.
2. Turn on the EUT and connect its antenna terminal to measurement via a low loss cable. Then set it to any one measured frequency within its operating range and make sure the instrument is operated in its linear range.
3. Adjust the center frequency of SA on any frequency be measured and set SA to zero span mode. And then, set RBW and VBW of spectrum analyzer to proper value.
4. Measure the time duration of one transmission on the measured frequency. And then plot the result with time difference of this time duration.
5. Repeat above procedures until all frequencies measured were complete.

#### 4.3.4 DEVIATION FROM TEST STANDARD

No deviation

#### 4.3.5 TEST SETUP





## 4.3.6 TEST RESULTS

Mode	Number of transmission in a 31.6 (79Hopping*0.4)	Length of transmission time (msec)	Result (msec)	Limit (msec)
DH1	50 (times / 5 sec) *6.32=316.00 times	0.476	150.416	400
DH3	25 (times / 5 sec) *6.32=158.00 times	1.740	274.920	400
DH5	17 (times / 5 sec) *6.32=107.44 times	3.030	325.540	400

Test plots of the transmitting time slot are shown on next six pages.



DH1

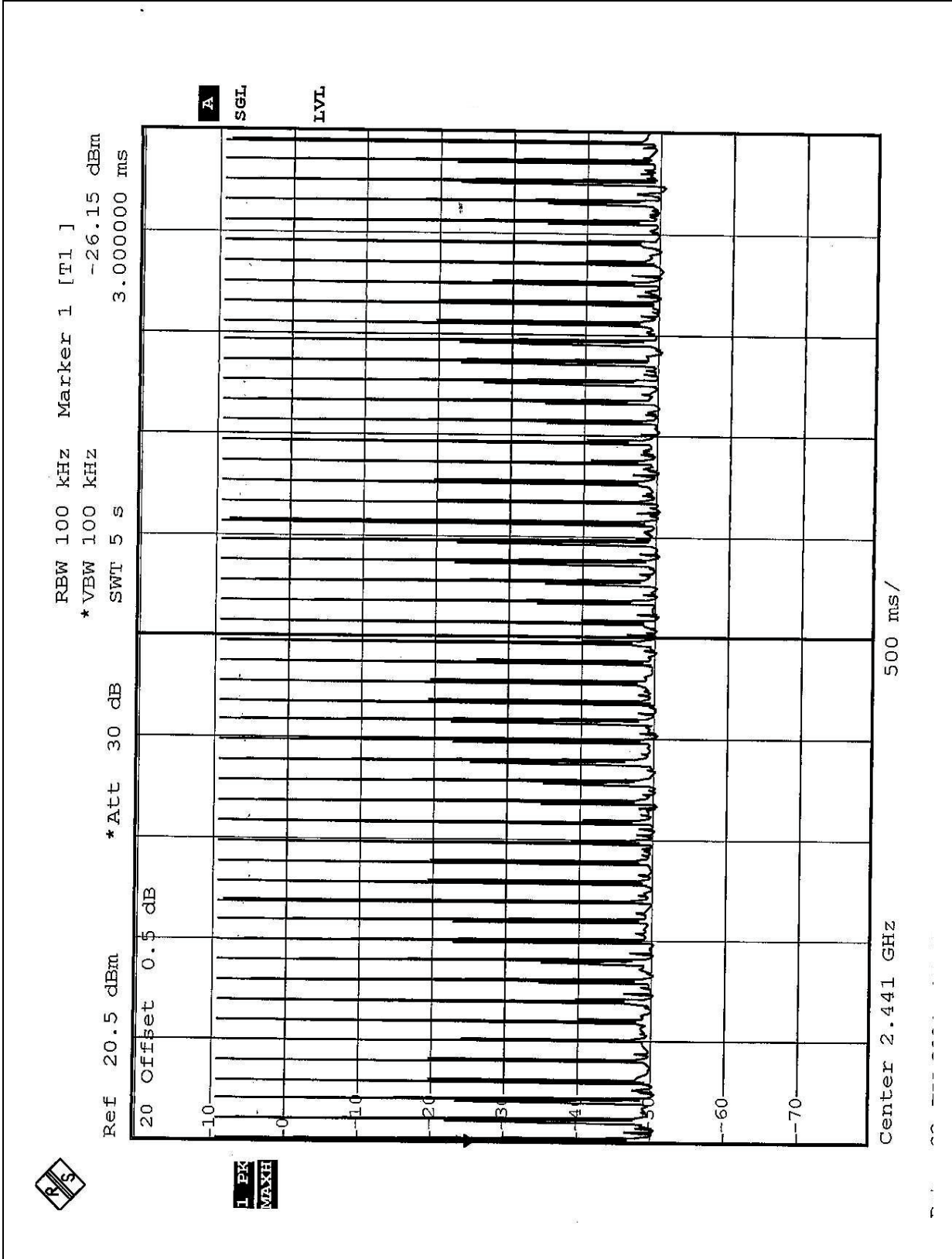



DH1

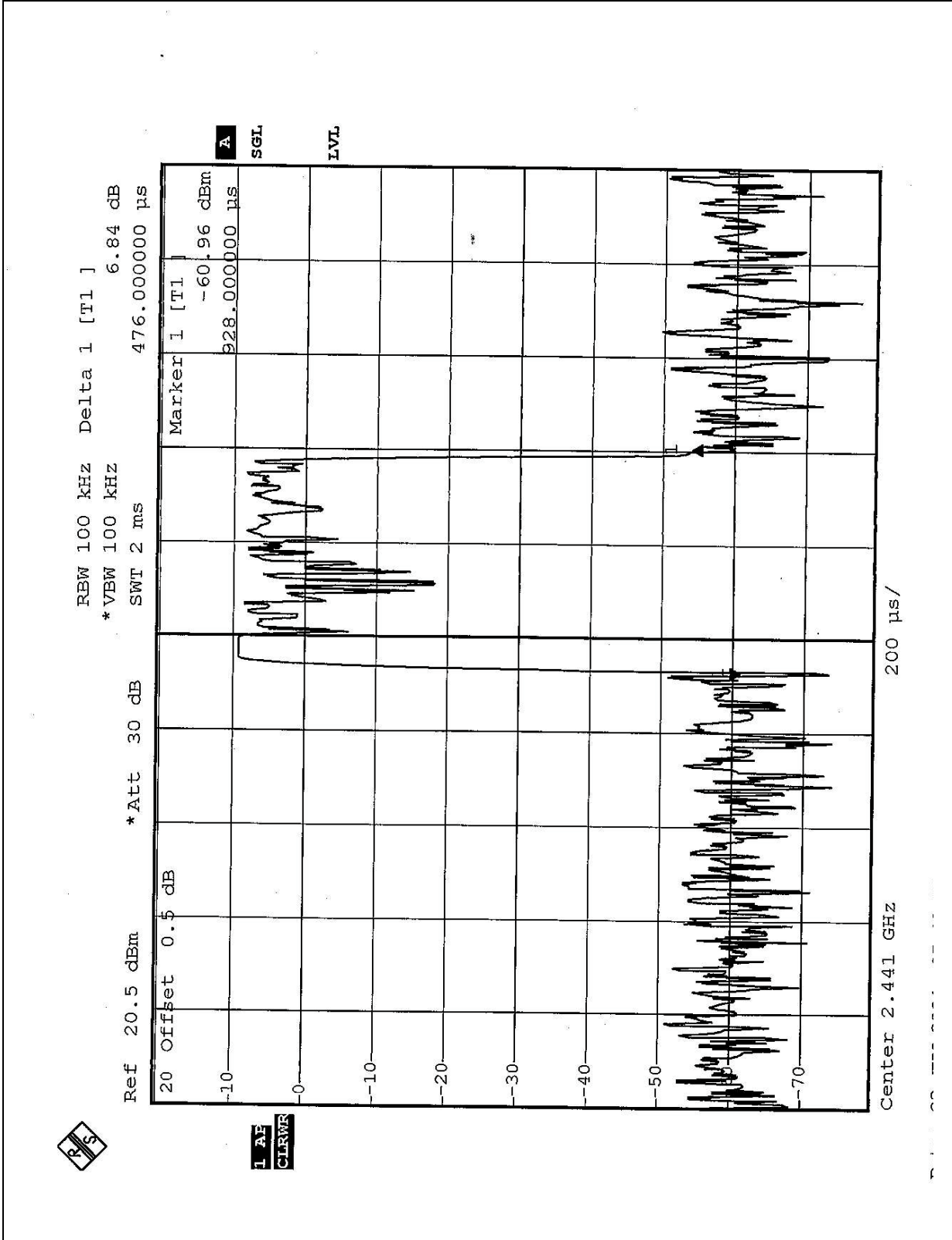



DH3

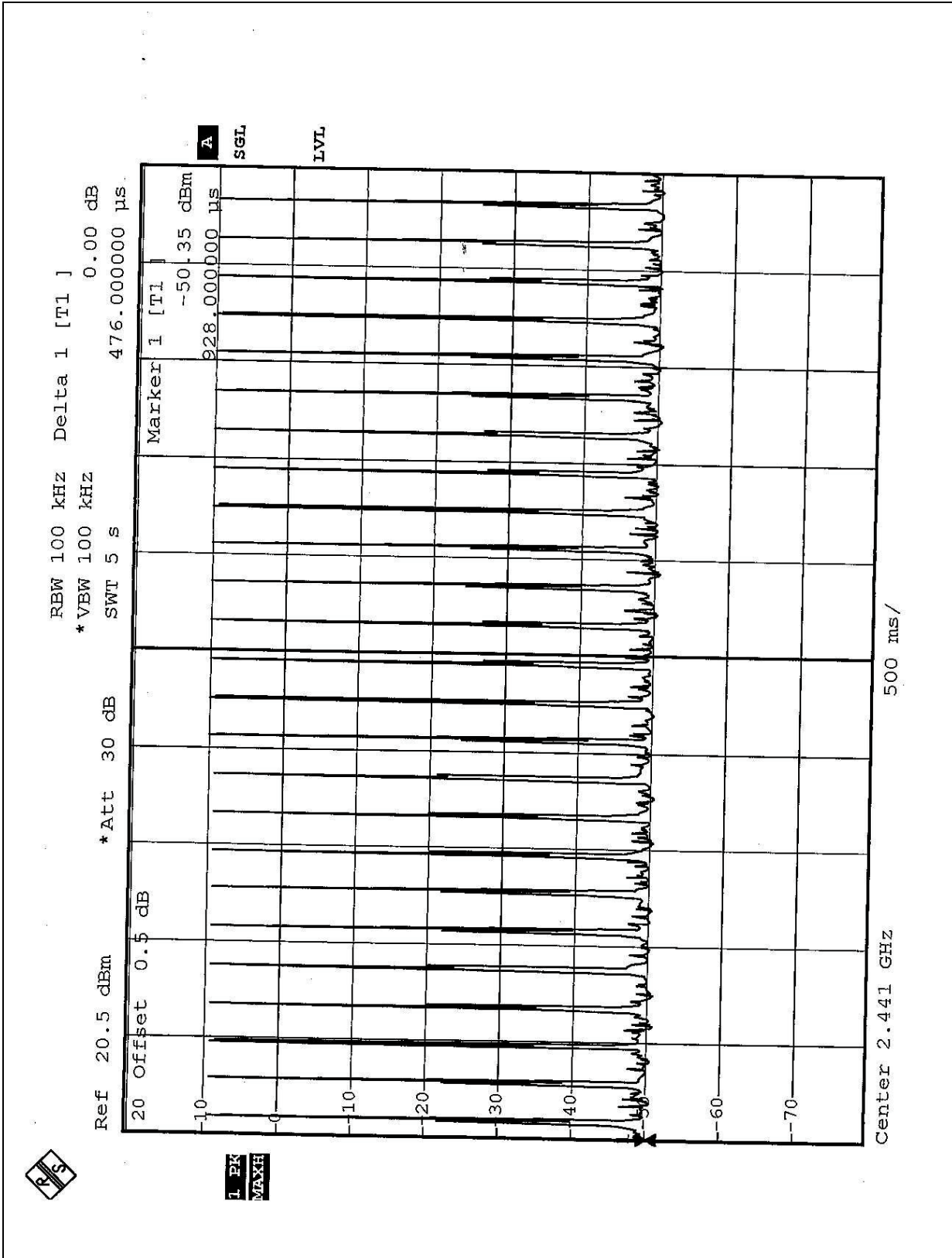



DH3

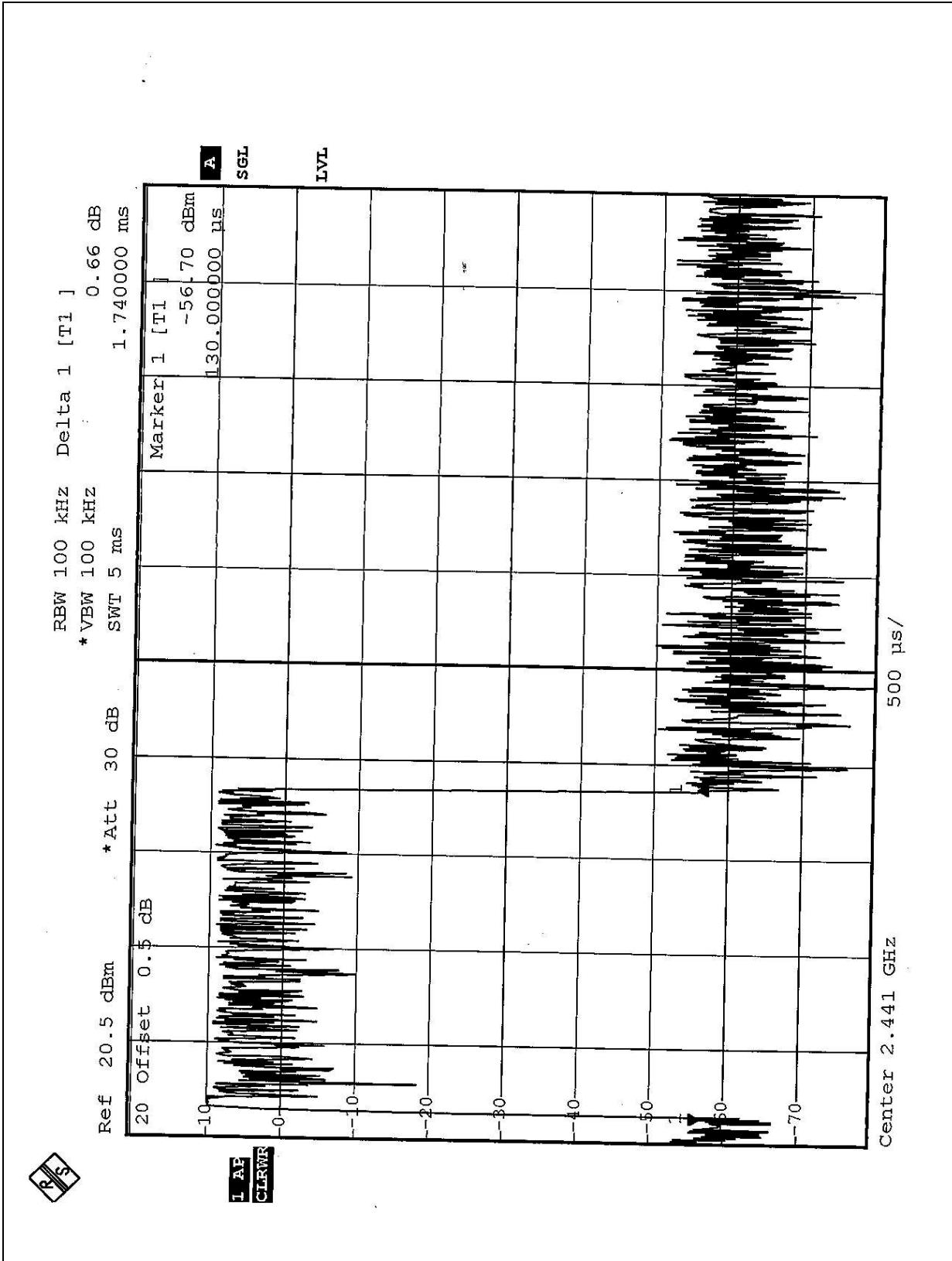



DH5

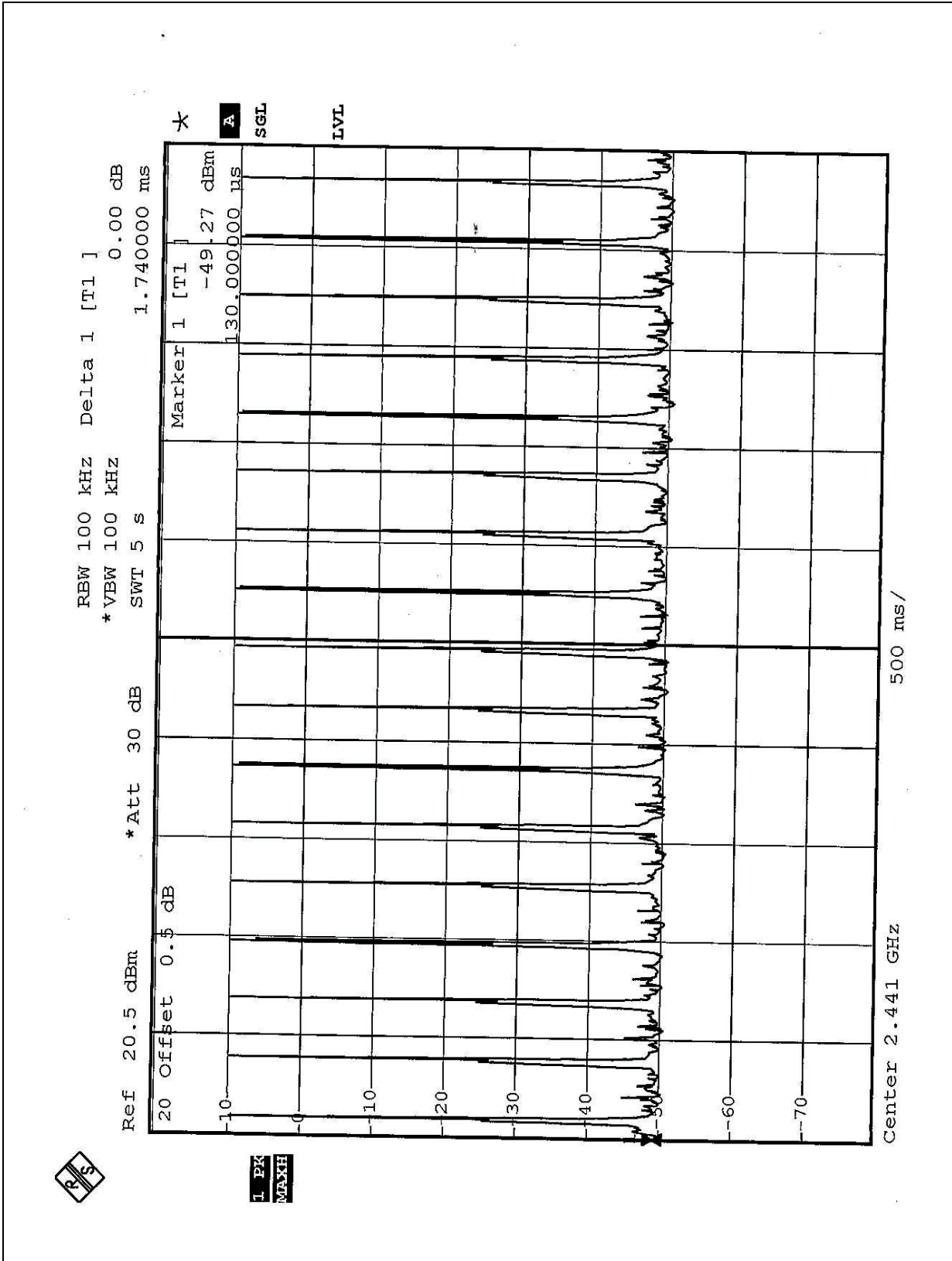



DH5

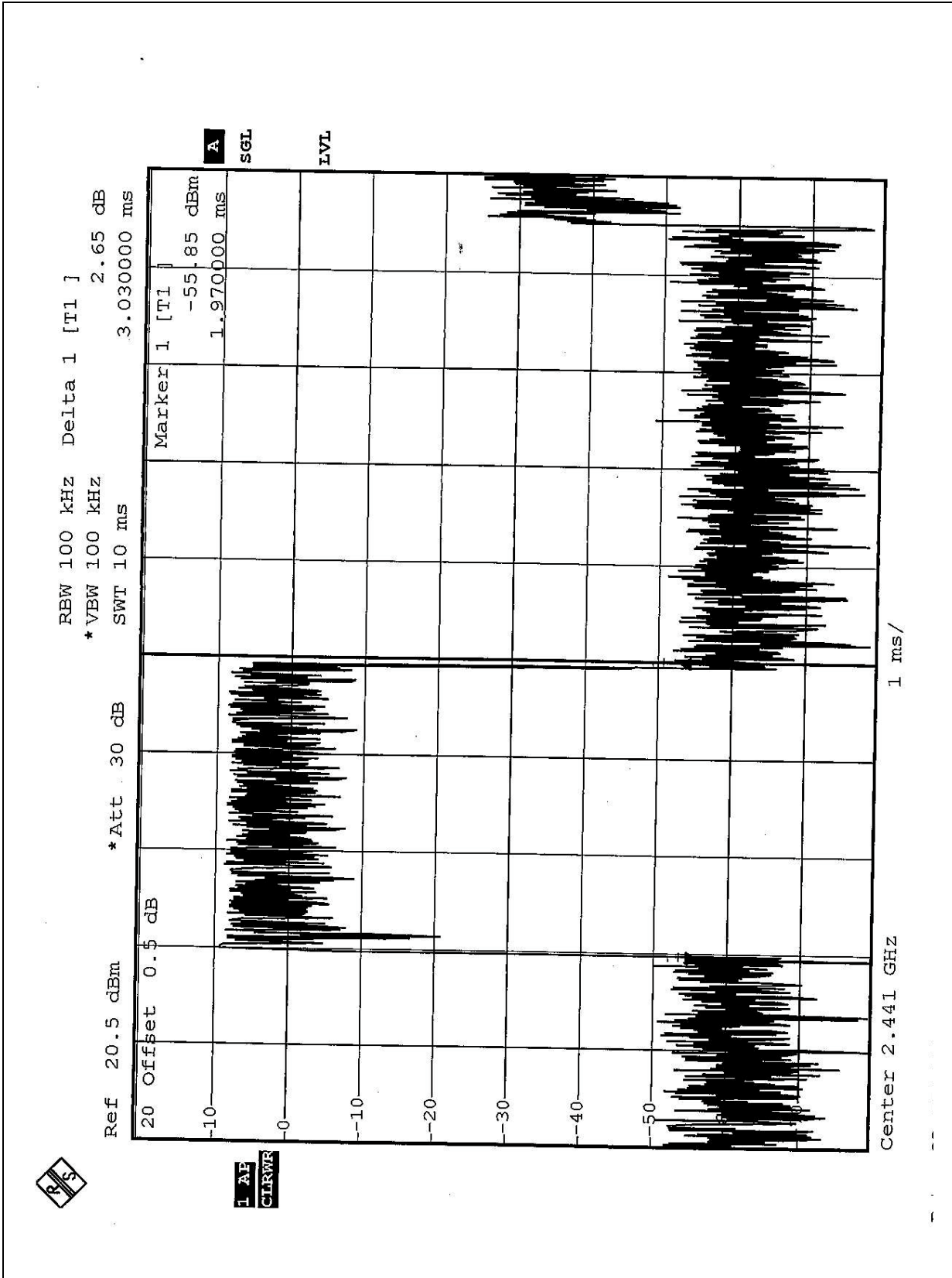

#### 4.4 CHANNEL BANDWIDTH

##### 4.4.1 LIMITS OF CHANNEL BANDWIDTH

For frequency hopping system operating in the 2400-2483.5 MHz and 5725-5850 MHz bands, the maximum 20dB bandwidth of the hopping channel is 1 MHz.

##### 4.4.2 TEST INSTRUMENTS

Description & Manufacturer	Model No.	Serial No.	Calibrated Until
SPECTRUM ANALYZER	FSEK30	100049	Aug. 12, 2004

##### NOTES:

- 1.The measurement uncertainty is less than +/- 2.6dB, which is calculated as per the NAMAS document NIS81.
- 2.The calibration interval of the above test instruments is 12 months. And the calibrations are traceable to NML/ROC and NIST/USA.





#### 4.4.3 TEST PROCEDURE

1. Check the calibration of the measuring instrument using either an internal calibrator or a known signal from an external generator.
2. Turn on the EUT and connect it to measurement instrument. Then set it to any one convenient frequency within its operating range. Set a reference level on the measuring instrument equal to the highest peak value.
3. Measure the frequency difference of two frequencies that were attenuated 20dB from the reference level. Record the frequency difference as the emission bandwidth.
4. Repeat above procedures until all frequencies measured were complete.

#### 4.4.4 DEVIATION FROM TEST STANDARD

No deviation

#### 4.4.5 TEST SETUP



#### 4.4.6 EUT OPERATING CONDITION

The software provided by client enabled the EUT to transmit and receive data at lowest, middle and highest channel frequencies individually.

## 4.4.7 TEST RESULTS

<b>EUT</b>	Bluetooth Print Combo Adapter	<b>MODEL</b>	BT-0260
<b>ENVIRONMENTAL CONDITIONS</b>	28deg. C, 70%RH, 991 hPa	<b>INPUT POWER (SYSTEM)</b>	120Vac, 60 Hz
<b>TESTED BY:</b> Allen Chang			

<b>CHANNEL</b>	<b>CHANNEL FREQUENCY (MHz)</b>	<b>20dB BANDWIDTH (kHz)</b>	<b>MAXIMUM LIMIT (MHz)</b>	<b>PASS/FAIL</b>
0	2402	981	1	PASS
39	2441	963	1	PASS
78	2480	834	1	PASS

### Channel 0

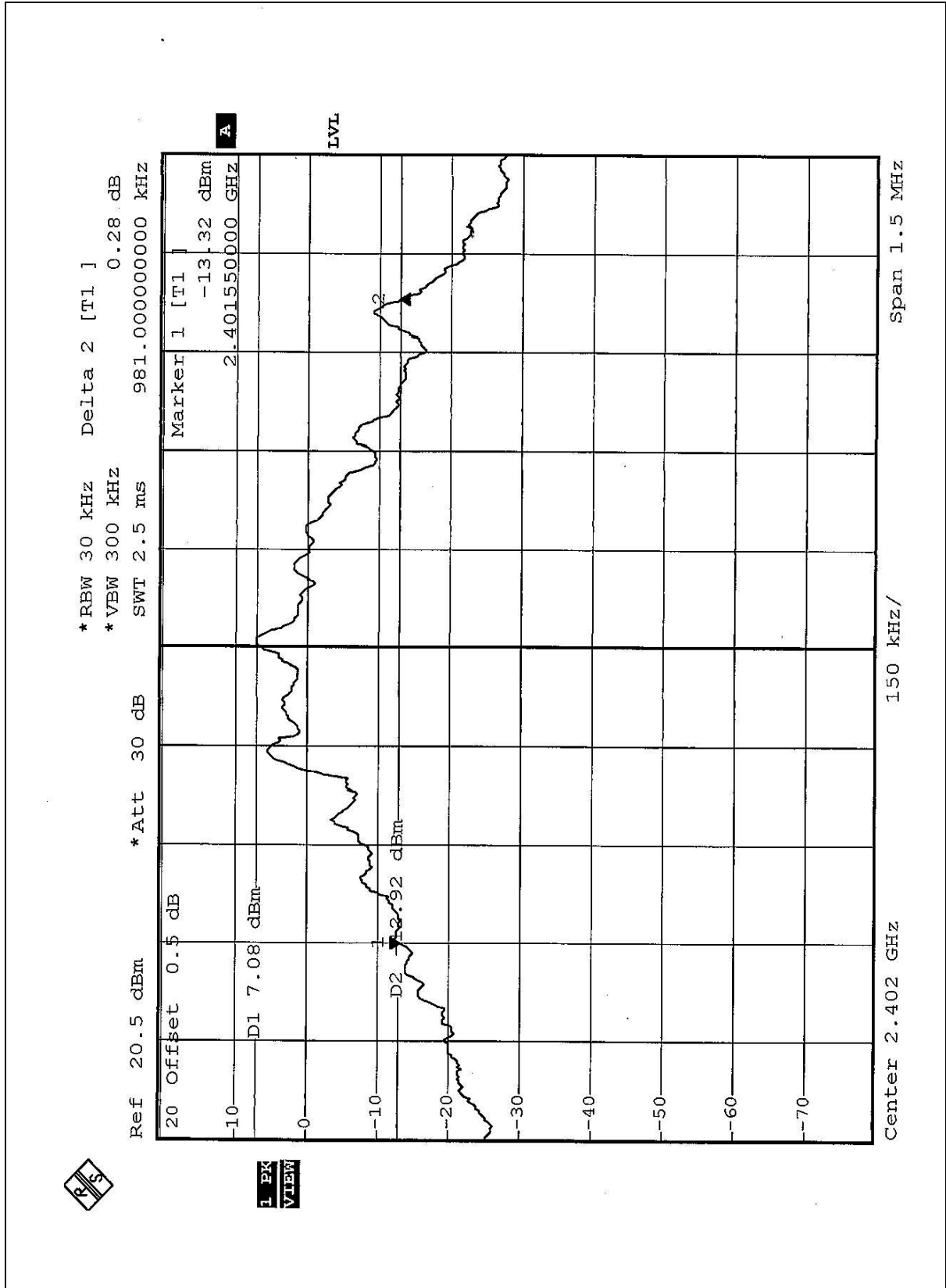



Channel 39

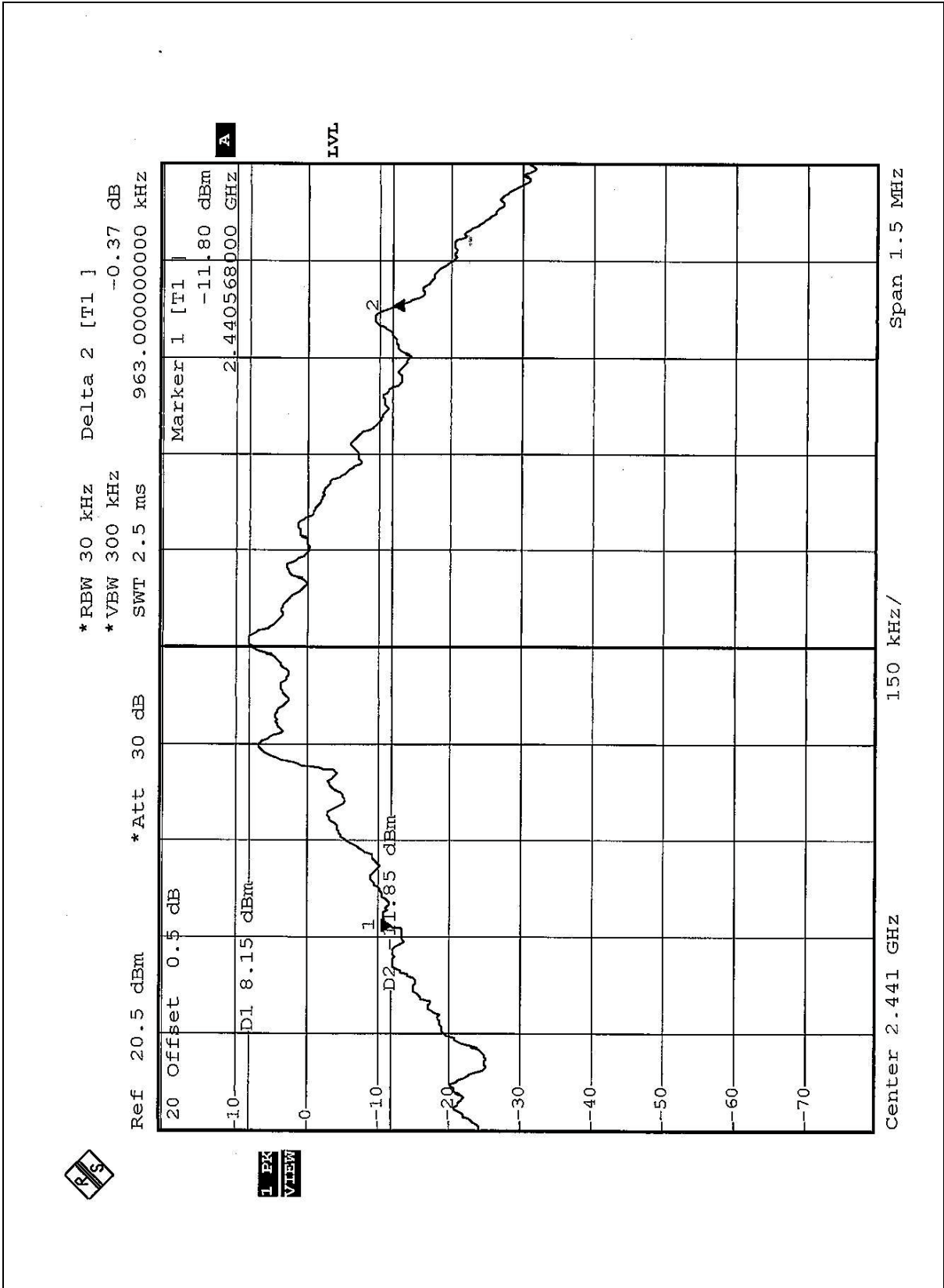



### Channel 78

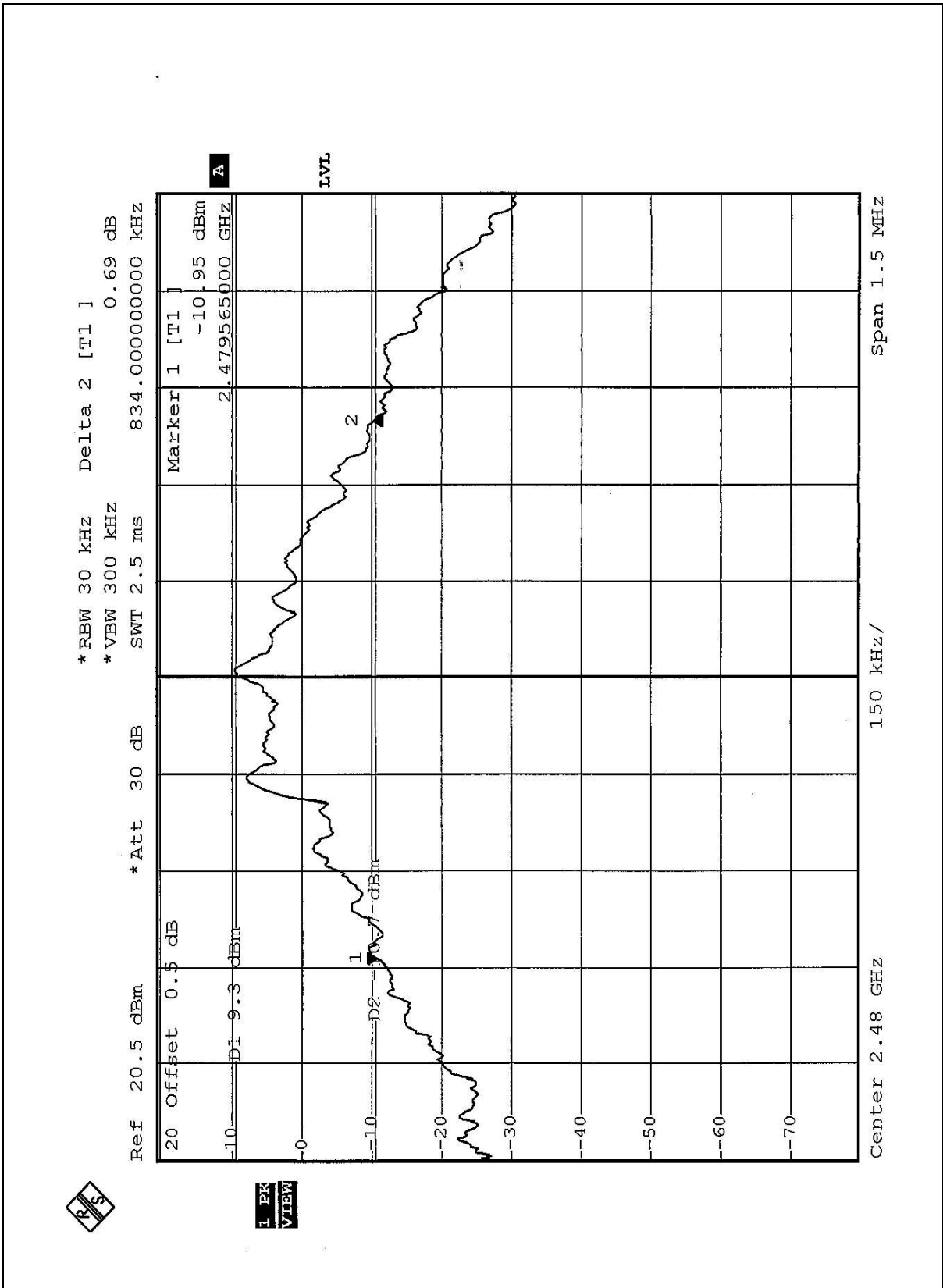

## 4.5 HOPPING CHANNEL SEPARATION

### 4.5.1 LIMIT OF HOPPING CHANNEL SEPARATION

At least 25kHz or 20dB bandwidth (whichever is greater).

### 4.5.2 TEST INSTRUMENTS

Description & Manufacturer	Model No.	Serial No.	Calibrated Until
SPECTRUM ANALYZER	FSEK30	100049	Aug. 12, 2004

#### NOTES:

The calibration interval of the above test instruments is 12 months. And the calibrations are traceable to NML/ROC and NIST/USA.

#### 4.5.3 TEST PROCEDURES

1. Check the calibration of the measuring instrument using either an internal calibrator or a known signal from an external generator.
2. Turn on the EUT and connect it to measurement instrument. Then set it to any one convenient frequency within its operating range.
3. By using the MaxHold function record the separation of two adjacent channels.
4. Measure the frequency difference of these two adjacent channels by SA MARK function. And then plot the result on SA screen.
5. Repeat above procedures until all frequencies measured were complete.

#### 4.5.4 DEVIATION FROM TEST STANDARD

No deviation

#### 4.5.5 TEST SETUP

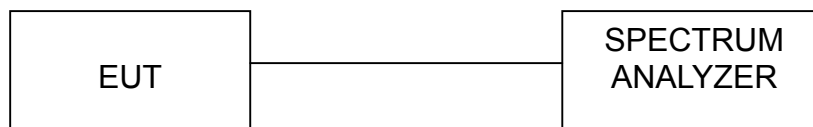



## 4.5.6 TEST RESULTS

<b>EUT</b>	Bluetooth Print Combo Adapter	<b>MODEL</b>	BT-0260
<b>ENVIRONMENTAL CONDITIONS</b>	28 deg. C, 70%RH, 991 hPa	<b>INPUT POWER (SYSTEM)</b>	120Vac, 60 Hz
<b>TESTED BY:</b> Allen Chang			

<b>Channel</b>	<b>Frequency (MHz)</b>	<b>Adjacent Channel Separation</b>	<b>Minimum Limit (kHz)</b>	<b>Pass / Fail</b>
0	2402	1.005MHz	981	PASS
39	2441	1.010MHz	963	PASS
78	2480	1.005MHz	834	PASS

The minimum limit is 20dB bandwidth. Test results please refer to next three pages.





### Channel 0

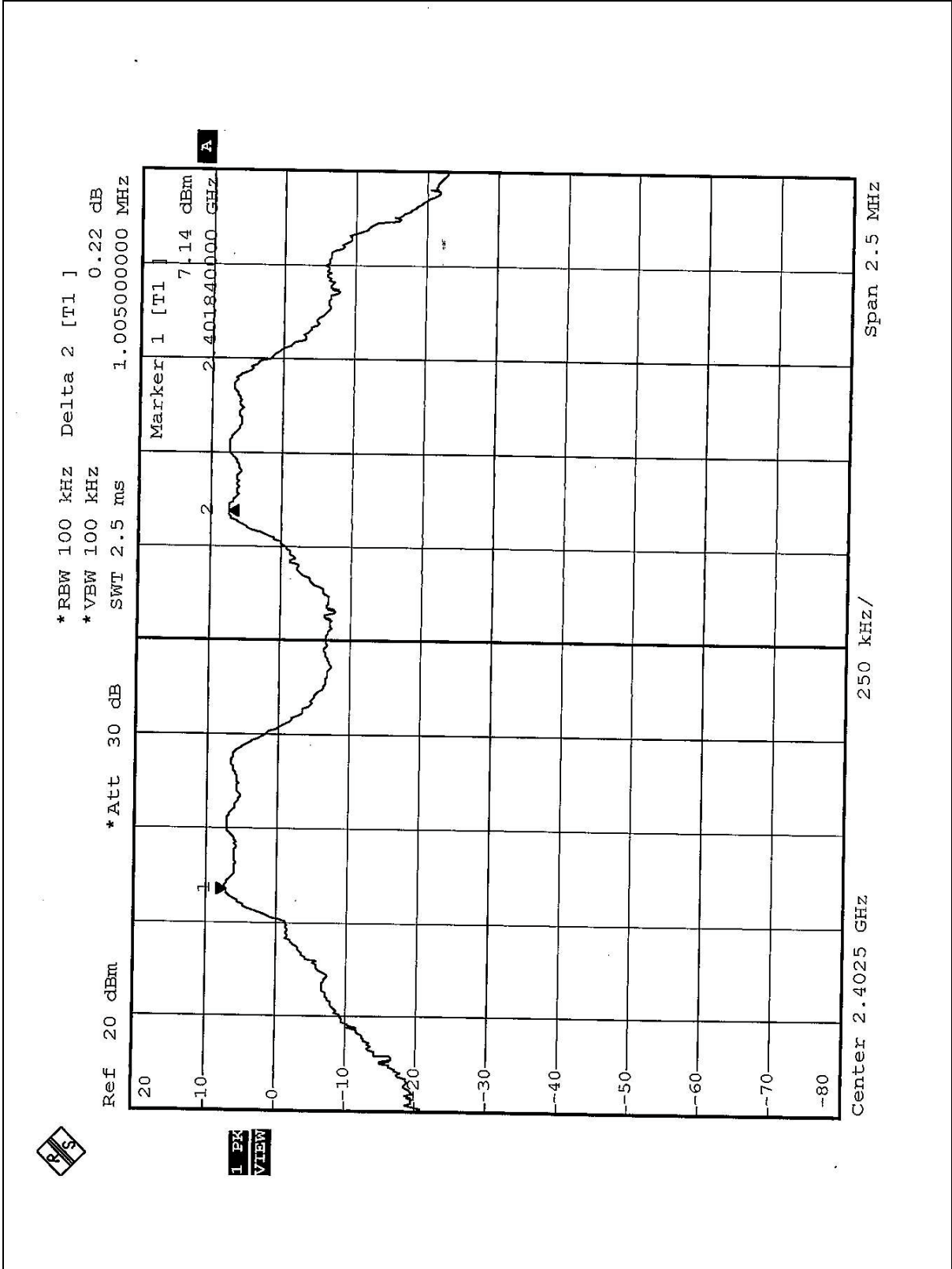

### Channel 39

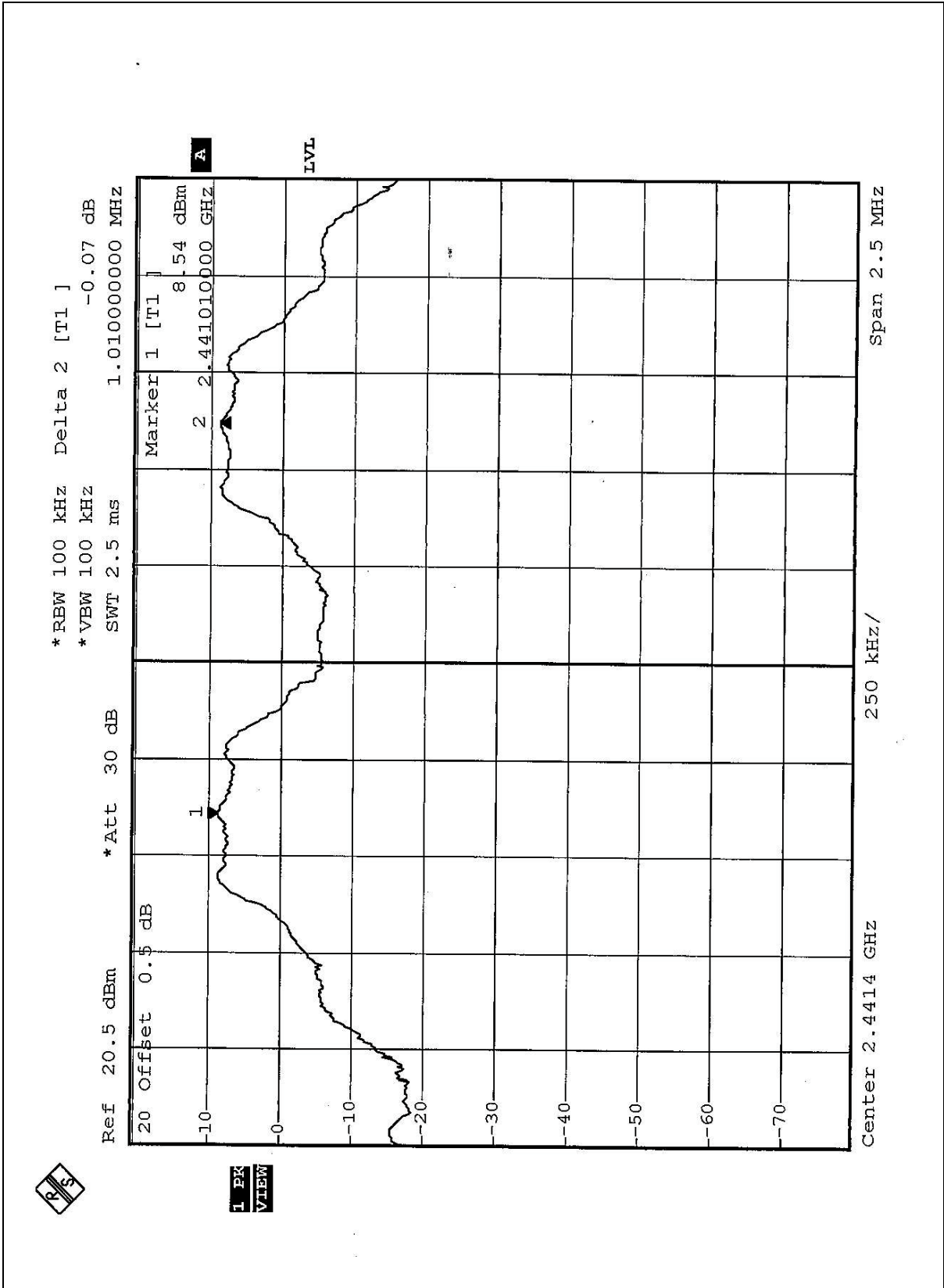

### Channel 78

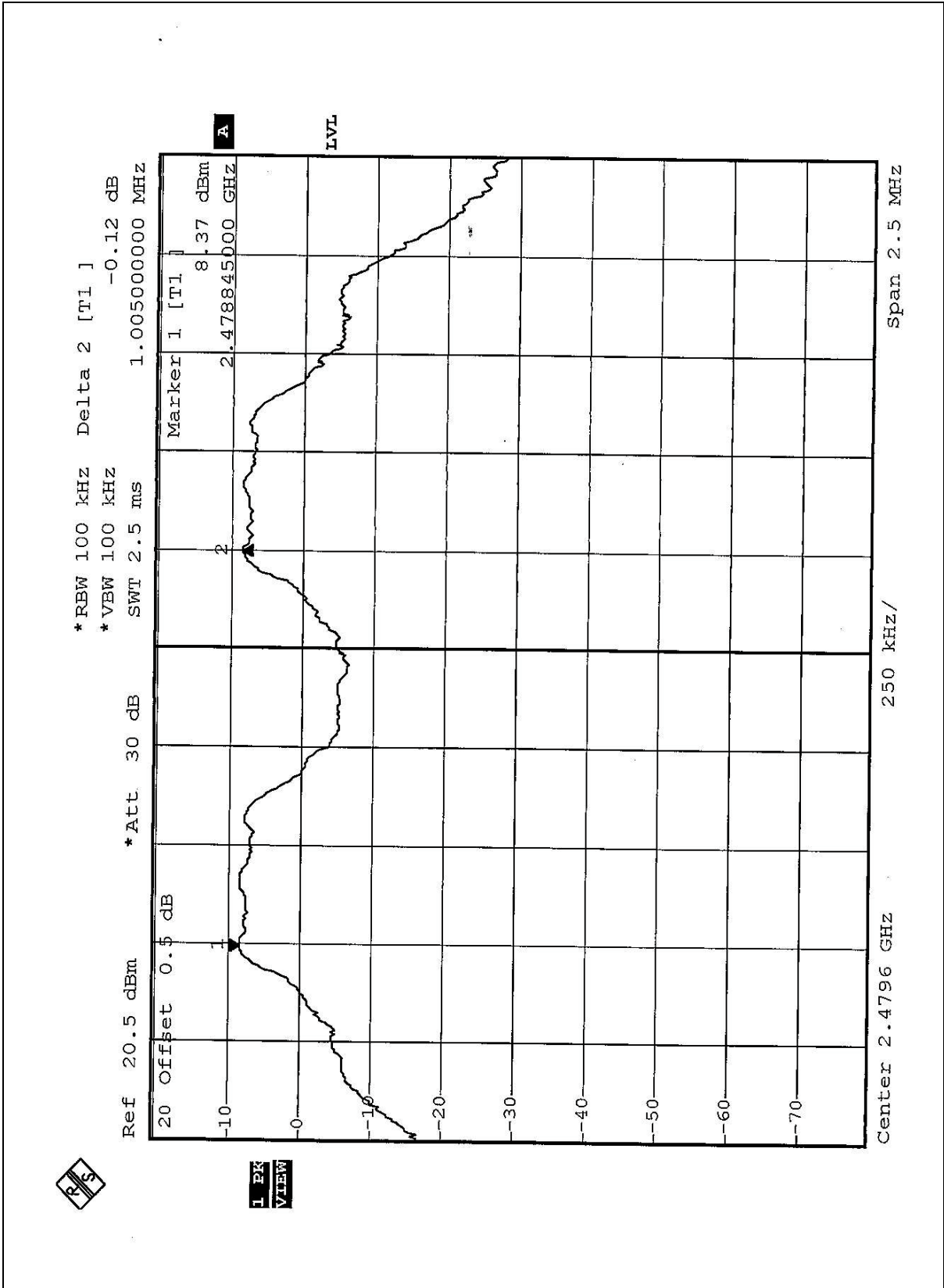



## 4.6 MAXIMUM PEAK OUTPUT POWER

### 4.6.1 LIMITS OF MAXIMUM PEAK OUTPUT POWER MEASUREMENT

The Maximum Peak Output Power Measurement is 30dBm.

### 4.6.2 INSTRUMENTS

Description & Manufacturer	Model No.	Serial No.	Calibrated Until
SPECTRUM ANALYZER	FSEK30	100049	Aug. 12, 2004

**NOTE:** The calibration interval of the above test instruments is 12 months and the calibrations are traceable to NML/ROC and NIST/USA.



#### 4.6.3 TEST PROCEDURES

1. Check the calibration of the measuring instrument using either an internal calibrator or a known signal from an external generator.
2. Turn on the EUT and connect it to measurement instrument. Then set it to any one convenient frequency within its operating range. Set a reference level on the measuring instrument equal to the highest peak value.
3. The center frequency of the spectrum analyzer is set to the fundamental frequency and using 1 MHz RBW and 3 MHz VBW.
4. Measure the frequency difference of two frequencies that were attenuated 20dB from the reference level. Record the frequency difference as the emission bandwidth.
5. Repeat above procedures until all frequencies measured were complete.

#### 4.6.4 DEVIATION FROM TEST STANDARD

No deviation

#### 4.6.5 TEST SETUP

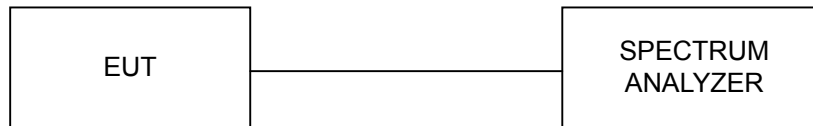

For the actual test configuration, please refer to the related Item – Photographs of the Test Configuration.

#### 4.6.6 EUT OPERATING CONDITION

The software provided by client enabled the EUT to transmit and receive data at lowest, middle and highest channel frequencies individually.

## 4.6.7 TEST RESULTS

<b>EUT</b>	Bluetooth Print Combo Adapter	<b>MODEL</b>	BT-0260
<b>ENVIRONMENTAL CONDITIONS</b>	28 deg. C, 70%RH, 991 hPa	<b>INPUT POWER (SYSTEM)</b>	120Vac, 60 Hz
<b>TESTED BY:</b> Allen Chang			

<b>CHANNEL</b>	<b>CHANNEL FREQUENCY (MHz)</b>	<b>PEAK POWER OUTPUT (dBm)</b>	<b>PEAK POWER LIMIT (dBm)</b>	<b>PASS/FAIL</b>
0	2402	8.44	30	PASS
39	2441	9.48	30	PASS
78	2480	8.77	30	PASS

### Channel 0

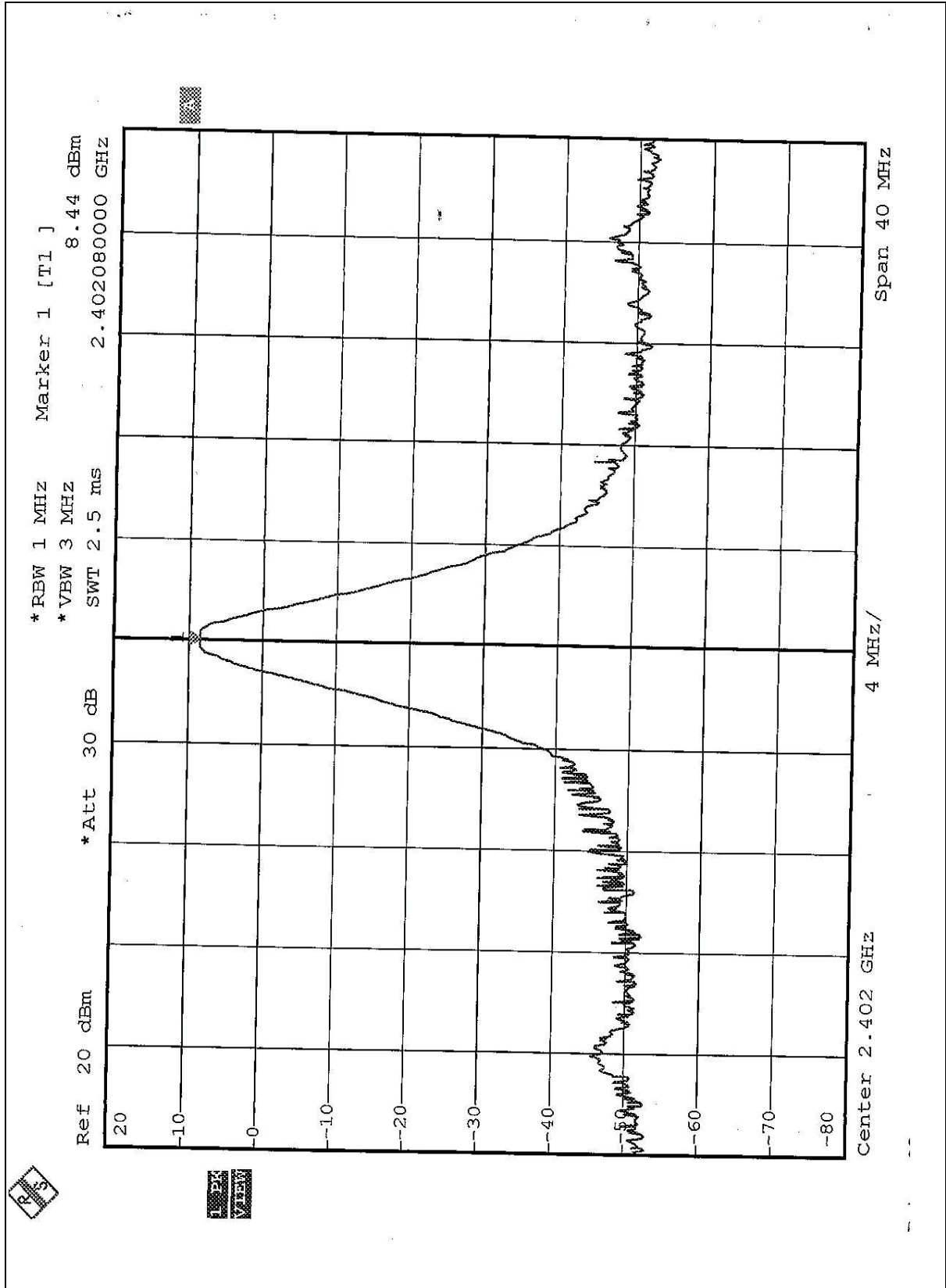



### Channel 39

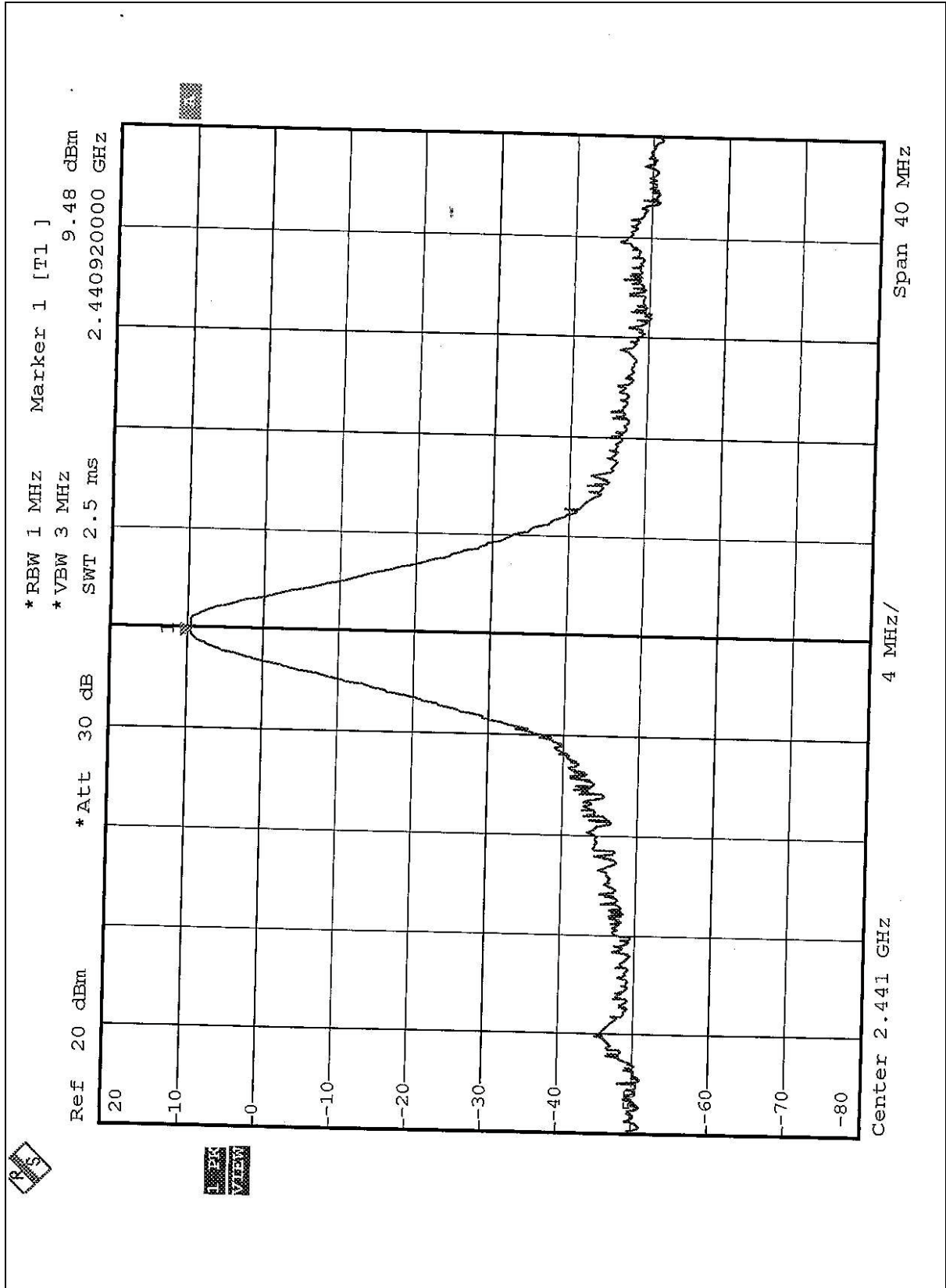

### Channel 78

