

ELECTROMAGNETIC EMISSIONS COMPLIANCE REPORT

INTENTIONAL RADIATOR CERTIFICATION TO FCC PART 15 SUBPART C REQUIREMENT

OF

Product Name: Bluetooth Module

Brand Name: CC&C

Model Name: BM-330R

Model Differences: N/A

FCC ID: PANBM330R

Report No.: ER/2006/40023-04

Issue Date: Jul. 13, 2007

FCC Rule Part: §15.247

Prepared for: CC&C Technologies, Inc.
8F, No. 150, Jian Yi Road, Chung Ho City,
Taipei County, Taiwan 235, R.O.C.

Prepared by: SGS Taiwan Ltd.
No. 134, Wu Kung Rd., Wuku Industrial
Zone, Taipei County, Taiwan.

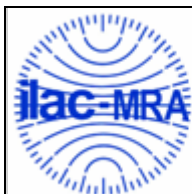

Note: This report shall not be reproduced except in full, without the written approval of SGS Taiwan Ltd. This document may be altered or revised by SGS Taiwan Ltd. personnel only, and shall be noted in the revision section of the document.

This Test Report is issued by the Company subject to its General Conditions of Service printed overleaf. Attention is drawn to the limitations of liability, indemnification, and Jurisdictional issued defined therein. The results shown in this test report refer only to the sample(s) tested unless otherwise stated. This test report cannot be reproduced, except in full, without prior written permission of the Company. Any unauthorized alteration, forgery or falsification of the content or appearance of this report is unlawful and offenders may be prosecuted to the fullest extent of the law. 此報告是遵循本公司訂定之通用服務條款所製作發放。請注意此條款列印於背面，將本公司之義務、免責、管轄權皆明確規範之。此報告結果除非另有說明僅對檢驗之樣品負責。本報告未經本公司書面許可，不可部份複製。對本報告內容或外觀之任何未經授權之變更、偽造、竄改皆屬非法，違犯者將會被依法追訴。

VERIFICATION OF COMPLIANCE

Applicant: CC&C Technologies, Inc.
 8F, No. 150, Jian Yi Road, Chung Ho City, Taipei County, Taiwan 235,
 R.O.C.

Equipment Under Test: Bluetooth Module

Brand Name: CC&C

FCC ID Number: PANBM330R

Model No.: BM-330R

Model Difference: N/A

File Number: ER/2006/40023-04

Date of test: May 16, 2006 ~ May 28, 2006; Jul. 13, 2007

Date of EUT Received: May 16, 2006; Jul. 12, 2007

We hereby certify that:

The above equipment was tested by SGS Taiwan Ltd. The test data, data evaluation, test procedures, and equipment configurations shown in this report were made in accordance with the procedures given in ANSI C63.4 (2003) and the energy emitted by the sample EUT tested as described in this report is in compliance with conducted and radiated emission limits of FCC Rules Part 15.247.

The test results of this report relate only to the tested sample identified in this report.

Test By:	<i>(original signature)</i>	Date	Jul. 13, 2007
	_____		_____
	<i>Danny Yeh/Engineer</i>		
Prepared By:	<i>(original signature)</i>	Date	Jul. 13, 2007
	_____		_____
	<i>Elisa Chen/Asst. Supervisor</i>		
Approved By:	<i>(original signature)</i>	Date	Jul. 13, 2007
	_____		_____
	<i>Vincent Su/Manager</i>		

This Test Report is issued by the Company subject to its General Conditions of Service printed overleaf. Attention is drawn to the limitations of liability, indemnification, and Jurisdictional issued defined therein. The results shown in this test report refer only to the sample(s) tested unless otherwise stated. This test report cannot be reproduced, except in full, without prior written permission of the Company. Any unauthorized alteration, forgery or falsification of the content or appearance of this report is unlawful and offenders may be prosecuted to the fullest extent of the law. 此報告是遵循本公司訂定之通用服務條款所製作發放。請注意此條款列印於背面，將本公司之義務，免責，管轄權皆明確規範之。此報告結果除非另有說明僅對檢驗之樣品負責。本報告未經本公司書面許可，不可部份複製。對本報告內容或外觀之任何未經授權之變更、偽造、竄改皆屬非法，違犯者將會被依法追訴。

Version

Version No.	Date
00	Jul. 13, 2007
01	Aug. 06, 2007

This Test Report is issued by the Company subject to its General Conditions of Service printed overleaf. Attention is drawn to the limitations of liability, indemnification, and Jurisdictional issued defined therein. The results shown in this test report refer only to the sample(s) tested unless otherwise stated. This test report cannot be reproduced, except in full, without prior written permission of the Company. Any unauthorized alteration, forgery or falsification of the content or appearance of this report is unlawful and offenders may be prosecuted to the fullest extent of the law. 此報告是遵循本公司訂定之通用服務條款所製作發放。請注意此條款列印於背面，將本公司之義務，免責，管轄權皆明確規範之。此報告結果除非另有說明僅對檢驗之樣品負責。本報告未經本公司書面許可，不可部份複製。對本報告內容或外觀之任何未經授權之變更、偽造、竄改皆屬非法，違犯者將會被依法追訴。

Table of Contents

1. GENERAL INFORMATION	7
1.1. Product Description	7
1.2. Related Submittal(s) / Grant (s)	7
1.3. Test Methodology	7
1.4. Test Facility	7
1.5. Special Accessories	7
1.6. Equipment Modifications	7
2. SYSTEM TEST CONFIGURATION	8
2.1. EUT Configuration	8
2.2. EUT Exercise	8
2.3. Test Procedure	8
2.4. Configuration of Tested System	9
3. SUMMARY OF TEST RESULTS	10
4. DESCRIPTION OF TEST MODES	10
5. CONDUCTED EMISSION TEST	11
5.1. Standard Applicable	11
5.2. EUT Setup	11
5.3. Measurement Procedure	11
5.4. Measurement Equipment Used:	12
5.5. Measurement Result	12
6. PEAK OUTPUT POWER MEASUREMENT	16
6.1. Standard Applicable	16
6.2. Measurement Procedure	16
6.3. Measurement Result	16
6.4. Measurement Equipment Used:	16
7. 20dB BAND WIDTH	19
7.1. Standard Applicable	19
7.2. Measurement Procedure	19
7.3. Measurement Result	19
7.4. Measurement Equipment Used:	19

This Test Report is issued by the Company subject to its General Conditions of Service printed overleaf. Attention is drawn to the limitations of liability, indemnification, and Jurisdictional issued defined therein. The results shown in this test report refer only to the sample(s) tested unless otherwise stated. This test report cannot be reproduced, except in full, without prior written permission of the Company. Any unauthorized alteration, forgery or falsification of the content or appearance of this report is unlawful and offenders may be prosecuted to the fullest extent of the law. 此報告是遵循本公司訂定之通用服務條款所製作發放。請注意此條款列印於背面，將本公司之義務，免責，管轄權皆明確規範之。此報告結果除非另有說明僅對檢驗之樣品負責。本報告未經本公司書面許可，不可部份複製。對本報告內容或外觀之任何未經授權之變更、偽造、竄改皆屬非法，違犯者將會被依法追訴。

8.	100KHz BANDWIDTH OF BAND EDGES MEASUREMENT.....	22
8.1.	Standard Applicable	22
8.2.	Measurement Procedure.....	22
8.3.	Measurement Result.....	22
8.4.	Measurement Equipment Used:	22
9.	SPURIOUS RADIATED EMISSION TEST.....	26
9.1.	Standard Applicable	26
9.2.	EUT Setup.....	26
9.3.	Measurement Procedure.....	26
9.4.	Test SET-UP (Block Diagram of Configuration).....	27
9.5.	Measurement Equipment Used:	28
9.6.	Field Strength Calculation	28
9.7.	Measurement Result.....	28
10.	FREQUENCY SEPARATION	41
10.1.	Standard Applicable	41
10.2.	Measurement Procedure.....	41
10.3.	Measurement Result.....	41
10.4.	Measurement Equipment Used:	41
11.	NUMBER OF HOPPING FREQUENCY	43
11.1.	Standard Applicable	43
11.2.	Measurement Procedure.....	43
11.3.	Measurement Result.....	43
11.4.	Measurement Equipment Used:	43
12.	TIME OF OCCUPANCY (DWELL TIME)	45
12.1.	Standard Applicable	45
12.2.	Measurement Procedure.....	45
12.3.	Measurement Result.....	45
12.4.	Measurement Equipment Used:	46
13.	Peak Power Spectral Density	52
13.1.	Standard Applicable	52
13.2.	Measurement Procedure.....	52
13.3.	Measurement Result.....	52
13.4.	Measurement Equipment Used:	52

This Test Report is issued by the Company subject to its General Conditions of Service printed overleaf. Attention is drawn to the limitations of liability, indemnification, and Jurisdictional issued defined therein. The results shown in this test report refer only to the sample(s) tested unless otherwise stated. This test report cannot be reproduced, except in full, without prior written permission of the Company. Any unauthorized alteration, forgery or falsification of the content or appearance of this report is unlawful and offenders may be prosecuted to the fullest extent of the law. 此報告是遵循本公司訂定之通用服務條款所製作發放。請注意此條款列印於背面，將本公司之義務，免責，管轄權皆明確規範之。此報告結果除非另有說明僅對檢驗之樣品負責。本報告未經本公司書面許可，不可部份複製。對本報告內容或外觀之任何未經授權之變更、偽造、竄改皆屬非法，違犯者將會被依法追訴。

14. ANTENNA REQUIREMENT55

14.1. Standard Applicable55

14.2. Antenna Connected Construction55

This Test Report is issued by the Company subject to its General Conditions of Service printed overleaf. Attention is drawn to the limitations of liability, indemnification, and Jurisdictional issued defined therein. The results shown in this test report refer only to the sample(s) tested unless otherwise stated. This test report cannot be reproduced, except in full, without prior written permission of the Company. Any unauthorized alteration, forgery or falsification of the content or appearance of this report is unlawful and offenders may be prosecuted to the fullest extent of the law. 此報告是遵循本公司訂定之通用服務條款所製作發放。請注意此條款列印於背面，將本公司之義務，免責，管轄權皆明確規範之。此報告結果除非另有說明僅對檢驗之樣品負責。本報告未經本公司書面許可，不可部份複製。對本報告內容或外觀之任何未經授權之變更、偽造、竄改皆屬非法，違犯者將會被依法追訴。

1. GENERAL INFORMATION

1.1. Product Description

The CC&C Technologies, Inc., Model: BM-330R is a Bluetooth Module.

The EUT is compliance with Bluetooth Standard.

A major technical descriptions of EUT is described as following:

- A). Operation Frequency: 2402 – 2480Hz, 79 channels
- B). Rated output power: 0.96 dBm
- C). Modulation type: Frequency Hopping Spread Spectrum (FHSS), GFSK, /4-DPSK, 8DPSK
- D). Antenna Designation: Micro-strip Antenna, -0.93dBi, Non-User Replaceable (Fixed)
- E). Power Supply: 5Vdc from USB port

1.2. Related Submittal(s) / Grant (s)

This submittal(s) (test report) is intended for **FCC ID: PANBM330R** filing to comply with Section 15.247 of the FCC Part 15, Subpart C Rules. The composite system (digital device) is compliance with Subpart B is authorized under a DoC procedure.

1.3. Test Methodology

Both conducted and radiated testing were performed according to the procedures in ANSI C63.4 (2003). Radiated testing was performed at an antenna to EUT distance 3 meters.

1.4. Test Facility

The open area test site and conducted measurement facility used to collect the radiated data is located on the address of SGS Taiwan Ltd. No. 134, Wu Kung Rd., Wuku Industrial Zone, Taipei Country, Taiwan. The Open Area Test Sites and the Line Conducted labs are constructed and calibrated to meet the FCC requirements in documents ANSI C63.4: 2003 and CISPR 22/EN 55022 requirements. Site No. 1(3 &10 meters) Registration Number: 23194, Both OATS and Anechoic chamber (3 meters) was accredited by TAF (0513). Canada Registration Number: 4620A-1.

1.5. Special Accessories

Not available for this EUT intended for grant.

1.6. Equipment Modifications

Not available for this EUT intended for grant.

This Test Report is issued by the Company subject to its General Conditions of Service printed overleaf. Attention is drawn to the limitations of liability, indemnification, and Jurisdictional issued defined therein. The results shown in this test report refer only to the sample(s) tested unless otherwise stated. This test report cannot be reproduced, except in full, without prior written permission of the Company. Any unauthorized alteration, forgery or falsification of the content or appearance of this report is unlawful and offenders may be prosecuted to the fullest extent of the law. 此報告是遵循本公司訂定之通用服務條款所製作發放。請注意此條款列印於背面，將本公司之義務，免責，管轄權皆明確規範之。此報告結果除非另有說明僅對檢驗之樣品負責。本報告未經本公司書面許可，不可部份複製。對本報告內容或外觀之任何未經授權之變更、偽造、竄改皆屬非法，違犯者將會被依法追訴。

2. SYSTEM TEST CONFIGURATION

2.1. EUT Configuration

The EUT configuration for testing is installed on RF field strength measurement to meet the Commissions requirement and operating in a manner which intends to maximize its emission characteristics in a continuous normal application.

2.2. EUT Exercise

The EUT (Transmitter) was operated in the engineering mode to fix the Tx frequency that was for the purpose of the measurements.

2.3. Test Procedure

2.3.1 Conducted Emissions

The EUT is a placed on as turn table which is 0.8 m above ground plane. According to the requirements in Section 7 and 13 of ANSI C63.4-2003. Conducted emissions from the EUT measured in the frequency range between 0.15 MHz and 30MHz using CISPR Quasi-Peak and Average detector mode.

2.3.2 Radiated Emissions

The EUT is a placed on as turn table which is 0.8 m above ground plane. The turn table shall rotate 360 degrees to determine the position of maximum emission level. EUT is set 3m away from the receiving antenna which varied from 1m to 4m to find out the highest emission. And also, each emission was to be maximized by changing the polarization of receiving antenna both horizontal and vertical. In order to find out the max. emission, the relative positions of this hand-held transmitter(EUT) was rotated through three orthogonal axes according to the requirements in Section 8 and 13 of ANSI C63.4-2003.

2.4. Configuration of Tested System

Fig. 2-1 Configuration of Tested System

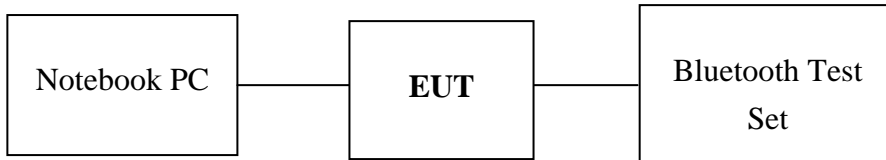

Fig. 2-2 Configuration of AC Power Line Conducted Emission

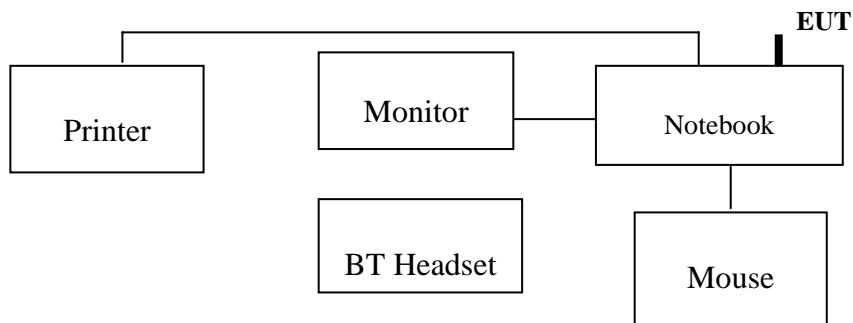

Table 2-1 Equipment Used in Tested System

Item	Equipment	Mfr/Brand	Model/Type No.	Series No.	Data Cable	Power Cord
1.	Notebook	Compaq	Presarlo 2100	CNF345Q1R	Shielding	Un-shielding
2.	Bluetooth Test Set	Anritsu	8852B	6K00004318	N/A	N/A
3.	BT Headset	Hahntek	BES-777	N/A	N/A	N/A
4.	Test Software	CSR	BlueSuite 1.22	Version1.22	N/A	N/A
5.	Monitor	HP	Vf51	TWTFG01092	Un-shielding	Un-shielding
6.	Mouse	HP	P8131-D	K023302209	Un-shielding	Un-shielding
7.	Printer	HP	DJ640C	TH12QE110Y	Un-shielding	Un-shielding

This Test Report is issued by the Company subject to its General Conditions of Service printed overleaf. Attention is drawn to the limitations of liability, indemnification, and Jurisdictional issued defined therein. The results shown in this test report refer only to the sample(s) tested unless otherwise stated. This test report cannot be reproduced, except in full, without prior written permission of the Company. Any unauthorized alteration, forgery or falsification of the content or appearance of this report is unlawful and offenders may be prosecuted to the fullest extent of the law. 此報告是遵循本公司訂定之通用服務條款所製作發放。請注意此條款列印於背面，將本公司之義務，免責，管轄權皆明確規範之。此報告結果除非另有說明僅對檢驗之樣品負責。本報告未經本公司書面許可，不可部份複製。對本報告內容或外觀之任何未經授權之變更、偽造、竄改皆屬非法，違犯者將會被依法追訴。

3. SUMMARY OF TEST RESULTS

FCC Rules	Description Of Test	Result
§15.207(a)	Conducted Emission	Compliant
§15.247(b)(1)	Peak Output Power	Compliant
§15.247(a)	20dB Bandwidth	Compliant
§15.247(c)	100 KHz Bandwidth Of Frequency Band Edges	Compliant
§15.209(a) (f)	Spurious Emission	Compliant
§15.247(a)(1)	Frequency Separation	Compliant
§15.247(a)(1)(iii)	Number of hopping frequency	Compliant
§15.247(a)(1)(iii)	Time of Occupancy	Compliant
§15.247	Peak Power Density	Compliant
§15.203, §15.247(b)(4)(i)	Antenna Requirement	Compliant

4. DESCRIPTION OF TEST MODES

The EUT has been tested under operating condition.

Test program used to control the EUT for staying in EDR continuous transmitting and receiving mode is programmed.

Channel low (2402MHz) 、 mid (2441MHz) and high (2480MHz) with highest data rate are chosen for full testing.

5. CONDUCTED EMISSION TEST

5.1. Standard Applicable

According to §15.207. frequency within 150KHz to 30MHz shall not exceed the limit table as below.

Frequency range MHz	Limits dB(uV)	
	Quasi-peak	Average
0.15 to 0.50	66 to 56	56 to 46
0.50 to 5	56	46
5 to 30	60	50

Note

- 1.The lower limit shall apply at the transition frequencies
- 2.The limit decreases linearly with the logarithm of the frequency in the range 0.15 MHz to 0.50 MHz.

5.2. EUT Setup

1. The conducted emission tests were performed in the test site, using the setup in accordance with the ANSI C63.4-2003.
2. The EUT was plug-in the AC/DC Power adapter. The host system was placed on the center of the back edge on the test table. The peripherals was placed on the side of the host PC system. The rear of the EUT and peripherals were placed flushed with the rear of the tabletop.
3. The spacing between the peripherals was 10 centimeters.
4. External I/O cables were draped along the edge of the test table and bundle when necessary.
5. The host system was connected with 110Vac/60Hz power source.

5.3. Measurement Procedure

1. The EUT was placed on a table which is 0.8m above ground plane.
2. Maximum procedure was performed on the six highest emissions to ensure EUT compliance.
3. Repeat above procedures until all frequency measured were complete.

This Test Report is issued by the Company subject to its General Conditions of Service printed overleaf. Attention is drawn to the limitations of liability, indemnification, and Jurisdictional issued defined therein. The results shown in this test report refer only to the sample(s) tested unless otherwise stated. This test report cannot be reproduced, except in full, without prior written permission of the Company. Any unauthorized alteration, forgery or falsification of the content or appearance of this report is unlawful and offenders may be prosecuted to the fullest extent of the law. 此報告是遵循本公司訂定之通用服務條款所製作發放。請注意此條款列印於背面，將本公司之義務，免責，管轄權皆明確規範之。此報告結果除非另有說明僅對檢驗之樣品負責。本報告未經本公司書面許可，不可部份複製。對本報告內容或外觀之任何未經授權之變更、偽造、竄改皆屬非法，違犯者將會被依法追訴。

5.4. Measurement Equipment Used:

Conducted Emission Test Site					
EQUIPMENT TYPE	MFR	MODEL NUMBER	SERIAL NUMBER	LAST CAL.	CAL DUE.
EMC Analyzer	HP	8594EM	3624A00203	09/02/2006	09/03/2007
EMI Test Receiver	R&S	ESCS30	828985/004	06/09/2007	06/10/2008
Transient Limiter	HP	11947A	3107A02062	09/02/2006	09/03/2007
LISN	Rolf-Heine	NNB-2/16Z	99012	12/31/2006	12/30/2007
LISN	Rolf-Heine	NNB-2/16Z	99013	12/24/2006	12/23/2007
Coaxial Cables	N/A	No. 3, 4	N/A	12/01/2006	12/01/2007

5.5. Measurement Result

The initial step in collecting conducted data is a spectrum analyzer peak scan of the measurement range. Significant peaks are then marked as shown on the following data page, and these signals are then quasi-peake.

AC POWER LINE CONDUCTED EMISSION TEST DATA

Operation Mode:	Operation Mode			Test Date:	May 18, 2006
Temperature:	24°C	Humidity:	56%	Test By:	Danny

FREQ MHz	Q.P. Raw dBuV	AVG Raw dBuV	Q.P. Limit dBuV	AVG Limit dBuV	Q.P. Margin dB	AVG Margin dB	NOTE
0.158	57.59	35.85	65.58	55.58	-7.99	-19.73	L1
0.177	51.42	34.59	64.61	54.61	-13.19	-20.02	L1
1.084	43.58	43.05	56.00	46.00	-12.42	-2.95	L1
1.283	44.04	42.23	56.00	46.00	-11.96	-3.77	L1
6.509	44.35	43.88	60.00	50.00	-15.65	-6.12	L1
17.506	46.86	41.49	60.00	50.00	-13.14	-8.51	L1
0.158	57.42	40.67	65.58	55.58	-8.16	-14.91	L2
0.177	51.22	36.67	64.61	54.61	-13.39	-17.94	L2
0.423	40.45	40.09	57.38	47.38	-16.93	-7.29	L2
7.201	44.34	37.09	60.00	50.00	-15.66	-12.91	L2
17.963	45.74	37.66	60.00	50.00	-14.26	-12.34	L2
20.259	41.63	33.63	60.00	50.00	-18.37	-16.37	L2

Remark :

- (1) Measuring frequencies from 0.15 MHz to 30MHz.
- (2) The emissions measured in frequency range from 0.15 MHz to 30MHz were made with an instrument using Qusia-Peak detector and Average detector.
- (3) “---” denotes the emission level was or more than 2dB below the Average limit, so no re-check anymore.
- (4) The IF bandwidth of SPA between 0.15MHz to 30MHz was 10KHz;
The IF bandwidth of Test Receiver between 0.15MHz to 30MHz was 9KHz;
- (5) L1 = Line One (Hot side) / L2 = Line Two (Neutral side)

This Test Report is issued by the Company subject to its General Conditions of Service printed overleaf. Attention is drawn to the limitations of liability, indemnification, and Jurisdictional issued defined therein. The results shown in this test report refer only to the sample(s) tested unless otherwise stated. This test report cannot be reproduced, except in full, without prior written permission of the Company. Any unauthorized alteration, forgery or falsification of the content or appearance of this report is unlawful and offenders may be prosecuted to the fullest extent of the law. 此報告是遵循本公司訂定之通用服務條款所製作發放。請注意此條款列印於背面，將本公司之義務，免責，管轄權皆明確規範之。此報告結果除非另有說明僅對檢驗之樣品負責。本報告未經本公司書面許可，不可部份複製。對本報告內容或外觀之任何未經授權之變更、偽造、竄改皆屬非法，違犯者將會被依法追訴。

Conducted Emission Test Plot

Conducted Emission Measurement

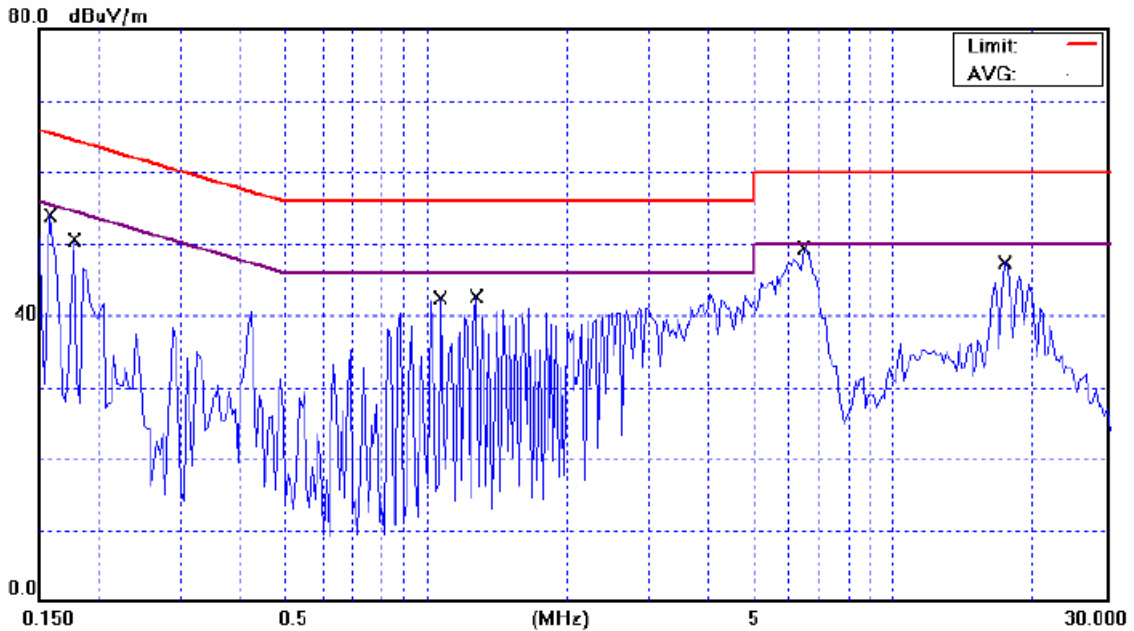

Site	SGS CONDUCTED #1	Phase:	L1	Temperature:	24 °C
Limit:	EN55022 Class B Conduction(QP)	Power:	AC110V/60HZ	Humidity:	56 %
EUT:		Distance:		Air Pressure:	hpa
M/N:					
Note:	Operation & Charge mode				

No.	Mk.	Freq. MHz	Reading Level dBuV/m	Factor dB	Measure- ment dBuV/m	Limit dBuV/m	Over dB	Detector	Comment
1		0.1578	57.39	0.20	57.59	65.58	-7.99	QP	
2		0.1578	35.65	0.20	35.85	55.58	-19.73	AVG	
3		0.1773	51.22	0.20	51.42	64.61	-13.19	QP	
4		0.1773	34.39	0.20	34.59	54.61	-20.02	AVG	
5		1.0836	43.38	0.20	43.58	56.00	-12.42	QP	
6	*	1.0836	42.85	0.20	43.05	46.00	-2.95	AVG	
7		1.2828	43.84	0.20	44.04	56.00	-11.96	QP	
8		1.2828	42.03	0.20	42.23	46.00	-3.77	AVG	
9		6.5094	43.82	0.53	44.35	60.00	-15.65	QP	
10		6.5094	43.35	0.53	43.88	50.00	-6.12	AVG	
11		17.5055	46.16	0.70	46.86	60.00	-13.14	QP	
12		17.5055	40.79	0.70	41.49	50.00	-8.51	AVG	

This Test Report is issued by the Company subject to its General Conditions of Service printed overleaf. Attention is drawn to the limitations of liability, indemnification, and Jurisdictional issued defined therein. The results shown in this test report refer only to the sample(s) tested unless otherwise stated. This test report cannot be reproduced, except in full, without prior written permission of the Company. Any unauthorized alteration, forgery or falsification of the content or appearance of this report is unlawful and offenders may be prosecuted to the fullest extent of the law. 此報告是遵循本公司訂定之通用服務條款所製作發放。請注意此條款列印於背面，將本公司之義務，免責，管轄權皆明確規範之。此報告結果除非另有說明僅對檢驗之樣品負責。本報告未經本公司書面許可，不可部份複製。對本報告內容或外觀之任何未經授權之變更、偽造、竄改皆屬非法，違犯者將會被依法追訴。

Conducted Emission Measurement

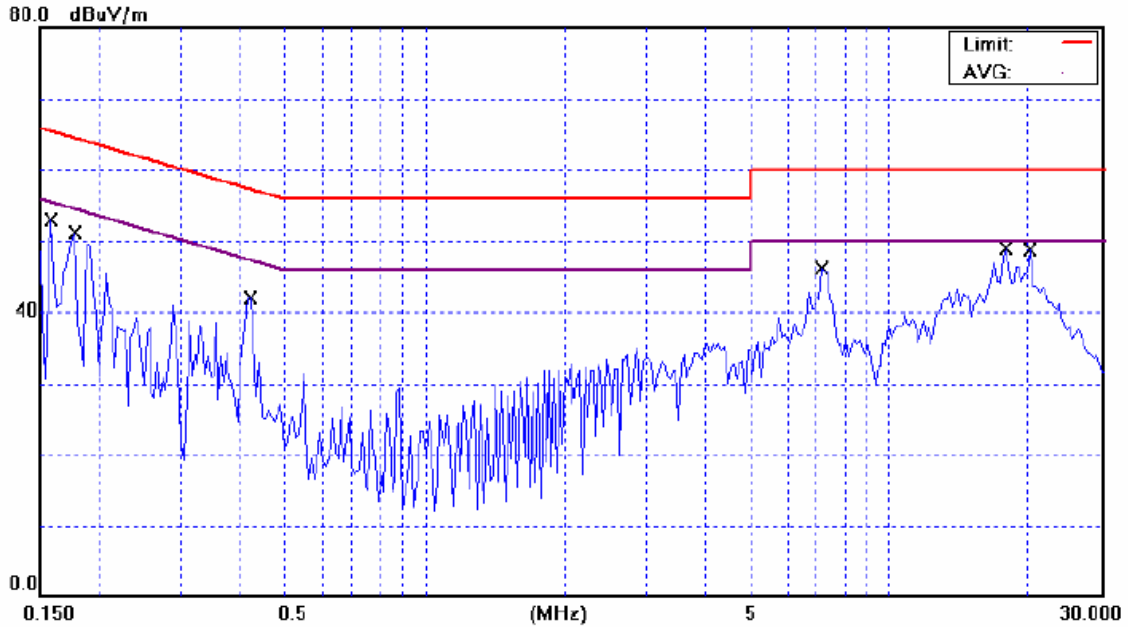

Site SGS CONDUCTED #1 Phase: **N** Temperature: 24 °C
 Limit: EN55022 Class B Conduction(QP) Power: AC110V/60HZ Humidity: 56 %
 EUT: Distance: Air Pressure: hpa
 M/N:
 Note: Operation & Charge mode

No.	Mk	Freq. MHz	Reading Level dBuV/m	Factor dB	Measure- ment dBuV/m	Limit dBuV/m	Over dB	Detector	Comment
1		0.1578	57.22	0.20	57.42	65.58	-8.16	QP	
2		0.1578	40.47	0.20	40.67	55.58	-14.91	AVG	
3		0.1773	51.02	0.20	51.22	64.61	-13.39	QP	
4		0.1773	36.47	0.20	36.67	54.61	-17.94	AVG	
5		0.4234	40.25	0.20	40.45	57.38	-16.93	QP	
6	*	0.4234	39.89	0.20	40.09	47.38	-7.29	AVG	
7		7.2008	43.78	0.56	44.34	60.00	-15.66	QP	
8		7.2008	36.53	0.56	37.09	50.00	-12.91	AVG	
9		17.9625	44.98	0.76	45.74	60.00	-14.26	QP	
10		17.9625	36.90	0.76	37.66	50.00	-12.34	AVG	
11		20.2594	40.82	0.81	41.63	60.00	-18.37	QP	
12		20.2594	32.82	0.81	33.63	50.00	-16.37	AVG	

This Test Report is issued by the Company subject to its General Conditions of Service printed overleaf. Attention is drawn to the limitations of liability, indemnification, and Jurisdictional issued defined therein. The results shown in this test report refer only to the sample(s) tested unless otherwise stated. This test report cannot be reproduced, except in full, without prior written permission of the Company. Any unauthorized alteration, forgery or falsification of the content or appearance of this report is unlawful and offenders may be prosecuted to the fullest extent of the law. 此報告是遵循本公司訂定之通用服務條款所製作發放。請注意此條款列印於背面，將本公司之義務，免責，管轄權皆明確規範之。此報告結果除非另有說明僅對檢驗之樣品負責。本報告未經本公司書面許可，不可部份複製。對本報告內容或外觀之任何未經授權之變更、偽造、竄改皆屬非法，違犯者將會被依法追訴。

6. PEAK OUTPUT POWER MEASUREMENT

6.1. Standard Applicable

For frequency hopping systems operating in the 2400-2483.5 MHz band employing at least 75 hopping channels, and all frequency hopping systems in the 5725-5850MHz band: 1Watt. For all other frequency hopping systems in the 2400 – 2483.5MHz band: 0.125 Watts.

6.2. Measurement Procedure

1. Place the EUT on the table and set it in transmitting mode.
2. Remove the antenna from the EUT and then connect a low loss RF cable from the antenna port to the power meter or spectrum. (Channel power function, RBW, VBW = 1MHz)
3. Record the max. reading.
4. Repeat above procedures until all frequency measured were complete.

6.3. Measurement Result

CH	Frequency (MHz)	Reading Power dBm	Cable Loss	Output Power dBm	Output Power W	Limit (W)
LOW	2402.0	-0.01	0.20	0.19	0.00104	1
MID	2441.0	-0.09	0.20	0.11	0.00103	1
HIGH	2480.0	0.76	0.20	0.96	0.00125	1

6.4. Measurement Equipment Used:

EQUIPMENT TYPE	MFR	MODEL NUMBER	SERIAL NUMBER	LAST CAL.	CAL DUE.
Spectrum Analyzer	R&S	FSP 40	100034	05/27/2007	05/26/2008
Spectrum Analyzer	Agilent	E7405A	US41160416	08/27/2006	08/27/2007
Spectrum Analyzer	Agilent	E4446A	MY43360126	01/22/2007	01/21/2008
Low Loss Cable	HUBER+SUHNER	SUCOFLEX 104PEA	N/A	N/A	N/A
Attenuator	Mini-Circuit	BW-S6W5	N/A	10/07/2006	10/06/2007

This Test Report is issued by the Company subject to its General Conditions of Service printed overleaf. Attention is drawn to the limitations of liability, indemnification, and Jurisdictional issued defined therein. The results shown in this test report refer only to the sample(s) tested unless otherwise stated. This test report cannot be reproduced, except in full, without prior written permission of the Company. Any unauthorized alteration, forgery or falsification of the content or appearance of this report is unlawful and offenders may be prosecuted to the fullest extent of the law. 此報告是遵循本公司訂定之通用服務條款所製作發放。請注意此條款列印於背面，將本公司之義務，免責，管轄權皆明確規範之。此報告結果除非另有說明僅對檢驗之樣品負責。本報告未經本公司書面許可，不可部份複製。對本報告內容或外觀之任何未經授權之變更、偽造、竄改皆屬非法，違犯者將會被依法追訴。

Peak Power Output Data Plot (CH Low)

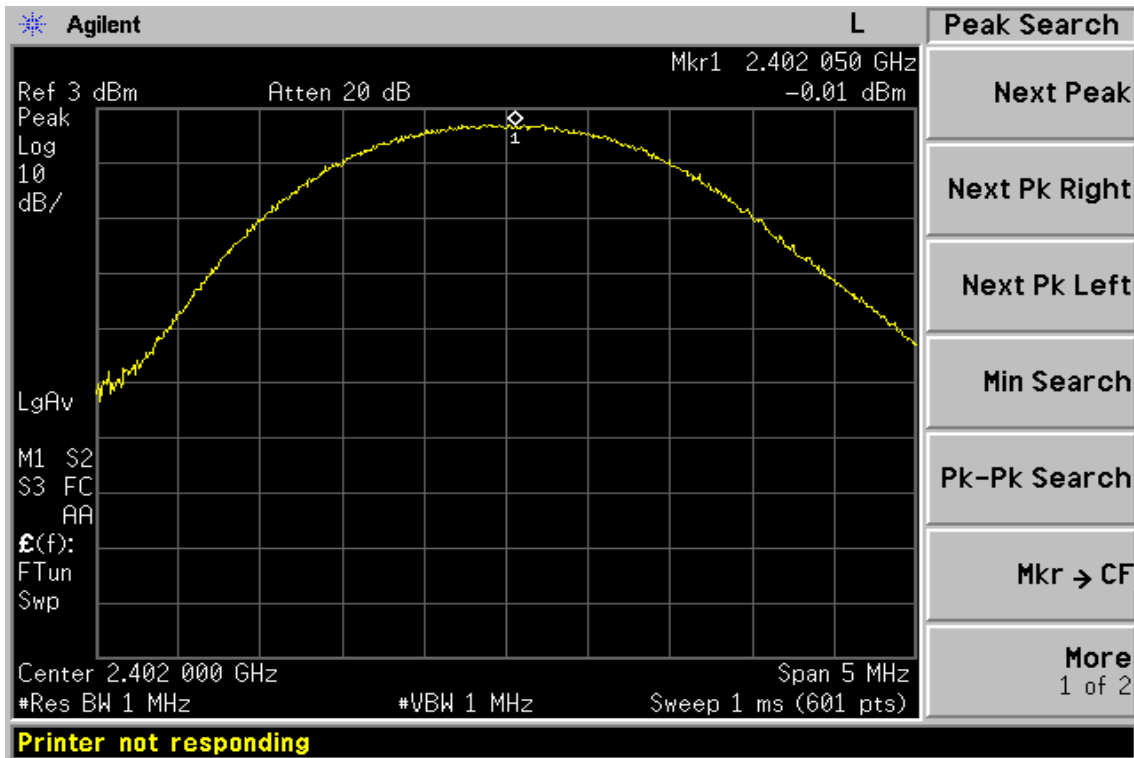

Peak Power Output Data Plot (CH Mid)

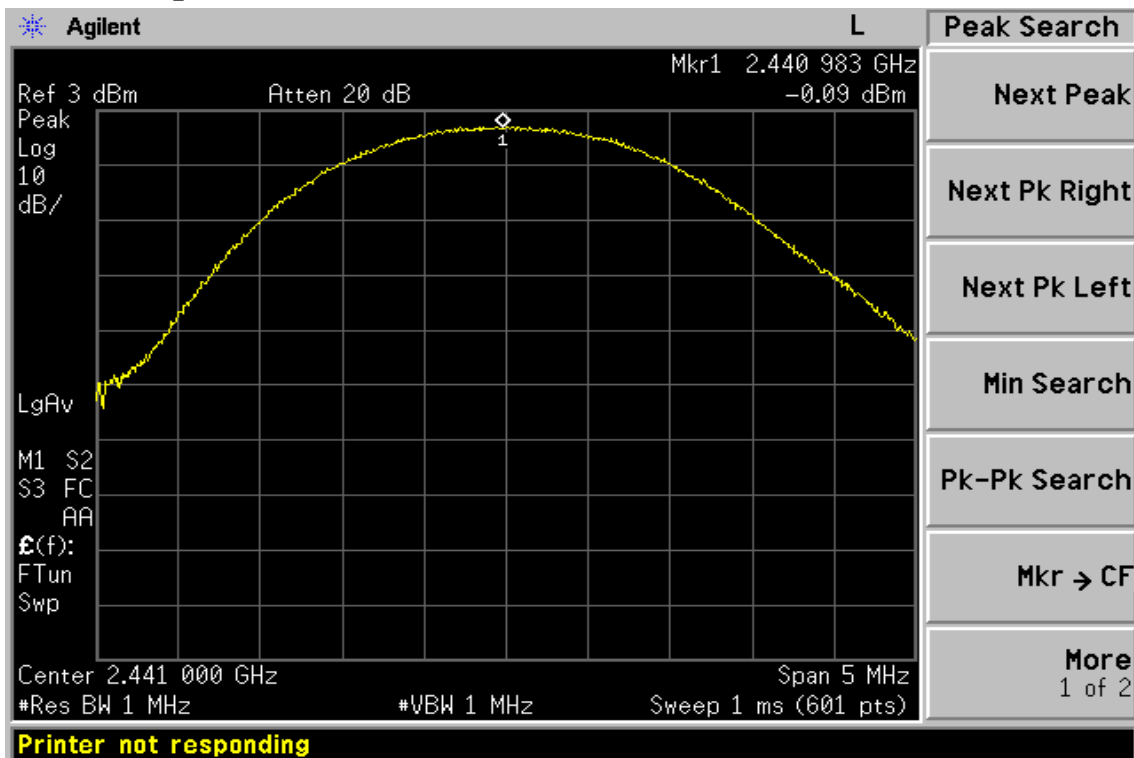

This Test Report is issued by the Company subject to its General Conditions of Service printed overleaf. Attention is drawn to the limitations of liability, indemnification, and Jurisdictional issued defined therein. The results shown in this test report refer only to the sample(s) tested unless otherwise stated. This test report cannot be reproduced, except in full, without prior written permission of the Company. Any unauthorized alteration, forgery or falsification of the content or appearance of this report is unlawful and offenders may be prosecuted to the fullest extent of the law. 此報告是遵循本公司訂定之通用服務條款所製作發放。請注意此條款列印於背面，將本公司之義務，免責，管轄權皆明確規範之。此報告結果除非另有說明僅對檢驗之樣品負責。本報告未經本公司書面許可，不可部份複製。對本報告內容或外觀之任何未經授權之變更、偽造、竄改皆屬非法，違犯者將會被依法追訴。

Peak Power Output Data Plot (CH High)

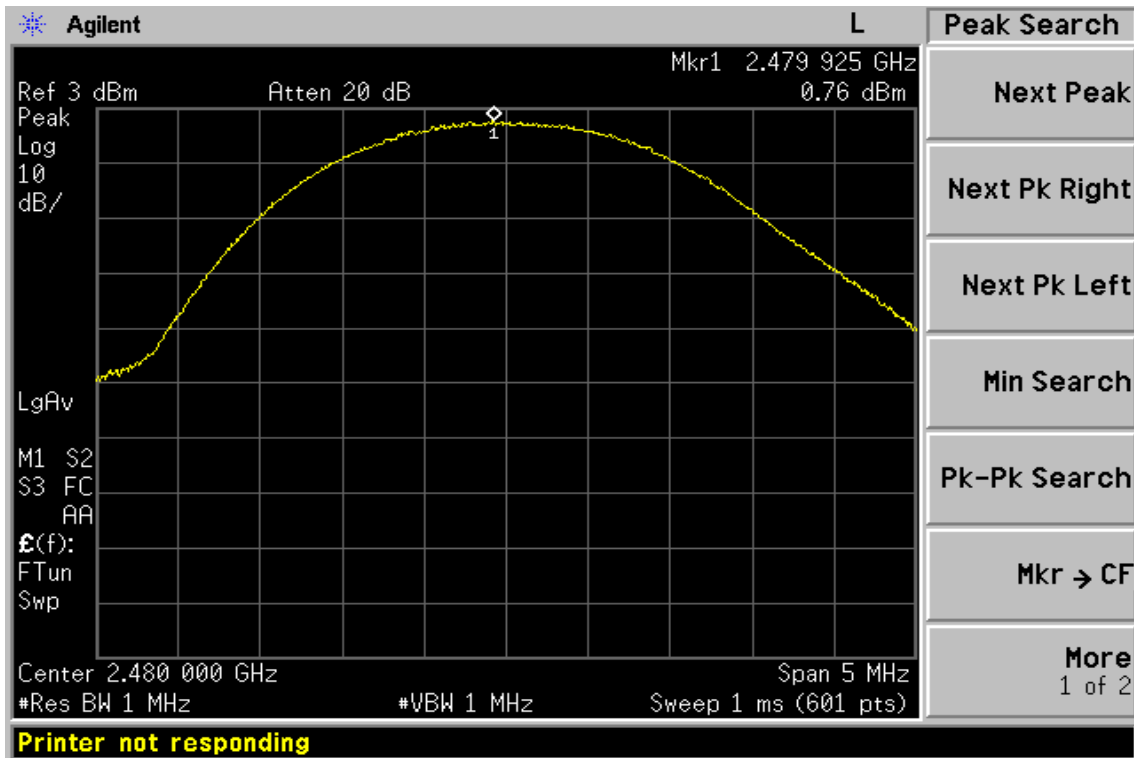

This Test Report is issued by the Company subject to its General Conditions of Service printed overleaf. Attention is drawn to the limitations of liability, indemnification, and Jurisdictional issued defined therein. The results shown in this test report refer only to the sample(s) tested unless otherwise stated. This test report cannot be reproduced, except in full, without prior written permission of the Company. Any unauthorized alteration, forgery or falsification of the content or appearance of this report is unlawful and offenders may be prosecuted to the fullest extent of the law. 此報告是遵循本公司訂定之通用服務條款所製作發放。請注意此條款列印於背面，將本公司之義務，免責，管轄權皆明確規範之。此報告結果除非另有說明僅對檢驗之樣品負責。本報告未經本公司書面許可，不可部份複製。對本報告內容或外觀之任何未經授權之變更、偽造、竄改皆屬非法，違犯者將會被依法追訴。

7. 20dB BAND WIDTH

7.1. Standard Applicable

For frequency hopping systems operating in the 2400MHz-2483.5 MHz no limit for 20dB bandwidth.

7.2. Measurement Procedure

1. Place the EUT on the table and set it in transmitting mode.
2. Remove the antenna from the EUT and then connect a low loss RF cable from the antenna port to the spectrum analyzer.
3. Set the spectrum analyzer as RBW=10KHz (1 % of Bandwidth.), Span= 3MHz, Sweep=auto
4. Mark the peak frequency and -20dB (upper and lower) frequency.
5. Repeat above procedures until all frequency measured were complete.

7.3. Measurement Result

CH	Bandwidth (MHz)	Bandwidth * 2/3 (MHz)
Lower	1.299	0.866
Mid	1.289	0.859
Higher	1.291	0.861

7.4. Measurement Equipment Used:

EQUIPMENT TYPE	MFR	MODEL NUMBER	SERIAL NUMBER	LAST CAL.	CAL DUE.
Spectrum Analyzer	R&S	FSP 40	100034	05/27/2007	05/26/2008
Spectrum Analyzer	Agilent	E7405A	US41160416	08/27/2006	08/27/2007
Spectrum Analyzer	Agilent	E4446A	MY43360126	01/22/2007	01/21/2008
Low Loss Cable	HUBER+SUHNER	SUCOFLEX 104PEA	N/A	N/A	N/A
Attenuator	Mini-Circuit	BW-S6W5	N/A	10/07/2006	10/06/2007

This Test Report is issued by the Company subject to its General Conditions of Service printed overleaf. Attention is drawn to the limitations of liability, indemnification, and Jurisdictional issued defined therein. The results shown in this test report refer only to the sample(s) tested unless otherwise stated. This test report cannot be reproduced, except in full, without prior written permission of the Company. Any unauthorized alteration, forgery or falsification of the content or appearance of this report is unlawful and offenders may be prosecuted to the fullest extent of the law. 此報告是遵循本公司訂定之通用服務條款所製作發放。請注意此條款列印於背面，將本公司之義務，免責，管轄權皆明確規範之。此報告結果除非另有說明僅對檢驗之樣品負責。本報告未經本公司書面許可，不可部份複製。對本報告內容或外觀之任何未經授權之變更、偽造、竄改皆屬非法，違犯者將會被依法追訴。

20dB Band Width Test Data CH-Low

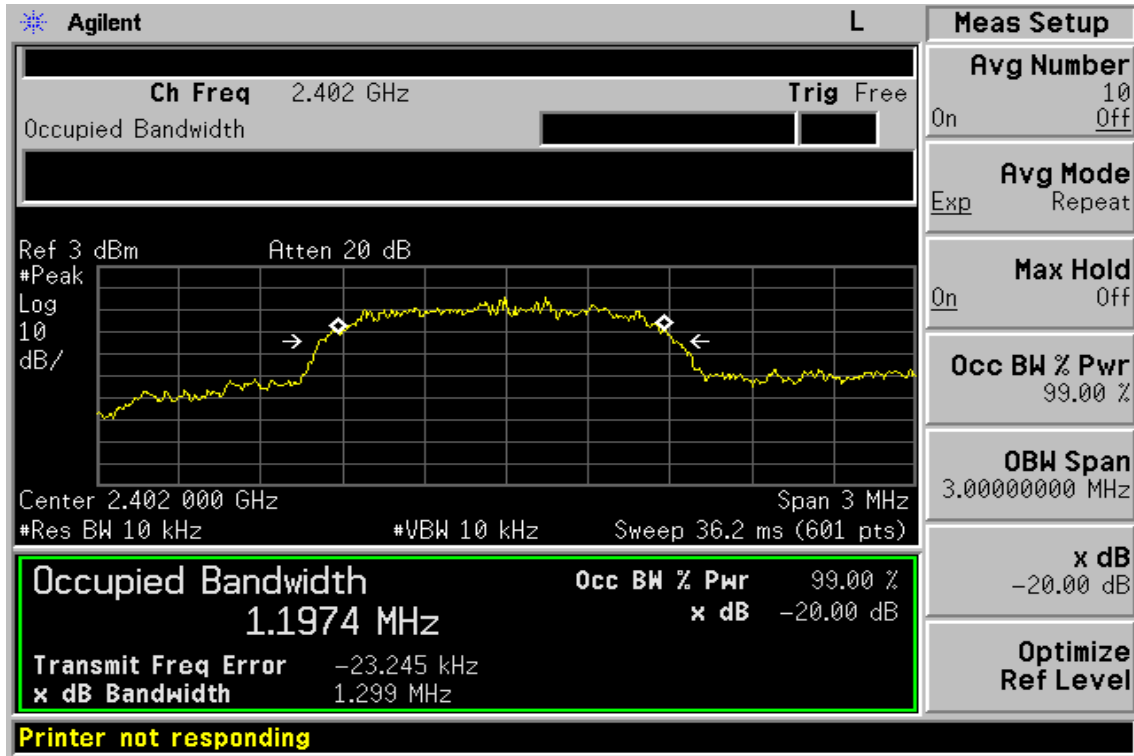

20dB Band Width Test Data CH-Mid

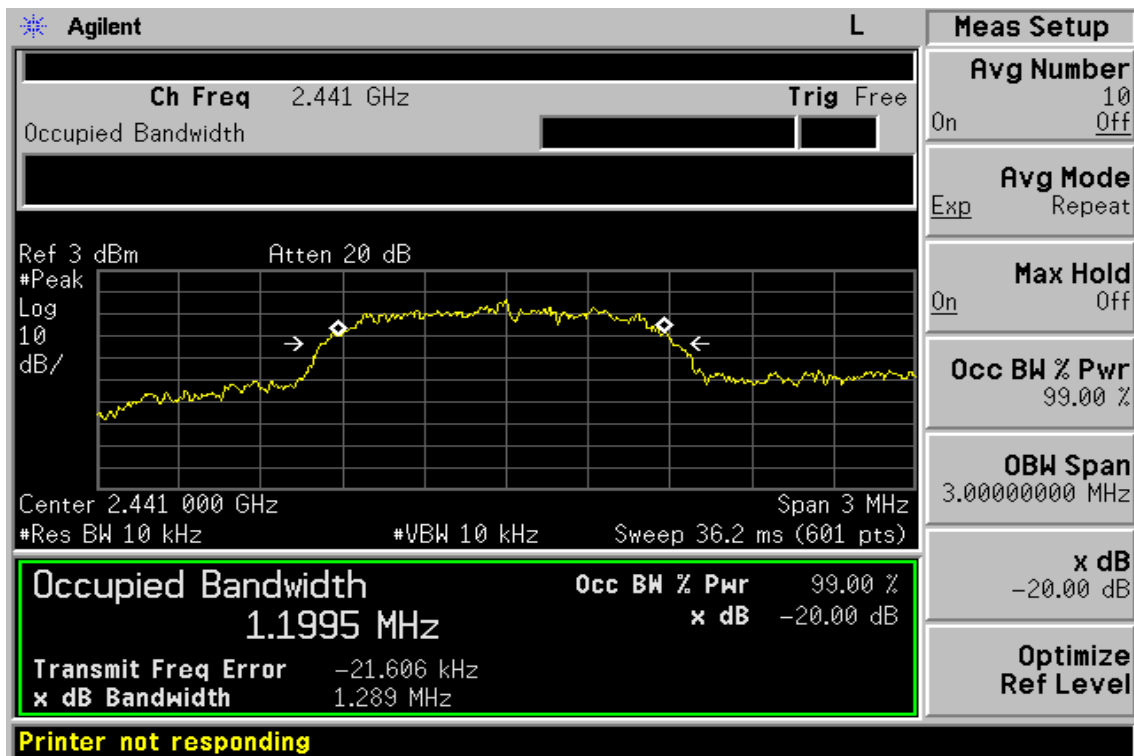

This Test Report is issued by the Company subject to its General Conditions of Service printed overleaf. Attention is drawn to the limitations of liability, indemnification, and Jurisdictional issued defined therein. The results shown in this test report refer only to the sample(s) tested unless otherwise stated. This test report cannot be reproduced, except in full, without prior written permission of the Company. Any unauthorized alteration, forgery or falsification of the content or appearance of this report is unlawful and offenders may be prosecuted to the fullest extent of the law. 此報告是遵循本公司訂定之通用服務條款所製作發放。請注意此條款列印於背面，將本公司之義務，免責，管轄權皆明確規範之。此報告結果除非另有說明僅對檢驗之樣品負責。本報告未經本公司書面許可，不可部份複製。對本報告內容或外觀之任何未經授權之變更、偽造、竄改皆屬非法，違犯者將會被依法追訴。

20dB Band Width Test Data CH-High

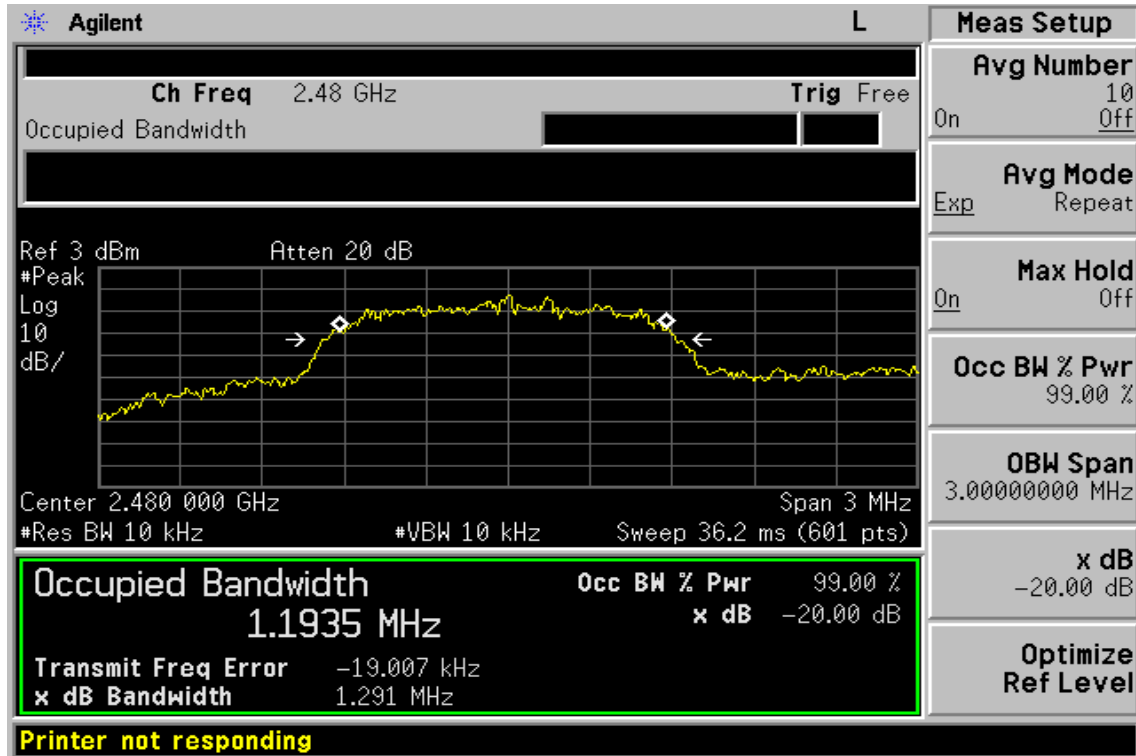

This Test Report is issued by the Company subject to its General Conditions of Service printed overleaf. Attention is drawn to the limitations of liability, indemnification, and Jurisdictional issued defined therein. The results shown in this test report refer only to the sample(s) tested unless otherwise stated. This test report cannot be reproduced, except in full, without prior written permission of the Company. Any unauthorized alteration, forgery or falsification of the content or appearance of this report is unlawful and offenders may be prosecuted to the fullest extent of the law. 此報告是遵循本公司訂定之通用服務條款所製作發放。請注意此條款列印於背面，將本公司之義務，免責，管轄權皆明確規範之。此報告結果除非另有說明僅對檢驗之樣品負責。本報告未經本公司書面許可，不可部份複製。對本報告內容或外觀之任何未經授權之變更、偽造、竄改皆屬非法，違犯者將會被依法追訴。

8. 100KHz BANDWIDTH OF BAND EDGES MEASUREMENT

8.1. Standard Applicable

According to §15.247(c), in any 100 KHz bandwidth outside the frequency bands in which the spread spectrum intentional radiator is operating, the radio frequency power that is produced by the intentional radiator shall be at least 20dB below that in the 100KHz bandwidth within the band that contains the highest level of the desired power, In addition, radiated emissions which fall in the restricted bands, as defined in §15.205(a), must also comply with the radiated emission limits specified in 15.209(a).

8.2. Measurement Procedure

1. Place the EUT on the table and set it in transmitting mode.
2. Remove the antenna from the EUT and then connect a low loss RF cable from the antenna port to the spectrum analyzer.
3. Set center frequency of spectrum analyzer = operating frequency.
4. Set the spectrum analyzer as RBW, VBW=100KHz, Span=25MHz, Sweep = auto
5. Mark Peak, 2.390GHz and 2.4835GHz and record the max. level.
6. Repeat above procedures until all frequency measured were complete.
7. Radiated Emission refer to section 9.

8.3. Measurement Result

Refer to attach spectrum analyzer data chart.

8.4. Measurement Equipment Used:

EQUIPMENT TYPE	MFR	MODEL NUMBER	SERIAL NUMBER	LAST CAL.	CAL DUE.
Spectrum Analyzer	R&S	FSP 40	100034	05/27/2007	05/26/2008
Spectrum Analyzer	Agilent	E7405A	US41160416	08/27/2006	08/26/2007
Spectrum Analyzer	Agilent	E4446A	MY43360126	01/22/2007	01/21/2008
Low Loss Cable	HUBER+SUHNER	SUCOFLEX 104PEA	N/A	N/A	N/A
Attenuator	Mini-Circuit	BW-S6W5	N/A	10/07/2006	10/06/2007

Note: Measurement Equipment for radiated emission refers to section 9.

Conducted Emission: Test Data CH-Low

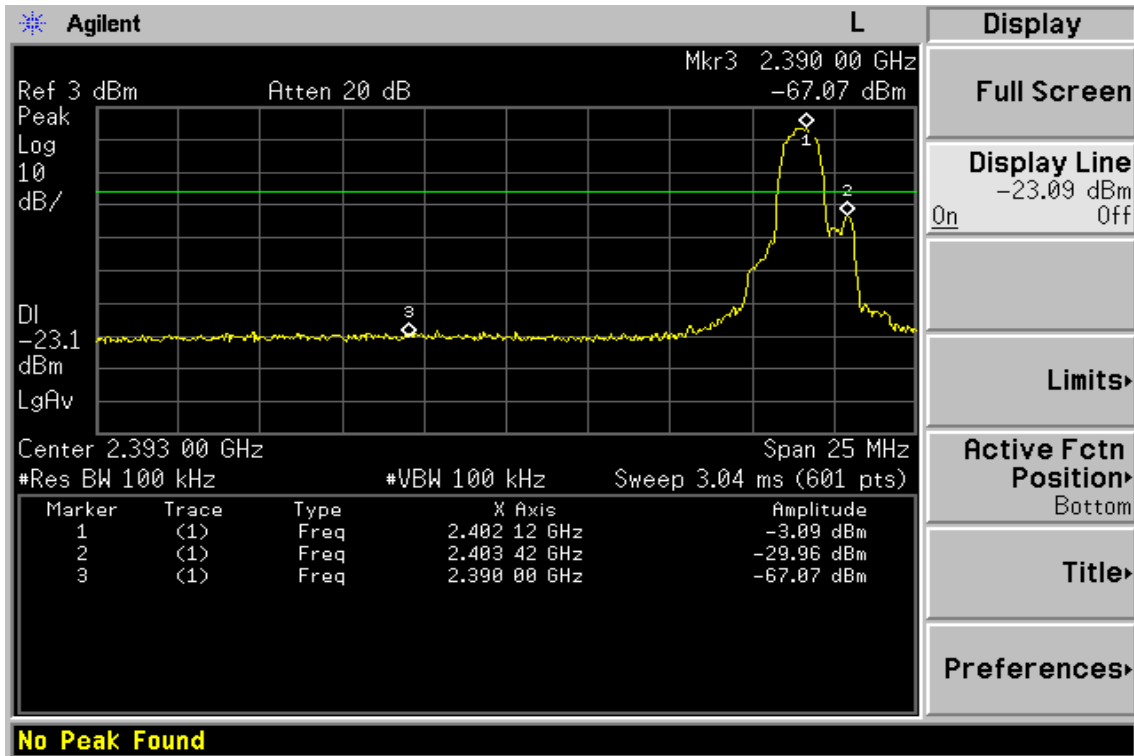

Conducted Emission: Test Data CH-High

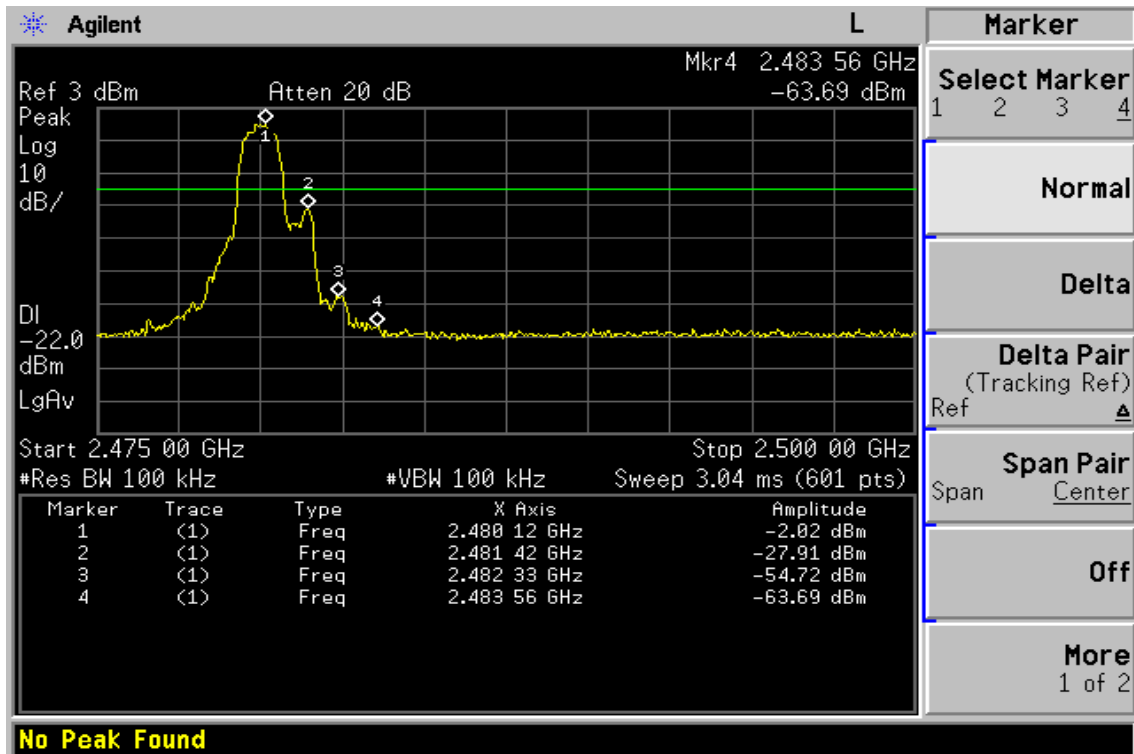

This Test Report is issued by the Company subject to its General Conditions of Service printed overleaf. Attention is drawn to the limitations of liability, indemnification, and Jurisdictional issued defined therein. The results shown in this test report refer only to the sample(s) tested unless otherwise stated. This test report cannot be reproduced, except in full, without prior written permission of the Company. Any unauthorized alteration, forgery or falsification of the content or appearance of this report is unlawful and offenders may be prosecuted to the fullest extent of the law. 此報告是遵循本公司訂定之通用服務條款所製作發放。請注意此條款列印於背面，將本公司之義務，免責，管轄權皆明確規範之。此報告結果除非另有說明僅對檢驗之樣品負責。本報告未經本公司書面許可，不可部份複製。對本報告內容或外觀之任何未經授權之變更、偽造、竄改皆屬非法，違犯者將會被依法追訴。

Radiated Emission:

Operation Mode	TX CH Low	Test Date	May 23, 2006
Fundamental Frequency	2402 MHz	Test By	Danny
Temperature	25 °C	Pol	Ver.
Humidity	65 %		

Freq. (MHz)	Peak	AV	Actual FS Ant./CL CF(dB)	Peak	AV	Peak Limit (dBuV/m)	AV	Margin (dB)	Remark
	Reading (dBuV)	Reading (dBuV)		Peak (dBuV/m)	AV (dBuV/m)		Limit (dBuV/m)		
2390.0	---					74.00	54.00		Peak

Operation Mode	TX CH Low	Test Date	May 23, 2006
Fundamental Frequency	2402 MHz	Test By	Danny
Temperature	25 °C	Pol	Hor.
Humidity	65 %		

Freq. (MHz)	Peak	AV	Actual FS Ant./CL CF(dB)	Peak	AV	Peak Limit (dBuV/m)	AV	Margin (dB)	Remark
	Reading (dBuV)	Reading (dBuV)		Peak (dBuV/m)	AV (dBuV/m)		Limit (dBuV/m)		
2390.0	---					74.00	54.00		Peak

Remark :

- (1) Datas of measurement within this frequency range shown “ - ” in the table above means the reading of emissions are attenuated more than 20dB below the permissible limits or the field strength is too small to be measured.
- (2) Radiated emissions measured in frequency above 1000MHz were made with an instrument using Peak detector mode and average detector mode of the emission shown in Actual FS column.
- (3) Spectrum Peak Setting : 1GHz- 26GHz, RBW= 1MHz, VBW= 3MHz, Sweep time= 200 ms.
- (4) Spectrum AV Setting : 1GHz- 26GHz, RBW= 1MHz, VBW= 10Hz, Sweep time= 200 ms.

This Test Report is issued by the Company subject to its General Conditions of Service printed overleaf. Attention is drawn to the limitations of liability, indemnification, and Jurisdictional issued defined therein. The results shown in this test report refer only to the sample(s) tested unless otherwise stated. This test report cannot be reproduced, except in full, without prior written permission of the Company. Any unauthorized alteration, forgery or falsification of the content or appearance of this report is unlawful and offenders may be prosecuted to the fullest extent of the law. 此報告是遵循本公司訂定之通用服務條款所製作發放。請注意此條款列印於背面，將本公司之義務，免責，管轄權皆明確規範之。此報告結果除非另有說明僅對檢驗之樣品負責。本報告未經本公司書面許可，不可部份複製。對本報告內容或外觀之任何未經授權之變更、偽造、竄改皆屬非法，違犯者將會被依法追訴。

Radiated Emission:

Operation Mode	TX CH High	Test Date	May 23, 2006
Fundamental Frequency	2480 MHz	Test By	Danny
Temperature	25 °C	Pol	Ver.
Humidity	65 %		

Freq. (MHz)	Peak	AV	Actual FS Ant./CL CF(dB)	Peak	AV	Peak Limit (dBuV/m)	AV	Margin (dB)	Remark
	Reading (dBuV)	Reading (dBuV)		Peak (dBuV/m)	AV (dBuV/m)		Limit (dBuV/m)		
2483.6	---	---	---	---	---	74.00	54.00	---	Peak

Operation Mode	TX CH High	Test Date	May 23, 2006
Fundamental Frequency	2480 MHz	Test By	Danny
Temperature	25 °C	Pol	Hor.
Humidity	65 %		

Freq. (MHz)	Peak	AV	Actual FS Ant./CL CF(dB)	Peak	AV	Peak Limit (dBuV/m)	AV	Margin (dB)	Remark
	Reading (dBuV)	Reading (dBuV)		Peak (dBuV/m)	AV (dBuV/m)		Limit (dBuV/m)		
2483.6	---	---	---	---	---	74.00	54.00	---	Peak

Remark :

- (1) Datas of measurement within this frequency range shown “ - ” in the table above means the reading of emissions are attenuated more than 20dB below the permissible limits or the field strength is too small to be measured.
- (2) Radiated emissions measured in frequency above 1000MHz were made with an instrument using Peak detector mode and average detector mode of the emission shown in Actual FS column.
- (3) Spectrum Peak Setting : 1GHz- 26GHz, RBW= 1MHz, VBW= 3MHz, Sweep time= 200 ms.
- (4) Spectrum AV Setting : 1GHz- 26GHz, RBW= 1MHz, VBW= 10Hz, Sweep time= 200 ms.

This Test Report is issued by the Company subject to its General Conditions of Service printed overleaf. Attention is drawn to the limitations of liability, indemnification, and Jurisdictional issued defined therein. The results shown in this test report refer only to the sample(s) tested unless otherwise stated. This test report cannot be reproduced, except in full, without prior written permission of the Company. Any unauthorized alteration, forgery or falsification of the content or appearance of this report is unlawful and offenders may be prosecuted to the fullest extent of the law. 此報告是遵循本公司訂定之通用服務條款所製作發放。請注意此條款列印於背面，將本公司之義務，免責，管轄權皆明確規範之。此報告結果除非另有說明僅對檢驗之樣品負責。本報告未經本公司書面許可，不可部份複製。對本報告內容或外觀之任何未經授權之變更、偽造、竄改皆屬非法，違犯者將會被依法追訴。

9. SPURIOUS RADIATED EMISSION TEST

9.1. Standard Applicable

According to §15.247(c), all other emissions outside these bands shall not exceed the general radiated emission limits specified in §15.209(a). And according to §15.33(a)(1), for an intentional radiator operates below 10GHz, the frequency range of measurements: to the tenth harmonic of the highest fundamental frequency or to 40GHz, whichever is lower.

9.2. EUT Setup

1. The radiated emission tests were performed in the 3 meter open-test site, using the setup in accordance with the ANSI C63.4-2003.
2. The EUT was put in the front of the test table. The peripherals was placed on the side of the host system. The rear of the EUT and peripherals were placed flushed with the rear of the tabletop.
3. The spacing between the peripherals was 10 centimeters.
4. External I/O cables were draped along the edge of the test table and bundle when necessary.
5. The host PC system was connected with 110Vac/60Hz power source.

9.3. Measurement Procedure

1. The EUT was placed on a turn table which is 0.8m above ground plane.
2. The turn table shall rotate 360 degrees to determine the position of maximum emission level.
3. EUT is set 3m away from the receiving antenna which varied from 1m to 4m to find out the highest emissions.
4. Maximum procedure was performed on the six highest emissions to ensure EUT compliance.
5. And also, each emission was to be maximized by changing the polarization of receiving antenna both horizontal and vertical.
6. Repeat above procedures until all frequency measured were complete.

This Test Report is issued by the Company subject to its General Conditions of Service printed overleaf. Attention is drawn to the limitations of liability, indemnification, and Jurisdictional issued defined therein. The results shown in this test report refer only to the sample(s) tested unless otherwise stated. This test report cannot be reproduced, except in full, without prior written permission of the Company. Any unauthorized alteration, forgery or falsification of the content or appearance of this report is unlawful and offenders may be prosecuted to the fullest extent of the law. 此報告是遵循本公司訂定之通用服務條款所製作發放。請注意此條款列印於背面，將本公司之義務，免責，管轄權皆明確規範之。此報告結果除非另有說明僅對檢驗之樣品負責。本報告未經本公司書面許可，不可部份複製。對本報告內容或外觀之任何未經授權之變更、偽造、竄改皆屬非法，違犯者將會被依法追訴。

9.4. Test SET-UP (Block Diagram of Configuration)

(A) Radiated Emission Test Set-Up, Frequency Below 1GHz

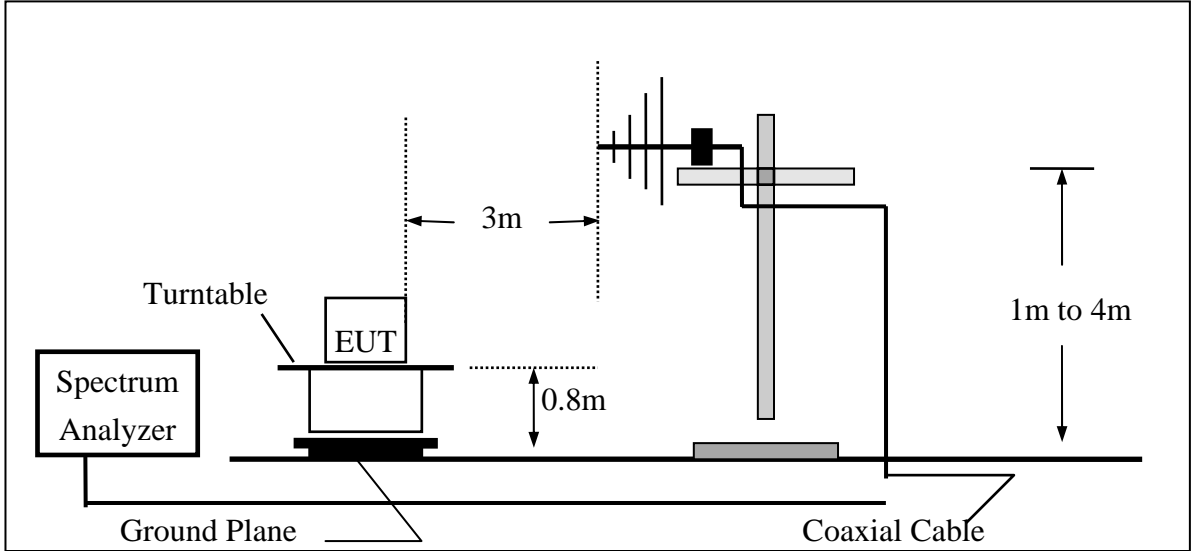

(B) Radiated Emission Test Set-UP Frequency Over 1 GHz

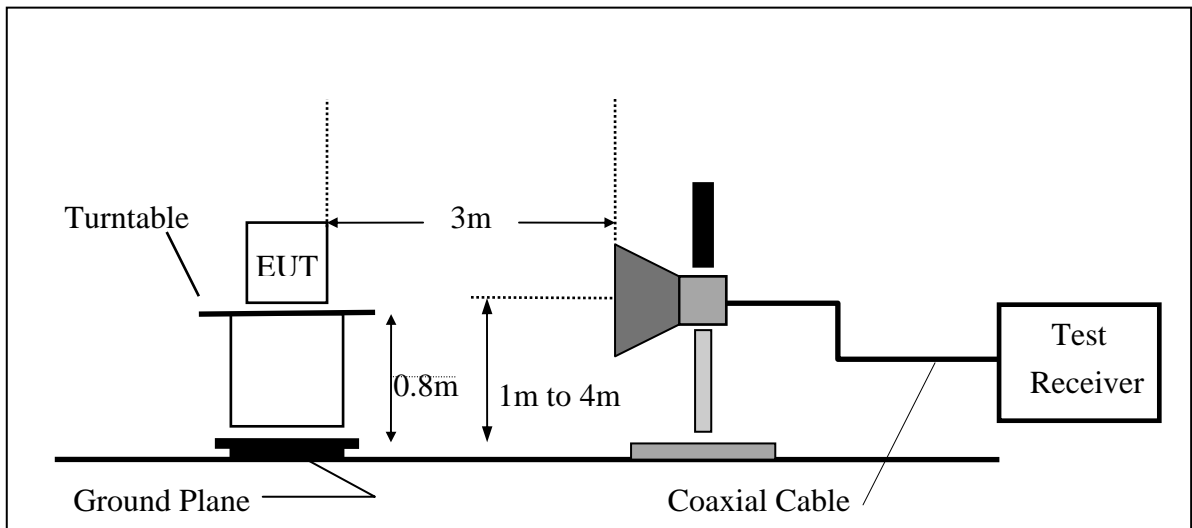

This Test Report is issued by the Company subject to its General Conditions of Service printed overleaf. Attention is drawn to the limitations of liability, indemnification, and Jurisdictional issued defined therein. The results shown in this test report refer only to the sample(s) tested unless otherwise stated. This test report cannot be reproduced, except in full, without prior written permission of the Company. Any unauthorized alteration, forgery or falsification of the content or appearance of this report is unlawful and offenders may be prosecuted to the fullest extent of the law. 此報告是遵循本公司訂定之通用服務條款所製作發放。請注意此條款列印於背面，將本公司之義務，免責，管轄權皆明確規範之。此報告結果除非另有說明僅對檢驗之樣品負責。本報告未經本公司書面許可，不可部份複製。對本報告內容或外觀之任何未經授權之變更、偽造、竄改皆屬非法，違犯者將會被依法追訴。

9.5. Measurement Equipment Used:

966 Chamber					
EQUIPMENT TYPE	MFR	MODEL NUMBER	SERIAL NUMBER	LAST CAL.	CAL DUE.
Spectrum Analyzer	R&S	FSP 40	100034	05/27/2007	05/26/2008
Spectrum Analyzer	Agilent	E7405A	US41160416	08/27/2006	08/26/2007
Bilog Antenna	SCHWAZBECK	VULB9163	152	06/03/2007	06/02/2008
Horn antenna	Schwarzbeck	BBHA 9120D	309/320	08/16/2006	08/15/2007
Horn antenna	Schwarzbeck	BBHA 9170	184/185	07/04/2007	07/03/2008
Pre-Amplifier	HP	8447D	2944A09469	07/19/2006	07/18/2007
Pre-Amplifier	HP	8494B	3008A00578	02/26/2007	02/25/2008
Turn Table	HD	DT420	N/A	N.C.R	N.C.R
Antenna Tower	HD	MA240-N	240/657	N.C.R	N.C.R
Controller	HD	HD100	N/A	N.C.R	N.C.R
Low Loss Cable	HUBER+SUHNER	SUCOFLEX 104PEA-10M	10m	10/09/2006	10/08/2007
Low Loss Cable	HUBER+SUHNER	SUCOFLEX 104PEA-3M	3m	10/09/2006	10/08/2007
Site NSA	SGS	966 chamber	N/A	11/17/2006	11/16/2007

9.6. Field Strength Calculation

The field strength is calculated by adding the Antenna Factor and Cable Factor and subtracting the Amplifier Gain and Duty Cycle Correction Factor(if any) from the measured reading. The basic equation with a sample calculation is as follows:

$$FS = RA + AF + CL - AG$$

Where	FS = Field Strength	CL = Cable Attenuation Factor (Cable Loss)
	RA = Reading Amplitude	AG = Amplifier Gain
	AF = Antenna Factor	

9.7. Measurement Result

Refer to attach tabular data sheets.

This Test Report is issued by the Company subject to its General Conditions of Service printed overleaf. Attention is drawn to the limitations of liability, indemnification, and Jurisdictional issued defined therein. The results shown in this test report refer only to the sample(s) tested unless otherwise stated. This test report cannot be reproduced, except in full, without prior written permission of the Company. Any unauthorized alteration, forgery or falsification of the content or appearance of this report is unlawful and offenders may be prosecuted to the fullest extent of the law. 此報告是遵循本公司訂定之通用服務條款所製作發放。請注意此條款列印於背面，將本公司之義務，免責，管轄權皆明確規範之。此報告結果除非另有說明僅對檢驗之樣品負責。本報告未經本公司書面許可，不可部份複製。對本報告內容或外觀之任何未經授權之變更、偽造、竄改皆屬非法，違犯者將會被依法追訴。

Conducted Spurious Emission Measurement Result Ch Low 30MHz – 3GHz

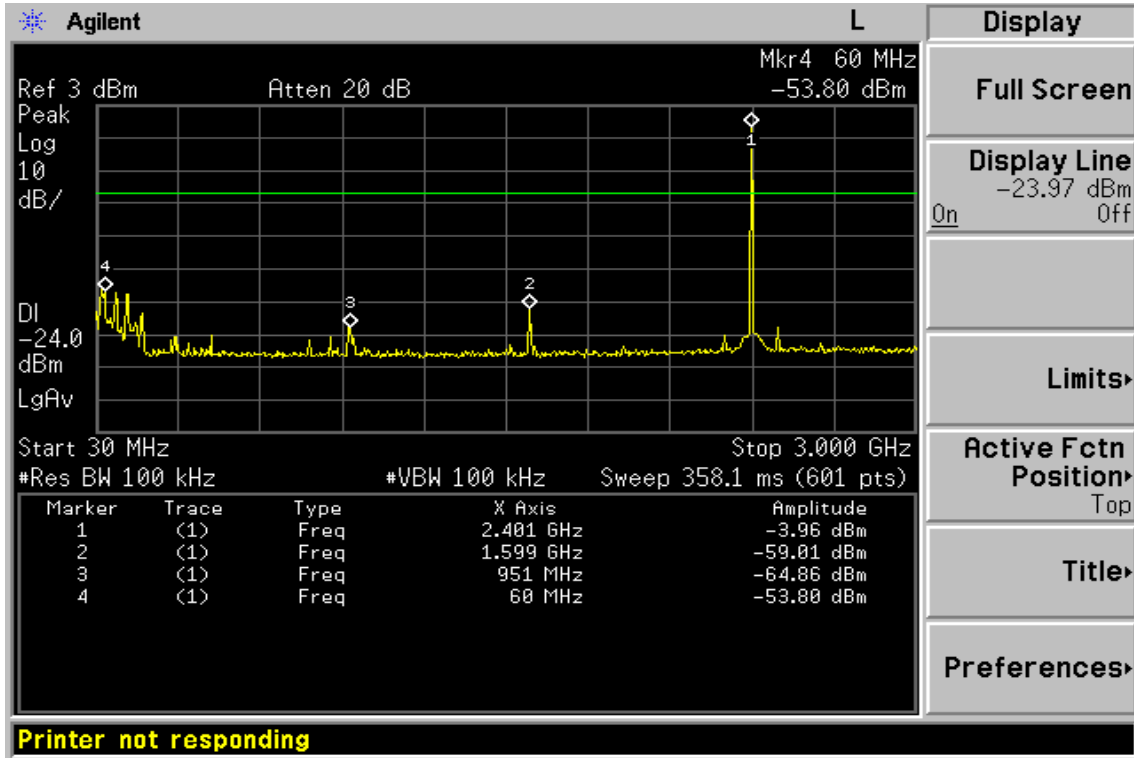

Ch Low 3GHz – 26.5GHz

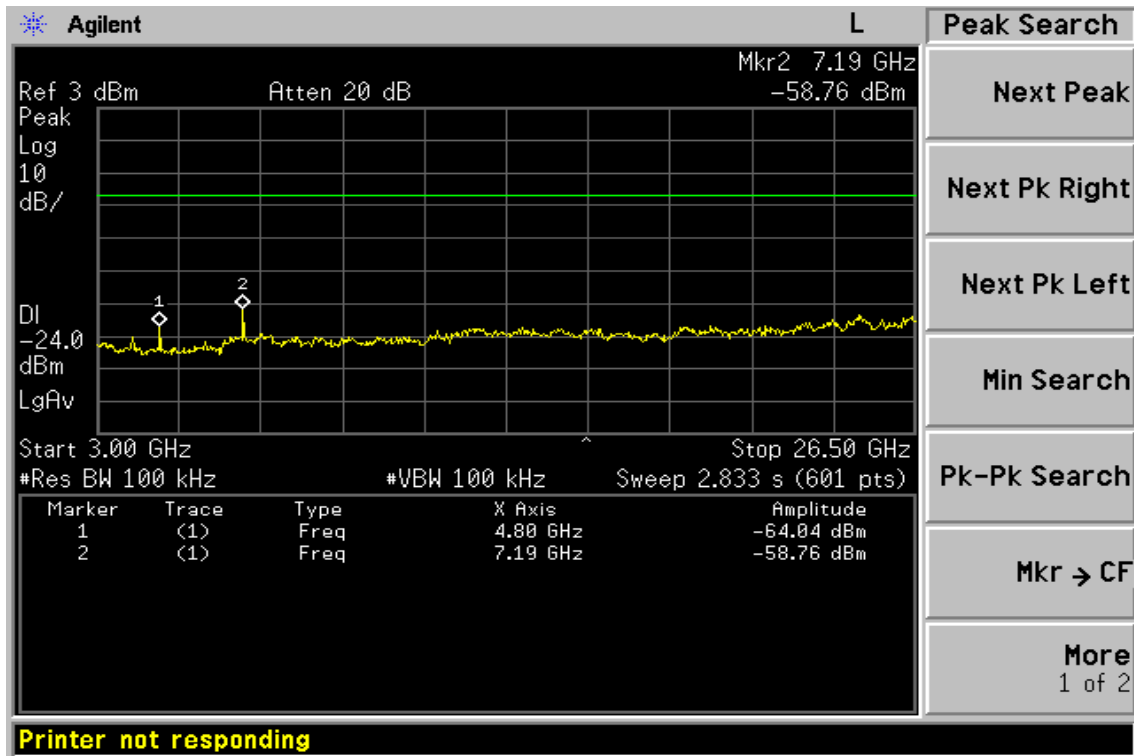

This Test Report is issued by the Company subject to its General Conditions of Service printed overleaf. Attention is drawn to the limitations of liability, indemnification, and Jurisdictional issued defined therein. The results shown in this test report refer only to the sample(s) tested unless otherwise stated. This test report cannot be reproduced, except in full, without prior written permission of the Company. Any unauthorized alteration, forgery or falsification of the content or appearance of this report is unlawful and offenders may be prosecuted to the fullest extent of the law. 此報告是遵循本公司訂定之通用服務條款所製作發放。請注意此條款列印於背面，將本公司之義務，免責，管轄權皆明確規範之。此報告結果除非另有說明僅對檢驗之樣品負責。本報告未經本公司書面許可，不可部份複製。對本報告內容或外觀之任何未經授權之變更、偽造、竄改皆屬非法，違犯者將會被依法追訴。

Ch Mid 30MHz – 3GHz

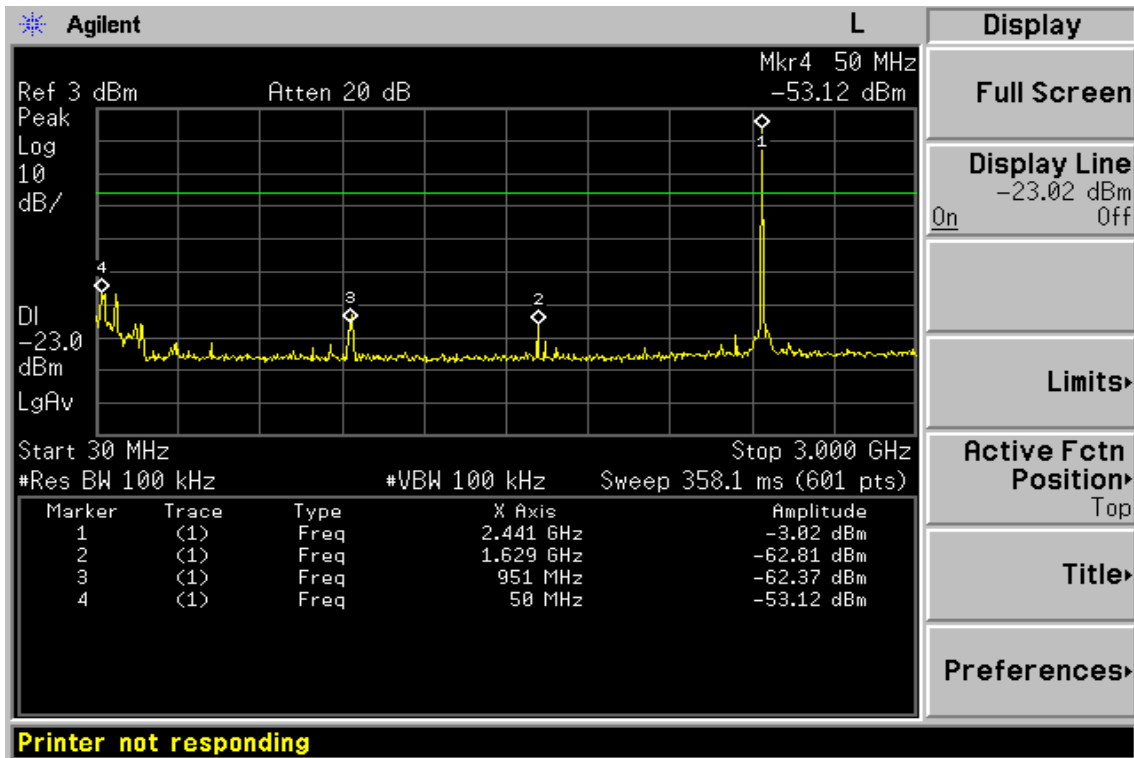

Ch Mid 3GHz – 26.5GHz

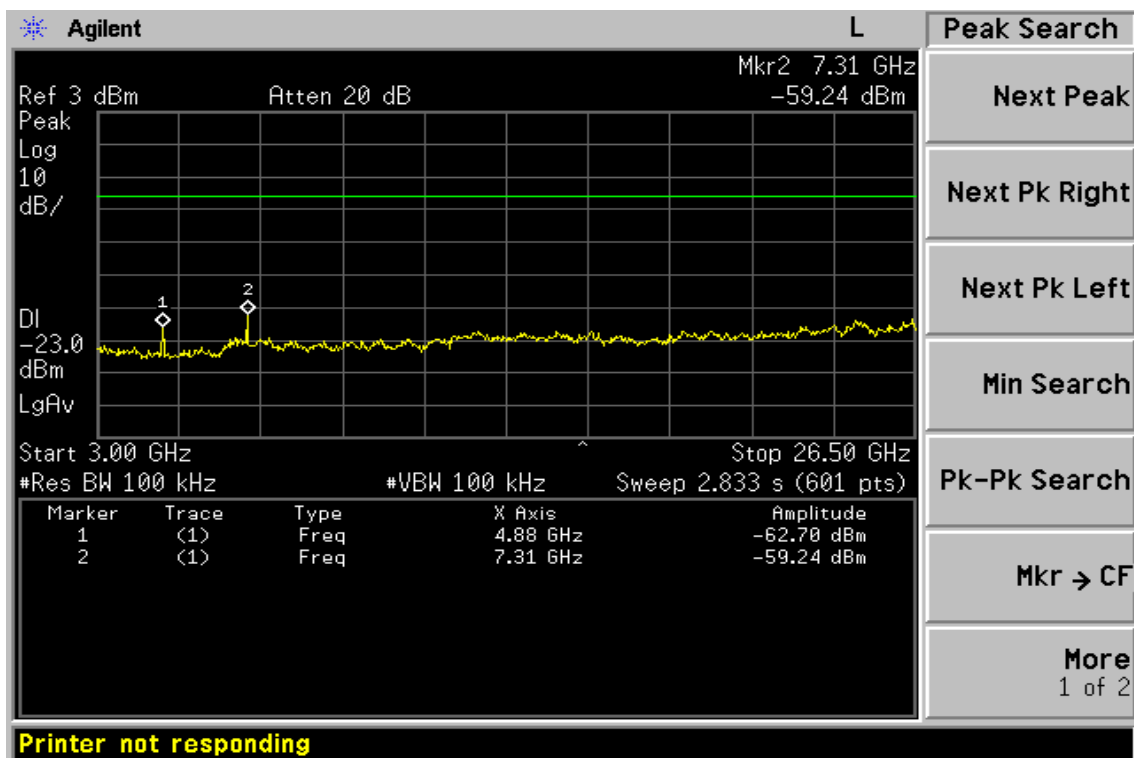

This Test Report is issued by the Company subject to its General Conditions of Service printed overleaf. Attention is drawn to the limitations of liability, indemnification, and Jurisdictional issued defined therein. The results shown in this test report refer only to the sample(s) tested unless otherwise stated. This test report cannot be reproduced, except in full, without prior written permission of the Company. Any unauthorized alteration, forgery or falsification of the content or appearance of this report is unlawful and offenders may be prosecuted to the fullest extent of the law. 此報告是遵循本公司訂定之通用服務條款所製作發放。請注意此條款列印於背面，將本公司之義務，免責，管轄權皆明確規範之。此報告結果除非另有說明僅對檢驗之樣品負責。本報告未經本公司書面許可，不可部份複製。對本報告內容或外觀之任何未經授權之變更、偽造、竄改皆屬非法，違犯者將會被依法追訴。

Ch High 30MHz – 3GHz

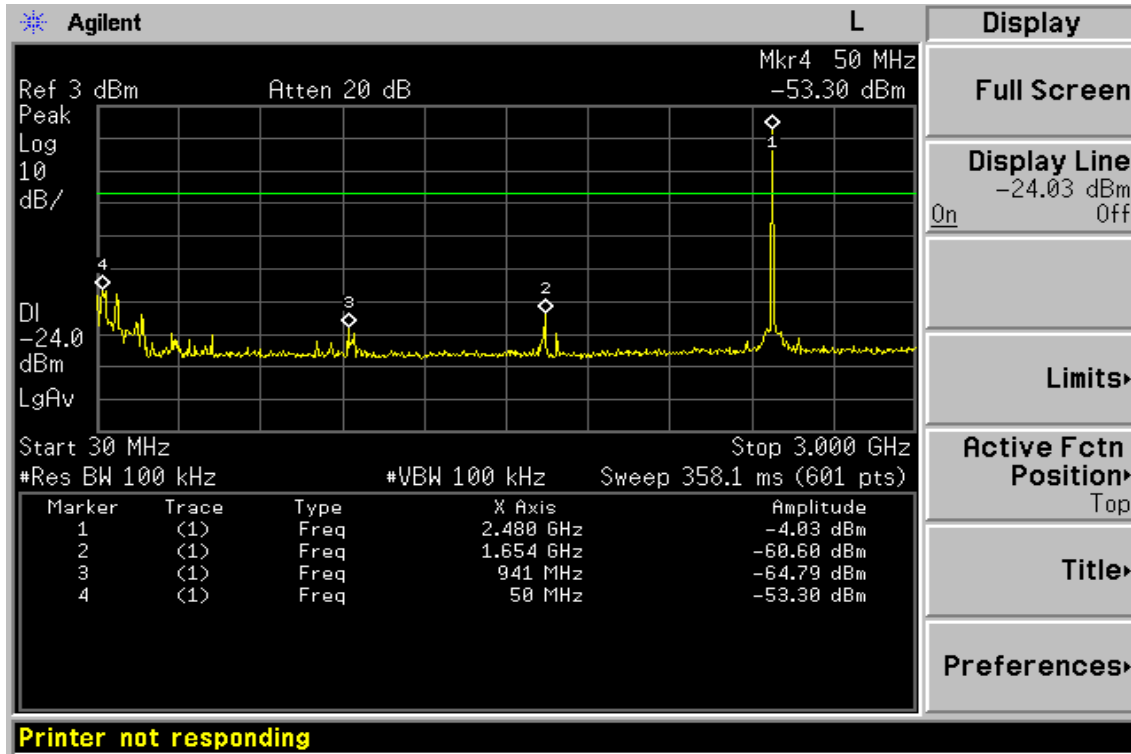

Ch High 3GHz – 26.5GHz

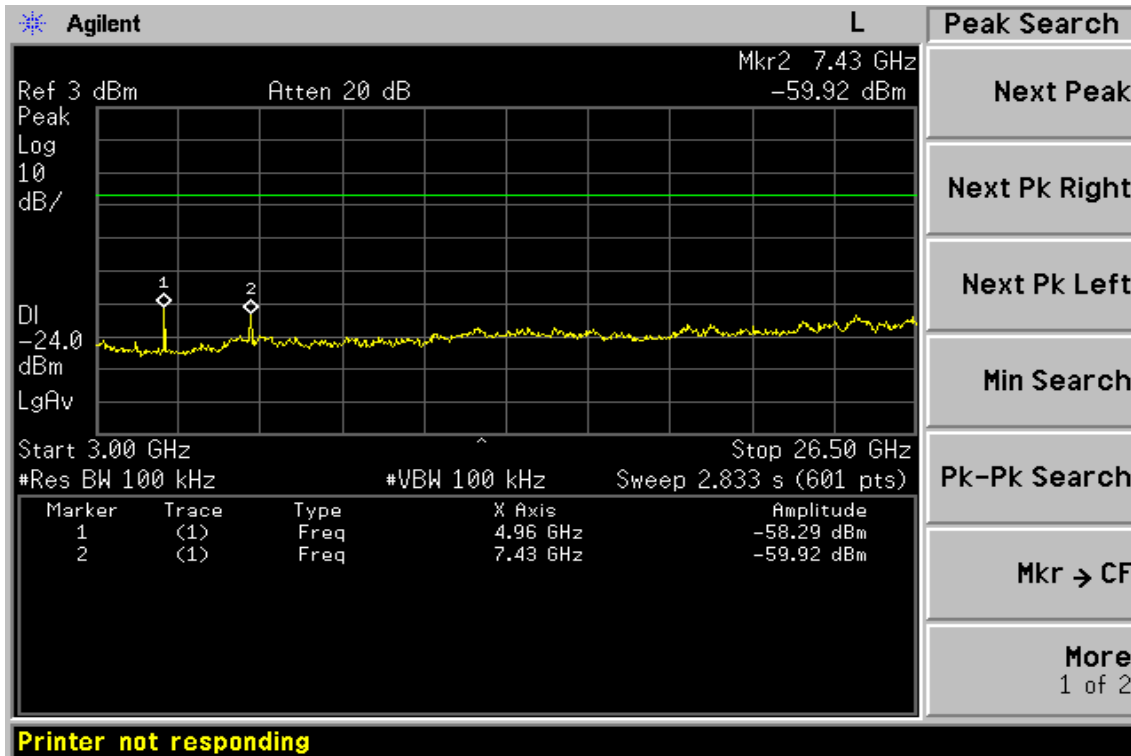

This Test Report is issued by the Company subject to its General Conditions of Service printed overleaf. Attention is drawn to the limitations of liability, indemnification, and Jurisdictional issued defined therein. The results shown in this test report refer only to the sample(s) tested unless otherwise stated. This test report cannot be reproduced, except in full, without prior written permission of the Company. Any unauthorized alteration, forgery or falsification of the content or appearance of this report is unlawful and offenders may be prosecuted to the fullest extent of the law. 此報告是遵循本公司訂定之通用服務條款所製作發放。請注意此條款列印於背面，將本公司之義務，免責，管轄權皆明確規範之。此報告結果除非另有說明僅對檢驗之樣品負責。本報告未經本公司書面許可，不可部份複製。對本報告內容或外觀之任何未經授權之變更、偽造、竄改皆屬非法，違犯者將會被依法追訴。

Radiated Spurious Emission Measurement Result (below 1GHz)

Operation Mode	TX CH Low	Test Date	May 26, 2006
Fundamental Frequency	2402MHz	Test By	Danny
Temperature	25 °C	Pol	Ver./Hor.
Humidity	65 %		

Freq. (MHz)	Ant.Pol. H/V	Detector Mode (PK/QP)	Reading (dBuV)	Factor (dB)	Actual FS (dBuV/m)	Limit3m (dBuV/m)	Safe Margin (dB)
36.79	V	Peak	46.76	-14.93	31.83	40.00	-8.17
300.63	V	Peak	45.37	-13.37	32.00	46.00	-14.00
240.49	H	Peak	40.87	-15.55	25.32	46.00	-20.68
300.63	H	Peak	49.08	-13.37	35.71	46.00	-10.29
623.64	H	Peak	44.91	-7.10	37.81	46.00	-8.19

Remark :

- 1 Measuring frequencies from 30 MHz to the 1GHz.
- 2 Radiated emissions measured in frequency range from 30 MHz to 1000MHz were made with an instrument using Peak/QP detector mode.
- 3 Datas of measurement within this frequency range shown “ - ” in the table above means the reading of emissions are attenuated more than 20dB below the permissible limits or the field strength is too small to be measured.
- 4 The IF bandwidth of SPA between 30MHz to 1GHz was 100KHz.

This Test Report is issued by the Company subject to its General Conditions of Service printed overleaf. Attention is drawn to the limitations of liability, indemnification, and Jurisdictional issued defined therein. The results shown in this test report refer only to the sample(s) tested unless otherwise stated. This test report cannot be reproduced, except in full, without prior written permission of the Company. Any unauthorized alteration, forgery or falsification of the content or appearance of this report is unlawful and offenders may be prosecuted to the fullest extent of the law. 此報告是遵循本公司訂定之通用服務條款所製作發放。請注意此條款列印於背面，將本公司之義務，免責，管轄權皆明確規範之。此報告結果除非另有說明僅對檢驗之樣品負責。本報告未經本公司書面許可，不可部份複製。對本報告內容或外觀之任何未經授權之變更、偽造、竄改皆屬非法，違犯者將會被依法追訴。

Radiated Spurious Emission Measurement Result (below 1GHz)

Operation Mode	TX CH Mid	Test Date	May 26, 2006
Fundamental Frequency	2441MHz	Test By	Danny
Temperature	25 °C	Pol	Ver./Hor.
Humidity	65 %		

Freq. (MHz)	Ant.Pol. H/V	Detector Mode (PK/QP)	Reading (dBuV)	Factor (dB)	Actual FS (dBuV/m)	Limit3m (dBuV/m)	Safe Margin (dB)
36.79	V	Peak	46.12	-14.93	31.19	40.00	-8.81
366.59	V	Peak	39.44	-11.50	27.94	46.00	-18.06
36.79	H	Peak	40.93	-14.93	26.00	40.00	-14.00
288.99	H	Peak	43.32	-13.82	29.50	46.00	-16.50
599.39	H	Peak	37.73	-7.64	30.09	46.00	-15.91

Remark :

- 1 Measuring frequencies from 30 MHz to the 1GHz.
- 2 Radiated emissions measured in frequency range from 30 MHz to 1000MHz were made with an instrument using Peak/QP detector mode.
- 3 Datas of measurement within this frequency range shown “ - ” in the table above means the reading of emissions are attenuated more than 20dB below the permissible limits or the field strength is too small to be measured.
- 4 The IF bandwidth of SPA between 30MHz to 1GHz was 100KHz.

This Test Report is issued by the Company subject to its General Conditions of Service printed overleaf. Attention is drawn to the limitations of liability, indemnification, and Jurisdictional issued defined therein. The results shown in this test report refer only to the sample(s) tested unless otherwise stated. This test report cannot be reproduced, except in full, without prior written permission of the Company. Any unauthorized alteration, forgery or falsification of the content or appearance of this report is unlawful and offenders may be prosecuted to the fullest extent of the law. 此報告是遵循本公司訂定之通用服務條款所製作發放。請注意此條款列印於背面，將本公司之義務，免責，管轄權皆明確規範之。此報告結果除非另有說明僅對檢驗之樣品負責。本報告未經本公司書面許可，不可部份複製。對本報告內容或外觀之任何未經授權之變更、偽造、竄改皆屬非法，違犯者將會被依法追訴。

Radiated Spurious Emission Measurement Result (below 1GHz)

Operation Mode	TX CH High	Test Date	May 26, 2006
Fundamental Frequency	2480MHz	Test By	Danny
Temperature	25 °C	Pol	Ver./Hor.
Humidity	65 %		

Freq. (MHz)	Ant.Pol. H/V	Detector Mode (PK/QP)	Reading (dBuV)	Factor (dB)	Actual FS (dBuV/m)	Limit3m (dBuV/m)	Safe Margin (dB)
36.79	V	Peak	46.34	-14.93	31.41	40.00	-8.59
58.13	V	Peak	44.90	-14.85	30.05	40.00	-9.95
366.59	V	Peak	39.08	-11.50	27.58	46.00	-18.42
240.49	H	Peak	40.21	-15.55	24.66	46.00	-21.34
300.63	H	Peak	46.11	-13.37	32.74	46.00	-13.26
623.64	H	Peak	44.17	-7.10	37.07	46.00	-8.93

Remark :

- 1 Measuring frequencies from 30 MHz to the 1GHz.
- 2 Radiated emissions measured in frequency range from 30 MHz to 1000MHz were made with an instrument using Peak/QP detector mode.
- 3 Datas of measurement within this frequency range shown “ - ” in the table above means the reading of emissions are attenuated more than 20dB below the permissible limits or the field strength is too small to be measured.
- 4 The IF bandwidth of SPA between 30MHz to 1GHz was 100KHz.

This Test Report is issued by the Company subject to its General Conditions of Service printed overleaf. Attention is drawn to the limitations of liability, indemnification, and Jurisdictional issued defined therein. The results shown in this test report refer only to the sample(s) tested unless otherwise stated. This test report cannot be reproduced, except in full, without prior written permission of the Company. Any unauthorized alteration, forgery or falsification of the content or appearance of this report is unlawful and offenders may be prosecuted to the fullest extent of the law. 此報告是遵循本公司訂定之通用服務條款所製作發放。請注意此條款列印於背面，將本公司之義務，免責，管轄權皆明確規範之。此報告結果除非另有說明僅對檢驗之樣品負責。本報告未經本公司書面許可，不可部份複製。對本報告內容或外觀之任何未經授權之變更、偽造、竄改皆屬非法，違犯者將會被依法追訴。

Radiated Spurious Emission Measurement Result (above 1GHz)

Operation Mode	TX CH Low	Test Date	May 26, 2006
Fundamental Frequency	2402 MHz	Test By	Danny
Temperature	25 °C	Pol	Ver.
Humidity	65 %		

Freq. (MHz)	Peak	AV	Ant./CL CF(dB)	Actual FS		Peak	AV	Margin (dB)	Remark
	Reading (dBuV)	Reading (dBuV)		Peak (dBuV/m)	AV (dBuV/m)	Limit (dBuV/m)	Limit (dBuV/m)		
1045.5	40.92	--	-9.25	31.67	--	74.00	54.00	-22.33	Peak
4804.0	----					74.00	54.00		
7206.0	----					74.00	54.00		
9608.0	----					74.00	54.00		
12010.0	----					74.00	54.00		
14412.0	----					74.00	54.00		
16814.0	----					74.00	54.00		
19216.0	----					74.00	54.00		
21618.0	----					74.00	54.00		
24020.0	----					74.00	54.00		

Remark :

- (1) Measuring frequencies from 1GHz to the 10th harmonic of highest fundamental frequency.
- (2) Datas of measurement within this frequency range shown “ - ” in the table above means the reading of emissions are attenuated more than 20dB below the permissible limits or the field strength is too small to be measured.
- (3) Radiated emissions measured in frequency above 1000MHz were made with an instrument using Peak detector mode and average detector mode of the emission shown in Actual FS column.
- (4) Spectrum Peak Setting : 1GHz- 26GHz, RBW= 1MHz, VBW= 3MHz, Sweep time= 200 ms.
- (5) Spectrum AV Setting : 1GHz- 26GHz, RBW= 1MHz, VBW= 10Hz, Sweep time= 200 ms.

This Test Report is issued by the Company subject to its General Conditions of Service printed overleaf. Attention is drawn to the limitations of liability, indemnification, and Jurisdictional issued defined therein. The results shown in this test report refer only to the sample(s) tested unless otherwise stated. This test report cannot be reproduced, except in full, without prior written permission of the Company. Any unauthorized alteration, forgery or falsification of the content or appearance of this report is unlawful and offenders may be prosecuted to the fullest extent of the law. 此報告是遵循本公司訂定之通用服務條款所製作發放。請注意此條款列印於背面，將本公司之義務，免責，管轄權皆明確規範之。此報告結果除非另有說明僅對檢驗之樣品負責。本報告未經本公司書面許可，不可部份複製。對本報告內容或外觀之任何未經授權之變更、偽造、竄改皆屬非法，違犯者將會被依法追訴。

Radiated Spurious Emission Measurement Result (above 1GHz)

Operation Mode	TX CH Low	Test Date	May 26, 2006
Fundamental Frequency	2402 MHz	Test By	Danny
Temperature	25 °C	Pol	Hor.
Humidity	65 %		

Freq. (MHz)	Peak	AV	Ant./CL CF(dB)	Actual FS		Peak	AV	Margin (dB)	Remark
	Reading (dBuV)	Reading (dBuV)		Peak (dBuV/m)	AV (dBuV/m)	Limit (dBuV/m)	Limit (dBuV/m)		
1351.0	44.45	--	-7.85	36.60	--	74.00	54.00	-17.40	Peak
4804.0	39.27	--	2.96	42.23	--	74.00	54.00	-11.77	Peak
7206.0	----					74.00	54.00		
9608.0	----					74.00	54.00		
12010.0	----					74.00	54.00		
14412.0	----					74.00	54.00		
16814.0	----					74.00	54.00		
19216.0	----					74.00	54.00		
21618.0	----					74.00	54.00		
24020.0	----					74.00	54.00		

Remark :

- (1) Measuring frequencies from 1GHz to the 10th harmonic of highest fundamental frequency.
- (2) Data of measurement within this frequency range shown “ - ” in the table above means the reading of emissions are attenuated more than 20dB below the permissible limits or the field strength is too small to be measured.
- (3) Radiated emissions measured in frequency above 1000MHz were made with an instrument using Peak detector mode and average detector mode of the emission shown in Actual FS column.
- (4) Spectrum Peak Setting : 1GHz- 26GHz, RBW= 1MHz, VBW= 3MHz, Sweep time= 200 ms.
- (5) Spectrum AV Setting : 1GHz- 26GHz, RBW= 1MHz, VBW= 10Hz, Sweep time= 200 ms.

This Test Report is issued by the Company subject to its General Conditions of Service printed overleaf. Attention is drawn to the limitations of liability, indemnification, and Jurisdictional issued defined therein. The results shown in this test report refer only to the sample(s) tested unless otherwise stated. This test report cannot be reproduced, except in full, without prior written permission of the Company. Any unauthorized alteration, forgery or falsification of the content or appearance of this report is unlawful and offenders may be prosecuted to the fullest extent of the law. 此報告是遵循本公司訂定之通用服務條款所製作發放。請注意此條款列印於背面，將本公司之義務，免責，管轄權皆明確規範之。此報告結果除非另有說明僅對檢驗之樣品負責。本報告未經本公司書面許可，不可部份複製。對本報告內容或外觀之任何未經授權之變更、偽造、竄改皆屬非法，違犯者將會被依法追訴。

Radiated Spurious Emission Measurement Result (above 1GHz)

Operation Mode	TX CH Mid	Test Date	May 26, 2006
Fundamental Frequency	2441 MHz	Test By	Danny
Temperature	25 °C	Pol	Ver.
Humidity	65 %		

Freq. (MHz)	Peak	AV	Ant./CL CF(dB)	Actual FS		Peak	AV	Margin (dB)	Remark
	Reading (dBuV)	Reading (dBuV)		Peak (dBuV/m)	AV (dBuV/m)	Limit (dBuV/m)	Limit (dBuV/m)		
1188.5	41.51	--	-8.65	32.86	--	74.00	54.00	-21.14	Peak
4882.0	----					74.00	54.00		
7323.0	----					74.00	54.00		
9764.0	----					74.00	54.00		
12205.0	----					74.00	54.00		
14646.0	----					74.00	54.00		
17087.0	----					74.00	54.00		
19528.0	----					74.00	54.00		
21969.0	----					74.00	54.00		
24410.0	----					74.00	54.00		

Remark :

- (1) Measuring frequencies from 1GHz to the 10th harmonic of highest fundamental frequency.
- (2) Data of measurement within this frequency range shown “ - ” in the table above means the reading of emissions are attenuated more than 20dB below the permissible limits or the field strength is too small to be measured.
- (3) Radiated emissions measured in frequency above 1000MHz were made with an instrument using Peak detector mode and average detector mode of the emission shown in Actual FS column.
- (4) Spectrum Peak Setting : 1GHz- 26GHz, RBW= 1MHz, VBW= 3MHz, Sweep time= 200 ms.
- (5) Spectrum AV Setting : 1GHz- 26GHz, RBW= 1MHz, VBW= 10Hz, Sweep time= 200 ms.

This Test Report is issued by the Company subject to its General Conditions of Service printed overleaf. Attention is drawn to the limitations of liability, indemnification, and Jurisdictional issued defined therein. The results shown in this test report refer only to the sample(s) tested unless otherwise stated. This test report cannot be reproduced, except in full, without prior written permission of the Company. Any unauthorized alteration, forgery or falsification of the content or appearance of this report is unlawful and offenders may be prosecuted to the fullest extent of the law. 此報告是遵循本公司訂定之通用服務條款所製作發放。請注意此條款列印於背面，將本公司之義務，免責，管轄權皆明確規範之。此報告結果除非另有說明僅對檢驗之樣品負責。本報告未經本公司書面許可，不可部份複製。對本報告內容或外觀之任何未經授權之變更、偽造、竄改皆屬非法，違犯者將會被依法追訴。

Radiated Spurious Emission Measurement Result (above 1GHz)

Operation Mode	TX CH Mid	Test Date	May 26, 2006
Fundamental Frequency	2441 MHz	Test By	Danny
Temperature	25 °C	Pol	Hor.
Humidity	65 %		

Freq. (MHz)	Peak	AV	Ant./CL CF(dB)	Actual FS		Peak	AV	Margin (dB)	Remark
	Reading (dBuV)	Reading (dBuV)		Peak (dBuV/m)	AV (dBuV/m)	Limit (dBuV/m)	Limit (dBuV/m)		
1351.0	43.48	--	-7.85	35.63	--	74.00	54.00	-18.37	Peak
4882.0	38.82	--	3.18	42.00	--	74.00	54.00	-12.00	Peak
7323.0	----					74.00	54.00		
9764.0	----					74.00	54.00		
12205.0	----					74.00	54.00		
14646.0	----					74.00	54.00		
17087.0	----					74.00	54.00		
19528.0	----					74.00	54.00		
21969.0	----					74.00	54.00		
24410.0	----					74.00	54.00		

Remark :

- (1) Measuring frequencies from 1GHz to the 10th harmonic of highest fundamental frequency.
- (2) Datas of measurement within this frequency range shown “ - ” in the table above means the reading of emissions are attenuated more than 20dB below the permissible limits or the field strength is too small to be measured.
- (3) Radiated emissions measured in frequency above 1000MHz were made with an instrument using Peak detector mode and average detector mode of the emission shown in Actual FS column.
- (4) Spectrum Peak Setting : 1GHz- 26GHz, RBW= 1MHz, VBW= 3MHz, Sweep time= 200 ms.
- (5) Spectrum AV Setting : 1GHz- 26GHz, RBW= 1MHz, VBW= 10Hz, Sweep time= 200 ms.

This Test Report is issued by the Company subject to its General Conditions of Service printed overleaf. Attention is drawn to the limitations of liability, indemnification, and Jurisdictional issued defined therein. The results shown in this test report refer only to the sample(s) tested unless otherwise stated. This test report cannot be reproduced, except in full, without prior written permission of the Company. Any unauthorized alteration, forgery or falsification of the content or appearance of this report is unlawful and offenders may be prosecuted to the fullest extent of the law. 此報告是遵循本公司訂定之通用服務條款所製作發放。請注意此條款列印於背面，將本公司之義務，免責，管轄權皆明確規範之。此報告結果除非另有說明僅對檢驗之樣品負責。本報告未經本公司書面許可，不可部份複製。對本報告內容或外觀之任何未經授權之變更、偽造、竄改皆屬非法，違犯者將會被依法追訴。

Radiated Spurious Emission Measurement Result (above 1GHz)

Operation Mode	TX CH High	Test Date	May 26, 2006
Fundamental Frequency	2480 MHz	Test By	Danny
Temperature	25 °C	Pol	Ver.
Humidity	65 %		

Freq. (MHz)	Peak	AV	Ant./CL CF(dB)	Actual FS		Peak	AV	Margin (dB)	Remark
	Reading (dBuV)	Reading (dBuV)		Peak (dBuV/m)	AV (dBuV/m)	Limit (dBuV/m)	Limit (dBuV/m)		
1741.0	42.82	--	-6.19	36.63	--	74.00	54.00	-17.37	Peak
4960.0	----					74.00	54.00		
7440.0	----					74.00	54.00		
9920.0	----					74.00	54.00		
12400.0	----					74.00	54.00		
14880.0	----					74.00	54.00		
17360.0	----					74.00	54.00		
19840.0	----					74.00	54.00		
22320.0	----					74.00	54.00		
24800.0	----					74.00	54.00		

Remark :

- (1) Measuring frequencies from 1GHz to the 10th harmonic of highest fundamental frequency.
- (2) Datas of measurement within this frequency range shown “ - ” in the table above means the reading of emissions are attenuated more than 20dB below the permissible limits or the field strength is too small to be measured.
- (3) Radiated emissions measured in frequency above 1000MHz were made with an instrument using Peak detector mode and average detector mode of the emission shown in Actual FS column.
- (4) Spectrum Peak Setting : 1GHz- 26GHz, RBW= 1MHz, VBW= 3MHz, Sweep time= 200 ms.
- (5) Spectrum AV Setting : 1GHz- 26GHz, RBW= 1MHz, VBW= 10Hz, Sweep time= 200 ms.

This Test Report is issued by the Company subject to its General Conditions of Service printed overleaf. Attention is drawn to the limitations of liability, indemnification, and Jurisdictional issued defined therein. The results shown in this test report refer only to the sample(s) tested unless otherwise stated. This test report cannot be reproduced, except in full, without prior written permission of the Company. Any unauthorized alteration, forgery or falsification of the content or appearance of this report is unlawful and offenders may be prosecuted to the fullest extent of the law. 此報告是遵循本公司訂定之通用服務條款所製作發放。請注意此條款列印於背面，將本公司之義務，免責，管轄權皆明確規範之。此報告結果除非另有說明僅對檢驗之樣品負責。本報告未經本公司書面許可，不可部份複製。對本報告內容或外觀之任何未經授權之變更、偽造、竄改皆屬非法，違犯者將會被依法追訴。

Radiated Spurious Emission Measurement Result (above 1GHz)

Operation Mode	TX CH High	Test Date	May 26, 2006
Fundamental Frequency	2480 MHz	Test By	Danny
Temperature	25 °C	Pol	Hor.
Humidity	65 %		

Freq. (MHz)	Peak	AV	Ant./CL CF(dB)	Actual FS		Peak	AV	Margin (dB)	Remar
	Reading (dBuV)	Reading (dBuV)		Peak (dBuV/m)	AV (dBuV/m)	Limit (dBuV/m)	Limit (dBuV/m)		
1643.5	43.23	--	-6.60	36.63	--	74.00	54.00	-17.37	Peak
4960.0	----					74.00	54.00		
7440.0	----					74.00	54.00		
9920.0	----					74.00	54.00		
12400.0	----					74.00	54.00		
14880.0	----					74.00	54.00		
17360.0	----					74.00	54.00		
19840.0	----					74.00	54.00		
22320.0	----					74.00	54.00		
24800.0	----					74.00	54.00		

Remark :

- (1) Measuring frequencies from 1GHz to the 10th harmonic of highest fundamental frequency.
- (2) Data of measurement within this frequency range shown “ - ” in the table above means the reading of emissions are attenuated more than 20dB below the permissible limits or the field strength is too small to be measured.
- (3) Radiated emissions measured in frequency above 1000MHz were made with an instrument using Peak detector mode and average detector mode of the emission shown in Actual FS column.
- (4) Spectrum Peak Setting : 1GHz- 26GHz, RBW= 1MHz, VBW= 3MHz, Sweep time= 200 ms.
- (5) Spectrum AV Setting : 1GHz- 26GHz, RBW= 1MHz, VBW= 10Hz, Sweep time= 200 ms.

This Test Report is issued by the Company subject to its General Conditions of Service printed overleaf. Attention is drawn to the limitations of liability, indemnification, and Jurisdictional issued defined therein. The results shown in this test report refer only to the sample(s) tested unless otherwise stated. This test report cannot be reproduced, except in full, without prior written permission of the Company. Any unauthorized alteration, forgery or falsification of the content or appearance of this report is unlawful and offenders may be prosecuted to the fullest extent of the law. 此報告是遵循本公司訂定之通用服務條款所製作發放。請注意此條款列印於背面，將本公司之義務、免責、管轄權皆明確規範之。此報告結果除非另有說明僅對檢驗之樣品負責。本報告未經本公司書面許可，不可部份複製。對本報告內容或外觀之任何未經授權之變更、偽造、竄改皆屬非法，違犯者將會被依法追訴。

10. FREQUENCY SEPARATION

10.1. Standard Applicable

According to §15.247(a)(1), Frequency hopping systems shall have hopping channel carrier frequencies separated by minimum of 25KHz or the $2/3 * 20\text{dB}$ bandwidth of the hopping channel, whichever is greater.

10.2. Measurement Procedure

1. Place the EUT on the table and set it in transmitting mode.
2. Remove the antenna from the EUT and then connect a low loss RF cable from the antenna port to the spectrum analyzer.
3. Set center frequency of spectrum analyzer = middle of hopping channel .
4. Set the spectrum analyzer as RBW,VBW=100KHz, Adjust Span to 5 MHz, Sweep = auto.
5. Max hold. Mark 3 Peaks of hopping channel and record the 3 peaks frequency.

10.3. Measurement Result

Channel separation	Limit	Result
MHz	kHz	
1	$\geq 25\text{KHz}$ or $2/3 * 20\text{ dB bandwidth}$	PASS

10.4. Measurement Equipment Used:

EQUIPMENT TYPE	MFR	MODEL NUMBER	SERIAL NUMBER	LAST CAL.	CAL DUE.
Spectrum Analyzer	R&S	FSP 40	100034	05/27/2007	05/26/2008
Spectrum Analyzer	Agilent	E7405A	US41160416	08/27/2006	08/26/2007
Spectrum Analyzer	Agilent	E4446A	MY43360126	01/22/2007	01/21/2008
Low Loss Cable	HUBER+SUHNER	SUCOFLEX 104PEA	N/A	N/A	N/A
Attenuator	Mini-Circuit	BW-S6W5	N/A	10/07/2006	10/06/2007

This Test Report is issued by the Company subject to its General Conditions of Service printed overleaf. Attention is drawn to the limitations of liability, indemnification, and Jurisdictional issued defined therein. The results shown in this test report refer only to the sample(s) tested unless otherwise stated. This test report cannot be reproduced, except in full, without prior written permission of the Company. Any unauthorized alteration, forgery or falsification of the content or appearance of this report is unlawful and offenders may be prosecuted to the fullest extent of the law. 此報告是遵循本公司訂定之通用服務條款所製作發放。請注意此條款列印於背面，將本公司之義務，免責，管轄權皆明確規範之。此報告結果除非另有說明僅對檢驗之樣品負責。本報告未經本公司書面許可，不可部份複製。對本報告內容或外觀之任何未經授權之變更、偽造、竄改皆屬非法，違犯者將會被依法追訴。

Frequency Separation Test Data

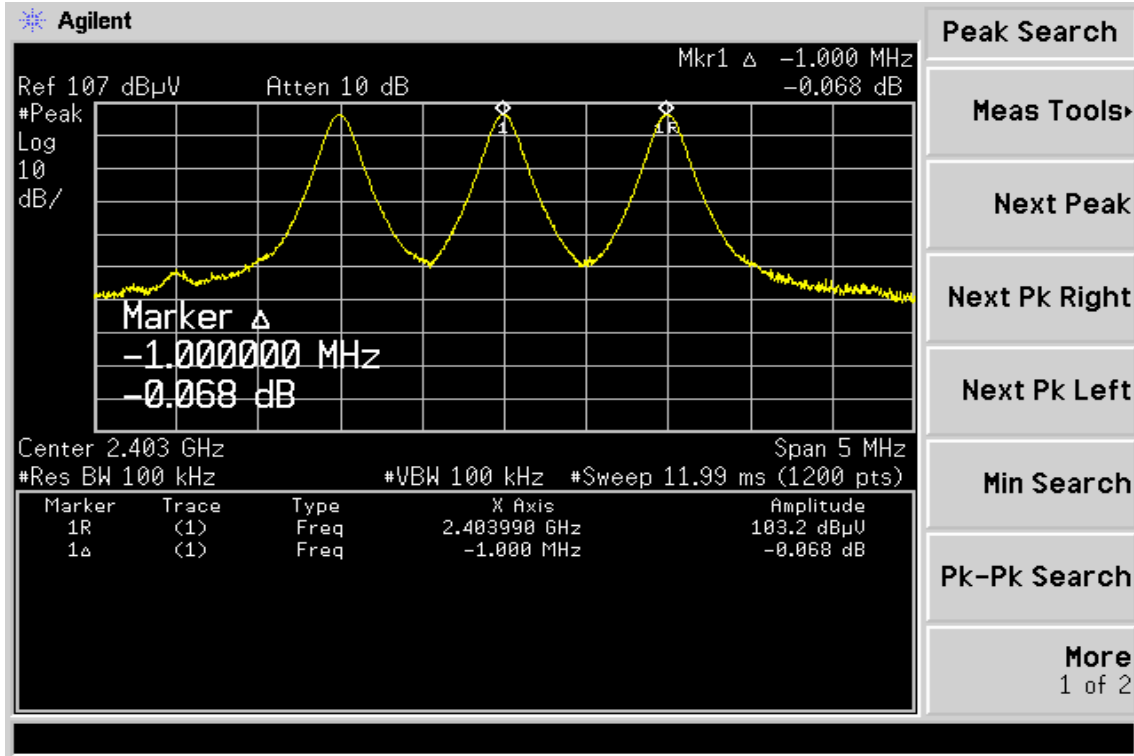

This Test Report is issued by the Company subject to its General Conditions of Service printed overleaf. Attention is drawn to the limitations of liability, indemnification, and Jurisdictional issued defined therein. The results shown in this test report refer only to the sample(s) tested unless otherwise stated. This test report cannot be reproduced, except in full, without prior written permission of the Company. Any unauthorized alteration, forgery or falsification of the content or appearance of this report is unlawful and offenders may be prosecuted to the fullest extent of the law. 此報告是遵循本公司訂定之通用服務條款所製作發放。請注意此條款列印於背面，將本公司之義務，免責，管轄權皆明確規範之。此報告結果除非另有說明僅對檢驗之樣品負責。本報告未經本公司書面許可，不可部份複製。對本報告內容或外觀之任何未經授權之變更、偽造、竄改皆屬非法，違犯者將會被依法追訴。

11. NUMBER OF HOPPING FREQUENCY

11.1. Standard Applicable

According to §15.247(a)(1)(iii), Frequency hopping systems operating in the 2400MHz-2483.5 MHz bands shall use at least 15 hopping frequencies.

11.2. Measurement Procedure

1. Place the EUT on the table and set it in transmitting mode.
2. Remove the antenna from the EUT and then connect a low loss RF cable from the antenna port to the spectrum analyzer.
3. Set spectrum analyzer Start=2400MHz, Stop = 2483.5MHz, Sweep = auto.
4. Set the spectrum analyzer as RBW,VBW=100KHz,
5. Max hold, view and count how many channel in the band.

11.3. Measurement Result

Total No of hopping channel	Limit (CH)	Measurement result (CH)	Result
	15	79	Pass

11.4. Measurement Equipment Used:

EQUIPMENT TYPE	MFR	MODEL NUMBER	SERIAL NUMBER	LAST CAL.	CAL DUE.
Spectrum Analyzer	R&S	FSP 40	100034	05/27/2007	05/26/2008
Spectrum Analyzer	Agilent	E7405A	US41160416	08/27/2006	08/26/2007
Spectrum Analyzer	Agilent	E4446A	MY43360126	01/22/2007	01/21/2008
Low Loss Cable	HUBER+SUHNER	SUCOFLEX 104PEA	N/A	N/A	N/A
Attenuator	Mini-Circuit	BW-S6W5	N/A	10/07/2006	10/06/2007

This Test Report is issued by the Company subject to its General Conditions of Service printed overleaf. Attention is drawn to the limitations of liability, indemnification, and Jurisdictional issued defined therein. The results shown in this test report refer only to the sample(s) tested unless otherwise stated. This test report cannot be reproduced, except in full, without prior written permission of the Company. Any unauthorized alteration, forgery or falsification of the content or appearance of this report is unlawful and offenders may be prosecuted to the fullest extent of the law. 此報告是遵循本公司訂定之通用服務條款所製作發放。請注意此條款列印於背面，將本公司之義務，免責，管轄權皆明確規範之。此報告結果除非另有說明僅對檢驗之樣品負責。本報告未經本公司書面許可，不可部份複製。對本報告內容或外觀之任何未經授權之變更、偽造、竄改皆屬非法，違犯者將會被依法追訴。

Channel Number

2.4 GHz – 2.441GHz

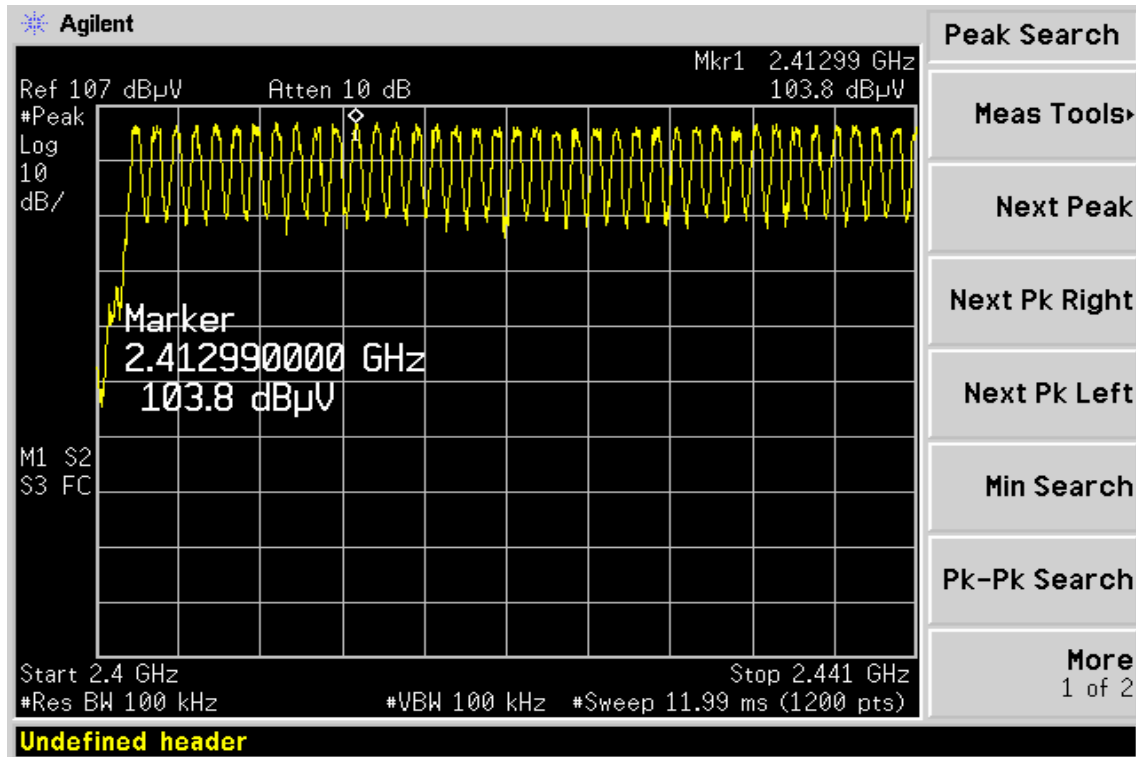

2.441 GHz – 2.4835GHz

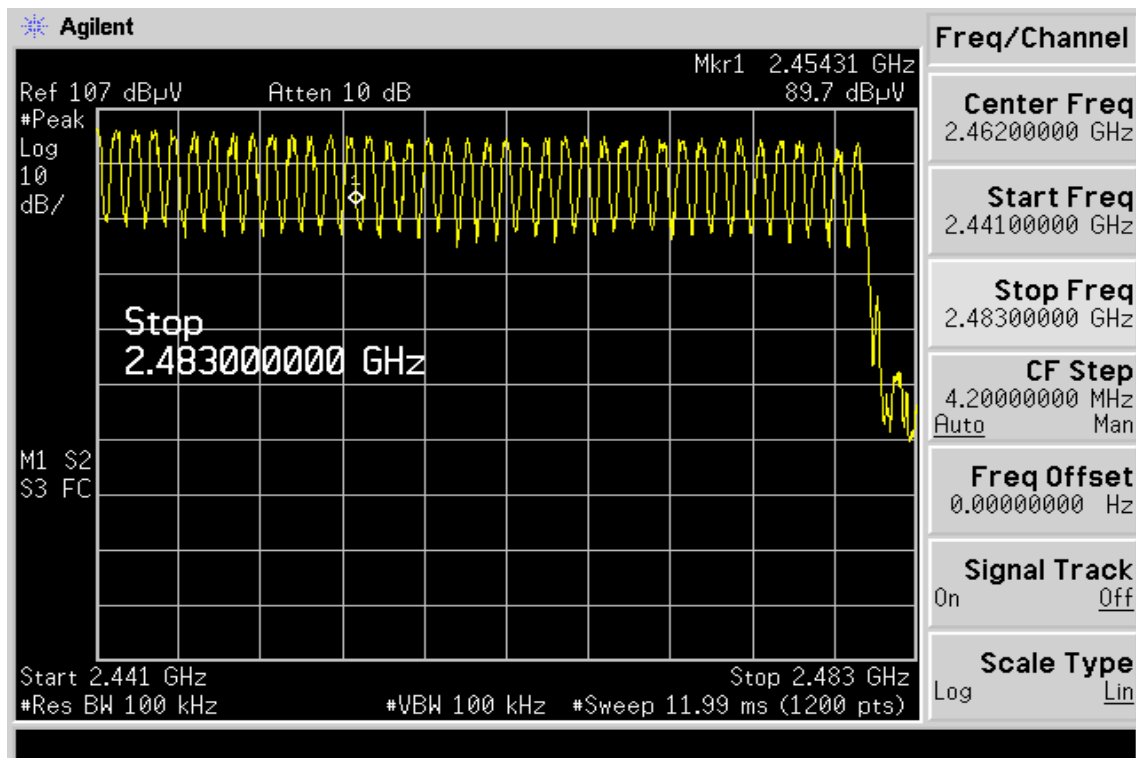

This Test Report is issued by the Company subject to its General Conditions of Service printed overleaf. Attention is drawn to the limitations of liability, indemnification, and Jurisdictional issued defined therein. The results shown in this test report refer only to the sample(s) tested unless otherwise stated. This test report cannot be reproduced, except in full, without prior written permission of the Company. Any unauthorized alteration, forgery or falsification of the content or appearance of this report is unlawful and offenders may be prosecuted to the fullest extent of the law. 此報告是遵循本公司訂定之通用服務條款所製作發放。請注意此條款列印於背面，將本公司之義務，免責，管轄權皆明確規範之。此報告結果除非另有說明僅對檢驗之樣品負責。本報告未經本公司書面許可，不可部份複製。對本報告內容或外觀之任何未經授權之變更、偽造、竄改皆屬非法，違犯者將會被依法追訴。

12. TIME OF OCCUPANCY (DWELL TIME)

12.1. Standard Applicable

According to §15.247(a)(1)(iii), Frequency hopping systems operating in the 2400MHz-2483.5 MHz. The average time of occupancy on any frequency shall not greater than 0.4 s within period of 0.4 seconds multiplied by the number of hopping channel employed.

12.2. Measurement Procedure

1. Place the EUT on the table and set it in transmitting mode.
2. Remove the antenna from the EUT and then connect a low loss RF cable from the antenna port to the spectrum analyzer.
3. Set center frequency of spectrum analyzer = operating frequency.
4. Set the spectrum analyzer as RBW,VBW=100KHz, Span = 0Hz , Adjust Sweep = 30s.
5. Repeat above procedures until all frequency measured were complete.

12.3. Measurement Result

A period time = 0.4 (ms) * 79 = 31.6 (s)

CH Low: DH1 time slot = 0.405 (ms) * (1600/(1*79)) * 31.6 = 259.2 (ms)

DH3 time slot = 1.675 (ms) * (1600/(3*79)) * 31.6 = 357.3 (ms)

DH5 time slot = 2.925 (ms) * (1600/(5*79)) * 31.6 = 374.4 (ms)

CH Mid: DH1 time slot = 0.405 (ms) * (1600/(1*79)) * 31.6 = 259.2 (ms)

DH3 time slot = 1.675 (ms) * (1600/(3*79)) * 31.6 = 357.3 (ms)

DH5 time slot = 2.906 (ms) * (1600/(5*79)) * 31.6 = 372.0 (ms)

CH High: DH1 time slot = 0.416 (ms) * (1600/(1*79)) * 31.6 = 266.2 (ms)

DH3 time slot = 1.662 (ms) * (1600/(3*79)) * 31.6 = 354.6 (ms)

DH5 time slot = 2.906 (ms) * (1600/(5*79)) * 31.6 = 372.0 (ms)

This Test Report is issued by the Company subject to its General Conditions of Service printed overleaf. Attention is drawn to the limitations of liability, indemnification, and Jurisdictional issued defined therein. The results shown in this test report refer only to the sample(s) tested unless otherwise stated. This test report cannot be reproduced, except in full, without prior written permission of the Company. Any unauthorized alteration, forgery or falsification of the content or appearance of this report is unlawful and offenders may be prosecuted to the fullest extent of the law. 此報告是遵循本公司訂定之通用服務條款所製作發放。請注意此條款列印於背面，將本公司之義務，免責，管轄權皆明確規範之。此報告結果除非另有說明僅對檢驗之樣品負責。本報告未經本公司書面許可，不可部份複製。對本報告內容或外觀之任何未經授權之變更、偽造、竄改皆屬非法，違犯者將會被依法追訴。

12.4. Measurement Equipment Used:

Conducted Emission Test Site					
EQUIPMENT TYPE	MFR	MODEL NUMBER	SERIAL NUMBER	LAST CAL.	CAL DUE.
Spectrum Analyzer	Agilent	E4446A	MY43360126	03/29/2007	03/28/2008
Spectrum Analyzer	Agilent	7405A	US41160416	06/28/2007	06/29/2008
Spectrum Analyzer	R&S	FSP 40	100034	11/09/2006	11/10/2007
Low Loss Cable	HUBER+SUHNER	SUCOFLEX 104PEA	N/A	N/A	N/A
Attenuator	Mini-Circuit	BW-S10W5	N/A	10/07/2006	10/06/2007
Attenuator	Mini-Circuit	BW-S6W5	N/A	10/07/2006	10/06/2007
Splitter	Mini-Circuit	ZFSC-2-10G	N/A	10/07/2006	10/06/2007

This Test Report is issued by the Company subject to its General Conditions of Service printed overleaf. Attention is drawn to the limitations of liability, indemnification, and Jurisdictional issued defined therein. The results shown in this test report refer only to the sample(s) tested unless otherwise stated. This test report cannot be reproduced, except in full, without prior written permission of the Company. Any unauthorized alteration, forgery or falsification of the content or appearance of this report is unlawful and offenders may be prosecuted to the fullest extent of the law. 此報告是遵循本公司訂定之通用服務條款所製作發放。請注意此條款列印於背面，將本公司之義務，免責，管轄權皆明確規範之。此報告結果除非另有說明僅對檢驗之樣品負責。本報告未經本公司書面許可，不可部份複製。對本報告內容或外觀之任何未經授權之變更、偽造、竄改皆屬非法，違犯者將會被依法追訴。

Dwell Time Test Data

CH-Low

DH1

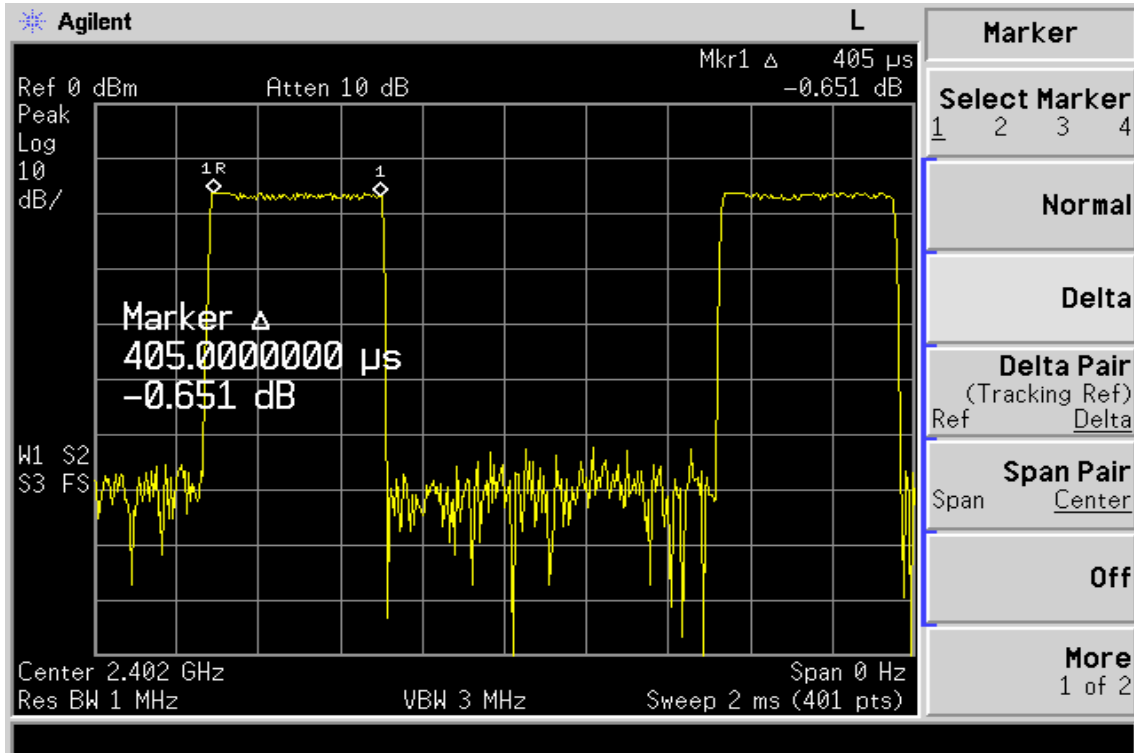

This Test Report is issued by the Company subject to its General Conditions of Service printed overleaf. Attention is drawn to the limitations of liability, indemnification, and Jurisdictional issued defined therein. The results shown in this test report refer only to the sample(s) tested unless otherwise stated. This test report cannot be reproduced, except in full, without prior written permission of the Company. Any unauthorized alteration, forgery or falsification of the content or appearance of this report is unlawful and offenders may be prosecuted to the fullest extent of the law. 此報告是遵循本公司訂定之通用服務條款所製作發放。請注意此條款列印於背面，將本公司之義務，免責，管轄權皆明確規範之。此報告結果除非另有說明僅對檢驗之樣品負責。本報告未經本公司書面許可，不可部份複製。對本報告內容或外觀之任何未經授權之變更、偽造、竄改皆屬非法，違犯者將會被依法追訴。

DH3

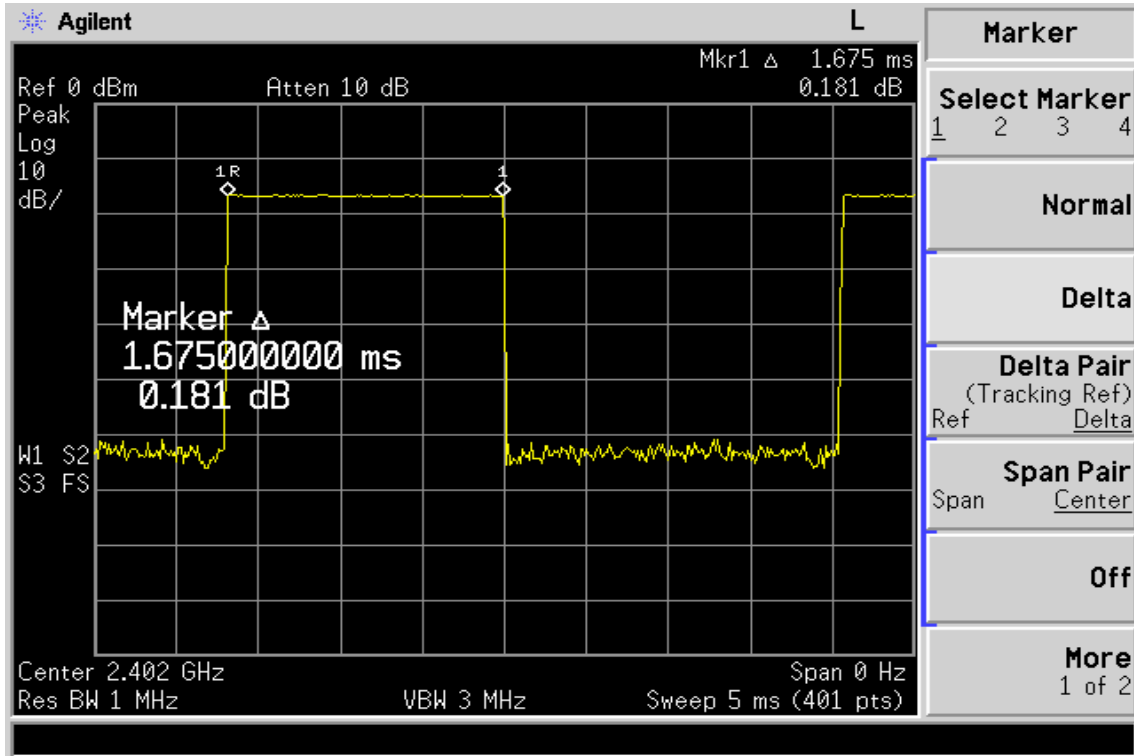

DH5

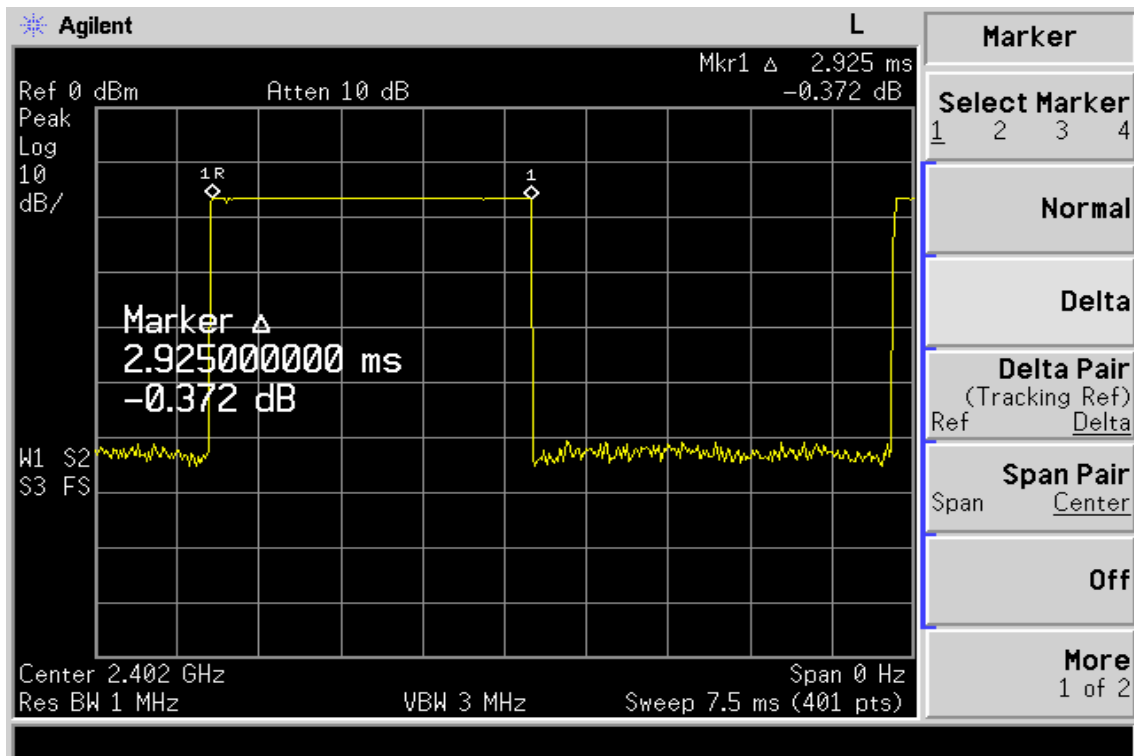

This Test Report is issued by the Company subject to its General Conditions of Service printed overleaf. Attention is drawn to the limitations of liability, indemnification, and Jurisdictional issued defined therein. The results shown in this test report refer only to the sample(s) tested unless otherwise stated. This test report cannot be reproduced, except in full, without prior written permission of the Company. Any unauthorized alteration, forgery or falsification of the content or appearance of this report is unlawful and offenders may be prosecuted to the fullest extent of the law. 此報告是遵循本公司訂定之通用服務條款所製作發放。請注意此條款列印於背面，將本公司之義務，免責，管轄權皆明確規範之。此報告結果除非另有說明僅對檢驗之樣品負責。本報告未經本公司書面許可，不可部份複製。對本報告內容或外觀之任何未經授權之變更、偽造、竄改皆屬非法，違犯者將會被依法追訴。

CH-Mid

DH1

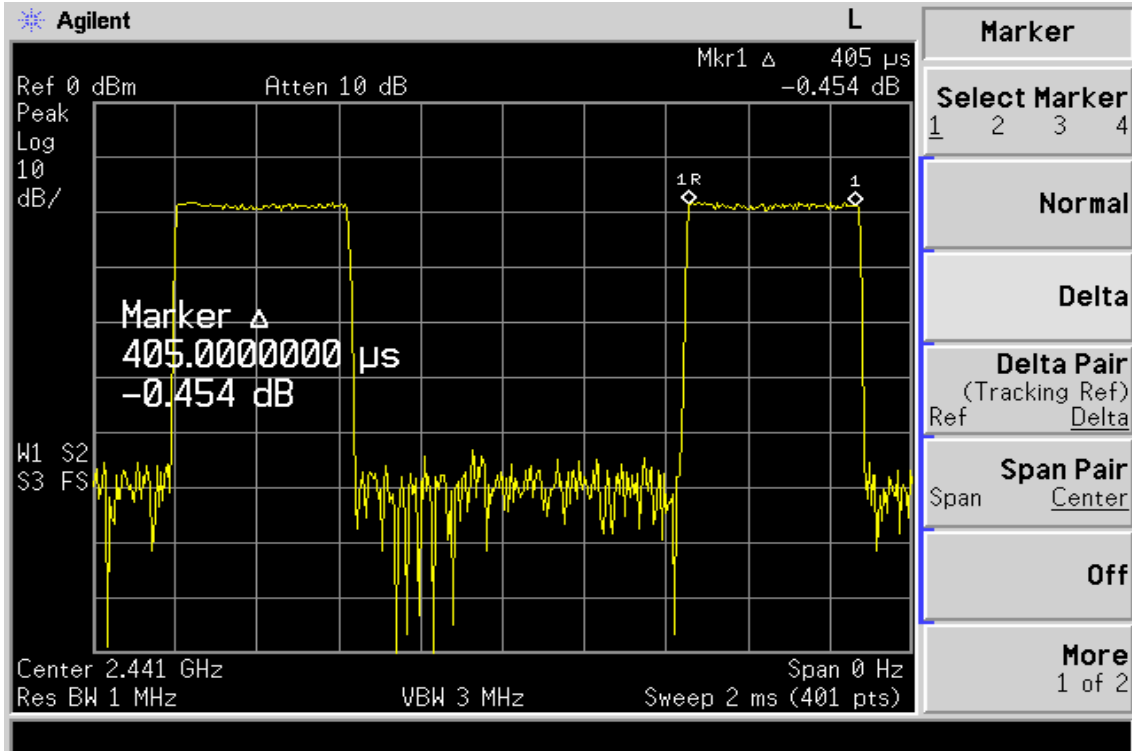

DH3

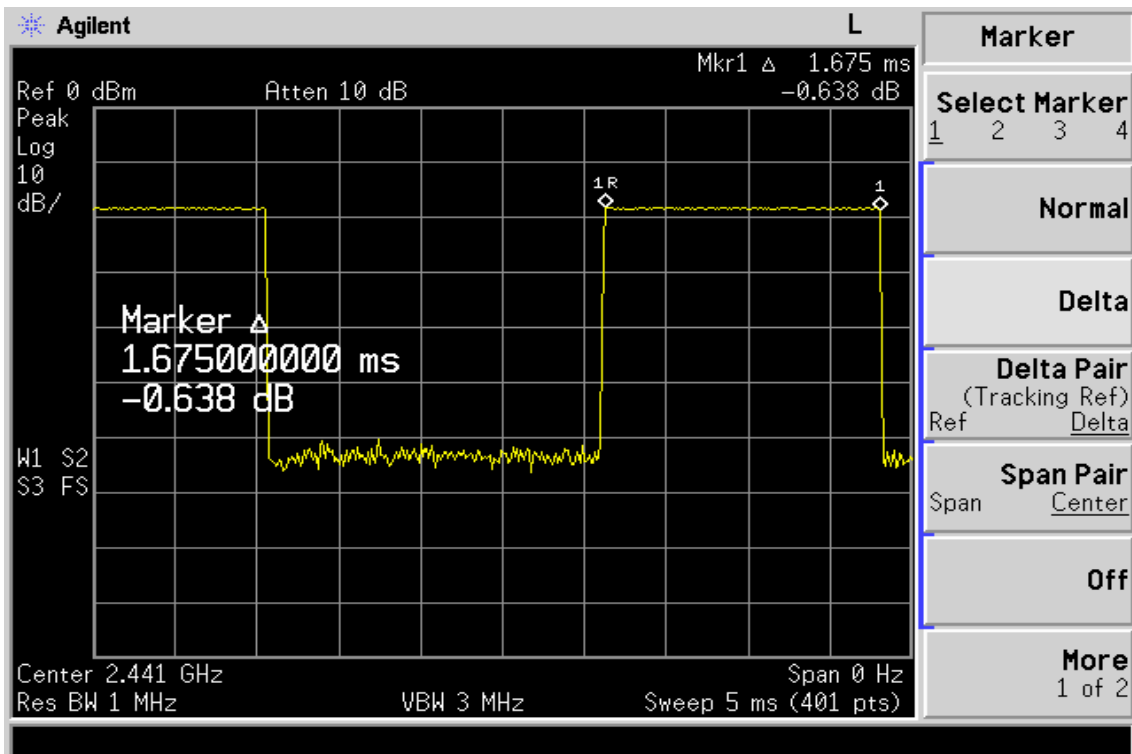

This Test Report is issued by the Company subject to its General Conditions of Service printed overleaf. Attention is drawn to the limitations of liability, indemnification, and Jurisdictional issued defined therein. The results shown in this test report refer only to the sample(s) tested unless otherwise stated. This test report cannot be reproduced, except in full, without prior written permission of the Company. Any unauthorized alteration, forgery or falsification of the content or appearance of this report is unlawful and offenders may be prosecuted to the fullest extent of the law. 此報告是遵循本公司訂定之通用服務條款所製作發放。請注意此條款列印於背面，將本公司之義務，免責，管轄權皆明確規範之。此報告結果除非另有說明僅對檢驗之樣品負責。本報告未經本公司書面許可，不可部份複製。對本報告內容或外觀之任何未經授權之變更、偽造、竄改皆屬非法，違犯者將會被依法追訴。

DH5

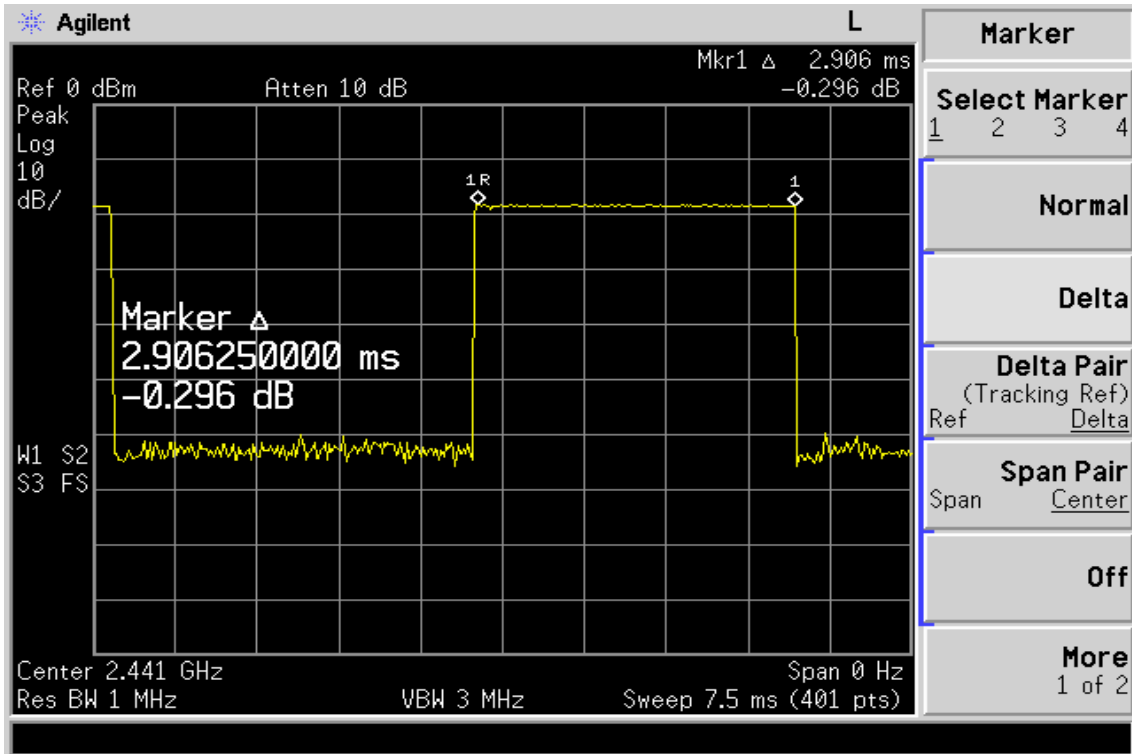

CH-High

DH1

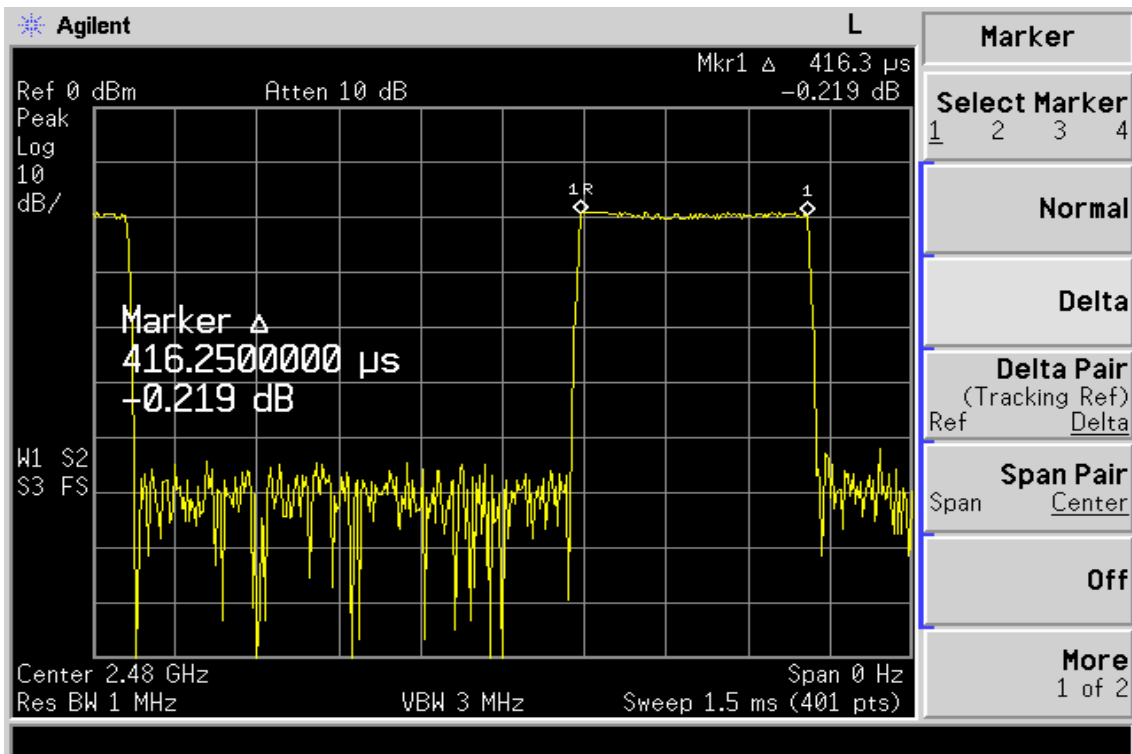

This Test Report is issued by the Company subject to its General Conditions of Service printed overleaf. Attention is drawn to the limitations of liability, indemnification, and Jurisdictional issued defined therein. The results shown in this test report refer only to the sample(s) tested unless otherwise stated. This test report cannot be reproduced, except in full, without prior written permission of the Company. Any unauthorized alteration, forgery or falsification of the content or appearance of this report is unlawful and offenders may be prosecuted to the fullest extent of the law. 此報告是遵循本公司訂定之通用服務條款所製作發放。請注意此條款列印於背面，將本公司之義務，免責，管轄權皆明確規範之。此報告結果除非另有說明僅對檢驗之樣品負責。本報告未經本公司書面許可，不可部份複製。對本報告內容或外觀之任何未經授權之變更、偽造、竄改皆屬非法，違犯者將會被依法追訴。

DH3

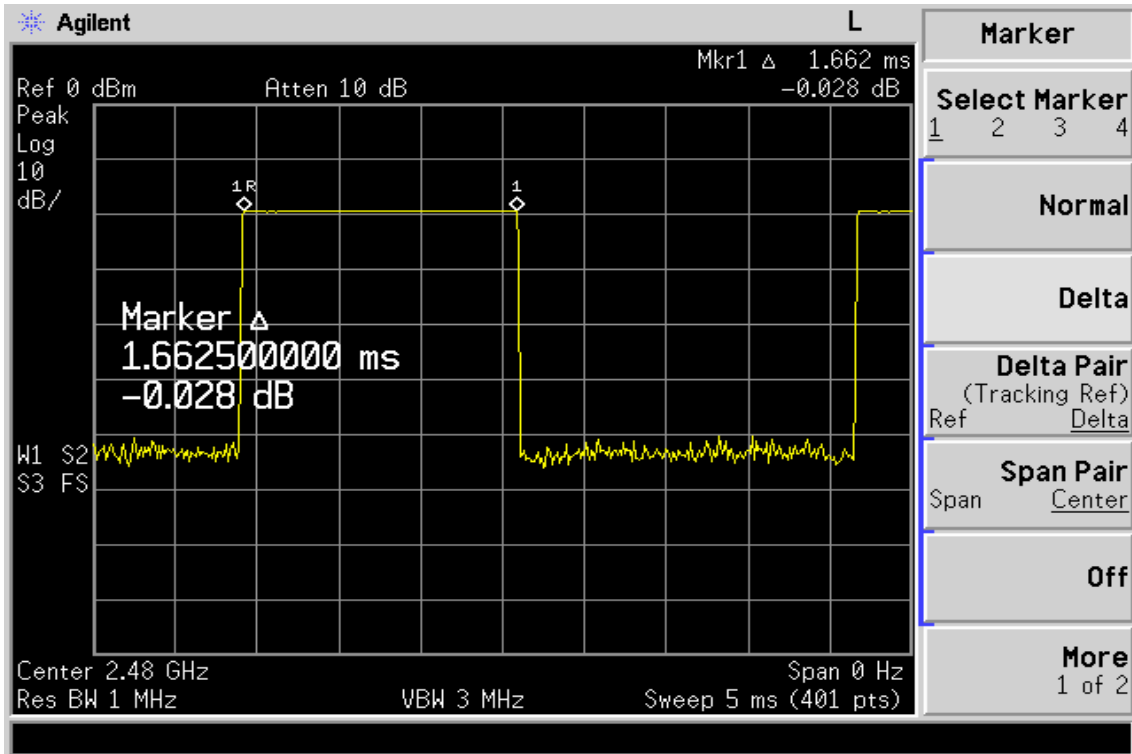

DH5

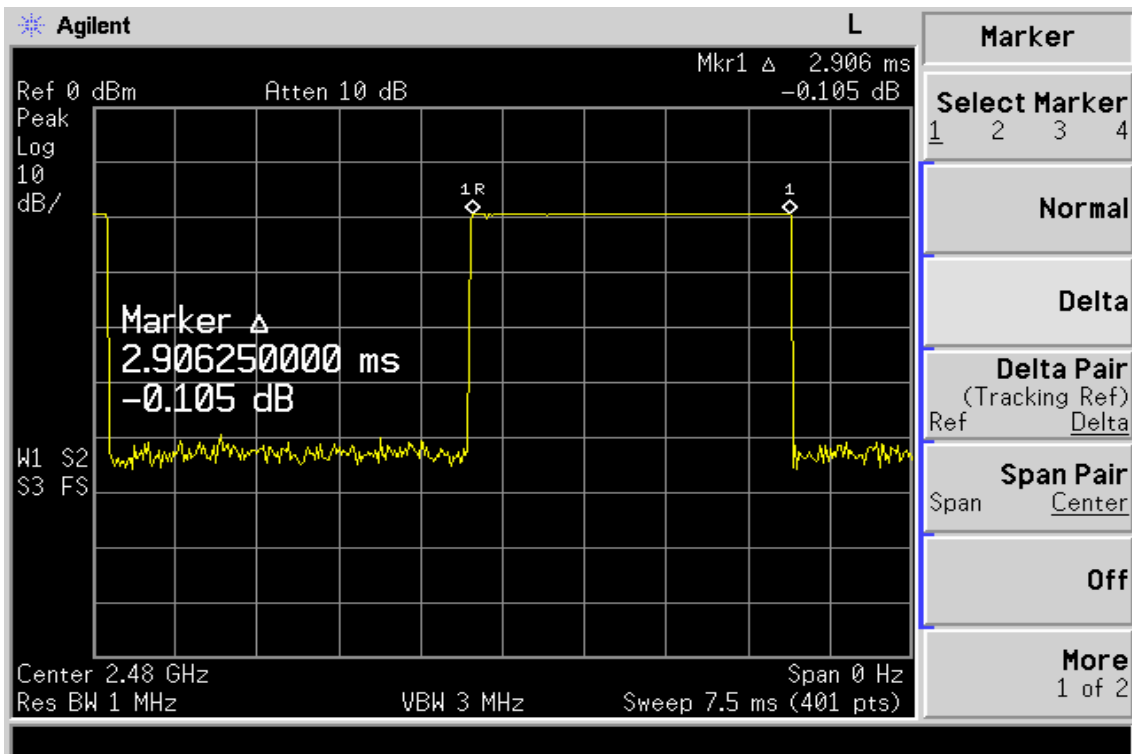

This Test Report is issued by the Company subject to its General Conditions of Service printed overleaf. Attention is drawn to the limitations of liability, indemnification, and Jurisdictional issued defined therein. The results shown in this test report refer only to the sample(s) tested unless otherwise stated. This test report cannot be reproduced, except in full, without prior written permission of the Company. Any unauthorized alteration, forgery or falsification of the content or appearance of this report is unlawful and offenders may be prosecuted to the fullest extent of the law. 此報告是遵循本公司訂定之通用服務條款所製作發放。請注意此條款列印於背面，將本公司之義務，免責，管轄權皆明確規範之。此報告結果除非另有說明僅對檢驗之樣品負責。本報告未經本公司書面許可，不可部份複製。對本報告內容或外觀之任何未經授權之變更、偽造、竄改皆屬非法，違犯者將會被依法追訴。

13. Peak Power Spectral Density

13.1. Standard Applicable

According to §15.247(d), for direct sequence systems, the peak power spectral density conducted from the intentional radiator to the antenna shall not be greater than 8 dBm in any 3kHz band during any time interval of continuous transmission.

13.2. Measurement Procedure

1. Place the EUT on the table and set it in transmitting mode.
2. Remove the antenna from the EUT and then connect a low loss RF cable from the antenna port to the spectrum analyzer.
3. Set the spectrum analyzer as RBW = 3KHz, VBW = 10KHz, Span = 1.5MHz, Sweep=100s
4. Record the max. reading.
5. Repeat above procedures until all frequency measured were complete.

13.3. Measurement Result

CH	RF Power Density Reading (dBm)	Cable loss (dB)	RF Power Density Level (dBm)	Maximum Limit (dBm)
Low	-10.21	0.10	-10.11	8
Mid	-10.35	0.10	-10.25	8
High	-10.36	0.10	-10.26	8

13.4. Measurement Equipment Used:

EQUIPMENT TYPE	MFR	MODEL NUMBER	SERIAL NUMBER	LAST CAL.	CAL DUE.
Spectrum Analyzer	R&S	FSP 40	100034	05/27/2007	05/26/2008
Spectrum Analyzer	Agilent	E7405A	US41160416	08/27/2006	08/27/2007
Spectrum Analyzer	Agilent	E4446A	MY43360126	03/29/2007	03/28/2008
Low Loss Cable	HUBER+SUHNER	SUCOFLEX 104PEA	N/A	N/A	N/A
Attenuator	Mini-Circuit	BW-S6W5	N/A	10/07/2006	10/06/2007

This Test Report is issued by the Company subject to its General Conditions of Service printed overleaf. Attention is drawn to the limitations of liability, indemnification, and Jurisdictional issued defined therein. The results shown in this test report refer only to the sample(s) tested unless otherwise stated. This test report cannot be reproduced, except in full, without prior written permission of the Company. Any unauthorized alteration, forgery or falsification of the content or appearance of this report is unlawful and offenders may be prosecuted to the fullest extent of the law. 此報告是遵循本公司訂定之通用服務條款所製作發放。請注意此條款列印於背面，將本公司之義務，免責，管轄權皆明確規範之。此報告結果除非另有說明僅對檢驗之樣品負責。本報告未經本公司書面許可，不可部份複製。對本報告內容或外觀之任何未經授權之變更、偽造、竄改皆屬非法，違犯者將會被依法追訴。

Power Spectral Density Test Plot (CH-Low)

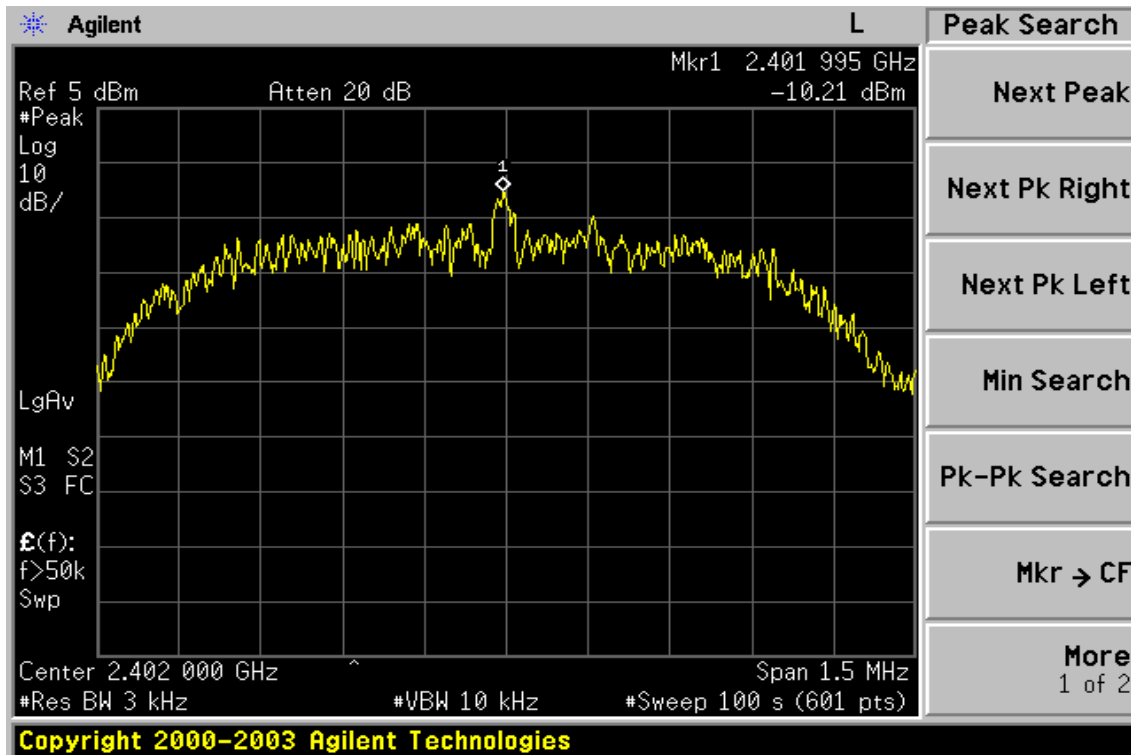

Power Spectral Density Test Plot (CH-Mid)

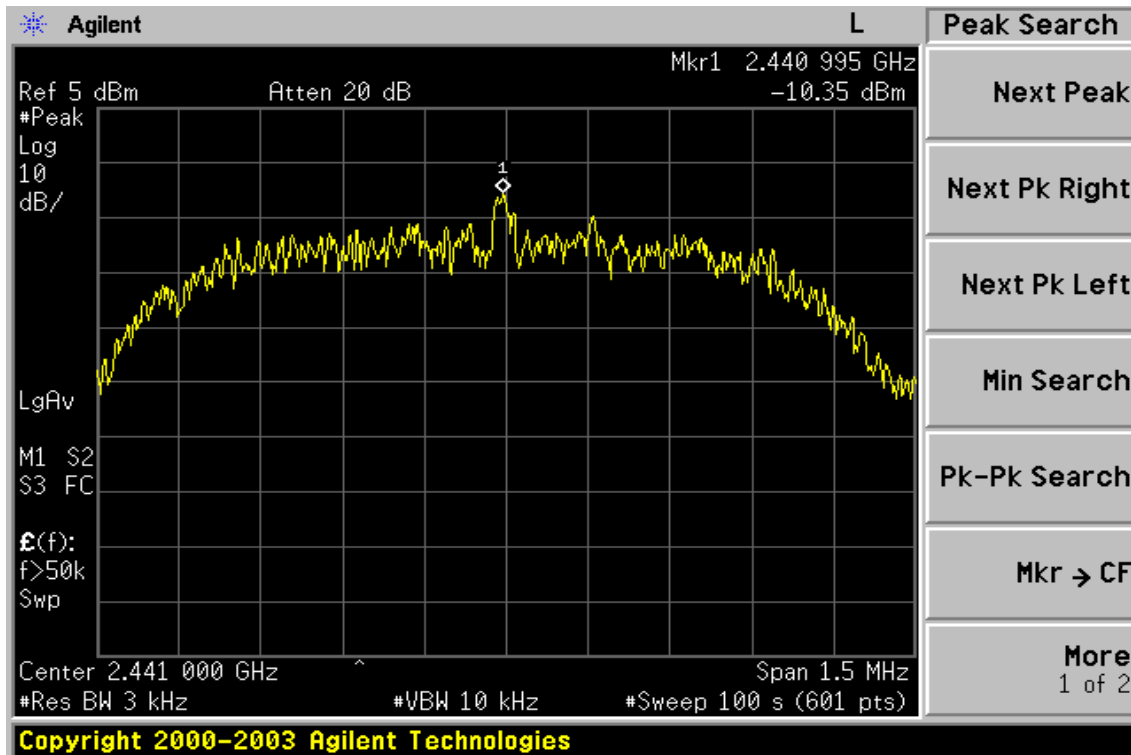

This Test Report is issued by the Company subject to its General Conditions of Service printed overleaf. Attention is drawn to the limitations of liability, indemnification, and Jurisdictional issued defined therein. The results shown in this test report refer only to the sample(s) tested unless otherwise stated. This test report cannot be reproduced, except in full, without prior written permission of the Company. Any unauthorized alteration, forgery or falsification of the content or appearance of this report is unlawful and offenders may be prosecuted to the fullest extent of the law. 此報告是遵循本公司訂定之通用服務條款所製作發放。請注意此條款列印於背面，將本公司之義務，免責，管轄權皆明確規範之。此報告結果除非另有說明僅對檢驗之樣品負責。本報告未經本公司書面許可，不可部份複製。對本報告內容或外觀之任何未經授權之變更、偽造、竄改皆屬非法，違犯者將會被依法追訴。

Power Spectral Density Test Plot (CH-High)

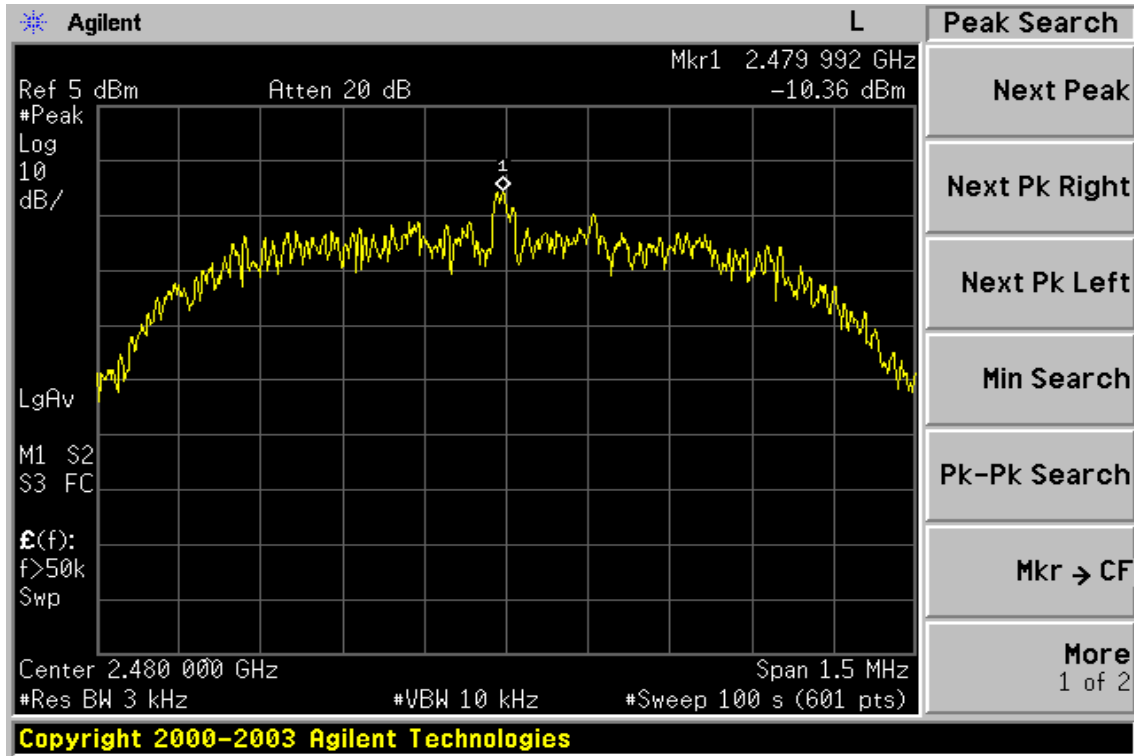

This Test Report is issued by the Company subject to its General Conditions of Service printed overleaf. Attention is drawn to the limitations of liability, indemnification, and Jurisdictional issued defined therein. The results shown in this test report refer only to the sample(s) tested unless otherwise stated. This test report cannot be reproduced, except in full, without prior written permission of the Company. Any unauthorized alteration, forgery or falsification of the content or appearance of this report is unlawful and offenders may be prosecuted to the fullest extent of the law. 此報告是遵循本公司訂定之通用服務條款所製作發放。請注意此條款列印於背面，將本公司之義務，免責，管轄權皆明確規範之。此報告結果除非另有說明僅對檢驗之樣品負責。本報告未經本公司書面許可，不可部份複製。對本報告內容或外觀之任何未經授權之變更、偽造、竄改皆屬非法，違犯者將會被依法追訴。

14. ANTENNA REQUIREMENT

14.1. Standard Applicable

For intentional device, according to §15.203, an intentional radiator shall be designed to ensure that no antenna other than furnished by the responsible party shall be used with the device.

And according to §15.247(4)(1), system operating in the 2400-2483.5MHz bands that are used exclusively for fixed, point-to-point operations may employ transmitting antennas with directional gain greater than 6dBi provided the maximum peak output power of the intentional radiator is reduced by 1 dB for every 3 dB that the directional gain of the antenna exceeds 6 dBi.

14.2. Antenna Connected Construction

The directional gains of antenna used for transmitting is -0.93dBi, and the antenna connector is designed with permanent attachment and no consideration of replacement. Please see EUT photo for details.