



# CTC Laboratories, Inc.

1-2/F., Building 2, Jiaquan Building, Guanlan High-Tech Park, Shenzhen, Guangdong, China  
Tel: +86-755- 27521059 Fax: +86-755- 27521011 Http://www.sz-ctc.com.cn

## TEST REPORT

**Report No.** .....: GTI20190207F-4  
**FCC ID**.....: PADWF129  
**IC** .....: 10563A-WF129  
**Applicant**.....: WAHOO FITNESS L.L.C.  
**Address**.....: 90 W WIEUCA RD NE STE 110 ATLANTA GA 30342  
**Manufacturer**.....: SHENZHEN FENDA SMART TECHNOLOGY LIMITED  
**Address**.....: Fenda Hi-Tech Park,Xhoushi Road Shiyan,Baoan Shenzhen China 518108  
**Product Name**.....: ELEMNT ROAM  
**Trade Mark**.....: N/A  
**Model/Type reference**.....: WFCC4  
**Listed Model(s)** .....: N/A  
**Standard**.....: FCC CFR Title 47 Part 15 Subpart C Section 15.247  
RSS 247 Issue 2  
**Date of receipt of test sample**...: 2019-01-31  
**Date of testing**.....: 2019-01-31 to 2019-02-21  
**Date of issue**.....: 2019-02-21  
**Result**.....: PASS

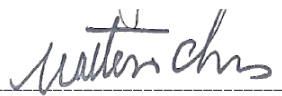
Compiled by:  
(Printed name+signature) Torny Fang   
Supervised by:  
(Printed name+signature) Cary Luo   
Approved by:  
(Printed name+signature) Walter Chen 

**Testing Laboratory Name**..... **Shenzhen General Testing & Inspection Technology Co.,Ltd.**  
**Address**..... 1-2/F., Building 2, Jiaquan Building, Guanlan High-Tech Park,  
Shenzhen, Guangdong, China

This test report may be duplicated completely for legal use with the approval of the applicant. It should not be reproduced except in full, without the written approval of our laboratory. The client should not use it to claim product endorsement by GTI. The test results in the report only apply to the tested sample. The test report shall be invalid without all the signatures of testing engineers, reviewer and approver. Any objections must be raised to GTI within 15 days since the date when the report is received. It will not be taken into consideration beyond this limit. The test report merely correspond to the test sample.



Table of Contents

Page

1. TEST SUMMARY ..... 3

1.1. TEST STANDARDS..... 3

1.2. REPORT VERSION..... 3

1.3. TEST DESCRIPTION..... 4

1.4. TEST FACILITY ..... 5

1.5. MEASUREMENT UNCERTAINTY ..... 5

1.6. ENVIRONMENTAL CONDITIONS ..... 6

2. GENERAL INFORMATION ..... 7

2.1. CLIENT INFORMATION ..... 7

2.2. GENERAL DESCRIPTION OF EUT ..... 7

2.3. OPERATION STATE..... 8

2.4. MEASUREMENT INSTRUMENTS LIST ..... 9

3. TEST ITEM AND RESULTS ..... 11

3.1. CONDUCTED EMISSION..... 11

3.2. RADIATED EMISSION ..... 14

3.3. BAND EDGE EMISSIONS ..... 20

3.4. CHANNEL SEPARATION AND BANDWIDTH ..... 28

3.5. NUMBER OF HOPPING CHANNEL..... 41

3.6. DWELL TIME ..... 44

3.7. PEAK OUTPUT POWER ..... 51

3.8. ANTENNA REQUIREMENT ..... 58

4. EUT TEST PHOTOS ..... 59

5. PHOTOGRAPHS OF EUT CONSTRUCTIONAL ..... 60



# 1. TEST SUMMARY

## 1.1. Test Standards

The tests were performed according to following standards:

[FCC Rules Part 15.247](#): Operation within the bands of 902-928MHz, 2400-2483.5MHz, and 5725-5850MHz.

[RSS 247 Issue 2](#): Standard Specifications for Frequency Hopping Systems (FHSs) and Digital Transmission Systems (DTSs) Operating in the Bands 902-928MHz, 2400-2483.5MHz and 5725-5850MHz.

[ANSI C63.10-2013](#): American National Standard for Testing Unlicensed Wireless Devices.

## 1.2. Report version

Revised No.	Date of issue	Description
01	2019-02-21	Original



### 1.3. Test Description

FCC Part 15 Subpart C(15.247)/ RSS 247 Issue 5				
Test Item	Standard Section		Result	Test Engineer
	FCC	IC		
Antenna Requirement	15.203	/	Pass	Terry Su
Conducted Emission	15.207	RSS-GEN 7.2.2	Pass	Terry Su
Restricted Bands	15.205	RSS-Gen 7.2.3	Pass	Terry Su
Hopping Channel Separation	15.247(a)(1)	RSS 247 5.1 (2)	Pass	Terry Su
Dwell Time	15.247(a)(1)	RSS 247 5.1 (4)	Pass	Terry Su
Peak Output Power	15.247(b)(1)	RSS 247 5.4 (2)	Pass	Terry Su
Number of Hopping Frequency	15.247(b)(1)	RSS 247 5.1 (4)	Pass	Terry Su
Band Edge Emissions	15.247(d)	RSS 247 5.5	Pass	Terry Su
Radiated Spurious Emission	15.247(c)&15.209	RSS 247 5.5	Pass	Terry Su
99% Occupied Bandwidth & 20dB Bandwidth	15.247(a)	RSS 247 5.1 (1)	Pass	Terry Su

Note: The measurement uncertainty is not included in the test result.



## 1.4. Test Facility

### Address of the report laboratory

#### Shenzhen General Testing & Inspection Technology Co., Ltd.

Add: 1-2/F., Building 2, Jiaquan Building, Guanlan High-Tech Park, Shenzhen, Guangdong, China

### Laboratory accreditation

The test facility is recognized, certified, or accredited by the following organizations:

#### CNAS-Lab Code: L5365

Shenzhen General Testing & Inspection Technology Co.,Ltd. has been assessed and proved to be in compliance with CNAS-CL01 Accreditation Criteria for Testing and Calibration Laboratories (identical to ISO/IEC17025: 2005 General Requirements) for the Competence of Testing and Calibration Laboratories.

#### A2LA-Lab Cert. No.: CN1208

Shenzhen General Testing & Inspection Technology Co.,Ltd. EMC Laboratory has been accredited by A2LA for technical competence in the field of electrical testing, and proved to be in compliance with ISO/IEC 17025: 2005 General Requirements for the Competence of Testing and Calibration Laboratories and any additional program requirements in the identified field of testing.

#### IC Registration No.: 9783A-1

The 3m alternate test site of Shenzhen General Testing & Inspection Technology Co.,Ltd. EMC Laboratory has been registered by Certification and Engineer Bureau of Industry Canada for the performance of with Registration NO.: 9783A on Jan, 2016.

#### FCC-Registration No.: 951311

Shenzhen General Testing & Inspection Technology Co.,Ltd. EMC Laboratory has been registered and fully described in a report filed with the (FCC) Federal Communications Commission. The acceptance letter from the FCC is maintained in our files. Registration 951311, Aug 26, 2017

## 1.5. Measurement Uncertainty

The data and results referenced in this document are true and accurate. The reader is cautioned that there may be errors within the calibration limits of the equipment and facilities. The measurement uncertainty was calculated for all measurements listed in this test report acc. to TR-100028-01" Electromagnetic compatibility and Radio spectrum Matters (ERM);Uncertainties in the measurement of mobile radio equipment characteristics; Part 1" and TR-100028-02 "Electromagnetic compatibility and Radio spectrum Matters (ERM);Uncertainties in the measurement of mobile radio equipment characteristics; Part 2 " and is documented in the Shenzhen General Testing & Inspection Technology Co., Ltd. quality system acc. to DIN EN ISO/IEC 17025. Furthermore, component and process variability of devices similar to that tested may result in additional deviation. The manufacturer has the sole responsibility of continued compliance of the device.

Below is the best measurement capability for Shenzhen General Testing & Inspection Technology Co., Ltd.



Test Items	Measurement Uncertainty	Notes
Transmitter power conducted	0.42 dB	(1)
Transmitter power Radiated	2.14 dB	(1)
Conducted spurious emissions 9kHz~40GHz	1.60 dB	(1)
Radiated spurious emissions 9kHz~40GHz	2.20 dB	(1)
Conducted Emissions 9kHz~30MHz	3.20 dB	(1)
Radiated Emissions 30~1000MHz	4.70 dB	(1)
Radiated Emissions 1~18GHz	5.00 dB	(1)
Radiated Emissions 18~40GHz	5.54 dB	(1)
Occupied Bandwidth	-----	(1)

**Note (1):** This uncertainty represents an expanded uncertainty expressed at approximately the 95% confidence level using a coverage factor of k=1.96.

### 1.6. Environmental conditions

During the measurement the environmental conditions were within the listed ranges:

Temperature:	15~35°C
Relative Humidity:	30~60 %
Air Pressure:	950~1050mba



## 2. GENERAL INFORMATION

### 2.1. Client Information

Applicant:	WAHOO FITNESS L.L.C.
Address:	90 W WIEUCA RD NE STE 110 ATLANTA GA 30342
Manufacturer:	SHENZHEN FENDA SMART TECHNOLOGY LIMITED
Address:	Fenda Hi-Tech Park,Xhoushi Road Shiyan,Baoan Shenzhen China 518108

### 2.2. General Description of EUT

Product Name:	ELEMNT ROAM
Model/Type reference:	WFCC4
Marketing Name:	N/A
Listed Model(s):	N/A
Power supply:	Battery powered: 3.8V 2000mAh
Hardware version:	N/A
Software version:	N/A
<b>Bluetooth 4.2+EDR</b>	
Modulation:	GFSK, $\pi/4$ -DQPSK, 8-DPSK
Operation frequency:	2402MHz~2480MHz
Max Peak Output Power:	7.93dBm(GFSK)
Channel number:	79
Channel separation:	1MHz
Antenna type:	PCB Antenna
Antenna gain:	0dBi



### 2.3. Operation state

Operation Frequency List: The EUT has been tested under typical operating condition. The Applicant provides communication tools software to control the EUT for staying in continuous transmitting and receiving mode for testing. BT EDR, 79 channels are provided to the EUT. Channels 00/39/78 were selected for testing.

Operation Frequency List:

Channel	Frequency (MHz)
<b>00</b>	<b>2402</b>
01	2403
⋮	⋮
38	2440
<b>39</b>	<b>2441</b>
40	2442
⋮	⋮
77	2479
<b>78</b>	<b>2480</b>

Note: The display in grey were the channel selected for testing.

Test mode

For RF test items:
The engineering test program was provided and enabled to make EUT continuous transmit
For AC power line conducted emissions:
The EUT was set to connect with the Bluetooth instrument under large package sizes transmission.
For Radiated spurious emissions test item:
The engineering test program was provided and enabled to make EUT continuous transmit. The EUT in each of three orthogonal axis emissions had been tested, but only the worst case (X axis) data recorded in the report.





## 2.4. Measurement Instruments List

Tonscend JS0806-2 Test system						
Item	Test Equipment	Manufacturer	Model No.	Serial No.	Calibrated Date	Calibrated until
1	Spectrum Analyzer	Rohde & Schwarz	FSU26	100105	Jan. 07, 2017	Dec. 28 2019
2	Spectrum Analyzer	Rohde & Schwarz	FUV40-N	101331	Jan. 07, 2017	Dec. 28 2019
3	MXG Vector Signal Generator	Agilent	N5182A	MY47420864	Jan. 07, 2017	Dec. 28 2019
4	Signal Generator	Agilent	E8257D	MY46521908	Jan. 07, 2017	Dec. 28 2019
5	Power Sensor	Agilent	U2021XA	MY5365004	Jan. 07, 2017	Dec. 28 2019
6	Power Sensor	Agilent	U2021XA	MY5365006	Jan. 07, 2017	Dec. 28 2019
7	Simultaneous Sampling DAQ	Agilent	U2531A	TW54493510	Jan. 07, 2017	Dec. 28 2019
8	Climate Chamber	TABAI	PR-4G	A8708055	Jan. 07, 2017	Dec. 28 2019
9	Wideband Radio Communication Tester	Rohde & Schwarz	CMW500	116410	Jan. 06, 2018	Dec. 28 2019
10	Climate Chamber	ESPEC	MT3065	/	Jan. 04,2018	Dec. 28 2019
11	300328 v2.1.1 test system	TONSCEND	v2.6	/	/	/

Item	Test Equipment	Manufacturer	Model No.	Serial No.	Calibrated until
1	EMI Test Receiver	Rohde & Schwarz	ESCI	100658	Dec. 28 2019
2	High pass filter	micro-tranics	HPM50111	142	Dec. 28 2019
3	Log-Bicon Antenna	Schwarzbeck	CBL6141A	4180	Dec. 28 2019
4	Ultra-Broadband Antenna	ShwarzBeck	BBHA9170	25841	Dec. 28 2019
5	Loop Antenna	LAPLAC	RF300	9138	Dec. 28 2019
6	Spectrum Analyzer	Rohde & Schwarz	FSU26	100105	Dec. 28 2019
7	Horn Antenna	Schwarzbeck	BBHA 9120D	647	Dec. 28 2019
8	Pre-Amplifier	HP	8447D	1937A03050	Dec. 28 2019
9	Pre-Amplifier	EMCI	EMC051835	980075	Dec. 28 2019
10	Antenna Mast	UC	UC3000	N/A	N/A
11	Turn Table	UC	UC3000	N/A	N/A
12	Cable Below 1GHz	Schwarzbeck	AK9515E	33155	Dec. 28 2019
13	Cable Above 1GHz	Hubersuhner	SUCOFLEX102	DA1580	Dec. 28 2019
14	Splitter	Mini-Circuit	ZAPD-4	400059	Dec. 28 2019
15	RF Connection Cable	HUBER+SUHNER	RE-7-FL	N/A	Dec. 28 2019
16	RF Connection Cable	Chengdu E-Microwave	---	---	Dec. 28 2019
17	High pass filter	Compliance Direction systems	BSU-6	34202	Dec. 28 2019

CTC Laboratories, Inc

1-2/F., Building 2, Jiaquan Building, Guanlan High-Tech Park, Shenzhen, Guangdong, China  
 Tel.: (86)755-27521059 Fax: (86)755-27521011 Http://www.sz-ctc.org.cn



For anti-fake verification, please visit the official website of Certification and Accreditation Administration of the People's Republic of China: [yz.cncaic.cn](http://yz.cncaic.cn)



18	Attenuator	Chengdu E-Microwave	EMCAXX-10R NZ-3	---	Dec. 28 2019
----	------------	------------------------	--------------------	-----	--------------

Note:1. The Cal. Interval was one year.

2. The cable loss has calculated in test result which connection between each test instruments.

### 3. TEST ITEM AND RESULTS

#### 3.1. Conducted Emission

##### Limit

Conducted Emission Test Limit

Frequency	Maximum RF Line Voltage (dB $\mu$ V)	
	Quasi-peak Level	Average Level
150kHz~500kHz	66 ~ 56 *	56 ~ 46 *
500kHz~5MHz	56	46
5MHz~30MHz	60	50

Notes:

- (1) \*Decreasing linearly with logarithm of the frequency.
- (2) The lower limit shall apply at the transition frequencies.
- (3) The limit decrease in line with the logarithm of the frequency in the range of 0.15 to 0.50MHz.

##### Test Configuration

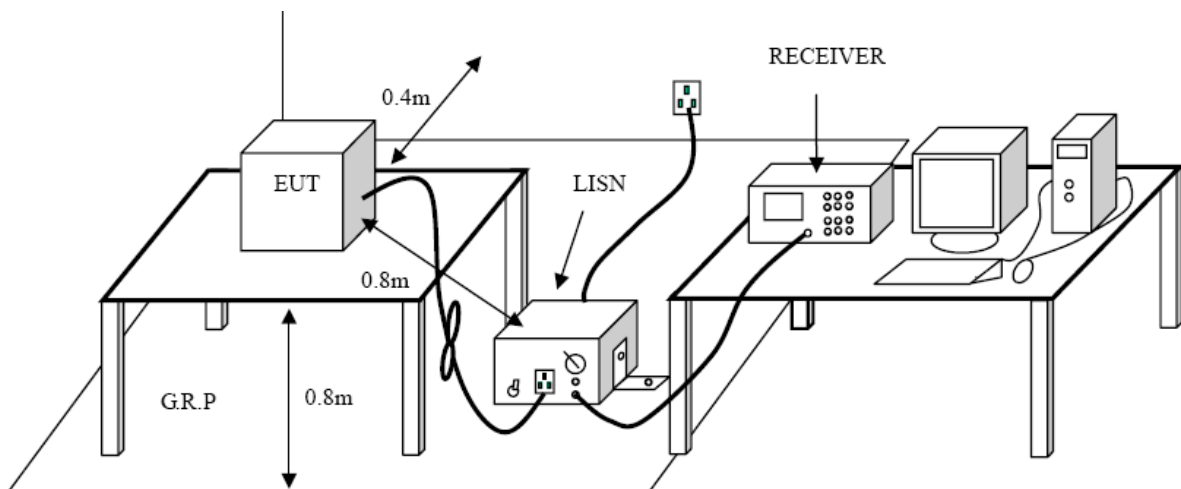

##### Test Procedure

1. The EUT was setup according to ANSI C63.10:2013 requirements.
2. The EUT was placed on a platform of nominal size, 1 m by 1.5 m, raised 80 cm above the conducting ground plane. The vertical conducting plane was located 40 cm to the rear of the EUT. All other surfaces of EUT were at least 80 cm from any other grounded conducting surface.
3. The EUT and simulators are connected to the main power through a line impedances stabilization network (LISN). The LISN provides a 50ohm /50uH coupling impedance for the measuring equipment.  
The peripheral devices are also connected to the main power through a LISN. (Please refer to the block diagram of the test setup and photographs)
4. Each current-carrying conductor of the EUT power cord, except the ground (safety) conductor, was individually connected through a LISN to the input power source.
5. The excess length of the power cord between the EUT and the LISN receptacle were folded back and forth at the center of the lead to form a bundle not exceeding 40 cm in length.
6. Conducted Emissions were investigated over the frequency range from 0.15MHz to 30MHz using a receiver bandwidth of 9 kHz.
7. During the above scans, the emissions were maximized by cable manipulation.



**Test Mode:**

Please refer to the clause 2.2.

**Test Results**

Only show worst adapter data.

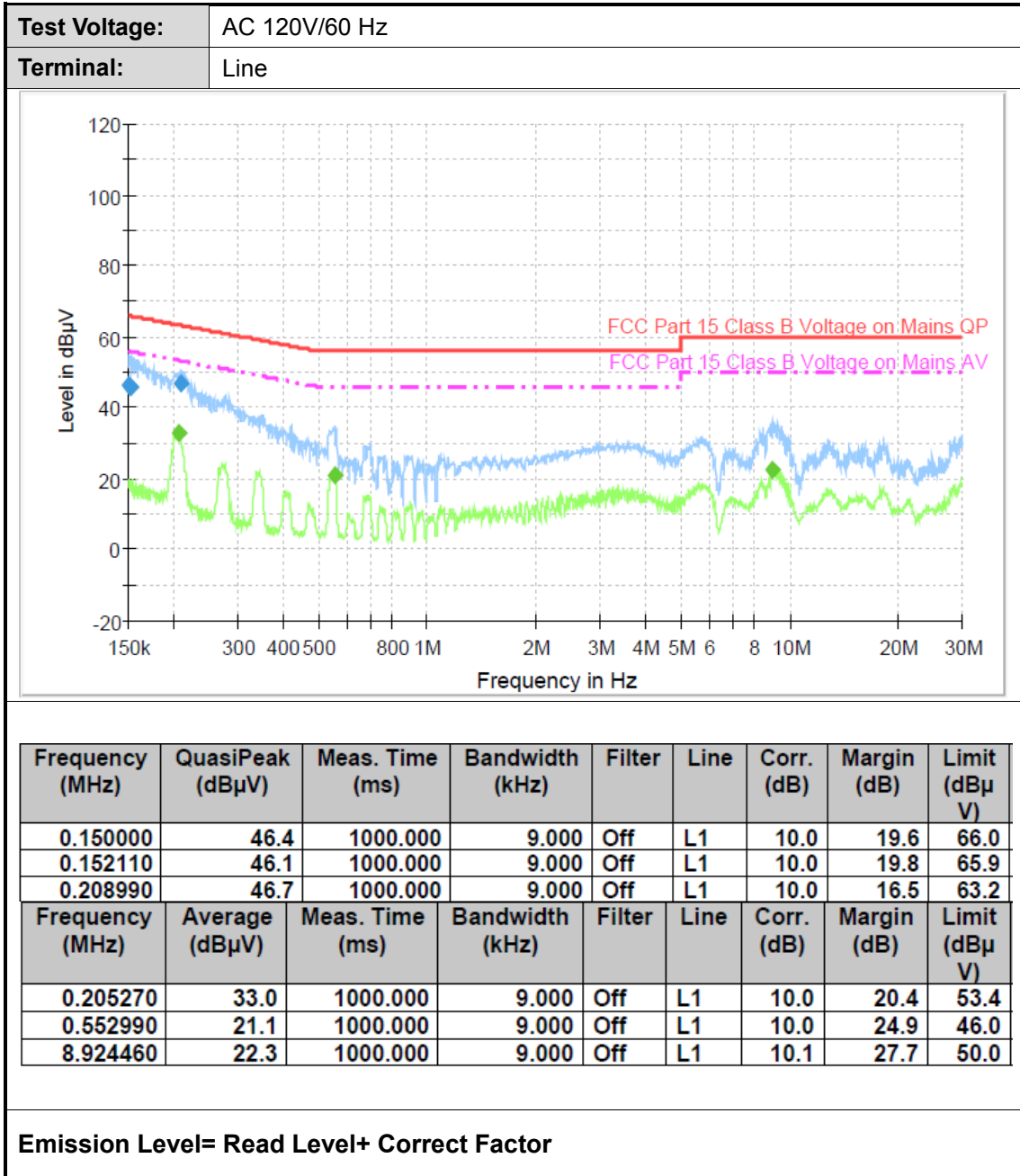

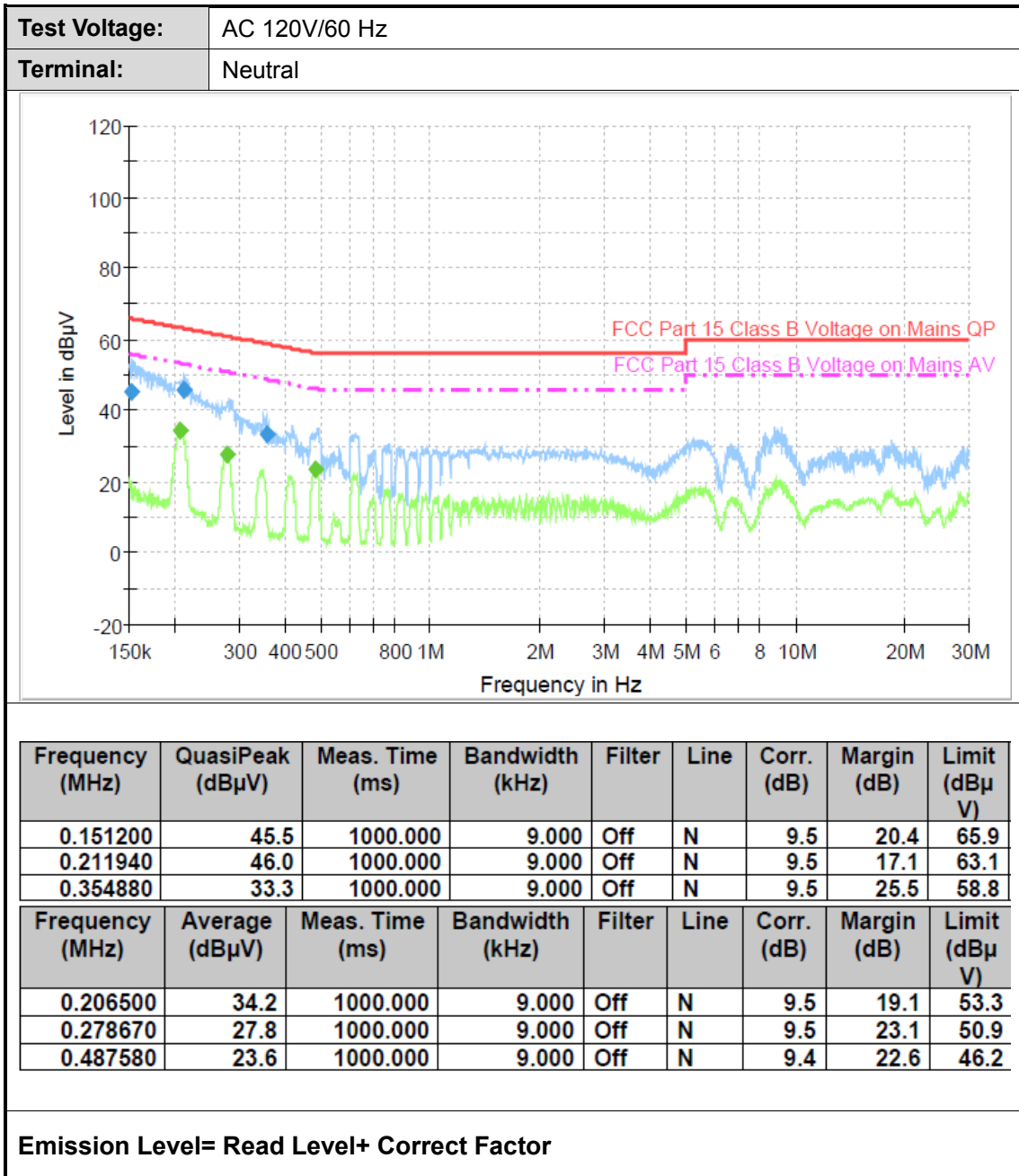

### 3.2. Radiated Emission

Limit

**Radiated Emission Limits (9 kHz~1000 MHz)**

Frequency (MHz)	Field Strength (microvolt/meter)	Measurement Distance (meters)
0.009~0.490	2400/F(KHz)	300
0.490~1.705	24000/F(KHz)	30
1.705~30.0	30	30
30~88	100	3
88~216	150	3
216~960	200	3
Above 960	500	3

**Radiated Emission Limit (Above 1000MHz)**

Frequency (MHz)	Distance Meters(at 3m)	
	Peak	Average
Above 1000	74	54

**Note:**

- (1) The tighter limit applies at the band edges.
- (2) Emission Level (dBuV/m)=20log Emission Level (uV/m).

Test Configuration

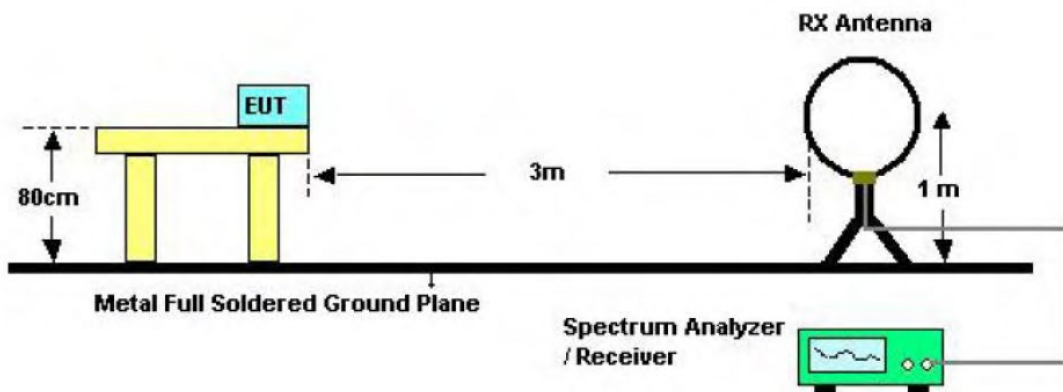

Below 30MHz Test Setup

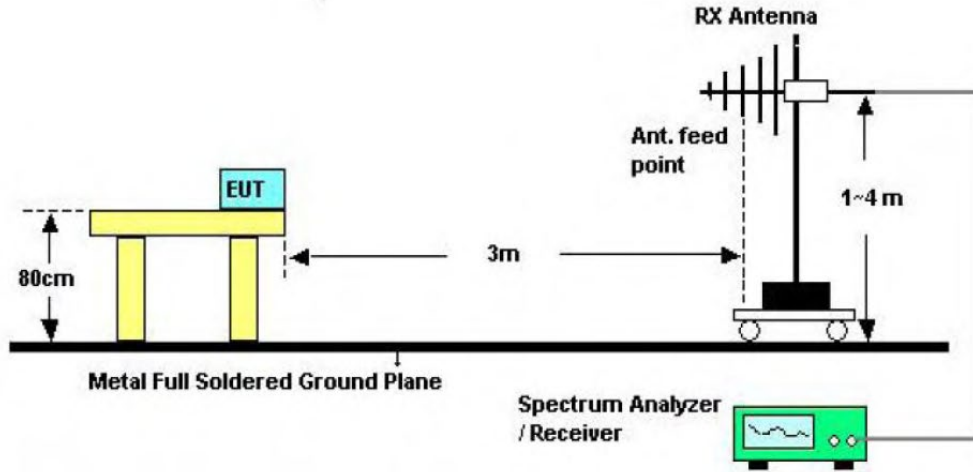

Below Above 1GHz Test Setup

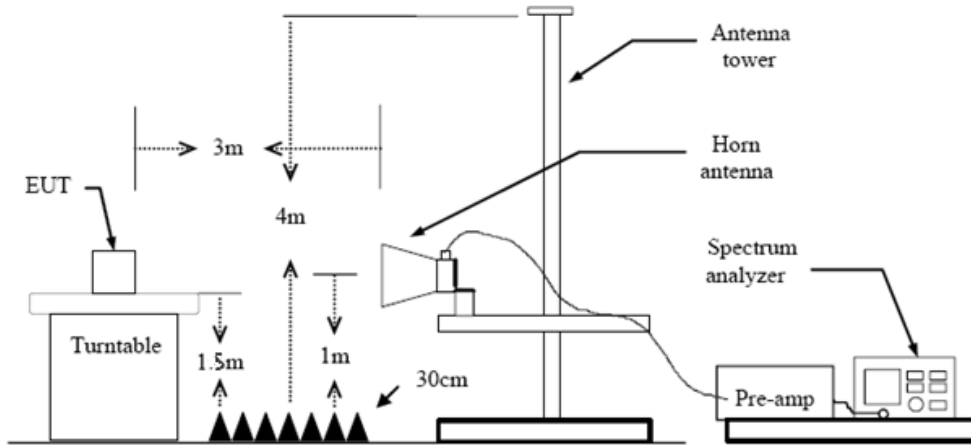

Above 1GHz Test Setup



### **Test Procedure**

1. The EUT was setup and tested according to ANSI C63.10:2013
2. The EUT is placed on a turn table which is 0.8 meter above ground for below 1 GHz, and 1.5 m for above 1 GHz. The turn table is rotated 360 degrees to determine the position of the maximum emission level.
3. The EUT was set 3 meters from the receiving antenna, which was mounted on the top of a variable height antenna tower.
4. For each suspected emission, the EUT was arranged to its worst case and then tune the Antenna tower (from 1 m to 4 m) and turntable (from 0 degree to 360 degrees) to find the maximum reading. A pre-amp and a high pass filter are used for the test in order to get better signal level to comply with the guidelines.
5. Set to the maximum power setting and enable the EUT transmit continuously.
6. Use the following spectrum analyzer settings
  - (1) Span shall wide enough to fully capture the emission being measured;
  - (2) Below 1 GHz:  
RBW=120 kHz, VBW=300 kHz, Sweep=auto, Detector function=peak, Trace=max hold;  
If the emission level of the EUT measured by the peak detector is 3 dB lower than the applicable limit, the peak emission level will be reported. Otherwise, the emission measurement will be repeated using the quasi-peak detector and reported.
  - (3) From 1 GHz to 10<sup>th</sup> harmonic:  
RBW=1MHz, VBW=3MHz Peak detector for Peak value.  
RBW=1MHz, VBW=3MHz RMS detector for Average value.

### **Test Mode**

Please refer to the clause 2.2.

### **Test Result**

#### **9 KHz~30 MHz**

From 9 KHz to 30 MHz: Conclusion: PASS

Note: The amplitude of spurious emissions which are attenuated by more than 20dB below the permissible value has no need to be reported.





30MHz-1GHz

Only show worse case:GFSK

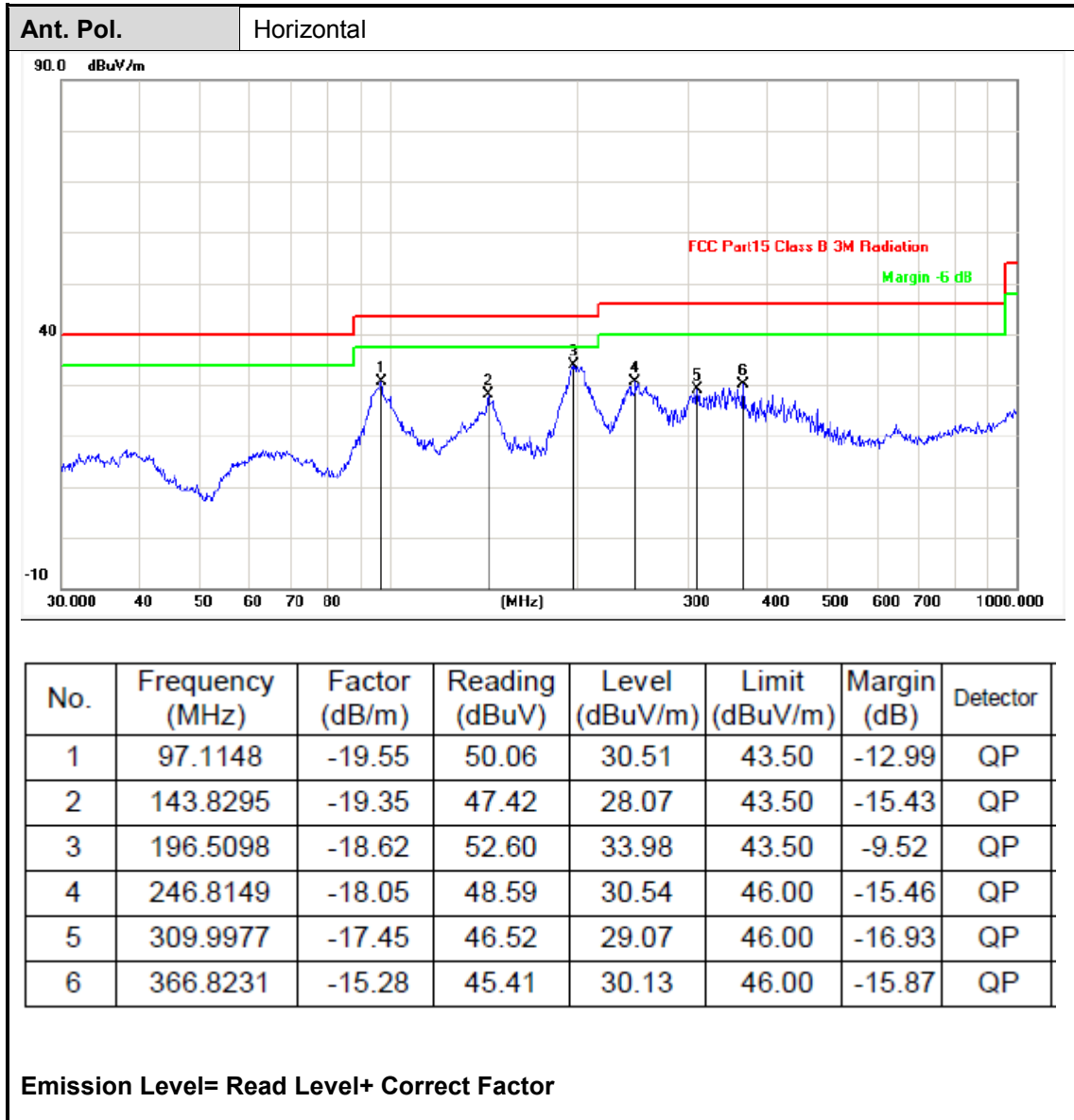

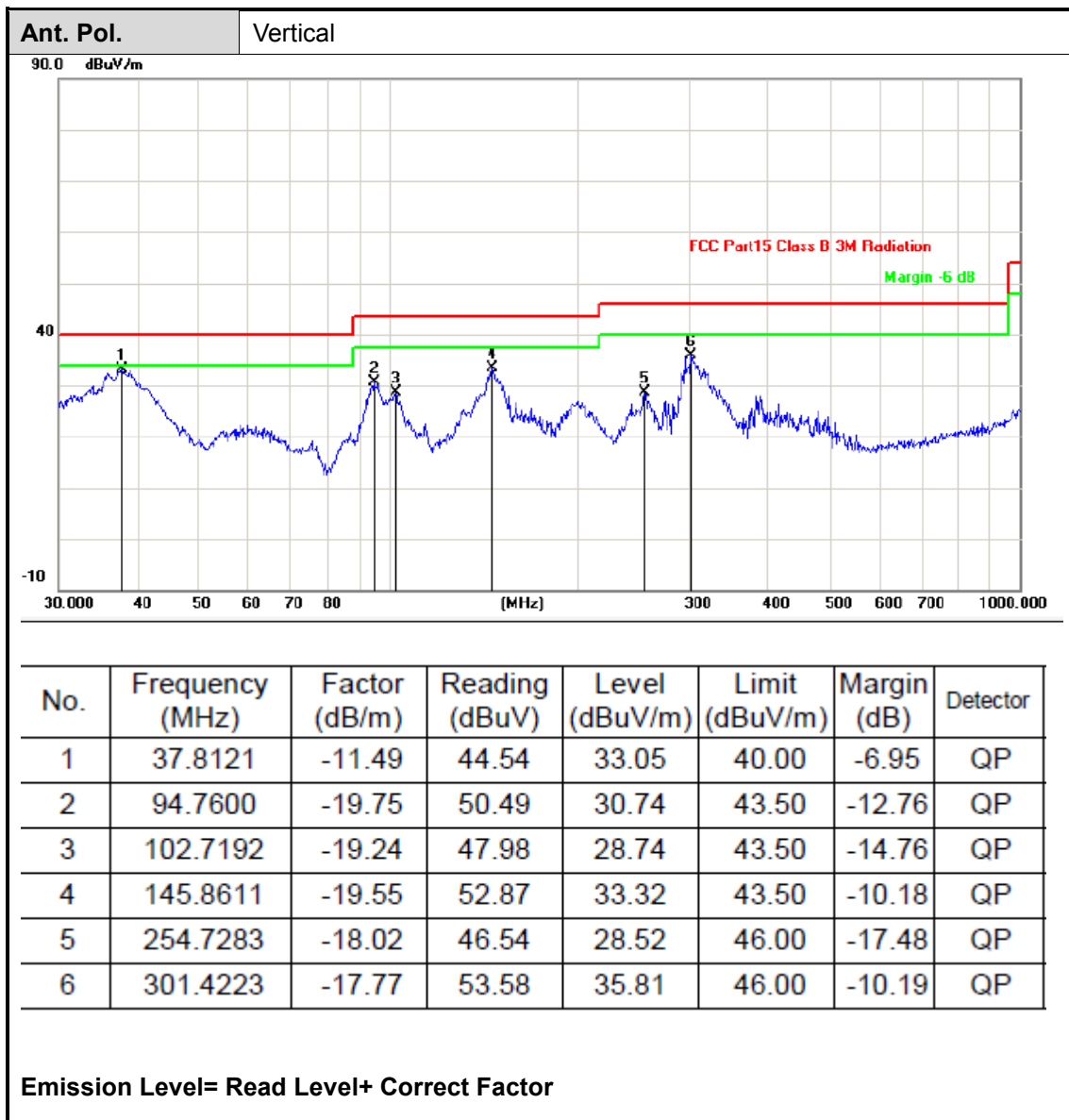

**Adobe 1GHz****Only show worse case:GFSK****No report for the emission which more than 10 dB below the prescribed limit.**

Test Mode: EDR - 2402MHz							
Frequency (MHz)	Reading (dBuV)	Antenna Factor (dB/m)	Level (dBuV/m)	Limit (dBuV/m)	Margin (dB)	Antenna Pole (V/H)	Remark
4804	45.36	3.09	48.45	74	-25.55	V	peak
7206	43.58	5.21	48.79	74	-25.21	V	peak
4804	45.89	3.09	48.98	74	-25.02	H	peak
7206	43.64	5.21	48.85	74	-25.15	H	peak

Remark:

- 1.Factor (dB/m) = Antenna Factor (dB/m)+Cable Factor (dB)-Pre-amplifier Factor
- 2.Margin value = Level -Limit value

Test Mode: EDR - 2441MHz							
Frequency (MHz)	Reading (dBuV)	Antenna Factor (dB/m)	Level (dBuV/m)	Limit (dBuV/m)	Margin (dB)	Antenna Pole (V/H)	Remark
4882	44.32	3.37	47.69	74	-26.31	V	peak
7323	43.26	5.56	48.82	74	-25.18	V	peak
4882	44.55	3.37	47.92	74	-26.08	H	peak
4882	44.32	3.37	47.69	74	-26.31	V	peak

Remark:

- 1.Factor (dB/m) = Antenna Factor (dB/m)+Cable Factor (dB)-Pre-amplifier Factor
- 2.Margin value = Level -Limit value

Test Mode: EDR - 2480MHz							
Frequency (MHz)	Reading (dBuV)	Antenna Factor (dB/m)	Level (dBuV/m)	Limit (dBuV/m)	Margin (dB)	Antenna Pole (V/H)	Remark
4960	43.29	3.44	46.73	74	-27.27	V	peak
7440	45.38	5.64	51.02	74	-22.98	V	peak
4960	46.28	3.44	49.72	74	-24.28	H	peak
7440	43.64	5.64	49.28	74	-24.72	H	peak

Remark:

- 1.Factor (dB/m) = Antenna Factor (dB/m)+Cable Factor (dB)-Pre-amplifier Factor
- 2.Margin value = Level -Limit value

### 3.3. Band Edge Emissions

**Limit**

Restricted Frequency Band (MHz)	(dBuV/m)(at 3m)	
	Peak	Average
2310 ~2390	74	54
2483.5 ~2500	74	54

**Note: All restriction bands have been tested, only the worst case is reported.**

**Test Configuration**

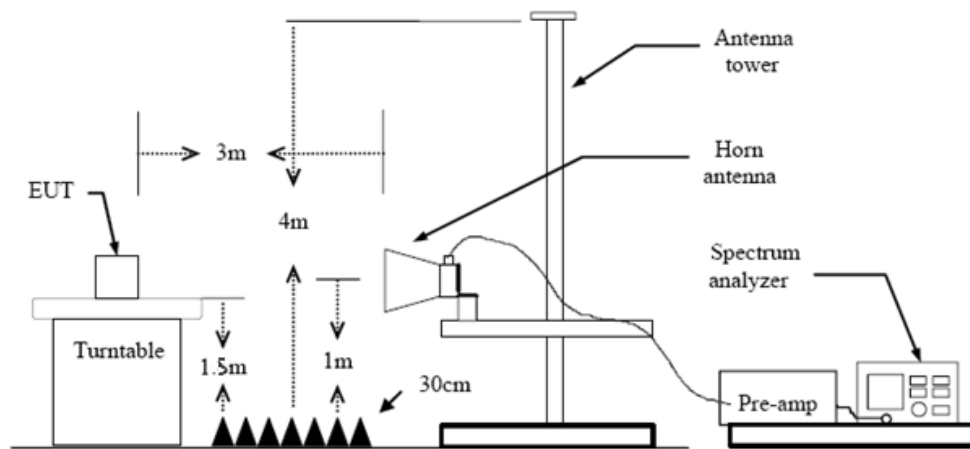

**Test Procedure**

1. The EUT was setup and tested according to ANSI C63.10:2013 requirements.
2. The EUT is placed on a turn table which is 1.5 meter above ground. The turn table is rotated 360 degrees to determine the position of the maximum emission level.
3. The EUT was positioned such that the distance from antenna to the EUT was 3 meters.
4. The antenna is scanned from 1 meter to 4 meters to find out the maximum emission level. This is repeated for both horizontal and vertical polarization of the antenna. In order to find the maximum emission, all of the interface cables were manipulated according to ANSI C63.10:2013 on radiated measurement.
5. The receiver set as follow:  
 RBW=1MHz, VBW=3MHz PEAK detector for Peak value.  
 RBW=1MHz, VBW=10Hz with PEAK Detector for Average Value.

**Test Mode**

Please refer to the clause 2.2.

**Test Results**



## (1) Radiation Test

Only show worse case:GFSK

EDR				2402MHz			
Frequency (MHz)	Read Level (dBuV)	Factor (dB/m)	Level (dBuV/m)	Limit Line (dBuV/m)	Margin (dB)	Polarization	Test value
2390	52.31	3.28	55.59	74	-18.41	Vertical	Peak
2400	51.12	3.85	54.97	74	-19.03	Vertical	Peak
2390	53.34	3.02	56.36	74	-17.64	Horizontal	Peak
2400	51.15	3.67	54.82	74	-19.18	Horizontal	Peak
2390	44.38	3.28	47.66	54	-6.34	Vertical	Average
2400	43.64	3.85	47.49	54	-6.51	Vertical	Average
2390	43.56	3.02	46.58	54	-7.42	Horizontal	Average
2400	42.38	3.67	46.05	54	-7.95	Horizontal	Average

EDR				2480MHz			
Frequency (MHz)	Read Level (dBuV)	Factor (dB/m)	Level (dBuV/m)	Limit Line (dBuV/m)	Margin (dB)	Polarization	Test value
2483.5	51.23	3.79	55.02	74	-18.98	Vertical	Peak
2500	49.35	4.09	53.44	74	-20.56	Vertical	Peak
2483.5	51.23	3.65	54.88	74	-19.12	Horizontal	Peak
2500	52.36	3.95	56.31	74	-17.69	Horizontal	Peak
2483.5	41.33	3.79	45.12	54	-8.88	Vertical	Average
2500	41.68	4.09	45.77	54	-8.23	Vertical	Average
2483.5	41.24	3.65	44.89	54	-9.11	Horizontal	Average
2500	42.23	3.95	46.18	54	-7.82	Horizontal	Average

Remark:

- 1.Factor (dB/m) = Antenna Factor (dB/m)+Cable Factor (dB)-Pre-amplifier Factor
- 2.Margin value = Level -Limit value



(2) Conducted Test

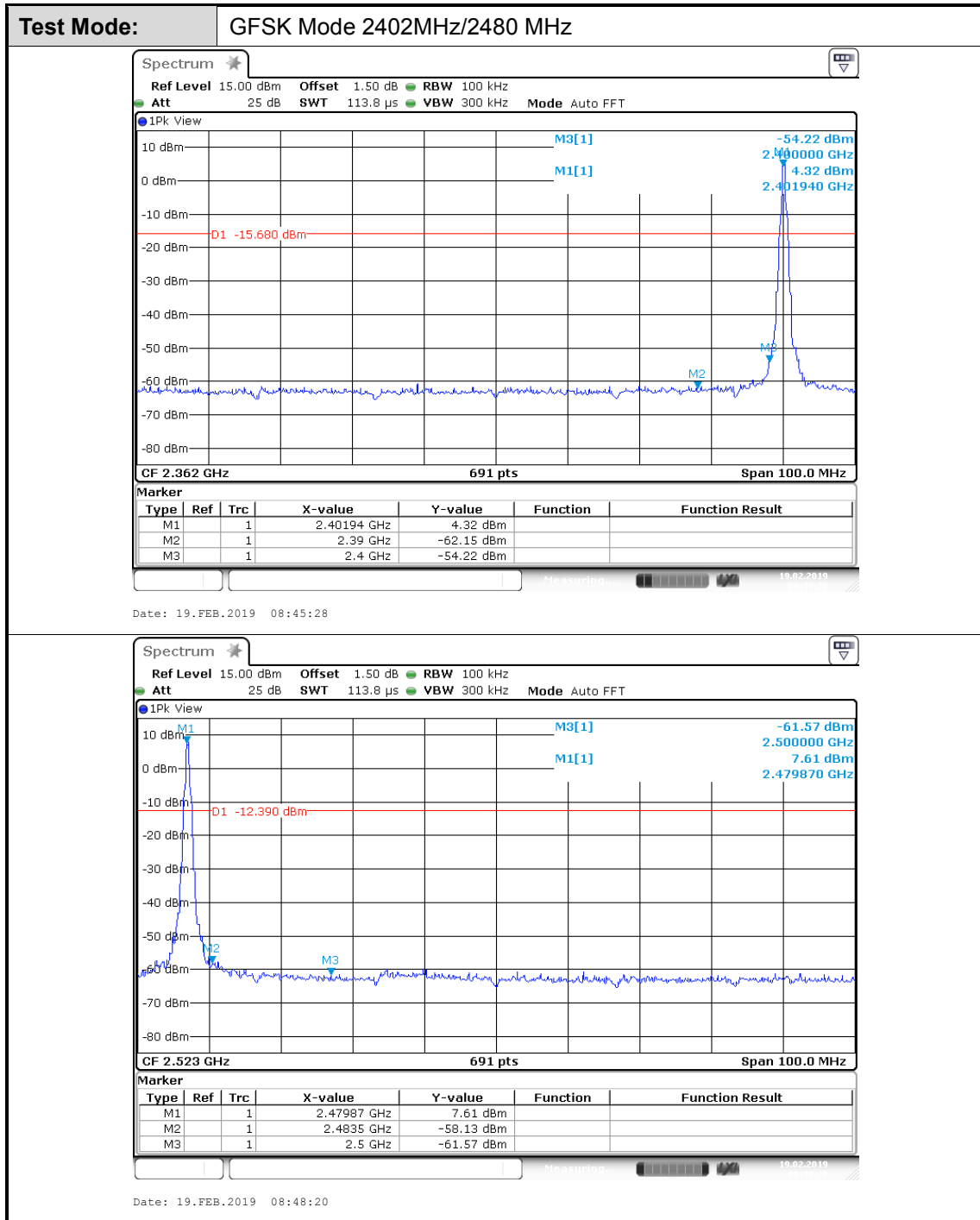

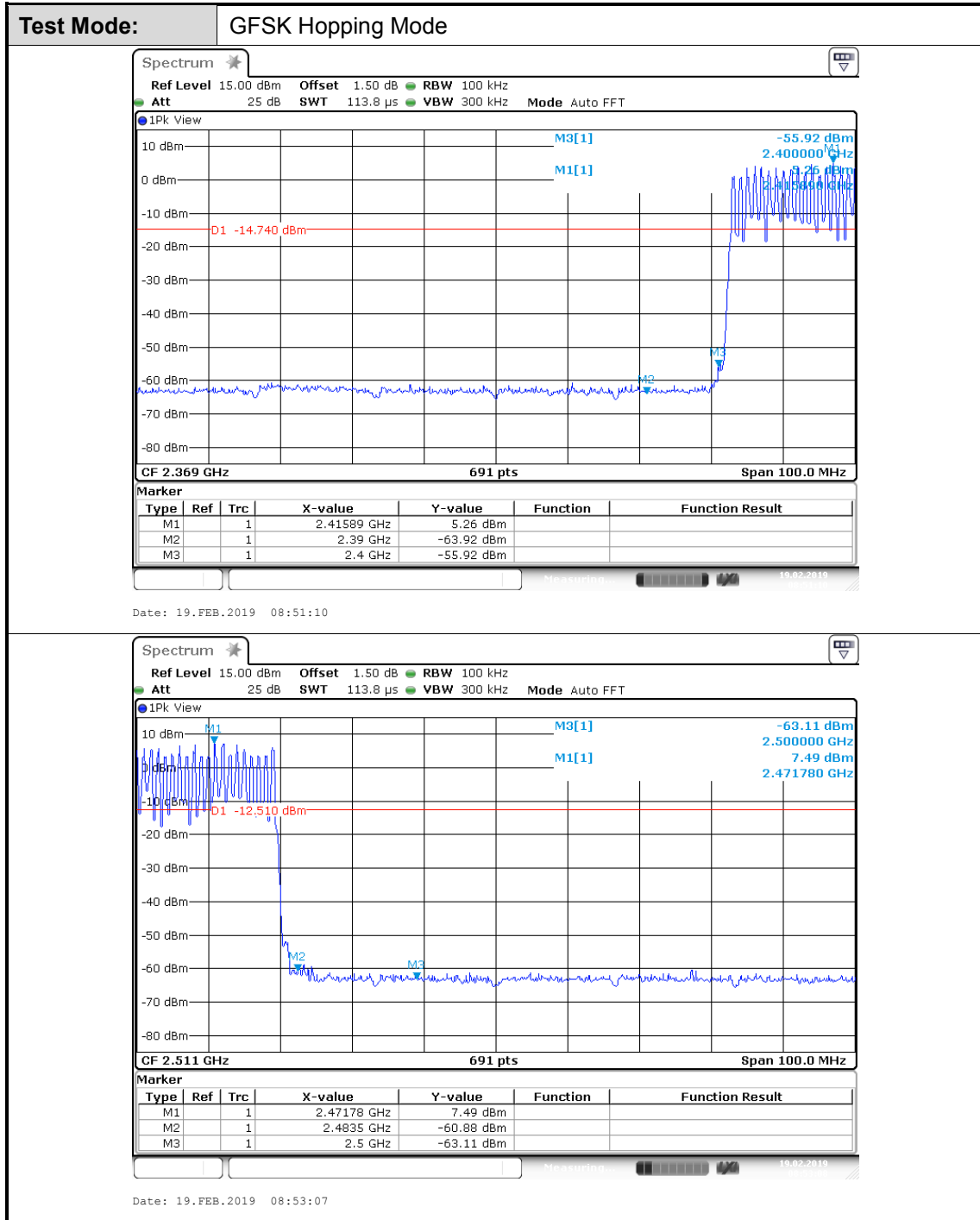

CTC Laboratories, Inc

1-2/F., Building 2, Jiaquan Building, Guanlan High-Tech Park, Shenzhen, Guangdong, China  
 Tel.: (86)755-27521059 Fax: (86)755-27521011 Http://www.sz-ctc.org.cn



For anti-fake verification, please visit the official website of Certification and Accreditation Administration of the People's Republic of China : [yz.cncaic.cn](http://yz.cncaic.cn)

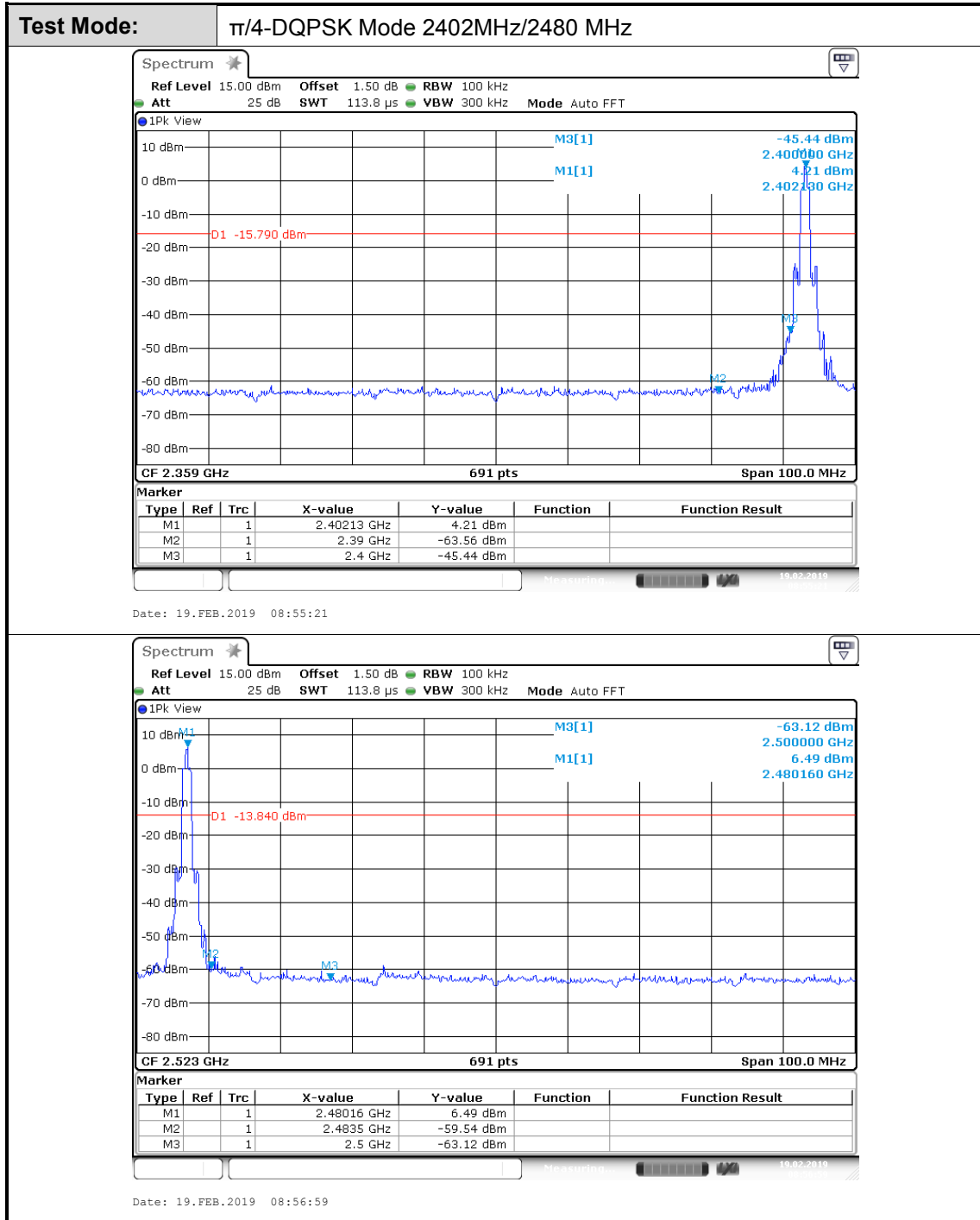



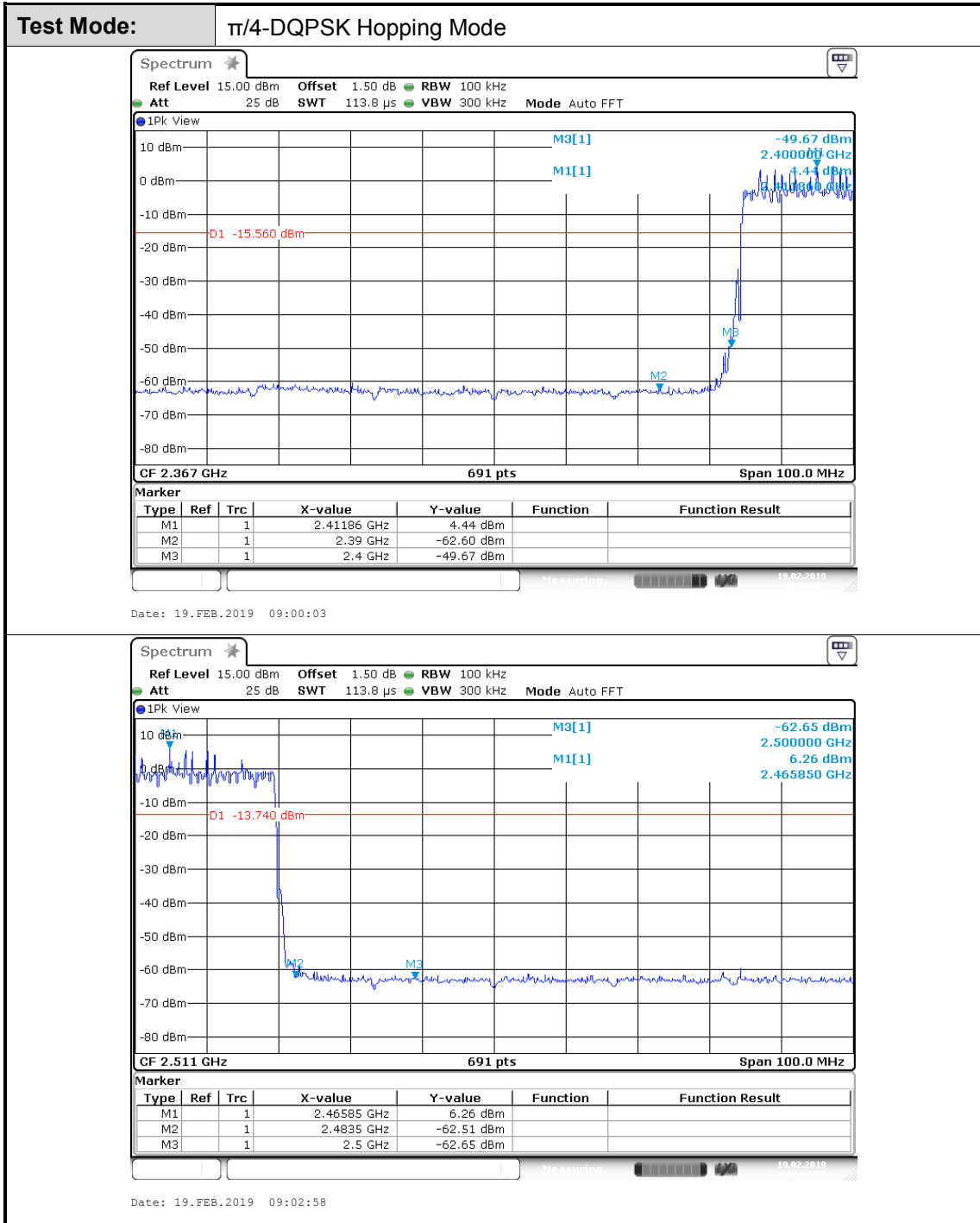

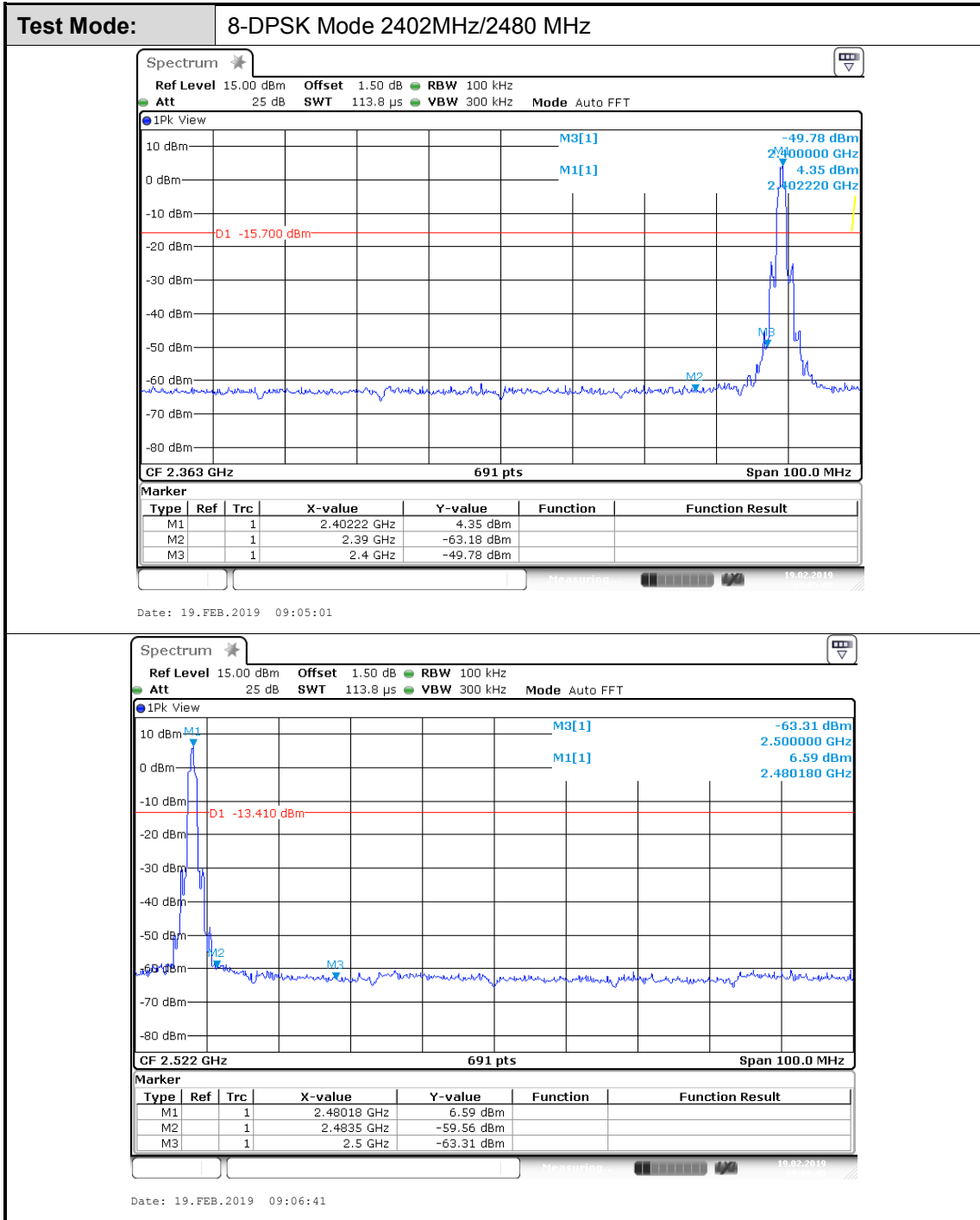

CTC Laboratories, Inc

1-2/F., Building 2, Jiaquan Building, Guanlan High-Tech Park, Shenzhen, Guangdong, China  
Tel.: (86)755-27521059 Fax: (86)755-27521011 Http://www.sz-ctc.org.cn



For anti-fake verification, please visit the official website of Certification and Accreditation Administration of the People's Republic of China: [yz.cncaic.cn](http://yz.cncaic.cn)

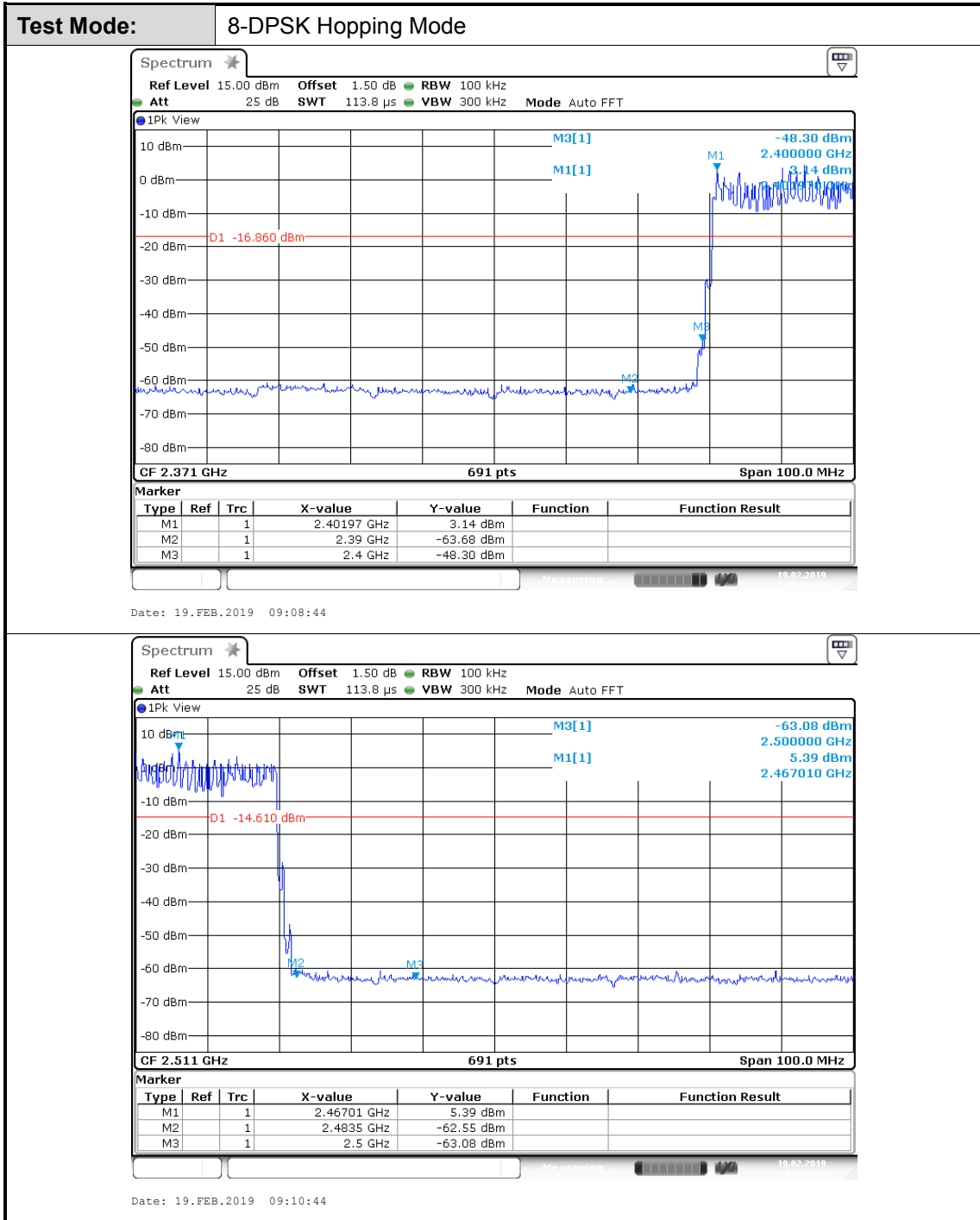

CTC Laboratories, Inc

1-2/F., Building 2, Jiaquan Building, Guanlan High-Tech Park, Shenzhen, Guangdong, China  
Tel.: (86)755-27521059 Fax: (86)755-27521011 Http://www.sz-ctc.org.cn



For anti-fake verification, please visit the official website of Certification and Accreditation Administration of the People's Republic of China : [yz.cncaic.cn](http://yz.cncaic.cn)

### 3.4. Channel Separation and Bandwidth

#### Limit

Test Item	Limit	Frequency Range(MHz)
Bandwidth	$\leq 1$ MHz (20dB bandwidth)	2400~2483.5
Channel Separation	$>25$ KHz or $>$ two-thirds of the 20 dB bandwidth Which is greater	2400~2483.5

#### Test Configuration

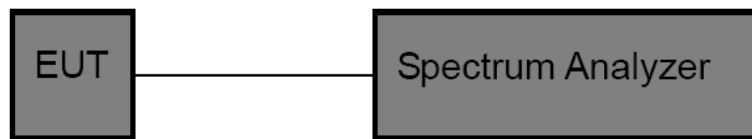

#### Test Procedure

1. The EUT was directly connected to the spectrum analyzer and antenna output port as show in the block diagram above.
2. Spectrum Setting:
  - (1) Set RBW = 100 kHz.
  - (2) Set the video bandwidth (VBW)  $\geq 3$  RBW.
  - (3) Detector = Peak.
  - (4) Trace mode = Max hold.
  - (5) Sweep = Auto couple.

NOTE: The EUT was set to continuously transmitting in each mode and low, Middle and high channel for the test.

#### Test Mode

Please refer to the clause 2.2.

#### Test Results

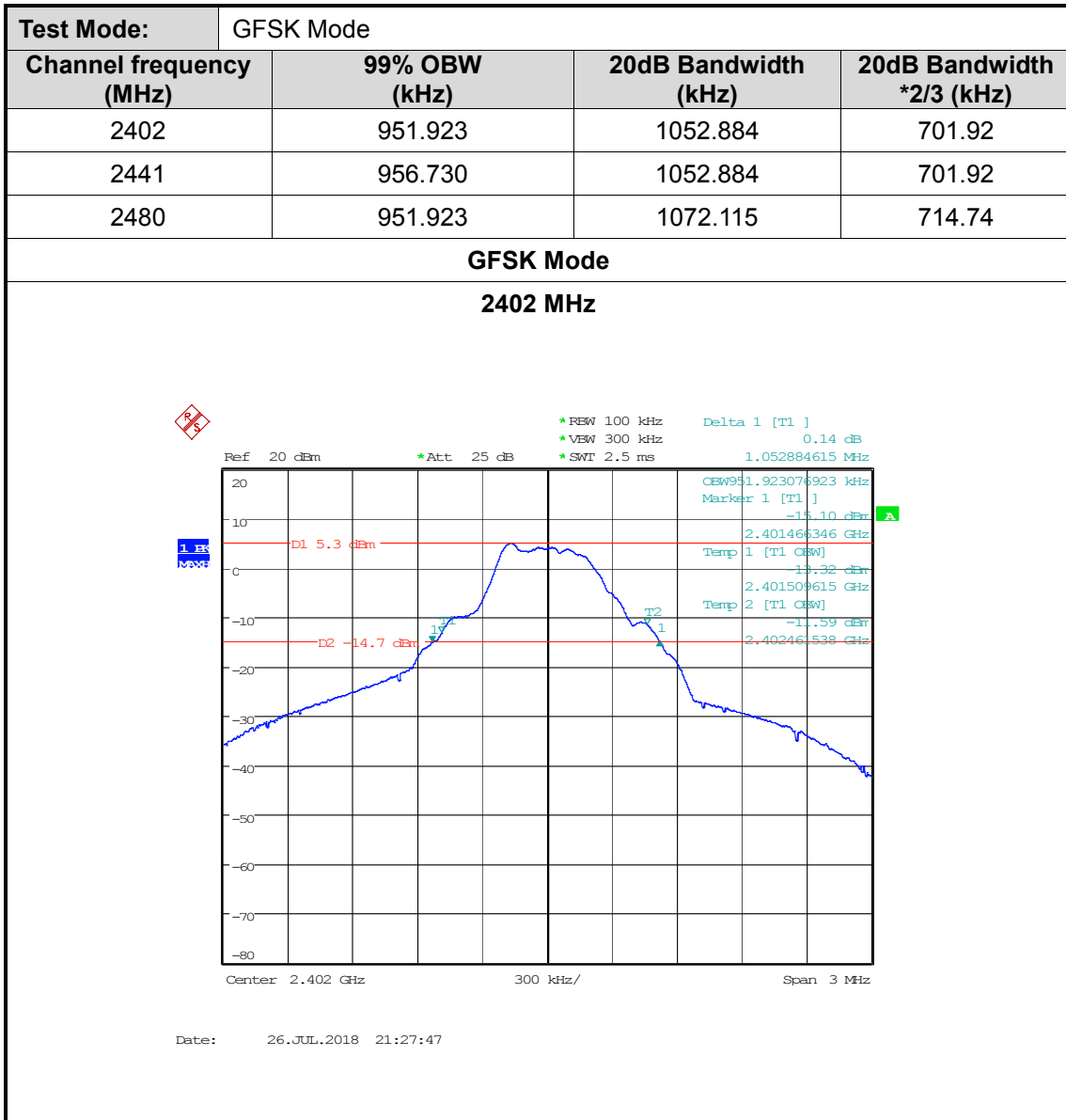

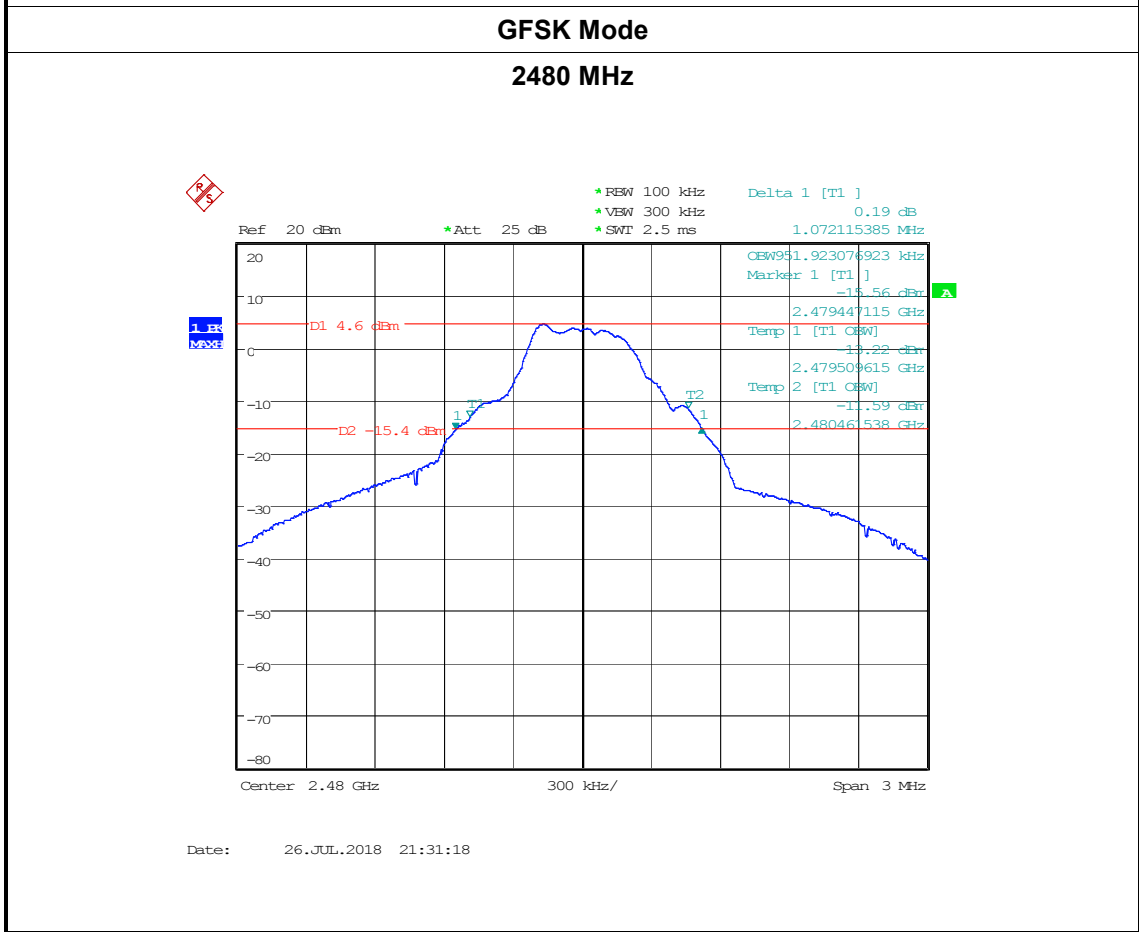
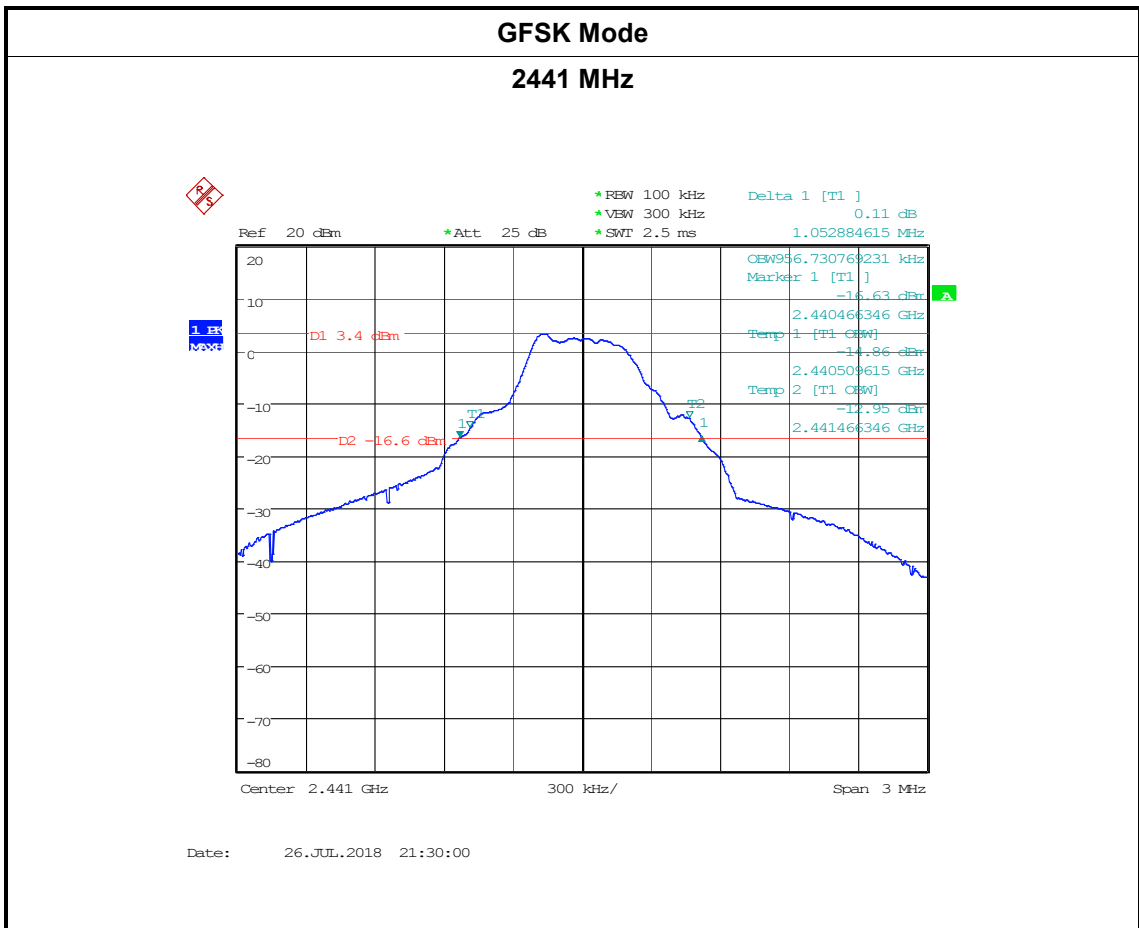

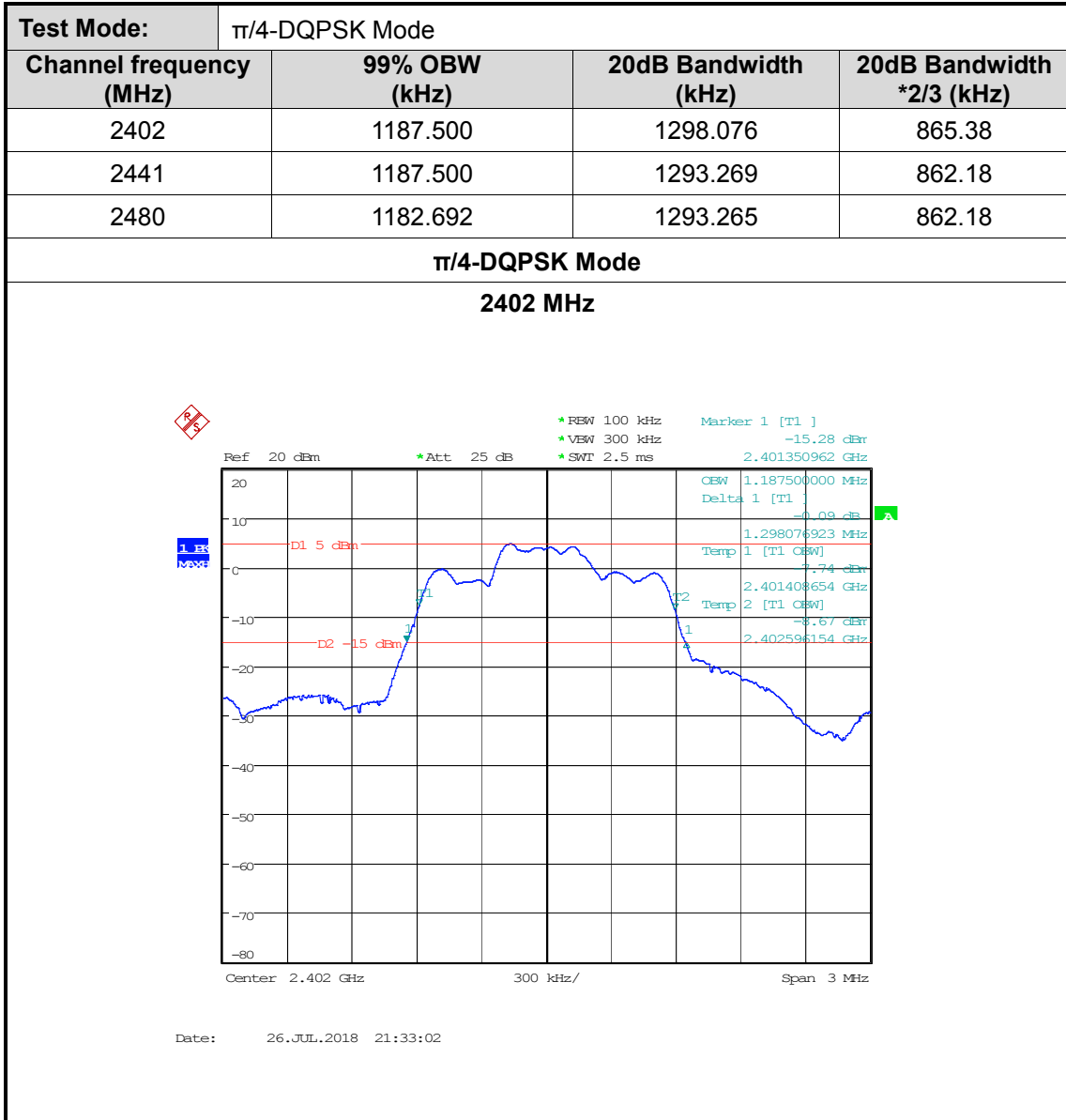



### $\pi/4$ -DQPSK Mode

#### 2441 MHz

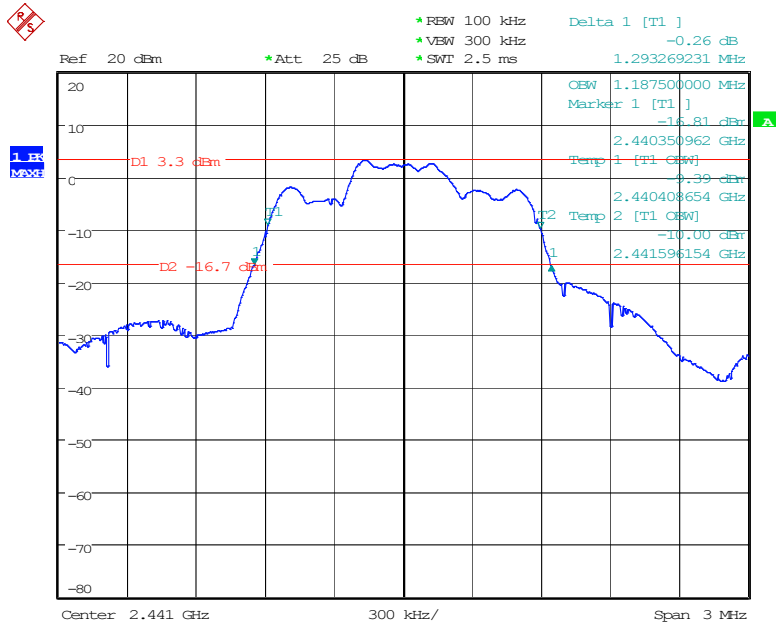

Date: 26.JUL.2018 21:34:24

### $\pi/4$ -DQPSK Mode

#### 2480 MHz

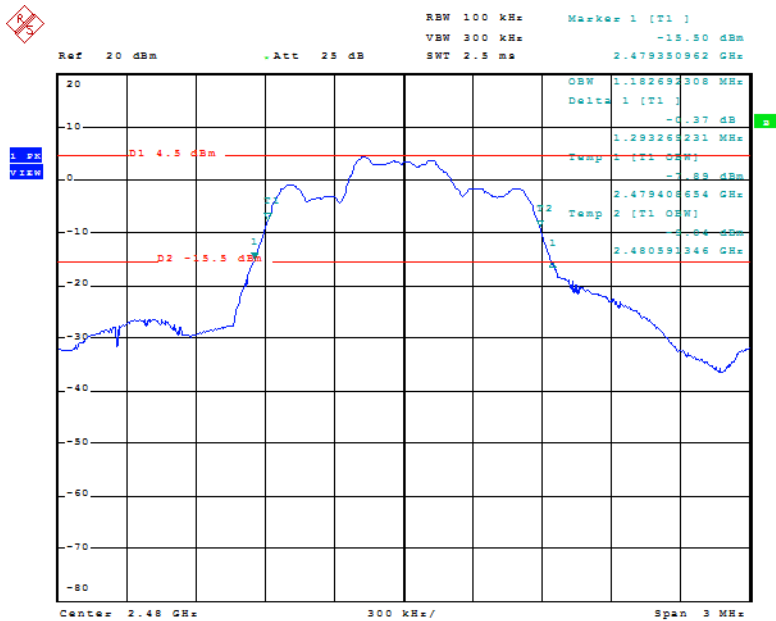

Date: 29.JUL.2018 15:45:04

CTC Laboratories, Inc

1-2/F., Building 2, Jiaquan Building, Guanlan High-Tech Park, Shenzhen, Guangdong, China  
 Tel.: (86)755-27521059      Fax: (86)755-27521011      Http://www.sz-ctc.org.cn



For anti-fake verification, please visit the official website of Certification and Accreditation Administration of the People's Republic of China: [yz.cncaic.cn](http://yz.cncaic.cn)





<b>Test Mode:</b>	8-DPSK Mode		
<b>Channel frequency (MHz)</b>	<b>99% OBW (kHz)</b>	<b>20dB Bandwidth (kHz)</b>	<b>20dB Bandwidth *2/3 (kHz)</b>
2402	1216.346	1322.115	881.41
2441	1216.346	1322.115	881.41
2480	1206.730	1317.307	878.20

**8-DPSK Mode**

**2402 MHz**

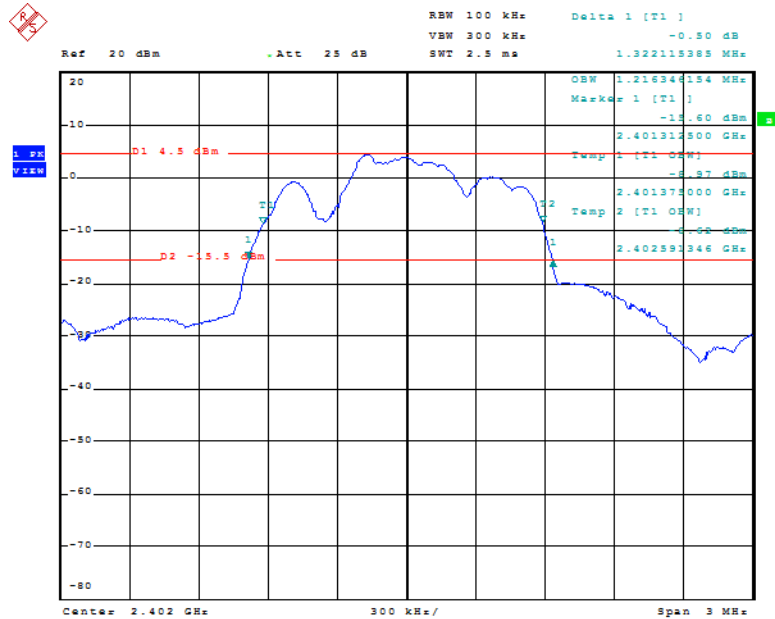

Date: 29.JUL.2018 15:47:57



### 8-DPSK Mode

### 2441 MHz

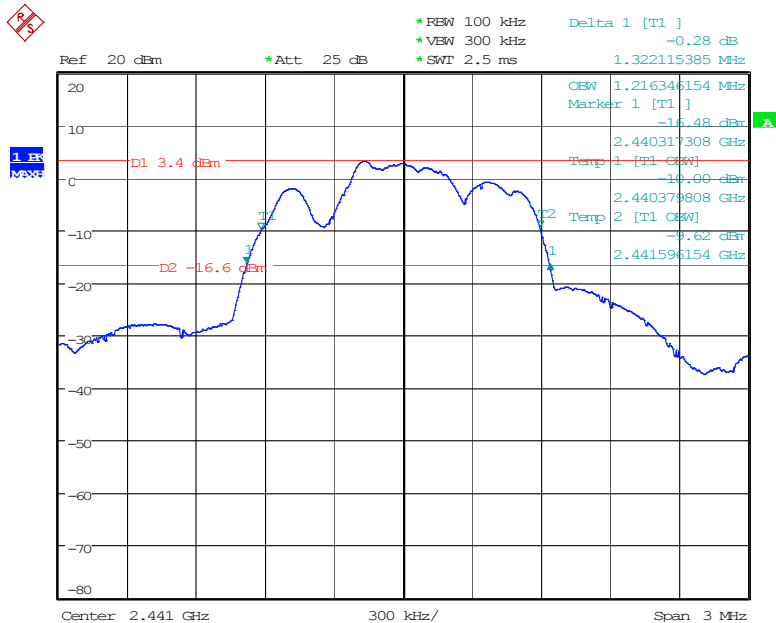

Date: 26.JUL.2018 21:39:25

### 8-DPSK Mode

### 2480 MHz

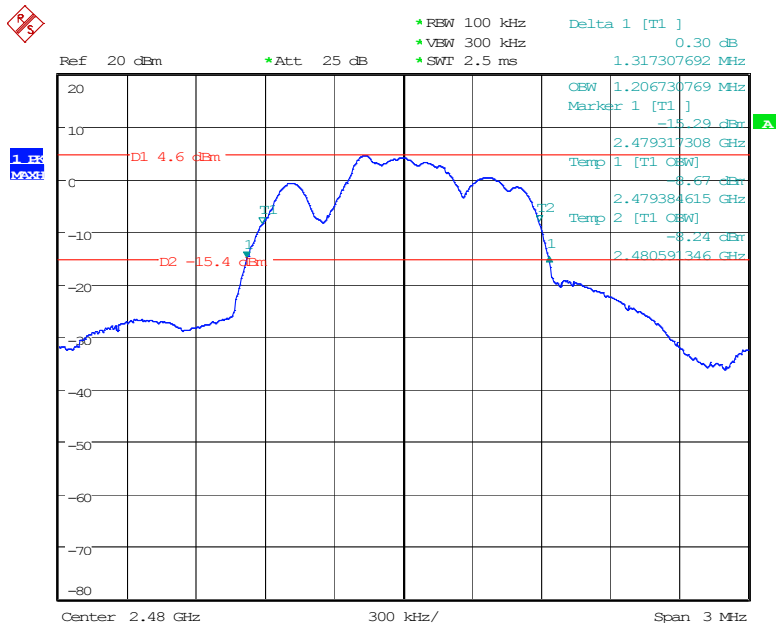

Date: 26.JUL.2018 21:40:55

CTC Laboratories, Inc

1-2/F., Building 2, Jiaquan Building, Guanlan High-Tech Park, Shenzhen, Guangdong, China  
Tel.: (86)755-27521059      Fax: (86)755-27521011      Http://www.sz-ctc.org.cn



For anti-fake verification, please visit the official website of Certification and Accreditation Administration of the People's Republic of China: [yz.cncaic.cn](http://yz.cncaic.cn)



<b>Test Mode:</b>	GFSK Hopping Mode	
<b>Channel frequency (MHz)</b>	<b>Separation Read Value (kHz)</b>	<b>Separation Limit (kHz)</b>
2402	1000.00	701.92
2441	1000.00	701.92
2480	1000.00	714.74

**GFSK Hopping Mode**

**2402 MHz**

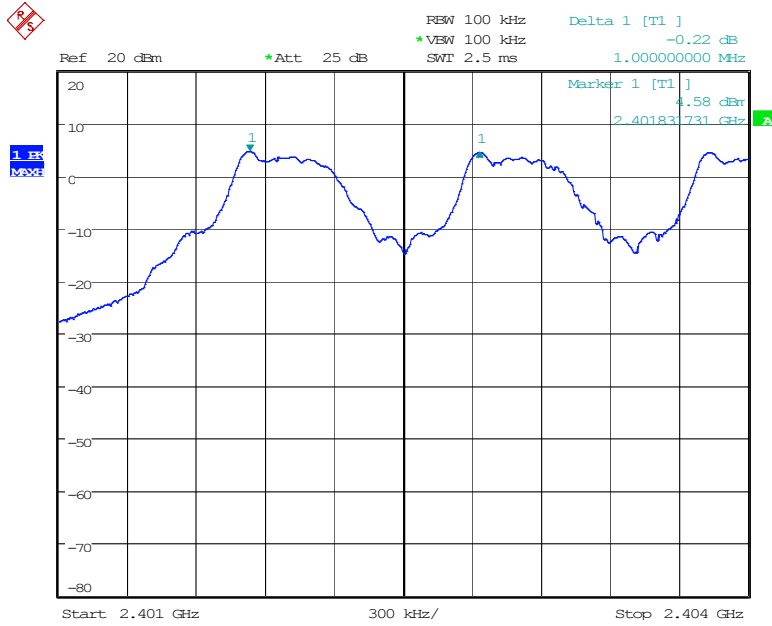

Date: 27.JUL.2018 10:36:45



### GFSK Hopping Mode

#### 2441 MHz

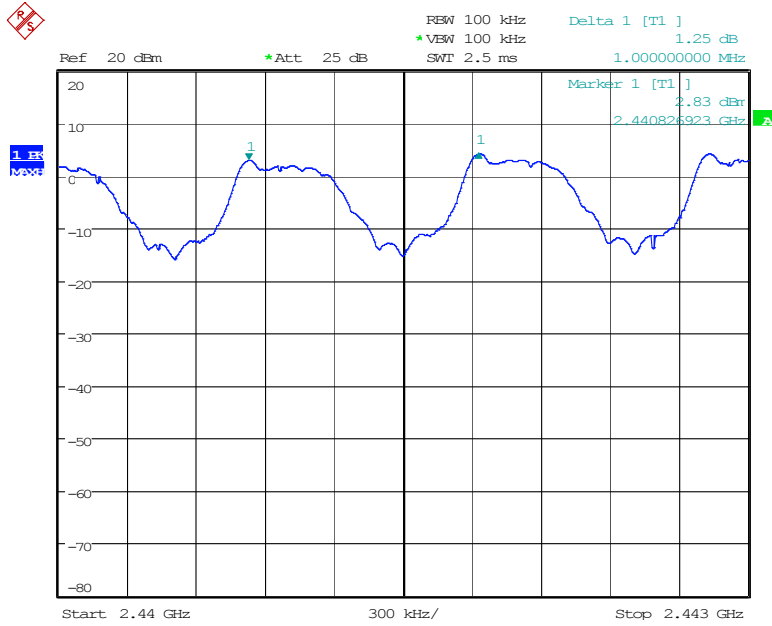

Date: 27.JUL.2018 10:39:52

### GFSK Hopping Mode

#### 2480 MHz

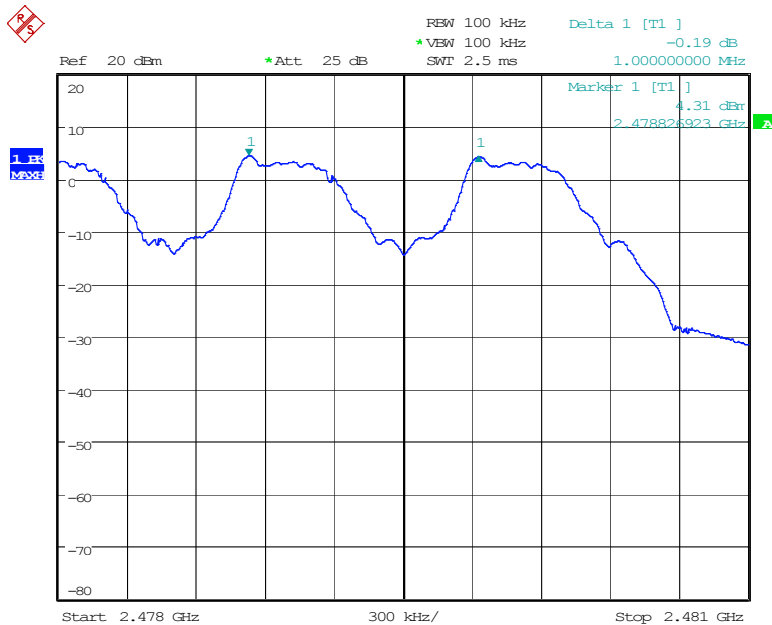

Date: 27.JUL.2018 10:41:59

CTC Laboratories, Inc

1-2/F., Building 2, Jiaquan Building, Guanlan High-Tech Park, Shenzhen, Guangdong, China  
 Tel.: (86)755-27521059      Fax: (86)755-27521011      Http://www.sz-ctc.org.cn



For anti-fake verification, please visit the official website of Certification and Accreditation Administration of the People's Republic of China : [yz.cncaic.cn](http://yz.cncaic.cn)

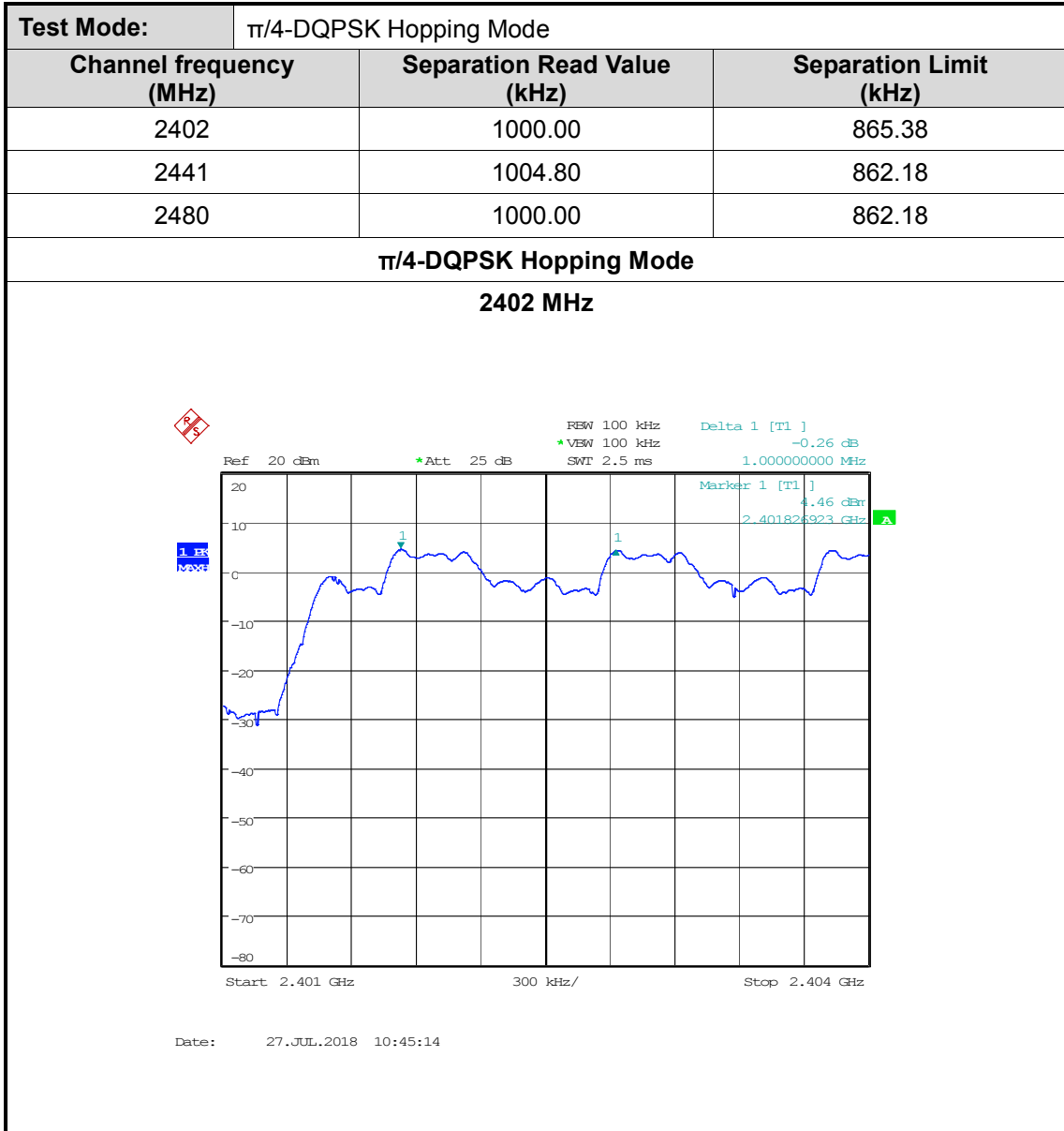

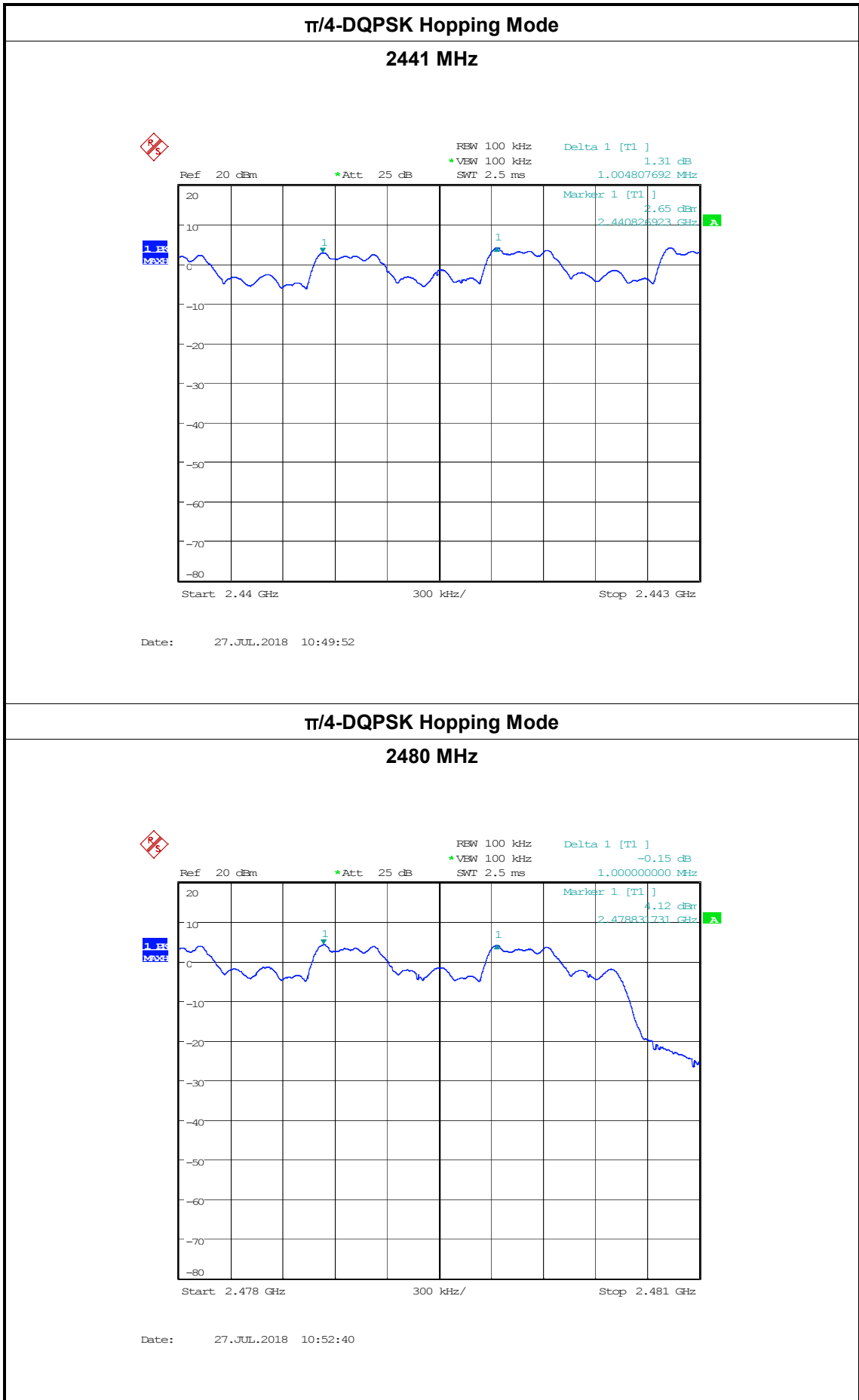

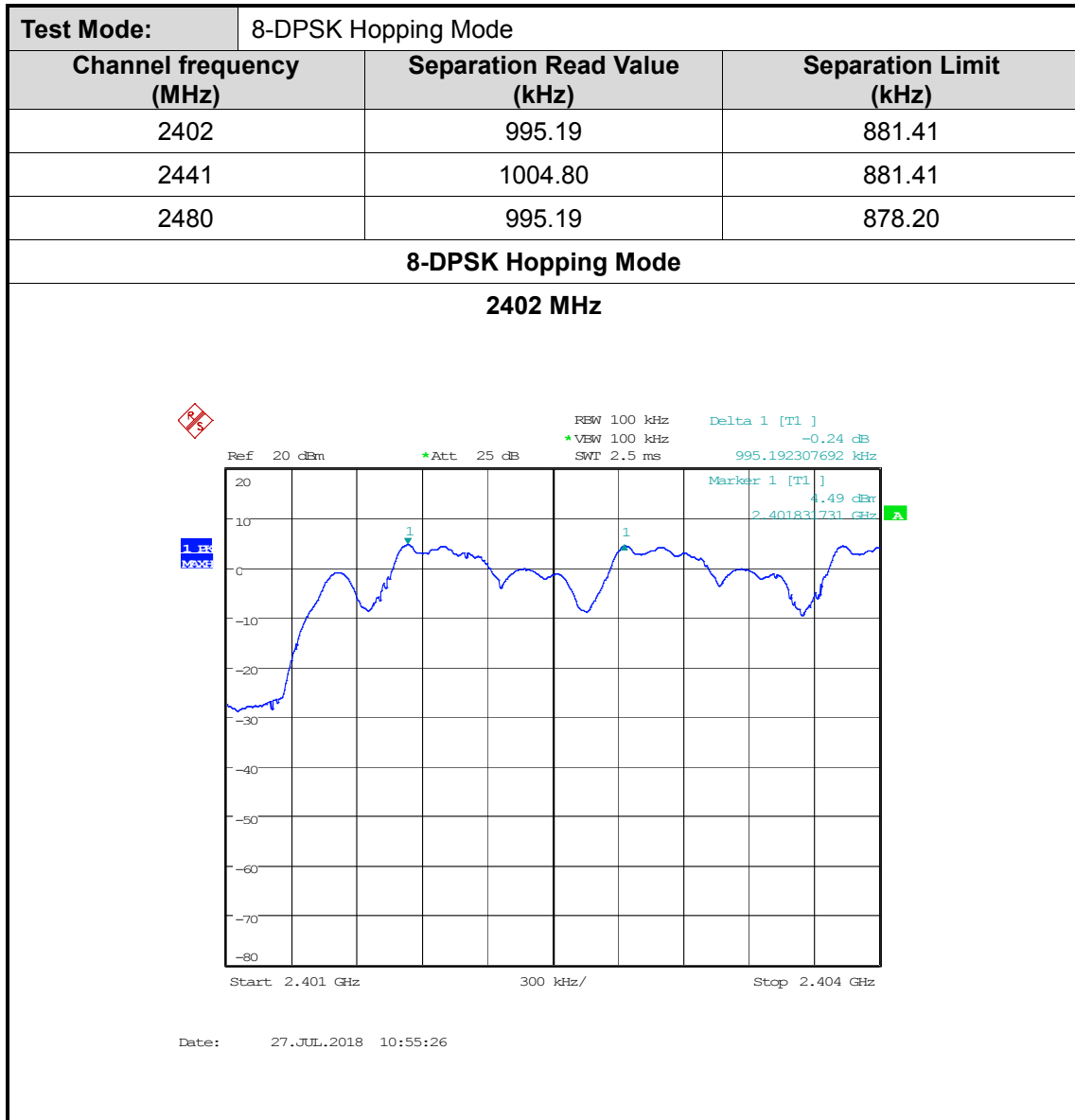



### 8-DPSK Hopping Mode

#### 2441 MHz

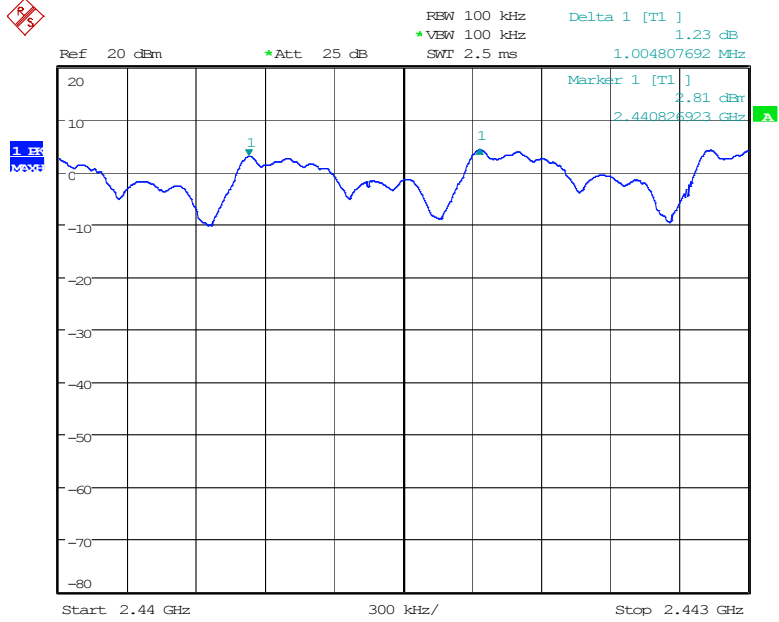

Date: 27.JUL.2018 10:59:20

### 8-DPSK Hopping Mode

#### 2480 MHz

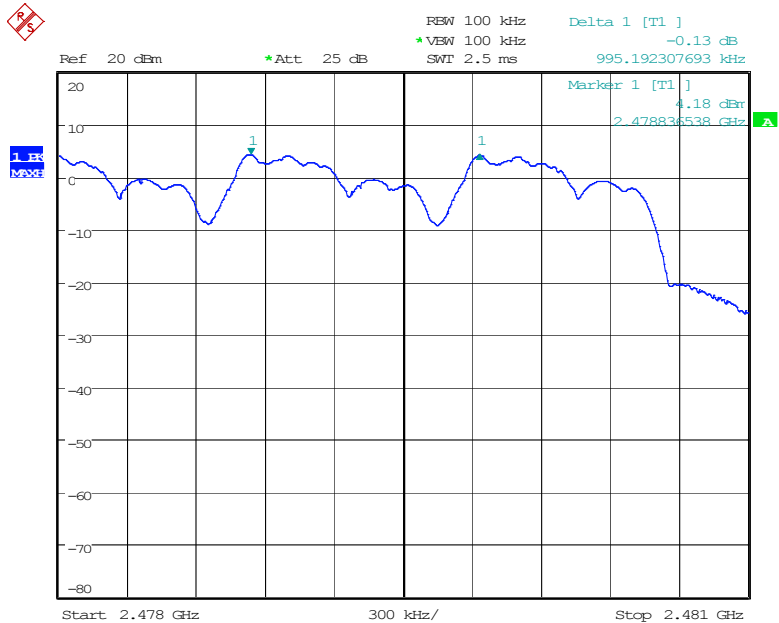

Date: 27.JUL.2018 11:03:07

CTC Laboratories, Inc

1-2/F., Building 2, Jiaquan Building, Guanlan High-Tech Park, Shenzhen, Guangdong, China  
 Tel.: (86)755-27521059      Fax: (86)755-27521011      Http://www.sz-ctc.org.cn



For anti-fake verification, please visit the official website of Certification and Accreditation Administration of the People's Republic of China : [yz.cncaic.cn](http://yz.cncaic.cn)



### 3.5. Number of Hopping Channel

#### Limit

Section	Test Item	Limit
15.247	Number of Hopping Channel	>15

#### Test Configuration

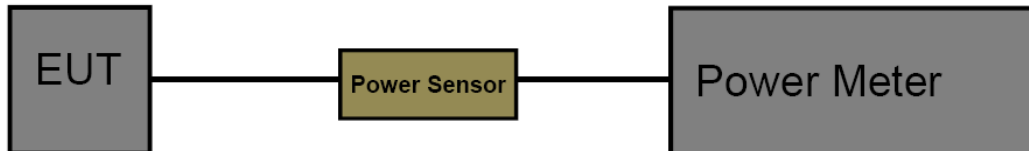

#### Test Procedure

1. The EUT was directly connected to the spectrum analyzer and antenna output port as show in the block diagram above.
2. Spectrum Setting:
  - (1) Peak Detector: RBW=100 kHz, VBW $\geq$ RBW, Sweep time= Auto.

#### Test Mode

Please refer to the clause 2.2.

#### Test Result



<b>Test Mode:</b>	Hopping Mode		
Frequency Range	Test Mode	Quantity of Hopping Channel	Limit
2402MHz~2483.5MHz	GFSK	79	>15
	$\pi/4$ -DQPSK	79	
	8-DPSK	79	

**GFSK Mode**

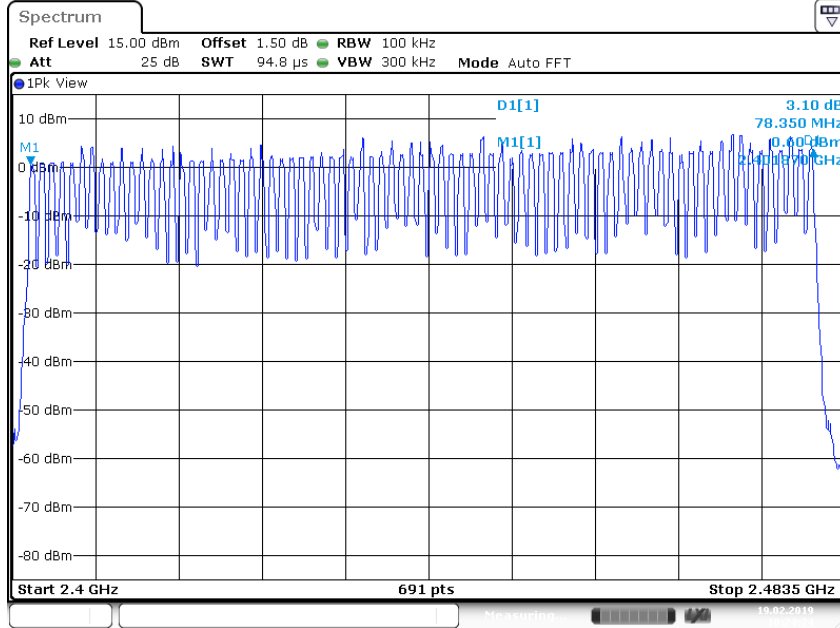

Date: 19.FEB.2019 10:24:24

**$\pi/4$ -DQPSK Mode**

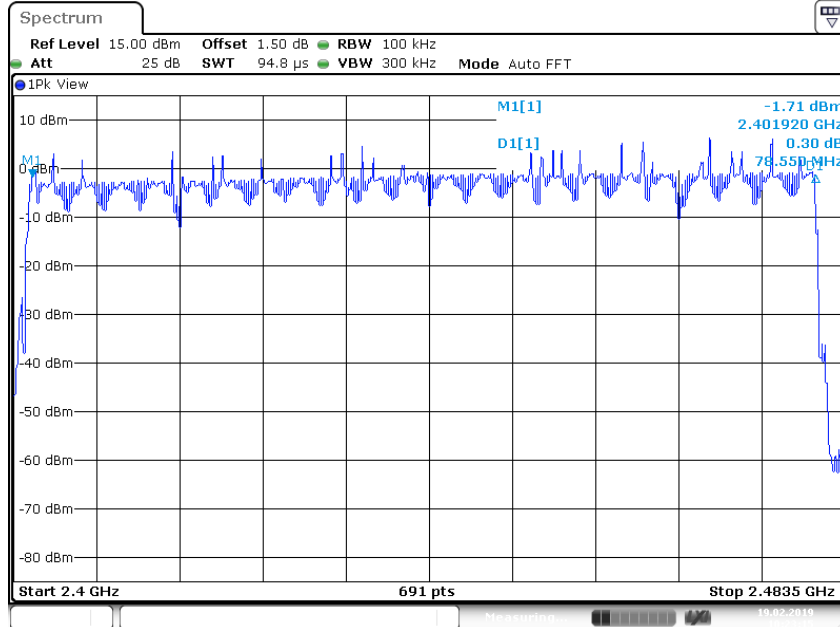

Date: 19.FEB.2019 10:23:14

CTC Laboratories, Inc

1-2/F., Building 2, Jiaquan Building, Guanlan High-Tech Park, Shenzhen, Guangdong, China  
Tel.: (86)755-27521059 Fax: (86)755-27521011 Http://www.sz-ctc.org.cn



For anti-fake verification, please visit the official website of Certification and Accreditation Administration of the People's Republic of China : [yz.cncaic.cn](http://yz.cncaic.cn)

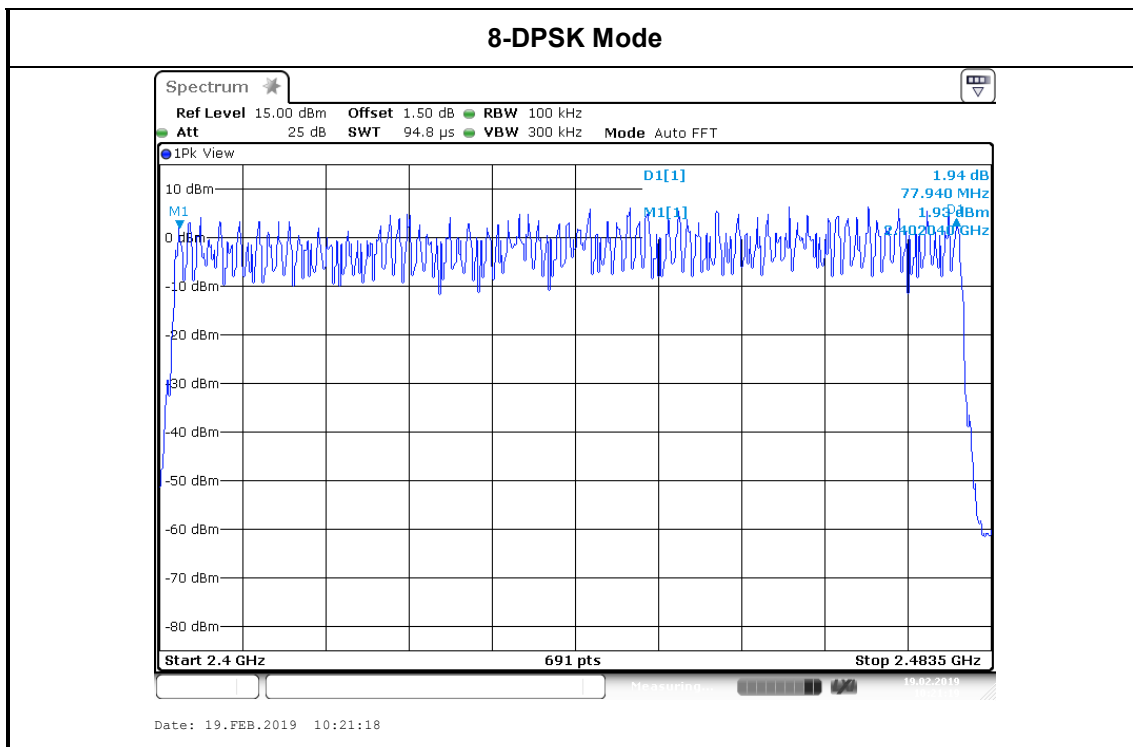

### 3.6. Dwell Time

#### Limit

Section	Test Item	Limit
15.247(a)(1)/ RSS-210 Annex 8(A8.1d)	Average Time of Occupancy	0.4 sec

#### Test Configuration

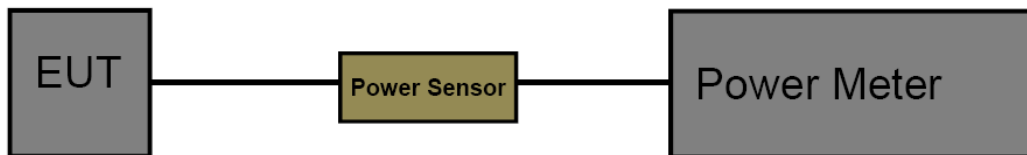

#### Test Procedure

1. The EUT was directly connected to the spectrum analyzer and antenna output port as show in the block diagram above.
2. Spectrum Setting:
  - (1) Spectrum Setting: RBW=1MHz, VBW≥RBW.
  - (2) Use video trigger with the trigger level set to enable triggering only on full pulses.
  - (3) Sweep Time is more than once pulse time.
  - (4) Set the center frequency on any frequency would be measure and set the frequency span to zero.
  - (5) Measure the maximum time duration of one single pulse.
  - (6) Set the EUT for packet transmitting.

#### Test Mode

Please refer to the clause 2.2

#### Test Result



Test Mode:		Hopping Mode (GFSK)				
Test Mode	Channel (MHz)	Pulse Time (ms)	Total of Dwell (ms)	Period Time (s)	Limit (ms)	Result
1DH1	2441	0.423	135.36	31.60	400	PASS
1DH3	2441	1.678	268.48	31.60	400	PASS
1DH5	2441	2.926	312.11	31.60	400	PASS

1DH1 Total of Dwell= Pulse Time\*(1600/2)\*31.6/79  
 1DH3 Total of Dwell= Pulse Time\*(1600/4)\*31.6/79  
 1DH5 Total of Dwell= Pulse Time\*(1600/6)\*31.6/79

### GFSK Hopping Mode 1DH1

#### 2441 MHz

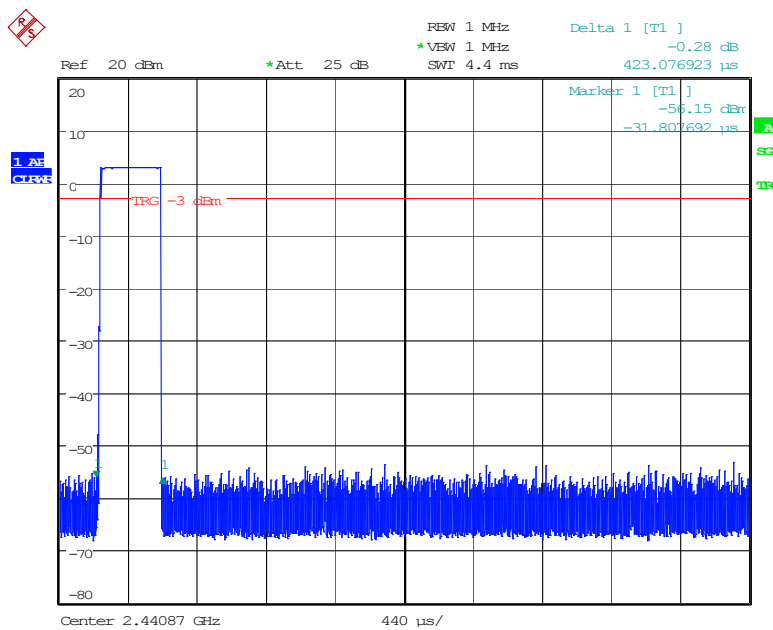

Date: 27.JUL.2018 10:21:36



### GFSK Hopping Mode 1DH3

#### 2441 MHz

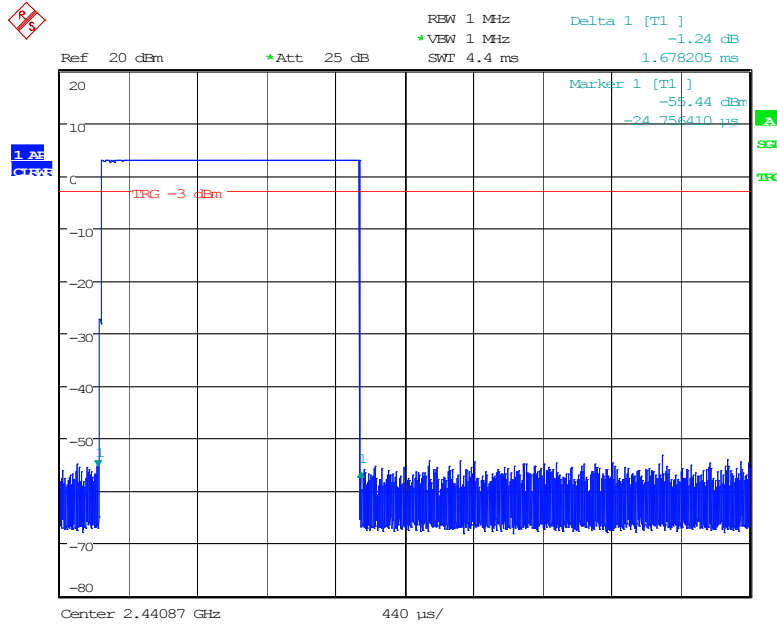

Date: 27.JUL.2018 10:23:17

### GFSK Hopping Mode 1DH5

#### 2441 MHz

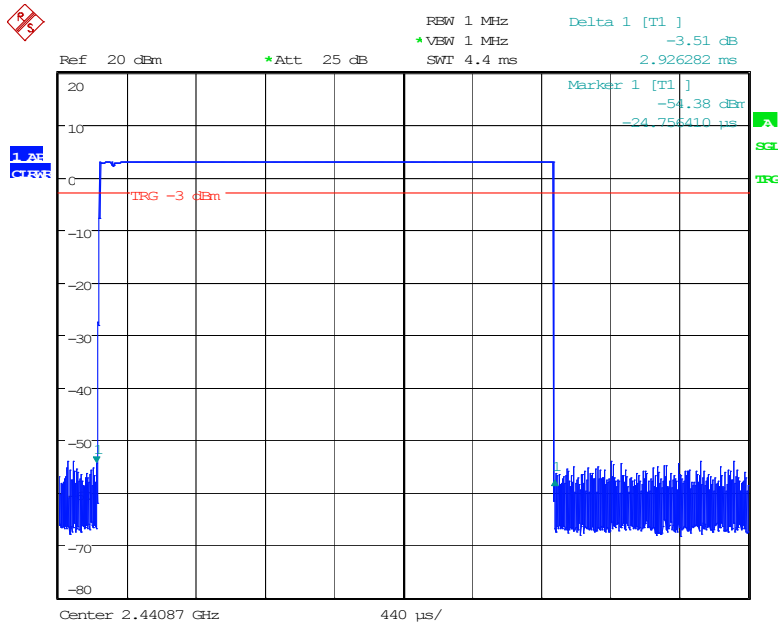

Date: 27.JUL.2018 10:24:10

CTC Laboratories, Inc

1-2/F., Building 2, Jiaquan Building, Guanlan High-Tech Park, Shenzhen, Guangdong, China  
Tel.: (86)755-27521059 Fax: (86)755-27521011 Http://www.sz-ctc.org.cn



For anti-fake verification, please visit the official website of Certification and Accreditation Administration of the People's Republic of China : [yz.cncaic.cn](http://yz.cncaic.cn)



Test Mode:		Hopping Mode ( $\pi/4$ -DQPSK)				
Test Mode	Channel (MHz)	Pulse Time (ms)	Total of Dwell (ms)	Period Time (s)	Limit (ms)	Result
2DH1	2441	0.416	133.12	31.60	400	PASS
2DH3	2441	1.678	268.48	31.60	400	PASS
2DH5	2441	2.926	312.11	31.60	400	PASS

2DH1 Total of Dwell= Pulse Time\*(1600/2)\*31.6/79  
2DH3 Total of Dwell= Pulse Time\*(1600/4)\*31.6/79  
2DH5 Total of Dwell= Pulse Time\*(1600/6)\*31.6/79

**$\pi/4$ -DQPSK Hopping Mode 2DH1**

**2441 MHz**

Date: 27.JUL.2018 10:26:15



### $\pi/4$ -DQPSK Hopping Mode 2DH3

2441 MHz

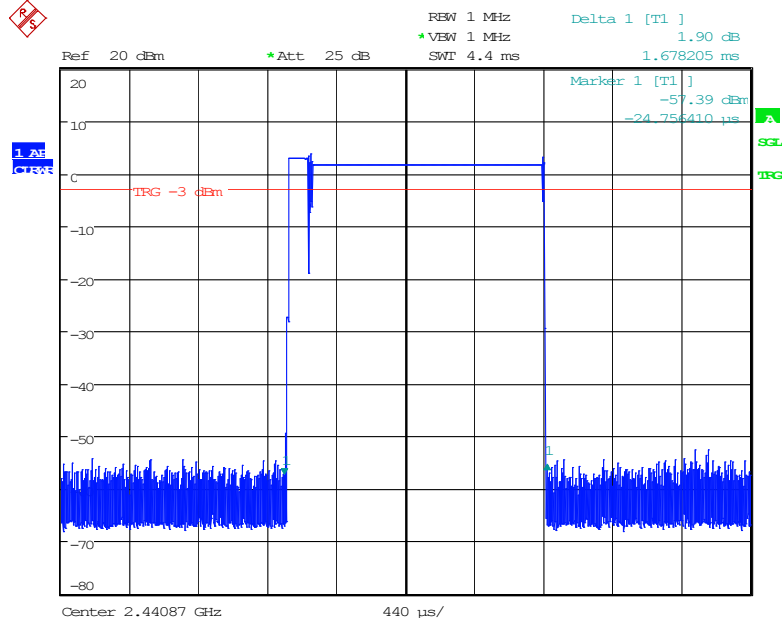

Date: 27.JUL.2018 10:28:11

### $\pi/4$ -DQPSK Hopping Mode 2DH5

2441 MHz

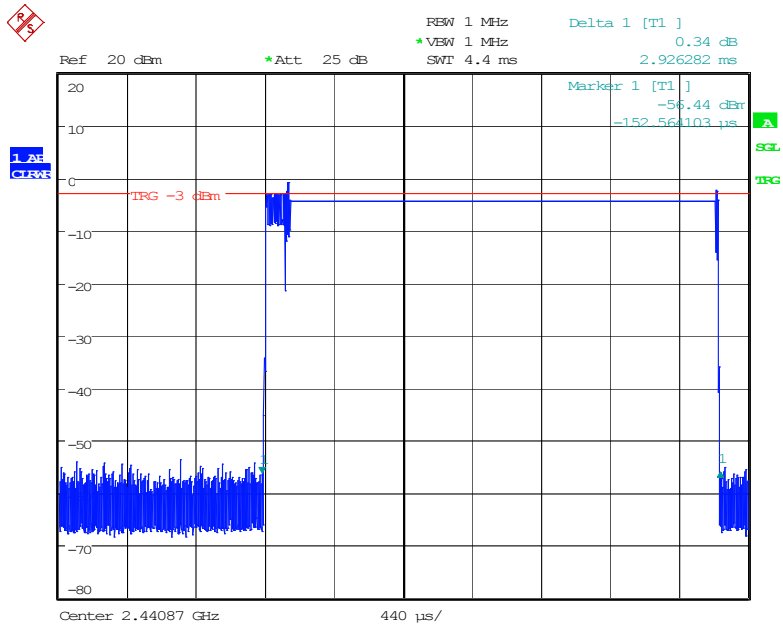

Date: 27.JUL.2018 10:29:05

CTC Laboratories, Inc

1-2/F., Building 2, Jiaquan Building, Guanlan High-Tech Park, Shenzhen, Guangdong, China  
Tel.: (86)755-27521059 Fax: (86)755-27521011 Http://www.sz-ctc.org.cn



For anti-fake verification, please visit the official website of Certification and Accreditation Administration of the People's Republic of China: [yz.cncaic.cn](http://yz.cncaic.cn)





Test Mode:		Hopping Mode (8-DPSK)				
Test Mode	Channel (MHz)	Pulse Time (ms)	Total of Dwell (ms)	Period Time (s)	Limit (ms)	Result
3DH1	2441	0.416	133.12	31.60	400	PASS
3DH3	2441	1.664	266.24	31.60	400	PASS
3DH5	2441	2.926	312.11	31.60	400	PASS

1DH1 Total of Dwell= Pulse Time\*(1600/2)\*31.6/79  
1DH3 Total of Dwell= Pulse Time\*(1600/4)\*31.6/79  
1DH5 Total of Dwell= Pulse Time\*(1600/6)\*31.6/79

**8-DPSK Hopping Mode 3DH1**

**2441 MHz**

Date: 27.JUL.2018 10:29:55

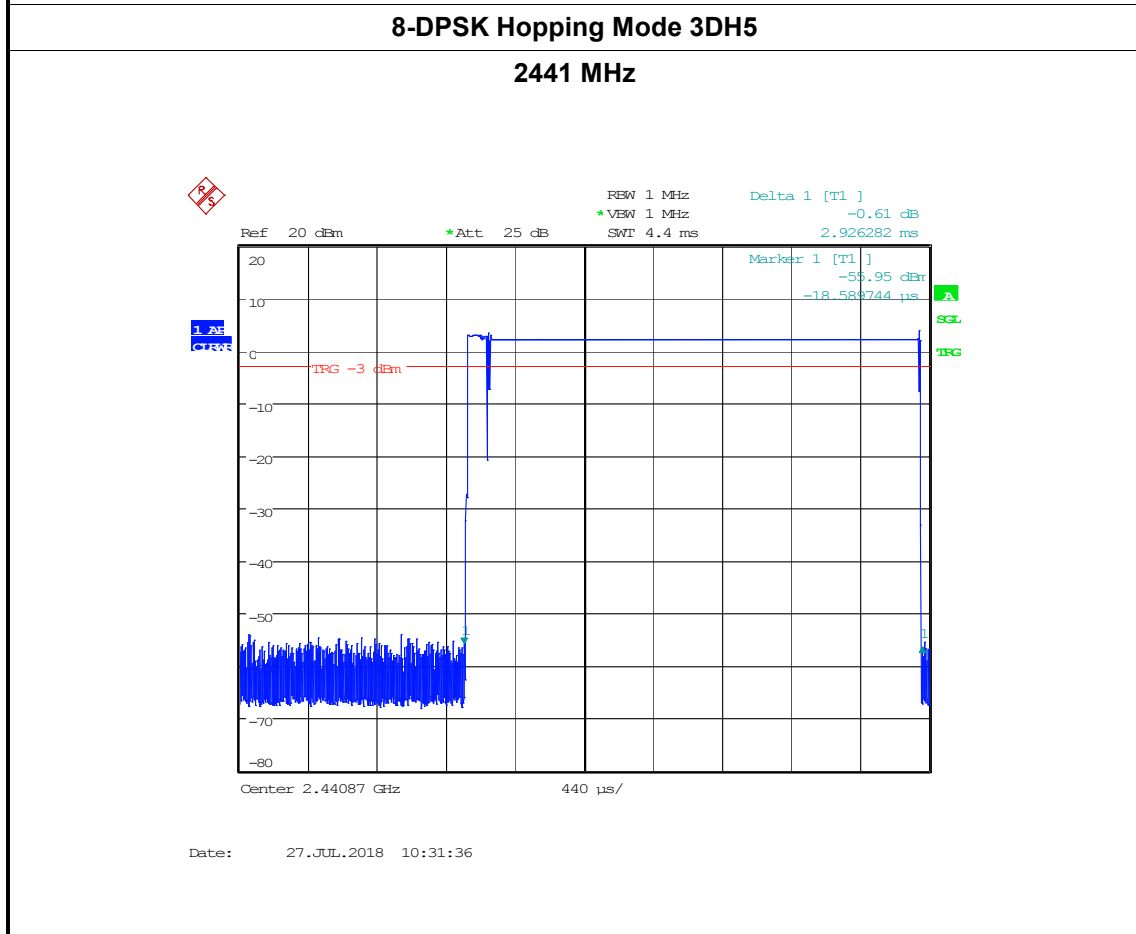
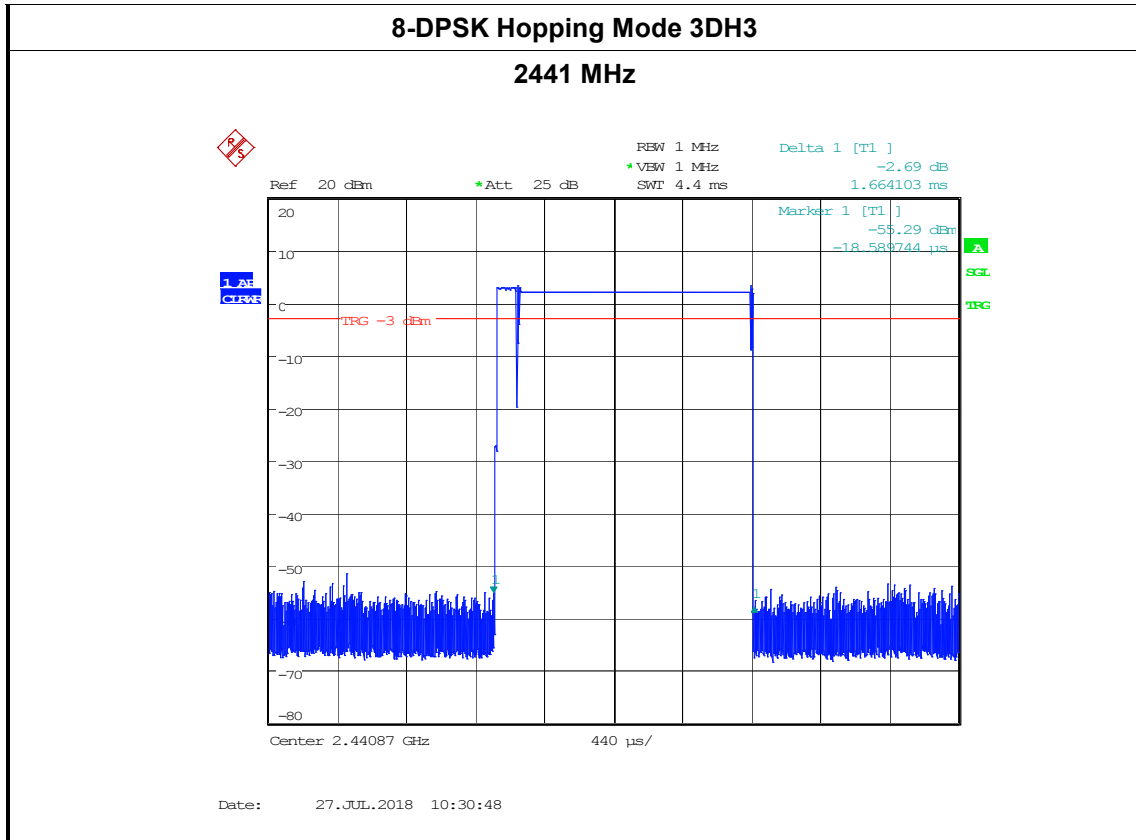

### 3.7. Peak Output Power

#### Limit

Test Item	Limit	Frequency Range(MHz)
Peak Output Power	Hopping Channels>75 Power<1W(30dBm) Other <125mW(21dBm)	2400~2483.5

#### Test Configuration

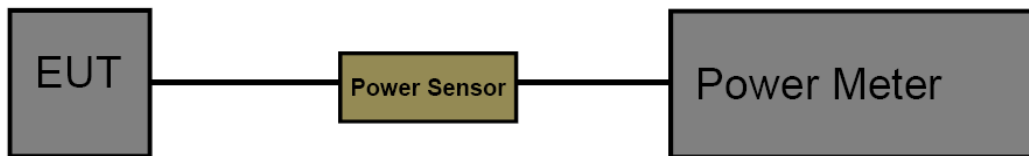

#### Test Procedure

1. The EUT was directly connected to the spectrum analyzer and antenna output port as show in the block diagram above.
2. Spectrum Setting:  
Peak Detector: RBW=1 MHz, VBW=3 MHz for bandwidth less than 1MHz.  
RBW=3 MHz, VBW=3 MHz for bandwidth more than 1MHz.

#### Test Mode

Please refer to the clause 2.2

#### Test Result

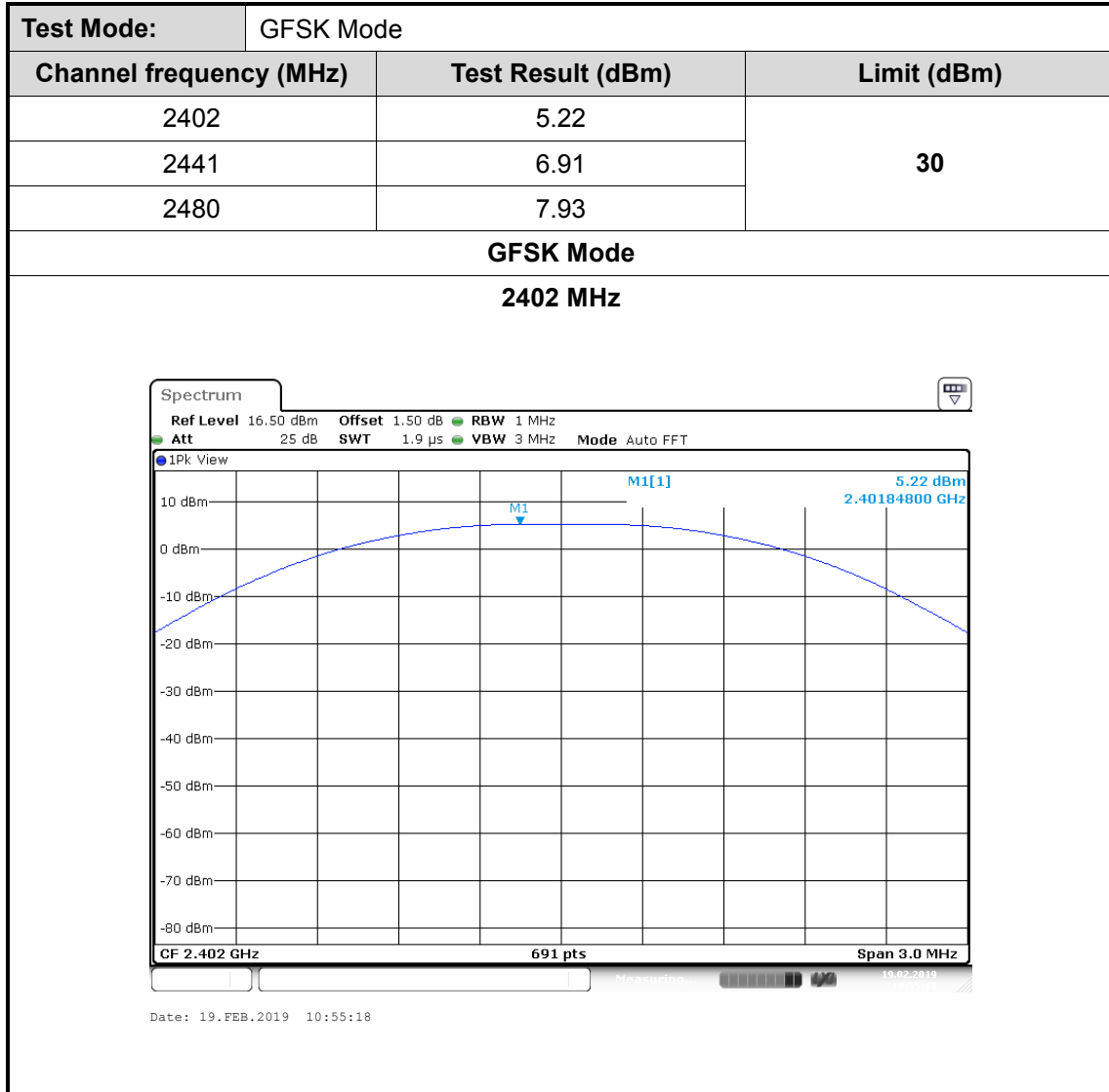



### GFSK Mode

2441 MHz

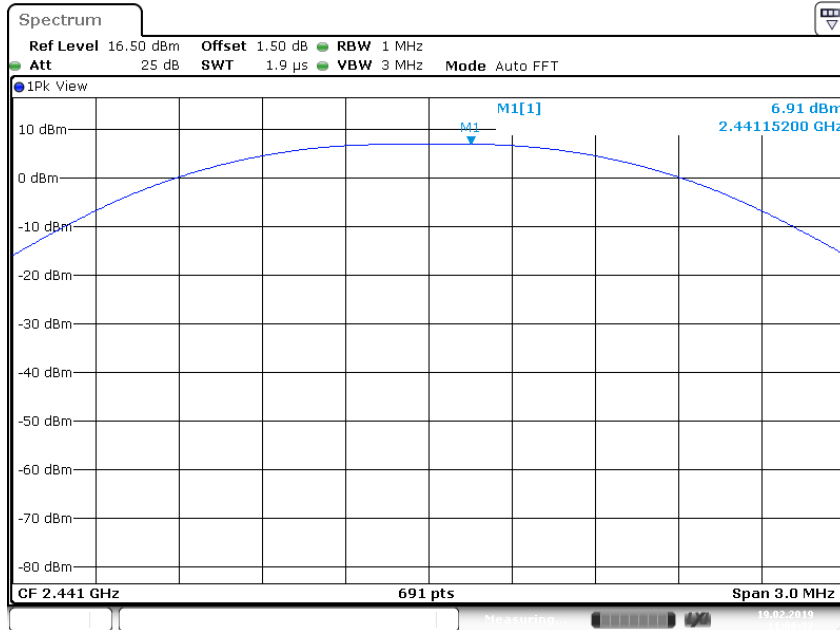

### GFSK Mode

2480 MHz

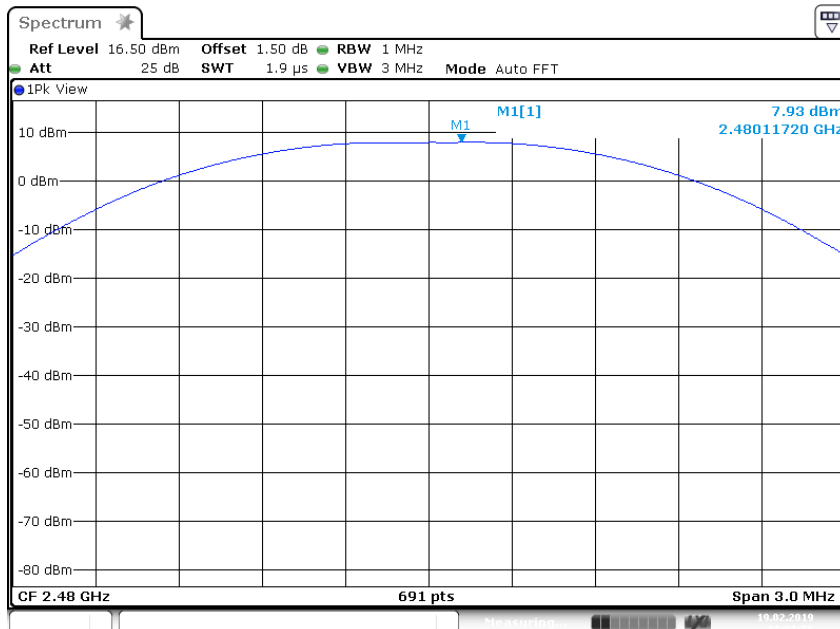

CTC Laboratories, Inc

1-2/F., Building 2, Jiaquan Building, Guanlan High-Tech Park, Shenzhen, Guangdong, China  
Tel.: (86)755-27521059 Fax: (86)755-27521011 Http://www.sz-ctc.org.cn



For anti-fake verification, please visit the official website of Certification and Accreditation Administration of the People's Republic of China : [yz.cncaic.cn](http://yz.cncaic.cn)

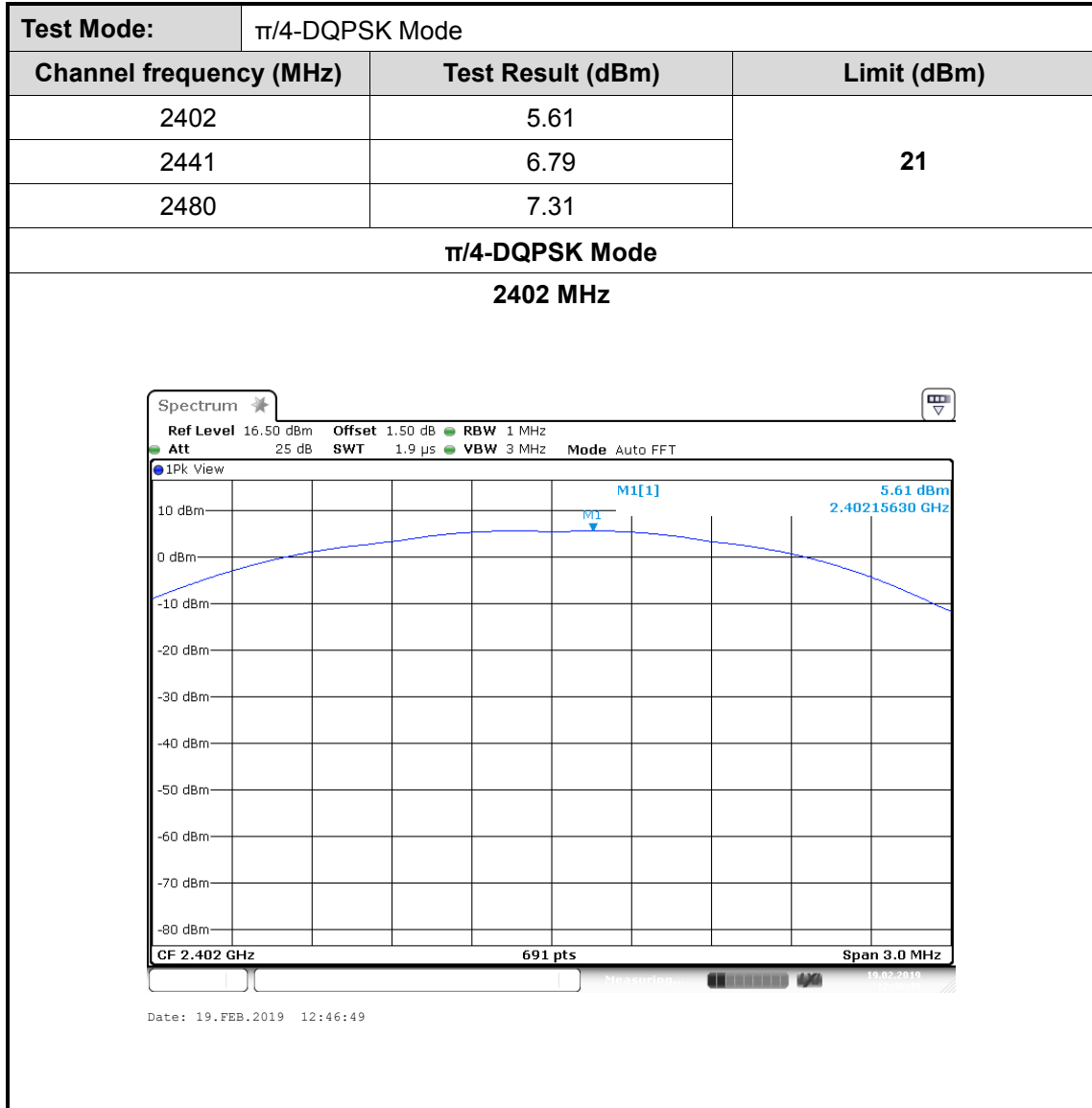



### $\pi/4$ -DQPSK Mode

#### 2441 MHz

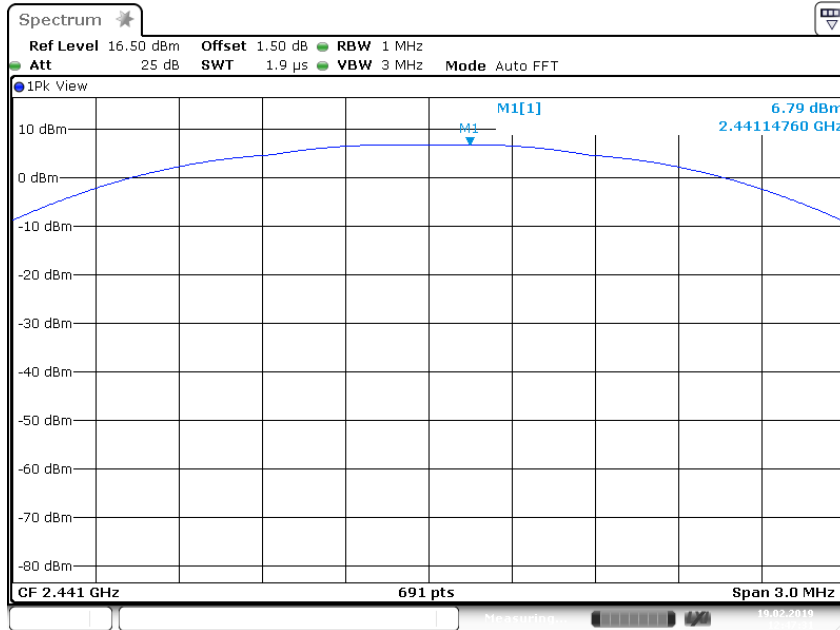

### $\pi/4$ -DQPSK Mode

#### 2480 MHz

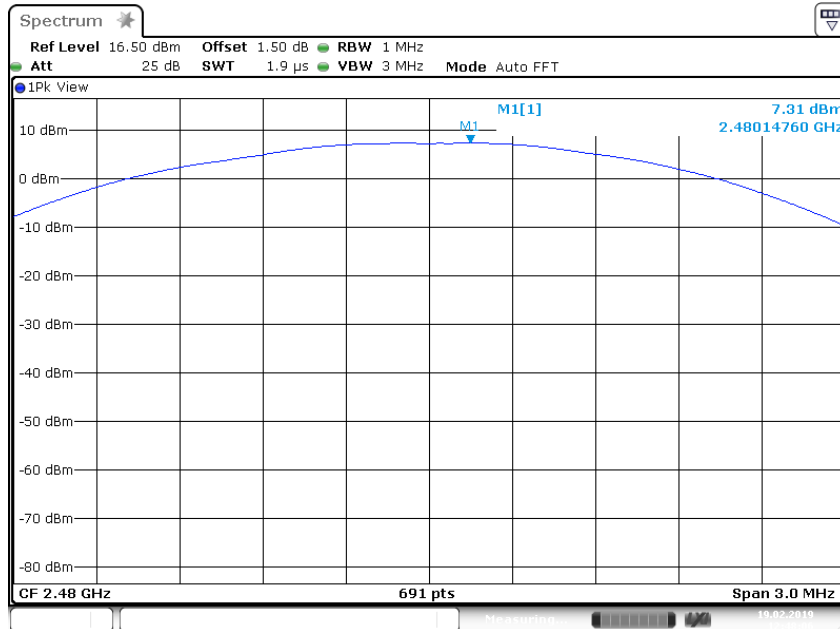

CTC Laboratories, Inc

1-2/F., Building 2, Jiaquan Building, Guanlan High-Tech Park, Shenzhen, Guangdong, China  
Tel.: (86)755-27521059 Fax: (86)755-27521011 Http://www.sz-ctc.org.cn



For anti-fake verification, please visit the official website of Certification and Accreditation Administration of the People's Republic of China : [yz.cncaic.cn](http://yz.cncaic.cn)

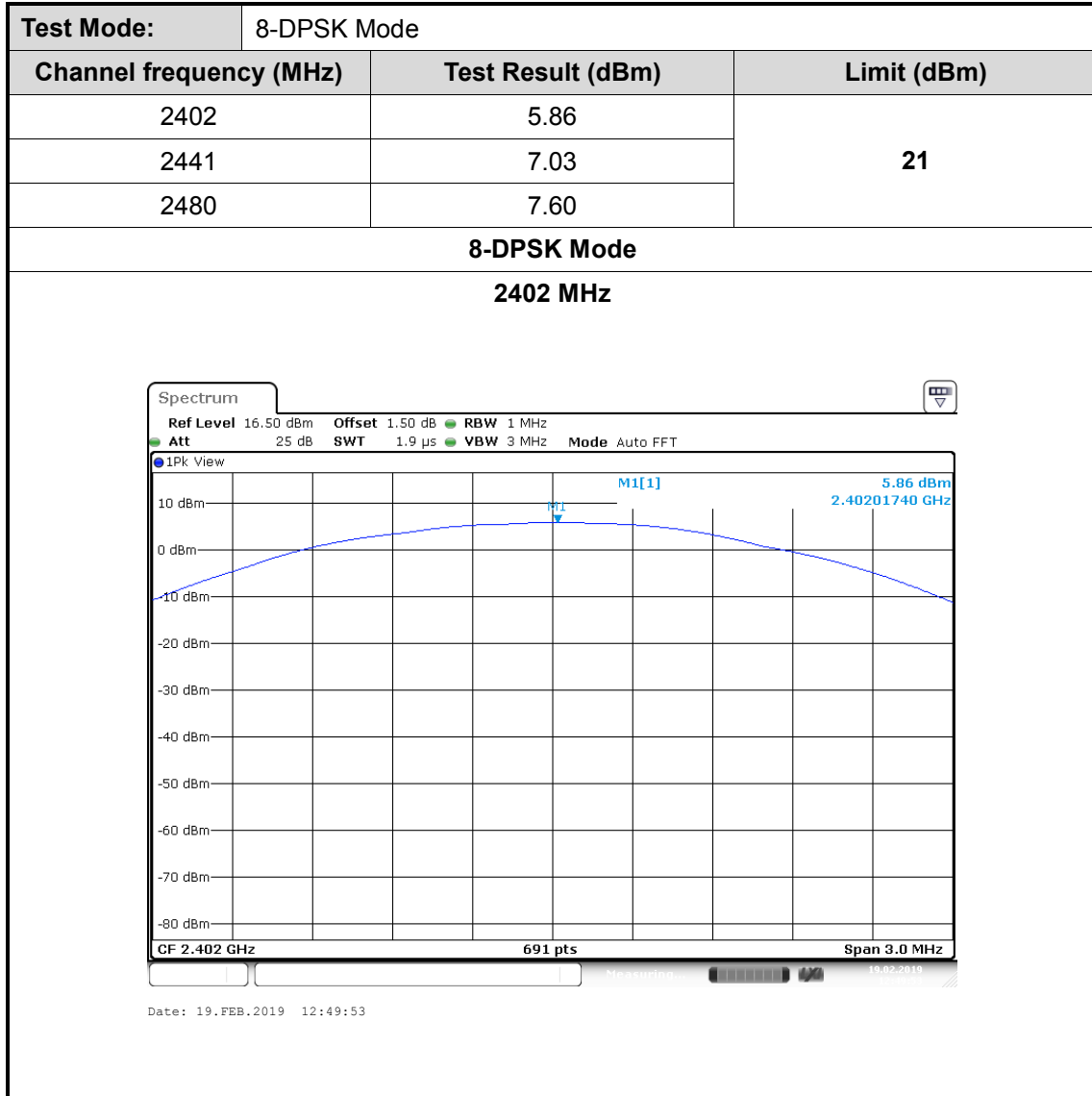





### 8-DPSK Mode

### 2441 MHz

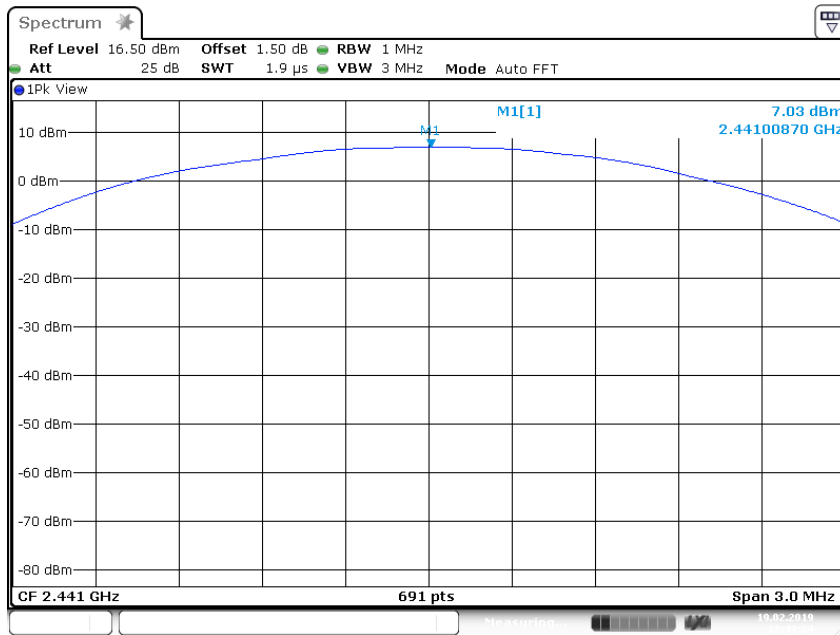

### 8-DPSK Mode

### 2480 MHz

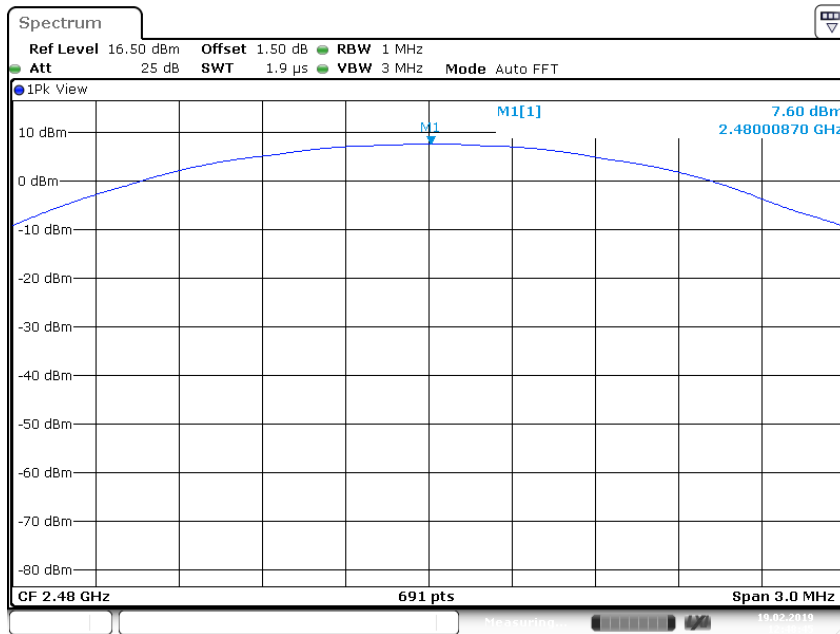



### 3.8. Antenna requirement

#### Requirement

##### **FCC CFR Title 47 Part 15 Subpart C Section 15.203:**

An intentional radiator shall be designed to ensure that no antenna other than that furnished by the responsible party shall be used with the device. The use of a permanently attached antenna or of an antenna that uses a unique coupling to the intentional radiator, the manufacturer may design the unit so that a broken antenna can be replaced by the user, but the use of a standard antenna jack or electrical connector is prohibited.

##### **FCC CFR Title 47 Part 15 Subpart C Section 15.247(c) (1)(i):**

(i) Systems operating in the 2400~2483.5 MHz band that is used exclusively for fixed. Point-to-point operations may employ transmitting antennas with directional gain greater than 6dBi provided the maximum conducted output power of the intentional radiator is reduced by 1 dB for every 3 dB that the directional gain of the antenna exceeds 6dBi.

#### Test Result

The EUT's antenna is soldered to the PCB. The gain of the antenna is 0 dBi. Meet the standards.

Please reference to the annex: Internal Photographs



## 4.EUT TEST PHOTOS

Please reference to the annex: Test Photo



## 5.PHOTOGRAPHS OF EUT CONSTRUCTIONAL

Please reference to the annex: External Photographs and Internal Photographs

\*\*\*\*\*THE END\*\*\*\*\*