



Shenzhen GTI Technology Co., Ltd.

1F,2 Block, Jiaquan Building, Guanlan High-tech Park Baoan District,
Shenzhen, Guangdong, China.

Tel: +86-755- 27521059

Fax: +86-755- 27521011

TEST REPORT

Product Name : GEMNFC

Trademark : N.A

Model/Type reference : GEMNFC02

Listed Model(s) : N.A

FCC ID : PADWF125

Test Standards : **FCC Part 15.249: Operation within the bands 902-928 MHz, 2400-2483.5 MHz and 5725-5850 MHz**

Report No : GTI20180533F-2

Applicant : Wahoo Fitness L.L.C.

Address of applicant : 90 W WIEUCA RD NE STE 110 ATLANTA GA 30342

Date of Receipt : Mar. 18, 2018

Date of Test Date..... : Mar. 18, 2018- Apr 06, 2018

Data of issue...... : Apr 07, 2018

Test result	Pass *
--------------------	---------------

* In the configuration tested, the EUT complied with the standards specified above

GENERAL DESCRIPTION OF EUT	
Equipment:	GEMNFC
Model Name:	GEMNFC02
Adding Model(s):	N.A.
Model difference:	N.A.
Manufacturer:	Wahoo Fitness L.L.C.
Manufacturer Address:	90 W WIEUCA RD NE STE 110 ATLANTA GA 30342
Factory:	Flextronics Electronics Technology (Suzhou) Co., Ltd.
Address:	No.268 Suhong Road, Suzhou Industrial Park, Suzhou City, Jiangsu Province, China
Power Rating:	DC 5V(from USB port)

Compiled By:

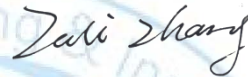

(Zaki Zhang)

Reviewed By:



(Gavin Shi)

Approved By:



(Walter Chen)

This test report may be duplicated completely for legal use with the approval of the applicant. It should not be reproduced except in full, without the written approval of our laboratory. The client should not use it to claim product endorsement by GTI. The test results in the report only apply to the tested sample. The test report shall be invalid without all the signatures of testing engineers, reviewer and approver. Any objections must be raised to GTI within 15 days since the date when the report is received. It will not be taken into consideration beyond this limit.



Table of Contents

Page

1. SUMMARY..... 4

1.1. TEST STANDARDS.....4

1.2. TEST DESCRIPTION.....4

1.3. TEST FACILITY5

1.4. MEASUREMENT UNCERTAINTY5

2. GENERAL INFORMATION 6

2.1. GENERAL DESCRIPTION OF EUT6

2.2. DESCRIPTION OF TEST MODES7

2.3. MEASUREMENT INSTRUMENTS LIST8

7. TEST CONDITIONS AND RESULTS 9

7.1. CONDUCTED EMISSION MEASUREMENT.....9

7.2. RADIATED EMISSION13

7.3. 20dB BANDWIDTH.....17

7.4. BAND EDGE TEST TEST.....19

7.5. ANTENNA REQUIREMENT.....21

8. EUT TEST PHOTO 22

9. PHOTOGRAPHS OF EUT CONSTRUCTIONAL 24



1. SUMMARY

1.1. Test Standards

The tests were performed according to following standards:

FCC Rules Part 15.249: Frequency Hopping, Direct Spread Spectrum and Hybrid Systems that are in operation within the bands of 902-928 MHz, 2400-2483.5 MHz, and 5725-5850 MHz

ANSI C63.10-2013: American National Standard for Testing Unlicensed Wireless Devices

1.2. Test Description

FCC PART 15 15.249		
FCC Part 15.207	AC Power Conducted Emission	PASS
FCC Part 15.249 (a) (d) /15.209	Radiated Emissions	PASS
FCC Part 15.249 (a)	Spurious RF Conducted Emission	N/A
FCC Part 15.215(c)	20dB Occupied Band Width	PASS
FCC Part 15.249 (d)	Band edge Test	PASS
FCC Part 15.203	Antenna requirement	PASS

.Note 1:EUT is battery power supply. conducted emission is not need



1.3. Test Facility

1.3.1 Address of the test laboratory

Shenzhen General Testing & Inspection Technology Co., Ltd.

Add: 1F, 2 Block, Jiaquan Building, Guanlan High-tech Park Baoan District, Shenzhen, Guangdong, China

1.3.2 Laboratory accreditation

The test facility is recognized, certified, or accredited by the following organizations:

IC Registration No.: 9783A

The 3m alternate test site of Shenzhen GTI Technology Co., Ltd. EMC Laboratory has been registered by Certification and Engineer Bureau of Industry Canada for the performance of with Registration NO.: 9783A on Jan, 2016.

FCC-Registration No.: 951311

Shenzhen GTI Technology Co., Ltd. EMC Laboratory has been registered and fully described in a report filed with the (FCC) Federal Communications Commission. The acceptance letter from the FCC is maintained in our files. Registration 951311, Aug 26, 2017

1.4. Measurement Uncertainty

The data and results referenced in this document are true and accurate. The reader is cautioned that there may be errors within the calibration limits of the equipment and facilities. The measurement uncertainty was calculated for all measurements listed in this test report acc. to CISPR 16 - 4 Specification for radio disturbance and immunity measuring apparatus and methods – Part 4: Uncertainty in EMC Measurements and is documented in the Shenzhen General Testing & Inspection Technology Co., Ltd quality system acc. to DIN EN ISO/IEC 17025. Furthermore, component and process variability of devices similar to that tested may result in additional deviation. The manufacturer has the sole responsibility of continued compliance of the device.

Hereafter the best measurement capability for General Testing & Inspection laboratory is reported:

Test Items	Measurement Uncertainty	Notes
Transmitter power conducted	0.57 dB	(1)
Transmitter power Radiated	2.20 dB	(1)
Conducted spurious emission 9KHz-40 GHz	1.60 dB	(1)
Radiated spurious emission 9KHz-40 GHz	2.20 dB	(1)
Conducted Emission 9KHz-30MHz	3.39 dB	(1)
Radiated Emission 30~1000MHz	4.24 dB	(1)
Radiated Emission 1~18GHz	5.16 dB	(1)
Radiated Emission 18-40GHz	5.54 dB	(1)
Occupied Bandwidth	-----	(1)

(1) This uncertainty represents an expanded uncertainty expressed at approximately the 95% confidence level using a coverage factor of $k=1.96$.

2. GENERAL INFORMATION

2.1. General Description of EUT

Product Name:	GEMNFC
Model/Type reference:	GEMNFC02
Power supply:	DC 5V(from USB port)
Hardware version:	V1.0
Software version:	V1.0
Bluetooth:	
Supported type:	Version 4.0 for low Energy
Modulation:	GFSK
Operation frequency:	2402MHz to 2480MHz
Channel number:	40
Channel separation:	2 MHz
Antenna type:	Ceramic Antenna
Antenna gain:	4.17dBi
ANT+:	
Supported type:	ANT+
Modulation:	GFSK
Operation frequency:	2457MHz
Channel number:	1
Channel separation:	/
Antenna type:	Ceramic Antenna
Antenna gain:	4.17dBi

Note: For a more detailed features description, please refer to the manufacturer's specifications or the User's Manual.

2.2. Description of Test Modes

Peripherals Devices:

Name:	Model:	Serial	Manufacture	Remark
Laptop	Thinkpad	/	Lenovo	/

Note: All the above equipment /cable were placed in worse case position to maximize emission signals during emission test.

Operation Frequency

The Applicant provides communication tools software to control the EUT for staying in continuous transmitting (Duty Cycle more than 98%) mode for testing.

ANT+

Channel	Frequency (MHz)
01	2457



2.3.Measurement Instruments List

Maximum Peak Output Power / Band Edge Compliance of RF Emission / Spurious RF Conducted Emission /Hoping Require/ 20dB bandwidth					
Item	Test Equipment	Manufacturer	Model No.	Serial No.	Calibrated until
1	Spectrum Analyzer	Rohde & Schwarz	FSU	100105	Jan. 04,2019
2	RF Cable	Schwarzbeck	AH32D4	SF0150	Jan. 04,2019
3	Temporary Antenna connector	Schwarzbeck	SMA24D	ED1201	Jan. 04,2019

Note: The temporary antenna connector is soldered on the PCB board in order to perform conducted tests and this temporary antenna connector is listed in the equipment list.

3.

Conducted Emission					
Item	Test Equipment	Manufacturer	Model No.	Serial No.	Calibrate until
1	LISN	R&S	ENV216	101112	Jan. 04,2019
2	LISN	R&S	ENV216	101113	Jan. 04,2019
3	EMI Test Receiver	R&S	ESCI	100920	Jan. 04,2019
4	Cable	Schwarzbeck	AK9515E	33156	Jan. 04,2019

4.

Radiated Emission					
Item	Test Equipment	Manufacturer	Model No.	Serial No.	Calibrated until
1	EMI Test Receiver	R&S	ESCI	100967	Jan. 04,2019
2	High pass filter	micro-tranics	HPM50111	34202	Jan. 04,2019
3	Log-Bicon Antenna	Schwarzbeck	CBL6141A	4180	Jan. 04,2019
4	Ultra-Broadband Antenna	ShwarzBeck	BBHA9170	25841	Jan. 04,2019
5	Loop Antenna	LAPLAC	RF300	9138	Jan. 04,2019
6	Spectrum Analyzer	Rohde & Schwarz	FSU	100105	Jan. 04,2019
7	Horn Antenna	Schwarzbeck	BBHA 9120D	648	Jan. 04,2019
8	Pre-Amplifier	HP	8447D	1937A03050	Jan. 04,2019
9	Pre-Amplifier	EMCI	EMC05183 5	980075	Jan. 04,2019
10	Antenna Mast	UC	UC3000	N/A	N/A
11	Turn Table	UC	UC3000	N/A	N/A
12	Cable Below 1GHz	Schwarzbeck	AK9515E	33155	Jan. 04,2019
13	Cable Above 1GHz	Hubersuhner	SUCOFLEX1 02	DA1580	Jan. 04,2019

5. Note: 1. The Cal.Interval was one year.

6. 2. The cable loss has calculated in test result which connection between each test instruments.

7. TEST CONDITIONS AND RESULTS

7.1. CONDUCTED EMISSION MEASUREMENT

Limit

POWER LINE CONDUCTED EMISSION

(Frequency Range 150KHz-30MHz)

FREQUENCY (MHz)		
	Quasi-peak	Average
0.15 -0.5	66 - 56 *	56 - 46 *
0.50 -5.0	56.00	46.00
5.0 -30.0	60.00	50.00

Note:

(1) The tighter limit applies at the band edges.

(2) The limit of " * " marked band means the limitation decreases linearly with the logarithm of the frequency in the range.

The following table is the setting of the receiver

Receiver Parameters	Setting
Attenuation	10 dB
Start Frequency	0.15 MHz
Stop Frequency	30 MHz
IF Bandwidth	9 kHz

Test Procedure

1. The EUT was placed 0.8 meters from the horizontal ground plane with EUT being connected to the power mains through a line impedance stabilization network (LISN). All other support equipments powered from additional LISN(s). The LISN provide 50 Ohm/ 50uH of coupling impedance for the measuring instrument.
2. Interconnecting cables that hang closer than 40 cm to the ground plane shall be folded back and forth in the center forming a bundle 30 to 40 cm long.
3. I/O cables that are not connected to a peripheral shall be bundled in the center. The end of the cable may be terminated, if required, using the correct terminating impedance. The overall length shall not exceed 1 m. Repeat above procedures until all frequency measurements have been completed.
4. LISN at least 80 cm from nearest part of EUT chassis.
5. For the actual test configuration, please refer to the related Item –EUT Test Photos.

Test Configuration

For the actual test configuration, please refer to the related Item –EUT Test Photos.

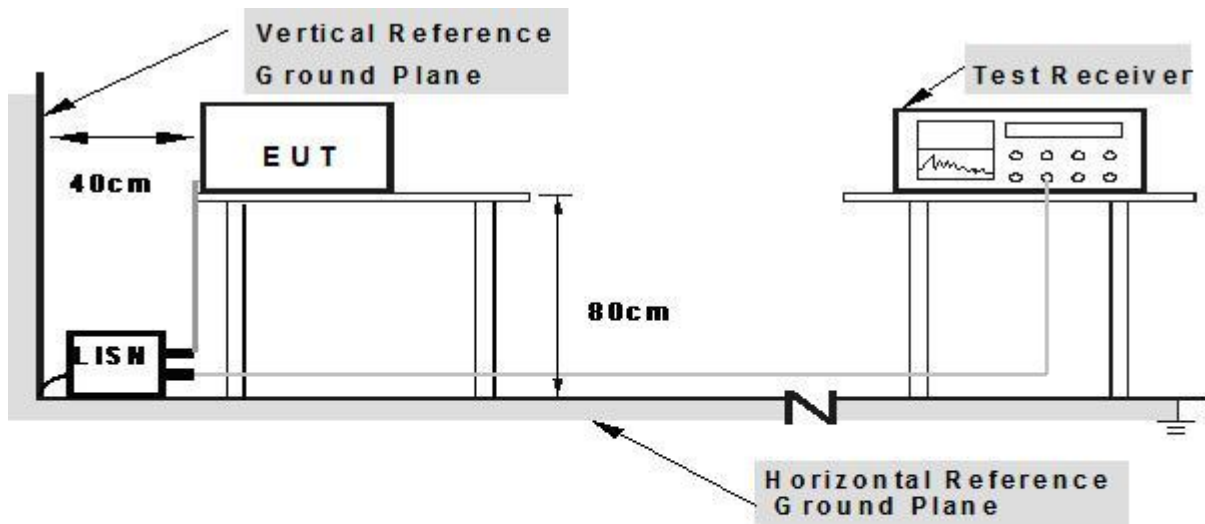

- Note: 1.Support units were connected to second LISN.**
2.Both of LISNs (AMN) are 80 cm from EUT and at least 80 from other units and other metal planes

Test Results



TEST RESULTS

Temperature :	21 °C	Relative Humidity :	60%
Pressure :	101 Kpa	Test Date :	2018-03-25
Test Mode :	Mode 1	Phase :	L
Test Voltage :	AC 120V/60Hz		

Voltage with 2-Line-LISN

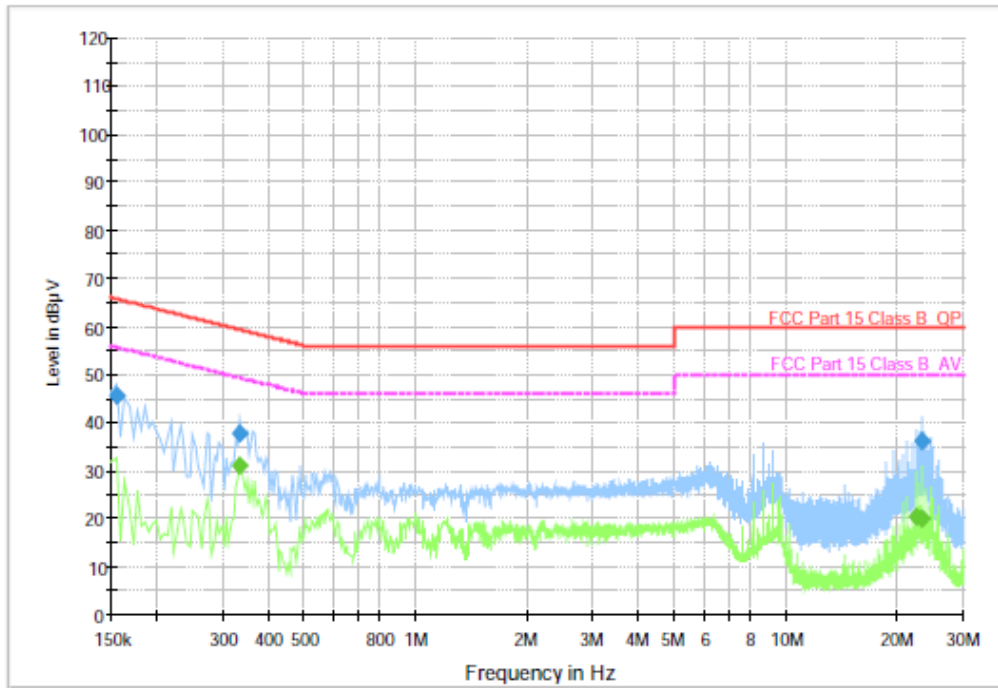

Final Measurement Detector 1

Frequency (MHz)	QuasiPeak (dBµV)	Meas. Time (ms)	Bandwidth (kHz)	Filter	Line	Corr. (dB)	Margin (dB)	Limit (dBµV)	Comment
0.154500	45.6	1000.000	9.000	Off	L1	10.0	20.2	65.8	
0.334500	37.6	1000.000	9.000	Off	L1	9.9	21.7	59.3	
23.235000	36.0	1000.000	9.000	Off	L1	10.0	24.0	60.0	

Final Measurement Detector 2

Frequency (MHz)	Average (dBµV)	Meas. Time (ms)	Bandwidth (kHz)	Filter	Line	Corr. (dB)	Margin (dB)	Limit (dBµV)	Comment
0.334500	30.9	1000.000	9.000	Off	L1	9.9	18.4	49.3	
22.393500	20.3	1000.000	9.000	Off	L1	10.0	29.7	50.0	
23.239500	20.1	1000.000	9.000	Off	L1	10.0	29.9	50.0	

Temperature :	21 °C	Relative Humidity :	60%
Pressure :	101 Kpa	Test Date :	2018-03-25
Test Mode :	Mode 1	Phase :	N
Test Voltage :	AC 120V/60Hz		

Voltage with 2-Line-LISN

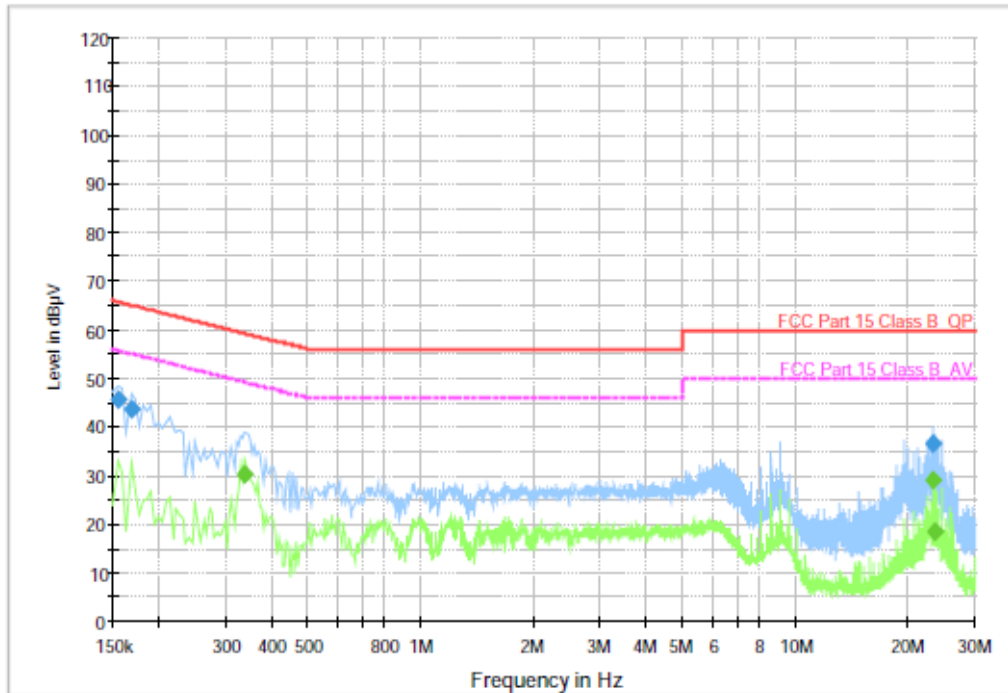

Final Measurement Detector 1

Frequency (MHz)	QuasiPeak (dBµV)	Meas. Time (ms)	Bandwidth (kHz)	Filter	Line	Corr. (dB)	Margin (dB)	Limit (dBµV)	Comment
0.154500	45.7	1000.000	9.000	Off	N	9.6	20.1	65.8	
0.168000	43.8	1000.000	9.000	Off	N	9.6	21.3	65.1	
23.235000	36.7	1000.000	9.000	Off	N	10.1	23.3	60.0	

Final Measurement Detector 2

Frequency (MHz)	Average (dBµV)	Meas. Time (ms)	Bandwidth (kHz)	Filter	Line	Corr. (dB)	Margin (dB)	Limit (dBµV)	Comment
0.339000	30.1	1000.000	9.000	Off	N	9.8	19.1	49.2	
23.230500	29.1	1000.000	9.000	Off	N	10.1	20.9	50.0	
23.568000	18.4	1000.000	9.000	Off	N	10.1	31.6	50.0	

7.2. Radiated Emission

Limit

For intentional device, according to § 15.209(a), § 15.249(a), the general requirement of field strength of radiated emission from intentional radiators at a distance of 3 meters shall not exceed the following table.

The frequency spectrum above 1 GHz for Transmitter was investigated. All emission not reported are much lower than the prescribed limits. Set the RBW=1MHz, VBW=3MHz for Peak Detector while the RBW=1MHz, VBW=10Hz for Average Detector, Readings are both peak and average values. The pre-test have done for the EUT in three axes and found the worst emission at position shown in test setup photos.

Frequency (MHz)	Distance (Meters)	Radiated (dBuV/m)	Radiated (µV/m)
0.009-0.49	3	$20\log(2400/F(KHz))+40\log(300/3)$	$2400/F(KHz)$
0.49-1.705	3	$20\log(24000/F(KHz))+40\log(30/3)$	$24000/F(KHz)$
1.705-30	3	$20\log(30)+40\log(30/3)$	30
30-88	3	40.0	100
88-216	3	43.5	150
216-960	3	46.0	200
Above 960	3	54.0	500

Test Procedure

- The EUT was placed on a turn table which is 0.8m(below 1GHz)or1.5m(above 1GHz) above ground plane.
- Maximum procedure was performed by raising the receiving antenna from 1m to 4m and rotating the turn table from 0° to 360° to acquire the highest emissions from EUT
- And also, each emission was to be maximized by changing the polarization of receiving antenna both horizontal and vertical.
- Repeat above procedures until all frequency measurements have been completed.

Field Strength Calculation

The field strength is calculated by adding the Antenna Factor and Cable Factor and subtracting the Amplifier Gain and Duty Cycle Correction Factor (if any) from the measured reading. The basic equation with a sample calculation is as follows:

$$FS = RA + AF + CL - AG$$

Where	FS = Field Strength	CL = Cable Attenuation Factor (Cable Loss)
	RA = Reading Amplitude	AG = Amplifier Gain
	AF = Antenna Factor	

For example

Frequency (MHz)	FS (dBµV/m)	RA (dBµV/m)	AF (dB)	CL (dB)	AG (dB)	Transd (dB)
150.00	40	58.1	12.2	1.6	31.90	-18.1

$$\text{Transd} = \text{AF} + \text{CL} - \text{AG}$$

Test Configuration

For the actual test configuration, please refer to the related Item –EUT Test Photos.

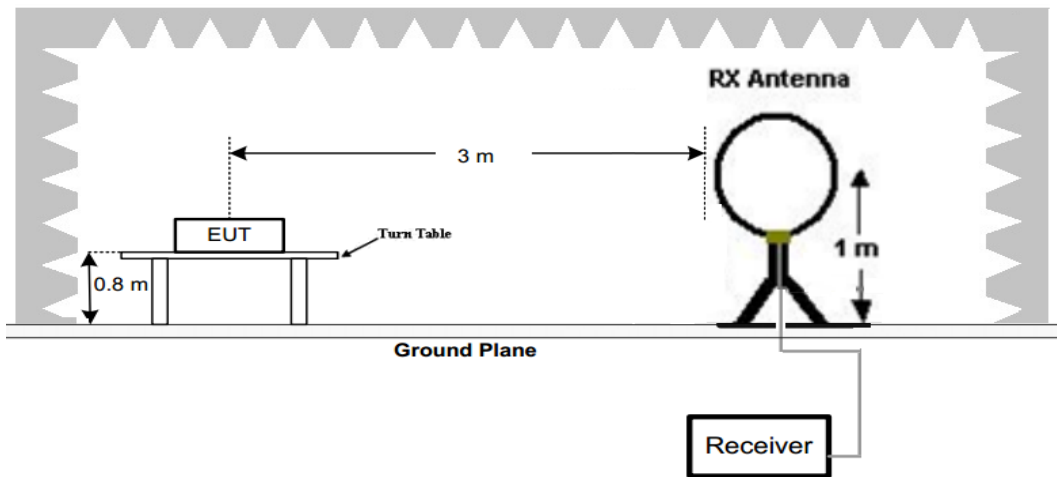
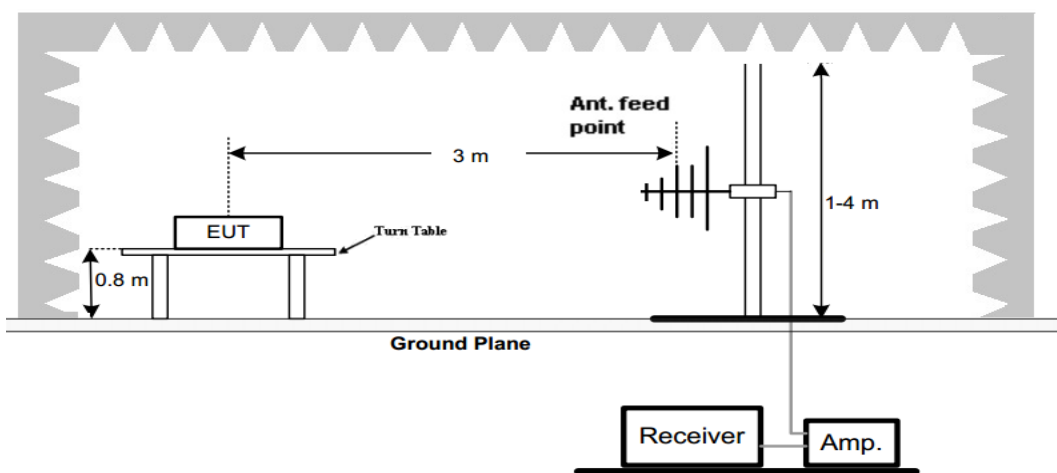
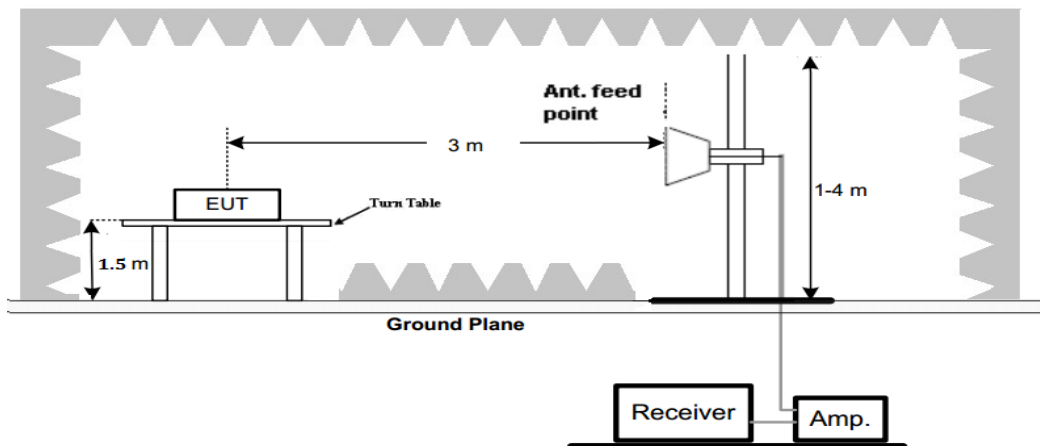
Frequency range 9 KHz – 30MHz**Frequency range 30MHz – 1000MHz****Frequency range above 1GHz-25GHz****Test Results**

Remark:

For 9 KHz-30MHz

The test results of 9kHz-30MHz is attenuated more than 20dB below the permissible limits, so the results don't record in the report.

For 30MHz-1GHz

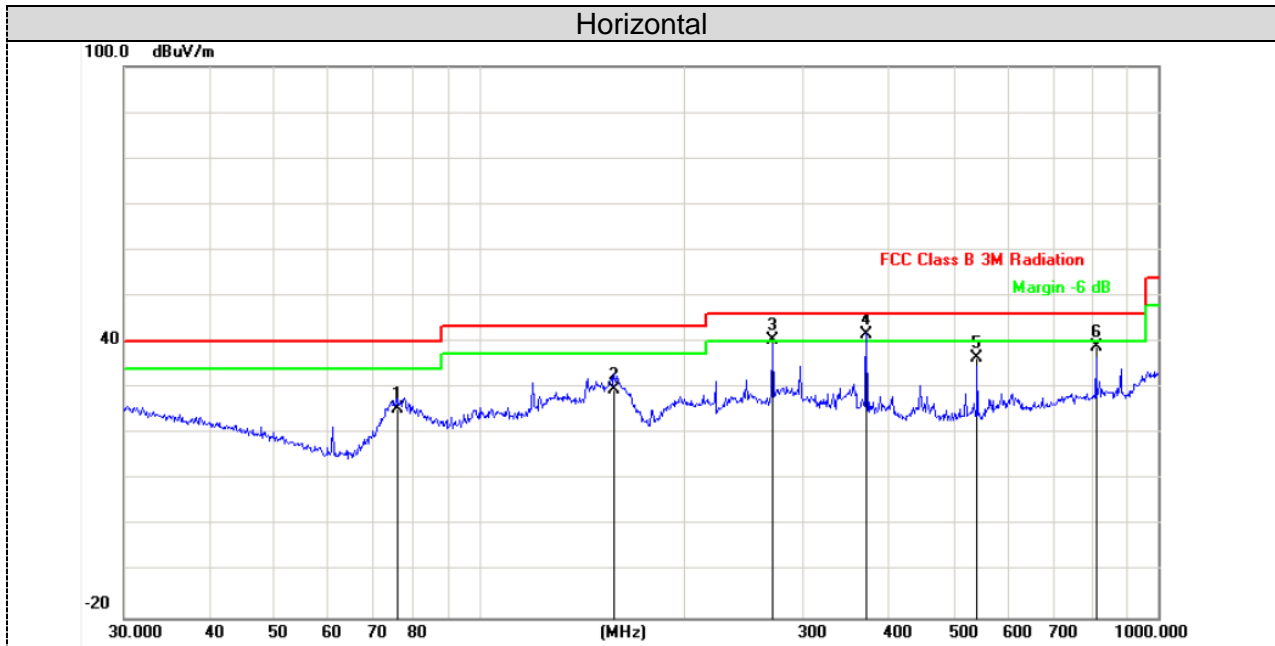

No.	Frequency (MHz)	Factor (dB/m)	Reading (dBuV)	Level (dBuV/m)	Limit (dBuV/m)	Margin (dB)	Detector	Height (cm)	Azimuth ()	P/F	Remark
1	75.7114	-18.58	44.08	25.50	40.00	-14.50	QP			P	
2	158.1123	-16.75	46.35	29.60	43.50	-13.90	QP			P	
3	270.3748	-12.28	52.68	40.40	46.00	-5.60	QP			P	
4	372.0045	-10.62	52.22	41.60	46.00	-4.40	QP			P	
5	541.3725	-7.93	44.53	36.60	46.00	-9.40	QP			P	
6	810.2653	-4.11	43.01	38.90	46.00	-7.10	QP			P	



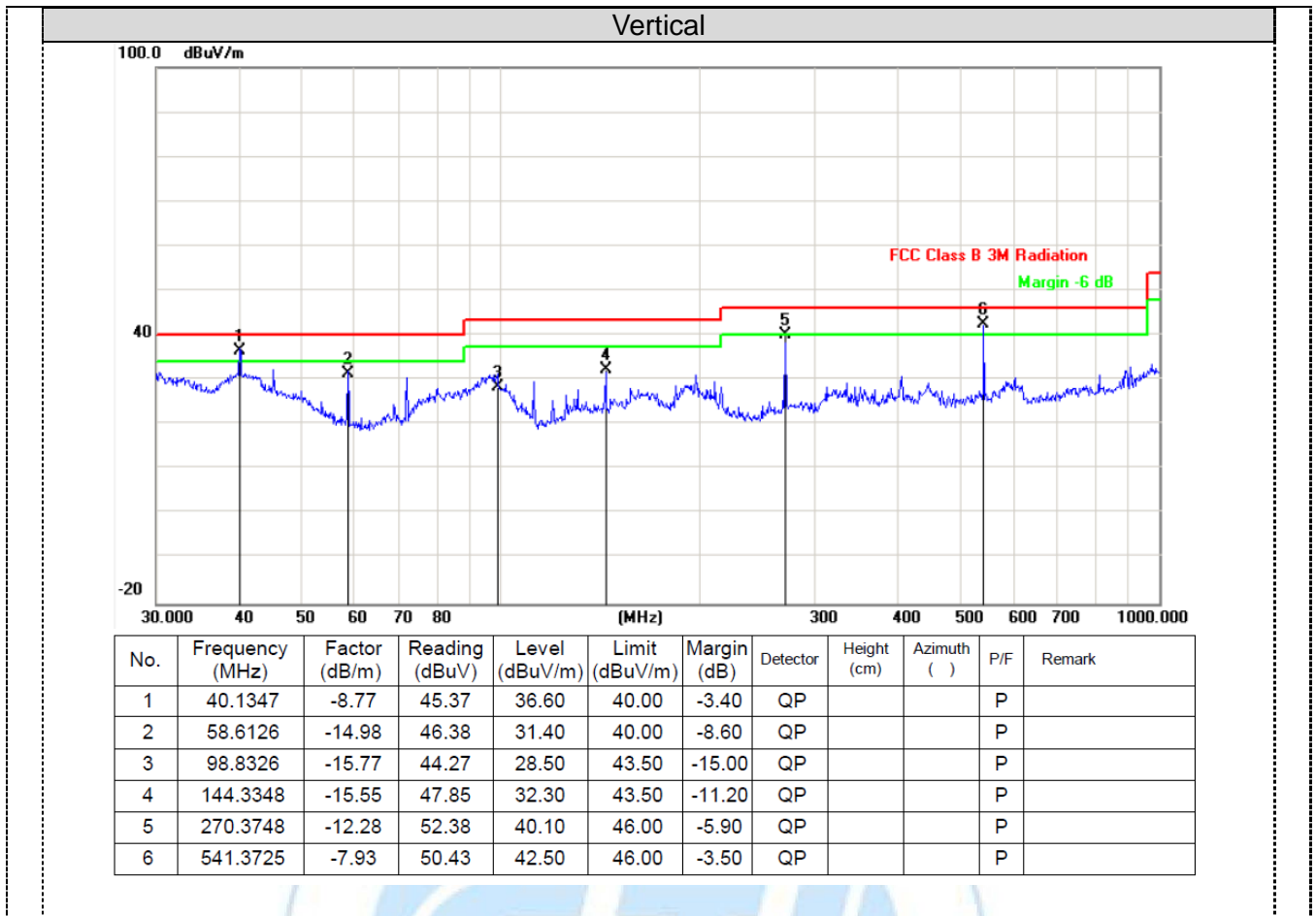

Polar (H/V)	Frequency (MHz)	Meter Reading (dBuV)	Pre-amplifier (dB)	Cable Loss (dB)	Antenna Factor (dB/m)	Emission Level (dBuV/m)	Limits (dBuV/m)	Margin (dB)	Detector Type
H	2457	86.11	36.2	4.25	30.1	84.26	114	-29.74	PK
H	2457	74.69	36.2	4.25	30.1	72.84	94	-21.16	AV
V	2457	88.65	36.2	4.25	30.1	86.80	114	-27.20	PK
V	2457	76.14	36.2	4.25	30.1	74.29	94	-19.71	AV

REMARKS:

1. Emission level (dBuV/m) = Raw Value (dBuV) + Correction Factor (dB/m)
2. Correction Factor (dB/m) = Antenna Factor (dB/m) + Cable Factor (dB) - Pre-amplifier Factor
3. Margin value = Limit value - Emission level.
4. -- Mean the PK detector measured value is below average limit.
5. The other emission levels were very low against the limit.

Above 1GHz emission please refer to C180406Z02-RP1 report

7.3.20dB Bandwidth

Limit

unwanted emissions outside of the frequency bands shown in these alternative provisions must be attenuated to the emission limits shown in §15.209.

Test Procedure

1. The transmitter output was connected to the spectrum analyzer.
2. Set SA as follow:
 - a) RBW: 100 kHz.
 - b) VBW: $\geq 3 \times$ RBW.
 - c) Detector: Peak.
 - d) Trace mode: max hold.
 - e) Sweep: auto couple.
3. Allow the trace to stabilize.
4. Measure the maximum width of the emission that is constrained by the frequencies associated with the two outermost amplitude points (upper and lower frequencies) that are attenuated by 6 dB relative to the maximum level measured in the fundamental emission.

Test Configuration



Test Results

ANT+				
Type	Channel	20dB Bandwidth (MHz)	99% Bandwidth (MHz)	Result
GFSK	00	1.1016	0.9952	Pass

Test plot as follows:

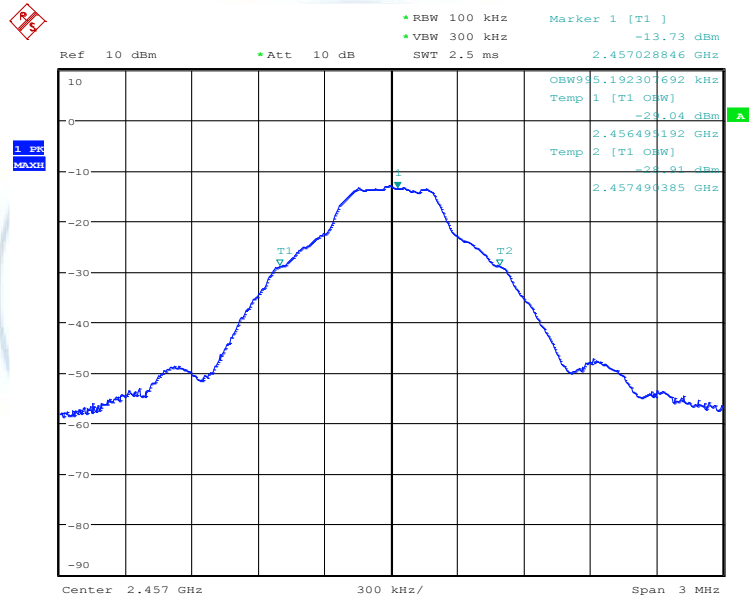
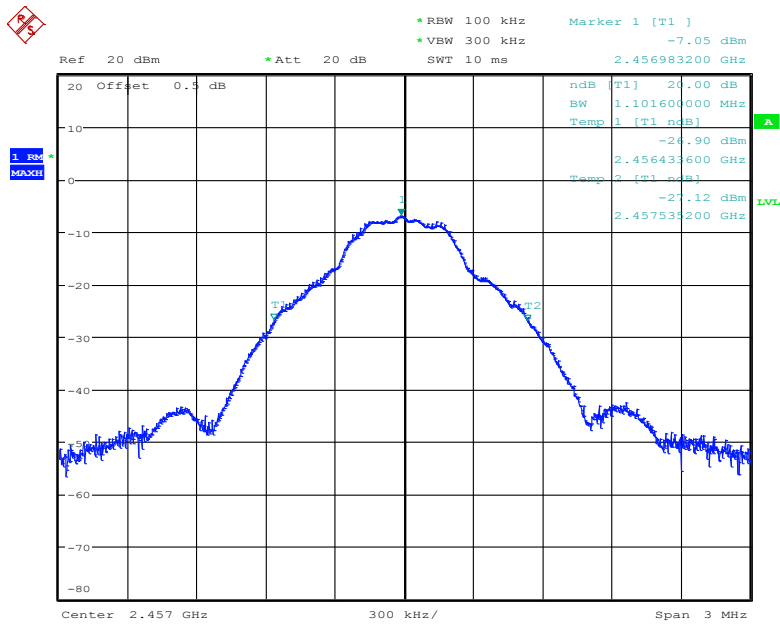

7.4. Band edge Test Test

Limit

For intentional device, according to § 15.249(d), Emissions radiated outside of the specified frequency bands, except for harmonics, shall be attenuated by at least 50 dB below the level of the fundamental or to the general radiated emission limits in 15.209, whichever is the lesser attenuation.

Test Procedure

The frequency spectrum above 1 GHz for Transmitter was investigated. All emission not reported are much lower than the prescribed limits. Set the RBW=1MHz, VBW=3MHz for Peak Detector while the RBW=1MHz, VBW=10Hz for Average Detector, Readings are both peak and average values. The pre-test have done for the EUT in three axes and found the worst emission at position shown in test setup photos.

1. The EUT was placed on a turn table which is 0.8m(below 1GHz)or1.5m(above 1GHz) above ground plane
2. . The table was rotated 360 degrees to determine the position of the highest radiation.
3. The EUT was set 3 meters away from the interference receiving antenna, which was mounted on the top of a variable height antenna tower.
4. The antenna height is varied from one meter to four meters above the ground to determine the maximum value of the field strength. Both horizontal and vertical polarizations of the antenna are set to make the measurement.
5. For each suspected emission, the EUT was arranged to its worst case and then the antenna was tuned to heights from 1 meter to 4 meters and the rotatable table was turned from 0 degrees to 360 degrees to find the maximum reading.
6. The test-receiver system was set to Peak Detect Function and Specified Bandwidth with Maximum Hold Mode.
7. Place a marker at the end of the restricted band closest to the transmit frequency to show compliance. Also measure any emissions in the restricted bands. Save the spectrum analyzer plot. Repeat for each power and modulation for lowest and highest channel
8. Test the EUT in the lowest channel, the highest channel
9. The radiation measurements are performed in X, Y, Z axis positioning. And found the X axis positioning which it is worse case, only the test worst case mode is recorded in the report.
10. Repeat above procedures until all frequencies measured was complete.

Field Strength Calculation

The field strength is calculated by adding the Antenna Factor and Cable Factor and subtracting the Amplifier Gain and Duty Cycle Correction Factor (if any) from the measured reading. The basic equation with a sample calculation is as follows:

$$FS = RA + AF + CL - AG$$

Where	FS = Field Strength	CL = Cable Attenuation Factor (Cable Loss)
	RA = Reading Amplitude	AG = Amplifier Gain
	AF = Antenna Factor	

For example

Frequency (MHz)	FS (dBµV/m)	RA (dBµV/m)	AF (dB)	CL (dB)	AG (dB)	Transd (dB)
150.00	40	58.1	12.2	1.6	31.90	-18.1

$$\text{Transd} = \text{AF} + \text{CL} - \text{AG}$$

Test Configuration

For the actual test configuration, please refer to the related Item –EUT Test Photos.

Frequency range 30MHz – 1000MHz

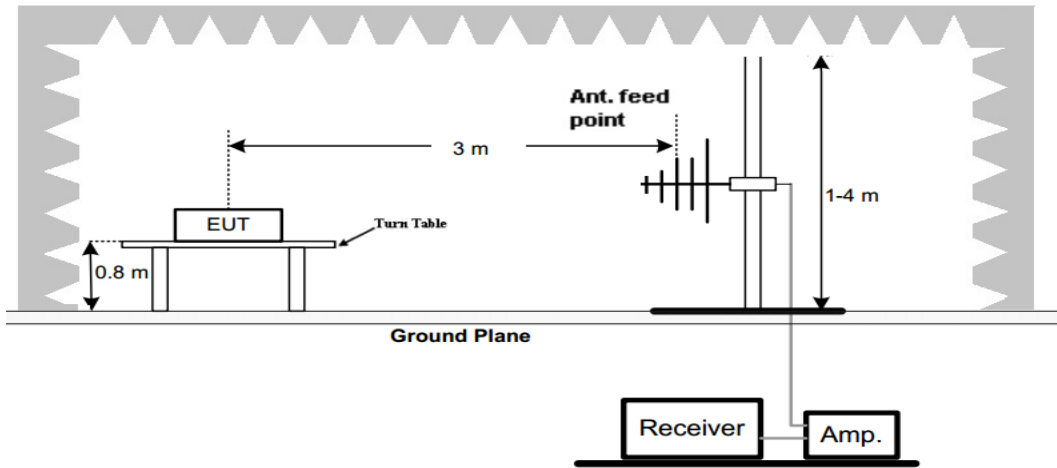

Frequency range above 1GHz-25GHz

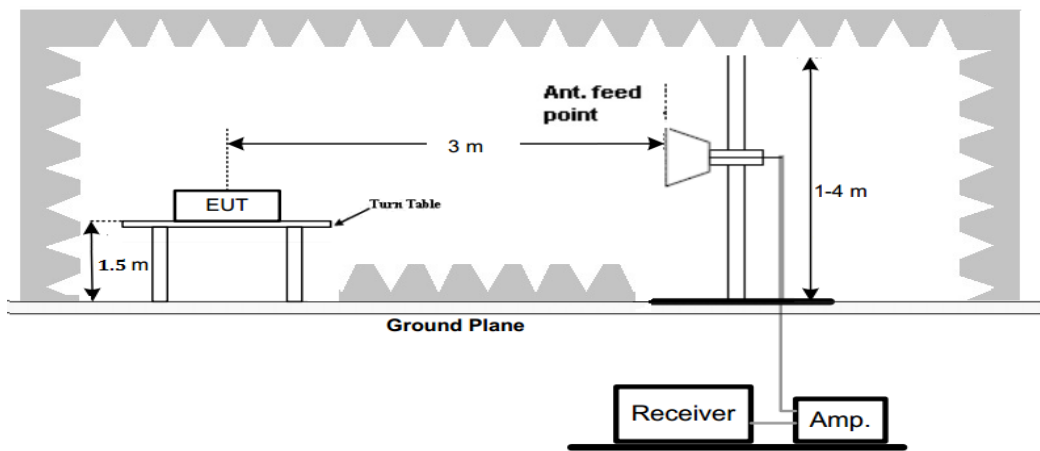

Test Results

Remark:

2457MHz									
Polar	Frequency	Meter Reading	Pre-amplifier	Cable Loss	Antenna Factor	Emission Level	Limits	Margin	Detector
(H/V)	(MHz)	(dBuV)	(dB)	(dB)	(dB/m)	(dBuV/m)	(dBuV/m)	(dB)	Type
H	2390	47.49	36.12	3.32	27.5	42.19	74	-31.81	PK
H	2390	36.45	36.12	3.32	27.5	31.15	54	-22.85	AV
V	2390	49.19	36.12	3.32	27.5	43.89	74	-30.11	PK
V	2390	35.89	36.12	3.32	27.5	30.59	54	-23.41	AV

2457MHz									
Polar	Frequency	Meter Reading	Pre-amplifier	Cable Loss	Antenna Factor	Emission Level	Limits	Margin	Detector
(H/V)	(MHz)	(dBuV)	(dB)	(dB)	(dB/m)	(dBuV/m)	(dBuV/m)	(dB)	Type
H	2483.5	47.75	36.55	3.38	27.5	42.08	74	-31.92	PK
H	2483.5	37.33	36.55	3.38	27.5	31.66	54	-22.34	AV
V	2483.5	46.64	36.55	3.38	27.5	40.97	74	-33.03	PK
V	2483.5	35.64	36.55	3.38	27.5	29.97	54	-24.03	AV

7.5. Antenna Requirement

Standard Applicable

For intentional device, according to FCC 47 CFR Section 15.203:

An intentional radiator shall be designed to ensure that no antenna other than that furnished by the responsible party shall be used with the device. The use of a permanently attached antenna or of an antenna that uses a unique coupling to the intentional radiator, the manufacturer may design the unit so that a broken antenna can be replaced by the user, but the use of a standard antenna jack or electrical connector is prohibited

Result

The EUT's antenna used a Antenna, soldered on the PCB., The antenna's gain is 4.17dBi. Complying with the standard requirement.

Test Result:

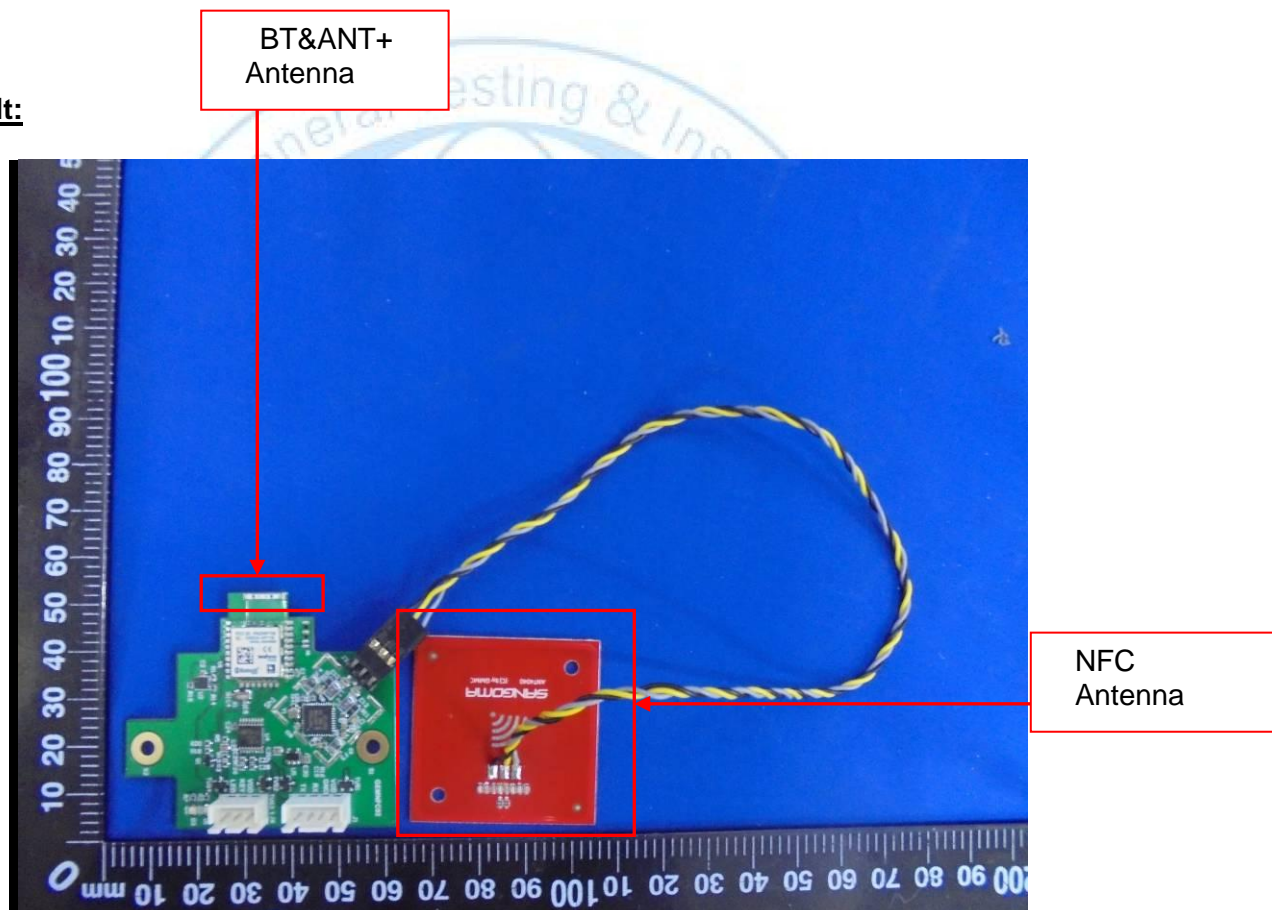

8. EUT TEST PHOTO

Conducted Emission

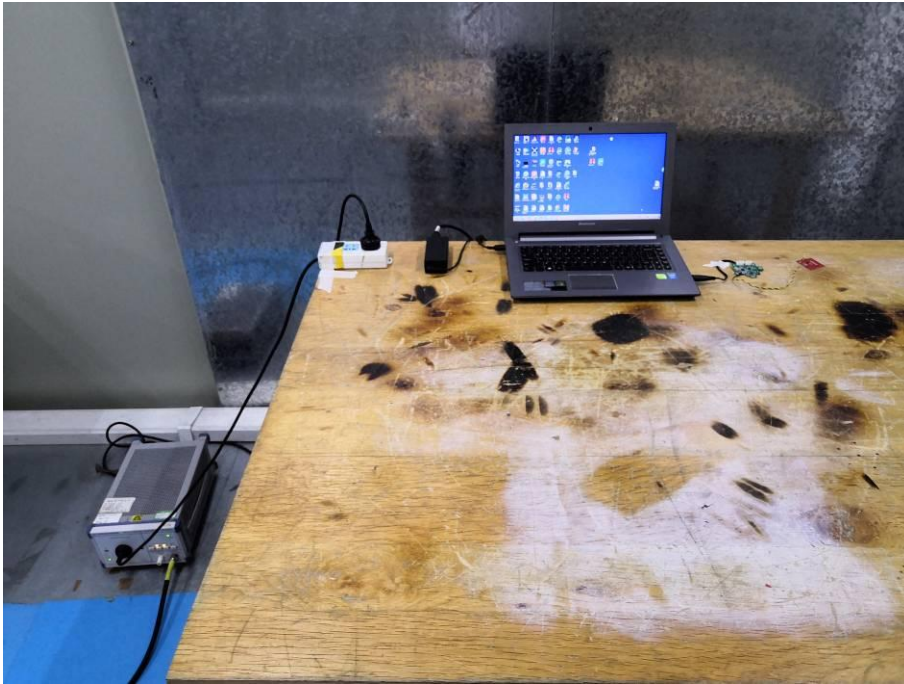

Radiated Emission

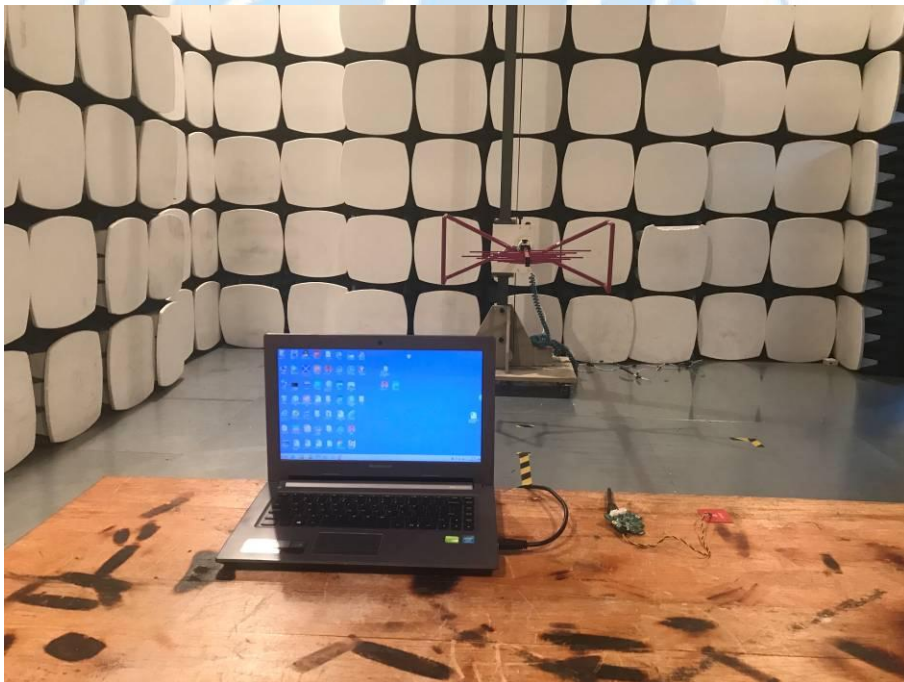





9. PHOTOGRAPHS OF EUT CONSTRUCTIONAL

Please reference to the test report No.: GTI20180533F-1

*****THE END*****

