

FCC TEST REPORT
for
Wahoo Fitness LLC

KICKR
Model No.: WF113

Prepared for : Wahoo Fitness LLC
Address : 90 W. Wieuca Road #110 Atlanta, GA 30342, United States

Prepared By : Shenzhen Anbotek Compliance Laboratory Limited
Address : 1/F., Building 1, SEC Industrial Park, No.0409 Qianhai Road,
Nanshan District, Shenzhen, Guangdong, China
Tel: (86) 755-26066544
Fax: (86) 755-26014772

Report Number : R011606622Y
Date of Test : Jun. 16~ Jul. 28, 2016
Date of Report : Jul. 28, 2016

TABLE OF CONTENT

Description	Page
Test Report	
1. GENERAL INFORMATION.....	4
1.1. Description of Device (EUT).....	4
1.2. Auxiliary Equipment Used during Test.....	5
1.3. Description of Test Facility.....	5
1.4. Measurement Uncertainty.....	5
2. TEST METHODOLOGY.....	6
2.1. Summary of Test Results.....	6
2.2. Description of Test Modes.....	6
3. CONDUCTED EMISSION TEST.....	7
3.1. Block Diagram of Test Setup.....	7
3.2. Power Line Conducted Emission Measurement Limits (15.207).....	7
3.3. Configuration of EUT on Measurement.....	7
3.4. Operating Condition of EUT.....	7
3.5. Test Procedure.....	8
3.6. Test equipment.....	8
3.7. Power Line Conducted Emission Measurement Results.....	8
4. FCC PART 15.247 REQUIREMENTS FOR DSSS & OFDM MODULATION.....	13
4.1 Test Setup.....	13
4.2 6dB Bandwidth.....	13
4.3. Maximum Peak output power test.....	17
4.4. Band Edges Measurement.....	20
4.5. Peak Power Spectral Density.....	31
4.6. Radiated Emissions.....	34
5. ANTENNA APPLICATION.....	45
5.1. Antenna requirement.....	45
5.2. Result.....	45
6. PHOTOGRAPH.....	46
6.1 Photo of Conducted Emission Test.....	46
6.2 Photo of Radiation Emission Test.....	46
APPENDIX I (EXTERNAL PHOTOS).....	48
APPENDIX II (INTERNAL PHOTOS).....	52

TEST REPORT

Applicant : Wahoo Fitness LLC
Manufacturer : Wahoo Fitness LLC
EUT : KICKR
Model No. : WF113
Serial No. : N.A.
Trade Mark : N.A.
Rating : DC 12V, 5A

Measurement Procedure Used:
FCC Part15 Subpart C 2015, Paragraph 15.247

The device described above is tested by Shenzhen Anbotek Compliance Laboratory Limited to determine the maximum emission levels emanating from the device and the severe levels of the device can endure and its performance criterion. The measurement results are contained in this test report and Shenzhen Anbotek Compliance Laboratory Limited is assumed full of responsibility for the accuracy and completeness of these measurements. Also, this report shows that the EUT (Equipment Under Test) is technically compliant with the FCC Part 15 Subpart C requirements.

This report applies to above tested sample only and shall not be reproduced in part without written approval of Shenzhen Anbotek Compliance Laboratory Limited.

Date of Test : Jun. 16~ Jul. 28, 2016

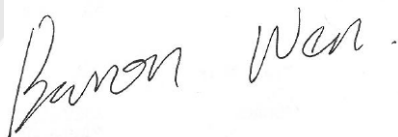
Prepared by : 
(Tested Engineer / Baron Wen)

Reviewer : 
(Project Manager / Amy Ding)

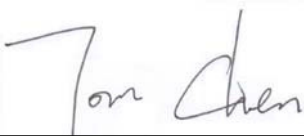
Approved & Authorized Signer : 
(Manager / Tom Chen)

1. GENERAL INFORMATION

1.1. Description of Device (EUT)

EUT : KICKR

Model Number : WF113

Test Power Supply : AC 120V, 60Hz for adapter/
AC 240V, 60Hz for adapter

Adapter : Model: SW60-12005000-W
Input: AC 100-240V, 50/60Hz, 1.5A
Output: DC 12V, 5.0A

Frequency : BT: 2402~2480MHz
ANT+: 2402~2480MHz

Modulation : BT: GFSK
ANT+: GFSK

Channel Spacing : BT: 2MHz
ANT+: 2MHz

Number of Channels : BT: 40
ANT+: 40

Antenna Type : Ceramic Chip Antenna (BT & ANT+)

Antenna Gain : 5.46 dBi (BT & ANT+)

Applicant : Wahoo Fitness LLC
Address : 90 W. Wieuca Road #110 Atlanta, GA 30342, United States

Manufacturer : Wahoo Fitness LLC
Address : 90 W. Wieuca Road #110 Atlanta, GA 30342, United States

Factory : Wahoo Fitness LLC
Address : 90 W. Wieuca Road #110 Atlanta, GA 30342, United States

Date of receipt : Jun. 16, 2016

Date of Test : Jun. 16~ Jul. 28, 2016

1.2. Auxiliary Equipment Used during Test

N/A

1.3. Description of Test Facility

The test facility is recognized, certified, or accredited by the following organizations:

FCC-Registration No.: 752021

Shenzhen Anbotek Compliance Laboratory Limited, EMC Laboratory has been registered and fully described in a report filed with the (FCC) Federal Communications Commission. The acceptance letter from the FCC is maintained in our files. Registration 752021, July 06, 2016.

IC-Registration No.: 8058A-1

Shenzhen Anbotek Compliance Laboratory Limited., EMC Laboratory has been registered and fully described in a report filed with the (IC) Industry Canada. The acceptance letter from the IC is maintained in our files. Registration 8058A-1, Jun. 13, 2016.

Test Location

All Emissions tests were performed at Shenzhen Anbotek Compliance Laboratory Limited. at 1/F., Building 1, SEC Industrial Park, No.0409 Qianhai Road, Nanshan District, Shenzhen, Guangdong, China

1.4. Measurement Uncertainty

Radiation Uncertainty : Ur = 4.1 dB (Horizontal)
Ur = 4.3 dB (Vertical)

Conduction Uncertainty : Uc = 3.4dB

2. TEST METHODOLOGY

The tests documented in this report were performed in accordance with ANSI C63.10: 2013 and FCC Part 15, Paragraph 15.247.

2.1. Summary of Test Results

The EUT has been tested according to the following specifications:

Standard	Test Type	Result	Notes
FCC Part 15, Paragraph 15.107, 15.207	Conducted Emission Test	PASS	Complies
FCC Part 15, Paragraph 15.247(b)(1)	Peak Output Power	PASS	Complies
FCC Part 15, Paragraph 15.247(a)(2)	6dB Bandwidth	PASS	Complies
FCC Part 15, Paragraph 15.247(c)	100kHz Bandwidth of Frequency Band Edges	PASS	Complies
FCC Part 15, Paragraph 15.209(a)(f)	Spurious Emission	PASS	Complies
FCC Part 15, Paragraph 15.247(a)(1)	Frequency Separation	-	N/A
FCC Part 15, Paragraph 15.247(a)(1)(iii)	Number of Hopping Frequency	-	N/A
FCC Part 15, Paragraph 15.247(a)(1)(iii)	Time of Occupancy	-	N/A
FCC Part 15, Paragraph 15.247(c)	Peak Power Density	PASS	Complies

2.2. Description of Test Modes

The EUT has been tested under operating condition.

Software used to control the EUT for staying in continuous transmitting and receiving mode is programmed.

Channel Low(2402MHz), Channel Middle(2440MHz) and Channel High(2480MHz) are chosen for the final testing.

3. Conducted Emission Test

3.1. Block Diagram of Test Setup

3.1.1. Block diagram of connection between the EUT and simulators

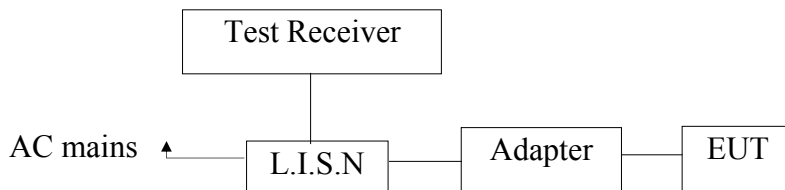

3.2. Power Line Conducted Emission Measurement Limits (15.207)

Frequency MHz	Limits dB(μV)	
	Quasi-peak Level	Average Level
0.15 ~ 0.50	66 ~ 56*	56 ~ 46*
0.50 ~ 5.00	56	46
5.00 ~ 30.00	60	50

- Notes: 1. *Decreasing linearly with logarithm of frequency.
2. The lower limit shall apply at the transition frequencies.

3.3. Configuration of EUT on Measurement

The following equipments are installed on Power Line Conducted Emission Measurement to meet the commission requirement and operating regulations in a manner which tends to maximize its emission characteristics in a normal application.

3.4. Operating Condition of EUT

- 3.4.1. Setup the EUT and simulator as shown as Section 3.1.
- 3.4.2. Turn on the power of all equipment.
- 3.4.3. Let the EUT work in test mode (On) and measure it.

3.5. Test Procedure

The EUT system is connected to the power mains through a line impedance stabilization network (L.I.S.N.). This provides a 50ohm coupling impedance for the EUT system. Please refer the block diagram of the test setup and photographs. Both sides of AC line are checked to find out the maximum conducted emission. In order to find the maximum emission levels, the relative positions of equipment and all of the interface cables shall be changed according to FCC ANSI C63.10-2013 on Conducted Emission Measurement.

The bandwidth of test receiver (ESCI) set at 9KHz.

The frequency range from 150KHz to 30MHz is checked.

The test results are reported on Section 3.6.

3.6. Test equipment

Item	Equipment	Manufacturer	Model No.	Serial No.	Last Cal.	Cal. Interval
1.	Two-Line V-network	Rohde & Schwarz	ENV216	100055	Apr. 16, 2016	1 Year
2.	EMI Test Receiver	Rohde & Schwarz	ESCI	100627	Apr. 16, 2016	1 Year
3.	RF Switching Unit	Compliance Direction	RSU-M2	38303	Apr. 16, 2016	1 Year

3.7. Power Line Conducted Emission Measurement Results

PASS.

The frequency range from 150KHz to 30 MHz is investigated.

Please refer the following pages.

CONDUCTED EMISSION TEST DATA

Test Site: 1# Shielded Room
 Operating Condition: On
 Test Specification: AC 120V, 60Hz for adapter
 Comment: Live Line
 Tem.:24°C Hum.:49%

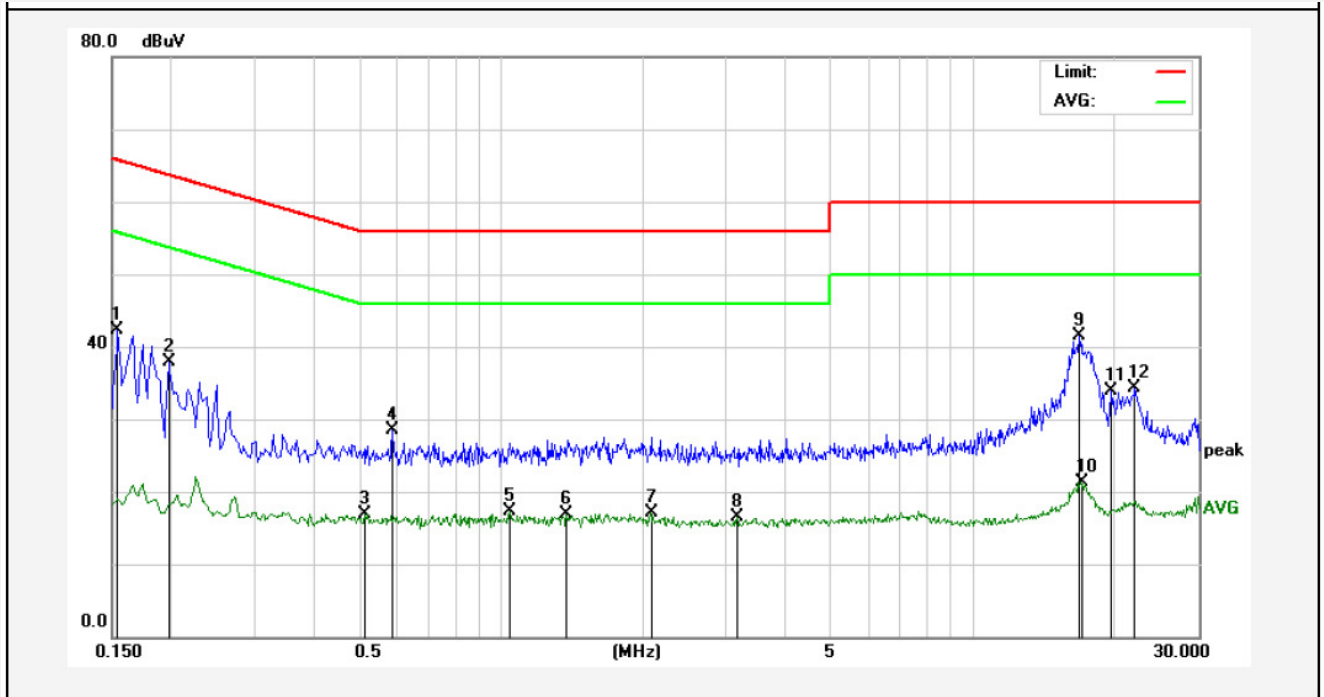

No.	Freq. (MHz)	Reading (dBuV)	Factor (dB)	Result (dBuV)	Limit dBuV	Over Limit (dB)	Detector	Remark
1	0.1539	22.30	20.00	42.30	65.78	-23.48	QP	
2	0.1980	17.81	20.00	37.81	63.69	-25.88	QP	
3	0.5140	-3.02	20.00	16.98	46.00	-29.02	AVG	
4	0.5899	8.57	20.00	28.57	56.00	-27.43	QP	
5	1.0460	-2.79	20.00	17.21	46.00	-28.79	AVG	
6	1.3740	-3.09	20.00	16.91	46.00	-29.09	AVG	
7	2.0740	-2.95	20.00	17.05	46.00	-28.95	AVG	
8	3.1619	-3.57	20.00	16.43	46.00	-29.57	AVG	
9	16.8219	21.41	20.00	41.41	60.00	-18.59	QP	
10	16.8859	1.28	20.00	21.28	50.00	-28.72	AVG	
11	19.5939	13.97	20.00	33.97	60.00	-26.03	QP	
12	21.9980	14.34	20.00	34.34	60.00	-25.66	QP	

CONDUCTED EMISSION TEST DATA

Test Site: 1# Shielded Room
 Operating Condition: On
 Test Specification: AC 120V, 60Hz for adapter
 Comment: Neutral Line
 Tem.:24°C Hum.:49%

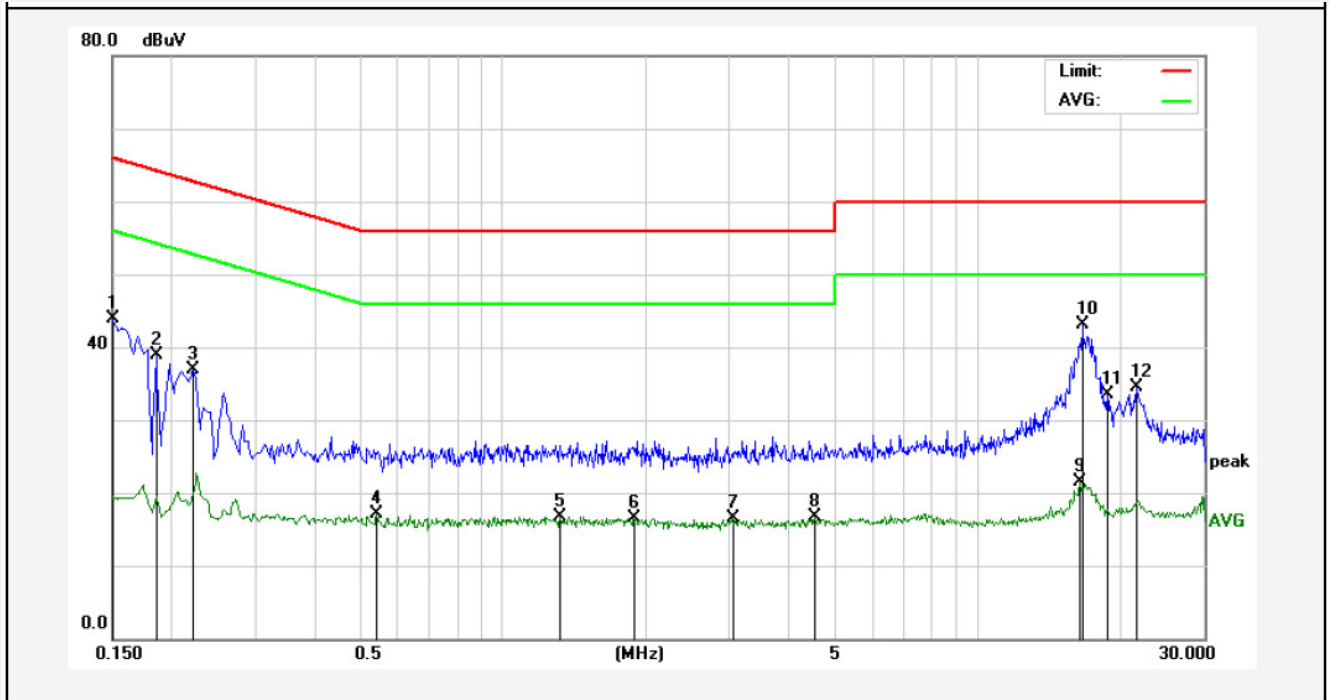

No.	Freq. (MHz)	Reading (dBuV)	Factor (dB)	Result (dBuV)	Limit dBuV	Over Limit (dB)	Detector	Remark
1	0.1499	23.99	20.00	43.99	66.00	-22.01	QP	
2	0.1860	18.82	20.00	38.82	64.21	-25.39	QP	
3	0.2220	16.83	20.00	36.83	62.74	-25.91	QP	
4	0.5420	-2.95	20.00	17.05	46.00	-28.95	AVG	
5	1.3220	-3.21	20.00	16.79	46.00	-29.21	AVG	
6	1.8780	-3.42	20.00	16.58	46.00	-29.42	AVG	
7	3.0340	-3.51	20.00	16.49	46.00	-29.51	AVG	
8	4.5339	-3.37	20.00	16.63	46.00	-29.37	AVG	
9	16.4779	1.46	20.00	21.46	50.00	-28.54	AVG	
10	16.6219	23.07	20.00	43.07	60.00	-16.93	QP	
11	18.7579	13.46	20.00	33.46	60.00	-26.54	QP	
12	21.6980	14.43	20.00	34.43	60.00	-25.57	QP	

CONDUCTED EMISSION TEST DATA

Test Site: 1# Shielded Room
 Operating Condition: On
 Test Specification: AC 240V, 60Hz for adapter
 Comment: Live Line
 Tem.:24°C Hum.:49%

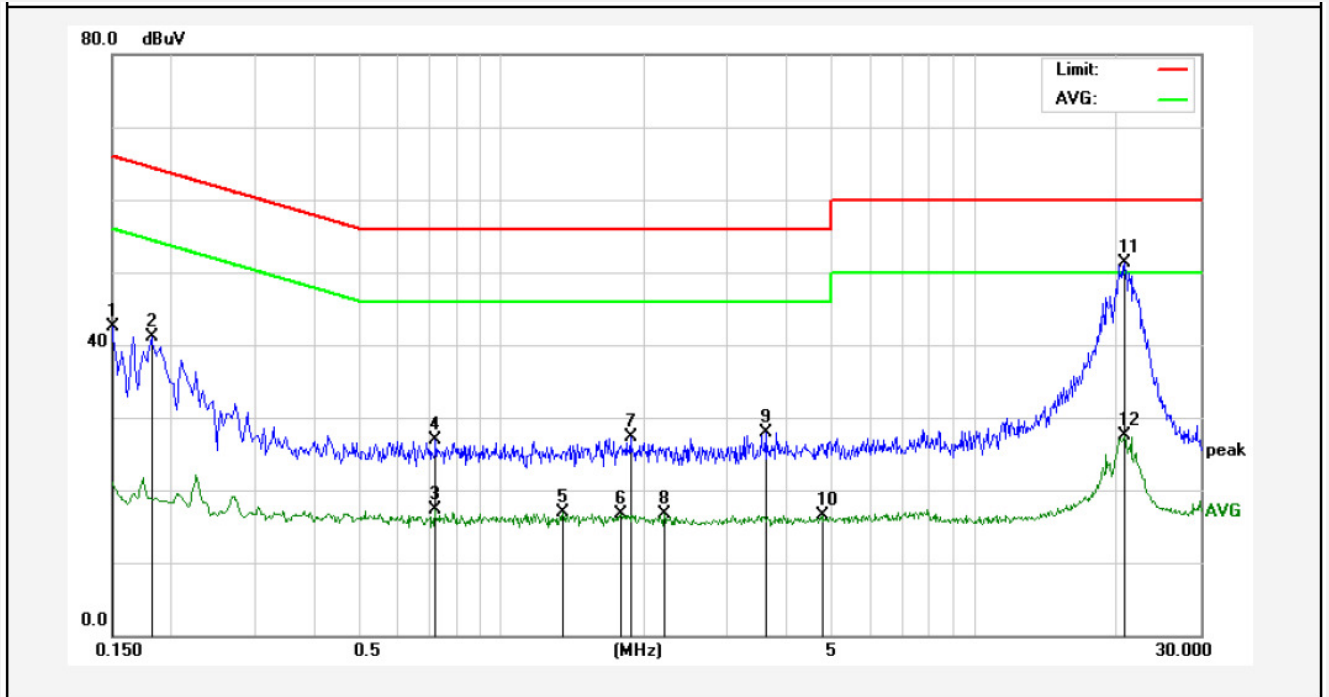

No.	Freq. (MHz)	Reading (dBuV)	Factor (dB)	Result (dBuV)	Limit dBuV	Over Limit (dB)	Detector	Remark
1	0.1500	22.46	20.00	42.46	65.99	-23.53	QP	
2	0.1819	21.19	20.00	41.19	64.39	-23.20	QP	
3	0.7220	-2.73	20.00	17.27	46.00	-28.73	AVG	
4	0.7260	6.99	20.00	26.99	56.00	-29.01	QP	
5	1.3460	-3.08	20.00	16.92	46.00	-29.08	AVG	
6	1.7860	-3.31	20.00	16.69	46.00	-29.31	AVG	
7	1.8740	7.34	20.00	27.34	56.00	-28.66	QP	
8	2.2060	-3.34	20.00	16.66	46.00	-29.34	AVG	
9	3.6060	7.83	20.00	27.83	56.00	-28.17	QP	
10	4.7700	-3.50	20.00	16.50	46.00	-29.50	AVG	
11	20.7660	31.26	20.00	51.26	60.00	-8.74	QP	
12	20.7660	7.44	20.00	27.44	50.00	-22.56	AVG	

CONDUCTED EMISSION TEST DATA

Test Site: 1# Shielded Room
 Operating Condition: On
 Test Specification: AC 240V, 60Hz for adapter
 Comment: Neutral Line
 Tem.:24°C Hum.:49%

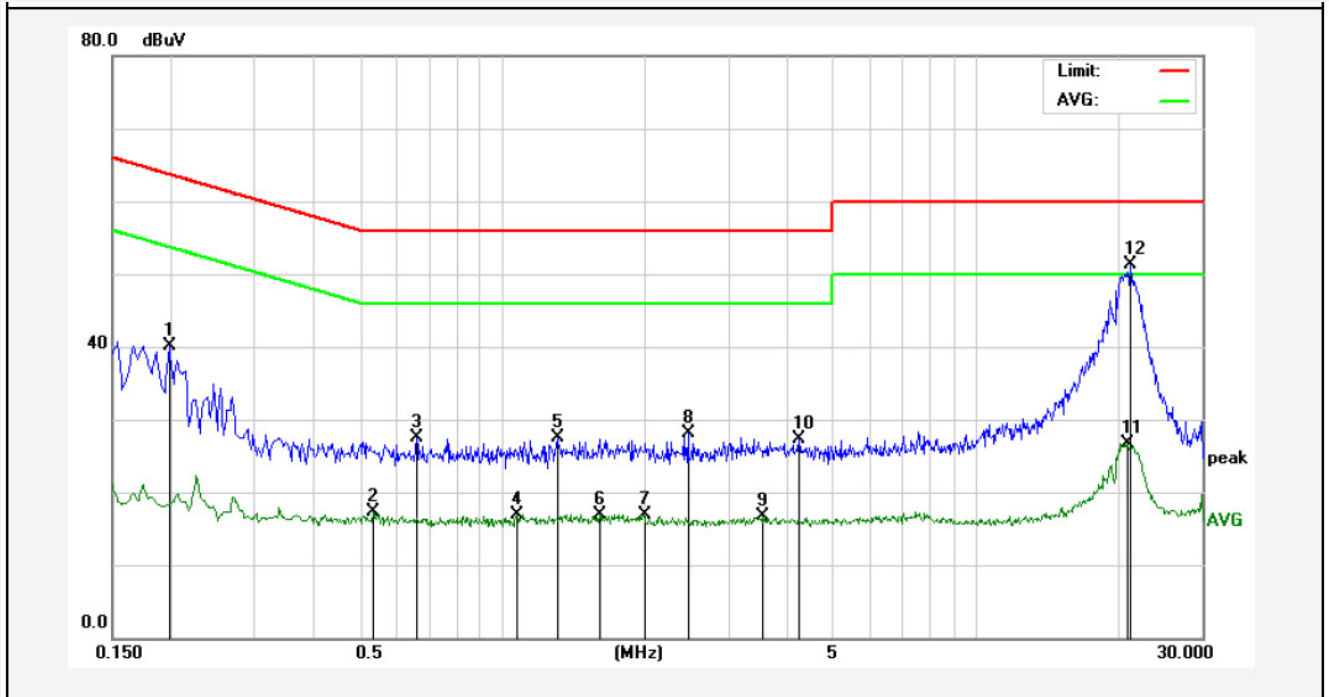

No.	Freq. (MHz)	Reading (dBuV)	Factor (dB)	Result (dBuV)	Limit dBuV	Over Limit (dB)	Detector	Remark
1	0.1980	20.17	20.00	40.17	63.69	-23.52	QP	
2	0.5340	-2.74	20.00	17.26	46.00	-28.74	AVG	
3	0.6580	7.56	20.00	27.56	56.00	-28.44	QP	
4	1.0740	-3.03	20.00	16.97	46.00	-29.03	AVG	
5	1.3060	7.59	20.00	27.59	56.00	-28.41	QP	
6	1.6019	-3.02	20.00	16.98	46.00	-29.02	AVG	
7	1.9860	-3.10	20.00	16.90	46.00	-29.10	AVG	
8	2.4660	8.17	20.00	28.17	56.00	-27.83	QP	
9	3.5460	-3.34	20.00	16.66	46.00	-29.34	AVG	
10	4.2460	7.38	20.00	27.38	56.00	-28.62	QP	
11	20.8660	6.78	20.00	26.78	50.00	-23.22	AVG	
12	21.2420	31.38	20.00	51.38	60.00	-8.62	QP	

4. FCC Part 15.247 Requirements for DSSS & OFDM Modulation

4.1 Test Setup

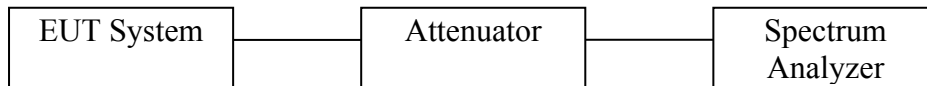

4.2 6dB Bandwidth

a. Limit

For the direct sequence systems, the minimum 6dB bandwidth shall be at least 500kHz.

b. Test Procedure

1. Place the EUT on the table and set it in the transmitting mode.
2. Remove the antenna from the EUT and then connect a low loss RF cable from the antenna port to the spectrum analyzer.
3. Set the spectrum analyzer as:
RBW = 100kHz, VBW $\geq 3 \times$ RBW = 300kHz,
Detector = Peak
Trace mode = Max hold.
Sweep - auto couple.
4. Mark the peak frequency and -6dB (upper and lower) frequency.
5. Repeat until all the rest channels are investigated.

c. Test Setup See 4.1

d. Test Equipment

Item	Equipment	Manufacturer	Model No.	Serial No.	Last Cal.	Cal. Interval
1.	Spectrum Analysis	Agilent	E4407B	US39390582	Apr. 16, 2016	1 Year
2.	Preamplifier	Instruments corporation	EMC011830	980100	Apr. 16, 2016	1 Year
3.	EMI Test Receiver	Rohde & Schwarz	ESPI	101604	Apr. 16, 2016	1 Year
4.	Double Ridged Horn Antenna	Instruments corporation	GTH-0118	351600	Apr. 19, 2016	1 Year
5.	Bilog Broadband Antenna	Schwarzbeck	VULB9163	VULB 9163-289	Apr. 19, 2016	1 Year
6.	Pre-amplifier	SONOMA	310N	186860	Apr. 16, 2016	1 Year
7.	EMI Test Software EZ-EMC	SHURPLE	N/A	N/A	N/A	N/A
8	Power Sensor	DAER	RPR3006W	15I00041SN046	Jun 30, 2016	1 Year
9	MXA Spectrum Analysis	Agilent	N9020A	MY51170037	Jun 30, 2016	1 Year
10	MXG RF Vector Signal Generator	Agilent	N5182A	MY48180656	Jun 30, 2016	1 Year
11	Signal Generator	Agilent	E4421B	MY41000743	Jun 30, 2016	1 Year
12	DC Power supply	IV	IV-8080	YQSB0096	Jun 30, 2016	1 Year
13	TEMP&HUMI PROGRAMMABLE CHAMBER	Bell Group	BE-THK-150M8	SE-0137	Mar 16, 2016	1 Year

e. Test Results

Pass.

f. Test Data

Channel	Frequency (MHz)	Bandwidth (kHz)	Limit (kHz)	Results
Low	2402	504.5		Pass
Mid	2440	506.8	>500	Pass
High	2480	508.4		Pass

Test Plots See the following page.

CH Low

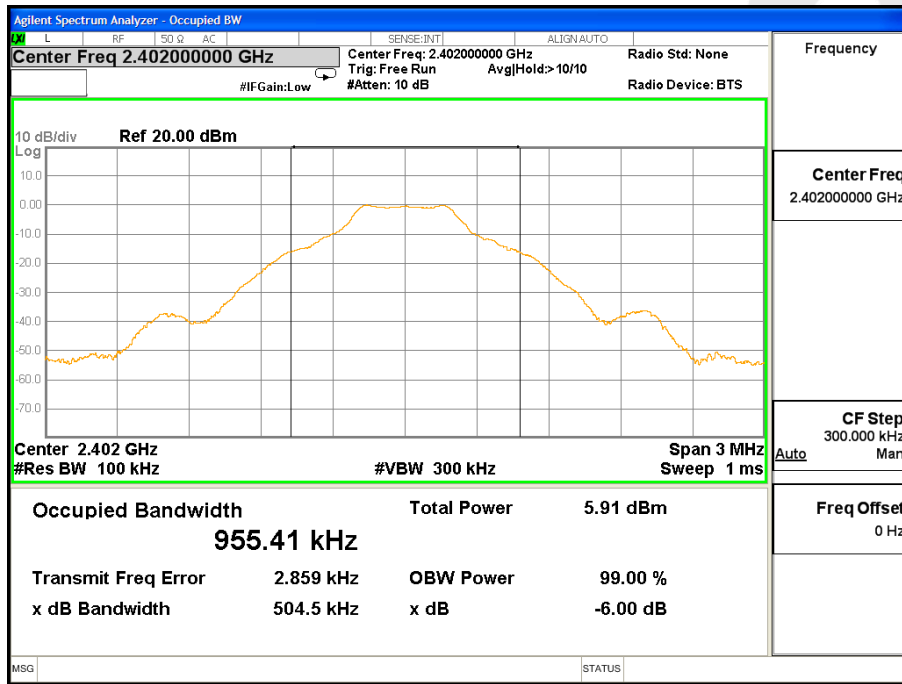

CH Mid

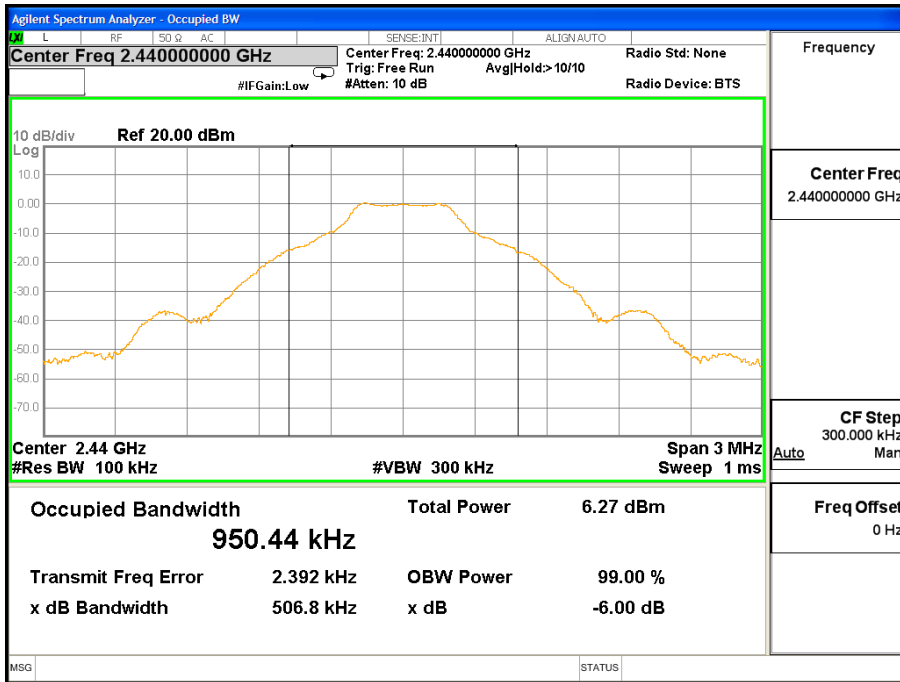

CH High

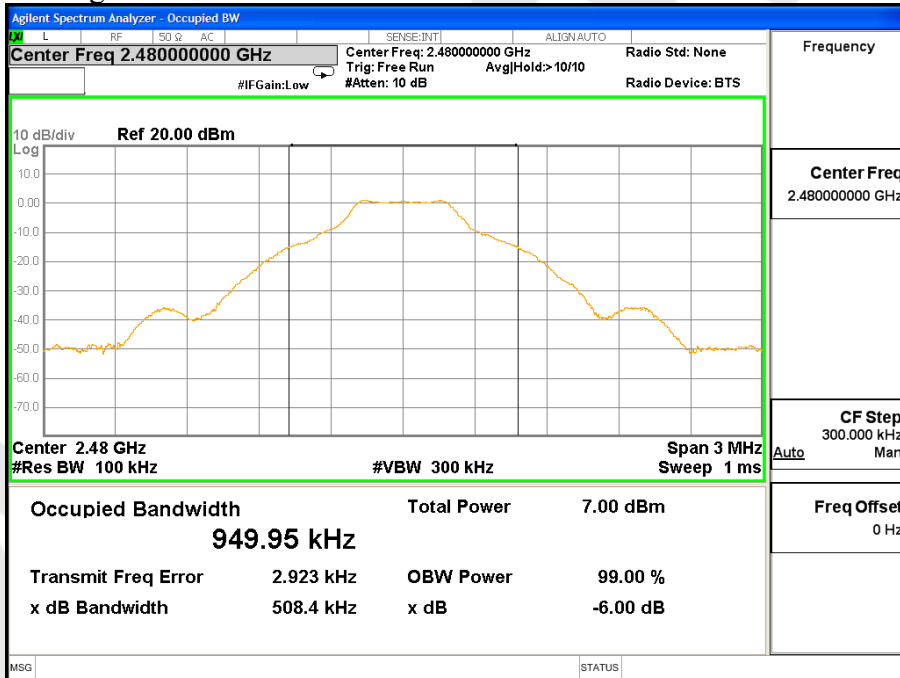

4.3. Maximum Peak output power test

a. Limit

The maximum peak output power of the intentional radiator shall not exceed the following:

1. For systems using digital modulation in the bands of 902-928 MHz, 2400-2483.5 MHz, and 5725-5850 MHz: 1 watt (30dBm).
2. Except as shown in paragraphs (b)(3) (i), (ii) and (iii) of this section, if transmitting antenna of directional gain greater than 6 dBi are used the peak output power from the intentional radiator shall be reduced below the stated values in paragraphs (b)(1) or (b)(2) of this section, as appropriate, by the amount in dB that the directional gain of the antenna exceeds 6 dBi.

b. Configuration of Measurement

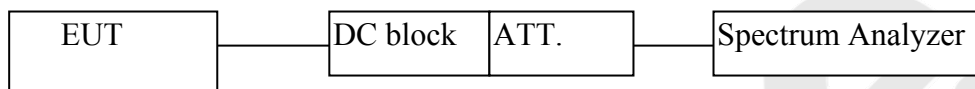

c. Test Procedure

This test was according the kDB 558074 D01 DTS Meas Guidance v03r05 9.1.1:

1. This procedure shall be used when the measurement instrument has available a resolution bandwidth that is greater than the DTS bandwidth.
2. Set the RBW \geq DTS bandwidth.
3. Set the VBW $\geq 3 * RBW$.
4. Set the span $\geq 3 * RBW$.
5. Detector = peak.
6. Sweep time = auto couple.
7. Trace mode = max hold.
8. Allow trace to fully stabilize.
9. Use peak marker function to determine the peak amplitude level.

d. Test Equipment

Same as the equipment listed in 4.2.

e. Test Results

Pass.

f. Test Data

Channel	Frequency (MHz)	Maximum transmit power (dBm)	Limit		Result
			(dBm)	(watts)	
Low	2402	0.656	30	1	Pass
Mid	2440	0.484			Pass
High	2480	2.469			Pass

CH Low

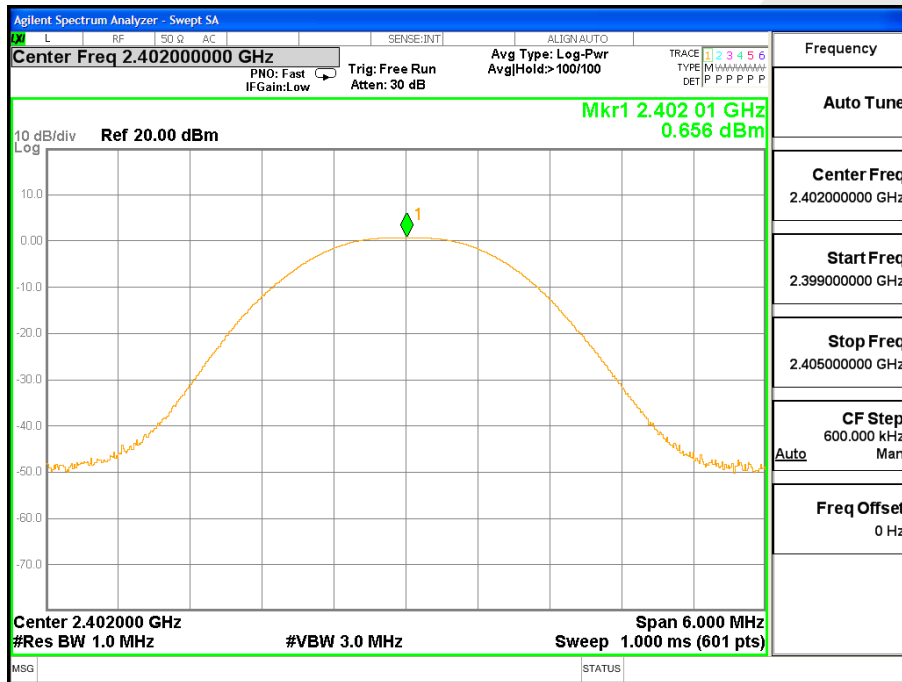

CH Mid

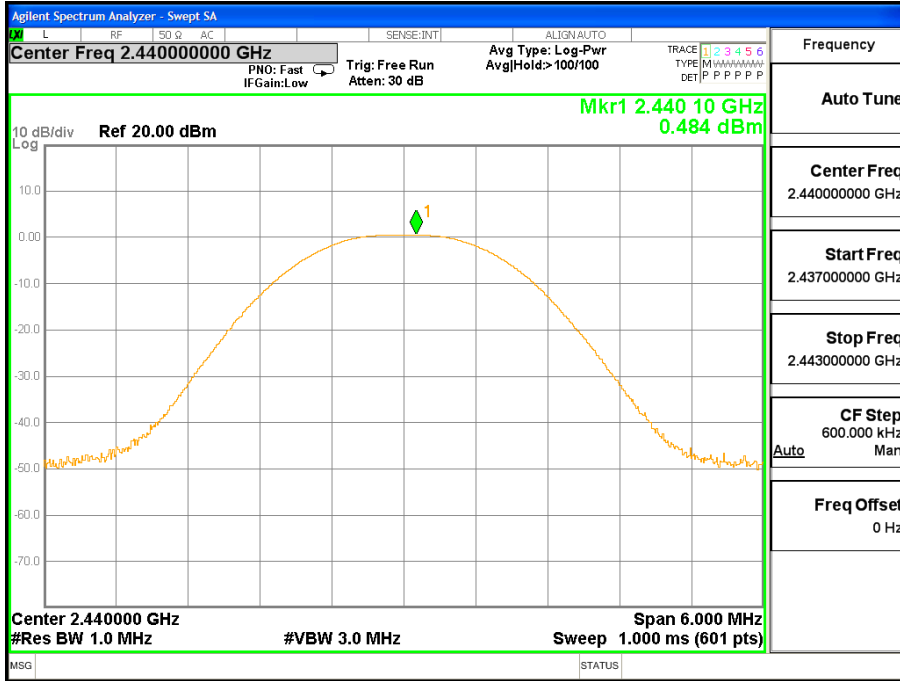

CH High

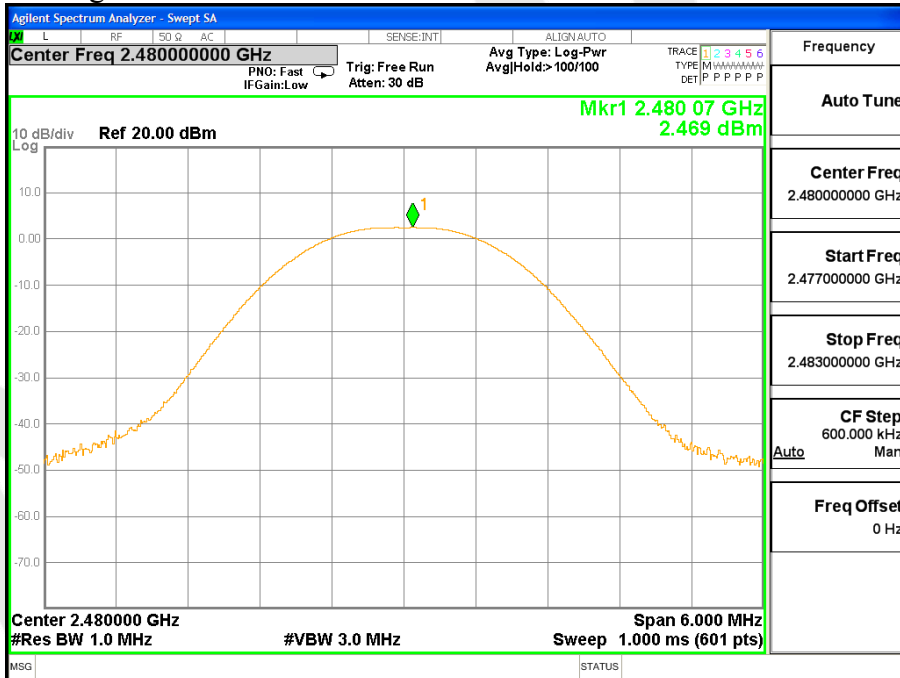

4.4. Band Edges Measurement

a. Limit

According to §15.247(c), in any 100 kHz bandwidth outside the frequency bands in which the spread spectrum intentional radiator is operating, the radio frequency power that is produced by the intentional radiator shall be at least 20dB below that in the 100kHz bandwidth within the band that contains the highest level of the desired power, In addition, radiated emissions which fall in the restricted bands, as defined in §15.205(a), must also comply with the radiated emission limits specified in §15.209(a).

b. Test Procedure

1. Conducted Method:

- 1) Set RBW=100KHz, VBW=300KHz
- 2) Detector=peak
- 3) Sweep time= auto
- 4) Trace mode=max hold.

2. Radiated Method:

- 1) For below 1GHz: The EUT is placed on a turntable, which is 0.8m above the ground plane. The EUT is tested in 9*6*6 Chamber.
For above 1GHz: The EUT is placed on a turntable, which is 1.5m above the ground plane. The EUT is tested in 9*6*6 Chamber.
- 2) The turntable shall be rotated for 360 degrees to determine the position of maximum emission level.
- 3) EUT is set 3m away from the receiving antenna, which is varied from 1m to 4m to find out the highest emission.
- 4) Set both RBW and VBW of spectrum analyzer to 100kHz with a convenient frequency span including 100kHz bandwidth from band edge, check the emission of EUT. If pass then set Spectrum Analyzer as below:
For below 1GHz:
The resolution bandwidth and video bandwidth of test receiver/ spectrum analyzer is 120kHz.
Detector: **Quasi-Peak**
For above 1GHz Peak measurement:
The resolution bandwidth of test receiver/ spectrum analyzer is 1MHz and video bandwidth is 3MHz.
Detector: **Peak**
For above 1GHz average measurement:
The resolution bandwidth of test receiver/ spectrum analyzer is 1MHz and the video bandwidth is 1kHz.
Detector: **Peak**
- 5) Repeat the procedures until all the PEAK and AVERAGE versus POLARIZATION are measured.

30M to 1G emissions:

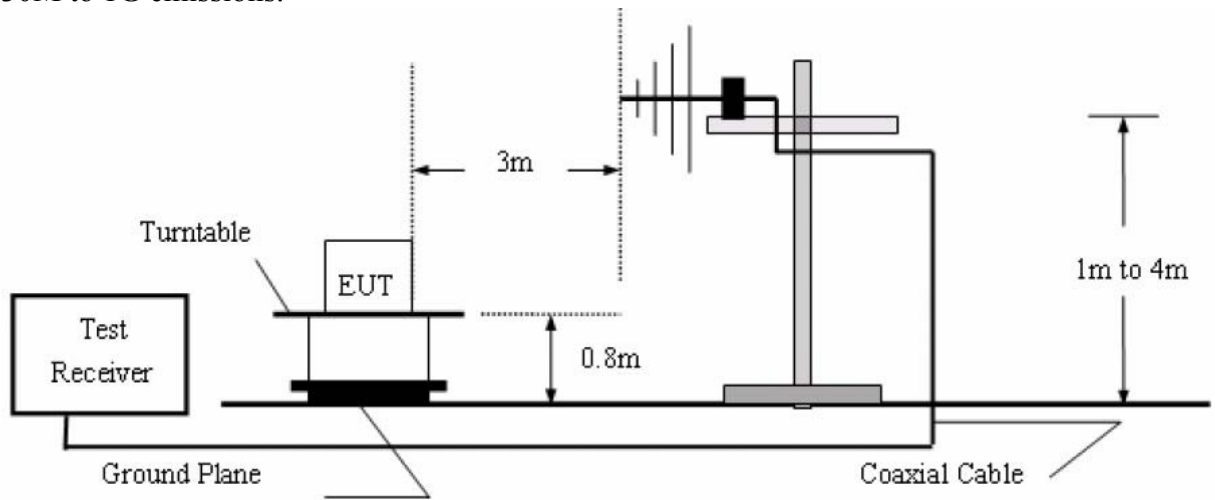

1G to 40G emissions:

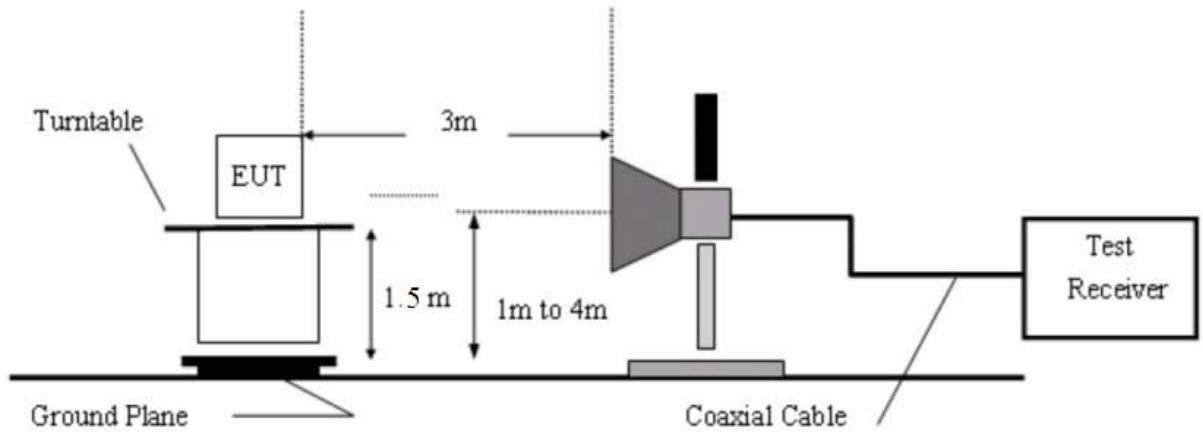

c. Test Equipment

Same as the equipment listed in 4.2.

d. Test Results

Pass.

e. Test Plots

See the following page.

CH Low

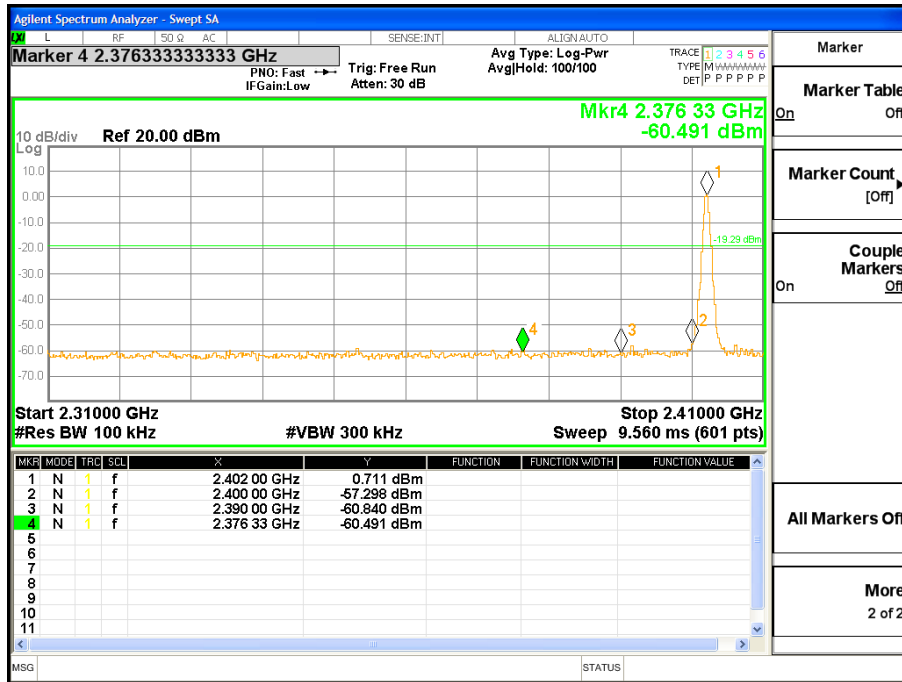

CH High

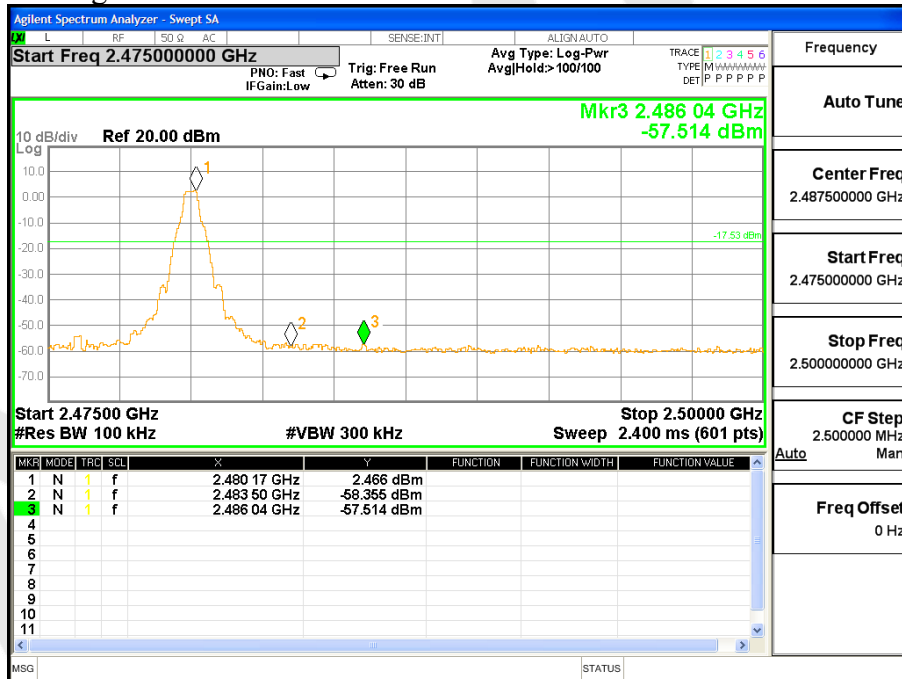

2402MHz

Horizontal-PEAK:

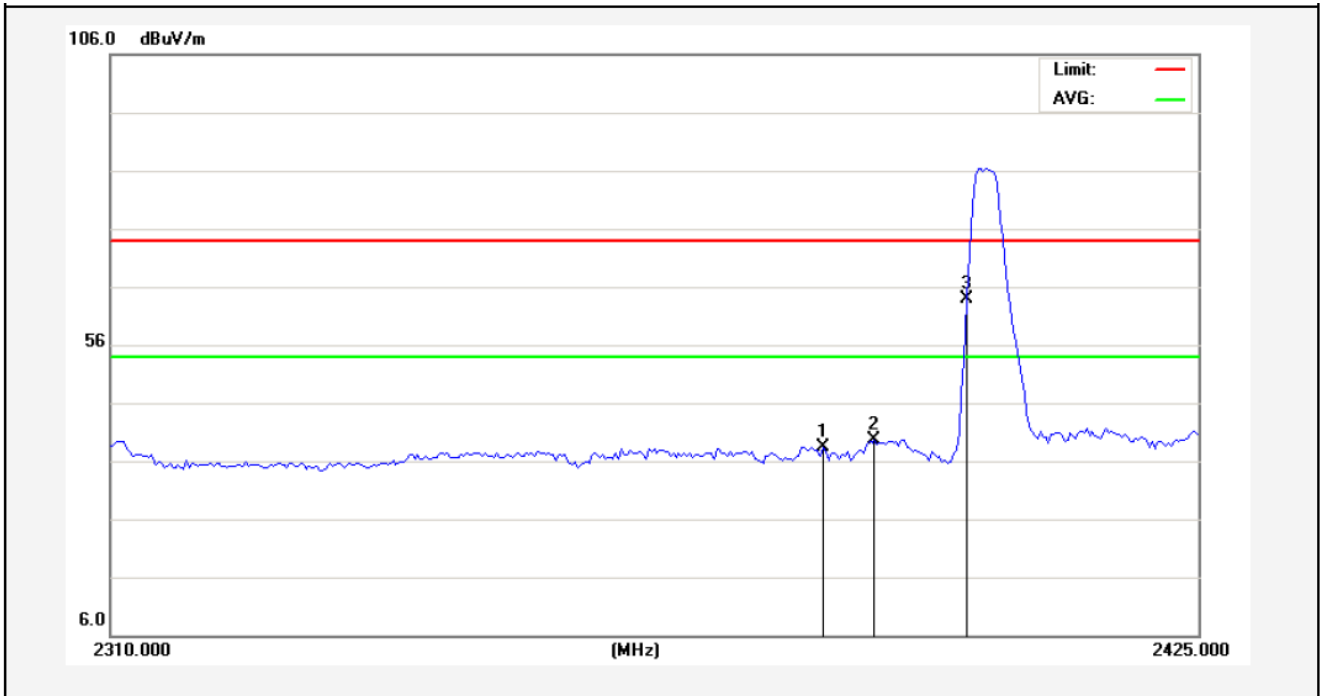

No.	Freq. (MHz)	Reading (dBuV/m)	Factor (dB/m)	Result (dBuV/m)	Limit (dBuV/)	Over Limit (dB)	Detector	Height (cm)	degree (deg)	Remark
1	2384.750	40.85	-2.53	38.32	74.00	-35.68	peak			
2	2390.000	42.23	-2.51	39.72	74.00	-34.28	peak			
3	2400.000	66.28	-2.49	63.79	74.00	-10.21	peak			

Anbotek

Horizontal-AV:

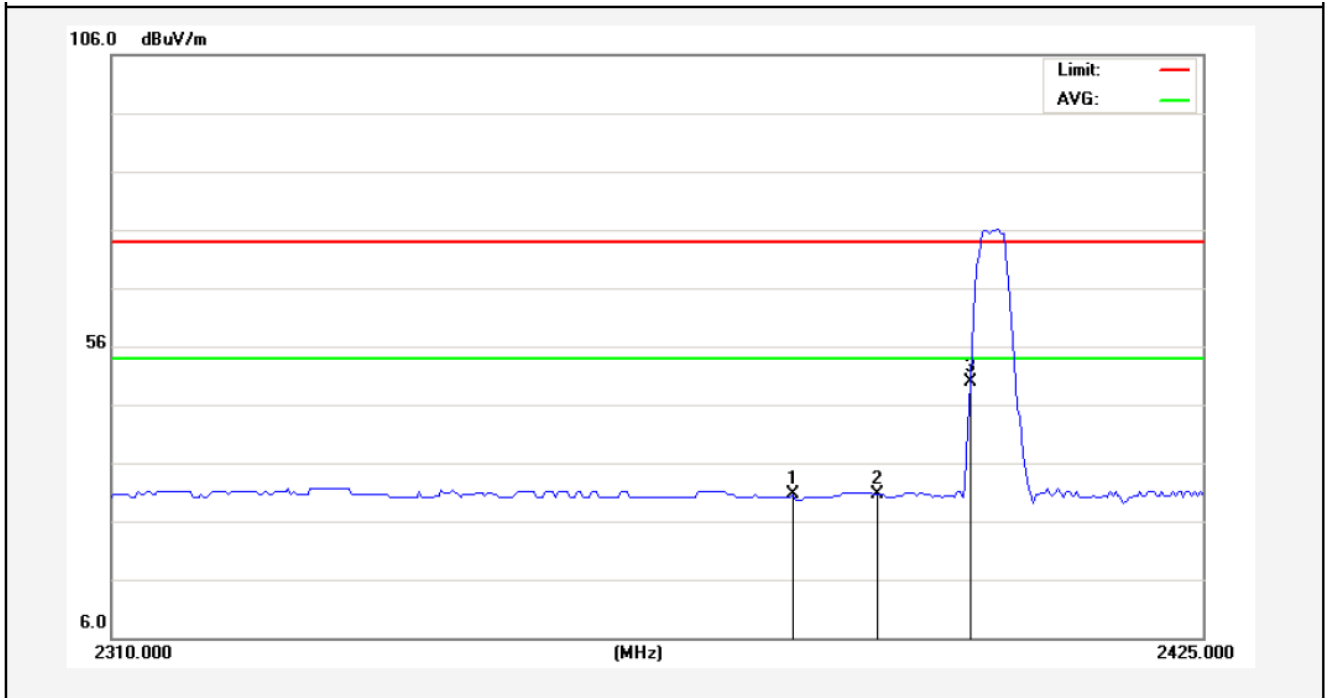

No.	Freq. (MHz)	Reading (dBuV/m)	Factor (dB/m)	Result (dBuV/m)	Limit (dBuV/)	Over Limit (dB)	Detector	Height (cm)	degree (deg)	Remark
1	2381.300	33.16	-2.53	30.63	54.00	-23.37	AVG			
2	2390.000	33.26	-2.51	30.75	54.00	-23.25	AVG			
3	2400.000	52.25	-2.49	49.76	54.00	-4.24	AVG			

Anbotek

2402MHz
Vertical-PEAK:

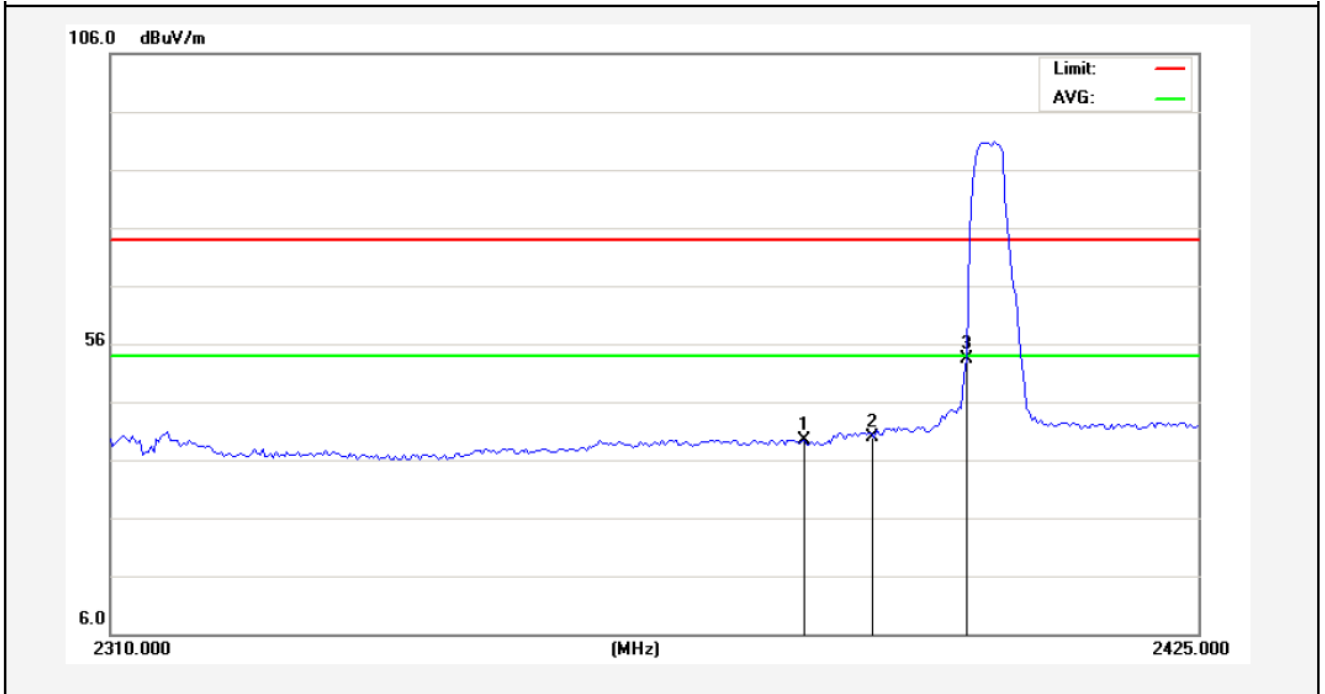

No.	Freq. (MHz)	Reading (dBuV/m)	Factor (dB/m)	Result (dBuV/m)	Limit (dBuV/)	Over Limit (dB)	Detector	Height (cm)	degree (deg)	Remark
1	2382.738	41.82	-2.53	39.29	74.00	-34.71	peak			
2	2390.000	42.42	-2.51	39.91	74.00	-34.09	peak			
3	2400.000	55.82	-2.49	53.33	74.00	-20.67	peak			

Anbotek

Vertical-AV:

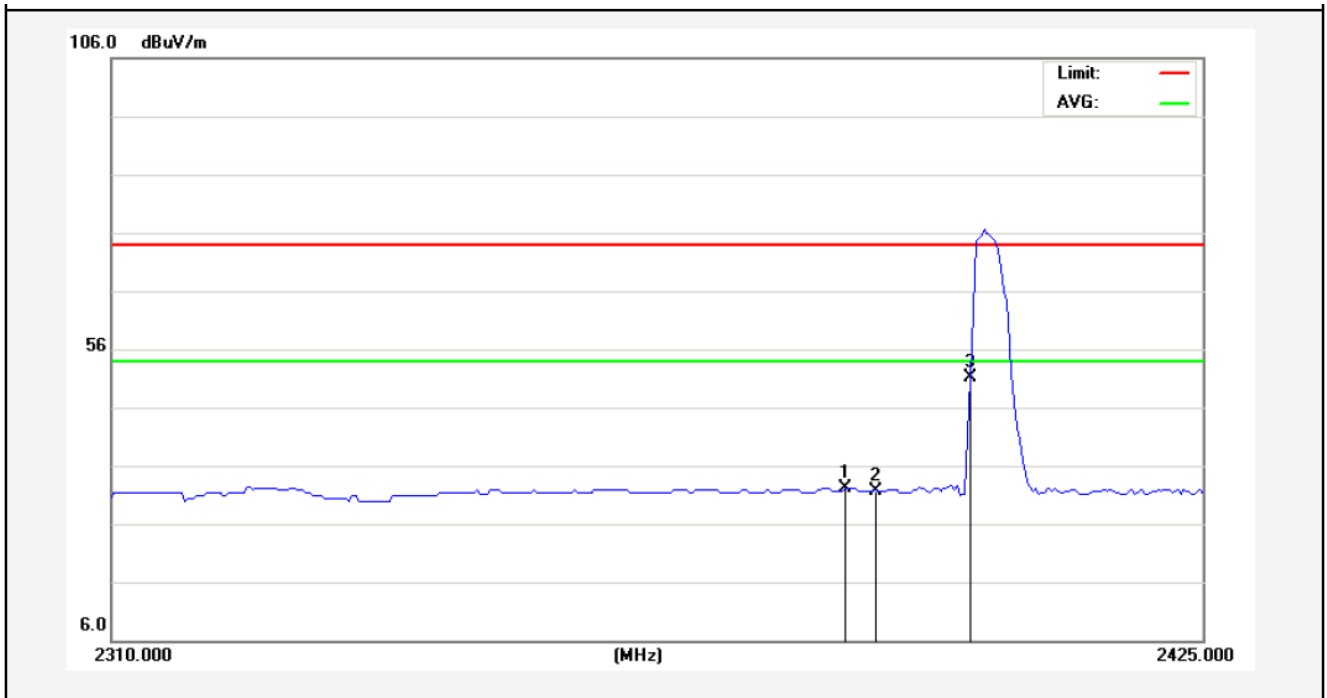

No.	Freq. (MHz)	Reading (dBuV/m)	Factor (dB/m)	Result (dBuV/m)	Limit (dBuV/)	Over Limit (dB)	Detector	Height (cm)	degree (deg)	Remark
1	2386.762	34.63	-2.52	32.11	54.00	-21.89	AVG			
2	2390.000	34.05	-2.51	31.54	54.00	-22.46	AVG			
3	2400.000	53.68	-2.49	51.19	54.00	-2.81	AVG			

Anbotek

2480MHz
Horizontal-PEAK:

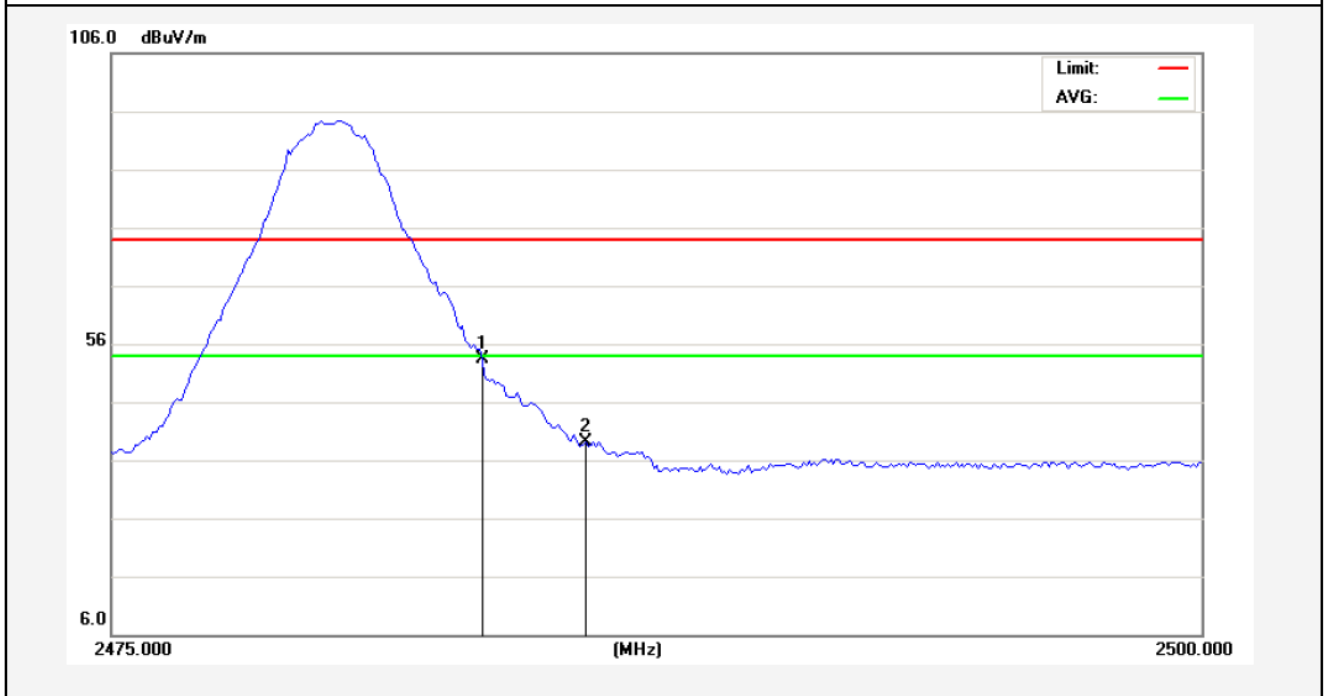

No.	Freq. (MHz)	Reading (dBuV/m)	Factor (dB/m)	Result (dBuV/m)	Limit (dBuV/)	Over Limit (dB)	Detector	Height (cm)	degree (deg)	Remark
1	2483.500	55.80	-2.31	53.49	74.00	-20.51	peak			
2	2485.875	41.32	-2.30	39.02	74.00	-34.98	peak			

Anbotek

Horizontal-AV:

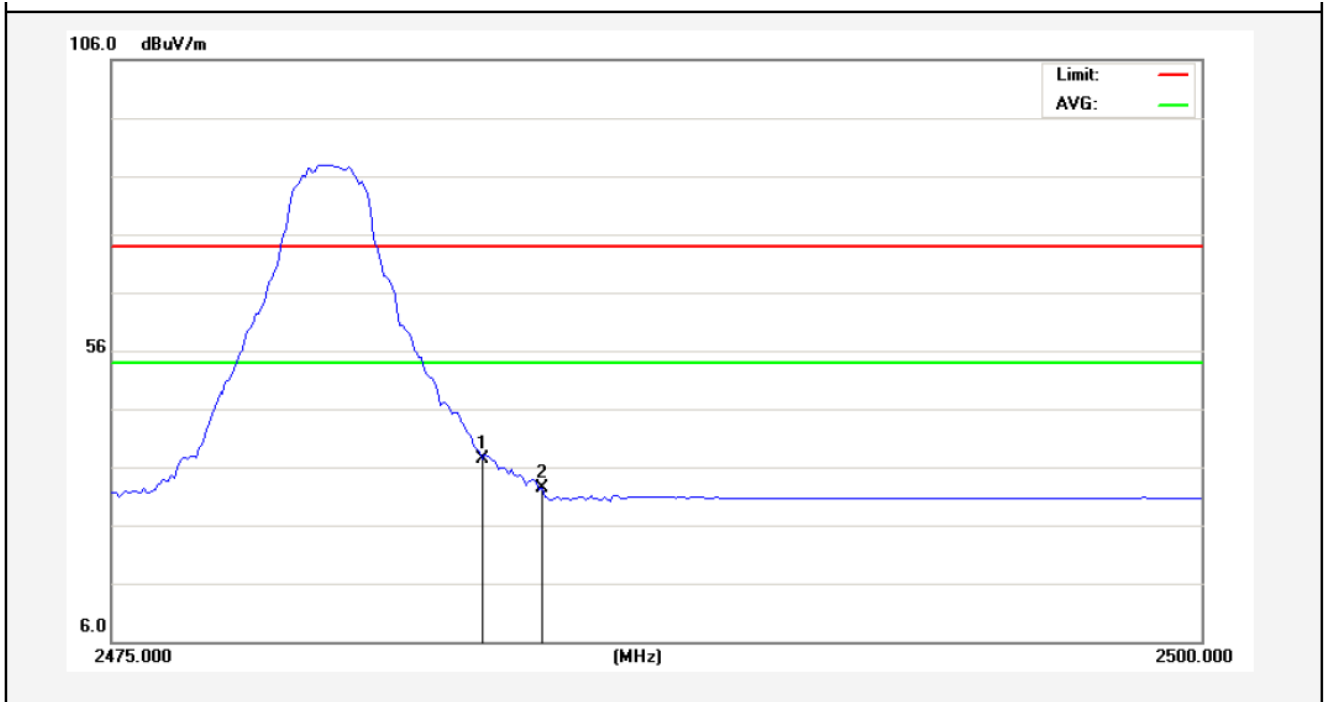

No.	Freq. (MHz)	Reading (dBuV/m)	Factor (dB/m)	Result (dBuV/m)	Limit (dBuV/)	Over Limit (dB)	Detector	Height (cm)	degree (deg)	Remark
1	2483.500	39.80	-2.31	37.49	54.00	-16.51	AVG			
2	2484.875	34.77	-2.30	32.47	54.00	-21.53	AVG			

Anbotek

2480MHz

Vertical-PEAK:

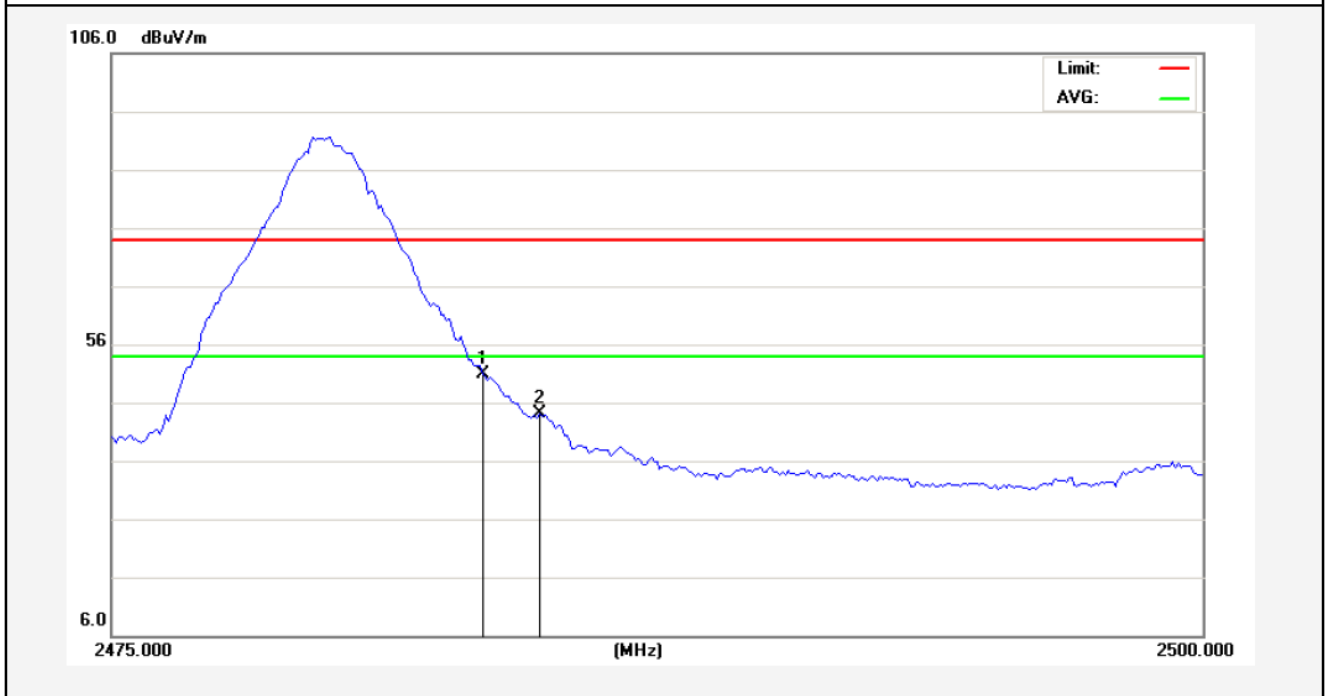

No.	Freq. (MHz)	Reading (dBuV/m)	Factor (dB/m)	Result (dBuV/m)	Limit (dBuV/)	Over Limit (dB)	Detector	Height (cm)	degree (deg)	Remark
1	2483.500	53.07	-2.31	50.76	74.00	-23.24	peak			
2	2484.813	46.36	-2.30	44.06	74.00	-29.94	peak			

Anbotek

Vertical-AV:

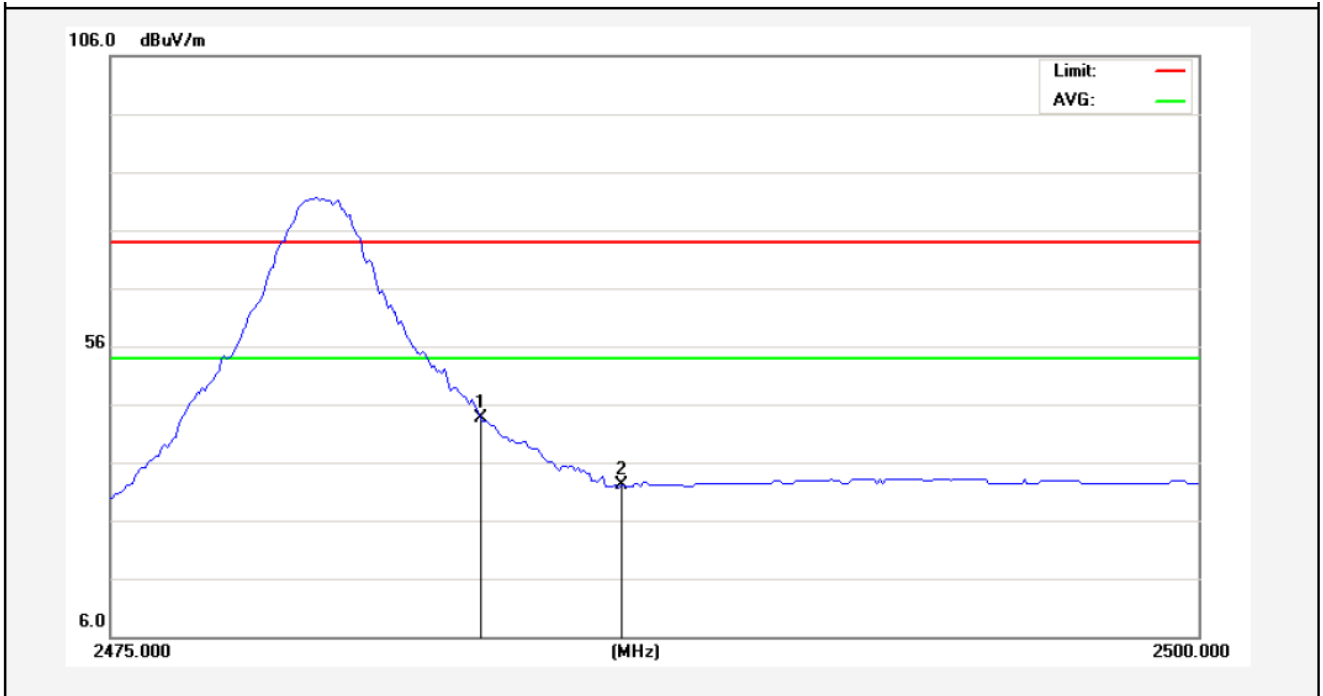

No.	Freq. (MHz)	Reading (dBuV/m)	Factor (dB/m)	Result (dBuV/m)	Limit (dBuV/)	Over Limit (dB)	Detector	Height (cm)	degree (deg)	Remark
1	2483.500	46.01	-2.31	43.70	54.00	-10.30	AVG			
2	2486.750	34.35	-2.30	32.05	54.00	-21.95	AVG			

Anbotek

4.5. Peak Power Spectral Density

a. Limit

1. For direct sequence systems, the peak power spectral density conducted from the intentional radiator to the antenna shall not be greater than 8dBm in any 3kHz band during any time interval of continuous transmission.
2. The direct sequence operating of the hybrid system, with the frequency hopping operation turned off, shall comply with the power density requirements of paragraph (d) of this section.

b. Test Procedure

1. Place the EUT on the table and set it in transmitting mode. Remove the antenna from the EUT and then connect a low loss RF cable from the antenna port to the spectrum analyzer.
2. Set the spectrum analyzer as RBW = 3kHz, VBW = 10kHz, Span = 1.5xDTS BW
3. Record the max. reading.
4. Repeat the above procedure until the measurements for all frequencies are completed.

c. Test Equipment

Same as the equipment listed in 4.2.

d. Test Setup

See 3.1

e. Test Results

Pass

f. Test Data

Please refer to the following data.

g. Test Plot See the following pages

Test mode: IEEE 802.11b

Channel	Frequency (MHz)	PPSD (dBm/3KHz)	∑PPSD (dBm/3KHz)	Limit (dBm)	Result
Low	2402	-13.185	-	8.00	Pass
Mid	2440	-13.288	-	8.00	Pass
High	2480	-11.228	-	8.00	Pass

CH Low

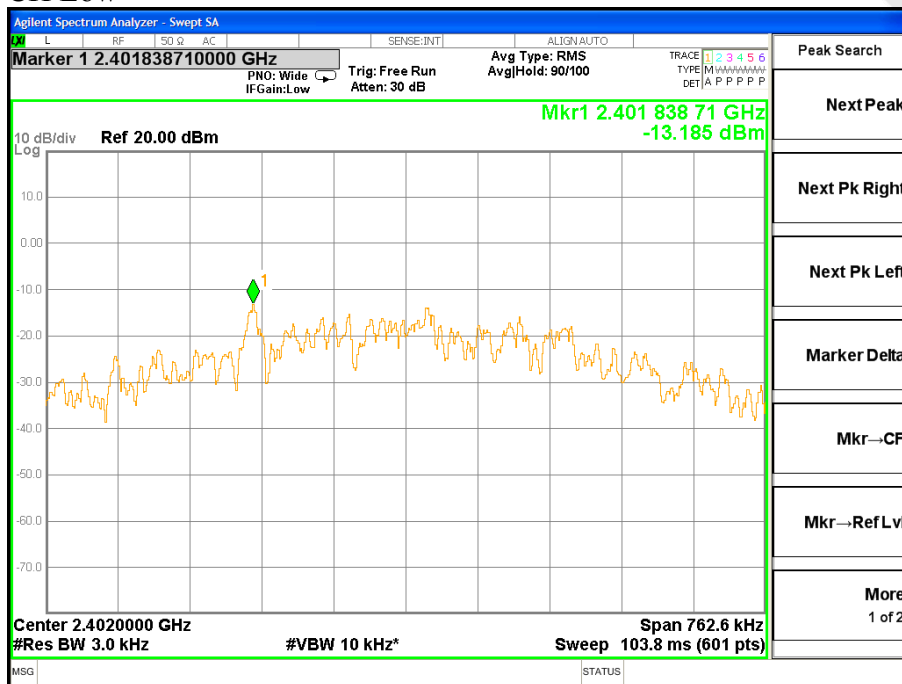

CH Mid

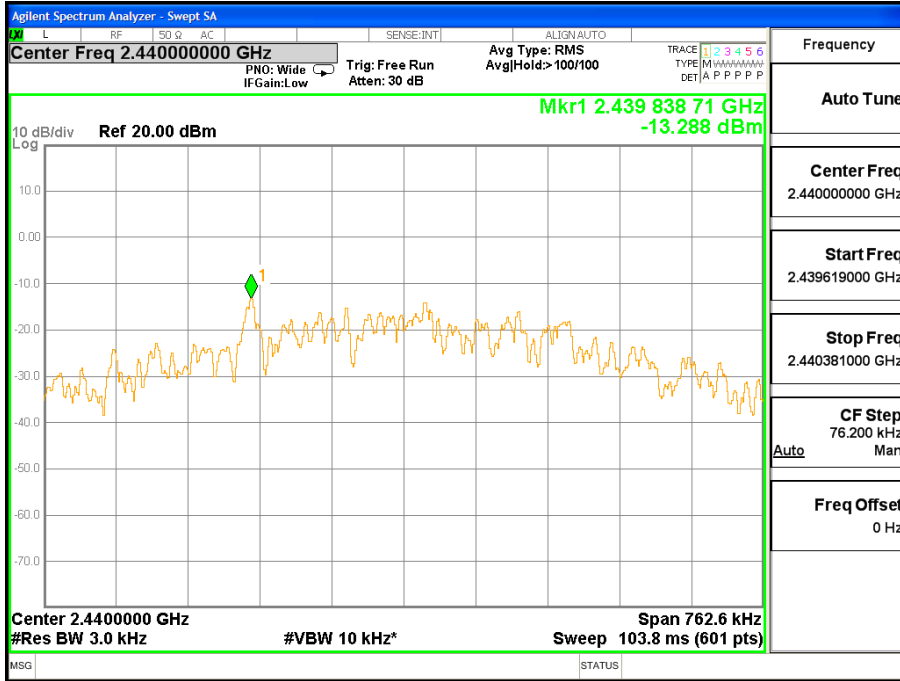

CH High

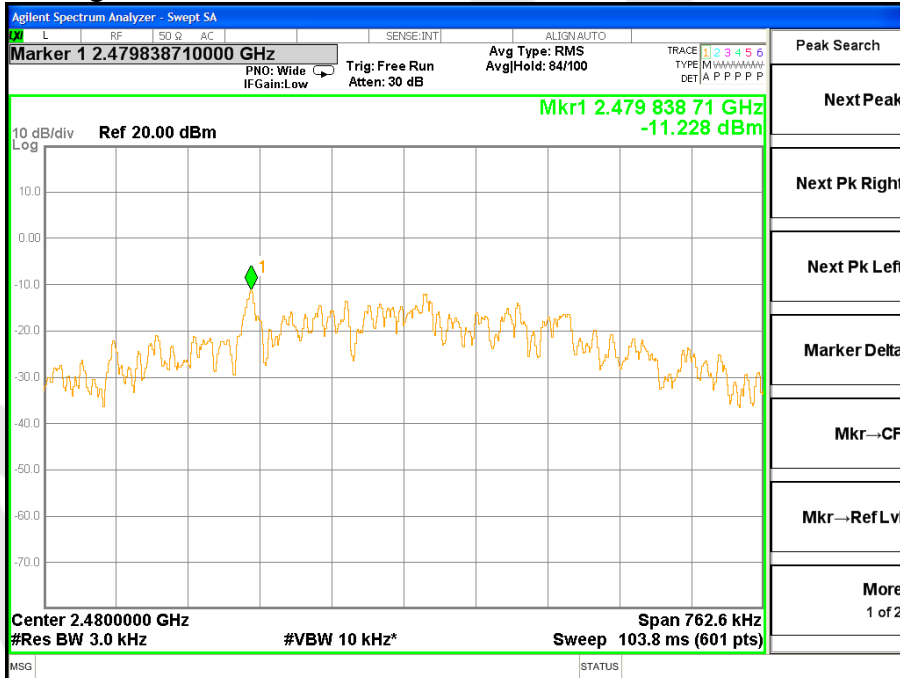

4.6. Radiated Emissions

4.6.1.1. Test Limits (< 30 MHz)

Frequency (MHz)	Field Strength (microvolts/meter)	Measurement Distance (meter)
0.009-0.490	2400/F(kHz)	300
0.490-1.705	24000/F(kHz)	30
1.705-30.0	30	30

4.6.1.2. Test Limits (≥ 30 MHz)

FIELD STRENGTH of Fundamental: @3M	FIELD STRENGTH of Harmonics	S15.209 30 - 88 MHz	40 dBuV/m
902-928 MHz		88 - 216 MHz	43.5
2.4-2.4835 GHz		216 - 960 MHz	46
94 dBμV/m @3m	54 dBμV/m @3m	ABOVE 960 MHz	54dBuV/m

In any 100 kHz bandwidth outside the frequency band in which the spread spectrum or digitally modulated intentional radiator is operating, the radio frequency power that is produced by the intentional radiator shall be at least 20 dB below that in the 100 kHz bandwidth within the band that contains the highest level of the desired power, based on either an RF conducted or a radiated measurement. Attenuation below the general limits specified in Section 15.209(a) is not required. In addition, radiated emissions which fall in the restricted bands, as defined in Section 15.205(a), must also comply with the radiated emission limits specified in Section 15.209(a) (see Section 15.205(c)).

Test Equipment

Item	Equipment	Manufacturer	Model No.	Serial No.	Last Cal.	Cal. Interval
1.	Spectrum Analysis	Agilent	E4407B	US39390582	Apr. 16, 2016	1 Year
2.	Preamplifier	Instruments corporation	EMC011830	980100	Apr. 16, 2016	1 Year
3.	EMI Test Receiver	Rohde & Schwarz	ESPI	101604	Apr. 16, 2016	1 Year
4.	Double Ridged Horn Antenna	Instruments corporation	GTH-0118	351600	Apr. 19, 2016	1 Year
5.	Bilog Broadband Antenna	Schwarzbeck	VULB9163	VULB 9163-289	Apr. 19, 2016	1 Year
6.	Pre-amplifier	SONOMA	310N	186860	Apr. 16, 2016	1 Year
7.	EMI Test Software EZ-EMC	SHURPLE	N/A	N/A	N/A	N/A
8.	Power Sensor	DAER	RPR3006W	15I00041SN046	Jun 30, 2016	1 Year
9.	MXA Spectrum Analysis	Agilent	N9020A	MY51170037	Jun 30, 2016	1 Year
10.	MXG RF Vector Signal Generator	Agilent	N5182A	MY48180656	Jun 30, 2016	1 Year
11.	Signal Generator	Agilent	E4421B	MY41000743	Jun 30, 2016	1 Year
12.	DC Power supply	IV	IV-8080	YQSB0096	Jun 30, 2016	1 Year
13.	TEMP&HUMI PROGRAMMABLE CHAMBER	Bell Group	BE-THK-150M8	SE-0137	Mar 16, 2016	1 Year

4.6.2. Test Configuration:

4.6.2.1. 9k to 30MHz emissions:

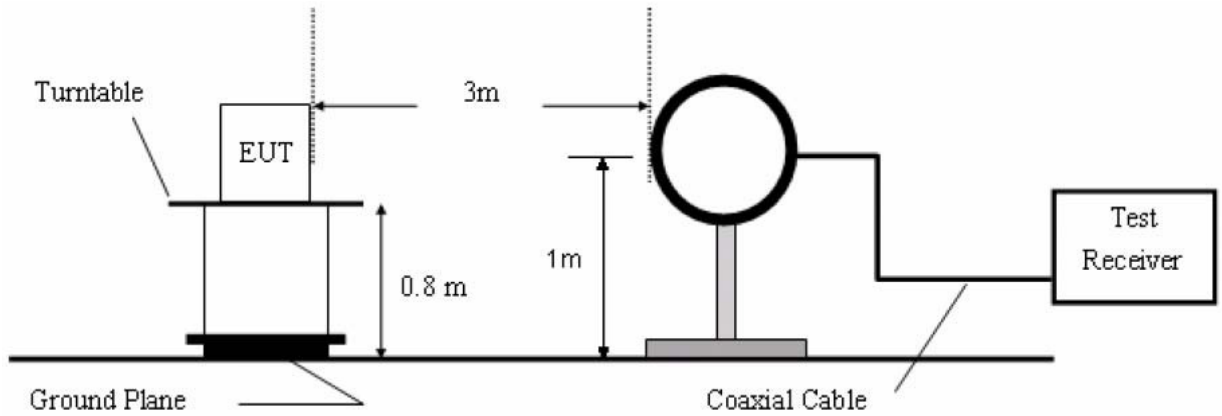

4.6.2.2. 30M to 1G emissions:

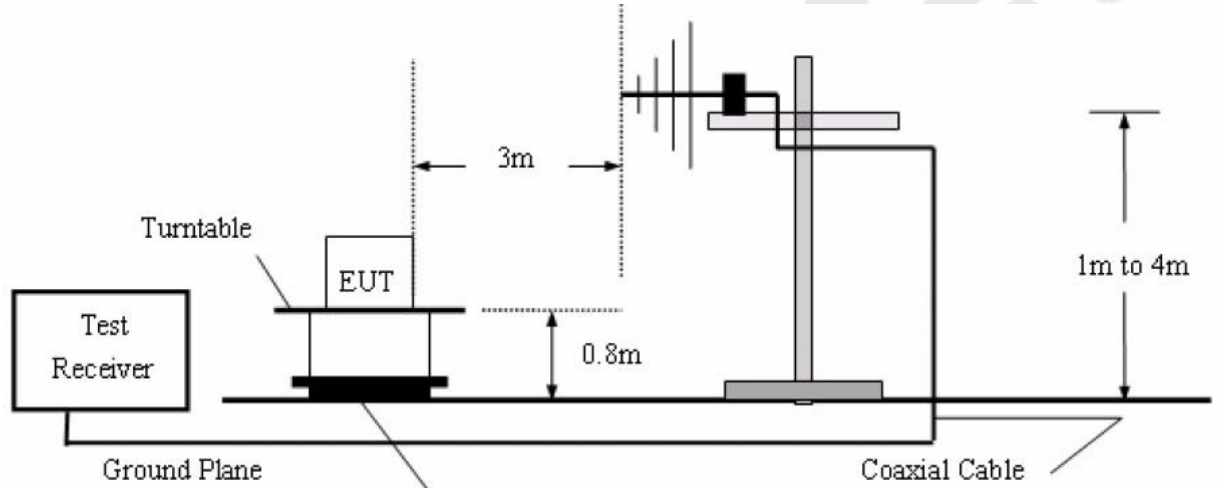

4.6.2.3. 1G to 40G emissions:

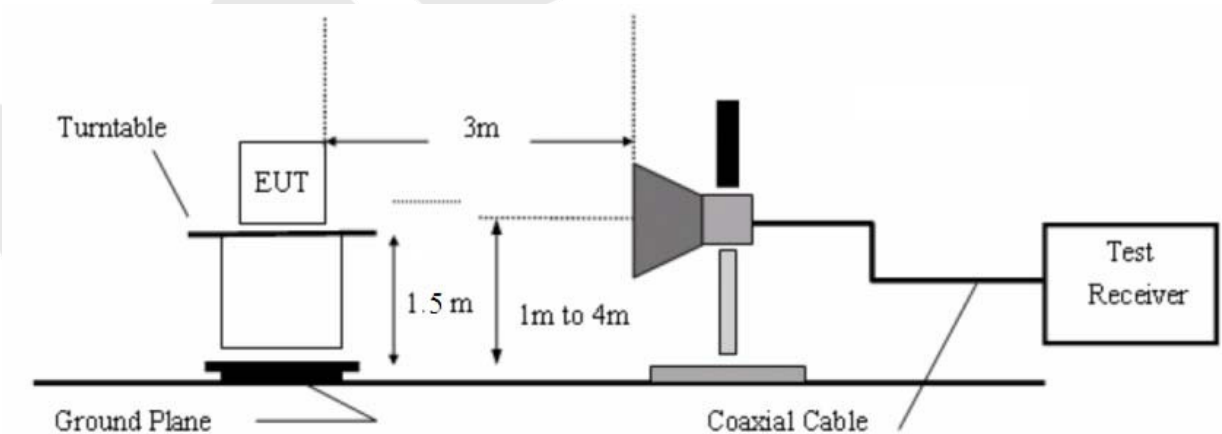

4.6.3. Test Procedure

For below 1GHz: The EUT is placed on a turntable, which is 0.8m above the ground plane.
For above 1GHz: The EUT is placed on a turntable, which is 1.5m above the ground plane.
The turn table can rotate 360 degrees to determine the position of the maximum emission level.
The EUT is set 3 meters away from the receiving antenna which is mounted on a antenna tower.
The antenna can be moved up and down from 1 to 4 meters to find out the maximum emission level. Both horizontal and vertical polarization of the antenna are set on test.

Measurements are made on 9KHz to 30MHz and 30MHz to 26GHz range with the transmitter set to the lowest, middle, and highest channels.

All readings from 30MHz to 1GHz are quasi-peak values with a resolution bandwidth of 120kHz. All reading are above 1GHz, peak & average values with a resolution bandwidth of 1MHz.

The EUT is tested in 9*6*6 Chamber. The device is evaluated in xyz orientation.

The test results are listed in Section 4.6.4.

4.6.4. Test Results

PASS.

Please refer the following pages. Only the worst case (x orientation).

The test results of above 18000MHz are attenuated more than 20dB below the permissible limits, so the results don't record in the report.

Job No.:	011606622I	Plarization:	Horizontal
Standard:	(RE)FCC PART15 C_3m	Power Source:	AC 120V, 60Hz for adapter
Test item:	Radiation Test	Temp.(C)/Hum.(%RH):	24.4(C)/50% RH
Test Mode:	On	Distance:	3m

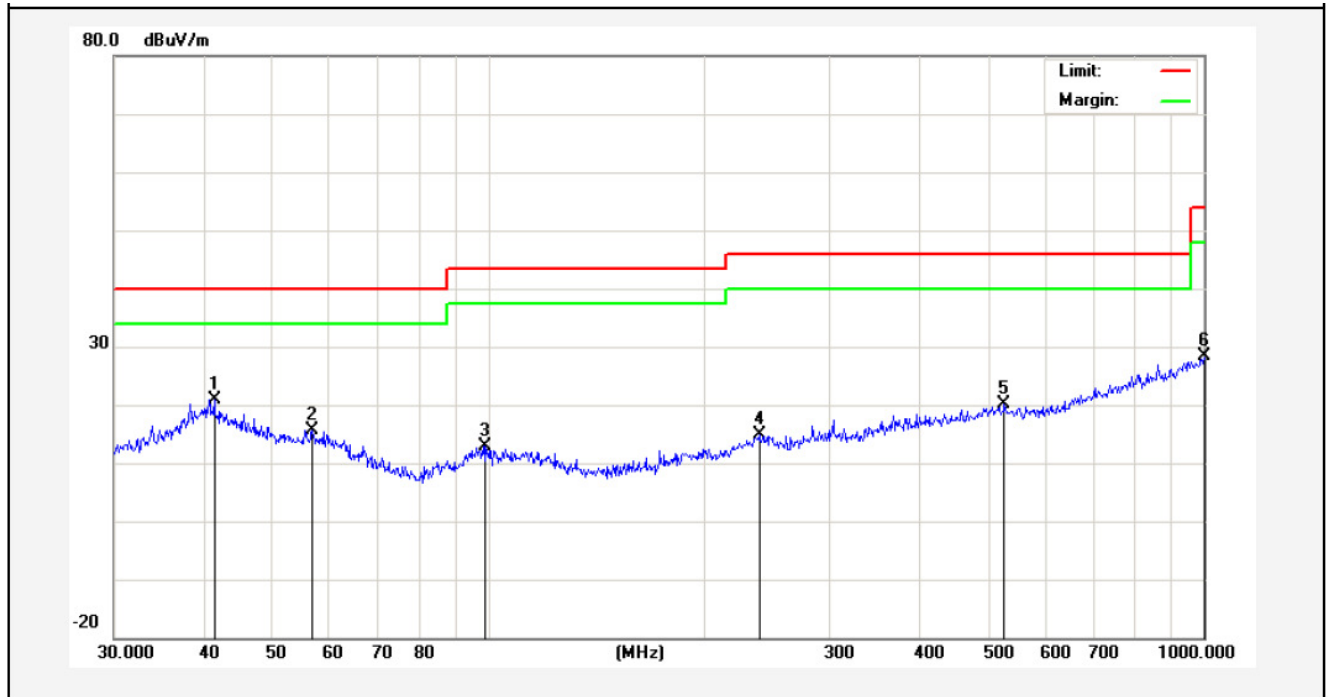

No.	Freq. (MHz)	Reading (dBuV/m)	Factor (dB/m)	Result (dBuV/m)	Limit (dBuV/)	Over Limit (dB)	Detector	Height (cm)	degree (deg)	Remark
1	41.4215	31.85	-10.93	20.92	40.00	-19.08	peak			
2	56.7917	30.77	-15.09	15.68	40.00	-24.32	peak			
3	99.1797	30.69	-17.80	12.89	43.50	-30.61	peak			
4	239.1473	30.04	-15.17	14.87	46.00	-31.13	peak			
5	526.3967	31.18	-11.03	20.15	46.00	-25.85	peak			
6	1000.0000	31.45	-3.13	28.32	54.00	-25.68	peak			

Job No.:	011606622I	Plarization:	Vertical
Standard:	(RE)FCC PART15 C _3m	Power Source:	AC 120V, 60Hz for adapter
Test item:	Radiation Test	Temp.(C)/Hum.(%RH):	24.4(C)/50% RH
Test Mode:	On	Distance:	3m

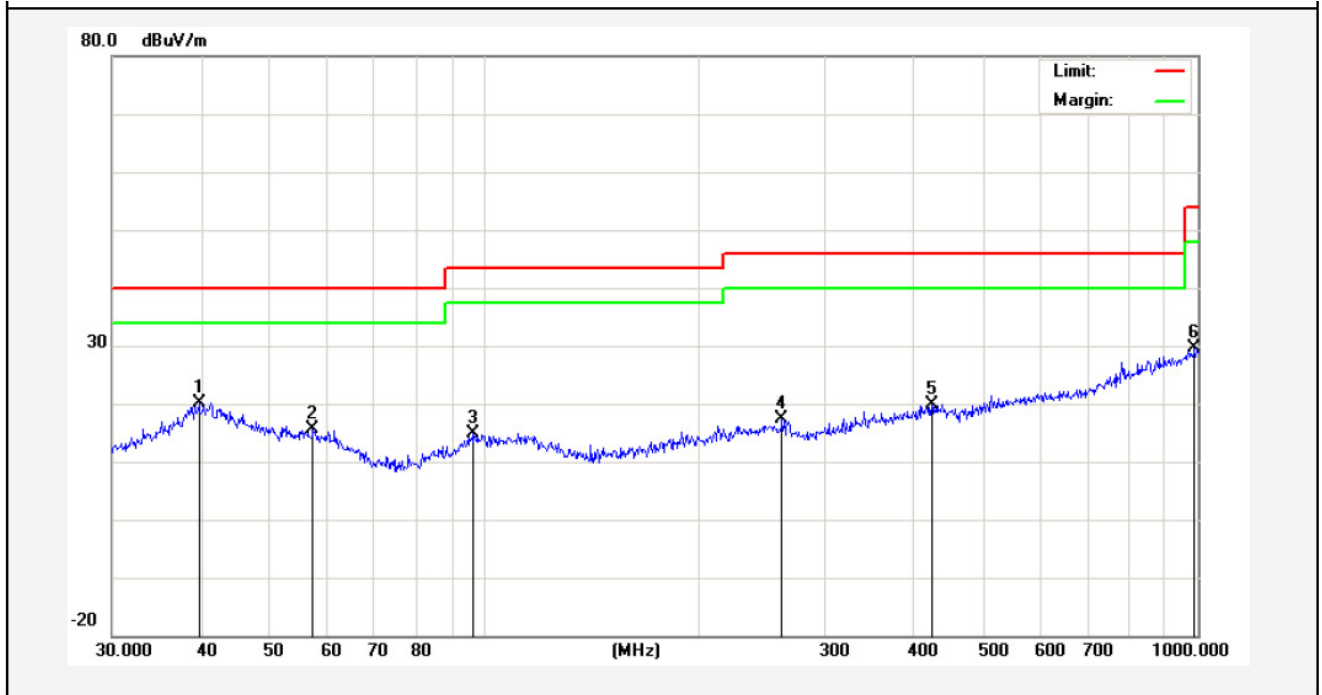

No.	Freq. (MHz)	Reading (dBuV/m)	Factor (dB/m)	Result (dBuV/m)	Limit (dBuV/)	Over Limit (dB)	Detector	Height (cm)	degree (deg)	Remark
1	39.7146	30.81	-10.59	20.22	40.00	-19.78	peak			
2	57.3923	30.80	-15.15	15.65	40.00	-24.35	peak			
3	96.4362	30.78	-15.95	14.83	43.50	-28.67	peak			
4	261.0583	31.53	-14.06	17.47	46.00	-28.53	peak			
5	423.5403	31.08	-11.27	19.81	46.00	-26.19	peak			
6	989.5355	31.84	-2.31	29.53	54.00	-24.47	peak			

Job No.:	011606622I	Plarization:	Horizontal
Standard:	(RE)FCC PART15 C _3m	Power Source:	AC 120V, 60Hz for adapter
Test item:	Radiation Test	Temp.(C)/Hum.(%RH):	24.4(C)/50% RH
Note:	2402MHz	Distance:	3m

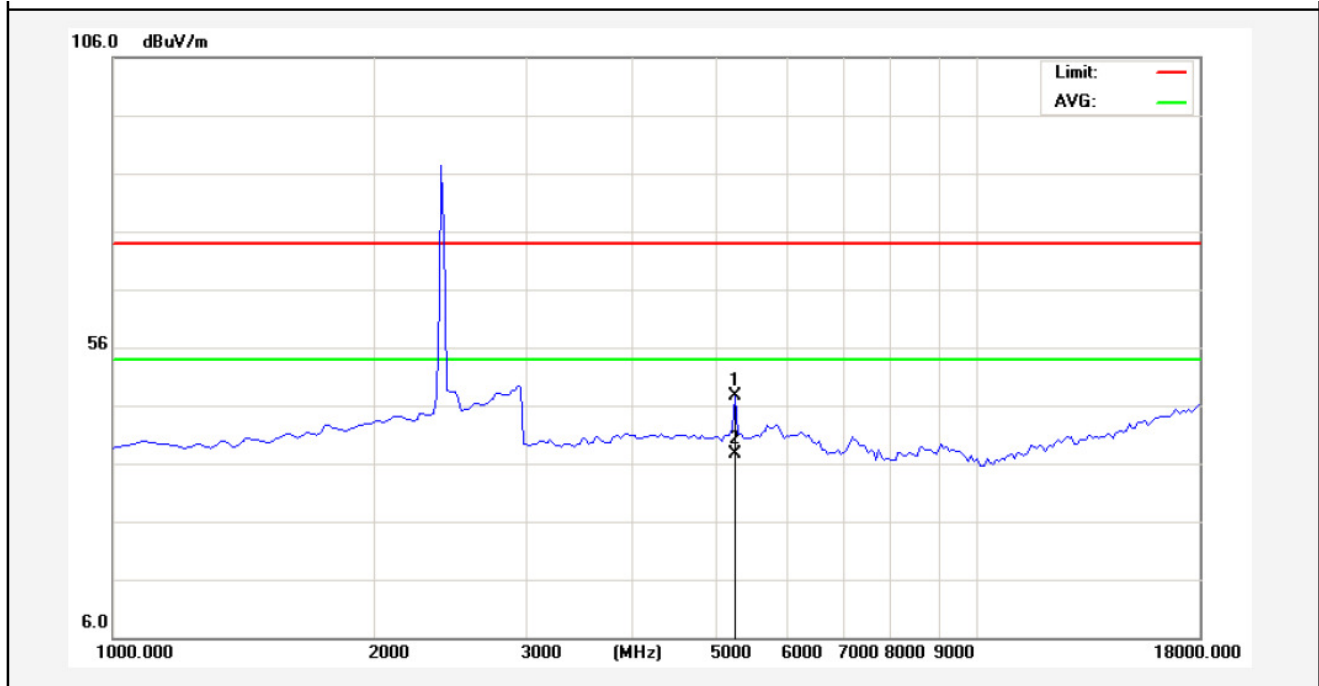

No.	Freq. (MHz)	Reading (dBuV/m)	Factor (dB/m)	Result (dBuV/m)	Limit (dBuV/)	Over Limit (dB)	Detector	Height (cm)	degree (deg)	Remark
1	5250.000	43.74	3.81	47.55	74.00	-26.45	peak			
2	5250.000	33.73	3.81	37.54	54.00	-16.46	AVG			



Job No.:	011606622I	Plarization:	Vertical
Standard:	(RE)FCC PART15 C _3m	Power Source:	AC 120V, 60Hz for adapter
Test item:	Radiation Test	Temp.(C)/Hum.(%RH):	24.4(C)/50% RH
Note:	2402MHz	Distance:	3m

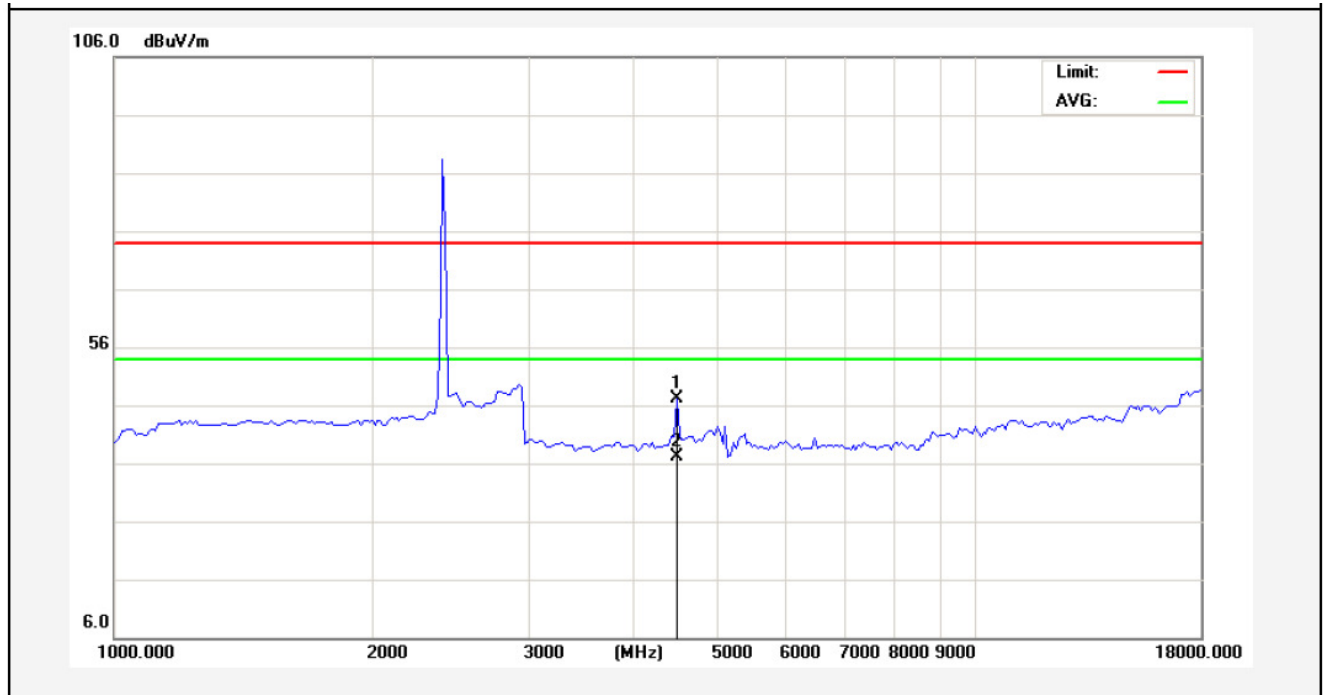

No.	Freq. (MHz)	Reading (dBuV/m)	Factor (dB/m)	Result (dBuV/m)	Limit (dBuV/)	Over Limit (dB)	Detector	Height (cm)	degree (deg)	Remark
1	4485.000	44.38	2.74	47.12	74.00	-26.88	peak			
2	4485.000	34.32	2.74	37.06	54.00	-16.94	AVG			

Job No.:	011606622I	Plarization:	Horizontal
Standard:	(RE)FCC PART15 C _3m	Power Source:	AC 120V, 60Hz for adapter
Test item:	Radiation Test	Temp.(C)/Hum.(%RH):	24.4(C)/50% RH
Note:	2440MHz	Distance:	3m

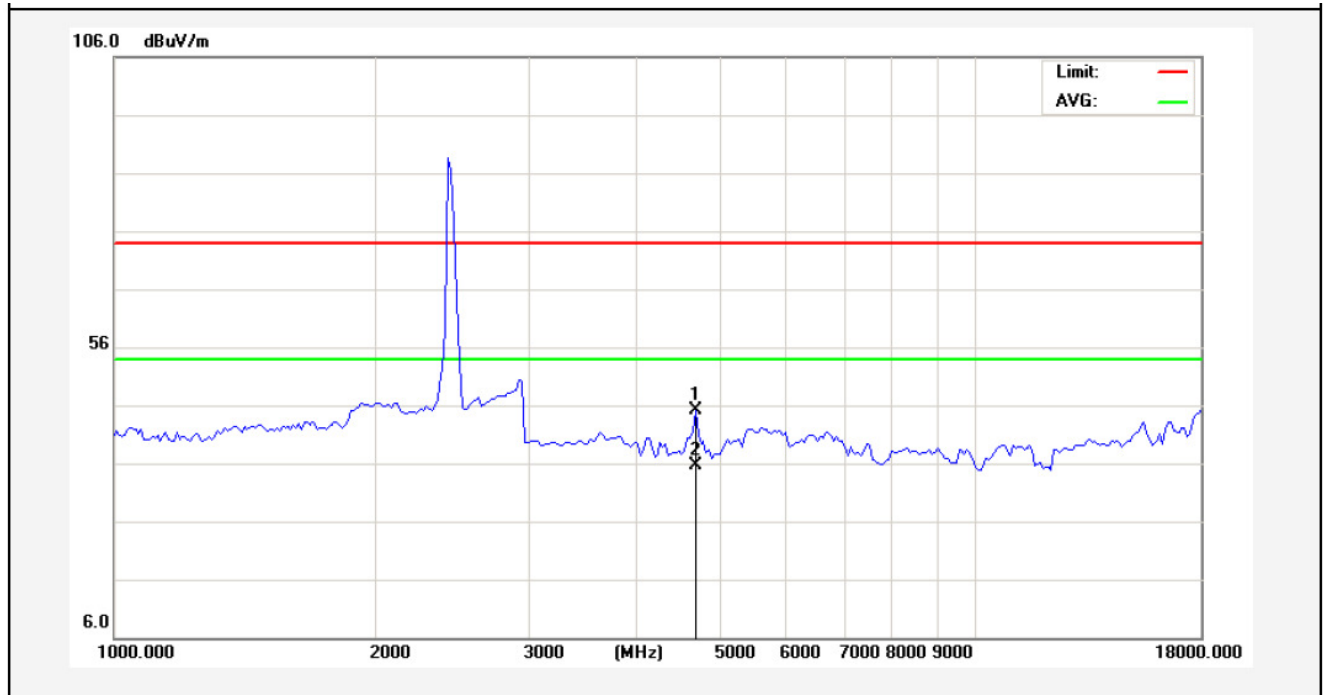

No.	Freq. (MHz)	Reading (dBuV/m)	Factor (dB/m)	Result (dBuV/m)	Limit (dBuV/)	Over Limit (dB)	Detector	Height (cm)	degree (deg)	Remark
1	4697.500	42.04	3.11	45.15	74.00	-28.85	peak			
2	4697.500	32.64	3.11	35.75	54.00	-18.25	AVG			

Job No.:	011606622I	Plarization:	Vertical
Standard:	(RE)FCC PART15 C _3m	Power Source:	AC 120V, 60Hz for adapter
Test item:	Radiation Test	Temp.(C)/Hum.(%RH):	24.4(C)/50% RH
Note:	2440MHz	Distance:	3m

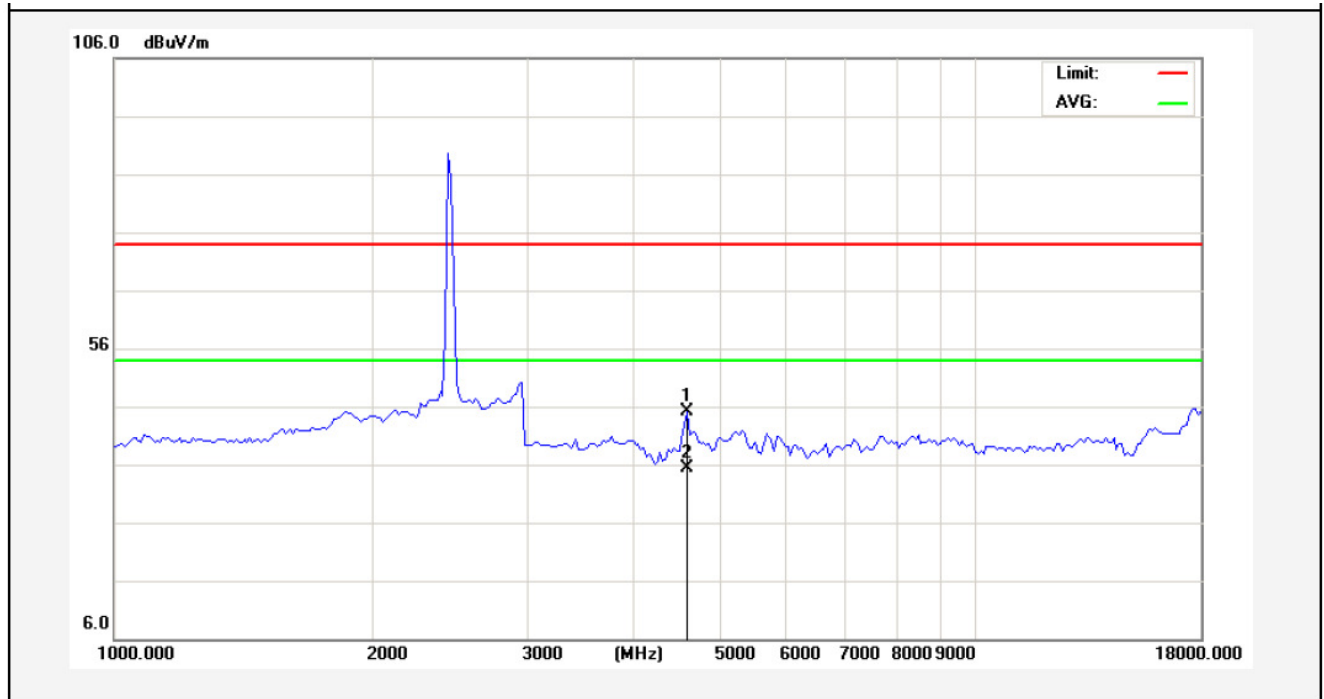

No.	Freq. (MHz)	Reading (dBuV/m)	Factor (dB/m)	Result (dBuV/m)	Limit (dBuV/)	Over Limit (dB)	Detector	Height (cm)	degree (deg)	Remark
1	4612.500	42.28	2.96	45.24	74.00	-28.76	peak			
2	4612.500	32.41	2.96	35.37	54.00	-18.63	AVG			

AM

Job No.:	011606622I	Plarization:	Horizontal
Standard:	(RE)FCC PART15 C _3m	Power Source:	AC 120V, 60Hz for adapter
Test item:	Radiation Test	Temp.(C)/Hum.(% RH):	24.4(C)/50% RH
Note:	2480MHz	Distance:	3m

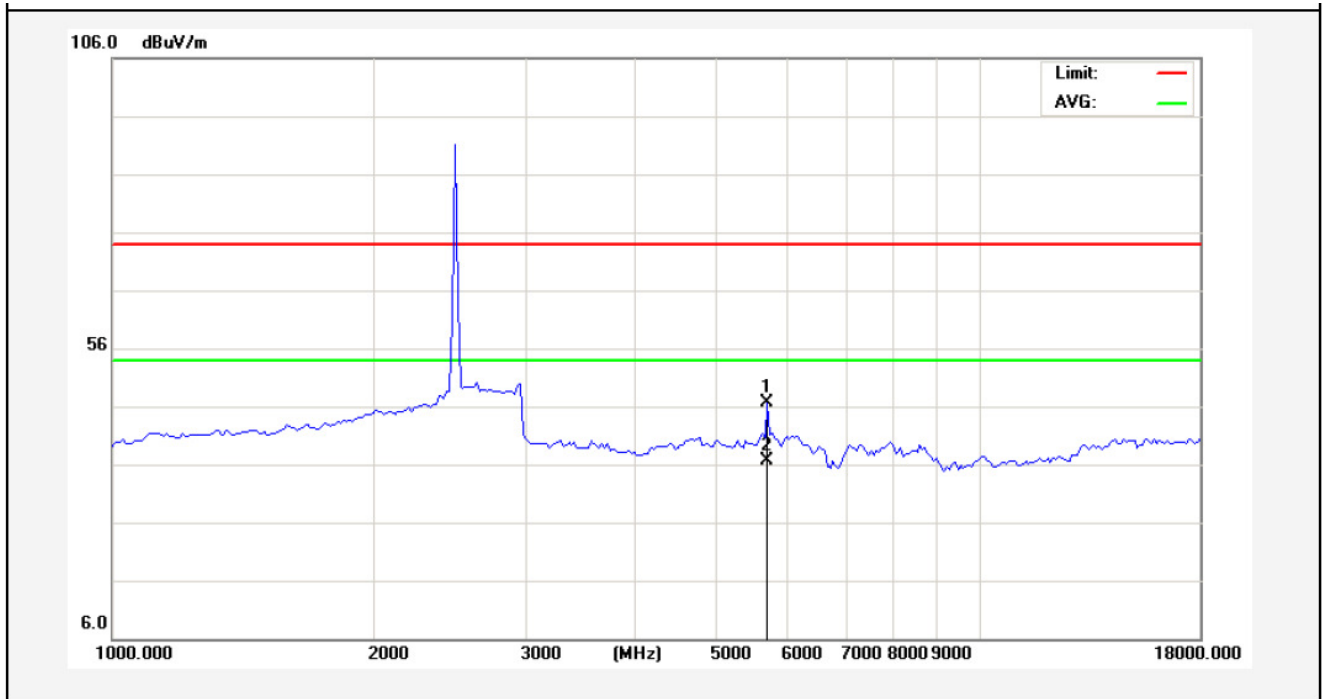

No.	Freq. (MHz)	Reading (dBuV/m)	Factor (dB/m)	Result (dBuV/m)	Limit (dBuV/)	Over Limit (dB)	Detector	Height (cm)	degree (deg)	Remark
1	5717.500	41.26	5.36	46.62	74.00	-27.38	peak			
2	5717.500	31.38	5.36	36.74	54.00	-17.26	AVG			



Job No.:	011606622I	Plarization:	Vertical
Standard:	(RE)FCC PART15 C_3m	Power Source:	AC 120V, 60Hz for adapter
Test item:	Radiation Test	Temp.(C)/Hum.(% RH):	24.4(C)/50% RH
Note:	2480MHz	Distance:	3m

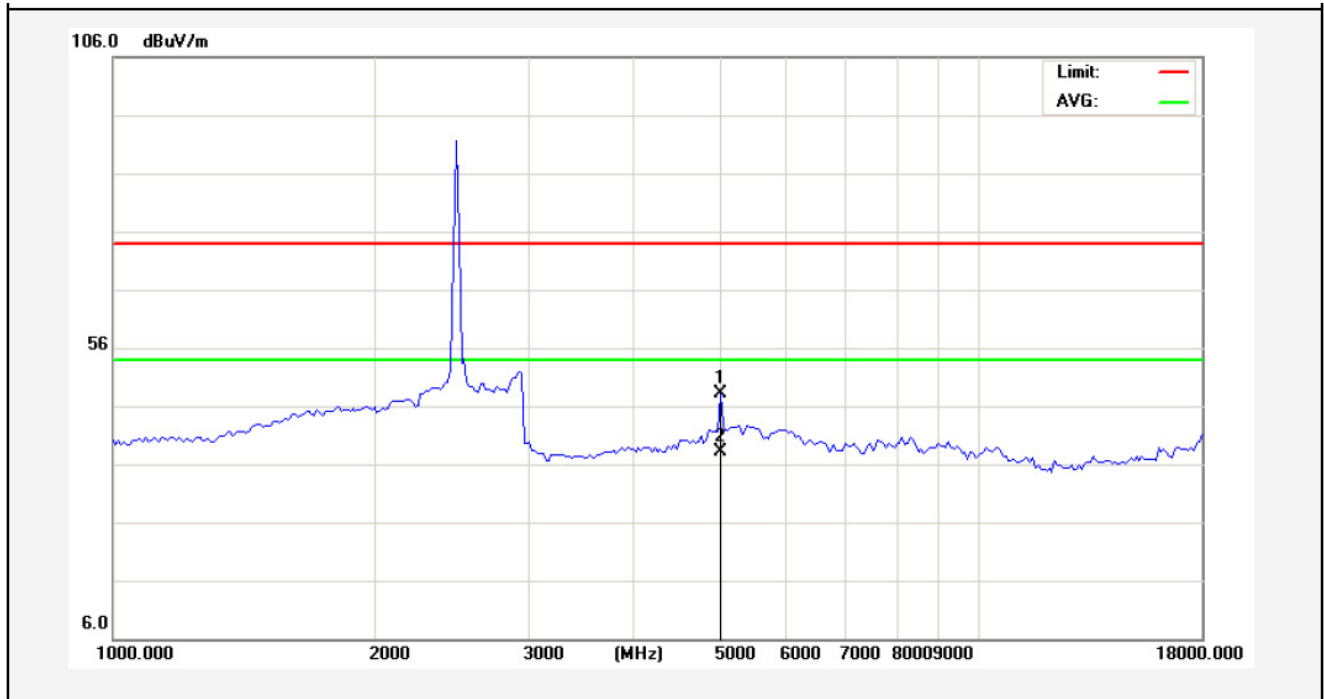

No.	Freq. (MHz)	Reading (dBuV/m)	Factor (dB/m)	Result (dBuV/m)	Limit (dBuV/)	Over Limit (dB)	Detector	Height (cm)	degree (deg)	Remark
1	5037.500	44.50	3.67	48.17	74.00	-25.83	peak			
2	5037.500	34.44	3.67	38.11	54.00	-15.89	AVG			



5. ANTENNA APPLICATION

5.1. Antenna requirement

The EUT'S antenna is met the requirement of FCC part 15C section 15.203.

An intentional radiator shall be designed to ensure that no antenna other than that furnished by the responsible party shall be used with the device. The use of a permanently attached antenna or of an antenna that uses a unique coupling to the intentional radiator shall be considered sufficient to comply with the provisions of this section. The manufacturer may design the unit so that a broken antenna can be replaced by the user, but the use of a standard antenna jack or electrical connector is prohibited. This requirement does not apply to carrier current devices or to devices operated under the provisions of §15.211, §15.213, §15.217, §15.219, or §15.221. Further, this requirement does not apply to intentional radiators that must be professionally installed, such as perimeter protection systems and some field disturbance sensors, or to other intentional radiators which, in accordance with §15.31(d), must be measured at the installation site. However, the installer shall be responsible for ensuring that the proper antenna is employed so that the limits in this part are not exceeded.

5.2. Result

The EUT's antenna used a ceramic chip antenna which is permanently attached, The antenna's gain is 5.46dBi and meets the requirement.

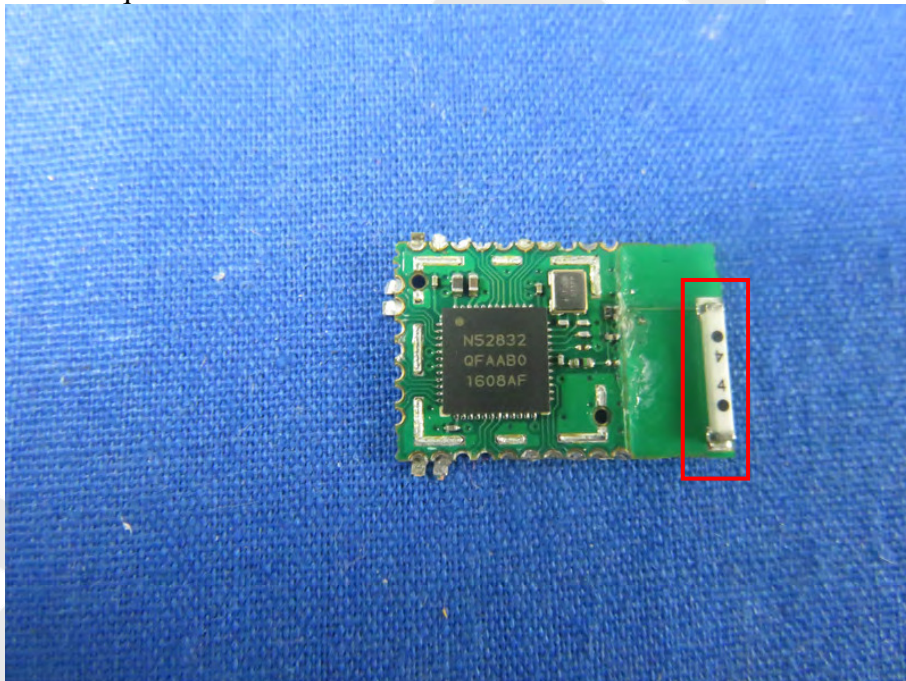

6. PHOTOGRAPH

6.1 Photo of Conducted Emission Test



6.2 Photo of Radiation Emission Test

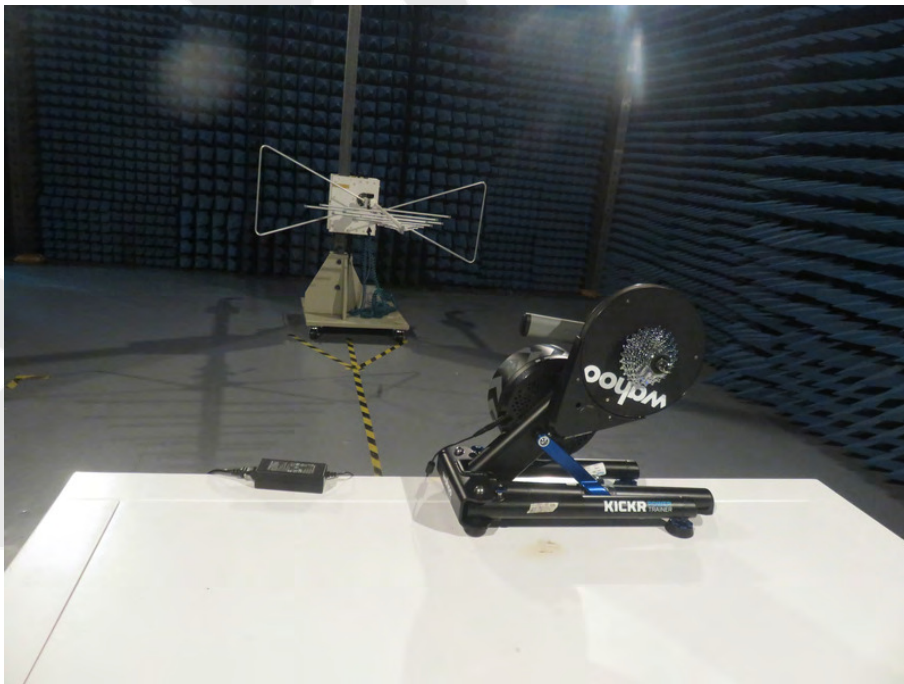

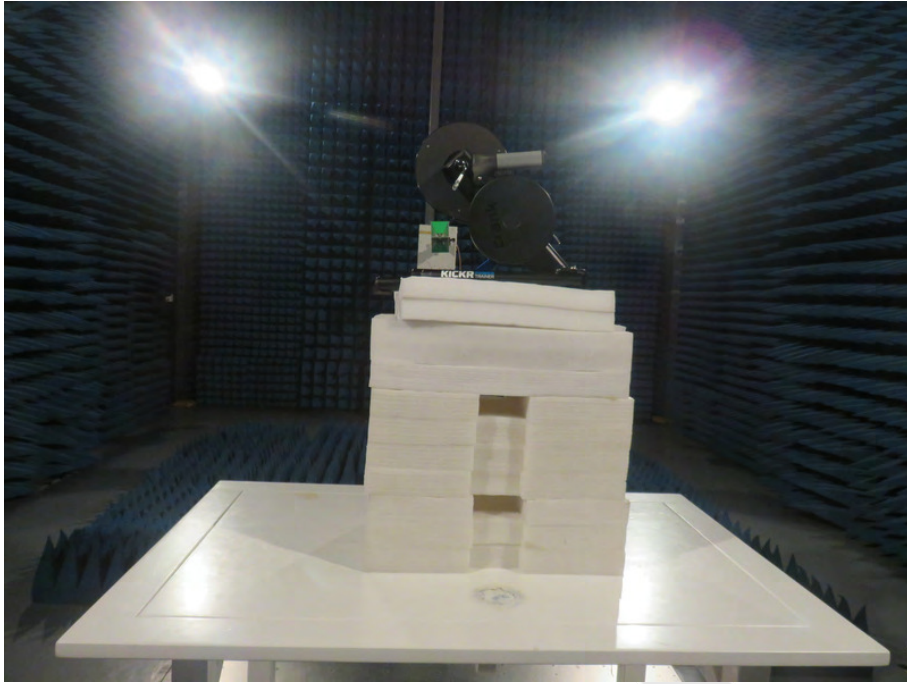

APPENDIX I (EXTERNAL PHOTOS)

1. Figure
The EUT-Overall View



2. Figure
The EUT-Top View



3. Figure
The EUT-Bottom View



4. Figure
The EUT-Front View



5. Figure
The EUT-Back View



6. Figure
The EUT-Right View



7. Figure
The EUT-Left View

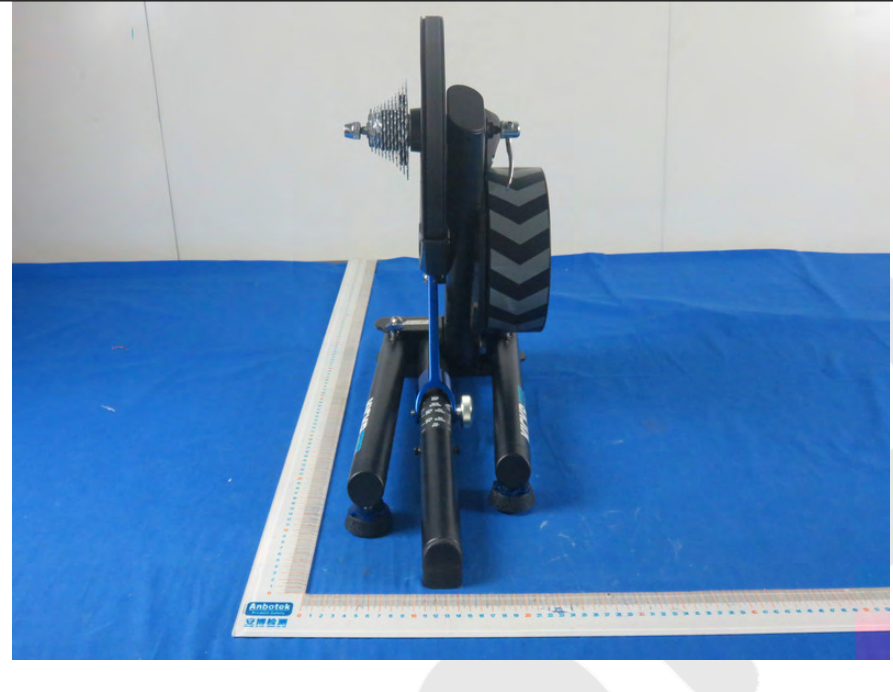

Anbotek

APPENDIX II (INTERNAL PHOTOS)

1. Figure
The EUT-Inside View

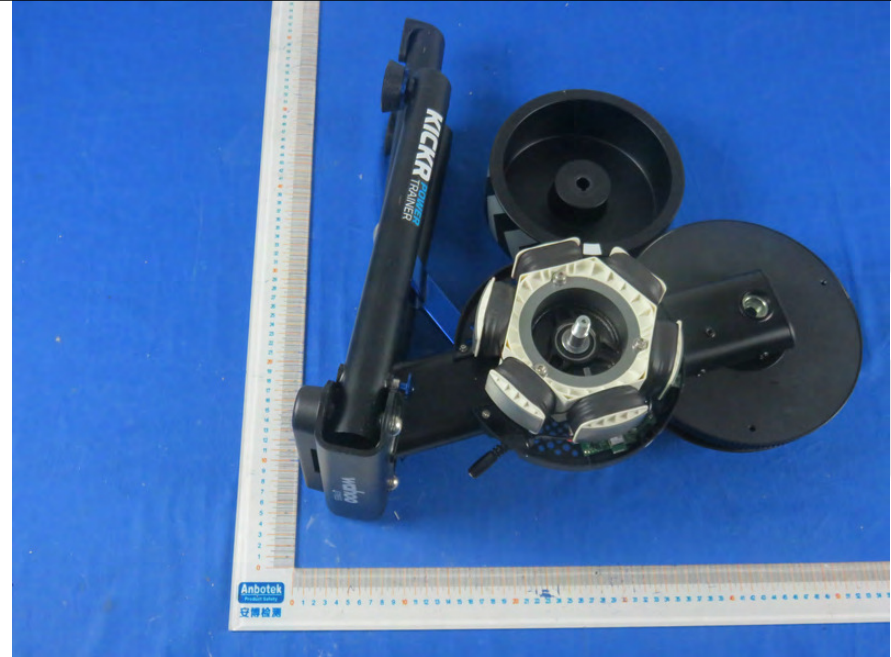

2. Figure
PCB of the EUT-Front View

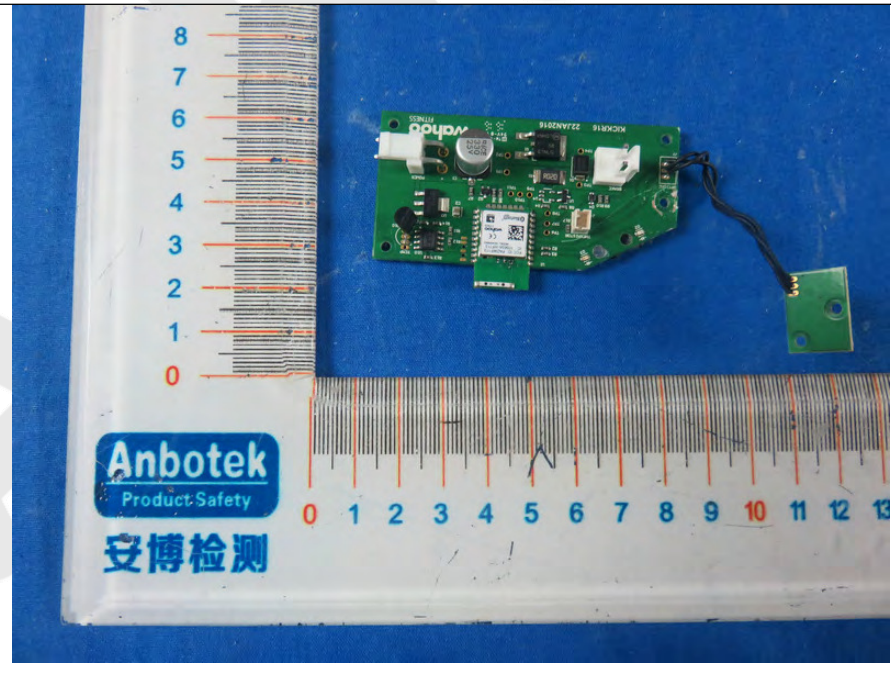

3. Figure
PCB of the EUT-Back View

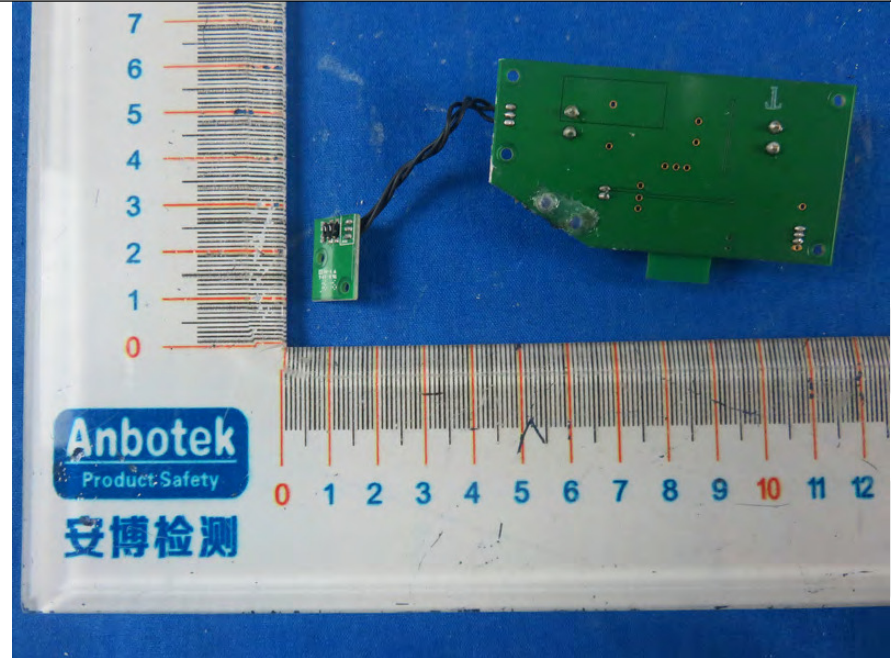

4. Figure
PCB of the EUT-Front View



5. Figure
PCB of the EUT-Back View

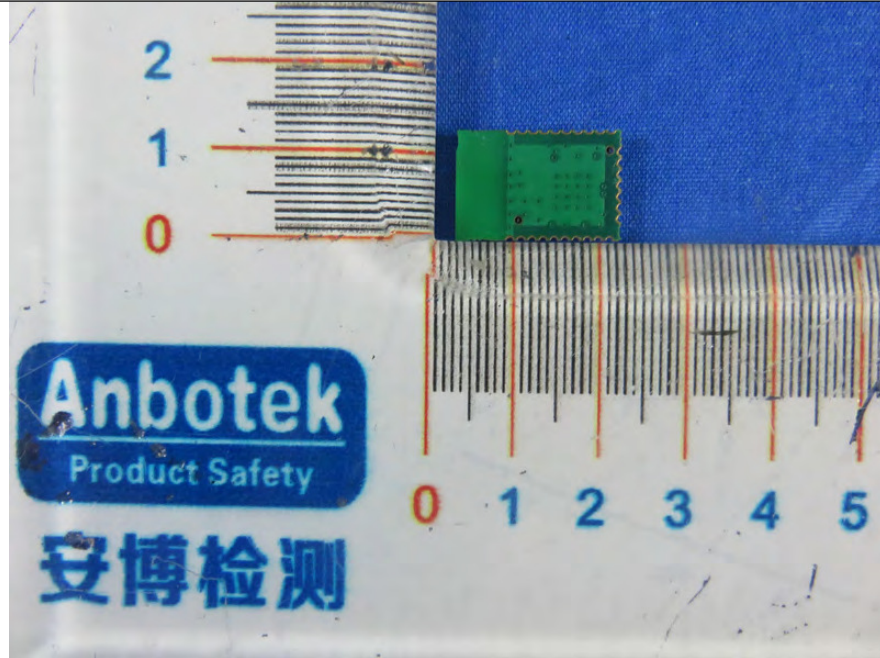

6. Figure
PCB of the EUT-Front View

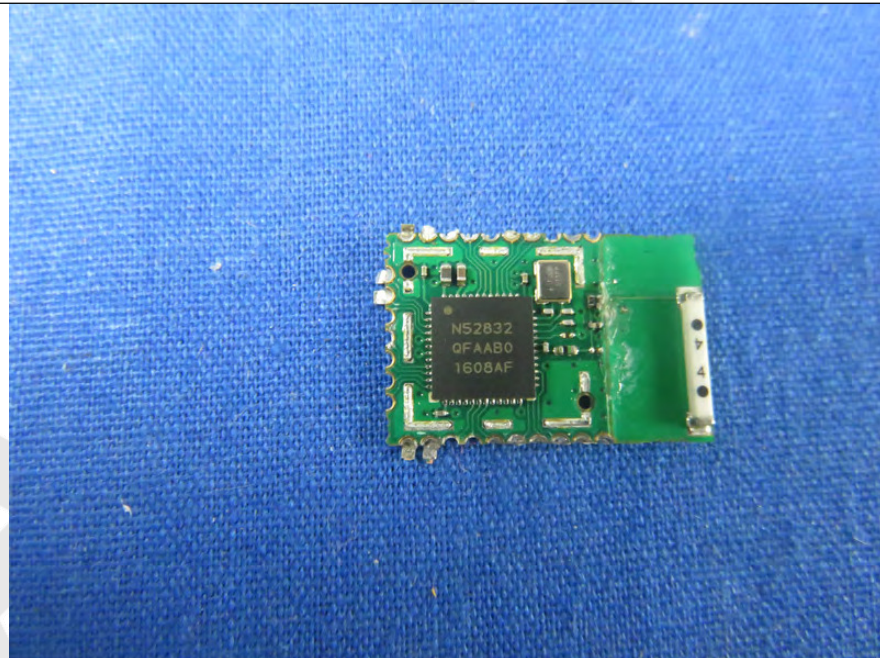

7. Figure
PCB of the EUT-Back View

