



FCC SAR Test Report

APPLICANT : altek Corporation
EQUIPMENT : Digital Camera
BRAND NAME : Kodak
MODEL NAME : KODAK EASYSHARE Wireless Camera M750
MARKETING NAME : KODAK EASYSHARE Wireless Camera M750
FCC ID : PA4-M750
STANDARD : FCC 47 CFR Part 2 (2.1093)
IEEE C95.1-1991
IEEE 1528-2003
FCC OET Bulletin 65 Supplement C (Edition 01-01)

The product was received on Nov. 17, 2011 and completely tested on Nov. 17, 2011. We, SPORTON INTERNATIONAL INC., would like to declare that the tested sample has been evaluated in accordance with the procedures and shown the compliance with the applicable technical standards.

The test results in this report apply exclusively to the tested model / sample. Without written approval of SPORTON INTERNATIONAL INC., the test report shall not be reproduced except in full.

Reviewed by:

Jones Tsai / Manager



SPORTON INTERNATIONAL INC.

No. 52, Hwa Ya 1st Rd., Hwa Ya Technology Park, Kwei-Shan Hsiang, Tao Yuan Hsien, Taiwan, R.O.C.

SPORTON INTERNATIONAL INC.

TEL : 886-3-327-3456

FAX : 886-3-328-4978

FCC ID : PA4-M750

Page Number : 1 of 30

Report Issued Date : Dec. 06, 2011

Report Version : Rev. 01



Table of Contents

1. Statement of Compliance 4
2. Administration Data 5
2.1 Testing Laboratory..... 5
2.2 Applicant 5
2.3 Manufacturer..... 5
2.4 Application Details..... 5
3. General Information 6
3.1 Description of Device Under Test (DUT) 6
3.2 Product Photos..... 7
3.3 Applied Standards..... 7
3.4 Device Category and SAR Limits 8
3.5 Test Conditions..... 8
4. Specific Absorption Rate (SAR)..... 9
4.1 Introduction 9
4.2 SAR Definition..... 9
5. SAR Measurement System10
5.1 E-Field Probe 11
5.2 Data Acquisition Electronics (DAE) 12
5.3 Robot 12
5.4 Measurement Server..... 13
5.5 Phantom..... 13
5.6 Device Holder..... 14
5.7 Data Storage and Evaluation 16
5.8 Test Equipment List..... 18
6. Tissue Simulating Liquids19
7. Uncertainty Assessment 20
8. SAR Measurement Evaluation 22
8.1 Purpose of System Performance check 22
8.2 System Setup..... 22
8.3 Validation Results..... 23
9. DUT Testing Position 24
10. Measurement Procedures 25
10.1 Spatial Peak SAR Evaluation..... 25
10.2 Area & Zoom Scan Procedures..... 26
10.3 Volume Scan Procedures..... 26
10.4 SAR Averaged Methods 26
10.5 Power Drift Monitoring..... 26
11. SAR Test Configurations 27
11.1 Exposure Positions Consideration..... 27
12. SAR Test Results 28
12.1 Conducted Power (Unit: dBm)..... 28
12.2 Test Records for Body SAR Test 29
13. References 30
Appendix A. Plots of System Performance Check
Appendix B. Plots of SAR Measurement
Appendix C. DASYS Calibration Certificate
Appendix D. Product Photos
Appendix E. Test Setup Photos



Revision History

REPORT NO.	VERSION	DESCRIPTION	ISSUED DATE
FA1N0237	Rev. 01	Initial issue of report	Dec. 06, 2011



1. Statement of Compliance

The maximum results of Specific Absorption Rate (SAR) found during testing for **altek Corporation Digital Camera KODAK EASYSHARE Wireless Camera M750** are as follows.

Band	Position	SAR _{1g} (W/kg)
802.11 b/g/n	Body (1 cm Gap)	0.041

This device is in compliance with Specific Absorption Rate (SAR) for general population/uncontrolled exposure limits (1.6 W/kg) specified in FCC 47 CFR part 2 (2.1093) and ANSI/IEEE C95.1-1991, and had been tested in accordance with the measurement methods and procedures specified in IEEE 1528-2003 and FCC OET Bulletin 65 Supplement C (Edition 01-01).



2. Administration Data

2.1 Testing Laboratory

Test Site	SPORTON INTERNATIONAL INC.
Test Site Location	No. 52, Hwa Ya 1 st Rd., Hwa Ya Technology Park, Kwei-Shan Hsiang, Tao Yuan Hsien, Taiwan, R.O.C. TEL: +886-3-327-3456 FAX: +886-3-328-4978

2.2 Applicant

Company Name	altek Corporation
Address	No. 12, Li-Hsin Road, Science-based Industrial Park, Hsin-Chu City, Taiwan

2.3 Manufacturer

Company Name	Altek (Kunshan) Co. Ltd.
Address	No. 77, 3rd. Main Street, Kunshan Export Processing Zone, Jiangsu Province, 215301, China

2.4 Application Details

Date of Receipt of Application	Nov. 17, 2011
Date of Start during the Test	Nov. 17, 2011
Date of End during the Test	Nov. 17, 2011

3. General Information

3.1 Description of Device Under Test (DUT)

Product Feature & Specification	
DUT Type	Digital Camera
Brand Name	Kodak
Model Name	KODAK EASYSHARE Wireless Camera M750
Marketing Name	KODAK EASYSHARE Wireless Camera M750
FCC ID	PA4-M750
Tx Frequency	2400 MHz ~ 2483.5 MHz
Rx Frequency	2400 MHz ~ 2483.5 MHz
Maximum Average Output Power to Antenna	802.11b: 15.5 dBm 802.11g: 13.79 dBm 802.11n (2.4GHz): 13.15 dBm (BW 20MHz)
Antenna Type	Stamping Antenna
Type of Modulation	802.11b: DSSS (BPSK / QPSK / CCK) 802.11g/n: OFDM (BPSK / QPSK / 16QAM / 64QAM)
DUT Stage	Production Unit
Remark: The above DUT's information was declared by manufacturer. Please refer to the specifications or user's manual for more detailed description.	

List of Accessory:

Specification of Accessory		
AC Adapter	Brand Name	Kodak
	Model Name	K20-AM
Battery	Brand Name	Kodak
	Model Name	KLIC-7006
USB Cable	Brand Name	Kodak
LCD Panel 1	Brand Name	Giantplus
	Model Name	Giantplus TP
LCD Panel 2	Brand Name	Giantplus
	Model Name	YFO TP

Remark: The above DUT's information was declared by manufacturer. Please refer to the specifications or user's manual for more detailed description.



3.2 Product Photos

Please refer to Appendix D

3.3 Applied Standards

The Specific Absorption Rate (SAR) testing specification, method and procedure for this device is in accordance with the following standards:

- FCC 47 CFR Part 2 (2.1093)
- IEEE C95.1-1991
- IEEE 1528-2003
- FCC OET Bulletin 65 Supplement C (Edition 01-01)
- FCC KDB 447498 D01 v04
- FCC KDB 616217 D01 v01r01
- FCC KDB 616217 D03 v01
- FCC KDB 248227 D01 v01r02



3.4 Device Category and SAR Limits

This device belongs to portable device category because its radiating structure is allowed to be used within 20 centimeters of the body of the user. Limit for General Population/Uncontrolled exposure should be applied for this device, it is 1.6 W/kg as averaged over any 1 gram of tissue.

3.5 Test Conditions

3.5.1 Ambient Condition

Ambient Temperature	20 to 24 °C
Humidity	< 60 %

3.5.2 Test Configuration

For WLAN SAR testing, WLAN engineering testing software installed on the DUT can provide continuous transmitting RF signal. This RF signal utilized in SAR measurement has almost 100% duty cycle and its crest factor is 1.

4. Specific Absorption Rate (SAR)

4.1 Introduction

SAR is related to the rate at which energy is absorbed per unit mass in an object exposed to a radio field. The SAR distribution in a biological body is complicated and is usually carried out by experimental techniques or numerical modeling. The standard recommends limits for two tiers of groups, occupational/controlled and general population/uncontrolled, based on a person's awareness and ability to exercise control over his or her exposure. In general, occupational/controlled exposure limits are higher than the limits for general population/uncontrolled.

4.2 SAR Definition

The SAR definition is the time derivative (rate) of the incremental energy (dW) absorbed by (dissipated in) an incremental mass (dm) contained in a volume element (dv) of a given density (ρ). The equation description is as below:

$$\text{SAR} = \frac{d}{dt} \left(\frac{dW}{dm} \right) = \frac{d}{dt} \left(\frac{dW}{\rho dv} \right)$$

SAR is expressed in units of Watts per kilogram (W/kg)

SAR measurement can be either related to the temperature elevation in tissue by

$$\text{SAR} = C \left(\frac{\delta T}{\delta t} \right)$$

Where: C is the specific heat capacity, δT is the temperature rise and δt is the exposure duration, or related to the electrical field in the tissue by

$$\text{SAR} = \frac{\sigma |E|^2}{\rho}$$

Where: σ is the conductivity of the tissue, ρ is the mass density of the tissue and E is the RMS electrical field strength.

However for evaluating SAR of low power transmitter, electrical field measurement is typically applied.

5. SAR Measurement System

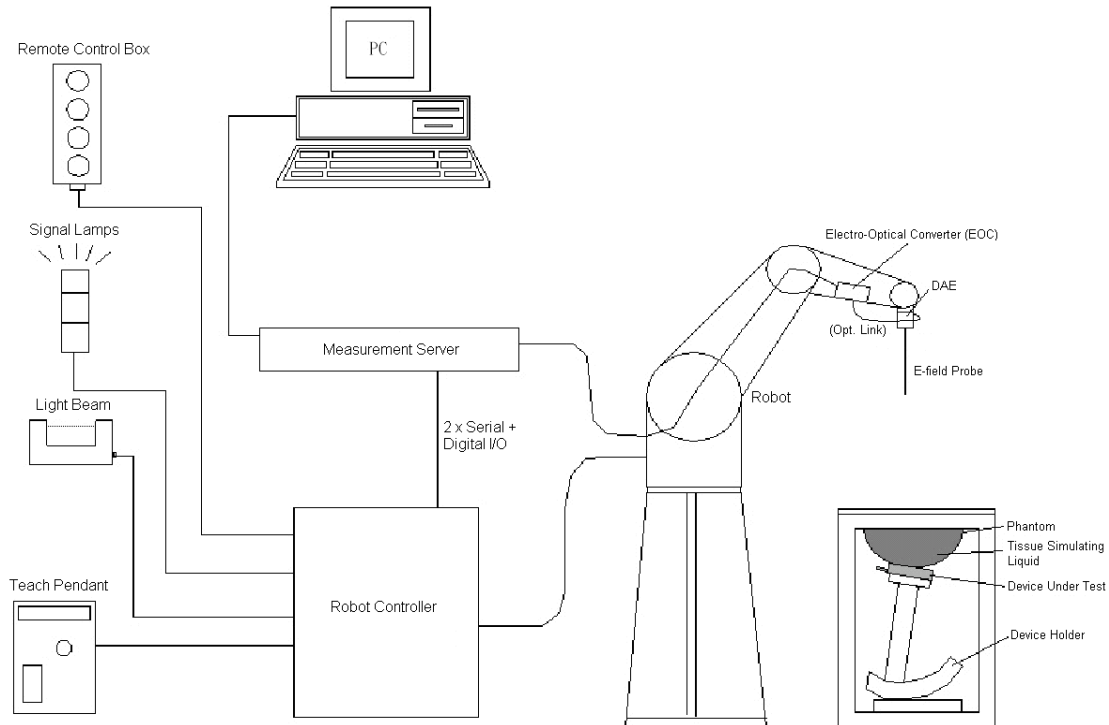

Fig 5.1 SPEAG DASY System Configurations

The DASY system for performance compliance tests is illustrated above graphically. This system consists of the following items:

- A standard high precision 6-axis robot with controller, a teach pendant and software
- A data acquisition electronic (DAE) attached to the robot arm extension
- A dosimetric probe equipped with an optical surface detector system
- The electro-optical converter (ECO) performs the conversion between optical and electrical signals
- A measurement server performs the time critical tasks such as signal filtering, control of the robot operation and fast movement interrupts.
- A probe alignment unit which improves the accuracy of the probe positioning
- A computer operating Windows XP
- DASY software
- Remote control with teach pendant and additional circuitry for robot safety such as warning lamps, etc.
- The SAM twin phantom
- A device holder
- Tissue simulating liquid
- Dipole for evaluating the proper functioning of the system

Some of the components are described in details in the following sub-sections.

5.1 E-Field Probe

The SAR measurement is conducted with the dosimetric probe (manufactured by SPEAG). The probe is specially designed and calibrated for use in liquid with high permittivity. The dosimetric probe has special calibration in liquid at different frequency. This probe has a built in optical surface detection system to prevent from collision with phantom.

5.1.1 E-Field Probe Specification

<ET3DV6 Probe >

Construction	Symmetrical design with triangular core Built-in optical fiber for surface detection system. Built-in shielding against static charges. PEEK enclosure material (resistant to organic solvents, e.g., DGBE)
Frequency	10 MHz to 3 GHz; Linearity: ± 0.2 dB
Directivity	± 0.2 dB in HSL (rotation around probe axis) ± 0.4 dB in HSL (rotation normal to probe axis)
Dynamic Range	5 μ W/g to 100 mW/g; Linearity: ± 0.2 dB
Dimensions	Overall length: 330 mm (Tip: 16 mm) Tip diameter: 6.8 mm (Body: 12 mm) Distance from probe tip to dipole centers: 2.7 mm

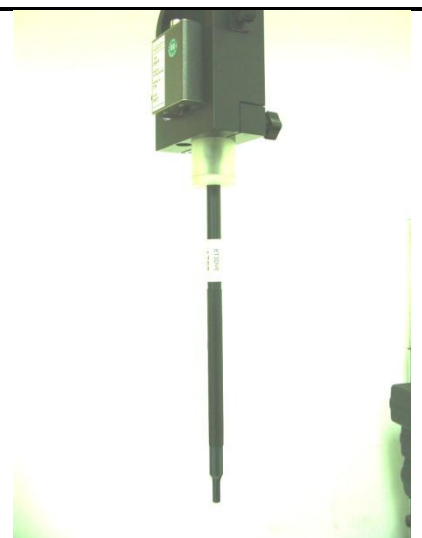

Fig 5.2 Photo of ET3DV6

<EX3DV4 Probe>

Construction	Symmetrical design with triangular core Built-in shielding against static charges PEEK enclosure material (resistant to organic solvents, e.g., DGBE)
Frequency	10 MHz to 6 GHz; Linearity: ± 0.2 dB
Directivity	± 0.3 dB in HSL (rotation around probe axis) ± 0.5 dB in tissue material (rotation normal to probe axis)
Dynamic Range	10 μ W/g to 100 mW/g; Linearity: ± 0.2 dB (noise: typically < 1 μ W/g)
Dimensions	Overall length: 330 mm (Tip: 20 mm) Tip diameter: 2.5 mm (Body: 12 mm) Typical distance from probe tip to dipole centers: 1 mm



Fig 5.3 Photo of EX3DV4

5.1.2 E-Field Probe Calibration

Each probe needs to be calibrated according to a dosimetric assessment procedure with accuracy better than $\pm 10\%$. The spherical isotropy shall be evaluated and within ± 0.25 dB. The sensitivity parameters (NormX, NormY, and NormZ), the diode compression parameter (DCP) and the conversion factor (ConvF) of the probe are tested. The calibration data can be referred to appendix C of this report.

5.2 Data Acquisition Electronics (DAE)

The data acquisition electronics (DAE) consists of a highly sensitive electrometer-grade preamplifier with auto-zeroing, a channel and gain-switching multiplexer, a fast 16 bit AD-converter and a command decoder and control logic unit. Transmission to the measurement server is accomplished through an optical downlink for data and status information as well as an optical uplink for commands and the clock.

The input impedance of the DAE is 200 MOhm; the inputs are symmetrical and floating. Common mode rejection is above 80 dB.



Fig 5.4 Photo of DAE

5.3 Robot

The SPEAG DASY system uses the high precision robots (DASY4: RX90BL; DASY5: TX90XL) type from Stäubli SA (France). For the 6-axis controller system, the robot controller version (DASY4: CS7MB; DASY5: CS8c) from Stäubli is used. The Stäubli robot series have many features that are important for our application:

- High precision (repeatability ± 0.035 mm)
- High reliability (industrial design)
- Jerk-free straight movements
- Low ELF interference (the closed metallic construction shields against motor control fields)



Fig 5.1 Photo of DASY4



Fig 5.2 Photo of DASY5

5.4 Measurement Server

The measurement server is based on a PC/104 CPU board with CPU (DASY4: 166 MHz, Intel Pentium; DASY5: 400 MHz, Intel Celeron), chipdisk (DASY4: 32 MB; DASY5: 128 MB), RAM (DASY4: 64 MB, DASY5: 128 MB). The necessary circuits for communication with the DAE electronic box, as well as the 16 bit AD converter system for optical detection and digital I/O interface are contained on the DASY I/O board, which is directly connected to the PC/104 bus of the CPU board.

The measurement server performs all the real-time data evaluation for field measurements and surface detection, controls robot movements and handles safety operations.



Fig 5.1 Photo of Server for DASY4



Fig 5.2 Photo of Server for DASY5

5.5 Phantom

<SAM Twin Phantom>

Shell Thickness	2 ± 0.2 mm; Center ear point: 6 ± 0.2 mm
Filling Volume	Approx. 25 liters
Dimensions	Length: 1000 mm; Width: 500 mm; Height: adjustable feet
Measurement Areas	Left Hand, Right Hand, Flat Phantom



Fig 5.3 Photo of SAM Phantom

The bottom plate contains three pair of bolts for locking the device holder. The device holder positions are adjusted to the standard measurement positions in the three sections. A white cover is provided to tap the phantom during off-periods to prevent water evaporation and changes in the liquid parameters. On the phantom top, three reference markers are provided to identify the phantom position with respect to the robot.

<ELI4 Phantom>

Shell Thickness	2 ± 0.2 mm (sagging: <1%)
Filling Volume	Approx. 30 liters
Dimensions	Major ellipse axis: 600 mm Minor axis: 400 mm



Fig 5.4 Photo of ELI4 Phantom

The ELI4 phantom is intended for compliance testing of handheld and body-mounted wireless devices in the frequency range of 30 MHz to 6 GHz. ELI4 is fully compatible with standard and all known tissue simulating liquids.

5.6 Device Holder

<Device Holder for SAM Twin Phantom>

The SAR in the phantom is approximately inversely proportional to the square of the distance between the source and the liquid surface. For a source at 5 mm distance, a positioning uncertainty of ± 0.5 mm would produce a SAR uncertainty of ± 20 %. Accurate device positioning is therefore crucial for accurate and repeatable measurements. The positions in which the devices must be measured are defined by the standards.

The DASY device holder is designed to cope with different positions given in the standard. It has two scales for the device rotation (with respect to the body axis) and the device inclination (with respect to the line between the ear reference points). The rotation center for both scales is the ear reference point (EPR). Thus the device needs no repositioning when changing the angles.

The DASY device holder is constructed of low-loss POM material having the following dielectric parameters: relative permittivity $\epsilon = 3$ and loss tangent $\delta = 0.02$. The amount of dielectric material has been reduced in the closest vicinity of the device, since measurements have suggested that the influence of the clamp on the test results could thus be lowered.



Fig 5.5 Device Holder

<Laptop Extension Kit>

The extension is lightweight and made of POM, acrylic glass and foam. It fits easily on the upper part of the mounting device in place of the phone positioned. The extension is fully compatible with the SAM Twin and ELI phantoms.

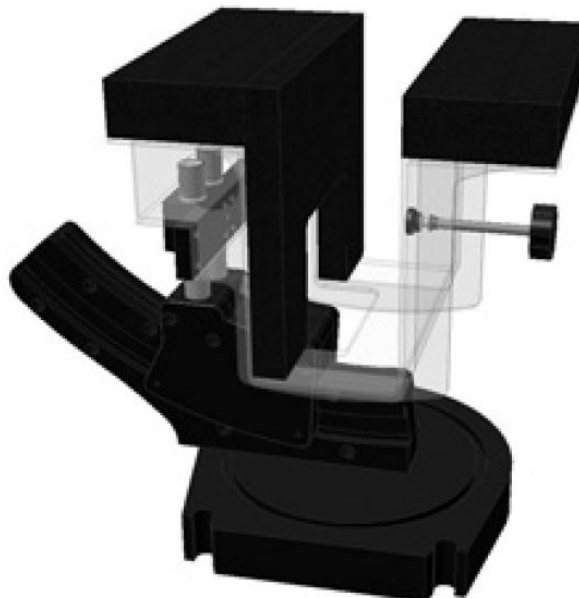

Fig 5.6 Laptop Extension Kit

5.7 Data Storage and Evaluation

5.7.1 Data Storage

The DASY software stores the assessed data from the data acquisition electronics as raw data (in microvolt readings from the probe sensors), together with all the necessary software parameters for the data evaluation (probe calibration data, liquid parameters and device frequency and modulation data) in measurement files. The post-processing software evaluates the desired unit and format for output each time the data is visualized or exported. This allows verification of the complete software setup even after the measurement and allows correction of erroneous parameter settings. For example, if a measurement has been performed with an incorrect crest factor parameter in the device setup, the parameter can be corrected afterwards and the data can be reevaluated.

The measured data can be visualized or exported in different units or formats, depending on the selected probe type (e.g., [V/m], [A/m], [mW/g]). Some of these units are not available in certain situations or give meaningless results, e.g., a SAR-output in a non-lose media, will always be zero. Raw data can also be exported to perform the evaluation with other software packages.

5.7.2 Data Evaluation

The DASY post-processing software (SEMCAD) automatically executes the following procedures to calculate the field units from the microvolt readings at the probe connector. The parameters used in the evaluation are stored in the configuration modules of the software :

Probe parameters :	- Sensitivity	Norm _i , a ₁₀ , a ₁₁ , a ₁₂
	- Conversion factor	ConvF _i
	- Diode compression point	dcp _i
Device parameters :	- Frequency	f
	- Crest factor	cf
Media parameters :	- Conductivity	σ
	- Density	ρ

These parameters must be set correctly in the software. They can be found in the component documents or they can be imported into the software from the configuration files issued for the DASY components. In the direct measuring mode of the multi-meter option, the parameters of the actual system setup are used. In the scan visualization and export modes, the parameters stored in the corresponding document files are used.

The first step of the evaluation is a linearization of the filtered input signal to account for the compression characteristics of the detector diode. The compensation depends on the input signal, the diode type and the DC-transmission factor from the diode to the evaluation electronics. If the exciting field is pulsed, the crest factor of the signal must be known to correctly compensate for peak power.

The formula for each channel can be given as :

$$V_i = U_i + U_i^2 \cdot \frac{cf}{dcp_i}$$

with V_i = compensated signal of channel i, (i = x, y, z)
 U_i = input signal of channel i, (i = x, y, z)
 cf = crest factor of exciting field (DASY parameter)
 dcp_i = diode compression point (DASY parameter)

From the compensated input signals, the primary field data for each channel can be evaluated :

$$\text{E-field Probes : } E_i = \sqrt{\frac{V_i}{\text{Norm}_i \cdot \text{ConvF}}}$$

$$\text{H-field Probes : } H_i = \sqrt{V_i} \cdot \frac{a_{i0} + a_{i1}f + a_{i2}f^2}{f}$$

with V_i = compensated signal of channel i, (i = x, y, z)
 Norm_i = sensor sensitivity of channel i, (i = x, y, z), $\mu\text{V}/(\text{V/m})^2$ for E-field Probes
 ConvF = sensitivity enhancement in solution
 a_{ij} = sensor sensitivity factors for H-field probes
 f = carrier frequency [GHz]
 E_i = electric field strength of channel i in V/m
 H_i = magnetic field strength of channel i in A/m

The RSS value of the field components gives the total field strength (Hermitian magnitude) :

$$E_{\text{tot}} = \sqrt{E_x^2 + E_y^2 + E_z^2}$$

The primary field data are used to calculate the derived field units.

$$\text{SAR} = E_{\text{tot}}^2 \cdot \frac{\sigma}{\rho \cdot 1000}$$

with SAR = local specific absorption rate in mW/g
 E_{tot} = total field strength in V/m
 σ = conductivity in [mho/m] or [Siemens/m]
 ρ = equivalent tissue density in g/cm^3

Note that the density is set to 1, to account for actual head tissue density rather than the density of the tissue simulating liquid.



5.8 Test Equipment List

Manufacturer	Name of Equipment	Type/Model	Serial Number	Calibration	
				Last Cal.	Due Date
SPEAG	Dosimetric E-Field Probe	ET3DV6	1788	Sep. 28, 2011	Sep. 27, 2012
SPEAG	2450MHz System Validation Kit	D2450V2	736	Jul. 25, 2011	Jul. 24, 2014
SPEAG	Data Acquisition Electronics	DAE3	577	Jun. 20, 2011	Jun. 19, 2012
SPEAG	Device Holder	N/A	N/A	NCR	NCR
SPEAG	SAM Phantom	QD 000 P40 C	TP-1303	NCR	NCR
SPEAG	SAM Phantom	QD 000 P40 C	TP-1383	NCR	NCR
SPEAG	SAM Phantom	QD 000 P40 C	TP-1446	NCR	NCR
SPEAG	SAM Phantom	QD 000 P40 C	TP-1478	NCR	NCR
SPEAG	SAM Phantom	QD 000 P41 C	TP-1150	NCR	NCR
SPEAG	SAM Phantom	QD 000 P40 CD	TP-1644	NCR	NCR
SPEAG	SAM Phantom	SM 000 T01 DA	TP-1542	NCR	NCR
SPEAG	ELI4 Phantom	QD 0VA 001 BB	1026	NCR	NCR
SPEAG	ELI4 Phantom	QD 0VA 001 BA	1029	NCR	NCR
SPEAG	ELI4 Phantom	QD 0VA 002 AA	TP-1127	NCR	NCR
SPEAG	ELI4 Phantom	QD 0VA 002 AA	TP-1131	NCR	NCR
Agilent	ENA Series Network Analyzer	E5071C	MY46100746	Jun. 10, 2011	Jun. 09, 2012
Anritsu	Radio Communication Analyzer	MT8820C	6201026480	Aug. 12, 2011	Aug. 11, 2012
Agilent	Wireless Communication Test Set	E5515C	MY48360820	Jan. 12, 2010	Jan. 11, 2012
Agilent	Wireless Communication Test Set	E5515C	GB46311322	Mar. 23, 2011	Mar. 22, 2013
Agilent	Wireless Communication Test Set	E5515C	MY50264370	Apr. 19, 2011	Apr. 18, 2013
R&S	Universal Radio Communication Tester	CMU200	114256	Feb. 08, 2010	Feb. 07, 2012
Agilent	Dielectric Probe Kit	85070D	US01440205	NCR	NCR
Agilent	Dual Directional Coupler	778D	50422	NCR	NCR
AR	Power Amplifier	5S1G4M2	0328767	NCR	NCR
R&S	Spectrum Analyzer	FSP7	101131	Jul. 29, 2011	Jul. 28, 2012
R&S	Spectrum Analyzer	FSP30	101329	May 03, 2011	May 02, 2012

Table 5.1 Test Equipment List

Note: The calibration certificate of DASY can be referred to appendix C of this report.

6. Tissue Simulating Liquids

For the measurement of the field distribution inside the SAM phantom with DASY, the phantom must be filled with around 25 liters of homogeneous body tissue simulating liquid. For head SAR testing, the liquid height from the ear reference point (ERP) of the phantom to the liquid top surface is larger than 15 cm, which is shown in Fig. 6.1. For body SAR testing, the liquid height from the center of the flat phantom to the liquid top surface is larger than 15 cm, which is shown in Fig. 6.2.

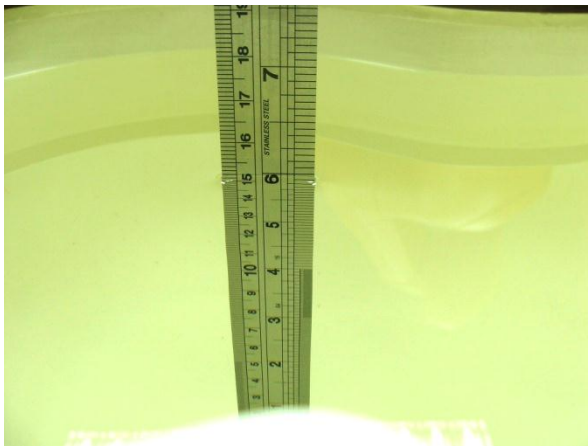

Fig 6.1 Photo of Liquid Height for Head SAR



Fig 6.2 Photo of Liquid Height for Body SAR

The following table gives the recipes for tissue simulating liquid.

Frequency (MHz)	Water (%)	Sugar (%)	Cellulose (%)	Salt (%)	Preventol (%)	DGBE (%)	Conductivity (σ)	Permittivity (ϵ_r)
For Head								
2450	55.0	0	0	0	0	45.0	1.80	39.2
For Body								
2450	68.6	0	0	0	0	31.4	1.95	52.7

Table 6.1 Recipes of Tissue Simulating Liquid

The dielectric parameters of the liquids were verified prior to the SAR evaluation using an Agilent 85070D Dielectric Probe Kit and an Agilent Network Analyzer.

The following table shows the measuring results for simulating liquid.

Freq.	Liquid Type	Temp. (°C)	Conductivity (σ)	Permittivity (ϵ_r)	Conductivity Target (σ)	Permittivity Target (ϵ_r)	Delta (σ) (%)	Delta (ϵ_r) (%)	Limit (%)	Date
2450	Body	21.5	1.96	52.9	1.95	52.7	0.51	0.38	±5	Nov. 17, 2011

Table 6.2 Measuring Results for Simulating Liquid

7. Uncertainty Assessment

The component of uncertainty may generally be categorized according to the methods used to evaluate them. The evaluation of uncertainty by the statistical analysis of a series of observations is termed a Type A evaluation of uncertainty. The evaluation of uncertainty by means other than the statistical analysis of a series of observation is termed a Type B evaluation of uncertainty. Each component of uncertainty, however evaluated, is represented by an estimated standard deviation, termed standard uncertainty, which is determined by the positive square root of the estimated variance.

A Type A evaluation of standard uncertainty may be based on any valid statistical method for treating data. This includes calculating the standard deviation of the mean of a series of independent observations; using the method of least squares to fit a curve to the data in order to estimate the parameter of the curve and their standard deviations; or carrying out an analysis of variance in order to identify and quantify random effects in certain kinds of measurement.

A type B evaluation of standard uncertainty is typically based on scientific judgment using all of the relevant information available. These may include previous measurement data, experience and knowledge of the behavior and properties of relevant materials and instruments, manufacture’s specification, data provided in calibration reports and uncertainties assigned to reference data taken from handbooks. Broadly speaking, the uncertainty is either obtained from an outdoor source or obtained from an assumed distribution, such as the normal distribution, rectangular or triangular distributions indicated in Table 7.1

Uncertainty Distributions	Normal	Rectangular	Triangular	U-Shape
Multi-plying Factor ^(a)	1/k ^(b)	1/√3	1/√6	1/√2

(a) standard uncertainty is determined as the product of the multiplying factor and the estimated range of variations in the measured quantity

(b) κ is the coverage factor

Table 7.1 Standard Uncertainty for Assumed Distribution

The combined standard uncertainty of the measurement result represents the estimated standard deviation of the result. It is obtained by combining the individual standard uncertainties of both Type A and Type B evaluation using the usual “root-sum-squares” (RSS) methods of combining standard deviations by taking the positive square root of the estimated variances.

Expanded uncertainty is a measure of uncertainty that defines an interval about the measurement result within which the measured value is confidently believed to lie. It is obtained by multiplying the combined standard uncertainty by a coverage factor. Typically, the coverage factor ranges from 2 to 3. Using a coverage factor allows the true value of a measured quantity to be specified with a defined probability within the specified uncertainty range. For purpose of this document, a coverage factor two is used, which corresponds to confidence interval of about 95 %. The DASY uncertainty Budget is showed in Table 7.2.



Error Description	Uncertainty Value (±%)	Probability Distribution	Divisor	Ci (1g)	Standard Uncertainty (1g)
Measurement System					
Probe Calibration	6.0	Normal	1	1	± 6.0 %
Axial Isotropy	4.7	Rectangular	√3	0.7	± 1.9 %
Hemispherical Isotropy	9.6	Rectangular	√3	0.7	± 3.9 %
Boundary Effects	1.0	Rectangular	√3	1	± 0.6 %
Linearity	4.7	Rectangular	√3	1	± 2.7 %
System Detection Limits	1.0	Rectangular	√3	1	± 0.6 %
Readout Electronics	0.3	Normal	1	1	± 0.3 %
Response Time	0.8	Rectangular	√3	1	± 0.5 %
Integration Time	2.6	Rectangular	√3	1	± 1.5 %
RF Ambient Noise	3.0	Rectangular	√3	1	± 1.7 %
RF Ambient Reflections	3.0	Rectangular	√3	1	± 1.7 %
Probe Positioner	0.4	Rectangular	√3	1	± 0.2 %
Probe Positioning	2.9	Rectangular	√3	1	± 1.7 %
Max. SAR Eval.	1.0	Rectangular	√3	1	± 0.6 %
Test Sample Related					
Device Positioning	2.9	Normal	1	1	± 2.9 %
Device Holder	3.6	Normal	1	1	± 3.6 %
Power Drift	5.0	Rectangular	√3	1	± 2.9 %
Phantom and Setup					
Phantom Uncertainty	4.0	Rectangular	√3	1	± 2.3 %
Liquid Conductivity (Target)	5.0	Rectangular	√3	0.64	± 1.8 %
Liquid Conductivity (Meas.)	2.5	Normal	1	0.64	± 1.6 %
Liquid Permittivity (Target)	5.0	Rectangular	√3	0.6	± 1.7 %
Liquid Permittivity (Meas.)	2.5	Normal	1	0.6	± 1.5 %
Combined Standard Uncertainty					± 10.99 %
Coverage Factor for 95 %					K = 2
Expanded Uncertainty					± 21.97 %

Table 7.2 Uncertainty Budget of DASYS for frequency range 300 MHz to 3 GHz

8. SAR Measurement Evaluation

Each DASY system is equipped with one or more system validation kits. These units, together with the predefined measurement procedures within the DASY software, enable the user to conduct the system performance check and system validation. System validation kit includes a dipole, tripod holder to fix it underneath the flat phantom and a corresponding distance holder.

8.1 Purpose of System Performance check

The system performance check verifies that the system operates within its specifications. System and operator errors can be detected and corrected. It is recommended that the system performance check be performed prior to any usage of the system in order to guarantee reproducible results. The system performance check uses normal SAR measurements in a simplified setup with a well characterized source. This setup was selected to give a high sensitivity to all parameters that might fail or vary over time. The system check does not intend to replace the calibration of the components, but indicates situations where the system uncertainty is exceeded due to drift or failure.

8.2 System Setup

In the simplified setup for system evaluation, the DUT is replaced by a calibrated dipole and the power source is replaced by a continuous wave that comes from a signal generator. The calibrated dipole must be placed beneath the flat phantom section of the SAM twin phantom with the correct distance holder. The distance holder should touch the phantom surface with a light pressure at the reference marking and be oriented parallel to the long side of the phantom. The equipment setup is shown below:

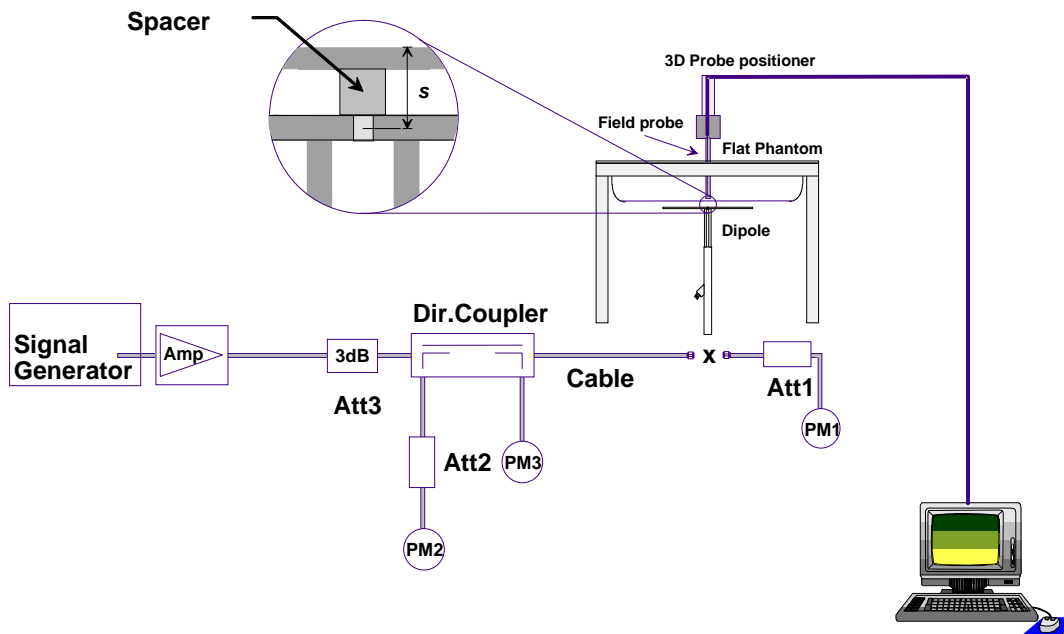

Fig 8.1 System Setup for System Evaluation

1. Signal Generator
2. Amplifier
3. Directional Coupler
4. Power Meter
5. Calibrated Dipole

The output power on dipole port must be calibrated to 24 dBm (250 mW) before dipole is connected.

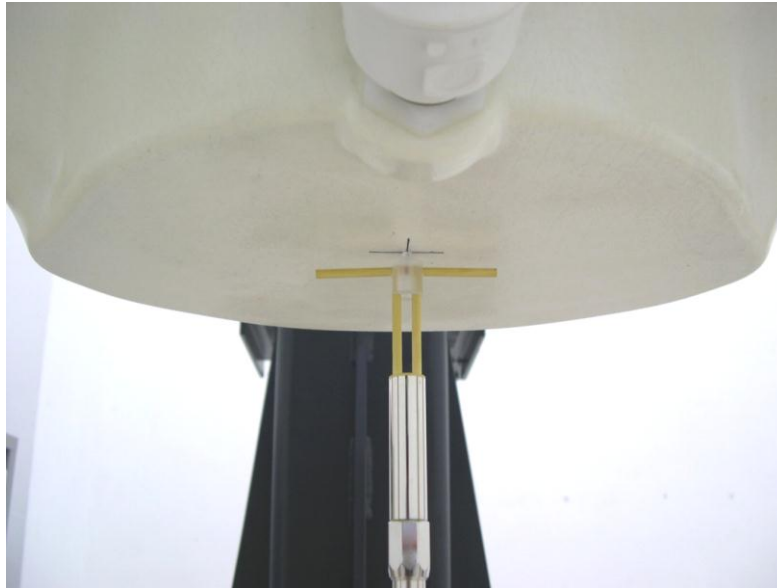

Fig 8.2 Photo of Dipole Setup

8.3 Validation Results

Comparing to the original SAR value provided by SPEAG, the validation data should be within its specification of 10 %. Table 8.1 shows the target SAR and measured SAR after normalized to 1W input power. The table below indicates the system performance check can meet the variation criterion and the plots can be referred to Appendix A of this report.

Measurement Date	Frequency (MHz)	Liquid Type	Targeted SAR _{1g} (W/kg)	Measured SAR _{1g} (W/kg)	Normalized SAR _{1g} (W/kg)	Deviation (%)
Nov. 17, 2011	2450	Body	52.3	13.6	54.40	4.02

Table 8.1 Target and Measurement SAR after Normalized

9. DUT Testing Position

This DUT was tested in five different positions. They are Front of the DUT with phantom 1 cm gap, Back of the DUT with phantom 1 cm gap, Top Side of the DUT with phantom 1 cm gap, Bottom Side of the DUT with phantom 1 cm gap, and Right Side of the DUT with phantom 1 cm gap.

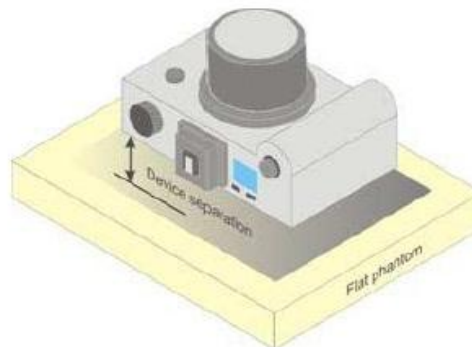

Fig 9.1 Illustration for Lap-touching Position

10. Measurement Procedures

The measurement procedures are as follows:

- (a) Use engineering software to transmit RF power continuously (continuous Tx) in the highest power channel.
- (b) Keep DUT to radiate 100% duty cycle.
- (c) Measure output power through RF cable and power meter.
- (d) Place the DUT in the positions as Appendix E demonstrates.
- (e) Set scan area, grid size and other setting on the DASY software.
- (f) Measure SAR results for the highest power channel on each testing position.
- (g) Find out the largest SAR result on these testing positions of each band
- (h) Measure SAR results for other channels in worst SAR testing position if the SAR of highest power channel is larger than 0.8 W/kg

According to the test standard, the recommended procedure for assessing the peak spatial-average SAR value consists of the following steps:

- (a) Power reference measurement
- (b) Area scan
- (c) Zoom scan
- (d) Power drift measurement

10.1 Spatial Peak SAR Evaluation

The procedure for spatial peak SAR evaluation has been implemented according to the test standard. It can be conducted for 1g and 10g, as well as for user-specific masses. The DASY software includes all numerical procedures necessary to evaluate the spatial peak SAR value.

The base for the evaluation is a "cube" measurement. The measured volume must include the 1g and 10g cubes with the highest averaged SAR values. For that purpose, the center of the measured volume is aligned to the interpolated peak SAR value of a previously performed area scan.

The entire evaluation of the spatial peak values is performed within the post-processing engine (SEMCAD). The system always gives the maximum values for the 1g and 10g cubes. The algorithm to find the cube with highest averaged SAR is divided into the following stages:

- (a) Extraction of the measured data (grid and values) from the Zoom Scan
- (b) Calculation of the SAR value at every measurement point based on all stored data (A/D values and measurement parameters)
- (c) Generation of a high-resolution mesh within the measured volume
- (d) Interpolation of all measured values from the measurement grid to the high-resolution grid
- (e) Extrapolation of the entire 3-D field distribution to the phantom surface over the distance from sensor to surface
- (f) Calculation of the averaged SAR within masses of 1g and 10g



10.2 Area & Zoom Scan Procedures

First Area Scan is used to locate the approximate location(s) of the local peak SAR value(s). The measurement grid within an Area Scan is defined by the grid extent, grid step size and grid offset. Next, in order to determine the EM field distribution in a three-dimensional spatial extension, Zoom Scan is required. The Zoom Scan measures 5x5x7 points with step size 8, 8 and 5 mm for 300 MHz to 3 GHz, and 8x8x8 points with step size 4, 4 and 2.5 mm for 3 GHz to 6 GHz. The Zoom Scan is performed around the highest E-field value to determine the averaged SAR-distribution over 10 g.

10.3 Volume Scan Procedures

The volume scan is used for assess overlapping SAR distributions for antennas transmitting in different frequency bands. It is equivalent to an oversized zoom scan used in standalone measurements. The measurement volume will be used to enclose all the simultaneous transmitting antennas. For antennas transmitting simultaneously in different frequency bands, the volume scan is measured separately in each frequency band. In order to sum correctly to compute the 1g aggregate SAR, the DUT remain in the same test position for all measurements and all volume scan use the same spatial resolution and grid spacing (step-size is 4, 4 and 2.5 mm). When all volume scan were completed, the software, SEMCAD postprocessor can combine and subsequently superpose these measurement data to calculating the multiband SAR.

10.4 SAR Averaged Methods

In DASy, the interpolation and extrapolation are both based on the modified Quadratic Shepard's method. The interpolation scheme combines a least-square fitted function method and a weighted average method which are the two basic types of computational interpolation and approximation.

Extrapolation routines are used to obtain SAR values between the lowest measurement points and the inner phantom surface. The extrapolation distance is determined by the surface detection distance and the probe sensor offset. The uncertainty increases with the extrapolation distance. To keep the uncertainty within 1% for the 1 g and 10 g cubes, the extrapolation distance should not be larger than 5 mm.

10.5 Power Drift Monitoring

All SAR testing is under the DUT install full charged battery and transmit maximum output power. In DASy measurement software, the power reference measurement and power drift measurement procedures are used for monitoring the power drift of DUT during SAR test. Both these procedures measure the field at a specified reference position before and after the SAR testing. The software will calculate the field difference in dB. If the power drift more than 5%, the SAR will be retested.

11. SAR Test Configurations

11.1 Exposure Positions Consideration

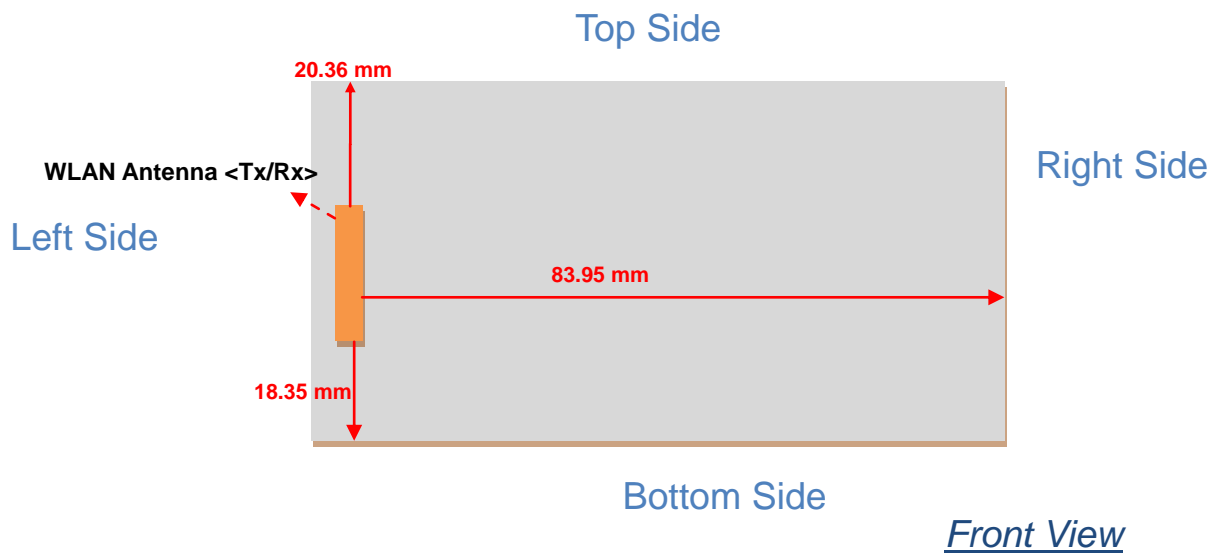

12. SAR Test Results

12.1 Conducted Power (Unit: dBm)

Mode	Channel	Frequency (MHz)	Average power (dBm)
			Data Rate (bps)
			1M
802.11b	CH 01	2412 MHz	15.5
	CH 06	2437 MHz	15.31
	CH 11	2462 MHz	14.98

Mode	Channel	Frequency (MHz)	Average power (dBm)
			Data Rate (bps)
			6M
802.11g	CH 01	2412 MHz	13.79
	CH 06	2437 MHz	13.51
	CH 11	2462 MHz	13.22

Mode	Channel	Frequency (MHz)	Average power (dBm)
			Data Rate (bps)
			MCS0
802.11n 20M	CH 01	2412 MHz	13.05
	CH 06	2437 MHz	13.15
	CH 11	2462 MHz	12.51

Note:

1. Per 2010/10 TCB workshop and KDB 248227, choose the highest output power channel to test SAR and determine further SAR exclusion
2. Per KDB 248227, 11g and 11n output power is less than 1/4 dB higher than 11b mode, thus the SAR can be excluded.

12.2 Test Records for Body SAR Test

<WLAN>

Plot No.	Band	Mode	Test Position	Gap (cm)	Ch.	SAR _{1g} (W/kg)
1	802.11b	-	Front	1	1	0.00629
2	802.11b	-	Back	1	1	0.033
3	802.11b	-	Left Side	1	1	0.041
4	802.11b	-	Top Side	1	1	0.00839
5	802.11b	-	Bottom Side	1	1	0.00822

Note:

1. Per KDB447498, if the highest output channel SAR for each exposure position ≤ 0.8 W/kg other channels SAR tests are not necessary.
2. Per KDB 941225 D06, for DUT dimension $\geq 9\text{cm} \times 5\text{cm}$, the test distance is 1cm. SAR must be measured for all surfaces and sides with a transmitting antenna located within 2.5cm from that surface or edge.

Test Engineer : Ted Sun



13. References

- [1] FCC 47 CFR Part 2 “Frequency Allocations and Radio Treaty Matters; General Rules and Regulations”
- [2] IEEE Std. C95.1-1991, “IEEE Standard for Safety Levels with Respect to Human Exposure to Radio Frequency Electromagnetic Fields, 3 kHz to 300 GHz”, 1991
- [3] IEEE Std. 1528-2003, “Recommended Practice for Determining the Peak Spatial-Average Specific Absorption Rate (SAR) in the Human Head from Wireless Communications Devices: Measurement Techniques”, December 2003
- [4] FCC OET Bulletin 65 (Edition 97-01) Supplement C (Edition 01-01), “Evaluating Compliance with FCC Guidelines for Human Exposure to Radiofrequency Electromagnetic Fields”, June 2001
- [5] SPEAG DASY System Handbook
- [6] FCC KDB 248227 D01 v01r02, “SAR Measurement Procedures for 802.11 a/b/g Transmitters”, May 2007
- [7] FCC KDB 447498 D01 v04, “Mobile and Portable Device RF Exposure Procedures and Equipment Authorization Policies”, November 2009
- [8] FCC KDB 616217 D01 v01r01, "SAR Evaluation Considerations for Laptop Computers with Antennas Built-in on Display Screens", November 2009
- [9] FCC KDB 616217 D03 v01, “SAR Evaluation Considerations for Laptop/Notebook/Netbook and Tablet Computers”, November 2009
- [10] FCC KDB 941225 D01 v02, “SAR Measurement Procedures for 3G Devices – CDMA 2000 / Ev-Do / WCDMA / HSDPA / HSPA”, October 2007
- [11] FCC KDB 941225 D03 v01, “Recommended SAR Test Reduction Procedures for GSM / GPRS / EDGE”, December 2008
- [12] FCC KDB 941225 D04 v01, “Evaluating SAR for GSM/(E)GPRS Dual Transfer Mode”, January 27 2010



Appendix A. Plots of System Performance Check

The plots are shown as follows.

System Check_Body_2450MHz_111117

DUT: Dipole 2450 MHz

Communication System: CW; Frequency: 2450 MHz; Duty Cycle: 1:1

Medium: MSL_2450_111117 Medium parameters used: $f = 2450$ MHz; $\sigma = 1.96$ mho/m; $\epsilon_r = 52.9$; $\rho = 1000$

kg/m³

Ambient Temperature : 22.5 ; Liquid Temperature : 21.5

DASY5 Configuration:

- Probe: ET3DV6 - SN1788; ConvF(4.01, 4.01, 4.01); Calibrated: 2011/9/28
- Sensor-Surface: 4mm (Mechanical Surface Detection)
- Electronics: DAE3 Sn577; Calibrated: 2011/6/20
- Phantom: ELI 4.0; Type: QDOVA001BA; Serial: 1029
- ; SEMCAD X Version 13.4 Build 125

Pin=250mW/Area Scan (91x91x1): Measurement grid: dx=10mm, dy=10mm

Maximum value of SAR (interpolated) = 15.6 mW/g

Pin=250mW/Zoom Scan (7x7x7)/Cube 0: Measurement grid: dx=5mm, dy=5mm, dz=5mm

Reference Value = 89.8 V/m; Power Drift = -0.101 dB

Peak SAR (extrapolated) = 33 W/kg

SAR(1 g) = 13.6 mW/g; SAR(10 g) = 6.16 mW/g

Maximum value of SAR (measured) = 15.1 mW/g

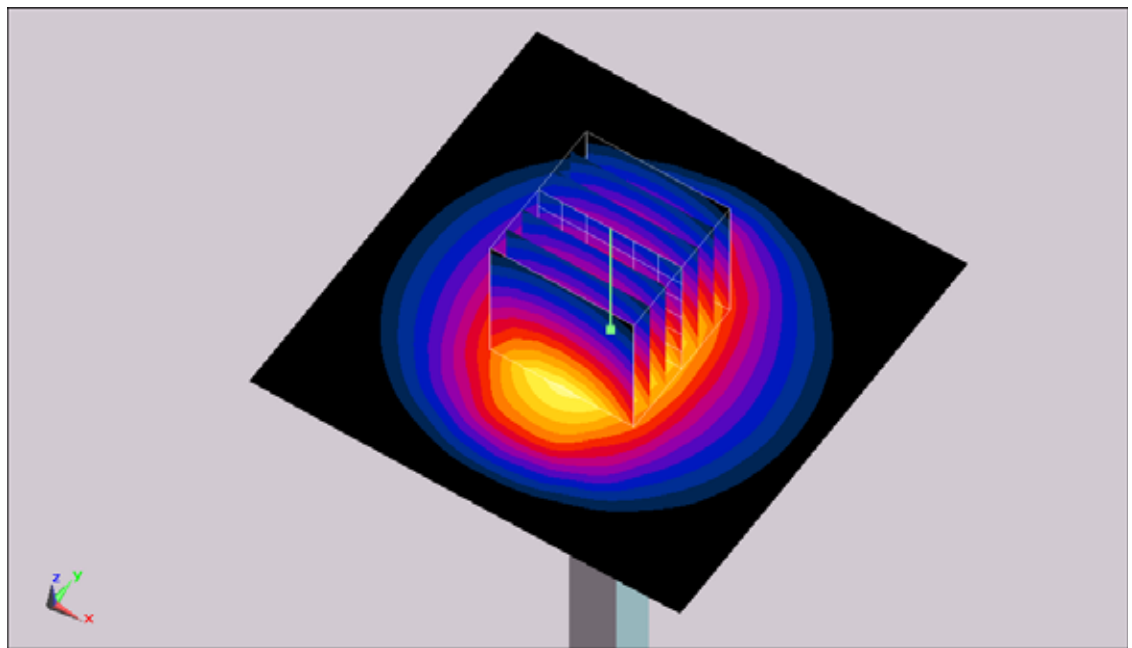
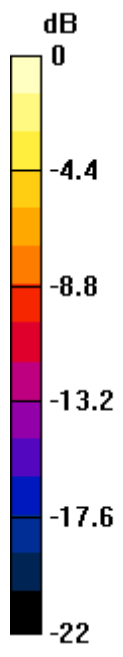

0 dB = 15.1mW/g



Appendix B. Plots of SAR Measurement

The plots are shown as follows.

#01 802.11b_Front_1cm_Ch1

DUT: 1N0237

Communication System: 802.11b ; Frequency: 2412 MHz;Duty Cycle: 1:1

Medium: MSL_2450_111117 Medium parameters used: $f = 2412$ MHz; $\sigma = 1.91$ mho/m; $\epsilon_r = 53$; $\rho = 1000$

kg/m³

Ambient Temperature : 22.5 ; Liquid Temperature : 21.5

DASY5 Configuration:

- Probe: ET3DV6 - SN1788; ConvF(4.01, 4.01, 4.01); Calibrated: 2011/9/28
- Sensor-Surface: 4mm (Mechanical Surface Detection)
- Electronics: DAE3 Sn577; Calibrated: 2011/6/20
- Phantom: ELI 4.0; Type: QDOVA001BA; Serial: 1029
- ; SEMCAD X Version 13.4 Build 125

Ch1/Area Scan (71x91x1): Measurement grid: dx=15mm, dy=15mm

Maximum value of SAR (interpolated) = 0.017 mW/g

Ch1/Zoom Scan (5x5x7)/Cube 0: Measurement grid: dx=8mm, dy=8mm, dz=5mm

Reference Value = 0.332 V/m; Power Drift = 0.127 dB

Peak SAR (extrapolated) = 0.014 W/kg

SAR(1 g) = 0.00629 mW/g; SAR(10 g) = 0.0033 mW/g

Maximum value of SAR (measured) = 0.00772 mW/g

Ch1/Zoom Scan (5x5x7)/Cube 1: Measurement grid: dx=8mm, dy=8mm, dz=5mm

Reference Value = 0.332 V/m; Power Drift = 0.127 dB

Peak SAR (extrapolated) = 0.031 W/kg

SAR(1 g) = 0.0062 mW/g; SAR(10 g) = 0.00283 mW/g

Maximum value of SAR (measured) = 0.00713 mW/g

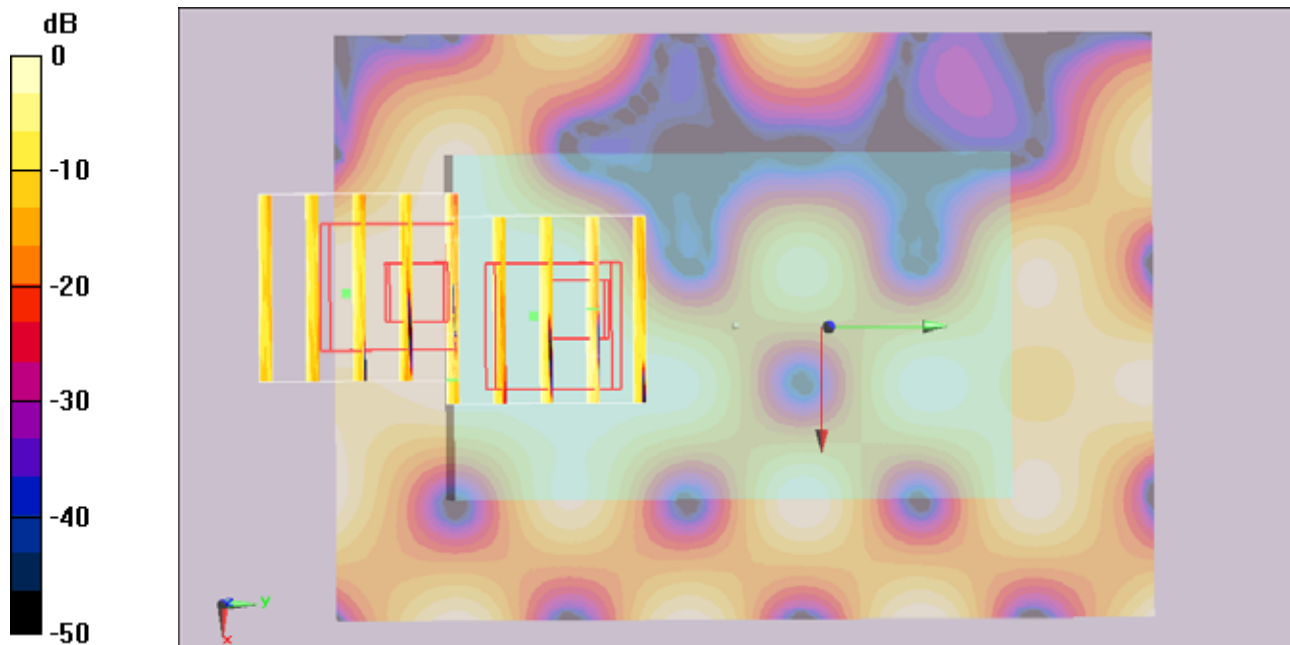

0 dB = 0.00713mW/g

#02 802.11b_Back_1cm_Ch1

DUT: 1N0237

Communication System: 802.11b ; Frequency: 2412 MHz;Duty Cycle: 1:1

Medium: MSL_2450_111117 Medium parameters used: $f = 2412$ MHz; $\sigma = 1.91$ mho/m; $\epsilon_r = 53$; $\rho = 1000$

kg/m³

Ambient Temperature : 22.5 ; Liquid Temperature : 21.5

DASY5 Configuration:

- Probe: ET3DV6 - SN1788; ConvF(4.01, 4.01, 4.01); Calibrated: 2011/9/28
- Sensor-Surface: 4mm (Mechanical Surface Detection)
- Electronics: DAE3 Sn577; Calibrated: 2011/6/20
- Phantom: ELI 4.0; Type: QDOVA001BA; Serial: 1029
- ; SEMCAD X Version 13.4 Build 125

Ch1/Area Scan (71x91x1): Measurement grid: dx=15mm, dy=15mm

Maximum value of SAR (interpolated) = 0.036 mW/g

Ch1/Zoom Scan (5x5x7)/Cube 0: Measurement grid: dx=8mm, dy=8mm, dz=5mm

Reference Value = 1.57 V/m; Power Drift = 0.168 dB

Peak SAR (extrapolated) = 0.086 W/kg

SAR(1 g) = 0.033 mW/g; SAR(10 g) = 0.016 mW/g

Maximum value of SAR (measured) = 0.034 mW/g

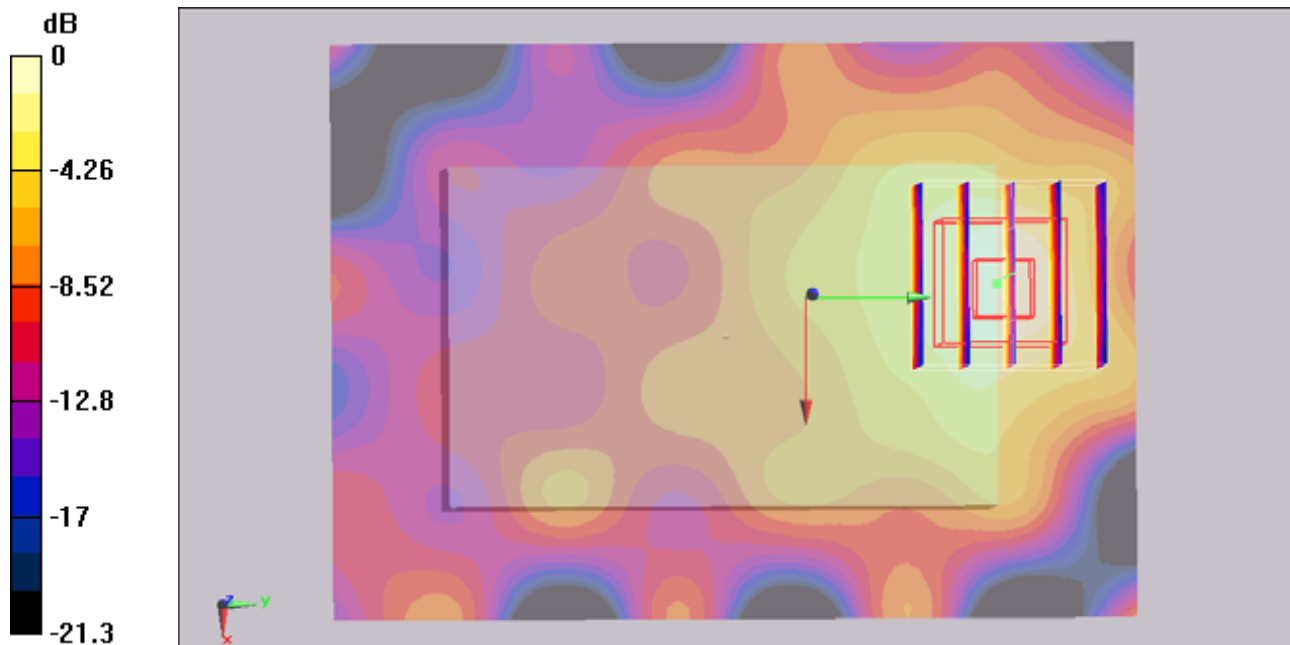

0 dB = 0.034mW/g

#03 802.11b_Left Side_1cm_Ch1

DUT: 1N0237

Communication System: 802.11b ; Frequency: 2412 MHz;Duty Cycle: 1:1

Medium: MSL_2450_111117 Medium parameters used: $f = 2412$ MHz; $\sigma = 1.91$ mho/m; $\epsilon_r = 53$; $\rho = 1000$

kg/m³

Ambient Temperature : 22.5 ; Liquid Temperature : 21.5

DASY5 Configuration:

- Probe: ET3DV6 - SN1788; ConvF(4.01, 4.01, 4.01); Calibrated: 2011/9/28
- Sensor-Surface: 4mm (Mechanical Surface Detection)
- Electronics: DAE3 Sn577; Calibrated: 2011/6/20
- Phantom: ELI 4.0; Type: QDOVA001BA; Serial: 1029
- ; SEMCAD X Version 13.4 Build 125

Ch1/Area Scan (51x81x1): Measurement grid: dx=15mm, dy=15mm

Maximum value of SAR (interpolated) = 0.045 mW/g

Ch1/Zoom Scan (5x5x7)/Cube 0: Measurement grid: dx=8mm, dy=8mm, dz=5mm

Reference Value = 4.26 V/m; Power Drift = 0.195 dB

Peak SAR (extrapolated) = 0.109 W/kg

SAR(1 g) = 0.041 mW/g; SAR(10 g) = 0.019 mW/g

Maximum value of SAR (measured) = 0.043 mW/g

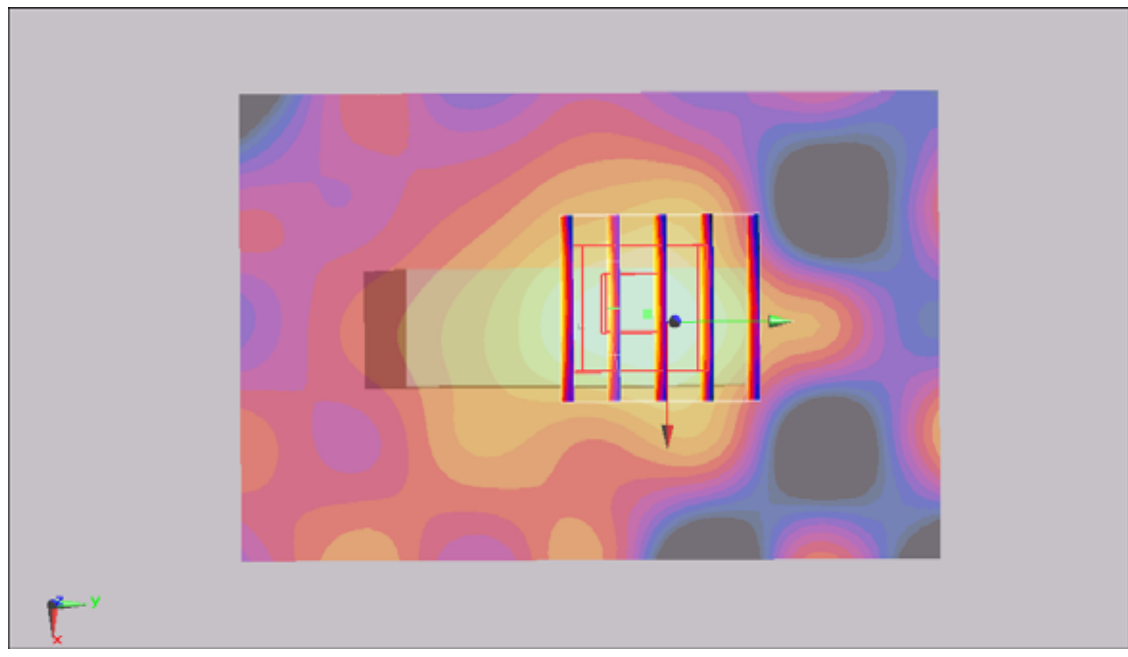
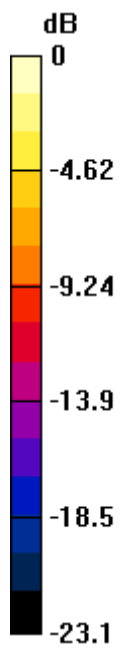

0 dB = 0.043mW/g

#03 802.11b_Left Side_1cm_Ch1_2D

DUT: 1N0237

Communication System: 802.11b ; Frequency: 2412 MHz;Duty Cycle: 1:1

Medium: MSL_2450_111117 Medium parameters used: $f = 2412$ MHz; $\sigma = 1.91$ mho/m; $\epsilon_r = 53$; $\rho = 1000$ kg/m³

Ambient Temperature : 22.5 ; Liquid Temperature : 21.5

DASY5 Configuration:

- Probe: ET3DV6 - SN1788; ConvF(4.01, 4.01, 4.01); Calibrated: 2011/9/28
- Sensor-Surface: 4mm (Mechanical Surface Detection)
- Electronics: DAE3 Sn577; Calibrated: 2011/6/20
- Phantom: ELI 4.0; Type: QDOVA001BA; Serial: 1029
- ; SEMCAD X Version 13.4 Build 125

Ch1/Area Scan (51x81x1): Measurement grid: dx=15mm, dy=15mm

Maximum value of SAR (interpolated) = 0.045 mW/g

Ch1/Zoom Scan (5x5x7)/Cube 0: Measurement grid: dx=8mm, dy=8mm, dz=5mm

Reference Value = 4.26 V/m; Power Drift = 0.195 dB

Peak SAR (extrapolated) = 0.109 W/kg

SAR(1 g) = 0.041 mW/g; SAR(10 g) = 0.019 mW/g

Maximum value of SAR (measured) = 0.043 mW/g

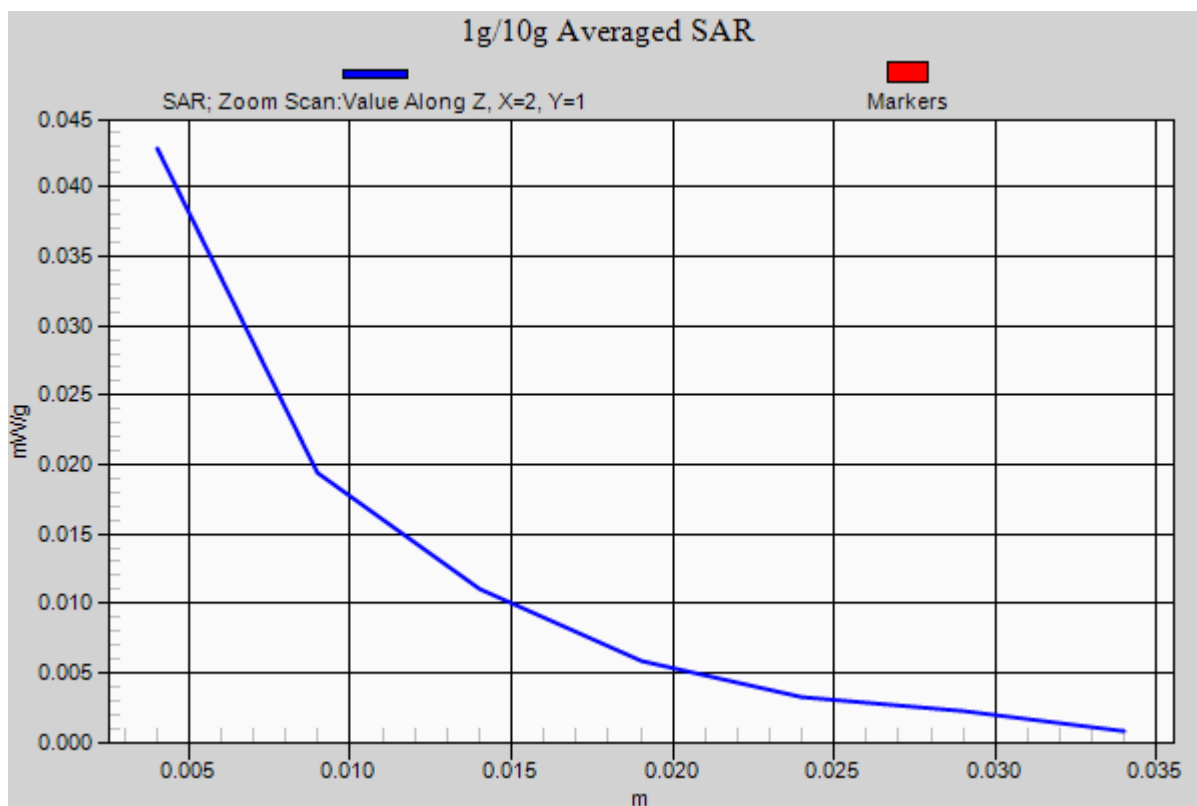

#04 802.11b_Top Side_1cm_Ch1

DUT: 1N0237

Communication System: 802.11b ; Frequency: 2412 MHz;Duty Cycle: 1:1

Medium: MSL_2450_111117 Medium parameters used: $f = 2412$ MHz; $\sigma = 1.91$ mho/m; $\epsilon_r = 53$; $\rho = 1000$

kg/m³

Ambient Temperature : 22.5 ; Liquid Temperature : 21.5

DASY5 Configuration:

- Probe: ET3DV6 - SN1788; ConvF(4.01, 4.01, 4.01); Calibrated: 2011/9/28
- Sensor-Surface: 4mm (Mechanical Surface Detection)
- Electronics: DAE3 Sn577; Calibrated: 2011/6/20
- Phantom: ELI 4.0; Type: QDOVA001BA; Serial: 1029
- ; SEMCAD X Version 13.4 Build 125

Ch1/Area Scan (51x81x1): Measurement grid: dx=15mm, dy=15mm

Maximum value of SAR (interpolated) = 0.023 mW/g

Ch1/Zoom Scan (5x5x7)/Cube 0: Measurement grid: dx=8mm, dy=8mm, dz=5mm

Reference Value = 1.66 V/m; Power Drift = -0.193 dB

Peak SAR (extrapolated) = 0.017 W/kg

SAR(1 g) = 0.00839 mW/g; SAR(10 g) = 0.00436 mW/g

Maximum value of SAR (measured) = 0.00977 mW/g

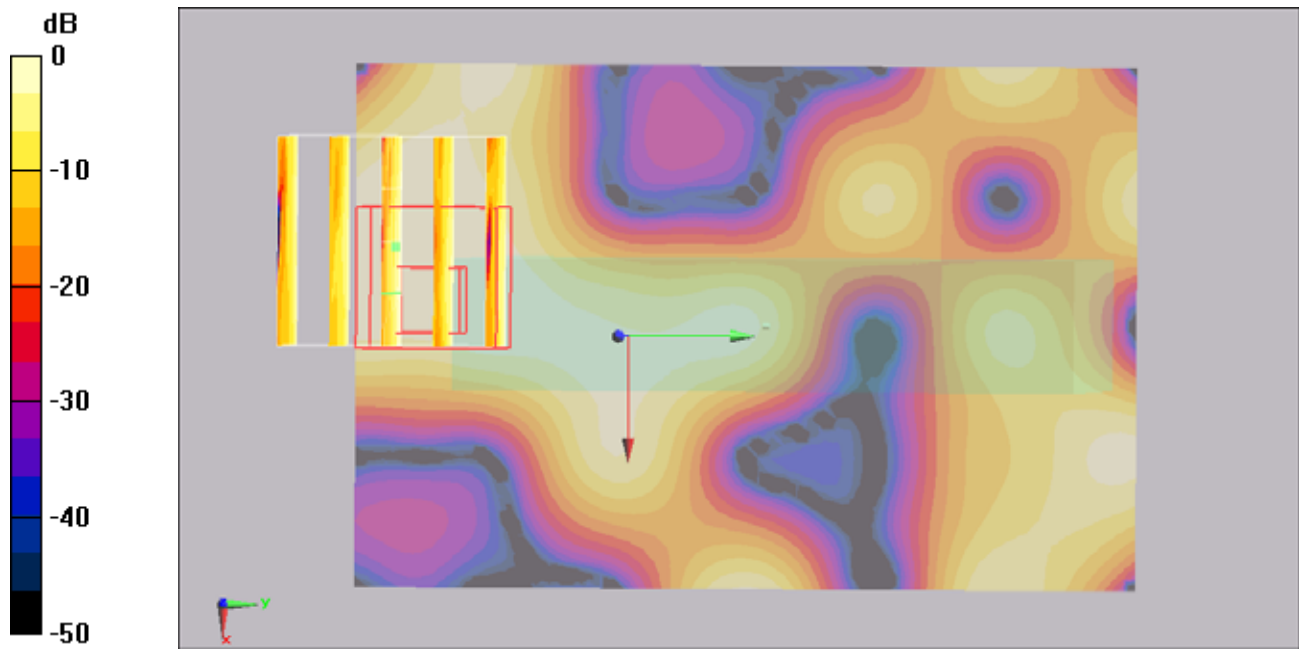

0 dB = 0.00977mW/g

#05 802.11b_Bottom Side_1cm_Ch1

DUT: 1N0237

Communication System: 802.11b ; Frequency: 2412 MHz;Duty Cycle: 1:1

Medium: MSL_2450_111117 Medium parameters used: $f = 2412$ MHz; $\sigma = 1.91$ mho/m; $\epsilon_r = 53$; $\rho = 1000$

kg/m³

Ambient Temperature : 22.5 ; Liquid Temperature : 21.5

DASY5 Configuration:

- Probe: ET3DV6 - SN1788; ConvF(4.01, 4.01, 4.01); Calibrated: 2011/9/28
- Sensor-Surface: 4mm (Mechanical Surface Detection)
- Electronics: DAE3 Sn577; Calibrated: 2011/6/20
- Phantom: ELI 4.0; Type: QDOVA001BA; Serial: 1029
- ; SEMCAD X Version 13.4 Build 125

Ch1/Area Scan (51x81x1): Measurement grid: dx=15mm, dy=15mm

Maximum value of SAR (interpolated) = 0.00933 mW/g

Ch1/Zoom Scan (5x5x7)/Cube 1: Measurement grid: dx=8mm, dy=8mm, dz=5mm

Reference Value = 1.24 V/m; Power Drift = 0.154 dB

Peak SAR (extrapolated) = 0.031 W/kg

SAR(1 g) = 0.00822 mW/g; SAR(10 g) = 0.0034 mW/g

Maximum value of SAR (measured) = 0.00976 mW/g

Ch1/Zoom Scan (5x5x7)/Cube 0: Measurement grid: dx=8mm, dy=8mm, dz=5mm

Reference Value = 1.24 V/m; Power Drift = 0.154 dB

Peak SAR (extrapolated) = 0.030 W/kg

SAR(1 g) = 0.00641 mW/g; SAR(10 g) = 0.00236 mW/g

Maximum value of SAR (measured) = 0.0076 mW/g

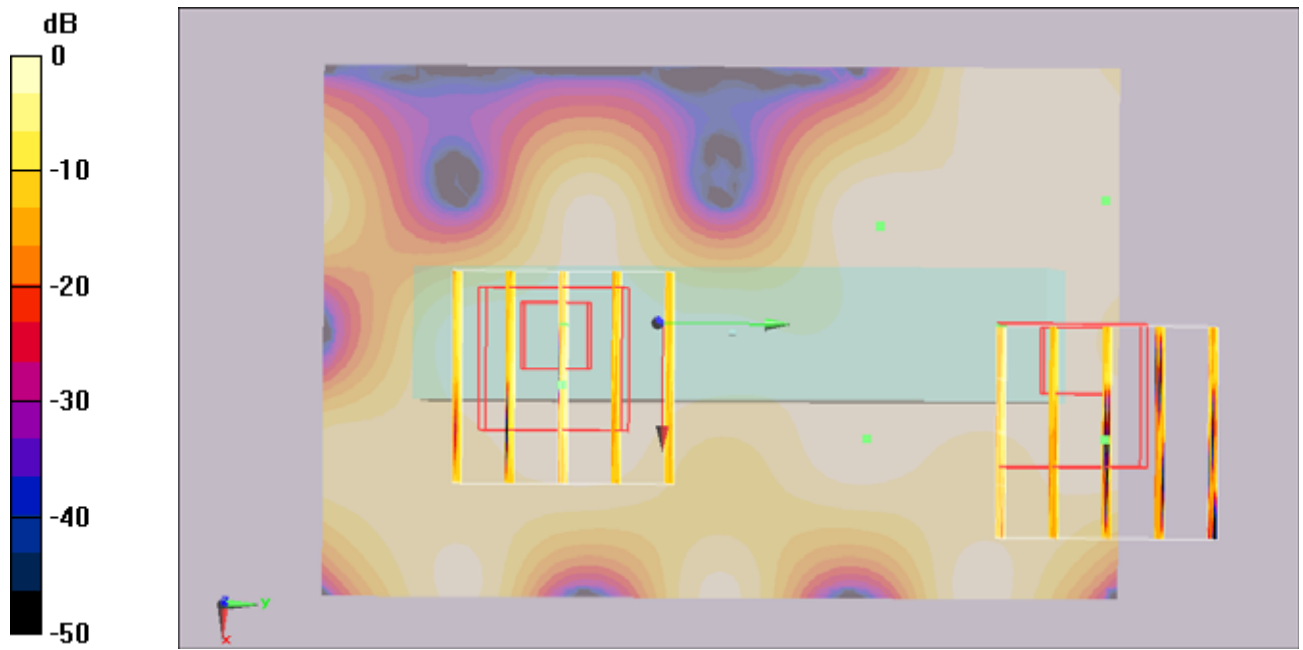

0 dB = 0.0076mW/g



Appendix C. DASYS Calibration Certificate

The DASYS calibration certificates are shown as follows.



Accredited by the Swiss Accreditation Service (SAS)
The Swiss Accreditation Service is one of the signatories to the EA
Multilateral Agreement for the recognition of calibration certificates

Accreditation No.: **SCS 108**

Client: **Sporton (Auden)**

Certificate No.: **D2450V2-736_Jul11**

CALIBRATION CERTIFICATE

Object: **D2450V2 - SN: 736**

Calibration procedure(s): **QA CAL-05.v8
Calibration procedure for dipole validation kits above 700 MHz**

Calibration date: **July 25, 2011**

This calibration certificate documents the traceability to national standards, which realize the physical units of measurements (SI).
The measurements and the uncertainties with confidence probability are given on the following pages and are part of the certificate.

All calibrations have been conducted in the closed laboratory facility: environment temperature (22 ± 3)°C and humidity < 70%.

Calibration Equipment used (M&TE critical for calibration)

Primary Standards	ID #	Cal Date (Certificate No.)	Scheduled Calibration
Power meter EPM-442A	GB37480704	06-Oct-10 (No. 217-01266)	Oct-11
Power sensor HP 8481A	US37292783	06-Oct-10 (No. 217-01266)	Oct-11
Reference 20 dB Attenuator	SN: S5086 (20b)	29-Mar-11 (No. 217-01367)	Apr-12
Type-N mismatch combination	SN: 5047.2 / 06327	29-Mar-11 (No. 217-01371)	Apr-12
Reference Probe ES3DV3	SN: 3205	29-Apr-11 (No. ES3-3205_Apr11)	Apr-12
DAE4	SN: 601	04-Jul-11 (No. DAE4-601_Jul11)	Jul-12
Secondary Standards	ID #	Check Date (in house)	Scheduled Check
Power sensor HP 8481A	MY41092317	18-Oct-02 (in house check Oct-09)	In house check: Oct-11
RF generator R&S SMT-06	100005	04-Aug-99 (in house check Oct-09)	In house check: Oct-11
Network Analyzer HP 8753E	US37390585 S4206	18-Oct-01 (in house check Oct-10)	In house check: Oct-11

Calibrated by: **Claudio Leubler** (Name), **Laboratory Technician** (Function),  (Signature)

Approved by: **Katja Pokovic** (Name), **Technical Manager** (Function),  (Signature)

Issued: July 25, 2011

This calibration certificate shall not be reproduced except in full without written approval of the laboratory.



Accredited by the Swiss Accreditation Service (SAS)

Accreditation No.: **SCS 108**

The Swiss Accreditation Service is one of the signatories to the EA Multilateral Agreement for the recognition of calibration certificates

Glossary:

TSL	tissue simulating liquid
ConvF	sensitivity in TSL / NORM x,y,z
N/A	not applicable or not measured

Calibration is Performed According to the Following Standards:

- IEEE Std 1528-2003, "IEEE Recommended Practice for Determining the Peak Spatial-Averaged Specific Absorption Rate (SAR) in the Human Head from Wireless Communications Devices: Measurement Techniques", December 2003
- IEC 62209-1, "Procedure to measure the Specific Absorption Rate (SAR) for hand-held devices used in close proximity to the ear (frequency range of 300 MHz to 3 GHz)", February 2005
- Federal Communications Commission Office of Engineering & Technology (FCC OET), "Evaluating Compliance with FCC Guidelines for Human Exposure to Radiofrequency Electromagnetic Fields; Additional Information for Evaluating Compliance of Mobile and Portable Devices with FCC Limits for Human Exposure to Radiofrequency Emissions", Supplement C (Edition 01-01) to Bulletin 65

Additional Documentation:

- DASY4/5 System Handbook

Methods Applied and Interpretation of Parameters:

- Measurement Conditions:** Further details are available from the Validation Report at the end of the certificate. All figures stated in the certificate are valid at the frequency indicated.
- Antenna Parameters with TSL:** The dipole is mounted with the spacer to position its feed point exactly below the center marking of the flat phantom section, with the arms oriented parallel to the body axis.
- Feed Point Impedance and Return Loss:** These parameters are measured with the dipole positioned under the liquid filled phantom. The impedance stated is transformed from the measurement at the SMA connector to the feed point. The Return Loss ensures low reflected power. No uncertainty required.
- Electrical Delay:** One-way delay between the SMA connector and the antenna feed point. No uncertainty required.
- SAR measured:** SAR measured at the stated antenna input power.
- SAR normalized:** SAR as measured, normalized to an input power of 1 W at the antenna connector.
- SAR for nominal TSL parameters:** The measured TSL parameters are used to calculate the nominal SAR result.

Measurement Conditions

DASY system configuration, as far as not given on page 1.

DASY Version	DASY5	V52.6.2
Extrapolation	Advanced Extrapolation	
Phantom	Modular Flat Phantom	
Distance Dipole Center - TSL	10 mm	with Spacer
Zoom Scan Resolution	dx, dy, dz = 5 mm	
Frequency	2450 MHz \pm 1 MHz	

Head TSL parameters

The following parameters and calculations were applied.

	Temperature	Permittivity	Conductivity
Nominal Head TSL parameters	22.0 °C	39.2	1.80 mho/m
Measured Head TSL parameters	(22.0 \pm 0.2) °C	38.9 \pm 6 %	1.85 mho/m \pm 6 %
Head TSL temperature change during test	< 0.5 °C	----	----

SAR result with Head TSL

SAR averaged over 1 cm³ (1 g) of Head TSL	Condition	
SAR measured	250 mW input power	13.9 mW / g
SAR for nominal Head TSL parameters	normalized to 1W	54.8 mW / g \pm 17.0 % (k=2)

SAR averaged over 10 cm³ (10 g) of Head TSL	condition	
SAR measured	250 mW input power	6.44 mW / g
SAR for nominal Head TSL parameters	normalized to 1W	25.6 mW / g \pm 16.5 % (k=2)

Body TSL parameters

The following parameters and calculations were applied.

	Temperature	Permittivity	Conductivity
Nominal Body TSL parameters	22.0 °C	52.7	1.95 mho/m
Measured Body TSL parameters	(22.0 \pm 0.2) °C	51.7 \pm 6 %	2.00 mho/m \pm 6 %
Body TSL temperature change during test	< 0.5 °C	----	----

SAR result with Body TSL

SAR averaged over 1 cm³ (1 g) of Body TSL	Condition	
SAR measured	250 mW input power	13.3 mW / g
SAR for nominal Body TSL parameters	normalized to 1W	52.3 mW / g \pm 17.0 % (k=2)

SAR averaged over 10 cm³ (10 g) of Body TSL	condition	
SAR measured	250 mW input power	6.18 mW / g
SAR for nominal Body TSL parameters	normalized to 1W	24.5 mW / g \pm 16.5 % (k=2)

Appendix

Antenna Parameters with Head TSL

Impedance, transformed to feed point	54.4 Ω + 1.5 j Ω
Return Loss	- 27.0 dB

Antenna Parameters with Body TSL

Impedance, transformed to feed point	50.8 Ω + 2.8 j Ω
Return Loss	- 30.7 dB

General Antenna Parameters and Design

Electrical Delay (one direction)	1.159 ns
----------------------------------	----------

After long term use with 100W radiated power, only a slight warming of the dipole near the feedpoint can be measured.

The dipole is made of standard semirigid coaxial cable. The center conductor of the feeding line is directly connected to the second arm of the dipole. The antenna is therefore short-circuited for DC-signals.

No excessive force must be applied to the dipole arms, because they might bend or the soldered connections near the feedpoint may be damaged.

Additional EUT Data

Manufactured by	SPEAG
Manufactured on	August 26, 2003

DASY5 Validation Report for Head TSL

Date: 25.07.2011

Test Laboratory: SPEAG, Zurich, Switzerland

DUT: Dipole 2450 MHz; Type: D2450V2; Serial: D2450V2 - SN: 736

Communication System: CW; Frequency: 2450 MHz

Medium parameters used: $f = 2450$ MHz; $\sigma = 1.85$ mho/m; $\epsilon_r = 38.9$; $\rho = 1000$ kg/m³

Phantom section: Flat Section

Measurement Standard: DASY5 (IEEE/IEC/ANSI C63.19-2007)

DASY52 Configuration:

- Probe: ES3DV3 - SN3205; ConvF(4.45, 4.45, 4.45); Calibrated: 29.04.2011
- Sensor-Surface: 3mm (Mechanical Surface Detection)
- Electronics: DAE4 Sn601; Calibrated: 04.07.2011
- Phantom: Flat Phantom 5.0 (front); Type: QD000P50AA; Serial: 1001
- DASY52 52.6.2(482); SEMCAD X 14.4.5(3634)

Dipole Calibration for Head Tissue/Pin=250 mW, d=10mm/Zoom Scan (7x7x7)/Cube 0:

Measurement grid: dx=5mm, dy=5mm, dz=5mm

Reference Value = 98.095 V/m; Power Drift = 0.09 dB

Peak SAR (extrapolated) = 28.615 W/kg

SAR(1 g) = 13.9 mW/g; SAR(10 g) = 6.44 mW/g

Maximum value of SAR (measured) = 18.121 mW/g

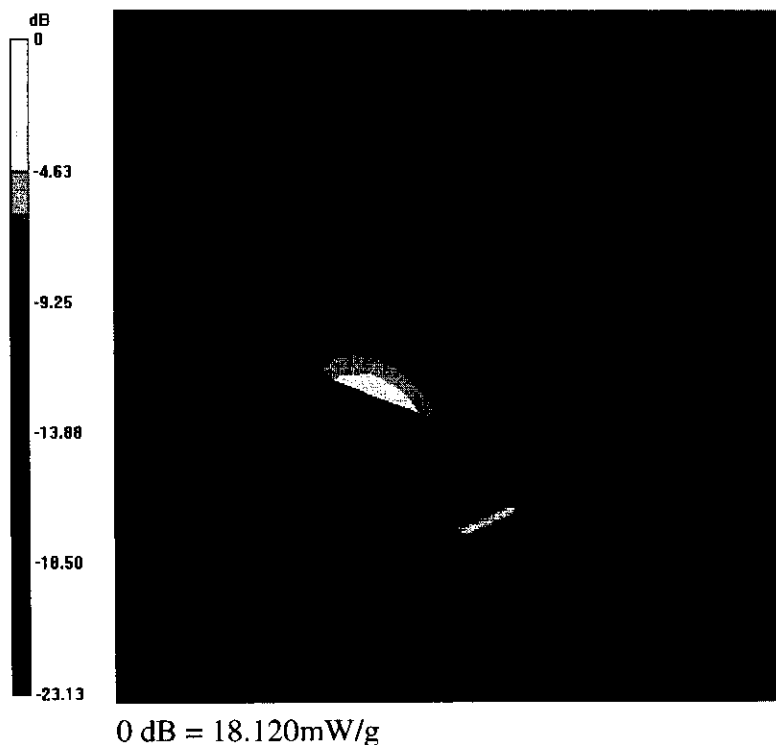

Impedance Measurement Plot for Head TSL

25 Jul 2011 11:54:16

CH1 S11 1 U FS 1: 54.398 Ω 1.4805 Ω 96.173 μH 2 450.000 000 MHz

*
De1

Cor

Avg
16

H1d

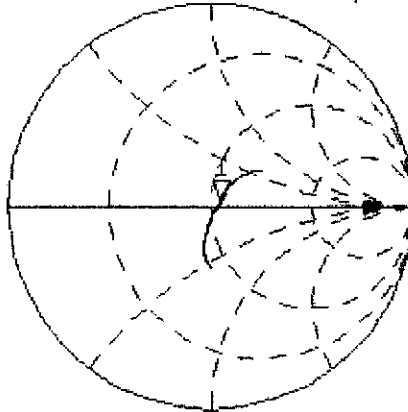

CH2 S11 LOG 5 dB/REF -20 dB 1: -27.042 dB 2 450.000 000 MHz

Cor

Avg
16

H1d

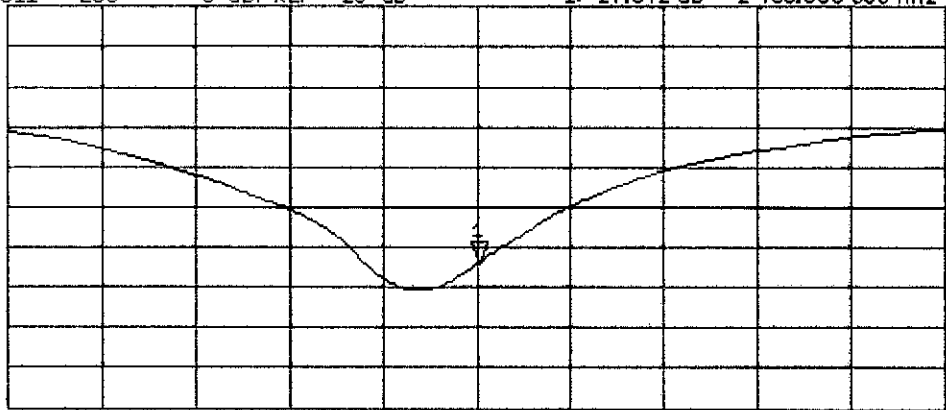

CENTER 2 450.000 000 MHz

SPAN 400.000 000 MHz

DASY5 Validation Report for Body TSL

Date: 25.07.2011

Test Laboratory: SPEAG, Zurich, Switzerland

DUT: Dipole 2450 MHz; Type: D2450V2; Serial: D2450V2 - SN: 736

Communication System: CW; Frequency: 2450 MHz

Medium parameters used: $f = 2450$ MHz; $\sigma = 2$ mho/m; $\epsilon_r = 51.7$; $\rho = 1000$ kg/m³

Phantom section: Flat Section

Measurement Standard: DASY5 (IEEE/IEC/ANSI C63.19-2007)

DASY52 Configuration:

- Probe: ES3DV3 - SN3205; ConvF(4.26, 4.26, 4.26); Calibrated: 29.04.2011
- Sensor-Surface: 3mm (Mechanical Surface Detection)
- Electronics: DAE4 Sn601; Calibrated: 04.07.2011
- Phantom: Flat Phantom 5.0 (back); Type: QD000P50AA; Serial: 1002
- DASY52 52.6.2(482); SEMCAD X 14.4.5(3634)

Dipole Calibration for Body Tissue/Pin=250 mW, d=10mm/Zoom Scan (7x7x7)/Cube 0:

Measurement grid: dx=5mm, dy=5mm, dz=5mm

Reference Value = 96.550 V/m; Power Drift = 0.02 dB

Peak SAR (extrapolated) = 27.432 W/kg

SAR(1 g) = 13.3 mW/g; SAR(10 g) = 6.18 mW/g

Maximum value of SAR (measured) = 17.294 mW/g

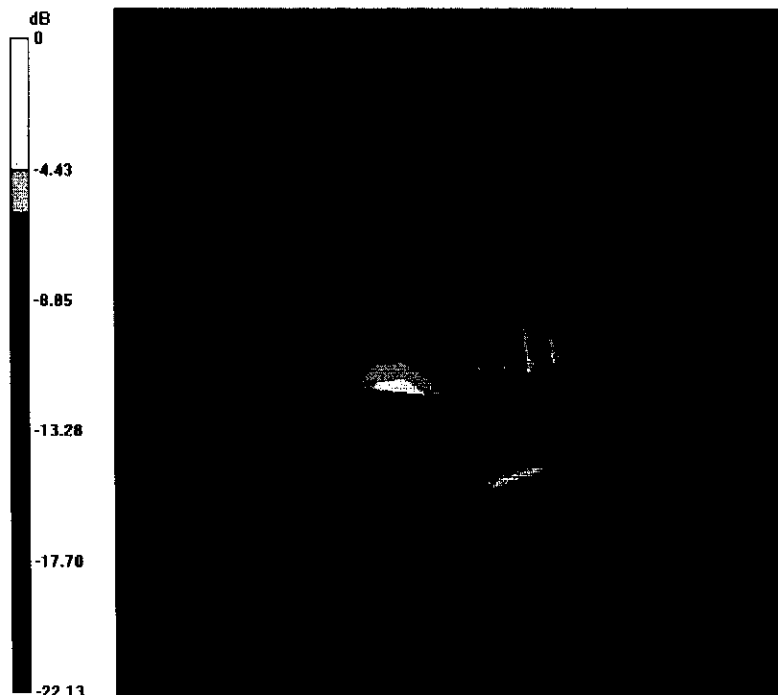

0 dB = 17.290mW/g

Impedance Measurement Plot for Body TSL

25 Jul 2011 11:55:00

CH1 S11 1 U FS 1: 50.812 Ω 2: 8262 Ω 183.59 μH 2 450.000 000 MHz

*
De1

Cor

Avg
16

H1 d

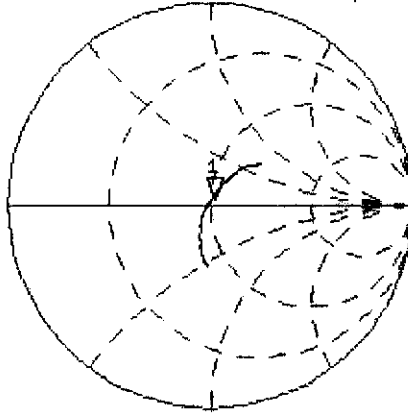

CH2 S11 LOG 5 dB/REF -20 dB 1: -30.696 dB 2 450.000 000 MHz

Cor

Avg
16

H1 d

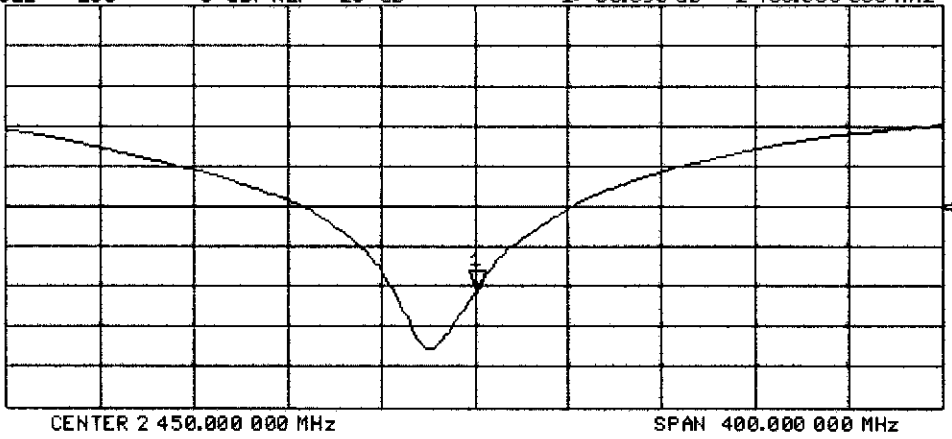

IMPORTANT NOTICE

USAGE OF THE DAE 3

The DAE unit is a delicate, high precision instrument and requires careful treatment by the user. There are no serviceable parts inside the DAE. Special attention shall be given to the following points:

Battery Exchange: The battery cover of the DAE3 unit is connected to a fragile 3-pin battery connector. Customer is responsible to apply utmost caution not to bend or damage the connector when changing batteries.

Shipping of the DAE: Before shipping the DAE to SPEAG for calibration the customer shall remove the batteries and pack the DAE in an antistatic bag. This antistatic bag shall then be packed into a larger box or container which protects the DAE from impacts transportation. The package shall be marked to indicate that a fragile instrument is inside.

E-Stop Failures: Touch detection may be malfunctioning due to broken magnets in the E-stop. Rough handling of the E-stop may lead to damage of these magnets. Touch and collision errors are often caused by dust and dirt accumulated in the E-stop. To prevent E-stop failure, Customer shall always mount the probe to the DAE carefully and keep the DAE unit in a non-dusty environment if not used for measurements.

Repair: Minor repairs are performed at no extra cost during the annual calibration. However, SPEAG reserves the right to charge for any repair especially if rough unprofessional handling caused the defect.

DASY Configuration Files: Since the exact values of the DAE input resistances, as measured during the calibration procedure of a DAE unit, are not used by the DASY software, a nominal value of 200 MOhm is given in the corresponding configuration file.

Important Note:

Warranty and calibration is void if the DAE unit is disassembled partly or fully by the Customer.

Important Note:

Never attempt to grease or oil the E-stop assembly. Cleaning and readjusting of the E-stop assembly is allowed by certified SPEAG personnel only and is part of the annual calibration procedure.

Important Note:

To prevent damage of the DAE probe connector pins, use great care when installing the probe to the DAE. Carefully connect the probe with the connector notch oriented in the mating position. Avoid any rotational movement of the probe body versus the DAE while turning the locking nut of the connector. The same care shall be used when disconnecting the probe from the DAE.



Accredited by the Swiss Accreditation Service (SAS)
The Swiss Accreditation Service is one of the signatories to the EA
Multilateral Agreement for the recognition of calibration certificates

Accreditation No.: **SCS 108**

Client **Sporton TW (Auden)**

Certificate No: **DAE3-577_Jun11**

CALIBRATION CERTIFICATE

Object: **DAE3 - SD 000 D03 AA - SN: 577**

Calibration procedure(s): **QA CAL-06.v23
Calibration procedure for the data acquisition electronics (DAE)**

Calibration date: **June 20, 2011**

This calibration certificate documents the traceability to national standards, which realize the physical units of measurements (SI).
The measurements and the uncertainties with confidence probability are given on the following pages and are part of the certificate.

All calibrations have been conducted in the closed laboratory facility: environment temperature (22 ± 3)°C and humidity < 70%.

Calibration Equipment used (M&TE critical for calibration)

Primary Standards	ID #	Cal Date (Certificate No.)	Scheduled Calibration
Keithley Multimeter Type 2001	SN: 0810278	28-Sep-10 (No:10376)	Sep-11
Secondary Standards	ID #	Check Date (in house)	Scheduled Check
Calibrator Box V1.1	SE UMS 006 AB 1004	08-Jun-11 (in house check)	In house check: Jun-12

	Name	Function	Signature
Calibrated by:	Dominique Steffen	Technician	
Approved by:	Fin Bornholt	R&D Director	

Issued: June 20, 2011

This calibration certificate shall not be reproduced except in full without written approval of the laboratory.



Accredited by the Swiss Accreditation Service (SAS)
The Swiss Accreditation Service is one of the signatories to the EA
Multilateral Agreement for the recognition of calibration certificates

Accreditation No.: **SCS 108**

Glossary

DAE data acquisition electronics
Connector angle information used in DASY system to align probe sensor X to the robot coordinate system.

Methods Applied and Interpretation of Parameters

- *DC Voltage Measurement*: Calibration Factor assessed for use in DASY system by comparison with a calibrated instrument traceable to national standards. The figure given corresponds to the full scale range of the voltmeter in the respective range.
- *Connector angle*: The angle of the connector is assessed measuring the angle mechanically by a tool inserted. Uncertainty is not required.
- The following parameters as documented in the Appendix contain technical information as a result from the performance test and require no uncertainty.
 - *DC Voltage Measurement Linearity*: Verification of the Linearity at +10% and -10% of the nominal calibration voltage. Influence of offset voltage is included in this measurement.
 - *Common mode sensitivity*: Influence of a positive or negative common mode voltage on the differential measurement.
 - *Channel separation*: Influence of a voltage on the neighbor channels not subject to an input voltage.
 - *AD Converter Values with inputs shorted*: Values on the internal AD converter corresponding to zero input voltage
 - *Input Offset Measurement*: Output voltage and statistical results over a large number of zero voltage measurements.
 - *Input Offset Current*: Typical value for information; Maximum channel input offset current, not considering the input resistance.
 - *Input resistance*: Typical value for information: DAE input resistance at the connector, during internal auto-zeroing and during measurement.
 - *Low Battery Alarm Voltage*: Typical value for information. Below this voltage, a battery alarm signal is generated.
 - *Power consumption*: Typical value for information. Supply currents in various operating modes.

DC Voltage Measurement

A/D - Converter Resolution nominal

High Range: 1LSB = 6.1 μ V, full range = -100...+300 mV
Low Range: 1LSB = 61nV, full range = -1.....+3mV

DASY measurement parameters: Auto Zero Time: 3 sec; Measuring time: 3 sec

Calibration Factors	X	Y	Z
High Range	404.381 \pm 0.1% (k=2)	403.844 \pm 0.1% (k=2)	404.277 \pm 0.1% (k=2)
Low Range	3.93296 \pm 0.7% (k=2)	3.93560 \pm 0.7% (k=2)	3.95800 \pm 0.7% (k=2)

Connector Angle

Connector Angle to be used in DASY system	101.5 $^{\circ}$ \pm 1 $^{\circ}$
---	-------------------------------------

Appendix

1. DC Voltage Linearity

High Range	Reading (μV)	Difference (μV)	Error (%)
Channel X + Input	199995.4	-2.24	-0.00
Channel X + Input	20003.13	3.03	0.02
Channel X - Input	-19996.01	3.89	-0.02
Channel Y + Input	199996.5	-0.01	-0.00
Channel Y + Input	20000.48	0.58	0.00
Channel Y - Input	-19998.50	2.10	-0.01
Channel Z + Input	199994.4	-1.15	-0.00
Channel Z + Input	20003.30	3.40	0.02
Channel Z - Input	-19996.26	3.24	-0.02

Low Range	Reading (μV)	Difference (μV)	Error (%)
Channel X + Input	2000.4	0.29	0.01
Channel X + Input	200.33	0.43	0.21
Channel X - Input	-199.88	-0.08	0.04
Channel Y + Input	1999.9	-0.31	-0.02
Channel Y + Input	200.45	0.55	0.28
Channel Y - Input	-200.38	-0.58	0.29
Channel Z + Input	1999.6	-0.23	-0.01
Channel Z + Input	199.26	-0.64	-0.32
Channel Z - Input	-200.62	-0.82	0.41

2. Common mode sensitivity

DASY measurement parameters: Auto Zero Time: 3 sec; Measuring time: 3 sec

	Common mode Input Voltage (mV)	High Range Average Reading (μV)	Low Range Average Reading (μV)
Channel X	200	15.32	13.45
	- 200	-13.16	-14.40
Channel Y	200	-5.58	-5.70
	- 200	4.51	4.52
Channel Z	200	-1.42	-1.57
	- 200	0.56	0.17

3. Channel separation

DASY measurement parameters: Auto Zero Time: 3 sec; Measuring time: 3 sec

	Input Voltage (mV)	Channel X (μV)	Channel Y (μV)	Channel Z (μV)
Channel X	200	-	0.73	-0.43
Channel Y	200	3.10	-	4.07
Channel Z	200	0.93	-1.25	-

4. AD-Converter Values with inputs shorted

DASY measurement parameters: Auto Zero Time: 3 sec; Measuring time: 3 sec

	High Range (LSB)	Low Range (LSB)
Channel X	15973	16638
Channel Y	15856	15275
Channel Z	16211	16876

5. Input Offset Measurement

DASY measurement parameters: Auto Zero Time: 3 sec; Measuring time: 3 sec

Input 10M Ω

	Average (μ V)	min. Offset (μ V)	max. Offset (μ V)	Std. Deviation (μ V)
Channel X	-0.94	-2.52	0.28	0.54
Channel Y	-1.05	-1.87	0.16	0.43
Channel Z	-0.85	-1.57	1.34	0.39

6. Input Offset Current

Nominal Input circuitry offset current on all channels: <25fA

7. Input Resistance (Typical values for information)

	Zeroing (kOhm)	Measuring (MOhm)
Channel X	200	200
Channel Y	200	200
Channel Z	200	200

8. Low Battery Alarm Voltage (Typical values for information)

Typical values	Alarm Level (VDC)
Supply (+ Vcc)	+7.9
Supply (- Vcc)	-7.6

9. Power Consumption (Typical values for information)

Typical values	Switched off (mA)	Stand by (mA)	Transmitting (mA)
Supply (+ Vcc)	+0.01	+6	+14
Supply (- Vcc)	-0.01	-8	-9



Accredited by the Swiss Accreditation Service (SAS)
The Swiss Accreditation Service is one of the signatories to the EA
Multilateral Agreement for the recognition of calibration certificates

Accreditation No.: **SCS 108**

Client **Sporton-TW (Auden)**

Certificate No: **ET3-1788_Sep11**

CALIBRATION CERTIFICATE

Object **ET3DV6 - SN:1788**

Calibration procedure(s) **QA CAL-01.v8, QA CAL-23.v4, QA CAL-25.v4
Calibration procedure for dosimetric E-field probes**

Calibration date: **September 28, 2011**

This calibration certificate documents the traceability to national standards, which realize the physical units of measurements (SI).
The measurements and the uncertainties with confidence probability are given on the following pages and are part of the certificate.

All calibrations have been conducted in the closed laboratory facility: environment temperature $(22 \pm 3)^\circ\text{C}$ and humidity $< 70\%$.

Calibration Equipment used (M&TE critical for calibration)

Primary Standards	ID	Cal Date (Certificate No.)	Scheduled Calibration
Power meter E4419B	GB41293874	31-Mar-11 (No. 217-01372)	Apr-12
Power sensor E4412A	MY41498087	31-Mar-11 (No. 217-01372)	Apr-12
Reference 3 dB Attenuator	SN: S5054 (3c)	29-Mar-11 (No. 217-01369)	Apr-12
Reference 20 dB Attenuator	SN: S5086 (20b)	29-Mar-11 (No. 217-01367)	Apr-12
Reference 30 dB Attenuator	SN: S5129 (30b)	29-Mar-11 (No. 217-01370)	Apr-12
Reference Probe ES3DV2	SN: 3013	29-Dec-10 (No. ES3-3013_Dec10)	Dec-11
DAE4	SN: 654	3-May-11 (No. DAE4-654_May11)	May-12
Secondary Standards	ID	Check Date (in house)	Scheduled Check
RF generator HP 8648C	US3642U01700	4-Aug-99 (in house check Oct-09)	In house check: Oct-11
Network Analyzer HP 8753E	US37390585	18-Oct-01 (in house check Oct-10)	In house check: Oct-11

Calibrated by:	Name	Function	Signature
	Jeton Kastrati	Laboratory Technician	
Approved by:	Katja Pokovic	Technical Manager	
This calibration certificate shall not be reproduced except in full without written approval of the laboratory.			Issued: September 29, 2011



Accredited by the Swiss Accreditation Service (SAS)

Accreditation No.: **SCS 108**

The Swiss Accreditation Service is one of the signatories to the EA
Multilateral Agreement for the recognition of calibration certificates

Glossary:

TSL	tissue simulating liquid
NORM _{x,y,z}	sensitivity in free space
ConvF	sensitivity in TSL / NORM _{x,y,z}
DCP	diode compression point
CF	crest factor (1/duty_cycle) of the RF signal
A, B, C	modulation dependent linearization parameters
Polarization φ	φ rotation around probe axis
Polarization ϑ	ϑ rotation around an axis that is in the plane normal to probe axis (at measurement center), i.e., $\vartheta = 0$ is normal to probe axis

Calibration is Performed According to the Following Standards:

- IEEE Std 1528-2003, "IEEE Recommended Practice for Determining the Peak Spatial-Averaged Specific Absorption Rate (SAR) in the Human Head from Wireless Communications Devices: Measurement Techniques", December 2003
- IEC 62209-1, "Procedure to measure the Specific Absorption Rate (SAR) for hand-held devices used in close proximity to the ear (frequency range of 300 MHz to 3 GHz)", February 2005

Methods Applied and Interpretation of Parameters:

- NORM_{x,y,z}**: Assessed for E-field polarization $\vartheta = 0$ ($f \leq 900$ MHz in TEM-cell; $f > 1800$ MHz: R22 waveguide). NORM_{x,y,z} are only intermediate values, i.e., the uncertainties of NORM_{x,y,z} does not affect the E²-field uncertainty inside TSL (see below *ConvF*).
- NORM(f)_{x,y,z} = NORM_{x,y,z} * frequency_response** (see Frequency Response Chart). This linearization is implemented in DASY4 software versions later than 4.2. The uncertainty of the frequency response is included in the stated uncertainty of *ConvF*.
- DCP_{x,y,z}**: DCP are numerical linearization parameters assessed based on the data of power sweep with CW signal (no uncertainty required). DCP does not depend on frequency nor media.
- PAR**: PAR is the Peak to Average Ratio that is not calibrated but determined based on the signal characteristics
- A_{x,y,z}; B_{x,y,z}; C_{x,y,z}; VR_{x,y,z}**: A, B, C are numerical linearization parameters assessed based on the data of power sweep for specific modulation signal. The parameters do not depend on frequency nor media. VR is the maximum calibration range expressed in RMS voltage across the diode.
- ConvF and Boundary Effect Parameters**: Assessed in flat phantom using E-field (or Temperature Transfer Standard for $f \leq 800$ MHz) and inside waveguide using analytical field distributions based on power measurements for $f > 800$ MHz. The same setups are used for assessment of the parameters applied for boundary compensation (alpha, depth) of which typical uncertainty values are given. These parameters are used in DASY4 software to improve probe accuracy close to the boundary. The sensitivity in TSL corresponds to NORM_{x,y,z} * ConvF whereby the uncertainty corresponds to that given for ConvF. A frequency dependent ConvF is used in DASY version 4.4 and higher which allows extending the validity from ± 50 MHz to ± 100 MHz.
- Spherical isotropy (3D deviation from isotropy)**: in a field of low gradients realized using a flat phantom exposed by a patch antenna.
- Sensor Offset**: The sensor offset corresponds to the offset of virtual measurement center from the probe tip (on probe axis). No tolerance required.

Probe ET3DV6

SN:1788

Manufactured: May 28, 2003
Calibrated: September 28, 2011

Calibrated for DASY/EASY Systems
(Note: non-compatible with DASY2 system!)

DASY/EASY - Parameters of Probe: ET3DV6 - SN:1788

Basic Calibration Parameters

	Sensor X	Sensor Y	Sensor Z	Unc (k=2)
Norm ($\mu\text{V}/(\text{V/m})^2$) ^A	1.71	1.62	1.80	$\pm 10.1 \%$
DCP (mV) ^B	97.3	98.4	95.4	

Modulation Calibration Parameters

UID	Communication System Name	PAR		A dB	B dB	C dB	VR mV	Unc ^E (k=2)
10000	CW	0.00	X	0.00	0.00	1.00	98.8	$\pm 3.0 \%$
			Y	0.00	0.00	1.00	102.6	
			Z	0.00	0.00	1.00	102.0	

The reported uncertainty of measurement is stated as the standard uncertainty of measurement multiplied by the coverage factor $k=2$, which for a normal distribution corresponds to a coverage probability of approximately 95%.

^A The uncertainties of NormX,Y,Z do not affect the E^2 -field uncertainty inside TSL (see Pages 5 and 6).

^B Numerical linearization parameter: uncertainty not required.

^E Uncertainty is determined using the max. deviation from linear response applying rectangular distribution and is expressed for the square of the field value.

DASY/EASY - Parameters of Probe: ET3DV6 - SN:1788

Calibration Parameter Determined in Head Tissue Simulating Media

f (MHz) ^C	Relative Permittivity ^F	Conductivity (S/m) ^F	ConvF X	ConvF Y	ConvF Z	Alpha	Depth (mm)	Unct. (k=2)
835	41.5	0.90	6.35	6.35	6.35	0.61	1.97	± 12.0 %
900	41.5	0.97	6.19	6.19	6.19	0.52	2.23	± 12.0 %
1750	40.1	1.37	5.47	5.47	5.47	0.52	2.57	± 12.0 %
1900	40.0	1.40	5.19	5.19	5.19	0.52	2.54	± 12.0 %
2000	40.0	1.40	5.15	5.15	5.15	0.55	2.36	± 12.0 %
2450	39.2	1.80	4.44	4.44	4.44	0.78	1.73	± 12.0 %

^C Frequency validity of ± 100 MHz only applies for DASY v4.4 and higher (see Page 2), else it is restricted to ± 50 MHz. The uncertainty is the RSS of the ConvF uncertainty at calibration frequency and the uncertainty for the indicated frequency band.

^F At frequencies below 3 GHz, the validity of tissue parameters (ϵ and σ) can be relaxed to ± 10% if liquid compensation formula is applied to measured SAR values. At frequencies above 3 GHz, the validity of tissue parameters (ϵ and σ) is restricted to ± 5%. The uncertainty is the RSS of the ConvF uncertainty for indicated target tissue parameters.

DASY/EASY - Parameters of Probe: ET3DV6- SN:1788

Calibration Parameter Determined in Body Tissue Simulating Media

f (MHz) ^C	Relative Permittivity ^F	Conductivity (S/m) ^F	ConvF X	ConvF Y	ConvF Z	Alpha	Depth (mm)	Unct. (k=2)
835	55.2	0.97	6.24	6.24	6.24	0.67	1.87	± 12.0 %
900	55.0	1.05	6.13	6.13	6.13	0.61	2.01	± 12.0 %
1750	53.4	1.49	4.71	4.71	4.71	0.55	2.84	± 12.0 %
1900	53.3	1.52	4.50	4.50	4.50	0.58	2.54	± 12.0 %
2000	53.3	1.52	4.55	4.55	4.55	0.61	2.39	± 12.0 %
2450	52.7	1.95	4.01	4.01	4.01	1.00	1.24	± 12.0 %

^C Frequency validity of ± 100 MHz only applies for DASY v4.4 and higher (see Page 2), else it is restricted to ± 50 MHz. The uncertainty is the RSS of the ConvF uncertainty at calibration frequency and the uncertainty for the indicated frequency band.

^F At frequencies below 3 GHz, the validity of tissue parameters (ϵ and σ) can be relaxed to ± 10% if liquid compensation formula is applied to measured SAR values. At frequencies above 3 GHz, the validity of tissue parameters (ϵ and σ) is restricted to ± 5%. The uncertainty is the RSS of the ConvF uncertainty for indicated target tissue parameters.

Frequency Response of E-Field (TEM-Cell:ifi110 EXX, Waveguide: R22)

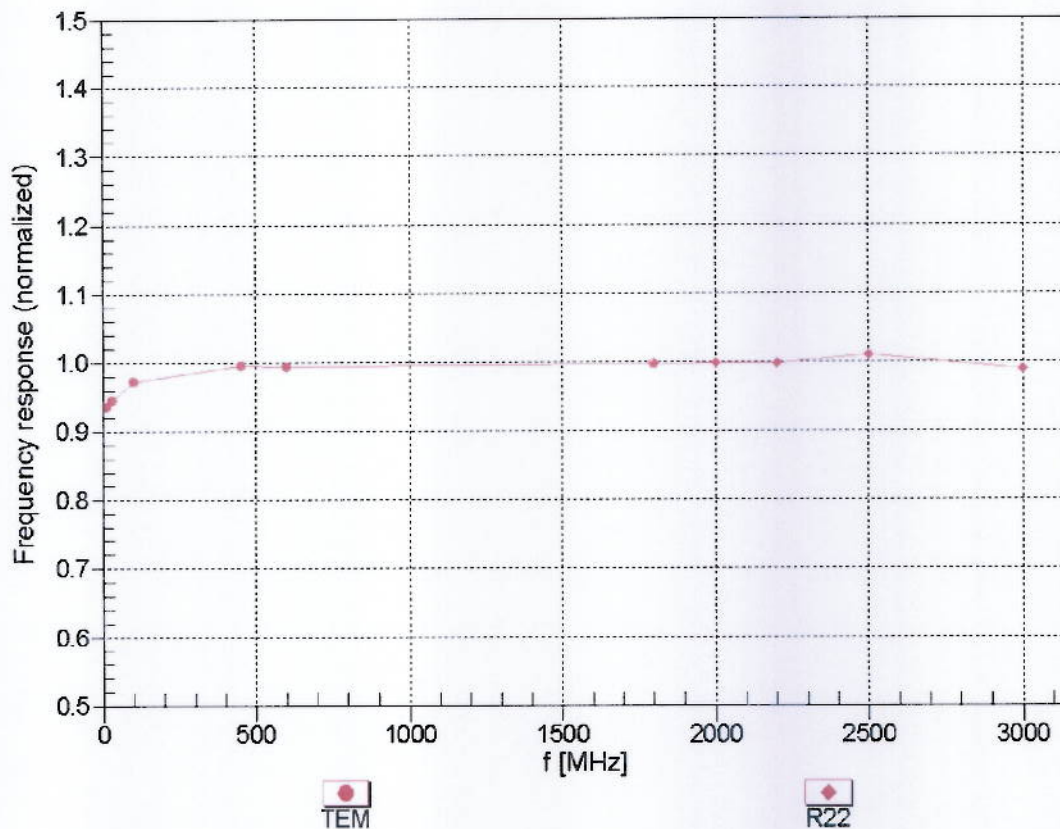

Uncertainty of Frequency Response of E-field: $\pm 6.3\%$ (k=2)

Receiving Pattern (ϕ), $\vartheta = 0^\circ$

f=600 MHz, TEM

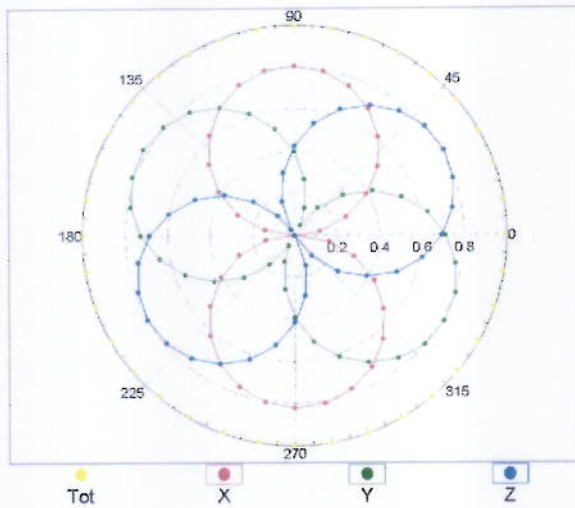

f=1800 MHz, R22

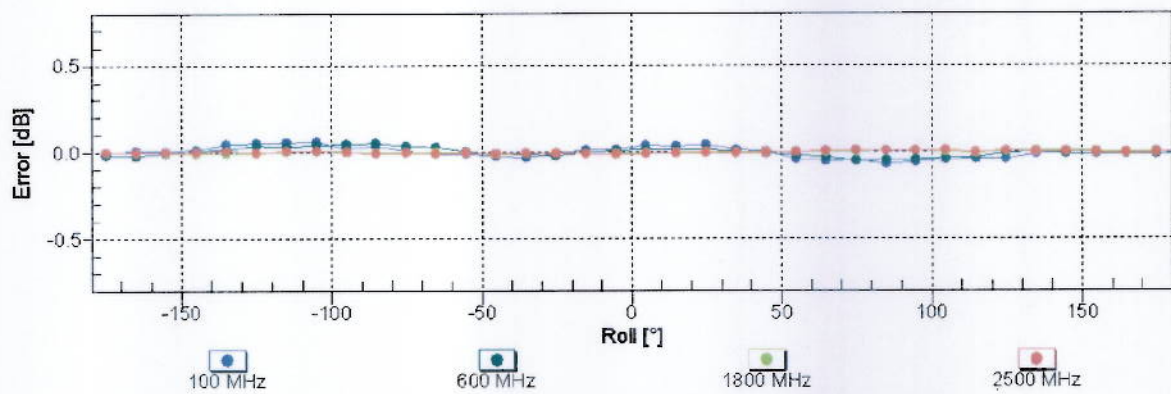
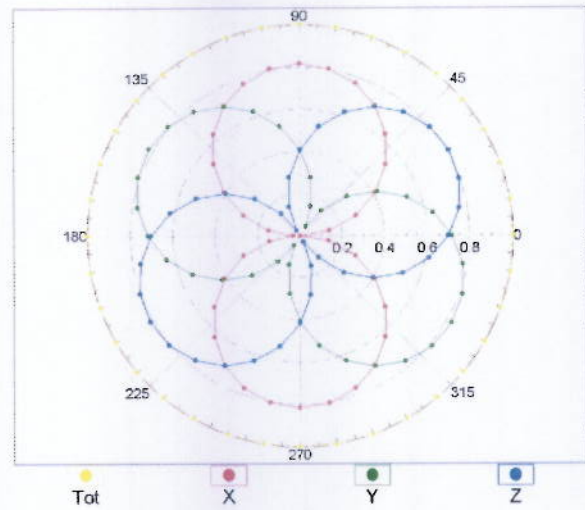

Uncertainty of Axial Isotropy Assessment: $\pm 0.5\%$ (k=2)

Dynamic Range f(SAR_{head}) (TEM cell , f = 900 MHz)

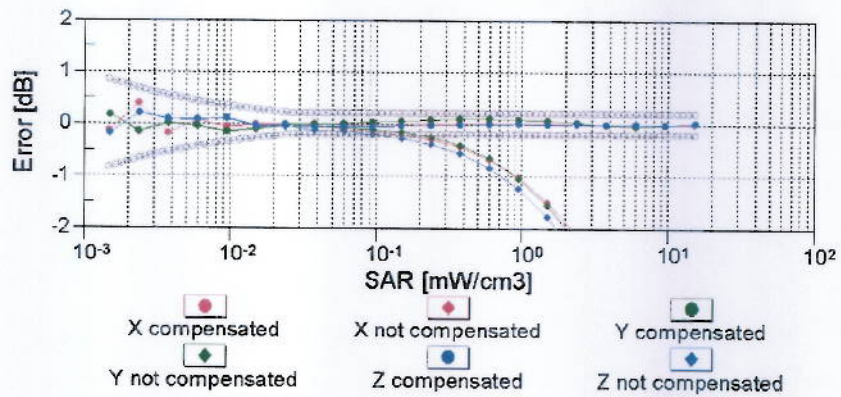
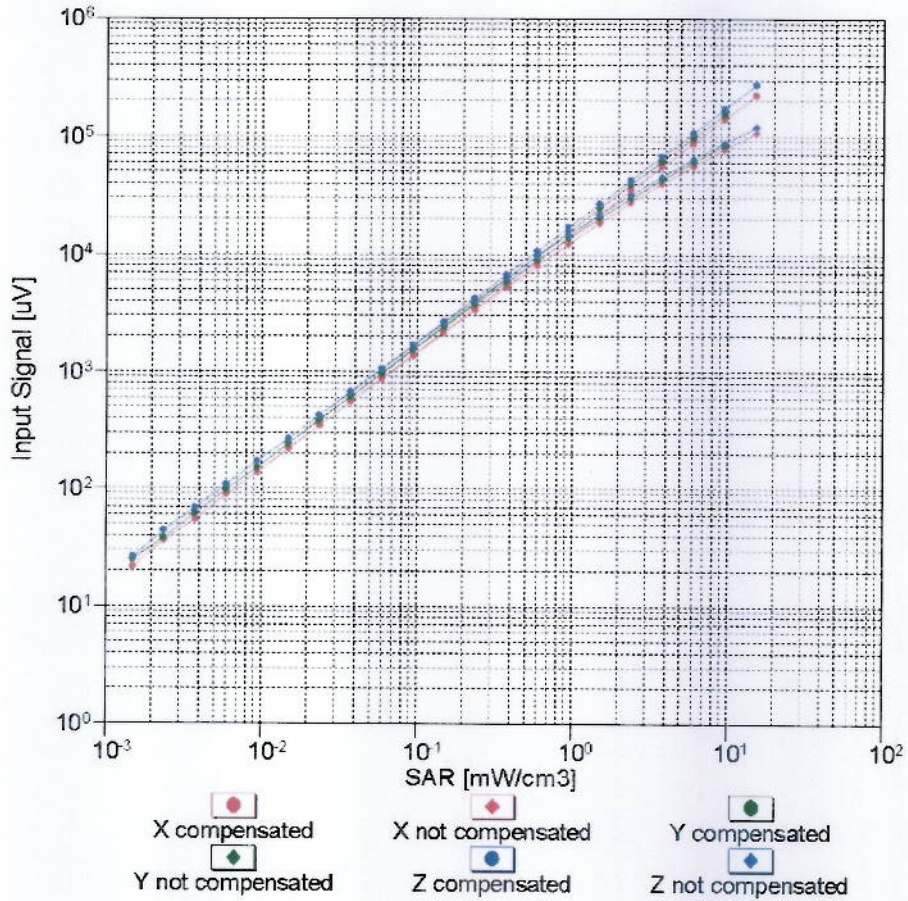

Uncertainty of Linearity Assessment: ± 0.6% (k=2)

Conversion Factor Assessment

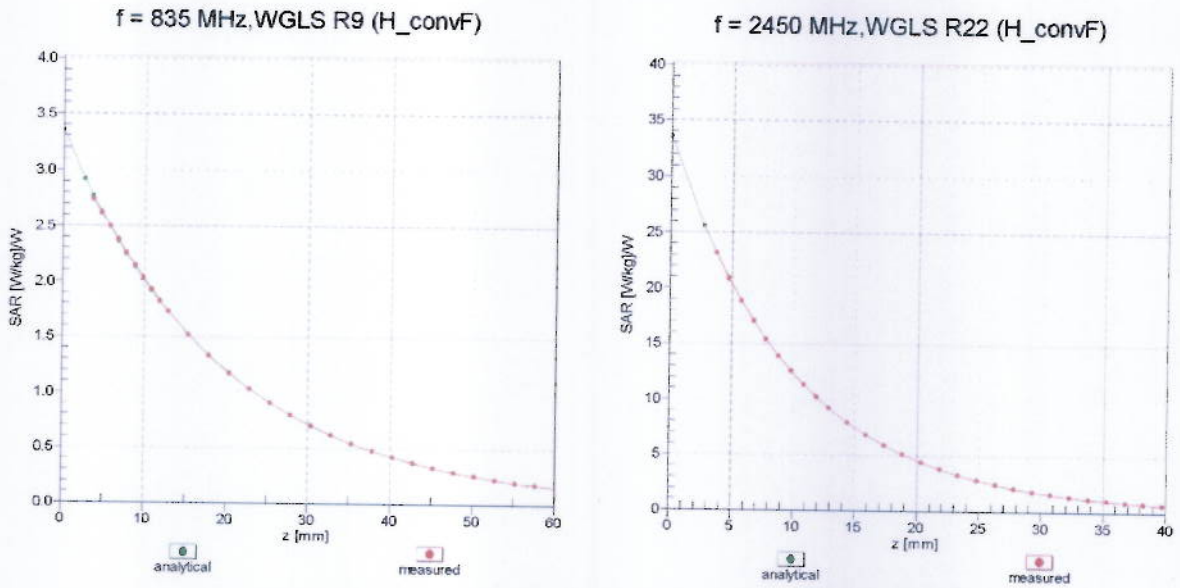

Deviation from Isotropy in Liquid Error (ϕ, ϑ), f = 900 MHz

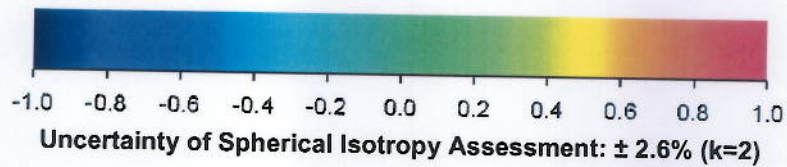
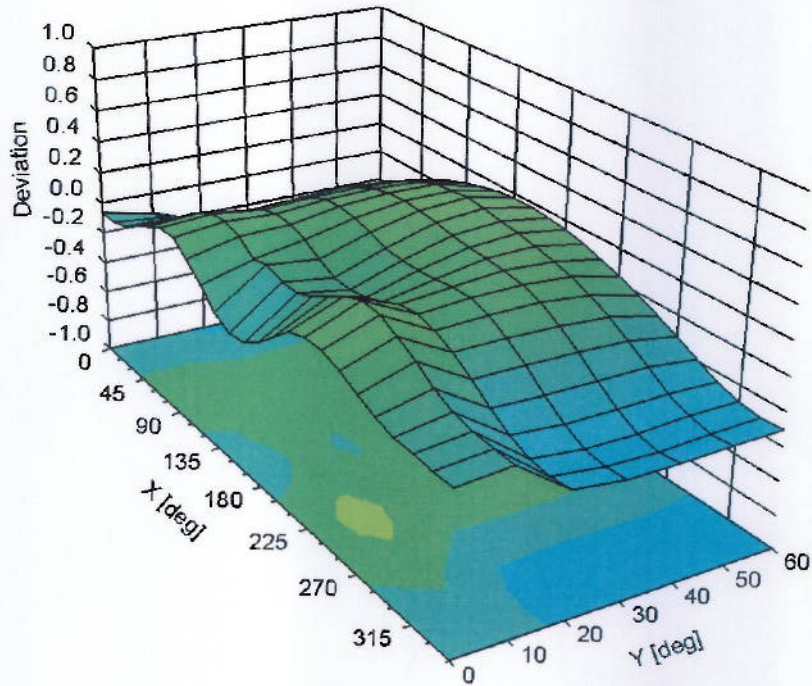

DASY/EASY - Parameters of Probe: ET3DV6 - SN:1788

Other Probe Parameters

Sensor Arrangement	Triangular
Connector Angle (°)	Not applicable
Mechanical Surface Detection Mode	enabled
Optical Surface Detection Mode	disabled
Probe Overall Length	337 mm
Probe Body Diameter	10 mm
Tip Length	10 mm
Tip Diameter	6.8 mm
Probe Tip to Sensor X Calibration Point	2.7 mm
Probe Tip to Sensor Y Calibration Point	2.7 mm
Probe Tip to Sensor Z Calibration Point	2.7 mm
Recommended Measurement Distance from Surface	4 mm