

---

# KODAK Baby Video Monitor and Dock / M300

**Monitor every moment. Record every memory.**

The recordable KODAK Baby Video Monitor—from the moment you press Record, you get up to 20 seconds of previous action. You'll always capture memories from the moment they start.

Attach gift card here

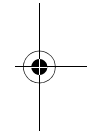
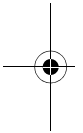

## User guide

[www.kodak.com](http://www.kodak.com)

For help:

[www.kodak.com/go/M300support](http://www.kodak.com/go/M300support)

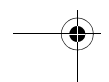
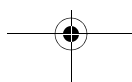

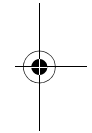
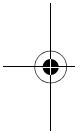
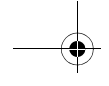

# Kodak

Eastman Kodak Company  
Rochester, New York 14650

© Kodak, 2011

All screen images are simulated.

Kodak is a trademark of Eastman Kodak Company.

4H8793\_en

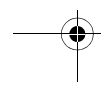
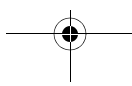

## Product features

### What's in the box:

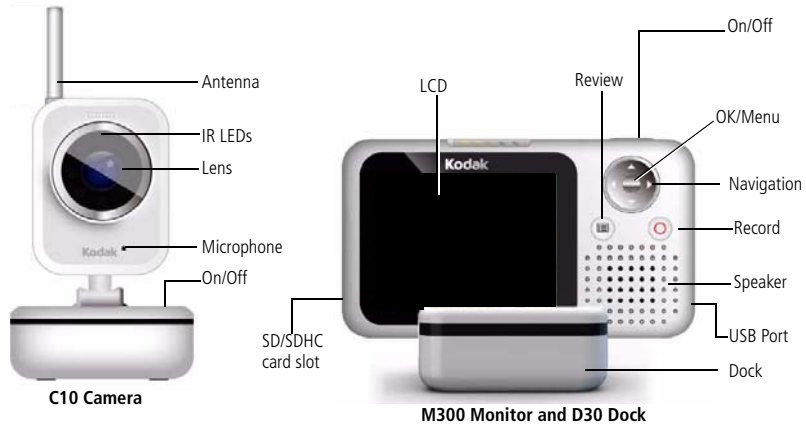

C10 Camera

M300 Monitor and D30 Dock

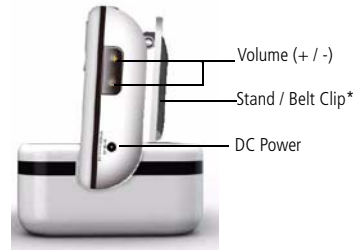
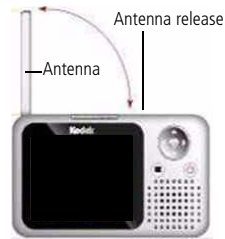

Monitor and Dock  
(side view)

### Also included:

#### Rechargeable battery pack

**(2) AC adapters:** A longer, 11.8 ft (3.6 m) cord for the camera, and a shorter, 6 ft (1.8 m) cord for the monitor

#### USB cable

#### Wall mounting accessories

**\*Stand / Belt Clip**—Use the stand to position the monitor on a flat surface. For portability, fasten the monitor to your belt with the clip.

[www.kodak.com/go/support](http://www.kodak.com/go/support)

EN i

## Product warning

 **CAUTION:**

**Strangulation Hazard—do not place the camera in the crib or within 3 ft (1 m) of the baby.**

- You must regularly monitor your baby's activity. This product cannot replace responsible, adult supervision. This product will not alert parents to a baby's silent activities.
- Never use extension cords with AC adapters. Use the AC adapters provided.
- When an AC adapter is plugged into an electrical outlet, do not touch the exposed end.
- Test the monitor before first use, periodically, and when changing the location of the camera.
- Do not use the monitor near water (bathtub, sink, etc). Keep the monitor away from heat sources (stoves, radiators, etc).
- This monitor may pick up signals from similar devices. Signals broadcast by this device may be picked up by other receivers.
- Small parts can be a choking hazard. Do not allow children to play with the camera or monitor.
- Use only the original, rechargeable battery pack provided.
- Install batteries correctly.
- Remove alkaline batteries from the camera if the camera is stored for long periods of time or when batteries are exhausted; do not mix old and new batteries; do not mix alkaline, standard, or rechargeable batteries.
- Keep all batteries away from children. Dispose of exhausted batteries properly.
- Do not attempt to recharge non-rechargeable camera batteries.

# Quick Start Up

## Camera

Operate the camera with the AC adapter or with 4 AA-size alkaline batteries (not provided).

- 1 If you choose to use AA-size alkaline batteries:
  - a Remove the screw on the back of the camera with a straight-blade screwdriver, then remove the battery door.
  - b Insert 4 batteries.
  - c Place the battery door back on the camera, then secure with the screw.
- 2 Select a location for the camera that will best capture the baby.



**CAUTION:**

**Strangulation Hazard—do not place the camera in the crib or within 3 ft (1 m) of the baby.**

- 3 Place the camera on a flat surface, such as a dresser or shelf. To mount the camera on a wall, [see page 4](#).
- 4 Connect the AC adapter with the longer cord to the back of the camera.
- 5 Plug the AC adapter into a standard electrical outlet, then secure the cord to the wall using the mounting clips, if necessary.
- 6 Press the On/Off button for at least 2 seconds. The button glows when the camera is turned on.

## Quick Start Up

### Monitor

Your monitor and camera were linked during manufacture.

The monitor operates only when the rechargeable battery pack is installed. After installing the battery pack, you can operate the monitor using the battery pack **or** with the AC adapter.

NOTE: To maximize battery life, charge the battery pack for 3 hours before first use. You can operate the monitor using the AC adapter during charging.

- 1 Select a convenient location for the monitor and dock that also provides optimal viewing (a table near your chair or sofa, for instance).
- 2 Slide the battery compartment cover to remove it.
- 3 Insert the battery pack connector into the socket, then insert the battery pack.

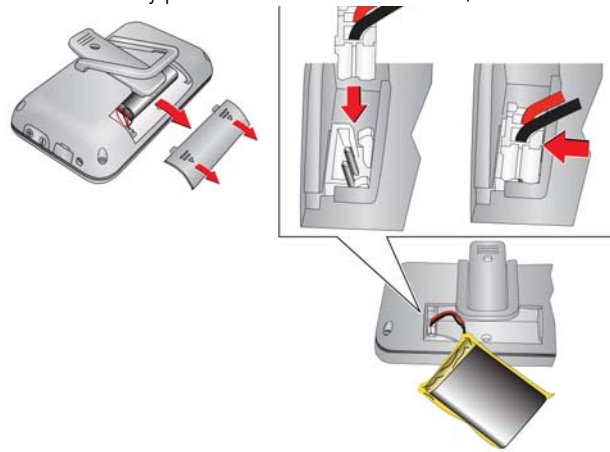

- 4 Close the battery compartment cover.
- 5 Connect the AC adapter with the shorter cord to the back of the monitor or dock.

## Quick Start Up

NOTE: If you prefer to use the monitor without the dock, connect the AC adapter with the shorter cord to the side of the monitor. For increased mobility, you can also use the monitor for up to eight hours with the rechargeable battery provided.

- 6 Seat the monitor in the dock. A red light on the dock glows when the monitor is properly seated.
- 7 Plug the AC adapter into a standard electrical outlet.
- 8 Press the On/Off button on the monitor for more than 2 seconds. A light on the top of the monitor glows when the monitor is turned on.
- 9 Turn on the camera.
- 10 Verify that an image appears on the monitor.

## Mount the Camera on a Wall

NOTE: Test monitor reception before mounting the camera on a wall. View the image on the monitor while someone else adjusts the camera position. Optimal camera-to-subject distance for night viewing is 3 – 6 ft (0.9 – 1.8 m).



### CAUTION:

**Strangulation Hazard—do not place the camera in the crib or within 3 ft (1 m) of the baby.**

- 1 Select a wall location for the camera, then drill 2 holes in that location using a 13/64 in. (5.2 mm) drill bit. Use the template provided (see page 18).
- 2 Insert a wall anchor into each hole, then gently tap the anchors with a hammer until they are seated (flush-mounted) in the wall.
- 3 Insert the screws into the anchors, then tighten the screws until approximately 7/32 in. (5.6 mm) of each screw is exposed.
- 4 Slide the base of the camera over the screws until the camera locks into place.
- 5 Connect the AC adapter to the camera (or insert 4 AA-size alkaline batteries).
- 6 Secure the AC adapter cord to the wall with the mounting clips.

## Quick Start Up

---

### Using the Camera

**On / Off Button**—Press for more than 2 seconds to turn camera On/Off.

### Using the Monitor

**On / Off Button**—

**Short Press**—Press to turn the display On/Off.

**Long Press**—Press for more than 2 seconds to turn the monitor On/Off.

NOTE: When the monitor is turned on, sounds transmitted by the camera are heard even when the display is turned off.

**OK / Menu Button**—Press to access features.

**Volume Control**—Press the + / - buttons to adjust the sound level.

**Record Button**—Press to Start / Stop video recording.

**Review Button**—Press to play a video.

**Navigation Buttons** ▲▼ ◀▶ —Press to select menu options.

**Power / Low Battery / Link Indicator - White LED**—

**Constant**—Normal operation

**Flashing slowly**—Battery level is low

**Flashing fast (twice per second)**—Monitor cannot establish link with the camera

NOTE: See [Linking additional cameras to your monitor](#), page 8.



## LCD Indicators

**Signal**— Displays signal strength and link status.



Good signal from the camera. Camera and monitor are linked.



Diminished signal. Adjust distance between camera and monitor.



No signal. Link from the camera is lost (see Troubleshooting).

## Camera-to-Monitor linking icons



Signal strength and battery status as they appear on the LCD

**Sound Level indicator**—Up to 4 orange LEDs indicate the sound level that the monitor is receiving.

## Quick Start Up

---

### Battery Status indicators—



**Fully Charged**—Battery is fully charged.



**Battery Charging**—Battery symbol changes in sequence.



**Battery Low**—Flashing symbol mean the battery needs charging.



**AC Power**—Device is powered by the AC adapter.

NOTE: When the battery is low for more than 10 minutes, the monitor turns off.

### SD Card Status—



SD Card is installed in the monitor.



No card is installed.



SD Card is full. Replace the card or delete files on the card to create space.



SD Card is locked. Remove the card, then slide up the small switch on the side of the card (toward the top of the card).

## Linking additional cameras to your monitor

Your camera and monitor were linked during manufacture. To purchase additional cameras and approved accessories, go to the KODAK Store ([www.kodak.com/go/accessories](http://www.kodak.com/go/accessories)).

To link additional cameras:

Linking button



- 1 Use a paper clip to press and hold the linking button on the back of the additional camera for more than 2 seconds (a white LED on the **camera** blinks twice per second for 10 seconds).
- 2 Press and hold the OK button on the **monitor** for more than 3 seconds (a linking icon appears on the LCD). After camera No. 2 is successfully linked, the display will show the image from the camera.

The image on the monitor switches from camera No. 2 to camera No. 1 after 10 seconds.

NOTE: Repeat the procedure to link up to 4 cameras.

## Camera Select

You can view video from the selected camera or from all cameras in sequence. The default monitor setting displays video from each linked camera for up to 10 seconds in sequence. To change to a different camera manually, press ► to select a camera, then press OK.

## Quick Start Up

---

### Special Features

**Buffered Recording**—Insert a memory card into the monitor, then press Record. The monitor records the current scene and up to 20 seconds of previous action.

**IMPORTANT:** *You must insert a memory card into the monitor to record video.*

**Night View**—In a dark room, the monitor uses infrared LEDs to enable you to see your baby at night.

**Review/Play**—Press the Review button on the monitor—the first frame of the most recently recorded video appears. In the bottom of the screen, a counter displays the number of saved videos. Press OK to Play. The recorded length, in minutes, appears on the top, right side of the screen. To locate another video, press ◀▶.

**Fast forward**—While in Play mode, press ▶ to fast forward through the video at 2X speed (press twice for 4X and 3 times for 8X). Press ◀ to decrease the playing speed or rewind to the beginning of the video.

**Pause**—While in Play mode, press the OK button to pause the video. Press OK again to restart the video.

**Live View Mode**—Press Review to return to live view mode.

**Delete a Video**—While in Play or Review mode, press ▼ to select the delete icon. To permanently delete the video, press the down arrow again, then press OK.

## Copying recorded videos to your computer

- 1 Turn on the monitor.
- 2 Connect the USB cable to the monitor and your computer.  
"Found Hardware" appears in your computer tray, and a new drive appears under My Computer.
- 3 Open the new drive, then copy any saved videos from the SD Card in your monitor to a new location on your computer. You may need to turn on the monitor after disconnecting from your computer.

NOTE: You can also turn off the monitor, remove the SD Card, then insert the card into a card reader that is connected to your computer.

## Using the Menu to access more features

- 1 Press the OK button.
- 2 At the menu, press ◀▶ ▲▼ to select a feature.

**Your selection appears in red.**

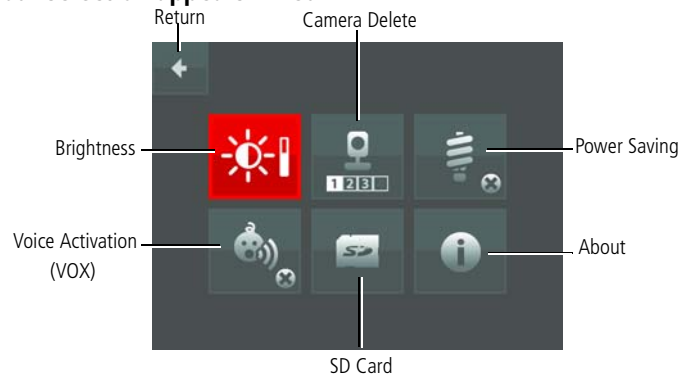

- 3 Press the OK button to enter the sub-menu for your selection.

NOTE: Press ◀▶ ▲▼ to return to the main menu at any time.

## Quick Start Up

### Sub-menus

**Brightness**—Press ▲▼ to adjust the brightness of your monitor image, then press OK.

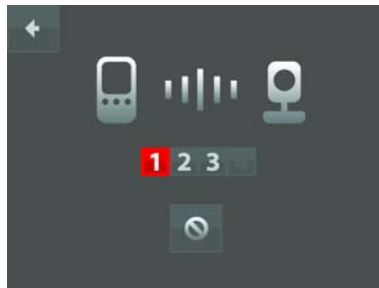

**Camera Delete**—While in Camera Delete, press OK. Press ◀▶ to select a camera to delete, then press OK.



NOTE: If you only have one camera, you cannot delete it.

**Power Saving**—You can turn off the LCD to save power. Press ▲▼ to select 30 Seconds, 5 minutes, 30 minutes, or OFF. Press OK to return to the main menu.

**Voice Activation (VOX)**—The monitor screen turns on when a preset sound level is detected from the camera for more than 10 seconds. If the detected sound drops below the preset sound level, the monitor turns off after 15 seconds. Press ▲▼ to activate. The last setting is saved. Press OK to return to the Main menu.

**SD Card**—If an SD card is installed in the monitor, an icon  appears in the main menu. Press ▶ to select the icon, then press OK. To format the SD Card, select  again, then select OK. After formatting is complete, the main menu appears.



#### CAUTION:

Formatting deletes all information stored on the SD card.

## Set the Date and Time

**IMPORTANT:** You must install an SD Card in the monitor to set the date and time. Date and time must be set so that recorded videos are sorted by date and time.

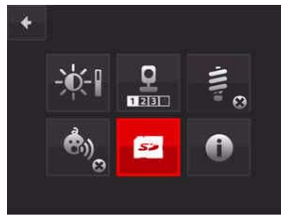

- 1 At the Main menu, select the SD Card icon, then press OK.
- 2 Press ▲▼ ◀▶ to select Date/time, then press OK.
- 3 Select a Date format.
- 4 Press ▲▼ to change numbers from 0 to 9. Press the ◀▶ to move between date format and time setting. Press ▶ to increase or ◀ to decrease numbers.
- 5 Press OK to return to the Date/time and SD Card Format menu.
- 6 Press ▲▼ ◀▶ select the Return arrow, then press OK to return to the Main menu.

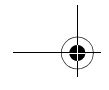

## Quick Start Up

---

### Tips and Troubleshooting

- To improve reception, adjust the distance between the camera and the monitor, or move the monitor away from other devices (cordless phones, Wi-Fi devices, etc). You can also extend the antenna on the monitor.
- To conserve battery power, use the AC adapter.
- If you installed alkaline batteries in the camera, remove them during long periods of non-use.

#### No picture or sound—Verify that the:

- Monitor is turned on
- AC adapters are plugged into a working, standard electrical outlet
- Camera is properly linked

#### Sound but no picture—Verify that the:

- Power-Saving mode is deactivated ([see page 11](#)). Press the On/Off button quickly to activate/deactivate the display.
- Monitor brightness is adjusted properly ([see page 11](#)).
- Device locations are acceptable. Move the camera and monitor to different locations.

#### Picture but no sound—Increase the monitor volume.

#### Picture not clear—

- For Night Vision, position the camera within 6 ft (1.8 m) of the baby.
- Test reception by moving the monitor and/or camera to a different location.
- Move the monitor away from other devices (cordless phones, Wi-Fi devices, etc).
- Adjust the monitor brightness ([see page 11](#)).
- Position the monitor closer to the camera, if necessary.

#### Squealing sound—Move the camera and the monitor farther away from each other.

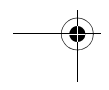
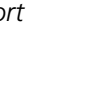
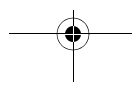
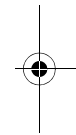
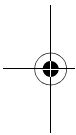



## Appendix

### KODAK Baby Video Monitor and Dock / M300

Specifications	
<b>Monitor</b>	3 in. (7.62 cm) diagonal LCD, 640 x 480 pixels, 4:3 aspect ratio
<b>Power supply</b>	
<b>M300 System</b>	AC Adapter Model No. EFS0050059055OUL, Manufacturer: Eastern Frontier. EIAJ Class 2 DC plug. Input: 100-240V AC 50/60 Hz. 0.2 Amp Output: 5.9 V DC, 0.55 Amp, 1.8 m cable
Size	4.9 x 2.8 x 1.0 in (12.4 x 7.1 x 2.5 cm)
Weight	1.1 lb (511 g)
<b>C10 Camera</b>	AC Adapter Model No. EFS0050059055OUL, Manufacturer: Eastern Frontier. EIAJ Class 2 DC plug. Input: 100-240V AC 50/60 Hz. 0.2 Amp Output: 5.9 V DC, 0.55 Amp, 3.6m cable
Size	2.8 x 3.2 x 6.0 in (7.1 x 8.1 x 15.2 cm)
Weight	0.46 lb (210 g)
<b>Communication with USB devices</b>	
USB Full Speed Type A	
<b>Wireless network compatibility</b>	
2.4 GHz RF	
<b>Other features</b>	
Video formats	AVI video file
Memory cards (see page 7)	SD, SDHC up to 32 GB.

## Appendix

Temperature	Operating: 32 to 104° F (0 to 40° C) Storage: -25 to 160° F (-32 to 71° C)
-------------	---

### Important safety instructions

#### Limited warranty

Kodak warrants KODAK Consumer Electronic Products and Accessories ("Products"), to be free from malfunctions and defects in both materials and workmanship for one year from the date of purchase. Retain the original dated sales receipt. Proof of the date of purchase will be required with any request for warranty repair.

#### Limited warranty coverage

Warranty service is only available from within the country where the Products were originally purchased. You may be required to ship Products, at your expense, to the authorized service facility for the country where the Products were purchased. Kodak will repair or replace Products if they fail to function properly during the warranty period, subject to any conditions and/or limitations stated herein. Warranty service will include all labor as well as any necessary adjustments and/or replacement parts. If Kodak is unable to repair or replace a Product, Kodak will, at its option, refund the purchase price paid for the Product provided the Product has been returned to Kodak along with proof of the purchase price paid. Repair, replacement, or refund of the purchase price are the sole remedies under the warranty. If replacement parts are used in making repairs, those parts may be remanufactured, or may contain remanufactured materials. If it is necessary to replace the entire Product, it may be replaced with a remanufactured Product. Remanufactured Products, parts and materials are warranted for the remaining warranty term of the original Product, or 90 days after the date of repair or replacement, whichever is longer.

#### Limitations

This warranty does not cover circumstances beyond Kodak's control. This warranty does not apply when failure is due to shipping damage, accident, alteration, modification, unauthorized service, misuse, abuse, use with incompatible accessories or attachments, failure to follow Kodak's operation, maintenance or repacking instructions, failure to use items supplied by Kodak (such as adapters and cables), or claims made after the duration of this warranty. Kodak makes no other express or implied warranty for this product, and disclaims the implied warranties of merchantability and fitness for a particular purpose. In the event that the exclusion of any implied warranty is ineffective under the law, the duration of the implied warranty will be one year from the purchase date or such longer period as required by law. The option of repair, replacement, or refund is Kodak's only obligation. Kodak will not be responsible for any special, consequential or incidental damages resulting from the sale, purchase, or use of this product regardless of the cause. Liability for any special, consequential or incidental damages (including but not limited to loss of revenue or profit, downtime costs, loss of the use of the equipment, cost of substitute equipment, facilities or services, or claims of your customers for such damages resulting from the purchase use or failure of the Product), regardless of cause or for breach of any written or implied warranty is expressly disclaimed.

### Your rights

Some states or jurisdictions do not allow exclusion or limitation of incidental or consequential damages, so the above limitation or exclusion may not apply to you. Some states or jurisdictions do not allow limitations on how long an implied warranty lasts, so the above limitation may not apply to you. This warranty gives you specific rights, and you may have other rights which vary from state to state or by jurisdiction.

### Outside the United States and Canada

In countries other than the United States and Canada, the terms and conditions of this warranty may be different. Unless a specific Kodak warranty is communicated to the purchaser in writing by a Kodak company, no warranty or liability exists beyond any minimum requirements imposed by law, even though defect, damage, or loss may be by negligence or other act.

### Regulatory compliance and advisory

#### FCC compliance and advisory

This equipment has been tested and found to comply with the limits for a Class B digital device, pursuant to Part 15 of the FCC Rules. These limits are designed to provide reasonable protection against harmful interference in a residential installation.

This equipment generates, uses, and can radiate radio frequency energy and, if not installed or used in accordance with the instructions, may cause harmful interference to radio communications. However, there is no guarantee that interference will not occur in a particular installation.

If this equipment does cause harmful interference to radio or television reception, which can be determined by turning the equipment off and on, the user is encouraged to try to correct the interference by one or more of the following measures: 1) reorient or relocate the receiving antenna; 2) increase the separation between the equipment and the receiver; 3) connect the equipment to an outlet on a circuit different from that to which the receiver is connected; 4) consult the dealer or an experienced radio/TV technician for additional suggestions.

Any changes or modifications not expressly approved by the party responsible for compliance could void the user's authority to operate the equipment. Where shielded interface cables have been provided with the product or specified additional components or accessories elsewhere defined to be used with the installation of the product, they must be used in order to ensure compliance with FCC regulation.

#### FCC and Industry Canada

This device complies with Industry Canada RSS-210 and FCC Rules. Operation is subject to the following two conditions: (1) this device may not cause harmful interference, and (2) this device must accept any interference received, including interference that may cause undesired operation.

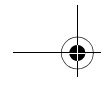

## Appendix

---

### FCC et Industrie Canada

Cet appareil est conforme à la norme RSS-210 d'Industrie Canada et aux réglementations de la FCC. Son utilisation est soumise aux deux conditions suivantes : (1) cet appareil ne doit pas provoquer d'interférences nuisibles, et (2) cet appareil doit supporter les interférences reçues, y compris celles susceptibles de nuire à son bon fonctionnement.

### Canadian DOC statement

**DOC Class B Compliance**—This Class B digital apparatus complies with Canadian ICES-003.

**Observation des normes-Classe B**—Cet appareil numérique de la classe B est conforme à la norme NMB-003 du Canada.

### Notice

When the monitor is operating, it is possible to view images and other content directly from other sources. Eastman Kodak Company, its subsidiaries and affiliates do not control and are not responsible for any content displayed or viewed.

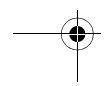
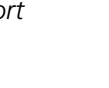
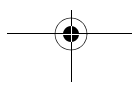
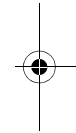
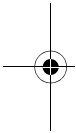



## Wall mounting Template

Select a wall location for the camera, then drill 2 holes in that location using a 13/64 in. (5.2 mm) drill bit. Use this template to determine hole placement.

