

Phottix Laso TTL Flash Trigger_Transmitter

Thank you for purchasing a Phottix Product

Note: Before using the Phottix Laso TTL Flash Trigger, please read this instruction manual carefully, while also referring to the instruction manuals of your camera, flash and other relevant devices.

Warnings

1. This product is a precise electronic instrument. Do not expose to damp environments or dust.
2. Please shut down the power of all devices when installing the wireless trigger.
3. Do not drop or crush.
4. Do not use the wireless trigger at flammable, explosive or high temperature environment.
5. Do not use harsh chemicals or solvents to clean the body. Use a soft cloth or lens paper.
6. Remove batteries from the wireless trigger if not being used for an extended period.
7. Interference: The Phottix Laso wireless trigger transmits radio signals at 2.4GHz. Its performance can be affected by electrical current, magnetic fields, radio signals, wireless routers, cellular phones, and other electronic devices. Environmental objects, such as large buildings or walls, trees, fences, or cars can also affect transmission performance. If your wireless trigger can't be triggered, move its location slightly.

FCC Interference Statement:

This device complies with part 15 of the FCC Rules. Operation is subject to the following two conditions: (1) This device may not cause harmful interference, and (2) this device must accept any interference received, including interference that may cause undesired operation.

FCC Radiation Exposure Statement:

This equipment complies with FCC RF radiation exposure limits set forth for an uncontrolled environment. This device and its antenna must not be co-located or operating in conjunction with any other antenna or transmitter.

NOTE: This equipment has been tested and found to comply with the limits for a Class B digital device, pursuant to Part 15 of the FCC Rules. These limits are designed to provide reasonable protection against harmful interference in a residential installation. This equipment generates, uses and can radiate radio

frequency energy and, if not installed and used in accordance with the instructions, may cause harmful interference to radio communications. However, there is no guarantee that interference will not occur in a particular installation. If this equipment does cause harmful interference to radio or television reception, which can be determined by turning the equipment off and on, the user is encouraged to try to correct the interference by one or more of the following measures:

- Reorient or relocate the receiving antenna.
- Increase the separation between the equipment and receiver.
- Connect the equipment into an outlet on a circuit different from that to which the receiver is connected.
- Consult the dealer or an experienced radio/TV technician for help.

Phottix Laso Wireless Trigger for Canon/Transmitter

The Phottix Laso transmitter is used for wireless flash shooting. It can control up to 5 groups (15 units) of radio-enabled Canon Speedlites, as well as non-wireless Canon E-TTL Speedlites by using the Phottix Laso receiver. The transmitter supports multiple flash modes and shooting approaches including E-TTL II/E-TTL, Manual, MULTI, Ext.A and Linked Shooting.

Table of Contents

- I. Parts
- II. Preparation Before Use
- III. The LCD Display
- IV. Wireless Flash Shooting: Radio Transmission
 - 1. Wireless Flash Setting
 - 2. E-TTL: Fully Automatic Wireless Flash Shooting
 - 3. Using Fully Automatic Wireless Flash
 - 4. E-TTL: Wireless Multiple Flash Shooting with Flash Ratio
 - 5. M:Wireless Multiple Flash Shooting with Manual Flash Output
 - 6. Multi:
 - 7. Gr: Shooting with a Different Flash Mode for Each Group
 - 8. Linked Shooting
- V. Setting Transmitter Functions with Camera Operations
- VI. Customizing the Transmitter
 - 1.C.Fn: Setting Custom Functions
 - 2.P.Fn: Setting Personal Functions
- VII. Technical Specification
- VII. Trouble Shooting Guide

I. Parts

- 1.<LINK> indication light: Radio transmission confirmation lamp
- 2.LCD panel
- 3.Function Button 3
- 4. Function Button 2
- 5. Function Button 1
- 6.<MODE>: Flash mode button
- 7.<⚡>: Charge lamp/Test flash button ;
- 8.<⦿>: Select/Set button
- 9.<⦿>: Select dial
- 10.Mounting foot lock lever
- 11.Battery compartment cover
- 12.Function button 4
- 13. <⚡>: Linked shooting button
- 14.Power button
- 15.Flash exposure confirmation lamp
- 16.Lock-release button
- 17.USB port
- 18.Remote release terminal
- 19.Contacts
- 20.Mounting foot
- 21.Locking pin
- 22.AF assist light



II. Preparation before use

Installing the batteries

1. Press the battery compartment cover and slide it down as shown to open the battery cover. (Picture 1)
2. Insert the batteries as shown. Make sure the “+” and “-” battery contacts are correctly oriented as shown. (Note: Please use 2 pieces of AA alkaline batteries or AA type NI-MH batteries. (Picture 2)
3. Replace the battery cover and push back into the locked position.



(图一)



(图二)

Attaching and Removing the Phottix Laso transmitter

Attaching the Phottix Laso transmitter to the camera hot shoe

1. Turn off the camera and Phottix Laso transmitter
2. Align the Phottix Laso transmitter hot shoe with camera's hot shoe mount.
3. Slide the Phottix Laso transmitter all the way into the camera's hot shoe mount.
4. Lock the Phottix Laso transmitter by sliding the mounting foot lock lever to the right until the lock lever clicks in place. (See picture 3)



(图三)



(图四)

Removing the Phottix Laso Transmitter

1. Lock release: press the lock-release button while slide the lock lever all the

<p>way back to the left. (see picture 4)</p> <ol style="list-style-type: none"> Slide the Phottix Laso transmitter out of camera's hot shoe mount. 	
---	--

Turn On/Off the Phottix Laso transmitter

- Turn On: Press and hold the power button until MENU interface is displayed on screen.
- Turn off: Press and hold the power button until the LCD screen goes blank.

Note: When  is displayed, please replace the batteries with new ones.

Checking the version info of the Phottix Laso transmitter

You can check the present version information on Phottix Laso transmitter: While pressing the power button to turn on the transmitter, press the flash <MODE> button simultaneously until the version info is displayed on the LCD screen.

<⚡>: Charge Lamp/Test Flash Button

- The charge lamp lights when the wireless shooting (slave) is ready.
- During wireless shooting, master unit's charge up will be lit when all slave units are fully charged.
- During wireless shooting, you can press the transmitter's charge lamp (test flash button) to fire a test flash.

Remote Release from Slave Unit

When performing wireless shooting, Phottix Laso transmitter supports remote release (remote control shooting) from a flash set or Phottix Laso receiver as a slave unit. For operations, see the flash or Phottix Laso receiver's instruction manual.

Note

When using the remote release function, the slave unit camera might need a shutter release cable (available separately) depending on the camera models.

- EOS digital cameras since 2012 do not need to use shutter release cable.
- EOS cameras before 2012, which are compatible with E-TTL II/E-TTL autoflash

and come with N3 type remote terminal EOS, a shutter release cable will be needed for linked shooting.

Test Flash from a slave unit

You can fire a test flash from a flash set as a slave unit. For operations, see the flash's instruction manual.

Note: When two or more units are set to master, the unit with the <LINK> lamp lit in green is the one that fires.

Modeling Flash

1. Modeling Flash from a Master Unit

When the camera's depth-of-view preview button is pressed, the flash will fire continuously for 1 sec. This is called the modeling flash. It enables you to see the effects of the flash on the subject and the lighting balance. You can also fire the modeling flash by pressing the charge lamp/test flash button on Phottix Laso transmitter (the operation required to be enabled in advance by setting C.Fn 02).

2. Modeling Flash from a Slave Unit

With EOS digital cameras released since 2012, you can fire the modeling flash from a flash set as a slave unit. For the operations, see the flash's instruction manual.

AF assist light

In low light/contrast situation, the Phottix Laso transmitter's built-in Auto Focus Assist Light will illuminate to assist with AF. The AF Assist Light on the front of the transmitter will project a focusing target on the subject. As laser light, the AF assist light has the advantages of better directionality, less decay and better performance compared with LED type AF assist lights. You can choose to enable or disable the AF assist light by setting P. Fn 08.

Note: The laser AF assist light is safe with optical power less than 5mW. However, avoid pointing the light at human eyes.

Memory Function

Phottix Laso transmitter supports memory function. You can save the wireless settings and recall the setting later.

1. Press function button 4 until **MENU 4** is displayed.
2. Save or load the settings

















Press function button 3 corresponding to **MEMORY**, and then press function button 1 corresponding to **SAVE**, the settings are saved (stored in the memory). Press function button 2 corresponding to **LOAD**, the settings that were saved are set.

Clearing Transmitter Settings

You can return the settings for wireless shooting to their default settings.

Press function button 2 and 3 simultaneously for 2 seconds or longer, the transmitter setting are cleared and the shooting mode returns to <ETTL>flash mode. Note that even when the settings are cleared, the transmission channel, the wireless radio ID and the C.Fn and P.Fn settings are not canceled.

III. MENU Functions

1.		FEB level	±3EV (in 1/3-stop increments)	
2.		Flash exposure compensation	±3EV (in 1/3-stop increments)	
3.		C.Fn function	C.Fn -01 to 22	
4.		Flash Ratio	ETTL	RATIO A:B C RATIO A:B RATIO OFF A:B ratio setting: 8:1 to 1:8, in 1/2-stop increments
			M/Multi	RATIO A:B:C RATIO A:B RATIO OFF
5.		Scan function	Scan the radio reception status and set the master unit's transmission channel automatically or manually.	
6.		Wireless radio ID	0000-9999	
7.		Transmission Channel	Ch.1-Ch.15and Auto	
8.		Memory Function		Save the present setting
				Load the settings that were saved
				Back to shooting-ready state
9.		Sync Mode		Enable High Speed Sync
			No display	First Curtain Sync
10		Firing group	Up to 5 firing groups A 、 B 、 C 、 D 、 E (at Gr mode)	
11		Multi Stroboscopic Flash Frequency	1-500Hz	
12.		Multi Stroboscopic Flash Number	1-100times, based on the frequency and flash output	

LCD Display

Phottix Laso transmitter's LCD display comes with five modes: E-TTL · M · MULTI · Gr and LINKED SHOT. You can cycle through “E-TTL · M · MULTI · Gr” by pressing <MODE> button. And by pressing and holding <Z> button, you can switch the LCD to display LINKED SHOT. Different display settings come to perform different flash modes. Find details about the five flash modes as following:

1. E-TTL/E-TTL II autoflash

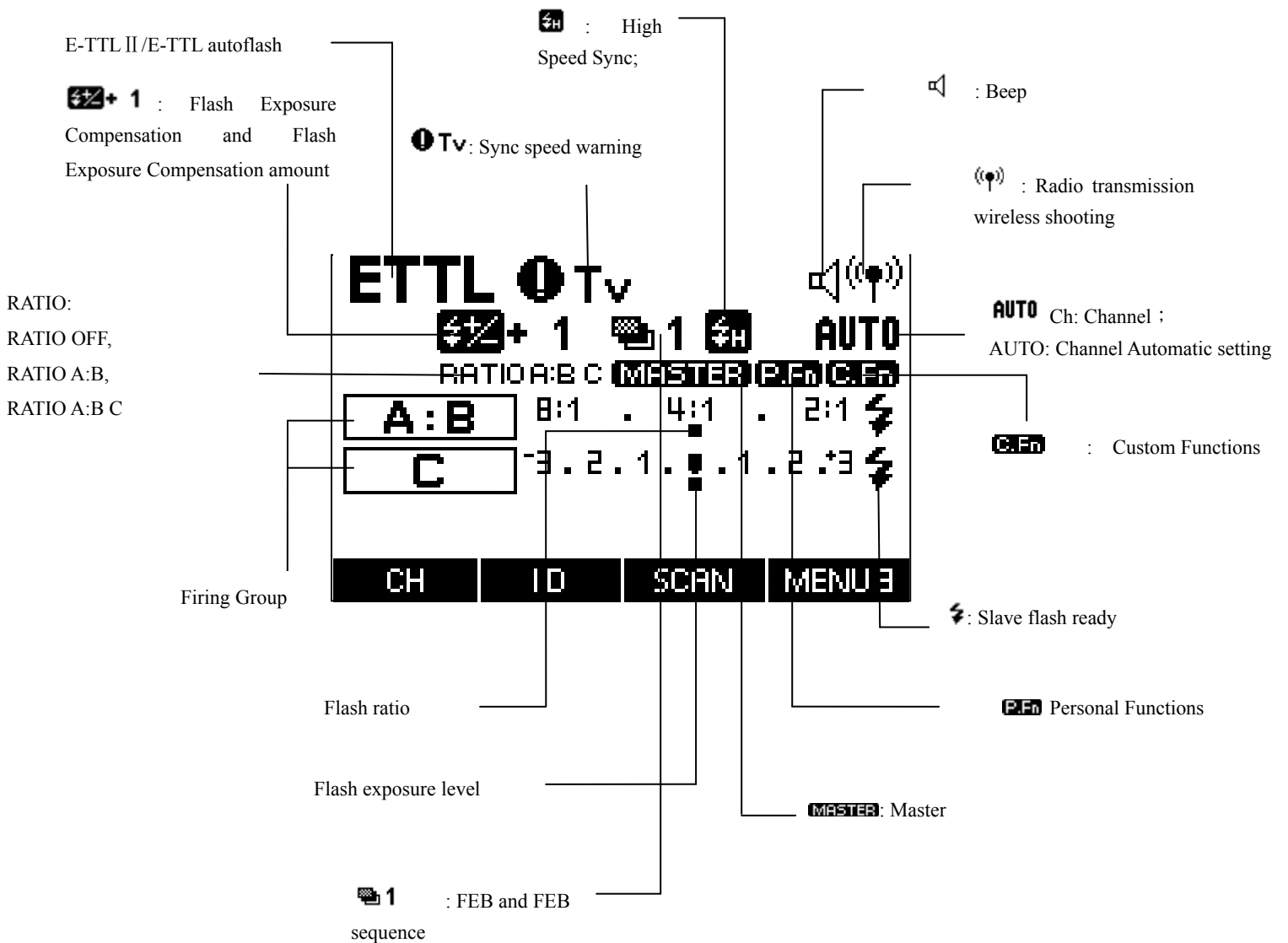

2. Manual Flash

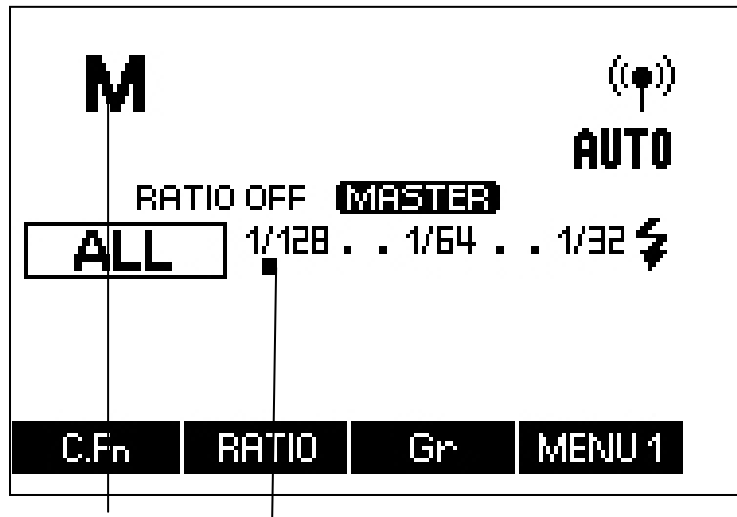

M: Manual Flash Manual Flash Output

3. Stroboscopic Flash

MULTI: Multi (Stroboscopic) flash

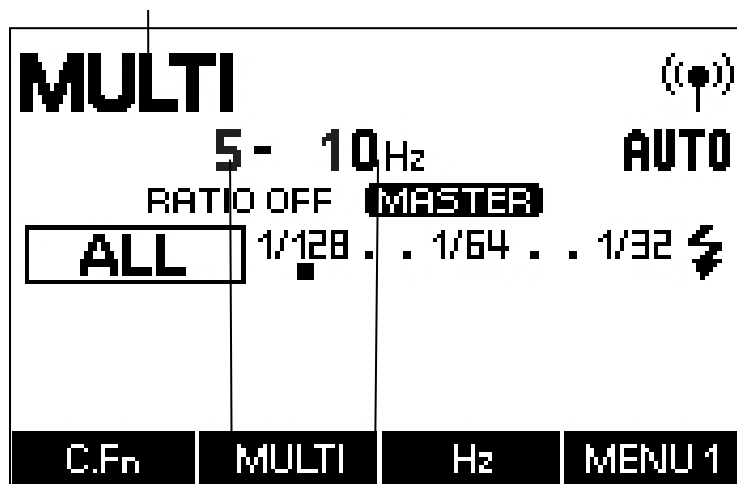

Number of flashes

Flash frequency

4. Group Firing

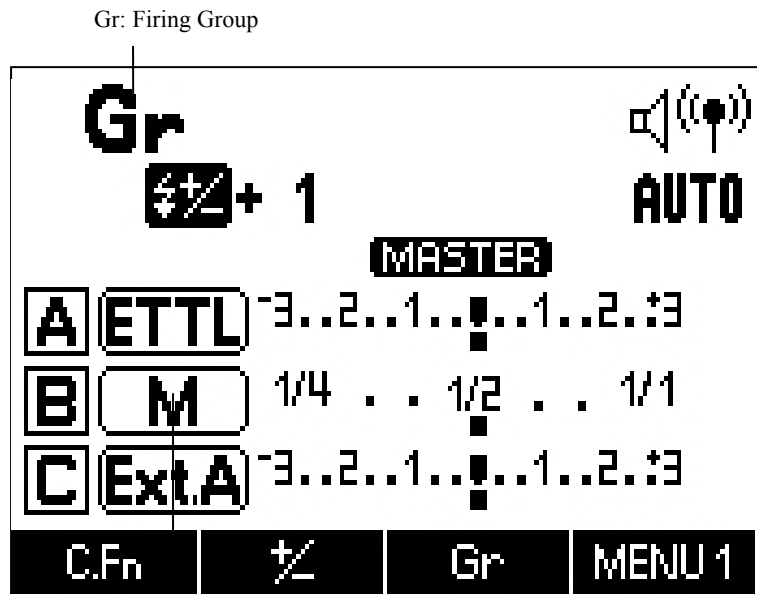

Three flash modes optional: ETTL · M · Ext. A

5. Linked Shooting

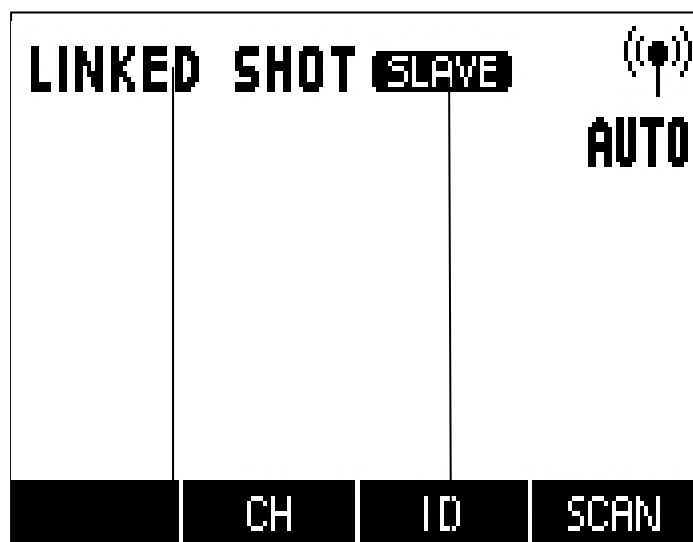

LINKED SHOT: Linked Shooting

SLAVE : SLAVE, Slave unit;
MASTER, Master unit;

Note: 1) The display will show only the settings currently applied.

- 2) The functions displayed above function buttons 1 to 4, such as **C.Fn** and **1/2**, change according to the settings' status.
- 3) When a button or dial is operated, the LCD panel illuminates.

IV. Wireless Flash Shooting: Radio Transmission

Note:

The transmitter attached to the camera is called the master unit, and a flash that is wirelessly controlled is called the slave unit.

When the camera's shooting mode is set to fully automatic mode or an Image Zone mode, the operations below are not available. Please set the camera's shooting mode to **P/Tv/Av/M/B** (Creative Zone mode) .

Wireless Flash Shooting

Using a transmitter and Canon radio-enabled Speedlites makes it easy to shoot with advanced wireless multiple flash lighting, in the same way as normal E-TTL II /E-TTL auto flash shooting.

The settings of the transmitter attached to the camera (master) are automatically reflected on the flash that is wirelessly controlled (slave). You do not need to operate the slave unit while shooting. You can then perform wireless E-TTL II/ETTL autoflash shooting just by setting the master unit to ETTL mode.

You can choose to perform autoflash shooting using one slave unit only, or perform wireless multiple flash shooting using two or more(up to 15) slave units.

The slave units can be radio-enabled speedlites and set on slave mode, and also other Canon ETTL flashes that are incompatible with the radio transmission wireless function by using with Phottix Laso receiver.

Master Unit	Slave Unit
Phottix Laso Transmitter	Canon Speedlites that have a wireless flash shooting function using radio transmission, like 600EX-RT (Slave mode) .
	Phottix Laso receiver+Canon ETTL Flash (Non-wireless mode)

Note:

- 1) When using Phottix Laso receiver as slave unit, restrictions will apply to parts of its functions. And parts of the operations would also be different. For details, see the instruction manual of Phottix Laso receiver







2) When performing radio transmission wireless flash shooting, restrictions may apply to the flash mode, maximum flash sync speed (referred to below as the “flash sync speed”) and high-speed sync function, depending on the camera used.

Wireless Settings

To perform wireless shooting, set the Phottix Laso transmitter (master unit) and flash (slave unit) with the following procedure.

1. Master unit setting: Check that **MASTER** is displayed.
2. Slave unit setting: For the slave unit setting, see the flash or receiver’s instruction manual.
3. Transmission Channel/Wireless Radio ID Settings: To avoid interference with wireless multiple flash systems using radio transmission that are used by other photographers or with other devices that use radio waves (wireless), you can change the transmission channel and wireless radio ID.

Use the following procedures to set the master unit’s transmission channel and wireless radio ID. Set the same channel and ID for both the master unit and slave unit. For the slave unit settings, see the flash’s instruction manual.









1. Press function button 4 until **MENU** is displayed.
2. Set a channel: press function button 1 corresponding to **CH**, turn  to select from Ch. 1-15 or Auto, and press  button to finish the setting.
3. Set wireless radio ID: press function button 2 corresponding to **ID**, turn  to select the digit to be set and press  button. Again turn  to select a number from 0-9, and press the  button.
4. Repeat step 4 to set the four ID

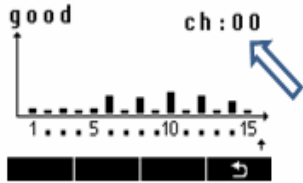

<p>digits one by one. Press function button 4 for corresponding to  to return to the shooting-ready state.</p> <p>5. When the transmission between the master unit and slave unit is established, the <LINK> lamp lights green.</p>	
--	--

4. Scanning the Master Unit Transmission Channels to Set

Phottix Laso transmitter is able to scan the radio reception status and set the master unit's transmission channel automatically or manually. When the channel is set to "AUTO", the channel with the best reception signal is automatically set. When setting the channel manually, you can set the transmission channel again while referring to the scan results.

<p>1. Scanning while "AUTO" is set: Press function button 4 to display , and then function button 3 corresponding to . The channel is reset to one with a good reception signal.</p>	
<p>2. Scanning while Ch.1 to 15 is set: Press function button 4 to display , and then function button 3 corresponding to . The radio reception status is displayed in a graph. The higher the peak of the channel in the graph, the better the radio reception signal. Turn  to select from Ch.1 to 15, and press  button to return to shooting-ready state.</p>	

The color of <LINK>lamp changes depending on the transmission status of the master unit and the slave unit.

Color	Status	Description	Action
Green	Lit	Transmission OK	-
Red	Lit	No connected	Check the channel and ID
	Blinking	Too many units	Master Units + slave units = 16units or less
		Error	Turn the power off and on again

Note: 1).If the transmission channels of the master unit and slave unit are different, the slave unit does not fire. Set both to the same number, or set both to “AUTO”.

2).If the wireless radio IDs of the master unit and slave unit are different, the slave unit does not fire.

ETTL: Fully Automatic Wireless Flash Shooting

Phottix Laso transmitter attached to the camera (master) and a wirelessly controlled flash (slave) can perform fully automatic wireless shooting.

1. Autoflash Shooting Using One Slave Unit

1.1 Set the flash as the slave unit: For the slave unit setting, see the flash or the Phottix Laso receiver’s instruction manual. Set A, B or C as the firing group. If set to D or E, the flash does not fire.

1.2 Check the channel and ID: If the channels and IDs of the master unit and slave unit are different, set them to exactly the same number.

1.3 Position the camera and the slave unit within the range of wireless radio transmission.

1.4 Set the flash mode to <ETTL>: Press the <MODE> button on master and set the flash mode to <ETTL>.The slave unit is set automatically to<ETTL> during shooting via the control form the master unit. For slave units that use Phottix Laso receiver, flashes on the receiver need not to set to wireless slave mode, but the need to be set to ETTL mode manually during shooting.

1.5 Check the transmission status and that the flash is ready:

Check that the <LINK>lamp lights green;

When the flash that is set to wireless slave mode is ready, the AF-assist beam emitter blinks at 1-second intervals;

Check that the <📡> slave flash-ready icon is lit on the master unit’s LCD panel;

When the recycling of all the flash units is completed, the master units' charge lamp lights on.

1.6 Check the operation: Press the master unit's test flash button (charge lamp). The slave unit flash will fire. If no, check that it is placed within the operation range.

1.7 Take the picture: Set the camera and take the picture, in the same way as with normal flash shooting. If a standard flash exposure was obtained, the flash exposure confirmation lamp lights up (blue) for 2 sec.

2. Autoflash Shooting Using Multiple Slave Unit





When you need more flash output you can increase the number of slave units and fire them as a single flash. To add slave units, use the same procedure as “Autoflash Shooting Using One Slave Unit”. Set A, B or C as the firing group. The flash will not fire if it is set to D or E. When the number of the slave units is increased, automatic control is performed to fire all flashes at the same flash output and ensure that the total flash output results in standard exposure.

Using Fully Automatic Wireless Flash

Flash exposure compensation and other settings set on the Phottix Laso transmitter (master unit) will be automatically set in the flash (slave). You don't need to operate the slave unit.

1. Flash Exposure Compensation

In the same way as normal exposure compensation, you can set exposure compensation for flash. The flash exposure compensation amount can be set up to ± 3 stops in 1/3-stop increments.

1. Press function button 4 until **MENU 1** is displayed.
2. Press function button 2 corresponding to ,  is displayed and flash compensation amount is highlighted.
3. Set the flash compensation amount: turn  to set the flash compensation amount, and press  button.
4. "0.3" indicates 1/3 stops, and "0.7" indicates 2/3 stops
5. To cancel flash exposure compensation, return the compensation amount to "±0".



Note:



1. By setting C.Fn13, you can choose to set the flash compensation amount by

turning <  > only, without operating function button 2 .

2. If the camera's exposure compensation is set to 1/2-stop increments, flash exposure compensation will be up to ± 3 stops in 1/2-stop increments.

3. FEB

With FEB (Flash Exposure Bracketing) function, you can take three shots while automatically changing the flash output. The settable range is up to ± 3 stops in 1/3-stop increments.

1. Press function button 4 until **MENU 1** is displayed.
2. Press function button 3 corresponding to **FEB**,  1 is displayed and the FEB level display is highlighted.
3. Set the FEB level: turn <  > to set FEB level and press <  > button.
4. "0.3" indicates 1/3 stops, and "0.7" indicates 2/3 stops.
5. When used together with flash exposure, FEB shooting is performed based on the flash exposure compensation amount.





Note:

- 1) You can choose whether or not to cancel FEB automatically after shooting three shots with FEB by setting C.Fn03.
- 2) You can change the order of FEB sequence by setting C.Fn04.

6. High-speed Sync

With the high-speed sync function, the flash can synchronize with all shutter speeds. This is convenient when you want to use aperture-priority AE for fill-flash portraits of a subject.

High-speed sync function is available for EOS digital cameras since 2012 only.

1. Press function button 4 until **MENU 4** is displayed.
2. Press function button 2 corresponding to **SYNC**,  will be displayed on the screen. Check if  is lit in the view finder.
3. Press function button 2 will disable .



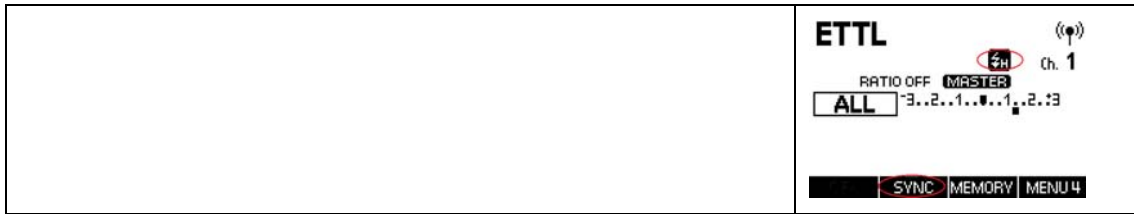

4. FEL: FE Lock

FE (Flash Exposure) lock locks the correct flash exposure setting for any part of the scene. Perform FE lock by operating the camera. For the operation, see the camera and flash's instruction manual.

5. About Master Units

You can use two or more master units (master units + slave units = maximum of 16 units). By preparing multiple cameras with master units attached, you can shoot by changing cameras while keeping the same lighting (slave units).

Note that when using two or more master units, the color of the <LINK> lamp varies depending on the order in which the power was turned on. The first master (main master) is green and the second subsequent masters (sub masters) are orange.

ETTL: Wireless Multiple Flash Shooting with Flash Ratio

1. Autoflash shooting with Two Slave Groups

You can divide the slave units into two firing groups A and B, and adjust the lighting balance (flash ratio). The exposure is controlled automatically so that the total flash output of firing group A and group B results in the standard exposure.

1.1 Set the firing group of the slave units

Operate and set the slave unit group one by one. Set one unit to <A>, and set the other to . For the slave unit settings, see the flash or receiver's instruction manual.

1.2 Set the ratio mode: Press the master unit's function button 4 to display **MENU 2**. Press function button corresponding to **RATIO** to set to <RATIO A:B >.

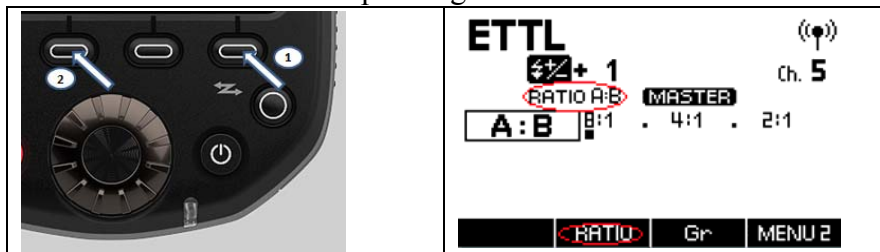

1.3 Set the flash ratio: Press function button 3 corresponding to **Gr**, and again press the function button 3 while it is corresponding to **A:B 1/2**, turn <⊙> to set the flash ratio and press <⊙> button. Press function button 4 corresponding to **↵** to return to shooting-ready state.

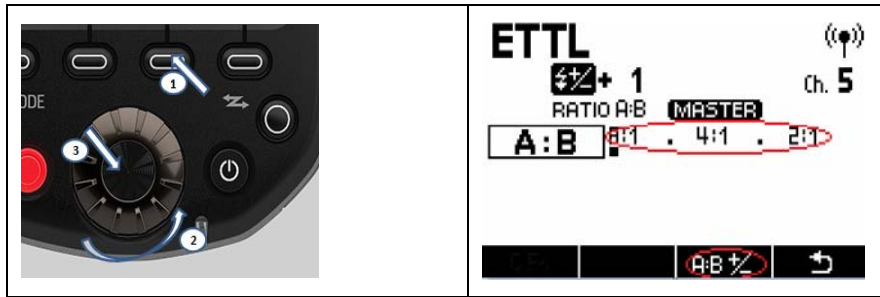

1.5 Take the picture: the slave unit flash at the set flash ratio.



2. Autoflash Shooting with Three Slave Groups

You can add firing group C to firing groups A and B. C is convenient to set lighting so as to eliminate the subject's shadow. The setting method is the same as "Autoflash Shooting with Two Slave Groups"

At the ratio mode **RATIO A:B:C**, group A and B can be set by flash ratio. Group C is independent with its flash output level assigned by the camera.

2.1 Set a flash as firing group C: For the slave unit settings, see the flash's instruction manual.

2.2 Press the master unit's function button 4 to display **MENU 2**. Press function button 2 corresponding to **RATIO** to set to **<RATIO A:B:C >**

2.3 Set flash exposure compensation as required

Press function button 3 corresponding to **Gr**, turn **<Gr >** and press function button 3 corresponding to **C 1/2**. Again turn **<Gr >** and press **<Gr >** button to set the flash exposure compensation amount for group C.

Press function button 4 corresponding to **Return** to return to shooting-ready state.



3. Slave Group Control

If you need more flash output or wish to perform more sophisticated lighting, you can increase the number of slave units. Simply set an additional slave unit to the firing group (A, B or C) whose flash output you want to increase. You can increase the number of slave units up to 15 units in total.

For example, if you set a firing group with three slave units to A, the three units are controlled as a single firing group A with a large flash output.

M: Wireless Multiple Flash Shooting with Manual Flash Output

When doing multiple flash shooting with manual flash output, you can shoot with a different flash output setting for each slave unit (firing group). Set all the parameters on the master unit.

1. Press <Mode> button to set the flash mode to <M>

2. Set the number of firing group:

While **MENU 1** is displayed, press function button 2 corresponding to **RATIO** to set the groups to fire. The setting changes as follows each time pressing the button: ALL (RATIO OFF) → A/B (RATIO A:B)

→ A/B/C (RATIO A:B:C) .

3. Select a firing group: Press function button 3 corresponding to **Gr**, turn <⊙> to select the group for which you want to set the flash output, and press <⊙> button.

4. Set the flash output: Press function button 3 corresponding to < *± >, turn <⊙> to set the flash output and press <⊙> button. Repeat step 3 and 4 to set the output of all groups

5. Take the picture: each group fires at the set flash output

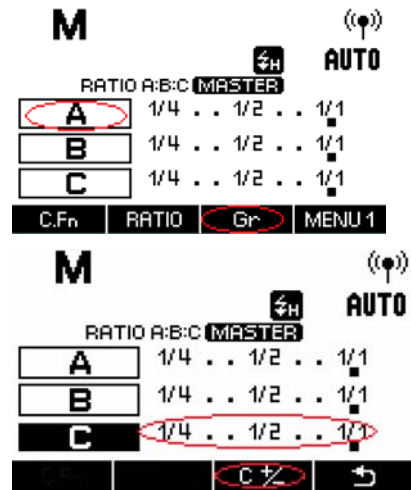

MULTI: Stroboscopic Flash



Stroboscopic flash is an advanced manual flash shooting method. When using stroboscopic flash with a slow shutter speed, you can shoot multiple successive movements within a single picture, similar to stop-motion pictures. In stroboscopic flash, set the flash output, number of flashes, and flash frequency (number of flashes per second = HZ).

1. Press master unit's <MODE> button to set the flash mode to <MULTI>.

2. Set the number of firing groups and flash output for each group by referring to manual flash on the preceding page.

3. Set the flash frequency and number of flashes: when **MENU 1** is displayed, press function button 2 corresponding to **MULTI**, turn <⊙> to set the number of flashes and press <⊙> button;



Press function button 3 corresponding to **Hz**, turn <  > to set the flash frequency and press <  > button.

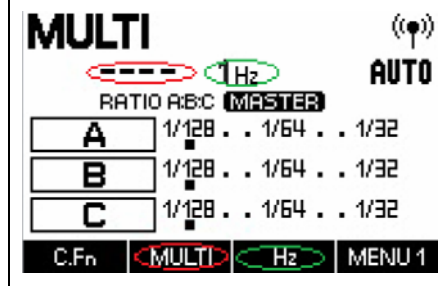

Note

1. High speed sync function is not available when using stroboscopic flash.
2. Phottix Laso receiver does not support MULTI mode. When master unit is set to MULTI mode, the slave unit that uses Phottix Laso receiver does not fire.

Gr: Shooting with a Different Flash Mode for Each Group

When using an EOS digital camera released since 2012, you can shoot with a different flash mode set for each firing group, with up to 5 groups (A/B/C/D/E) .

The flash modes that can be set are ①E-TTL II /E-TTL autoflash, ②Manual flash and ③Auto external flash metering. When the flash mode is ① or ③, exposure is controlled to result in standard exposure for the main subject as a single group. The function is for advanced users.

1. Set the flash mode to <Gr>
Press <MODE> button on master unit to set the flash mode to <Gr>.
2. Set the firing group on the slave units

Operate and set the slave units one by one, and set a firing group (A/B/C/D/E) for all the slave units. For slave unit settings, see the flash or wireless receiver’s instruction manual.

3. Set the flash mode
Set the flash mode of each firing group by operating the master unit.
While **MENU 1** is displayed, press function button corresponding to **Gr** and turn <  > to set the group.

Press function button 2 corresponding to <*Mode> to select the flash mode of the selected group from <ETTL>, <M>and<Ext.A>.

To turn off the firing of the selected group, press function button 1 corresponding to **ON/OFF** and set it to <OFF>.

Repeat step 3 to set the flash mode.



4. Set the flash output or flash exposure compensation amount

While a firing group is selected, press function button 3 corresponding to <*±>, turn <⊙> to set the flash function corresponding to the flash mode, and press <⊙> button.

When using the <M> mode, set the flash output. When using the <E TTL> or <Ext.A>, set the flash exposure compensation amount as required.

Press function button corresponding to **1/2** when **MENU 1** is displayed, flash exposure compensation can be set for all groups.

Repeat step 4 to set the flash function of all groups.

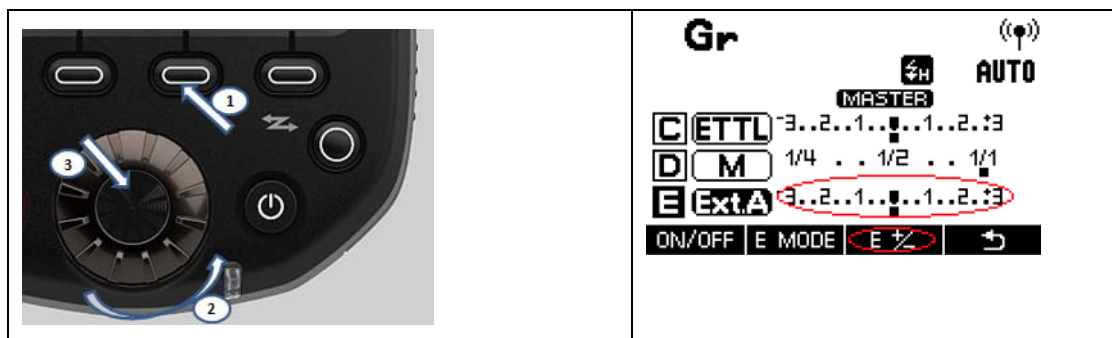

5. Take the picture: each slave units fires in the flash mode set for each group.

Linked Shooting

Linked shooting is a function that automatically releases the shutter of a slave unit camera by linking it to a master unit camera. You can shoot with linked shooting for up to 16 units, including both master units and slave units. This is convenient when you want to shoot a subject from multiple angles at the same time.

To shoot with linked shooting, attach Phottix Laso transmitter, and canon flash that supports radio transmission wireless shooting or the canon ST-E3-RT Speedlite transmitter to the camera.



Linked shooting setting

1. Set to linked shooting mode

Press and hold linked shooting button until **LINKED SHOT** is displayed. Linked shooting mode's "Slave unit" is set; Press linked shooting button again to set "Master unit" of linked shooting mode.

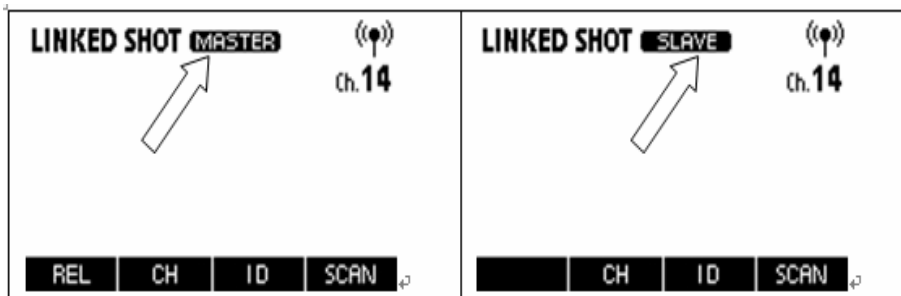

2. Set the channel and ID

Set the channel by pressing function button 2 corresponding to **CH**, turn <⊙> to select the channel and press <⊙> button. You also choose to scan the radio reception status and set the master unit's transmission channel automatically or manually. For operation please refer to preceding wireless setting section.

Set wireless radio ID: press function button 3 corresponding to **ID**, turn <⊙> to select the digit to be set, and press <⊙> button. Again turn <⊙> to select a number from 0-9, and press the <⊙> button. Repeat the procedure to set the 4 ID digits one by one. Press function button 4 for corresponding to **↶** to return to the shooting-ready state.

3. Set the camera's shooting functions

4. Set all the transmitters

Repeat steps 1to3 and set all the transmitters to "Master unit" or "Slave unit" in the

linked shooting mode.

Set the Speedlites used in linked shooting in the same way.

When pressing linked shooting button to change the setting of a unit from “Slave unit” to “Master Unit”, the other transmitter (or Speedlites) that were set to “Master Unit” until then automatically switch to “Slave unit”.

5. Set up the slave unit cameras

Check that the <LINK> lamp of the slave unit lights green and place all the slave units within master unit’s the radio transmission range.

6. Take the pictures

Check that the <LINK> lamp of the master unit lights green and take the picture. The slave unit cameras are released in coordination with the master unit camera. After shooting with linked shooting, the <LINK> lamp of slave unit briefly lights orange.

7. Press function button 1 corresponding to **REL** on master unit will release the shutter of all slave unit cameras.

Noted:

1. When using the linked shooting function, the slave unit camera might need a shutter release cable(available separately) depending on the camera models.

3) EOS digital cameras since 2012 do not need to use shutter release cable.

4) EOS cameras before 2012, which are compatible with E-TTL II/E-TTL autoflash and come with N3 type remote terminal EOS, shutter release cable will be needed for linked shooting.

2. Shooting with manual focus is recommended for the slave unit cameras. If focus cannot be achieved with autofocus, linked shooting is not possible with the corresponding slave unit cameras.

V. Setting Transmitter Functions with Camera Operations

Note: When the camera’s shooting mode is set to fully automatic mode or an Image Zone mode, the operations below are not available. Please set the camera’s shooting mode to **P/Tv/Av/M/B** (Creative Zone mode) .

When using EOS digital camera released since 2007, you can set flash functions, transmitter functions or Custom Functions from the camera’s menu screen. For the camera operations, see the camera’s instruction manual. (Examples displayed are EOS 6D menu screen)

1. Phottix Laso Transmitter Function Setting

1. Select [External Speedlite control] or [Flash control].
 2. Select [Flash function settings] or [External flash function setting], the screen changes to the (external) flash function settings screen
 3. Select an item and set the function. (The setting screen varies depending on the camera)

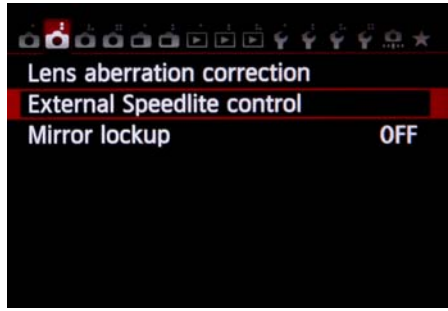

2. Settings Available in [Flash function settings]

Flash firing	[Enable]	Enable wireless flash shooting
	[Disable]	Disable wireless flash shooting
E-TTL II flash metering	[Evaluative]	For normal exposures
	[Average]	Flash exposure will be averaged for the entire scene metered by the camera. Flash exposure compensation may be necessary depending on the scene. This setting is for advanced users.
Flash synchronization speed in AV mode	You can set the flash sync speed when performing wireless flash shooting in aperture-priority AE(Av) mode	
Flash mode	E-TTL II / Manual flash / MULTI flash / Individual group control	
Shutter synchronization	1st curtain / High-speed synchronization	
Flash exposure compensation	Users can set the exposure compensation for flash up to ±3 stops in 1/3-stop increments.	
FEB	Users can take three shots while automatically changing the flash output, with settable range up to ±3 stops in	

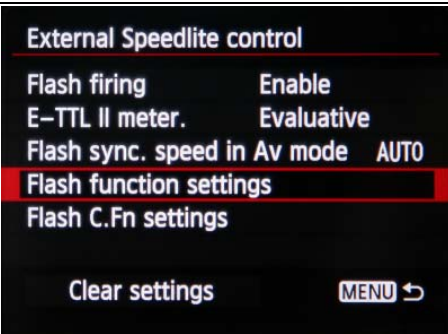

	1/3-stop increments.	
Wireless flash functions (setting)	Radio transmission wireless flash shooting is set automatically.(*For EOS digital camera released since 2012).	
Clear Speedlite function settings	You can restore Phottix Laso transmitter to their default settings	

3. Transmitter Custom Function Settings

The displayed contents vary depending on the camera. If C.Fn-20 and 22 are not displayed, set them by operating the transmitter.

<ol style="list-style-type: none"> 1. Select[Flash C.Fn settings]or[External flash C.Fn setting] 2. Select the Custom Function number and set function 3. To clear all the Custom Function settings, select [Clear all Speedlite C.Fn’s] or [Clear ext. flash C.Fn set] in step 1. <p>Note: [Auto power off] under [Flash C.Fn settings] is corresponding to Phottix Lasotransmitter’s C.Fn 01: Auto IDLE. You can enable or disable Auto IDLE for Phottix Lasotransmitter by operating the Camera menu option.</p>	
--	---





VI. Customizing the Transmitter

Phottix Laso Transmitter supports Custom function (C.Fn) and Personal Function (P.Fn) setting. You can customize the transmitter features to suit your shooting preferences with custom functions and personal functions. Note that the personal functions are customizable functions unique to the Phottix Laso transmitter.









Note: When the camera’s shooting mode is set to fully automatic mode or an Image











Zone mode, the operations below are not available. Please set the camera's shooting mode to **P/Tv/Av/M/B** (Creative Zone mode).

1. C.Fn: Setting custom functions

1. Press function button 4 until **C.Fn** is displayed on the screen.
2. Press and hold the function button 1 corresponding to **C.Fn** until Custom Function screen is displayed.
3. Turn <  > to select an item (number) to set, and press <  > button to display the setting.
4. Turn <  > to select the setting, and press <  > button to confirm the selection
5. Press function button 4 corresponding to **↩** to return to previous state.
6. To restore all the default settings of custom function, press function button 2 corresponding to **CLEAR**, and press function button 1 corresponding to **OK**. To cancel the operation, press function button 4 corresponding to **CANCEL**.

Custom Functions Chart



Custom Function No.	Functions	Setting No.	Setting and descriptions
C.Fn 01	 : Auto IDLE	0: ON	Enable Auto IDLE when the Phottix Laso transmitter is not operated for 5min.,
		1: OFF	Disable Auto IDLE when the Phottix Laso transmitter is not operated for 5min.,
C.Fn 02	 MODELING Modeling flash	0: 	Press the camera's depth-of-field preview button to fire the modeling flash
		1: 	Press Phottix Laso transmitter's test flash button to fire the modeling flash
		2:  / 	Press the camera's depth-of-field preview button or Phottix Laso transmitter's test flash button to fire the modeling flash
		3: OFF	Disable the modeling flash
C.Fn 03	 AUTO CANCEL : FEB auto cancel	0: ON	Enable: Set to automatically cancel FEB after shooting three shots with FEB
		1: OFF	Disable: Set not to automatically cancel FEB after shooting three shots with FEB
C.Fn 04	 : FEB sequence	0: 0 → - → +	Set the order of FEB sequence as following: 0: Standard exposure - : Decreased exposure (darker) + : Increased exposure (brighter)



		1: -->0->+	Set the order of FEB sequence as following: - : Decreased exposure (darker) 0: Standard exposure + : Increased exposure (brighter)
C.Fn 07	 TEST: Test firing with autoflash	0: 1/32	Set the flash output as 1/32 when firing the test flash in E-TTL II /E-TTL autoflash
		1: 1/1	Set the flash output as 1/1 when firing the test flash in E-TTL II /E-TTL autoflash
C.Fn 13	 : Flash exposure metering setting	0:  + 	Turn<  >and press button function corresponding to  to perform flash exposure compensation
		1: 	Turn<  >directly to perform flash exposure compensation without pressing  button.
C.Fn 20	 : Beep	0: OFF	Disable beep to sound on Phottix Laso transmitter when the slave unit is fully charged
		1: ON	Enable a beep to sound on Phottix Laso transmitter when the slave unit is fully charged
C.Fn 22	 : LCD panel illumination	0: 12sec	When a button or dial is operated, the LCD panel illumination go on for 12 sec.
		1: OFF	Disable LCD panel illumination
		2: ON	When a button or dial is operated, the LCD panel illuminates and keeps always on.

2. P.Fn: Setting personal functions

1. When Custom Function screen is displayed, press function button 1 corresponding to **P.Fn** to display Personal Function screen.
2. Set the personal function in the same way as step 3 and 4 for the custom function.
3. To restore all the default setting of personal function, set it in the same way as step 6 for custom function.

Personal Functions Chart

Personal Function No.	Functions	Setting No.	Setting and descriptions
P.Fn 01	 : LCD panel		You can adjust the contrast of the LCD panel in 5 levels.

	display contrast		
P.Fn 03	 :LCD panel illumination color: Master	0: GREEN	When the Phottix Laso transmitter is set as master unit (radio transmission wireless shooting, linked shooting) , select green as color of the LCD panel illumination.
		1: ORANGE	When the Phottix Laso transmitter is set as master unit (radio transmission wireless shooting, linked shooting) , select orange as color of the LCD panel illumination.
P.Fn 04	 :LCD panel illumination color: Slave	0: ORANGE	When the Phottix Laso transmitter is set as slave unit (linked shooting) , select orange as color of the LCD panel illumination.
		1: GREEN	When the Phottix Laso transmitter is set as slave unit (linked shooting) , select green as color of the LCD panel illumination.
P.Fn 08	 : AF assist beam	0: ENABLE	Enable the AF assist beam
		1: DISABLE	Disable the AF assist beam

USB port

The firmware of Phottix Laso transmitter can be upgraded via the USB port, so as to adjust its parameter and extend its compatibility with cameras to come in the future.

1.1 Connect the USB cable to the computer and the other end of the USB cable to Phottix Laso transmitter's USB port. A mobile device icon will be displayed on the computer when successfully connected.

1.2 Double click to start the upgrade software. The upgrade software can be used to check version info, and upgrade the Base software, RF software and Icon.

Click "Version" icon, the current version information of the connected Phottix Laso transmitter will be displayed in the software window.

Click "Base software" icon, locate and double click on the FDS file from the pop-out window. Then it starts loading the new firmware.

Click "RF software" icon, locate and double click on the RFC file from the pop-out window. Then it starts loading the new firmware.

Click "Icon" icon, locate and double click on the FIF file from the pop-out window.

Then it starts loading the new firmware.

1.3 The status of the upgrade will be displayed in the process bar. When completed, an “Updata OK” will be displayed at the bottom of the upgrade software window, and a “Download OK” will be displayed on the transmitter’s LCD screen. Upon completion, disconnect the USB cable and restart the Phottix Laso transmitter.

Note:

Please ensure stable power supply when attempting to upgrade the Phottix Laso transmitter.. Loss of computer power during the upgrade process could fail the upgrading.

VII. Trouble Shooting Guide

1. Power does not turn on

1.1 Make sure the batteries are installed in correct orientation.

1.2 Check battery contacts are in good contact and that the batteries are sufficient with power.

2.The Slave unit doesn’t fire

2.1 Check if the slave unit supports radio transmission wireless flash

2.2 Set the slave unit to .

2.3 Set the transmission channels and wireless radio IDs of the master unit and slave unit to the same numbers.

2.4 Check if the slave unit is within the transmission range of the master unit.

2.5 If using Phottix Laso receiver, please refer to the receiver’s manual instruction to check the operation.

3.  is displayed

Set the shutter speed 1 stop slower than the flash sync speed.

VIII · Technical Specification

Type	On-camera wireless flash trigger
Compatible cameras	EOS type-A camera compatible with E-TTL II/E-TTL autoflash
Exposure control system	E-TTL II /E-TTL auto, manual flash, stroboscopic flash, auto external flash metering (only when the flash mode is set to <Gr>) .
Frequency	2405 – 2475Hz
Modulation system	Primary modulation: OQPSK, secondary modulation: DS-SS

Channel	Auto, Ch.1-15	
Wireless radio ID	0000-9999	
Slave unit control	Up to 5 groups (A/B/C/D/E) , up to 15 units	
Transmission distance	100m+	
Flash ratio control	1:8-1:1-8:1, 1/2-stop increments	
Flash exposure compensation	±3 stops in 1/3- or 1/2- stop increments	
FEB	±3 stops in 1/3- or 1/2- stop increments (when used with flash exposure compensation)	
FE lock	Press the camera's <M-Fn> 、 <FEL> or <*> button	
HSS function	Provided, high speed sync is possible only with EOS digital cameras released since 2012	
Manual flash	1/1-1/128 (1/3-stop increments)	
Stroboscopic flash	Provided(1 - 500 Hz)	
Slave battery check	On the master unit's LCD panel, the <⚡> icon lights, the slave unit's AF assist beam emitter blinks and charge the lamp lights	
Flash exposure confirmation	Flash exposure confirmation lamp lights	
Modeling flash	Fired with camera's depth-of-field preview button	
Linked Shooting	Provided	
Custom functions	8	
Personal functions	4	
AF assist light	Peak wavelength	650nm
	Optical power	< 5mW
	Spot diameter at 1m	Injecting distance 1m: L-335mm W-326mm (angle of the sector at approx.20°)
	Operating temperature	-10°C ~ +40°C
Power source	2 x AA alkaline batteries or AA NI-MH batteries	
Power saving	Auto Idle if not operated for 5 min.	
Standby current	70mA	
Static current	≤250uA	
Dimension	(L×W×H) : (84.1×68.3×58.5) mm	
Weight(approx.)	118 g (Excluding the batteries)	

Please note: Product specifications and external design are subject to change without further notice.