

# FCC Radio Test Report

## FCC ID: P96WF76RL

### Class II Change

**Report No.** : TB-FCC137983  
**Applicant** : HUIZHOU TCL KING HIGH FREQUENCY ELECTRONIC CO., LTD

#### Equipment Under Test (EUT)

**EUT Name** : WIFI MODULE  
**Model No.** : WF76RL1500 1  
**Serial No.** : N/A  
**Brand Name** : TCL  
**Receipt Date** : 2013-07-29  
**Test Date** : 2013-07-30 to 2013-12-27  
**Issue Date** : 2014-01-03  
**Standards** : FCC Part 15, Subpart C (15.247:2011)/  
Canada RSS-210: 2010, Canada RSS-Gen: 2010  
**Test Method** : ANSI C63.4:2003  
**Conclusions** : **PASS**

In the configuration tested, the EUT complied with the standards specified above,  
The EUT technically complies with the FCC and IC requirements

**Test/Witness Engineer** : *IWAN SU*

**Approved & Authorized** : *Ray Lai.*

This report details the results of the testing carried out on one sample. The results contained in this test report do not relate to other samples of the same product. The manufacturer should ensure that all products in series production are in conformity with the product sample detailed in the report.

---

---

## Contents

<b>CONTENTS</b> .....	<b>2</b>
<b>1. GENERAL INFORMATION ABOUT EUT</b> .....	<b>4</b>
1.1 Client Information.....	4
1.2 General Description of EUT (Equipment Under Test) .....	4
1.3 Block Diagram Showing the Configuration of System Tested.....	5
1.4 Description of Support Units .....	5
1.5 Description of Test Mode.....	5
1.6 Description of Test Software Setting .....	6
1.7 Test Facility.....	7
<b>2. TEST SUMMARY</b> .....	<b>7</b>
<b>3. CONDUCTED EMISSION TEST</b> .....	<b>9</b>
3.1 Test Standard and Limit.....	9
3.2 Test Setup.....	9
3.3 Test Procedure.....	9
3.4 Test Equipment Used.....	10
3.5 EUT Operating Mode .....	10
3.6 Test Data.....	10
<b>4. RADIATED EMISSION TEST</b> .....	<b>13</b>
4.1 Test Standard and Limit.....	13
4.2 Test Setup.....	14
4.3 Test Procedure.....	15
4.4 EUT Operating Condition .....	15
4.5 Test Equipment.....	16
4.6 Test Data.....	16
<b>5. RESTRICTED BANDS REQUIREMENT</b> .....	<b>45</b>
5.1 Test Standard and Limit.....	45
5.2 Test Setup.....	45
5.3 Test Procedure.....	45
5.4 EUT Operating Condition .....	45
5.5 Test Equipment.....	46
5.6 Test Data.....	46
<b>6. BANDWIDTH TEST</b> .....	<b>55</b>
6.1 Test Standard and Limit.....	55
6.2 Test Setup.....	55
6.3 Test Procedure.....	55
6.4 EUT Operating Condition .....	55
6.5 Test Equipment.....	55
6.6 Test Data.....	56

---

---

<b>7.</b>	<b>PEAK OUTPUT POWER TEST.....</b>	<b>64</b>
	7.1 Test Standard and Limit.....	64
	7.2 Test Setup.....	64
	7.3 Test Procedure.....	64
	7.4 EUT Operating Condition .....	64
	7.5 Test Equipment.....	64
	7.6 Test Data.....	64
<b>8.</b>	<b>POWER SPECTRAL DENSITY TEST .....</b>	<b>73</b>
	8.1 Test Standard and Limit.....	73
	8.2 Test Setup.....	73
	8.3 Test Procedure.....	73
	8.4 EUT Operating Condition .....	73
	8.5 Test Equipment.....	73
	8.6 Test Data.....	73
<b>9.</b>	<b>ANTENNA CONDUCTED SPURIOUS EMISSION .....</b>	<b>82</b>
	9.1 Test Standard and Limit.....	82
	9.2 Test Setup.....	82
	9.3 Test Procedure.....	82
	9.4 EUT Operating Condition .....	83
	9.5 Test Equipment.....	83
	9.6 Test Data.....	83
<b>10.</b>	<b>ANTENNA REQUIREMENT.....</b>	<b>96</b>
	10.1 Standard Requirement.....	96
	10.2 Antenna Connected Construction .....	96
	10.2 Result.....	96

## 1. General Information about EUT

### 1.1 Client Information

<b>Applicant</b>	:	HUIZHOU TCL KING HIGH FREQUENCY ELECTRONIC CO., LTD
<b>Address</b>	:	HUA YU RD., NO.75, ZHONGKAI HIGH-TECH DEVELOPMENT AREA, HUIZHOU, CHINA
<b>Manufacturer</b>	:	HUIZHOU TCL KING HIGH FREQUENCY ELECTRONIC CO., LTD
<b>Address</b>	:	HUA YU RD., NO.75, ZHONGKAI HIGH-TECH DEVELOPMENT AREA, HUIZHOU, CHINA

### 1.2 General Description of EUT (Equipment Under Test)

<b>EUT Name</b>	:	WIFI MODULE
<b>Models No.</b>	:	WF76RL1500 1
<b>Model Difference</b>	:	N/A
<b>Product Description</b>	:	Operation Frequency: 802.11b/g/n(HT20): 2412MHz~2462MHz 802.11n(HT40):2422MHz~2452MHz
	:	Number of Channel: 802.11b/g/n(HT20):11 channels 802.11n(HT40):7 channels <i>see note(3)</i>
	:	Out Power: 802.11b: 17.09 dBm 802.11g: 16.92 dBm 802.11n (HT20): 15.76 dBm 802.11n(HT40): 14.75 dBm
	:	Antenna Gain: 2 dBi (Integrated Antenna)
	:	Modulation Type: 802.11b: DSSS (CCK, QPSK, BPSK) 802.11g: OFDM 802.11n: OFDM
	:	Bit Rate of Transmitter: 802.11b:11/5.5/2/1 Mbps 802.11g:54/48/36/24/18/12/9/6 Mbps 802.11n:up to 150Mbps
<b>Power Supply</b>	:	DC Voltage supplied from PC System.
<b>Power Rating</b>	:	DC 3.3V by USB adapter from PC System.
<b>Connecting I/O Port(S)</b>	:	Please refer to the User's Manual

**Note:**

- (1) This Test Report is FCC Part 15.247 for 802.11b/g/n, the test procedure follows the FCC KDB 558074 D01 DTS Meas Guidance v03r01.
- (2) For a more detailed features description, please refer to the manufacturer's specifications or

the User's Manual.

(3) Antenna information provided by the applicant.

(4) Channel List:

CH 01~CH 11 for 802.11b/g/n(20M) and CH 03~CH 09 for 802.11n(40M)

Channel	Frequency (MHz)	Channel	Frequency (MHz)	Channel	Frequency (MHz)
01	2412	05	2432	09	2452
02	2417	06	2437	10	2457
03	2422	07	2442	11	2462
04	2427	08	2447		

### 1.3 Block Diagram Showing the Configuration of System Tested

TX Mode

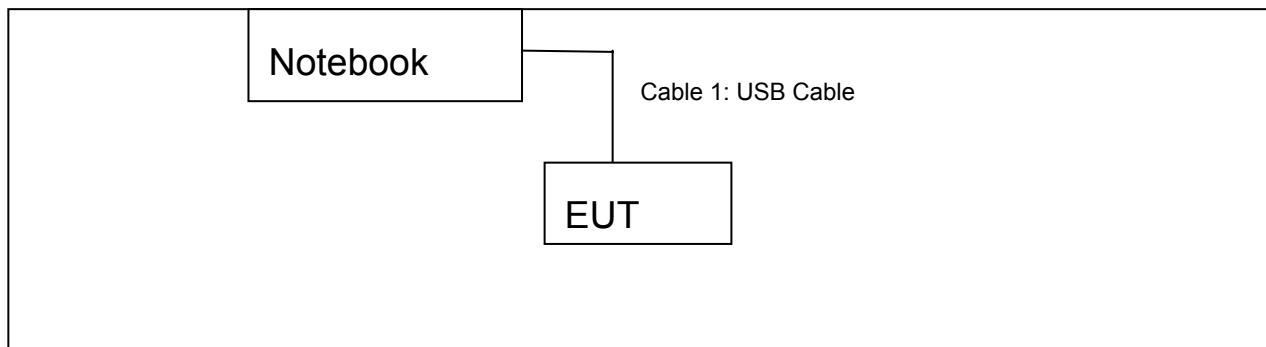

### 1.4 Description of Support Units

Name	Model	S/N	Manufacturer	Used “√”
Notebook	T60P	42W3244	Lenovo	√
Cable Information				
Number	Shielded Type	Ferrite Core	Length	Note
Cable 1	NO	NO	0.1M	Provided by the applicant

### 1.5 Description of Test Mode

To investigate the maximum EMI emission characteristics generates from EUT, the test system was pre-scanning tested base on the consideration of following EUT operation mode or test configuration mode which possible have effect on EMI emission level. Each of these EUT operation mode(s) or test configuration mode(s) mentioned follow was evaluated respectively.

For Conducted Test

Final Test Mode	Description
Mode 1	TX Mode
Mode 2	RX Mode

For Radiated Test	
Final Test Mode	Description
Mode 3	TX Mode B Mode Channel 01/06/11
Mode 4	TX Mode G Mode Channel 01/06/11
Mode 5	TX Mode N(HT20) Mode Channel 01/06/11
Mode 6	TX Mode N(HT40) Mode Channel 03/06/09
Mode 7	RX Mode B Mode Channel 01/06/11
Mode 8	RX Mode G Mode Channel 01/06/11
Mode 9	RX Mode N(HT20) Mode Channel 01/06/11
Mode 10	RX Mode N(HT40) Mode Channel 03/06/09

**Note:**

- (1) For all test, we have verified the construction and function in typical operation. And all the test modes were carried out with the EUT in transmitting operation in maximum power with all kinds of data rate.

According to ANSI C63.4 standards, the measurements are performed at the highest, middle, lowest available channels, and the worst case data rate as follows:

- 802.11b Mode: CCK (1 Mbps)
- 802.11g Mode: OFDM (6 Mbps)
- 802.11n (HT20) Mode: OFDM (6.5 Mbps)
- 802.11n (HT40) Mode: OFDM (13.0 Mbps)

- (2) During the testing procedure, the continuously transmitting with the maximum power mode was programmed by the customer.
- (3) The EUT is considered a mobile unit; in normal use it was positioned on X-plane. The worst case was found positioned on X-plane. Therefore only the test data of this X-plane was used for radiated emission measurement test.

## 1.6 Description of Test Software Setting

During testing channel & Power controlling software provided by the customer was used to control the operating channel as well as the output power level. The RF output power selection is for the setting of RF output power expected by the customer and is going to be fixed on the firmware of the final end product power parameters of WLAN.

---

---

<b>Test Software Version</b>	<b>Test Program: MT7601USB.exe</b>		
Frequency	2412 MHz	2437 MHz	2462 MHz
IEEE 802.11b DSSS	15	15	15
IEEE 802.11g OFDM	0C	0C	0C
IEEE 802.11n (HT20)	09	09	09
IEEE 802.11n (HT40)	08	08	08

## 1.7 Test Facility

The tests were performed at:

Shenzhen Certification Technology Service Co., Ltd

2F, Building B, East Area of Nanchang Second Industrial Zone, Gushu 2nd Road, Bao'an District, Shenzhen, 518126, China

Tel: 86-755-86375552 Fax: 86-755-26736857

At the time of testing, the Laboratory is accredited. It is listed in the United States of American Federal Communications Commission (FCC), and the registration number is 197647. And IC registration number is 8258A-1.

The test report was fulfilled by Shenzhen Toby Technology Co., Ltd. Shenzhen Toby Technology Co., Ltd. is assumed full responsibility for the accuracy and completeness of these measurements results.

## 2. Test Summary

FCC Part 15 Subpart C(15.247)/RSS-210: 2010				
Standard Section		Test Item	Judgment	Remark
FCC	IC			
15.203	/	Antenna Requirement	PASS	N/A
15.207	RSS-GEN 7.2.4	Conducted Emission	PASS	N/A
15.205	RSS-GEN 7.2.2	Restricted Bands	PASS	N/A
15.247(a)(2)	RSS-210 A.8.2(a)	6dB Bandwidth	PASS	N/A
15.247(b)	RSS-210 A.8.4(4)	Peak Output Power	PASS	N/A
15.247(e)	RSS-210 A.8.2(b)	Power Spectral Density	PASS	N/A
15.247(d)	RSS-210 Annex 8 (A8.5)	Transmitter Radiated Spurious Emission	PASS	N/A
/	RSS-210 Annex 8 (A8.5)	Receiver Radiated Spurious Emission	PASS	N/A
15.247(d)	RSS-210 Annex 8 (A8.5)	Antenna Conducted Spurious Emission	PASS	N/A

**Note:** "/" for no requirement for this test item.  
N/A is an abbreviation for Not Applicable.



### 3. Conducted Emission Test

#### 3.1 Test Standard and Limit

##### 3.1.1 Test Standard

FCC Part 15.207/ RSS-GEN7.2.4

##### 3.1.2 Test Limit

**Conducted Emission Test Limit**

Frequency	Maximum RF Line Voltage (dB $\mu$ V)	
	Quasi-peak Level	Average Level
150kHz~500kHz	66 ~ 56 *	56 ~ 46 *
500kHz~5MHz	56	46
5MHz~30MHz	60	50

Notes:

- (1) \*Decreasing linearly with logarithm of the frequency.
- (2) The lower limit shall apply at the transition frequencies.
- (3) The limit decrease in line with the logarithm of the frequency in the range of 0.15 to 0.50MHz.

#### 3.2 Test Setup

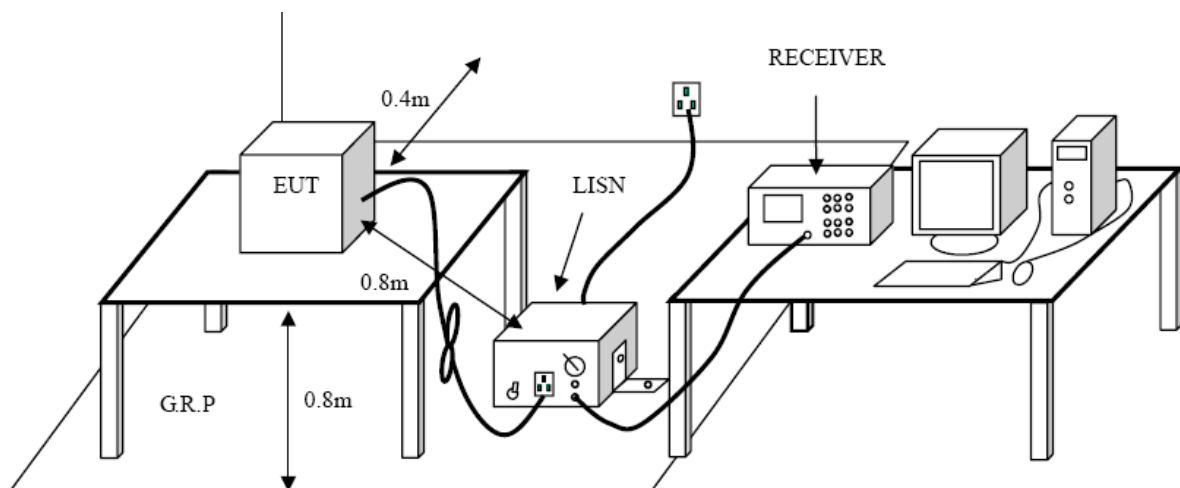

#### 3.3 Test Procedure

The EUT was placed 0.8 meters from the horizontal ground plane with EUT being connected to the power mains through a line impedance stabilization network (LISN). All other support equipments powered from additional LISN(s). The LISN provide 50 Ohm/ 50uH of coupling impedance for the measuring instrument.

Interconnecting cables that hang closer than 40 cm to the ground plane shall be folded back and forth in the center forming a bundle 30 to 40 cm long.

I/O cables that are not connected to a peripheral shall be bundled in the center. The end of the cable may be terminated, if required, using the correct terminating impedance. The overall length shall not exceed 1 m.

LISN at least 80 cm from nearest part of EUT chassis.

The bandwidth of EMI test receiver is set at 9kHz, and the test frequency band is from 0.15MHz to 30MHz.

### 3.4 Test Equipment Used

Description	Manufacturer	Model No.	Serial No.	Cal. Date	Cal. Due Date
EMI Test Receiver	ROHDE& SCHWARZ	ESCI	100321	2012-08-07	2013-08-06
50ΩCoaxial Switch	Anritsu	MP59B	X10321	2012-08-07	2013-08-06
L.I.S.N	Rohde & Schwarz	ENV216	101131	2012-08-07	2013-08-06
L.I.S.N	SCHWARZBECK	NNBL 8226-2	8226-2/164	2012-08-07	2013-08-06

### 3.5 EUT Operating Mode

Please refer to the description of test mode.

### 3.6 Test Data

Please see the next page.

E.U.T :	WIFI MODULE	Model Name :	WF76RL1500 1
Temperature :	23°C	Relative Humidity :	51 %
Terminal	Line		
Test Voltage :	AC 120 V / 60Hz		
Test Mode :	TX Mode (B Mode)		

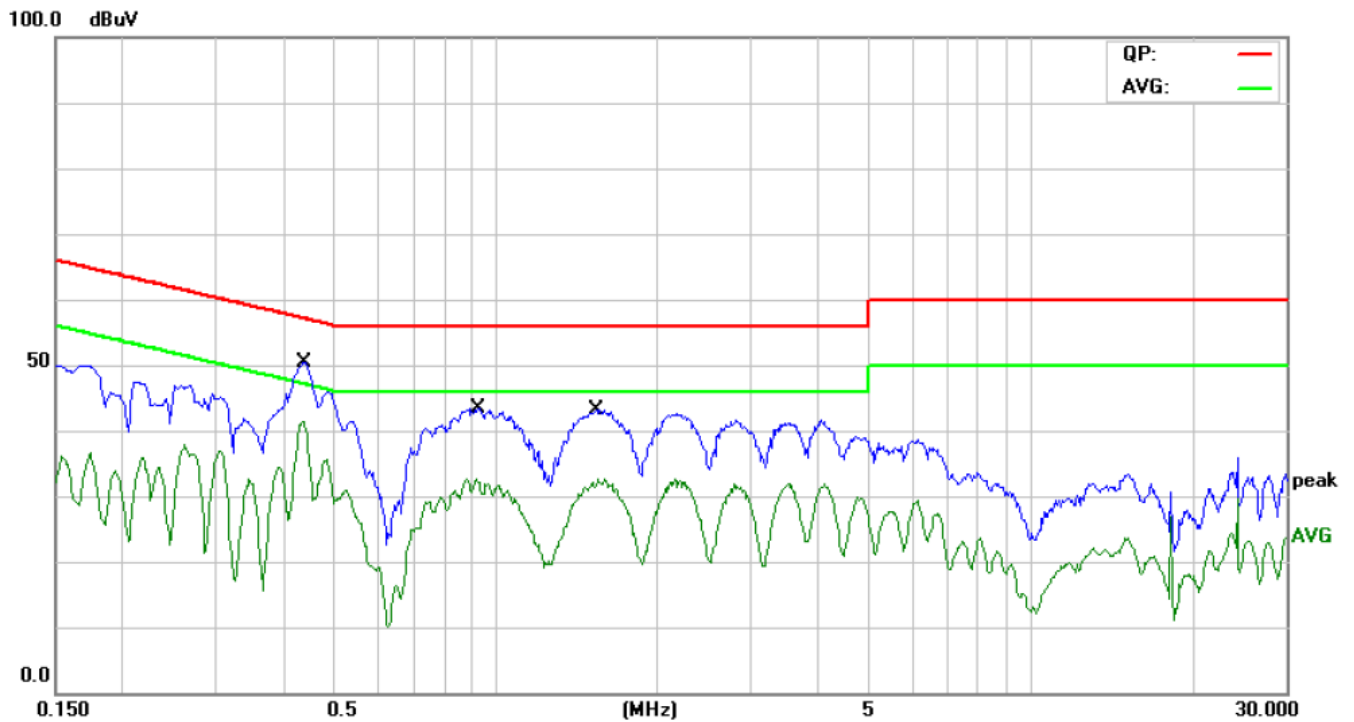

No.	Mk.	Freq.	Reading Level	Correct Factor	Measurement	Limit	Over	Detector	Comment
		MHz	dBuV	dB	dBuV	dBuV	dB		
1	*	0.4380	39.27	9.56	48.83	57.10	-8.27	QP	
2		0.4380	27.55	9.56	37.11	47.10	-9.99	AVG	
3		0.9260	29.35	9.36	38.71	56.00	-17.29	QP	
4		0.9260	19.42	9.36	28.78	46.00	-17.22	AVG	
5		1.5420	27.78	9.32	37.10	56.00	-18.90	QP	
6		1.5420	19.52	9.32	28.84	46.00	-17.16	AVG	

E.U.T :	WIFI MODULE	Model Name :	WF76RL1500 1
Temperature :	23°C	Relative Humidity :	51 %
Terminal	Neutral		
Test Voltage :	AC 120 V / 60Hz		
Test Mode :	TX Mode (B Mode)		

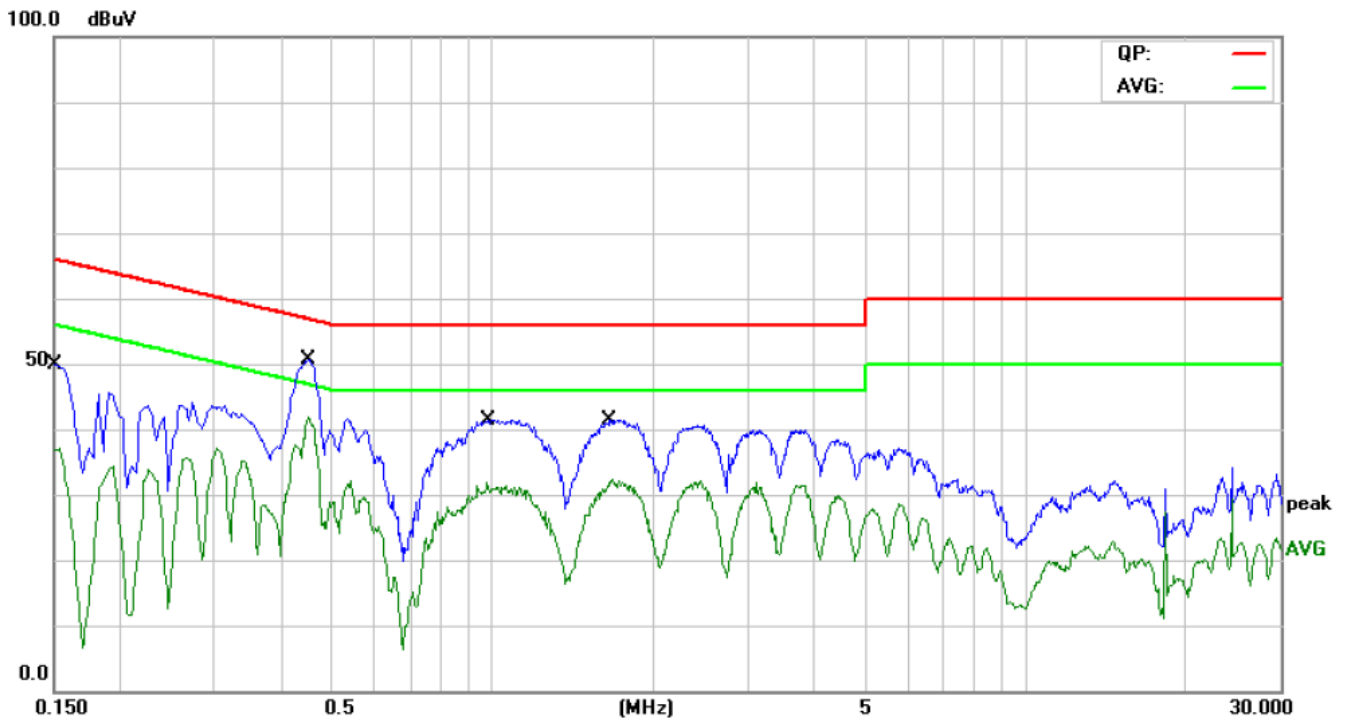

No.	Mk.	Freq. MHz	Reading Level dBuV	Correct Factor dB	Measure- ment dBuV	Limit dBuV	Over dB	Detector	Comment
1		0.1500	36.29	10.93	47.22	65.99	-18.77	QP	
2		0.1500	25.14	10.93	36.07	55.99	-19.92	AVG	
3		0.4500	40.07	9.57	49.64	56.87	-7.23	QP	
4	*	0.4500	32.50	9.57	42.07	46.87	-4.80	AVG	
5		0.9820	30.10	9.34	39.44	56.00	-16.56	QP	
6		0.9820	21.16	9.34	30.50	46.00	-15.50	AVG	
7		1.6540	28.98	9.35	38.33	56.00	-17.67	QP	
8		1.6540	21.08	9.35	30.43	46.00	-15.57	AVG	

## 4. Radiated Emission Test

### 4.1 Test Standard and Limit

#### 4.1.1 Test Standard

FCC Part 15.209/ RSS-210 Annex 8 (A8.5)

#### 4.1.2 Test Limit

**Radiated Emission Limits (9kHz~1000MHz)**

Frequency (MHz)	Field Strength (microvolt/meter)	Measurement Distance (meters)
0.009~0.490	2400/F(KHz)	300
0.490~1.705	24000/F(KHz)	30
1.705~30.0	30	30
30~88	100	3
88~216	150	3
216~960	200	3
Above 960	500	3

**Radiated Emission Limit (Above 1000MHz)**

Frequency (MHz)	Class A (dBuV/m)(at 3 M)		Class B (dBuV/m)(at 3 M)	
	Peak	Average	Peak	Average
Above 1000	80	60	74	54

**Note:**

- (1) The tighter limit applies at the band edges.
- (2) Emission Level(dBuV/m)=20log Emission Level(uV/m)

### 4.2 Test Setup

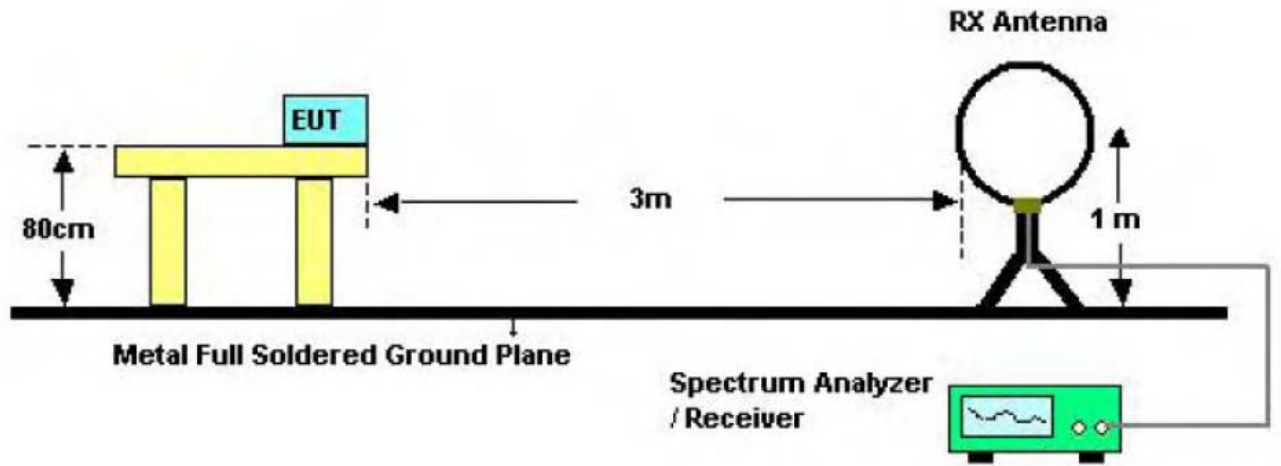

Bellow 30MHz Test Setup

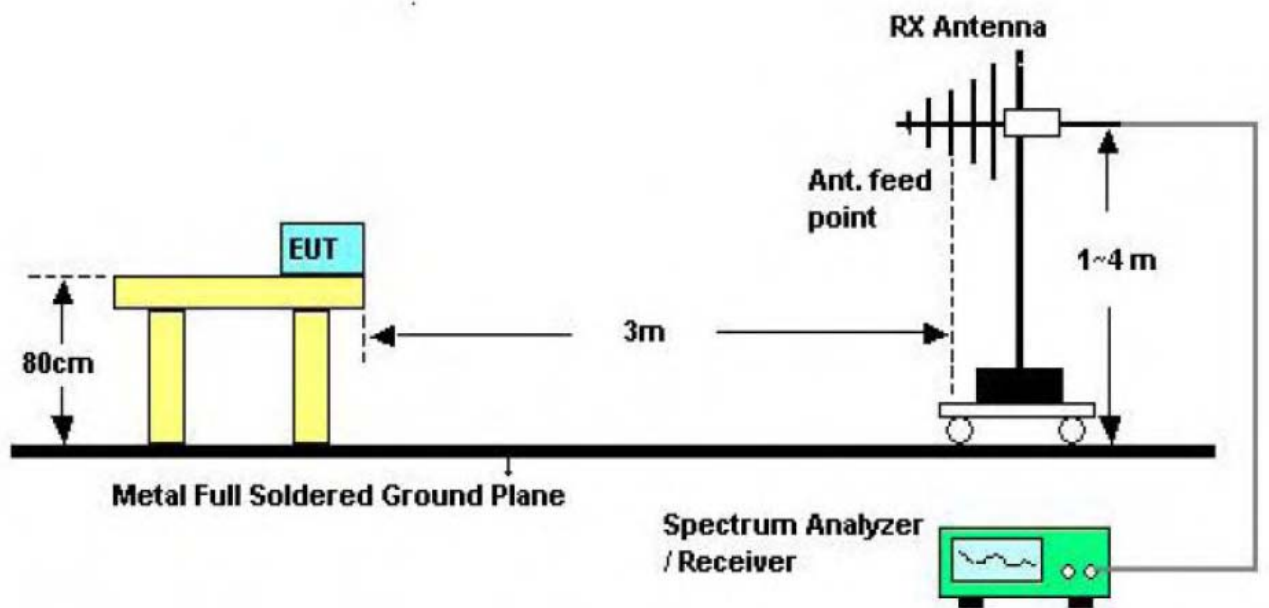

Bellow 1000MHz Test Setup

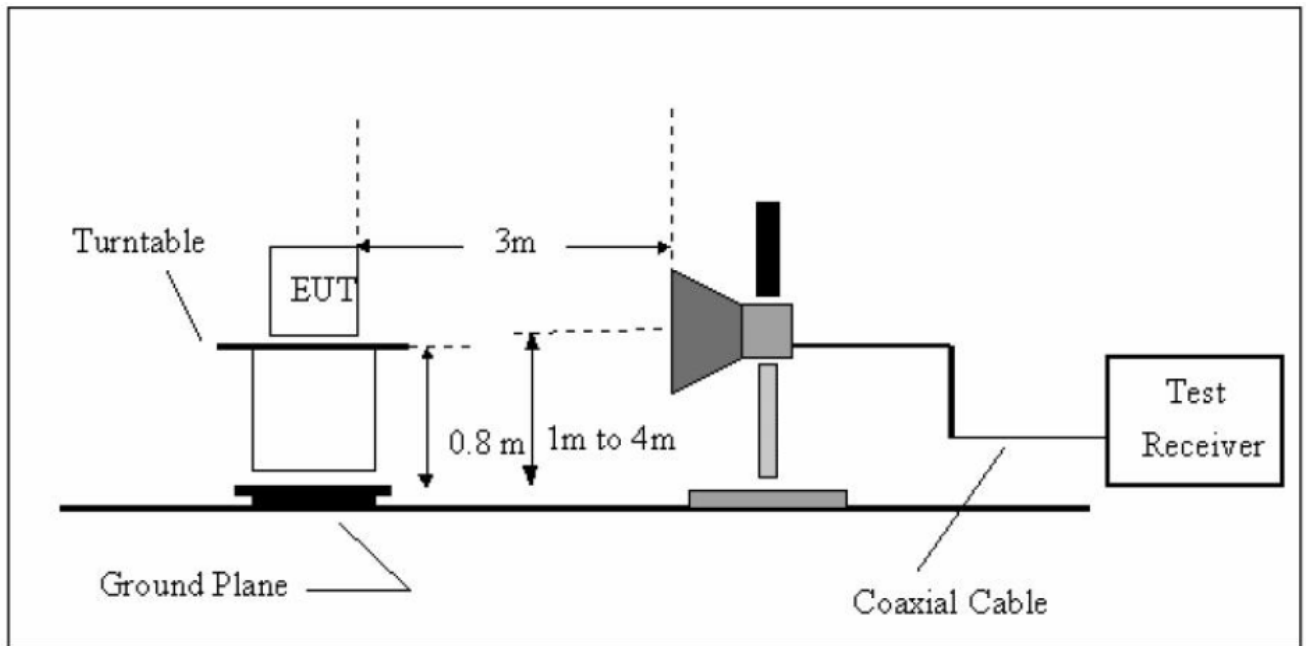

Above 1GHz Test Setup

#### 4.3 Test Procedure

- (1) The measuring distance of 3m shall be used for measurements at frequency up to 1GHz and above 1 GHz. The EUT was placed on a rotating 0.8m high above ground, the table was rotated 360 degrees to determine the position of the highest radiation.
- (2) The Test antenna shall vary between 1m and 4m, Both Horizontal and Vertical antenna are set to make measurement.
- (3) The initial step in collecting conducted emission data is a spectrum analyzer peak detector mode pre-scanning the measurement frequency range. Significant peaks are then marked and then Quasi Peak detector mode re-measured.
- (4) If the Peak Mode measured value compliance with and lower than Quasi Peak Mode Limit Bellow 1 GHz, the EUT shall be deemed to meet QP Limits and then no additional QP Mode measurement performed. But the Peak Value and average value both need to comply with applicable limit above 1 GHz.
- (5) For the actual test configuration, please see the test setup photo.

#### 4.4 EUT Operating Condition

The Equipment Under Test was set to Continual Transmitting in maximum power.

#### 4.5 Test Equipment

<b>Description</b>	<b>Manufacturer</b>	<b>Model No.</b>	<b>Serial No.</b>	<b>Cal. Date</b>	<b>Cal. Due Date</b>
Spectrum Analyzer	ROHDE& SCHWARZ	FSP30	DE25181	2013-12-30	2014-12-29
Spectrum Analyzer	Agilent	E4407B	MY49510055	2013-12-30	2014-12-29
EMI Test Receiver	ROHDE& SCHWARZ	ESCI	101165	2013-12-30	2014-12-29
Bilog Antenna	SCHWARZBECK	VULB9168	9168-438	2013-02-12	2014-02-11
Horn Antenna	SCHWARZBECK	BBHA 9120D	BBHA9120D	2013-02-12	2014-02-11
Horn Antenna	SCHWARZBECK	BBHA 9170	BBHA9170D	2013-02-12	2014-02-11
Active Loop Antenna	Beijing Daze	ZN30900A	SEL0097	2013-02-12	2014-02-11
Pre-amplifier	SCHWARZBECK	BBV9743	9743-019	2013-10-30	2014-10-29
Pre-amplifier	Quietek	AP-180C	CHM-0602012	2013-10-30	2014-10-29

#### 4.6 Test Data

Please see the next page.



Operation Mode:	802.11b	Test Date :	Dec. 26, 2013
	TX 2412MHz		
Frequency Range:	30~1000MHz	Temperature :	22 °C
Measured Distance:	3m	Humidity :	65 %
Ant. Pol.	Horizontal		
Test Voltage:	DC 5V		

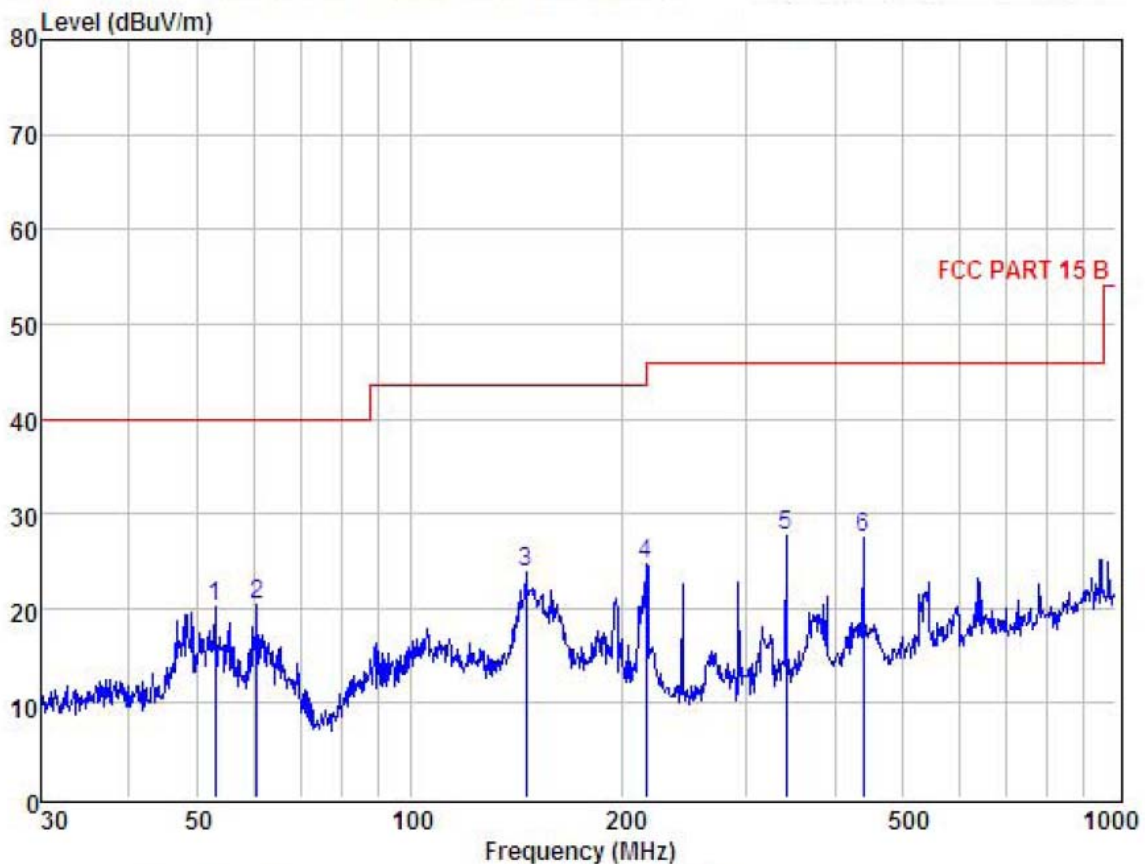

Item	Freq MHz	Read Level dBuV	Antenna Factor dB	Preamp Factor dB	Cable Loss dB	Level dBuV	Limit dBuV	Margin dBuV	Remark
1	52.95	34.52	13.22	27.84	0.22	20.12	40.00	-19.88	Peak
2	60.70	35.55	12.36	27.65	0.17	20.43	40.00	-19.57	Peak
3	145.86	36.48	13.90	26.91	0.44	23.91	43.50	-19.59	Peak
4	216.02	40.67	10.41	27.05	0.55	24.58	46.00	-21.42	Peak
5	340.78	40.40	13.68	27.25	0.75	27.58	46.00	-18.42	Peak
6	438.66	38.51	15.68	27.48	0.78	27.49	46.00	-18.51	Peak

Remark: Level = Read Level + Antenna Factor - Preamp Factor + Cable Loss

Operation Mode:	802.11b	Test Date :	Dec. 26, 2013
	TX 2412MHz		
Frequency Range:	30~1000MHz	Temperature :	22 °C
Measured Distance:	3m	Humidity :	65 %
Ant. Pol.	Vertical		
Test Voltage:	DC 5V		

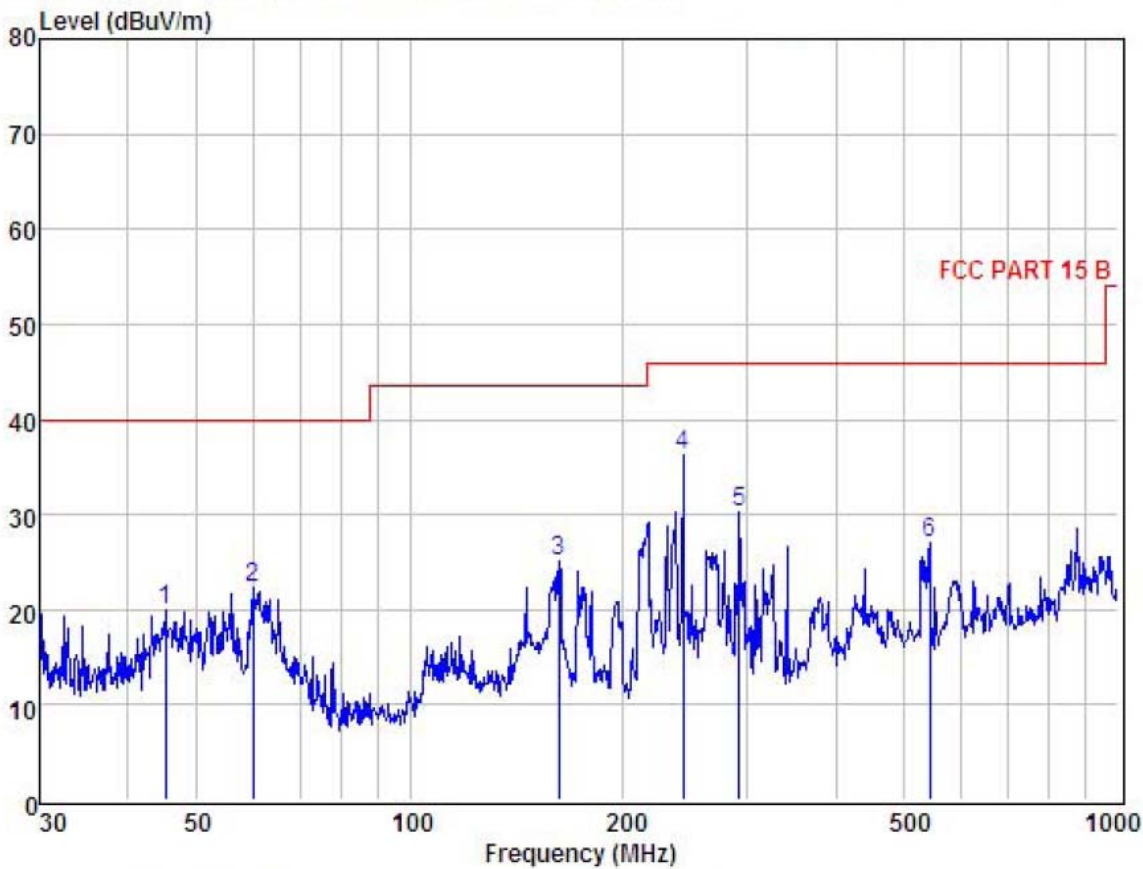

Item	Freq MHz	Read Level dBuV	Antenna Factor dB	Preamp Factor dB	Cable Loss dB	Level dBuV	Limit dBuV	Margin dBuV	Remark
1	45.22	34.03	13.65	27.82	0.05	19.91	40.00	-20.09	Peak
2	60.07	37.28	12.75	27.87	0.24	22.40	40.00	-17.60	Peak
3	162.61	37.65	13.95	26.91	0.45	25.14	43.50	-18.36	Peak
4	243.38	51.34	11.50	27.10	0.45	36.19	46.00	-9.81	Peak
5	292.06	44.17	12.62	27.17	0.67	30.29	46.00	-15.71	Peak
6	543.27	36.60	17.26	27.69	0.86	27.03	46.00	-18.97	Peak

Remark: Level = Read Level + Antenna Factor - Preamp Factor + Cable Loss

Operation Mode:	802.11b	Test Date :	Dec. 26, 2013
	RX 2412MHz		
Frequency Range:	30~1000MHz	Temperature :	22 °C
Measured Distance:	3m	Humidity :	65 %
Ant. Pol.	Horizontal		
Test Voltage:	DC 5V		

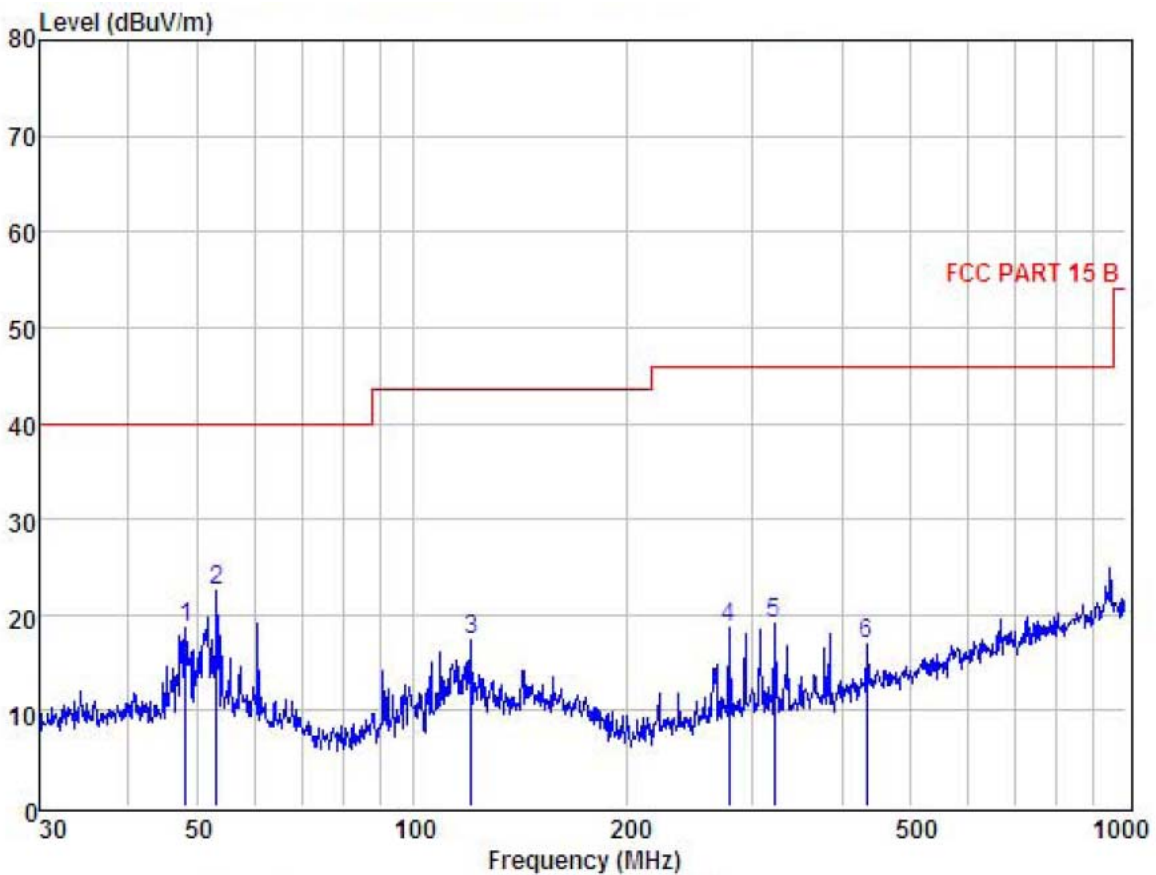

Item	Freq MHz	Read Level dBuV	Antenna Factor dB	Preamp Factor dB	Cable Loss dB	Level dBuV	Limit dBuV	Margin dBuV	Remark
1	48.16	32.70	13.59	27.82	0.09	18.56	40.00	-21.44	Peak
2	53.13	37.02	13.22	27.84	0.22	22.62	40.00	-17.38	Peak
3	120.70	31.60	12.24	26.88	0.40	17.36	43.50	-26.14	Peak
4	278.07	33.05	12.31	27.15	0.53	18.74	46.00	-27.26	Peak
5	321.06	32.61	13.33	27.22	0.47	19.19	46.00	-26.81	Peak
6	432.55	28.13	15.53	27.46	0.74	16.94	46.00	-29.06	Peak

Remark: Level = Read Level + Antenna Factor - Preamp Factor + Cable Loss

Operation Mode:	802.11b	Test Date :	Dec. 26, 2013
	RX 2412MHz		
Frequency Range:	30~1000MHz	Temperature :	22 °C
Measured Distance:	3m	Humidity :	65 %
Ant. Pol.	Vertical		
Test Voltage:	DC 5V		

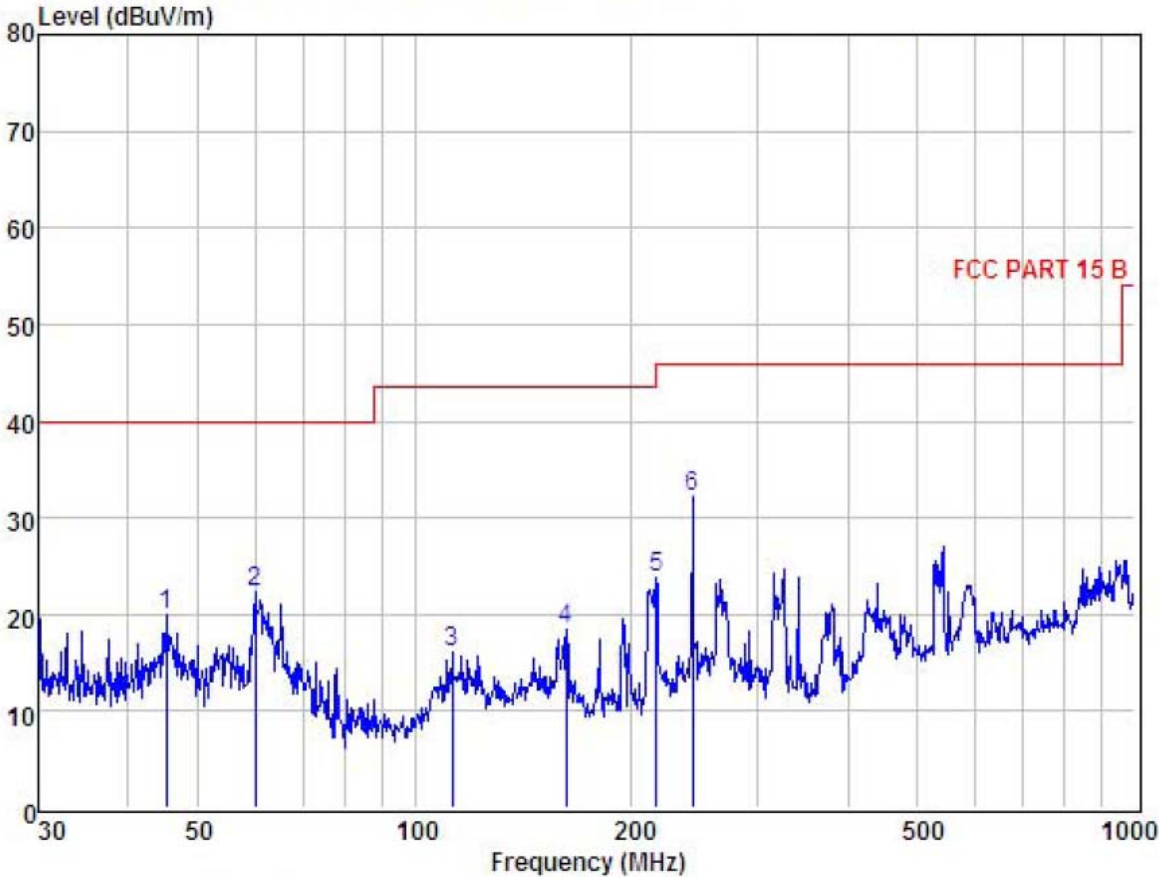

Item	Freq MHz	Read Level dBuV	Antenna Factor dB	Preamp Factor dB	Cable Loss dB	Level dBuV	Limit dBuV	Margin dBuV	Remark
1	45.22	34.03	13.65	27.82	0.05	19.91	40.00	-20.09	Peak
2	60.07	37.28	12.75	27.87	0.24	22.40	40.00	-17.60	Peak
3	112.92	30.94	11.50	26.87	0.47	16.04	43.50	-27.46	Peak
4	162.61	30.96	13.95	26.91	0.45	18.45	43.50	-25.05	Peak
5	216.78	39.77	10.41	27.05	0.59	23.72	46.00	-22.28	Peak
6	243.38	47.27	11.50	27.10	0.45	32.12	46.00	-13.88	Peak

Remark: Level = Read Level + Antenna Factor - Preamp Factor + Cable Loss

Operation Mode: 802.11b TX 2412MHz Test Date : Dec. 26, 2013  
 Frequency Range: 1-25GHz Temperature : 22 °C  
 Measured Distance: 3m Humidity : 65 %  
 Test Voltage: AC 120V/60Hz

Freq. (MHz)	Ant.Pol. H/V	Emission Level (dBuV/m)		Limit3m (dBuV/m)		Margin(dB)	
		PK	AV	PK	AV	PK	AV
4824.050	V	52.51	46.29	74.00	54.00	21.49	7.71
7236.110	V	45.20	40.07	74.00	54.00	28.80	13.93
--	V	--	--	74.00	54.00	--	--
--	V	--	--	74.00	54.00	--	--
--	V	--	--	74.00	54.00	--	--
4824.050	H	54.18	48.58	74.00	54.00	19.82	5.42
7236.110	H	47.29	42.91	74.00	54.00	26.71	11.09
--	H	--	--	74.00	54.00	--	--
--	H	--	--	74.00	54.00	--	--
--	H	--	--	74.00	54.00	--	--

**Other harmonics emissions are lower than 20dB below the allowable limit.**

- Note:**
- (1) All Readings are Peak Value and AV.
  - (2) Emission Level= Reading Level + Probe Factor +Cable Loss
  - (3) Data of measurement within this frequency range shown “ -- ” in the table above means the reading of emissions are attenuated more than 20dB below the permissible limits or the field strength is too small to be measured.

Operation Mode:	802.11b TX 2437MHz	Test Date :	Dec. 26, 2013
Frequency Range:	1-25GHz	Temperature :	22 °C
Measured Distance:	3m	Humidity :	65 %
Test Voltage:	AC 120V/60Hz		

Freq. (MHz)	Ant.Pol. H/V	Emission Level (dBuV/m)		Limit3m (dBuV/m)		Margin(dB)	
		PK	AV	PK	AV	PK	AV
4874.050	V	52.87	47.63	74.00	54.00	21.13	6.37
7311.200	V	45.90	40.11	74.00	54.00	28.10	13.89
--	V	--	--	74.00	54.00	--	--
--	V	--	--	74.00	54.00	--	--
--	V	--	--	74.00	54.00	--	--
4874.050	H	55.28	49.40	74.00	54.00	18.72	4.60
7311.200	H	48.39	42.87	74.00	54.00	25.61	11.13
--	H	--	--	74.00	54.00	--	--
--	H	--	--	74.00	54.00	--	--
--	H	--	--	74.00	54.00	--	--

**Other harmonics emissions are lower than 20dB below the allowable limit.**

- Note:**
- (1) All Readings are Peak Value and AV.
  - (2) Emission Level= Reading Level + Probe Factor +Cable Loss
  - (3) Data of measurement within this frequency range shown “ -- ” in the table above means the reading of emissions are attenuated more than 20dB below the permissible limits or the field strength is too small to be measured.

Operation Mode:	802.11b TX 2462MHz	Test Date :	Dec. 26, 2013
Frequency Range:	1-25GHz	Temperature :	22 °C
Measured Distance:	3m	Humidity :	65 %
Test Voltage:	AC 120V/60Hz		

Freq. (MHz)	Ant.Pol. H/V	Emission Level (dBuV/m)		Limit3m (dBuV/m)		Margin(dB)	
		PK	AV	PK	AV	PK	AV
4924.100	V	51.15	46.75	74.00	54.00	22.85	7.25
7386.150	V	46.05	39.52	74.00	54.00	27.95	14.48
--	V	--	--	74.00	54.00	--	--
--	V	--	--	74.00	54.00	--	--
--	V	--	--	74.00	54.00	--	--
4924.100	H	54.39	48.25	74.00	54.00	19.61	5.75
7386.150	H	47.50	41.62	74.00	54.00	26.50	12.38
--	H	--	--	74.00	54.00	--	--
--	H	--	--	74.00	54.00	--	--
--	H	--	--	74.00	54.00	--	--

**Other harmonics emissions are lower than 20dB below the allowable limit.**

**Note:**

- (1) All Readings are Peak Value and AV.
- (2) Emission Level= Reading Level + Probe Factor +Cable Loss
- (3) Data of measurement within this frequency range shown “ -- ” in the table above means the reading of emissions are attenuated more than 20dB below the permissible limits or the field strength is too small to be measured.

Operation Mode:	802.11g TX 2412MHz	Test Date :	Dec. 26, 2013
Frequency Range:	1-25GHz	Temperature :	22 °C
Measured Distance:	3m	Humidity :	65 %
Test Voltage:	AC 120V/60Hz		

Freq. (MHz)	Ant.Pol. H/V	Emission Level (dBuV/m)		Limit3m (dBuV/m)		Margin(dB)	
		PK	AV	PK	AV	PK	AV
4824.400	V	52.11	43.08	74.00	54.00	21.89	10.92
7236.650	V	45.60	38.18	74.00	54.00	28.40	15.82
--	V	--	--	74.00	54.00	--	--
--	V	--	--	74.00	54.00	--	--
--	V	--	--	74.00	54.00	--	--
4824.400	H	54.61	45.80	74.00	54.00	19.39	8.20
7236.650	H	47.67	39.01	74.00	54.00	26.39	14.99
--	H	--	--	74.00	54.00	--	--
--	H	--	--	74.00	54.00	--	--
--	H	--	--	74.00	54.00	--	--

**Other harmonics emissions are lower than 20dB below the allowable limit.**

- Note:**
- (1) All Readings are Peak Value and AV.
  - (2) Emission Level= Reading Level + Probe Factor +Cable Loss
  - (3) Data of measurement within this frequency range shown “ -- ” in the table above means the reading of emissions are attenuated more than 20dB below the permissible limits or the field strength is too small to be measured.



Operation Mode:	802.11g TX 2437MHz	Test Date :	Dec. 26, 2013
Frequency Range:	1-25GHz	Temperature :	22 °C
Measured Distance:	3m	Humidity :	65 %
Test Voltage:	AC 120V/60Hz		

Freq. (MHz)	Ant.Pol. H/V	Emission Level (dBuV/m)		Limit3m (dBuV/m)		Margin(dB)	
		PK	AV	PK	AV	PK	AV
4874.400	V	53.02	44.52	74.00	54.00	20.98	9.48
7313.600	V	46.30	39.08	74.00	54.00	27.70	14.92
--	V	--	--	74.00	54.00	--	--
--	V	--	--	74.00	54.00	--	--
--	V	--	--	74.00	54.00	--	--
4874.400	H	55.62	46.48	74.00	54.00	18.38	7.52
7313.600	H	48.57	39.60	74.00	54.00	25.43	14.40
--	H	--	--	74.00	54.00	--	--
--	H	--	--	74.00	54.00	--	--
--	H	--	--	74.00	54.00	--	--

**Other harmonics emissions are lower than 20dB below the allowable limit.**

- Note:**
- (1) All Readings are Peak Value and AV.
  - (2) Emission Level= Reading Level + Probe Factor +Cable Loss
  - (3) Data of measurement within this frequency range shown “ -- ” in the table above means the reading of emissions are attenuated more than 20dB below the permissible limits or the field strength is too small to be measured.

Operation Mode:	802.11g TX 2462MHz	Test Date :	Dec. 26, 2013
Frequency Range:	1-25GHz	Temperature :	22 °C
Measured Distance:	3m	Humidity :	65 %
Test Voltage:	AC 120V/60Hz		

Freq. (MHz)	Ant.Pol. H/V	Emission Level (dBuV/m)		Limit3m (dBuV/m)		Margin(dB)	
		PK	AV	PK	AV	PK	AV
4925.300	V	52.76	43.83	74.00	54.00	21.24	10.17
7387.800	V	47.50	36.69	74.00	54.00	36.69	17.31
--	V	--	--	74.00	54.00	--	--
--	V	--	--	74.00	54.00	--	--
--	V	--	--	74.00	54.00	--	--
4925.300	H	55.42	46.91	74.00	54.00	18.58	7.09
7387.800	H	48.34	39.57	74.00	54.00	25.66	14.43
--	H	--	--	74.00	54.00	--	--
--	H	--	--	74.00	54.00	--	--
--	H	--	--	74.00	54.00	--	--

**Other harmonics emissions are lower than 20dB below the allowable limit.**

**Note:**

- (1) All Readings are Peak Value and AV.
- (2) Emission Level= Reading Level + Probe Factor +Cable Loss
- (3) Data of measurement within this frequency range shown “ -- ” in the table above means the reading of emissions are attenuated more than 20dB below the permissible limits or the field strength is too small to be measured.

Operation Mode: 802.11n (HT20) TX 2412MHz Test Date : Dec. 26, 2013  
 Frequency Range: 1-25GHz Temperature : 22 °C  
 Measured Distance: 3m Humidity : 65 %  
 Test Voltage: AC 120V/60Hz

Freq. (MHz)	Ant.Pol. H/V	Emission Level (dBuV/m)		Limit3m (dBuV/m)		Margin(dB)	
		PK	AV	PK	AV	PK	AV
4825.120	V	52.08	43.31	74.00	54.00	21.92	10.69
7237.400	V	44.95	34.72	74.00	54.00	29.05	19.28
--	V	--	--	74.00	54.00	--	--
--	V	--	--	74.00	54.00	--	--
--	V	--	--	74.00	54.00	--	--
4825.120	H	54.34	44.10	74.00	54.00	19.66	9.90
7237.400	H	47.61	37.29	74.00	54.00	37.29	16.71
--	H	--	--	74.00	54.00	--	--
--	H	--	--	74.00	54.00	--	--
--	H	--	--	74.00	54.00	--	--

**Other harmonics emissions are lower than 20dB below the allowable limit.**

- Note:**
- (1) All Readings are Peak Value and AV.
  - (2) Emission Level= Reading Level + Probe Factor +Cable Loss
  - (3) Data of measurement within this frequency range shown “ -- ” in the table above means the reading of emissions are attenuated more than 20dB below the permissible limits or the field strength is too small to be measured.

Operation Mode: 802.11n (HT20) TX 2437MHz Test Date : Dec. 26, 2013  
 Frequency Range: 1-25GHz Temperature : 22 °C  
 Measured Distance: 3m Humidity : 65 %  
 Test Voltage: AC 120V/60Hz

Freq. (MHz)	Ant.Pol. H/V	Emission Level (dBuV/m)		Limit3m (dBuV/m)		Margin(dB)	
		PK	AV	PK	AV	PK	AV
4926.100	V	52.87	42.09	74.00	54.00	21.13	11.91
7312.060	V	45.88	35.47	74.00	54.00	28.12	18.53
--	V	--	--	74.00	54.00	--	--
--	V	--	--	74.00	54.00	--	--
--	V	--	--	74.00	54.00	--	--
4926.100	H	54.61	44.86	74.00	54.00	19.39	9.14
7312.060	H	48.37	38.75	74.00	54.00	25.63	15.25
--	H	--	--	74.00	54.00	--	--
--	H	--	--	74.00	54.00	--	--
--	H	--	--	74.00	54.00	--	--

**Other harmonics emissions are lower than 20dB below the allowable limit.**

- Note:**
- (1) All Readings are Peak Value and AV.
  - (2) Emission Level= Reading Level + Probe Factor +Cable Loss
  - (3) Data of measurement within this frequency range shown “ -- ” in the table above means the reading of emissions are attenuated more than 20dB below the permissible limits or the field strength is too small to be measured.

Operation Mode: 802.11n (HT20) TX 2462MHz Test Date : Dec. 26, 2013  
 Frequency Range: 1-25GHz Temperature : 22 °C  
 Measured Distance: 3m Humidity : 65 %  
 Test Voltage: AC 120V/60Hz

Freq. (MHz)	Ant.Pol. H/V	Emission Level (dBuV/m)		Limit3m (dBuV/m)		Margin(dB)	
		PK	AV	PK	AV	PK	AV
4926.100	V	52.05	42.71	74.00	54.00	21.95	11.29
7387.120	V	45.30	35.69	74.00	54.00	28.70	18.31
--	V	--	--	74.00	54.00	--	--
--	V	--	--	74.00	54.00	--	--
--	V	--	--	74.00	54.00	--	--
4926.100	H	54.62	44.78	74.00	54.00	19.38	9.22
7387.120	H	47.92	37.49	74.00	54.00	26.08	16.51
--	H	--	--	74.00	54.00	--	--
--	H	--	--	74.00	54.00	--	--
--	H	--	--	74.00	54.00	--	--

**Other harmonics emissions are lower than 20dB below the allowable limit.**

- Note:**
- (1) All Readings are Peak Value and AV.
  - (2) Emission Level= Reading Level + Probe Factor +Cable Loss
  - (3) Data of measurement within this frequency range shown “ -- ” in the table above means the reading of emissions are attenuated more than 20dB below the permissible limits or the field strength is too small to be measured.

Operation Mode: 802.11n (HT40) TX 2422MHz Test Date : Dec. 26, 2013  
 Frequency Range: 1-25GHz Temperature : 22 °C  
 Measured Distance: 3m Humidity : 65 %  
 Test Voltage: AC 120V/60Hz

Freq. (MHz)	Ant.Pol. H/V	Emission Level (dBUV/m)		Limit3m (dBUV/m)		Margin(dB)	
		PK	AV	PK	AV	PK	AV
4846.080	V	50.79	41.52	74.00	54.00	23.21	12.48
7267.110	V	44.51	36.05	74.00	54.00	29.49	17.95
--	V	--	--	74.00	54.00	--	--
--	V	--	--	74.00	54.00	--	--
--	V	--	--	74.00	54.00	--	--
4846.080	H	52.14	42.17	74.00	54.00	21.86	11.83
7267.110	H	45.21	36.12	74.00	54.00	28.79	17.88
--	H	--	--	74.00	54.00	--	--
--	H	--	--	74.00	54.00	--	--
--	H	--	--	74.00	54.00	--	--

**Other harmonics emissions are lower than 20dB below the allowable limit.**

- Note:**
- (1) All Readings are Peak Value and AV.
  - (2) Emission Level= Reading Level + Probe Factor +Cable Loss
  - (3) Data of measurement within this frequency range shown “ -- ” in the table above means the reading of emissions are attenuated more than 20dB below the permissible limits or the field strength is too small to be measured.

Operation Mode: 802.11n (HT40) TX 2437MHz Test Date : Dec. 26, 2013  
 Frequency Range: 1-25GHz Temperature : 22 °C  
 Measured Distance: 3m Humidity : 65 %  
 Test Voltage: AC 120V/60Hz

Freq. (MHz)	Ant.Pol. H/V	Emission Level (dBuV/m)		Limit3m (dBuV/m)		Margin(dB)	
		PK	AV	PK	AV	PK	AV
4876.100	V	51.22	42.04	74.00	54.00	22.78	11.96
7313.120	V	43.82	33.69	74.00	54.00	30.18	20.31
--	V	--	--	74.00	54.00	--	--
--	V	--	--	74.00	54.00	--	--
--	V	--	--	74.00	54.00	--	--
4876.100	H	53.47	43.64	74.00	54.00	20.53	10.36
7313.120	H	45.81	35.62	74.00	54.00	28.19	18.38
--	H	--	--	74.00	54.00	--	--
--	H	--	--	74.00	54.00	--	--
--	H	--	--	74.00	54.00	--	--

**Other harmonics emissions are lower than 20dB below the allowable limit.**

- Note:**
- (1) All Readings are Peak Value and AV.
  - (2) Emission Level= Reading Level + Probe Factor +Cable Loss
  - (3) Data of measurement within this frequency range shown “ -- ” in the table above means the reading of emissions are attenuated more than 20dB below the permissible limits or the field strength is too small to be measured.

Operation Mode: 802.11n (HT40) TX 2452MHz Test Date : Dec. 26, 2013  
 Frequency Range: 1-25GHz Temperature : 22 °C  
 Measured Distance: 3m Humidity : 65 %  
 Test Voltage: AC 120V/60Hz

Freq. (MHz)	Ant.Pol. H/V	Emission Level (dBuV/m)		Limit3m (dBuV/m)		Margin(dB)	
		PK	AV	PK	AV	PK	AV
4905.110	V	51.52	41.79	74.00	54.00	22.48	12.21
7357.200	V	43.60	34.81	74.00	54.00	30.40	19.19
--	V	--	--	74.00	54.00	--	--
--	V	--	--	74.00	54.00	--	--
--	V	--	--	74.00	54.00	--	--
4905.110	H	53.82	43.73	74.00	54.00	20.18	10.27
7357.200	H	45.49	35.71	74.00	54.00	28.51	18.29
--	H	--	--	74.00	54.00	--	--
--	H	--	--	74.00	54.00	--	--
--	H	--	--	74.00	54.00	--	--

**Other harmonics emissions are lower than 20dB below the allowable limit.**

- Note:**
- (1) All Readings are Peak Value and AV.
  - (2) Emission Level= Reading Level + Probe Factor +Cable Loss
  - (3) Data of measurement within this frequency range shown “ -- ” in the table above means the reading of emissions are attenuated more than 20dB below the permissible limits or the field strength is too small to be measured.



Operation Mode: 802.11b      Test Date : Dec. 26, 2013  
                          RX 2412MHz  
 Frequency Range: 1-25GHz      Temperature : 22 °C  
 Measured Distance: 3m      Humidity : 65 %  
 Test Voltage: AC 120V/60Hz

Freq. (MHz)	Ant.Pol. H/V	Emission Level (dBUV/m)		Limit3m (dBUV/m)		Margin(dB)	
		PK	AV	PK	AV	PK	AV
3215.760	V	45.19	40.67	74.00	54.00	28.81	13.33
--	V	--	--	74.00	54.00	--	--
--	V	--	--	74.00	54.00	--	--
--	V	--	--	74.00	54.00	--	--
--	V	--	--	74.00	54.00	--	--
3215.760	H	47.80	42.54	74.00	54.00	26.20	11.46
--	H	--	--	74.00	54.00	--	--
--	H	--	--	74.00	54.00	--	--
--	H	--	--	74.00	54.00	--	--
--	H	--	--	74.00	54.00	--	--

**Other harmonics emissions are lower than 20dB below the allowable limit.**

- Note:**
- (1) All Readings are Peak Value and AV.
  - (2) Emission Level= Reading Level + Probe Factor +Cable Loss
  - (3) Data of measurement within this frequency range shown “ -- ” in the table above means the reading of emissions are attenuated more than 20dB below the permissible limits or the field strength is too small to be measured.

Operation Mode: 802.11b      Test Date : Dec. 26, 2013  
                          RX 2437MHz  
 Frequency Range: 1-25GHz      Temperature : 22 °C  
 Measured Distance: 3m      Humidity : 65 %  
 Test Voltage: AC 120V/60Hz

Freq. (MHz)	Ant.Pol. H/V	Emission Level (dBUV/m)		Limit3m (dBUV/m)		Margin(dB)	
		PK	AV	PK	AV	PK	AV
3235.250	V	44.69	40.32	74.00	54.00	29.31	13.68
--	V	--	--	74.00	54.00	--	--
--	V	--	--	74.00	54.00	--	--
--	V	--	--	74.00	54.00	--	--
--	V	--	--	74.00	54.00	--	--
3235.250	H	46.72	41.69	74.00	54.00	27.28	12.31
--	H	--	--	74.00	54.00	--	--
--	H	--	--	74.00	54.00	--	--
--	H	--	--	74.00	54.00	--	--
--	H	--	--	74.00	54.00	--	--

**Other harmonics emissions are lower than 20dB below the allowable limit.**

- Note:**
- (1) All Readings are Peak Value and AV.
  - (2) Emission Level= Reading Level + Probe Factor +Cable Loss
  - (3) Data of measurement within this frequency range shown “ -- ” in the table above means the reading of emissions are attenuated more than 20dB below the permissible limits or the field strength is too small to be measured.

Operation Mode:	802.11b RX 2462MHz	Test Date :	Dec. 26, 2013
Frequency Range:	1-25GHz	Temperature :	22 °C
Measured Distance:	3m	Humidity :	65 %
Test Voltage:	AC 120V/60Hz		

Freq. (MHz)	Ant.Pol. H/V	Emission Level (dBuV/m)		Limit3m (dBuV/m)		Margin(dB)	
		PK	AV	PK	AV	PK	AV
3256.710	V	44.78	40.30	74.00	54.00	29.22	13.70
--	V	--	--	74.00	54.00	--	--
--	V	--	--	74.00	54.00	--	--
--	V	--	--	74.00	54.00	--	--
--	V	--	--	74.00	54.00	--	--
3256.710	H	47.37	43.81	74.00	54.00	26.63	10.19
--	H	--	--	74.00	54.00	--	--
--	H	--	--	74.00	54.00	--	--
--	H	--	--	74.00	54.00	--	--
--	H	--	--	74.00	54.00	--	--

**Other harmonics emissions are lower than 20dB below the allowable limit.**

- Note:**
- (1) All Readings are Peak Value and AV.
  - (2) Emission Level= Reading Level + Probe Factor +Cable Loss
  - (3) Data of measurement within this frequency range shown “ -- ” in the table above means the reading of emissions are attenuated more than 20dB below the permissible limits or the field strength is too small to be measured.

Operation Mode:	802.11g RX 2412MHz	Test Date :	Dec. 26, 2013
Frequency Range:	1-25GHz	Temperature :	22 °C
Measured Distance:	3m	Humidity :	65 %
Test Voltage:	AC 120V/60Hz		

Freq. (MHz)	Ant.Pol. H/V	Emission Level (dBuV/m)		Limit3m (dBuV/m)		Margin(dB)	
		PK	AV	PK	AV	PK	AV
3215.750	V	44.62	40.13	74.00	54.00	29.38	13.87
--	V	--	--	74.00	54.00	--	--
--	V	--	--	74.00	54.00	--	--
--	V	--	--	74.00	54.00	--	--
--	V	--	--	74.00	54.00	--	--
3215.750	H	46.69	42.17	74.00	54.00	27.31	11.83
--	H	--	--	74.00	54.00	--	--
--	H	--	--	74.00	54.00	--	--
--	H	--	--	74.00	54.00	--	--
--	H	--	--	74.00	54.00	--	--

**Other harmonics emissions are lower than 20dB below the allowable limit.**

- Note:**
- (1) All Readings are Peak Value and AV.
  - (2) Emission Level= Reading Level + Probe Factor +Cable Loss
  - (3) Data of measurement within this frequency range shown “ -- ” in the table above means the reading of emissions are attenuated more than 20dB below the permissible limits or the field strength is too small to be measured.

Operation Mode:	802.11g RX 2437MHz	Test Date :	Dec. 26, 2013
Frequency Range:	1-25GHz	Temperature :	22 °C
Measured Distance:	3m	Humidity :	65 %
Test Voltage:	AC 120V/60Hz		

Freq. (MHz)	Ant.Pol. H/V	Emission Level (dBuV/m)		Limit3m (dBuV/m)		Margin(dB)	
		PK	AV	PK	AV	PK	AV
3235.250	V	44.21	40.04	74.00	54.00	29.79	13.96
--	V	--	--	74.00	54.00	--	--
--	V	--	--	74.00	54.00	--	--
--	V	--	--	74.00	54.00	--	--
--	V	--	--	74.00	54.00	--	--
3235.250	H	45.85	41.45	74.00	54.00	28.15	12.55
--	H	--	--	74.00	54.00	--	--
--	H	--	--	74.00	54.00	--	--
--	H	--	--	74.00	54.00	--	--
--	H	--	--	74.00	54.00	--	--

**Other harmonics emissions are lower than 20dB below the allowable limit.**

- Note:**
- (1) All Readings are Peak Value and AV.
  - (2) Emission Level= Reading Level + Probe Factor +Cable Loss
  - (3) Data of measurement within this frequency range shown “ -- ” in the table above means the reading of emissions are attenuated more than 20dB below the permissible limits or the field strength is too small to be measured.

Operation Mode:	802.11g RX 2462MHz	Test Date :	Dec. 26, 2013
Frequency Range:	1-25GHz	Temperature :	22 °C
Measured Distance:	3m	Humidity :	65 %
Test Voltage:	AC 120V/60Hz		

Freq. (MHz)	Ant.Pol. H/V	Emission Level (dBUV/m)		Limit3m (dBUV/m)		Margin(dB)	
		PK	AV	PK	AV	PK	AV
3256.700	V	44.11	40.05	74.00	54.00	29.89	13.95
--	V	--	--	74.00	54.00	--	--
--	V	--	--	74.00	54.00	--	--
--	V	--	--	74.00	54.00	--	--
--	V	--	--	74.00	54.00	--	--
3256.700	H	46.57	42.60	74.00	54.00	27.43	11.40
--	H	--	--	74.00	54.00	--	--
--	H	--	--	74.00	54.00	--	--
--	H	--	--	74.00	54.00	--	--
--	H	--	--	74.00	54.00	--	--

**Other harmonics emissions are lower than 20dB below the allowable limit.**

- Note:**
- (1) All Readings are Peak Value and AV.
  - (2) Emission Level= Reading Level + Probe Factor +Cable Loss
  - (3) Data of measurement within this frequency range shown “ -- ” in the table above means the reading of emissions are attenuated more than 20dB below the permissible limits or the field strength is too small to be measured.

Operation Mode: 802.11n (HT20) Test Date : Dec. 26, 2013  
 RX 2412MHz  
 Frequency Range: 1-25GHz Temperature : 22 °C  
 Measured Distance: 3m Humidity : 65 %  
 Test Voltage: AC 120V/60Hz

Freq. (MHz)	Ant.Pol. H/V	Emission Level (dBUV/m)		Limit3m (dBUV/m)		Margin(dB)	
		PK	AV	PK	AV	PK	AV
3215.750	V	44.51	40.10	74.00	54.00	29.49	13.90
--	V	--	--	74.00	54.00	--	--
--	V	--	--	74.00	54.00	--	--
--	V	--	--	74.00	54.00	--	--
--	V	--	--	74.00	54.00	--	--
3215.750	H	46.25	42.13	74.00	54.00	27.75	11.87
--	H	--	--	74.00	54.00	--	--
--	H	--	--	74.00	54.00	--	--
--	H	--	--	74.00	54.00	--	--
--	H	--	--	74.00	54.00	--	--

**Other harmonics emissions are lower than 20dB below the allowable limit.**

- Note:**
- (1) All Readings are Peak Value and AV.
  - (2) Emission Level= Reading Level + Probe Factor +Cable Loss
  - (3) Data of measurement within this frequency range shown “ -- ” in the table above means the reading of emissions are attenuated more than 20dB below the permissible limits or the field strength is too small to be measured.

Operation Mode: 802.11n (HT20) Test Date : Dec. 26, 2013  
                   RX 2437MHz  
 Frequency Range: 1-25GHz Temperature : 22°C  
 Measured Distance: 3m Humidity : 65 %  
 Test Voltage: AC 120V/60Hz

Freq. (MHz)	Ant.Pol. H/V	Emission Level (dBUV/m)		Limit3m (dBUV/m)		Margin(dB)	
		PK	AV	PK	AV	PK	AV
3235.250	V	44.21	40.04	74.00	54.00	29.79	13.96
--	V	--	--	74.00	54.00	--	--
--	V	--	--	74.00	54.00	--	--
--	V	--	--	74.00	54.00	--	--
--	V	--	--	74.00	54.00	--	--
3235.250	H	45.85	41.45	74.00	54.00	28.15	12.55
--	H	--	--	74.00	54.00	--	--
--	H	--	--	74.00	54.00	--	--
--	H	--	--	74.00	54.00	--	--
--	H	--	--	74.00	54.00	--	--

**Other harmonics emissions are lower than 20dB below the allowable limit.**

- Note:**
- (1) All Readings are Peak Value and AV.
  - (2) Emission Level= Reading Level + Probe Factor +Cable Loss
  - (3) Data of measurement within this frequency range shown “ -- ” in the table above means the reading of emissions are attenuated more than 20dB below the permissible limits or the field strength is too small to be measured.



Operation Mode: 802.11n (HT20) Test Date : Dec. 26, 2013  
 RX 2462MHz  
 Frequency Range: 1-25GHz Temperature : 22 °C  
 Measured Distance: 3m Humidity : 65 %  
 Test Voltage: AC 120V/60Hz

Freq. (MHz)	Ant.Pol. H/V	Emission Level (dBuV/m)		Limit3m (dBuV/m)		Margin(dB)	
		PK	AV	PK	AV	PK	AV
3256.700	V	44.07	40.09	74.00	54.00	29.93	13.91
--	V	--	--	74.00	54.00	--	--
--	V	--	--	74.00	54.00	--	--
--	V	--	--	74.00	54.00	--	--
--	V	--	--	74.00	54.00	--	--
3256.700	H	46.41	42.17	74.00	54.00	27.59	11.83
--	H	--	--	74.00	54.00	--	--
--	H	--	--	74.00	54.00	--	--
--	H	--	--	74.00	54.00	--	--
--	H	--	--	74.00	54.00	--	--

**Other harmonics emissions are lower than 20dB below the allowable limit.**

- Note:**
- (1) All Readings are Peak Value and AV.
  - (2) Emission Level= Reading Level + Probe Factor +Cable Loss
  - (3) Data of measurement within this frequency range shown “ -- ” in the table above means the reading of emissions are attenuated more than 20dB below the permissible limits or the field strength is too small to be measured.

Operation Mode: 802.11n (HT40) Test Date : Dec. 26, 2013  
 RX 2422MHz  
 Frequency Range: 1-25GHz Temperature : 22 °C  
 Measured Distance: 3m Humidity : 65 %  
 Test Voltage: AC 120V/60Hz

Freq. (MHz)	Ant.Pol. H/V	Emission Level (dBuV/m)		Limit3m (dBuV/m)		Margin(dB)	
		PK	AV	PK	AV	PK	AV
3225.710	V	43.71	39.87	74.00	54.00	30.29	14.13
--	V	--	--	74.00	54.00	--	--
--	V	--	--	74.00	54.00	--	--
--	V	--	--	74.00	54.00	--	--
--	V	--	--	74.00	54.00	--	--
3225.710	H	45.22	41.38	74.00	54.00	28.78	12.62
--	H	--	--	74.00	54.00	--	--
--	H	--	--	74.00	54.00	--	--
--	H	--	--	74.00	54.00	--	--
--	H	--	--	74.00	54.00	--	--

**Other harmonics emissions are lower than 20dB below the allowable limit.**

- Note:**
- (1) All Readings are Peak Value and AV.
  - (2) Emission Level= Reading Level + Probe Factor +Cable Loss
  - (3) Data of measurement within this frequency range shown “ -- ” in the table above means the reading of emissions are attenuated more than 20dB below the permissible limits or the field strength is too small to be measured.

Operation Mode: 802.11n (HT40) Test Date : Dec. 26, 2013  
                   RX 2437MHz  
 Frequency Range: 1-25GHz Temperature : 22 °C  
 Measured Distance: 3m Humidity : 65 %  
 Test Voltage: AC 120V/60Hz

Freq. (MHz)	Ant.Pol. H/V	Emission Level (dBUV/m)		Limit3m (dBUV/m)		Margin(dB)	
		PK	AV	PK	AV	PK	AV
3235.250	V	43.84	39.57	74.00	54.00	30.16	14.43
--	V	--	--	74.00	54.00	--	--
--	V	--	--	74.00	54.00	--	--
--	V	--	--	74.00	54.00	--	--
--	V	--	--	74.00	54.00	--	--
3235.250	H	44.21	41.20	74.00	54.00	29.79	12.80
--	H	--	--	74.00	54.00	--	--
--	H	--	--	74.00	54.00	--	--
--	H	--	--	74.00	54.00	--	--
--	H	--	--	74.00	54.00	--	--

**Other harmonics emissions are lower than 20dB below the allowable limit.**

- Note:**
- (1) All Readings are Peak Value and AV.
  - (2) Emission Level= Reading Level + Probe Factor +Cable Loss
  - (3) Data of measurement within this frequency range shown “ -- ” in the table above means the reading of emissions are attenuated more than 20dB below the permissible limits or the field strength is too small to be measured.

Operation Mode: 802.11n (HT40) Test Date : Dec. 26, 2013  
 RX 2452MHz  
 Frequency Range: 1-25GHz Temperature : 22 °C  
 Measured Distance: 3m Humidity : 65 %  
 Test Voltage: AC 120V/60Hz

Freq. (MHz)	Ant.Pol. H/V	Emission Level (dBUV/m)		Limit3m (dBUV/m)		Margin(dB)	
		PK	AV	PK	AV	PK	AV
3245.230	V	43.51	38.95	74.00	54.00	30.49	15.05
--	V	--	--	74.00	54.00	--	--
--	V	--	--	74.00	54.00	--	--
--	V	--	--	74.00	54.00	--	--
--	V	--	--	74.00	54.00	--	--
3245.230	H	44.32	40.83	74.00	54.00	29.68	13.17
--	H	--	--	74.00	54.00	--	--
--	H	--	--	74.00	54.00	--	--
--	H	--	--	74.00	54.00	--	--
--	H	--	--	74.00	54.00	--	--

**Other harmonics emissions are lower than 20dB below the allowable limit.**

- Note:**
- (1) All Readings are Peak Value and AV.
  - (2) Emission Level= Reading Level + Probe Factor +Cable Loss
  - (3) Data of measurement within this frequency range shown “ -- ” in the table above means the reading of emissions are attenuated more than 20dB below the permissible limits or the field strength is too small to be measured.

## 5. Restricted Bands Requirement

### 5.1 Test Standard and Limit

#### 5.1.1 Test Standard

FCC Part 15.209 FCC Part 15.205  
RSS-210 A8.5

#### 5.1.2 Test Limit

Restricted Frequency Band (MHz)	Class B (dBuV/m)(at 3 M)	
	Peak	Average
2310 ~2390	74	54
2483.5 ~2500	74	54

### 5.2 Test Setup

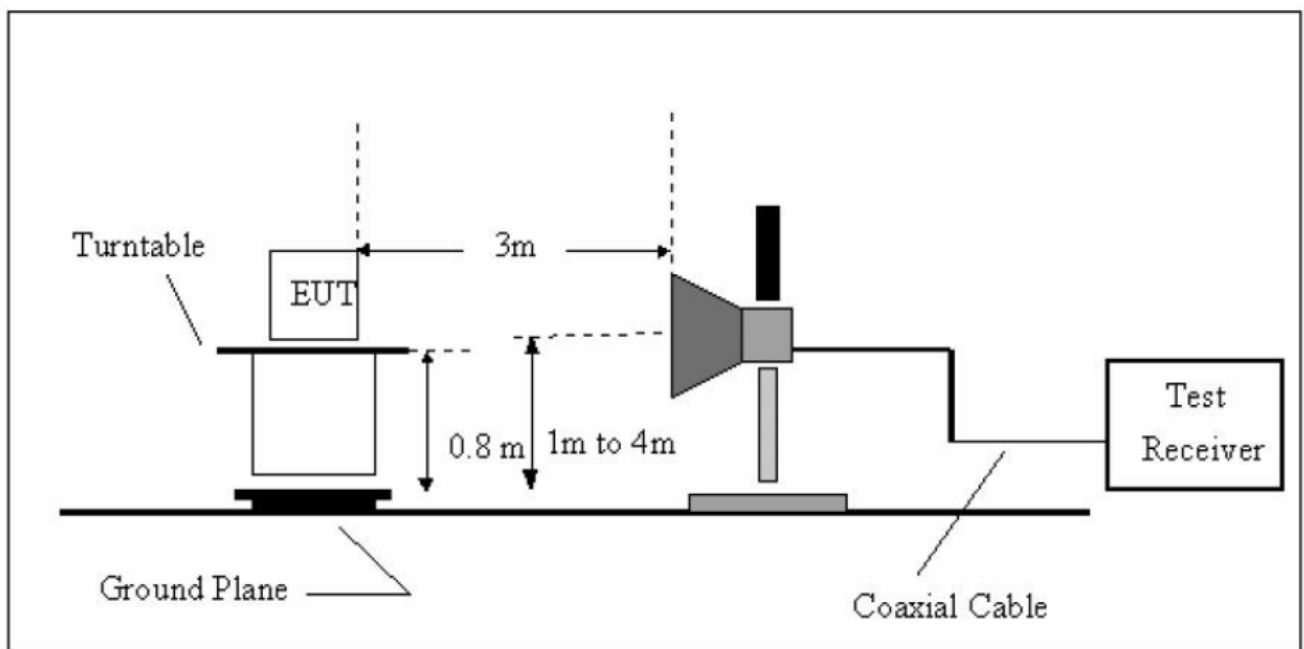

### 5.3 Test Procedure

- (1) The measuring distance of 3m shall be used for measurements at frequency up to 1GHz and above 1 GHz. The EUT was placed on a rotating 0.8m high above ground, the table was rotated 360 degrees to determine the position of the highest radiation.
- (2) The Test antenna shall vary between 1m and 4m, Both Horizontal and Vertical antenna are set to make measurement.
- (3) The initial step in collecting conducted emission data is a spectrum analyzer peak detector mode pre-scanning the measurement frequency range. Significant peaks are then marked and then Quasi Peak detector mode re-measured.

- (4) If the Peak Mode measured value compliance with and lower than Quasi Peak Mode Limit Bellow 1 GHz, the EUT shall be deemed to meet QP Limits and then no additional QP Mode measurement performed. But the Peak Value and average value both need to comply with applicable limit above 1 GHz.

Peak Detection:

Set the center frequency of the emission to be measured (within 2 MHz of the authorized band edge), set span to 2 MHz, with RBW/VBW=100 kHz/300 kHz, detector mode is Peak, then use band power function to measure the Bandwidth of 1 MHz.

Average Detection (EUT transmitting continuously and duty cycle $\geq$ 98 percent):

Set the center frequency of the emission to be measured (within 2 MHz of the authorized band edge), set span to 2 MHz, with RBW/VBW=100 kHz/300 kHz, detector mode is RMS or Average, then use band power function to measure the Bandwidth of 1 MHz.

- (5) For the actual test configuration, please see the test setup photo.

## 5.4 EUT Operating Condition

The Equipment Under Test was set to Continual Transmitting in maximum power.

## 5.5 Test Equipment

Description	Manufacturer	Model No.	Serial No.	Cal. Date	Cal. Due Date
Spectrum Analyzer	ROHDE& SCHWARZ	FSP30	DE25181	2013-12-30	2014-12-29
Spectrum Analyzer	Agilent	E4407B	MY49510055	2013-12-30	2014-12-29
EMI Test Receiver	ROHDE& SCHWARZ	ESCI	101165	2013-12-30	2014-12-29
Bilog Antenna	SCHWARZBECK	VULB9168	9168-438	2013-02-12	2014-02-11
Horn Antenna	SCHWARZBECK	BBHA 9120D	BBHA9120D	2013-02-12	2014-02-11
Horn Antenna	SCHWARZBECK	BBHA 9170	BBHA9170D	2013-02-12	2014-02-11
Active Loop Antenna	Beijing Daze	ZN30900A	SEL0097	2013-02-12	2014-02-11
Pre-amplifier	SCHWARZBECK	BBV9743	9743-019	2013-12-30	2014-12-29
Pre-amplifier	Quietek	AP-180C	CHM-0602012	2013-12-30	2014-12-29

## 5.6 Test Data

Please see the next page.

Spectrum Detector: PK  
 Temperature : 28 °C

Test Date : August 14, 2013  
 Humidity : 65 %

## 802.11b Mode

### 1. Conducted Test

Frequency (MHz)	Peak Power Output(dBm)	Emission Read Value(dBm)	Result of Band edge(dBc)	Band edge Limit(dBc)
<2400	2.80	-46.63	49.43	>20dBc
>2483.5	2.82	-46.91	49.73	>20dBc

Spectrum Detector: PK  
 Temperature : 22 °C

Test Date : December 26, 2013  
 Humidity : 65 %

### 2. Radiated emission test

FUNDAMENTAL					
Channel	Antenna polarization (H/V)	Emission (dBuV/m)			
		PEAK		AV	
CH 01	H	104.50		100.23	
	V	102.35		98.15	
CH 06	H	104.71		100.39	
	V	102.63		98.61	
CH 11	H	104.05		99.86	
	V	101.87		98.19	
BAND EDGE					
Frequency (MHz)	Antenna polarization (H/V)	Emission (dBuV/m)		Band edge Limit (dBuV/m)	
		PEAK	AV	PEAK	AV
<2400	H	56.79	46.11	74.00	54.00
<2400	V	54.41	44.29	74.00	54.00
>2483.5	H	58.19	47.37	74.00	54.00
>2483.5	V	56.66	46.14	74.00	54.00

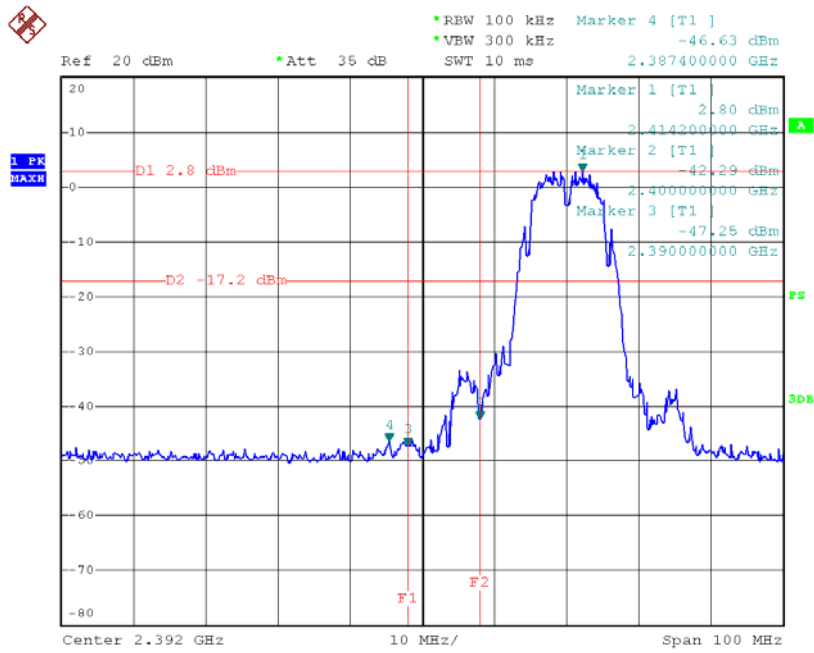

Date: 14.AUG.2013 11:47:57

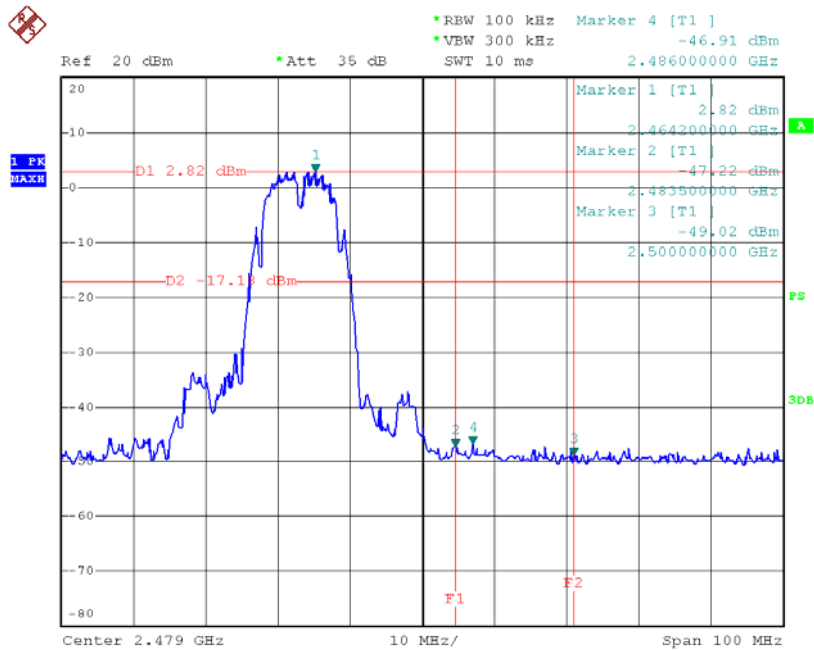

Date: 14.AUG.2013 11:46:05



Spectrum Detector: PK  
 Temperature : 28 °C

Test Date : August 14, 2013  
 Humidity : 65 %

## 802.11g Mode

### 1. Conducted Test

Frequency (MHz)	Peak Power Output(dBm)	Emission Read Value(dBm)	Result of Band edge(dBc)	Band edge Limit(dBc)
<2400	-4.33	-44.11	39.78	>20dBc
>2483.5	-5.90	-47.91	42.01	>20dBc

Spectrum Detector: PK  
 Temperature : 22 °C

Test Date : December 26, 2013  
 Humidity : 65 %

### 2. Radiated emission test

FUNDAMENTAL					
Channel	Antenna polarization (H/V)	Emission (dBuV/m)			
		PEAK		AV	
CH 01	H	103.14		98.39	
	V	101.88		97.14	
CH 06	H	103.65		98.81	
	V	102.03		97.49	
CH 11	H	102.87		96.07	
	V	101.62		95.86	
BAND EDGE					
Frequency (MHz)	Antenna polarization (H/V)	Emission (dBuV/m)		Band edge Limit (dBuV/m)	
		PEAK	AV	PEAK	AV
<2400	H	56.22	46.13	74.00	54.00
<2400	V	54.31	44.27	74.00	54.00
>2483.5	H	57.60	47.13	74.00	54.00
>2483.5	V	55.29	45.04	74.00	54.00

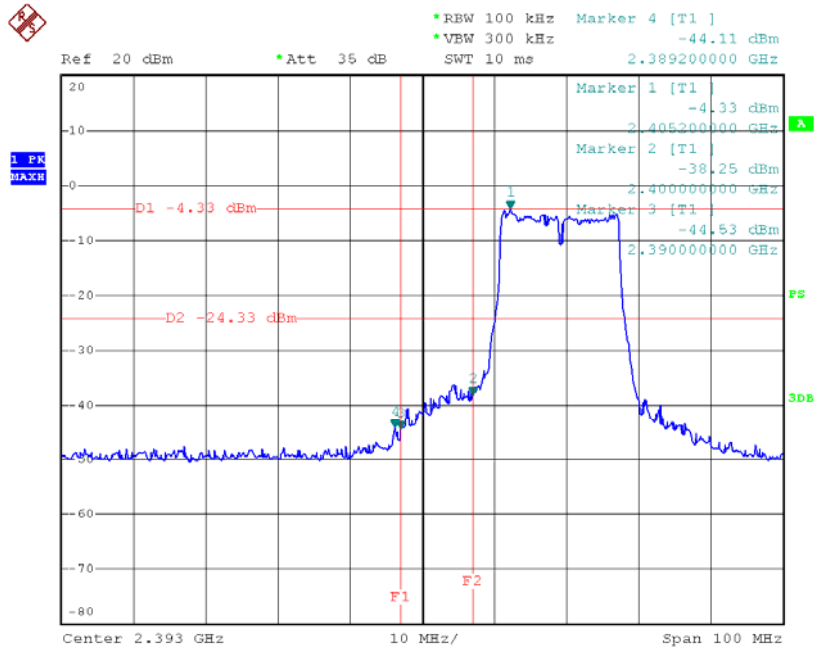

Date: 14.AUG.2013 13:54:07

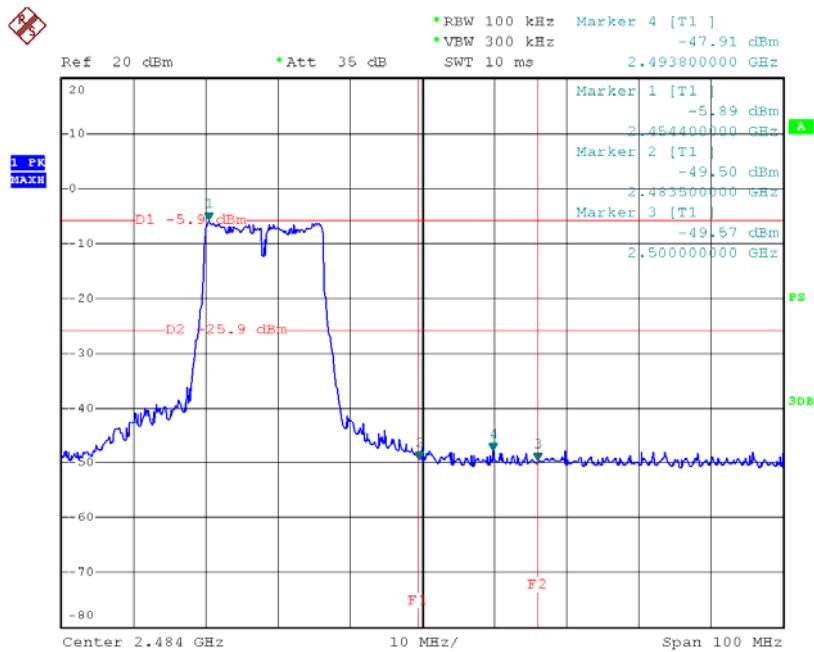

Date: 14.AUG.2013 13:50:09

Spectrum Detector: PK  
 Temperature : 28 °C

 Test Date : August 14, 2013  
 Humidity : 65 %

## 802.11n (HT20) Mode

### 1. Conducted Test

Frequency (MHz)	Peak Power Output(dBm)	Emission Read Value(dBm)	Result of Band edge(dBc)	Band edge Limit(dBc)
<2400	-5.69	-44.66	38.97	>20dBc
>2483.5	-6.79	-48.08	41.29	>20dBc

 Spectrum Detector: PK  
 Temperature : 22 °C

 Test Date : December 26, 2013  
 Humidity : 65 %

### 2. Radiated emission test

FUNDAMENTAL					
Channel	Antenna polarization (H/V)	Emission (dBuV/m)			
		PEAK		AV	
CH 01	H	102.26		97.62	
	V	101.58		95.81	
CH 06	H	102.97		97.89	
	V	101.69		96.03	
CH 11	H	102.05		97.40	
	V	100.91		95.27	
BAND EDGE					
Frequency (MHz)	Antenna polarization (H/V)	Emission (dBuV/m)		Band edge Limit (dBuV/m)	
		PEAK	AV	PEAK	AV
<2400	H	56.93	46.17	74.00	54.00
<2400	V	53.89	43.70	74.00	54.00
>2483.5	H	57.08	46.96	74.00	54.00
>2483.5	V	55.38	45.14	74.00	54.00

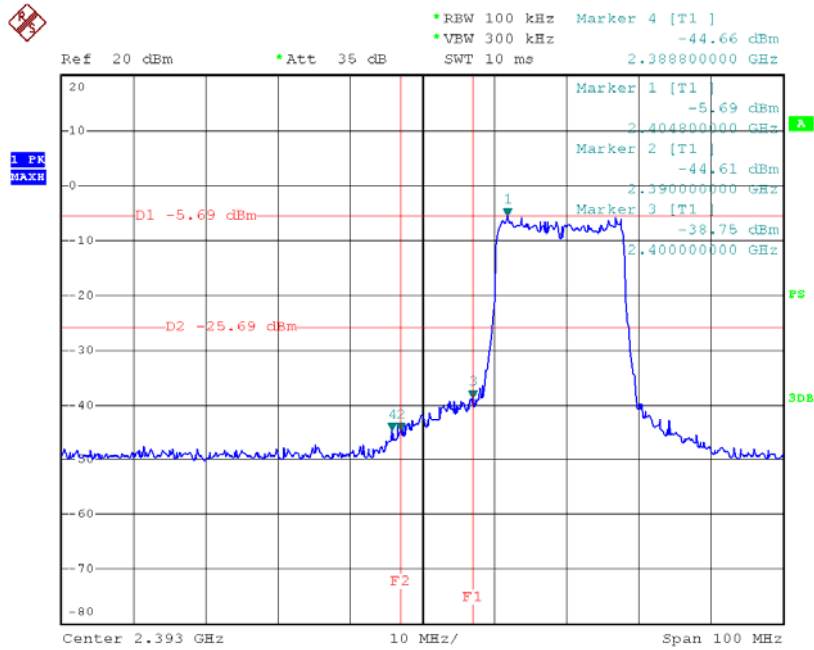

Date: 14.AUG.2013 14:17:37

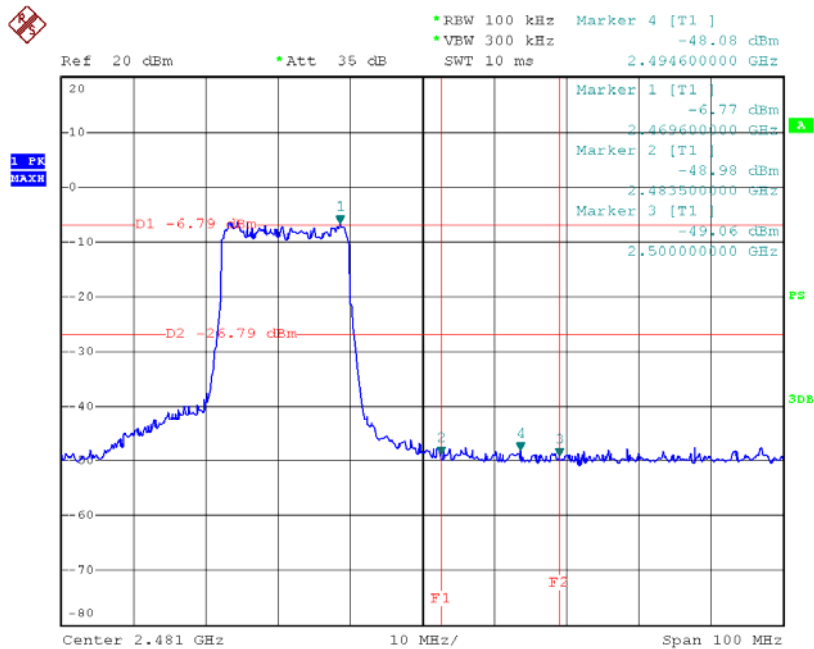

Date: 14.AUG.2013 14:28:06

Spectrum Detector: PK  
 Temperature : 28 °C

Test Date : August 14, 2013  
 Humidity : 65 %

## 802.11n (HT40) Mode

### 1. Conducted Test

Frequency (MHz)	Peak Power Output(dBm)	Emission Read Value(dBm)	Result of Band edge(dBc)	Band edge Limit(dBc)
<2400	-9.86	-41.33	31.47	>20dBc
>2483.5	-9.99	-47.37	37.38	>20dBc

Spectrum Detector: PK  
 Temperature : 22 °C

Test Date : December 26, 2013  
 Humidity : 65 %

### 2. Radiated emission test

FUNDAMENTAL					
Channel	Antenna polarization (H/V)	Emission (dBuV/m)			
		PEAK		AV	
CH 03	H	98.62		92.35	
	V	96.17		90.31	
CH 06	H	99.06		93.40	
	V	97.14		91.48	
CH 09	H	98.51		92.39	
	V	96.04		90.21	
BAND EDGE					
Frequency (MHz)	Antenna polarization (H/V)	Emission (dBuV/m)		Band edge Limit (dBuV/m)	
		PEAK	AV	PEAK	AV
<2400	H	56.85	46.20	74.00	54.00
<2400	V	54.79	44.96	74.00	54.00
>2483.5	H	57.53	47.08	74.00	54.00
>2483.5	V	55.32	45.06	74.00	54.00

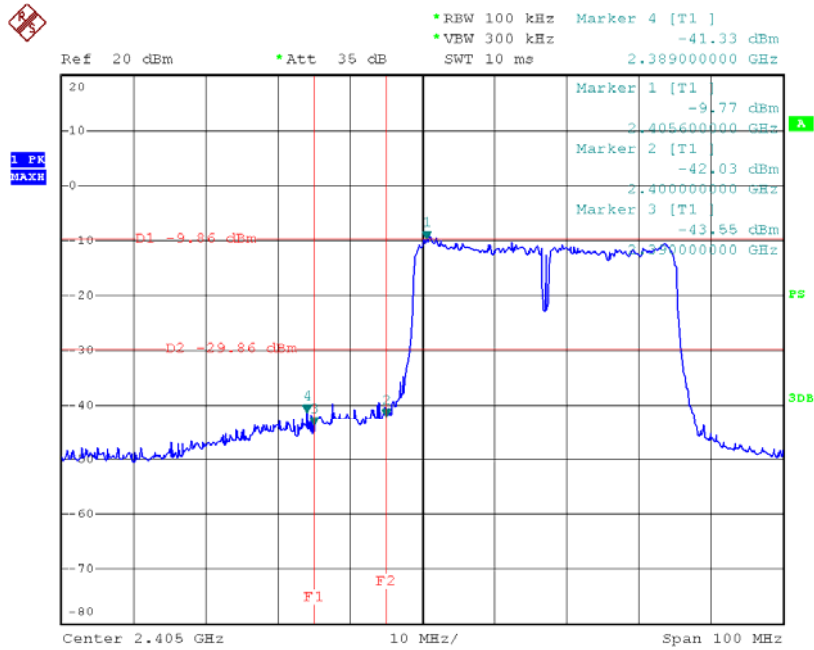

Date: 14.AUG.2013 14:44:18

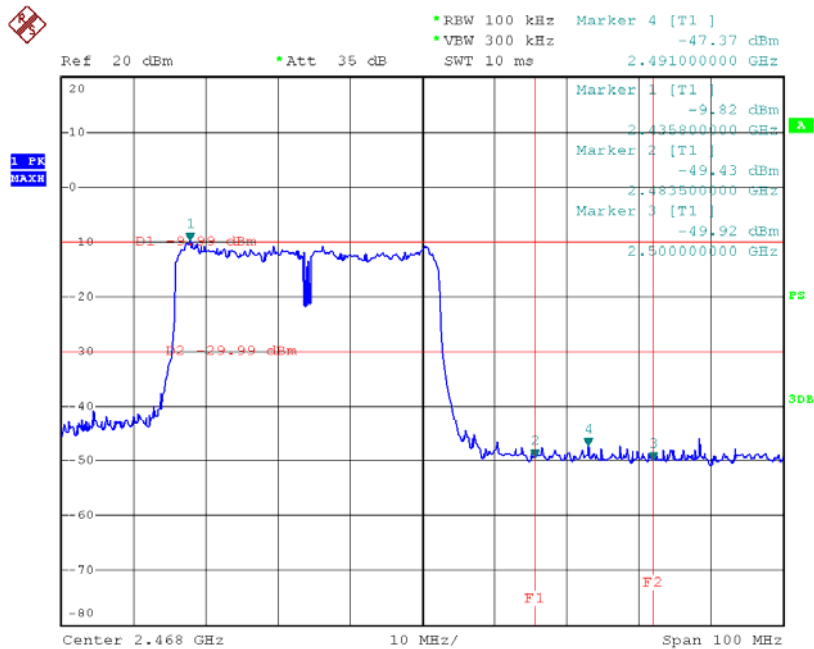

Date: 14.AUG.2013 14:46:59

## 6. Bandwidth Test

### 6.1 Test Standard and Limit

#### 8.1.1 Test Standard

FCC Part 15.247 (a)(2)/ RSS-210 A8.2(a)

#### 8.1.2 Test Limit

FCC Part 15 Subpart C(15.247)/RSS-210		
Test Item	Limit	Frequency Range(MHz)
Bandwidth	$\geq 500$ KHz (6dB bandwidth)	2400~2483.5

### 6.2 Test Setup

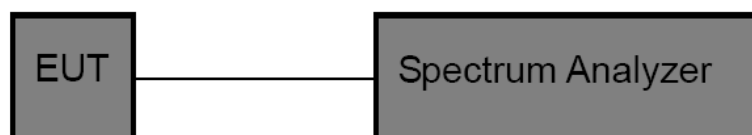

### 6.3 Test Procedure

- (1) The EUT was directly connected to the spectrum analyzer and antenna output port as show in the block diagram above.
- (2) The bandwidth is measured at an amplitude level reduced 6dB from the reference level. The reference level is the level of the highest amplitude signal observed from the transmitter at the fundamental frequency. Once the reference level is established, the equipment is conditioned with typical modulating signal to produce the worst –case (i.e the widest) bandwidth.
- (3) Measure the channel separation the spectrum analyzer was set to Resolution Bandwidth:100 kHz, and Video Bandwidth:300 kHz, Detector: Peak, Sweep Time set auto.

### 6.4 EUT Operating Condition

The EUT was set to continuously transmitting in each mode and low, middle and high channel for the test.

### 6.5 Test Equipment

Description	Manufacturer	Model No.	Serial No.	Cal. Date	Cal. Due Date
Spectrum Analyzer	ROHDE& SCHWARZ	FSP30	DE25181	2012-12-31	2013-12-30

### 6.6 Test Data

802.11b			
Channel frequency (MHz)	6dB Bandwidth (MHz)	99% Bandwidth (MHz)	Limit
2412	10.00	12.24	>=500 kHz
2437	10.08	12.28	>=500 kHz
2462	10.12	12.28	>=500 kHz

### 2412 MHz

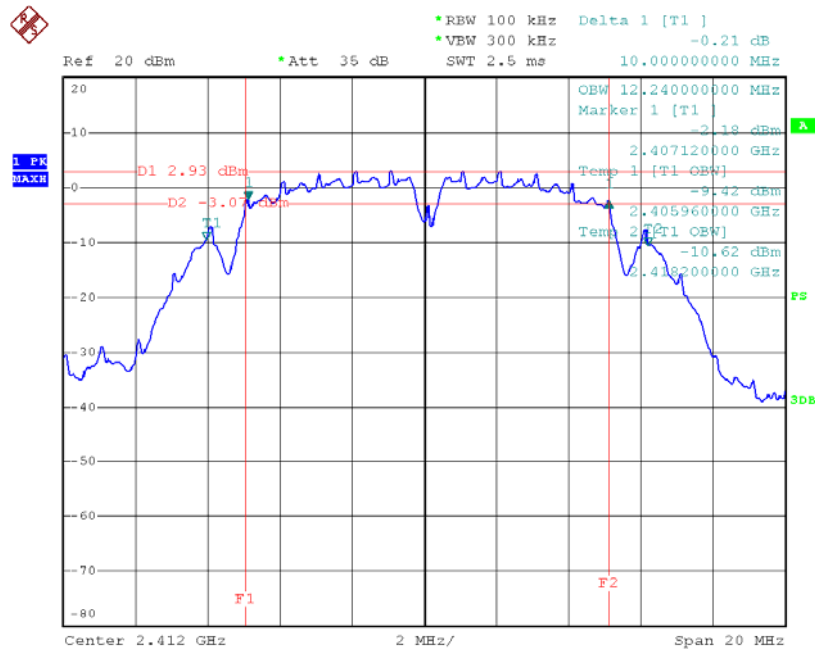

Date: 14.AUG.2013 11:34:03



## 2437 MHz

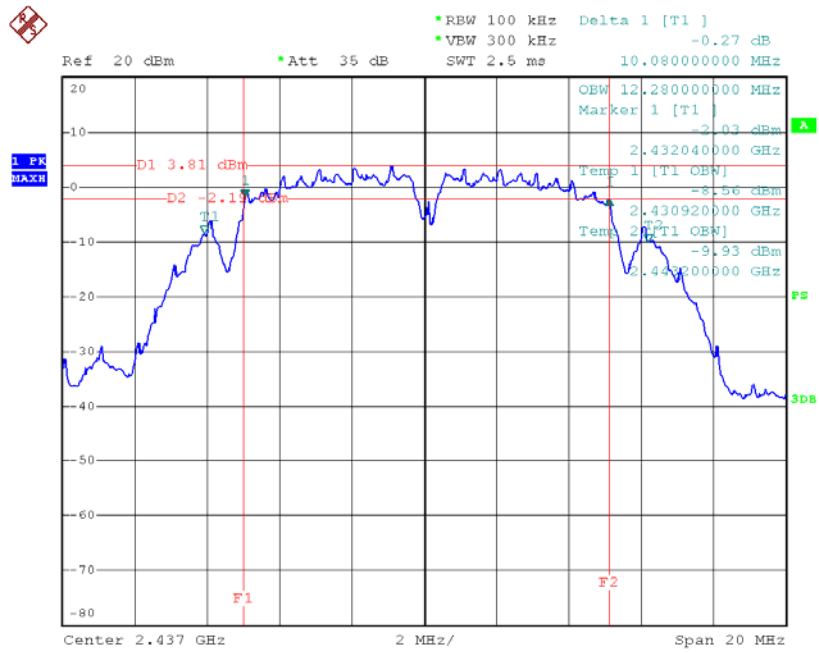

Date: 14.AUG.2013 11:39:35

## 2462 MHz

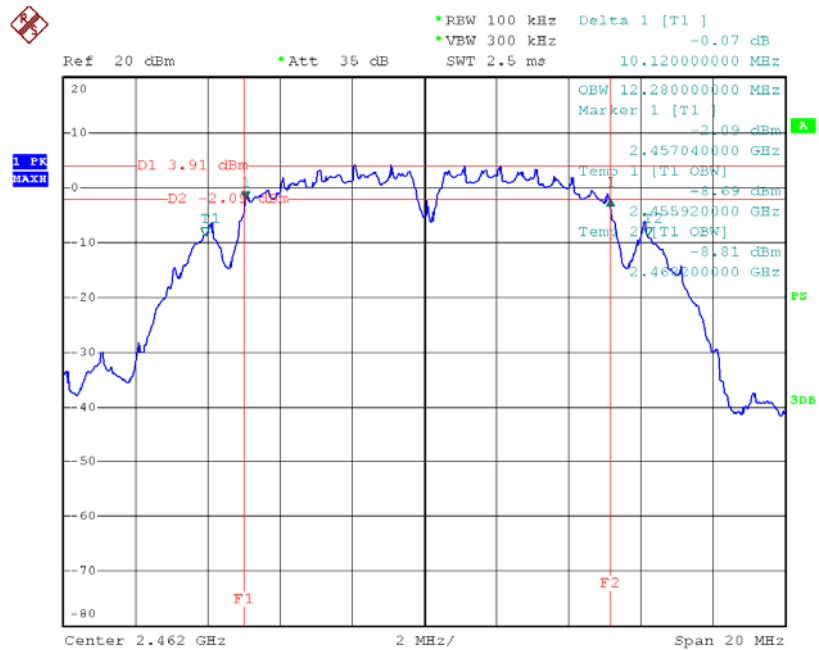

Date: 14.AUG.2013 11:44:36

802.11g			
Channel frequency (MHz)	6dB Bandwidth (MHz)	99% Bandwidth (MHz)	Limit
2412	16.52	16.48	>=500 kHz
2437	16.60	16.52	>=500 kHz
2462	16.60	16.56	>=500 kHz

### 2412 MHz

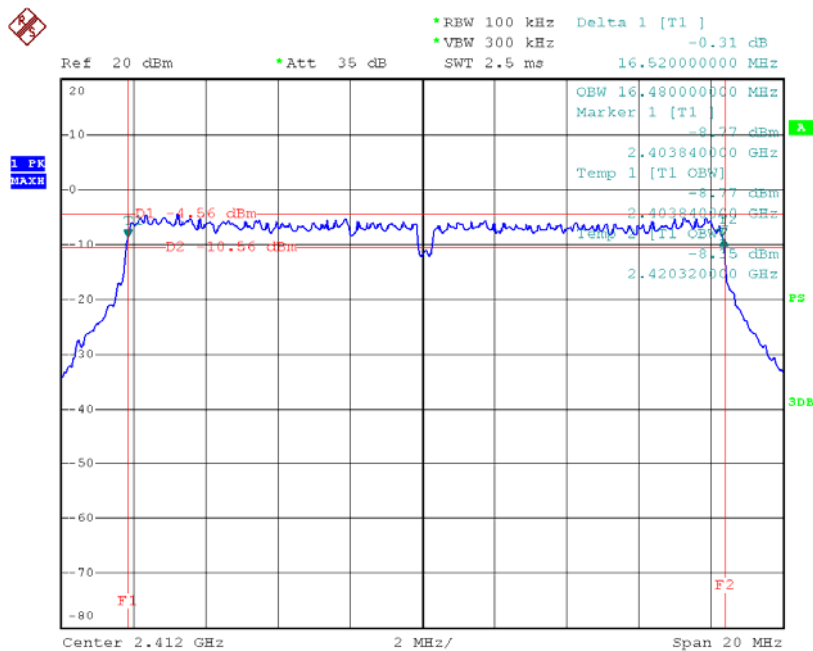

Date: 14.AUG.2013 13:55:51

## 2437 MHz

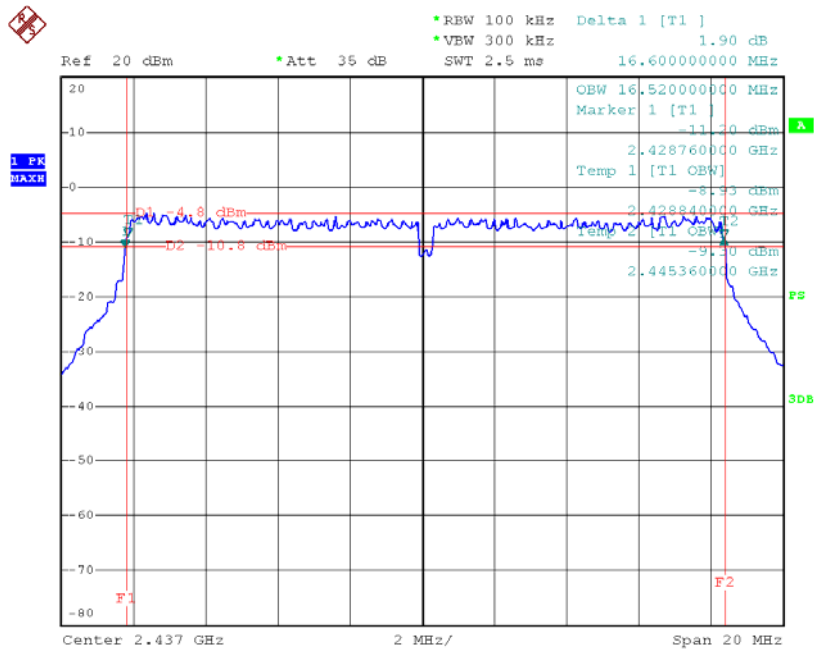

Date: 14.AUG.2013 13:58:49

## 2462 MHz

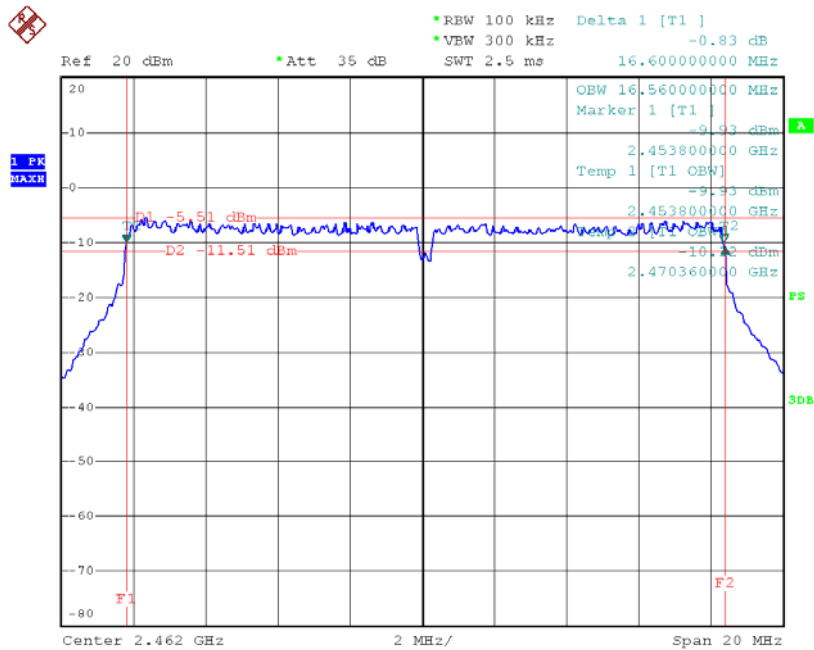

Date: 14.AUG.2013 11:55:37

802.11n(HT20)			
Channel frequency (MHz)	6dB Bandwidth (MHz)	99% Bandwidth (MHz)	Limit
2412	17.76	17.64	>=500 kHz
2437	17.76	17.64	>=500 kHz
2462	17.76	17.64	>=500 kHz

2412 MHz

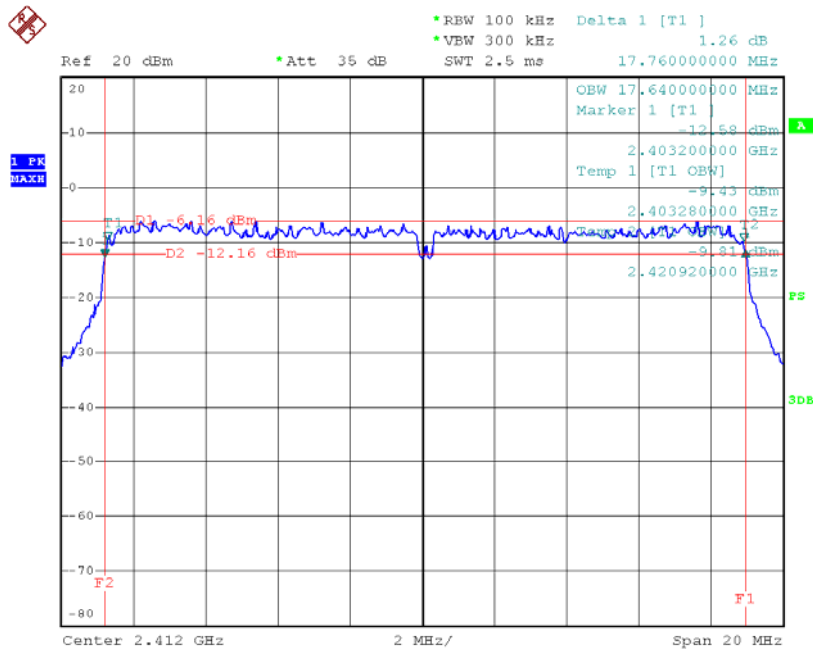

Date: 14.AUG.2013 14:14:37

## 2437 MHz

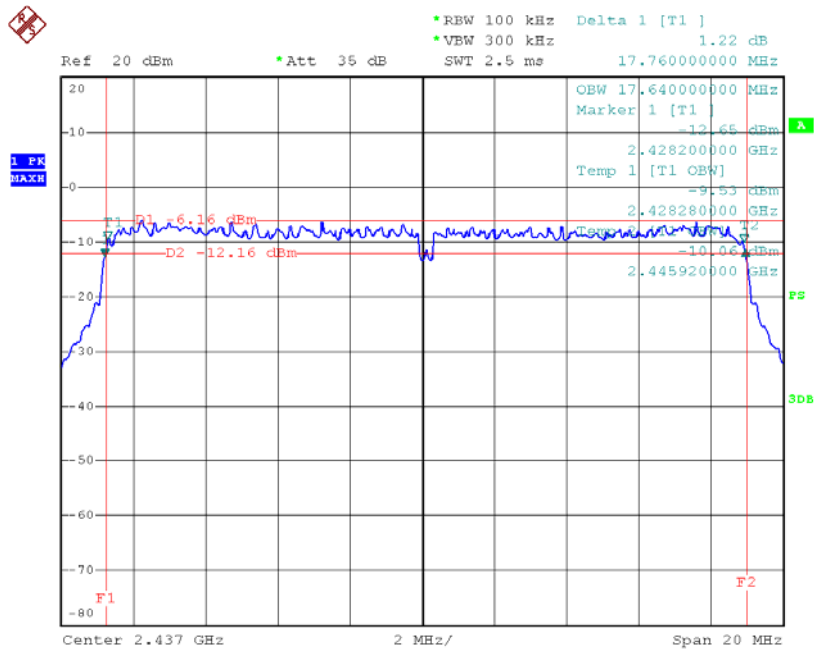

Date: 14.AUG.2013 14:24:09

## 2462 MHz

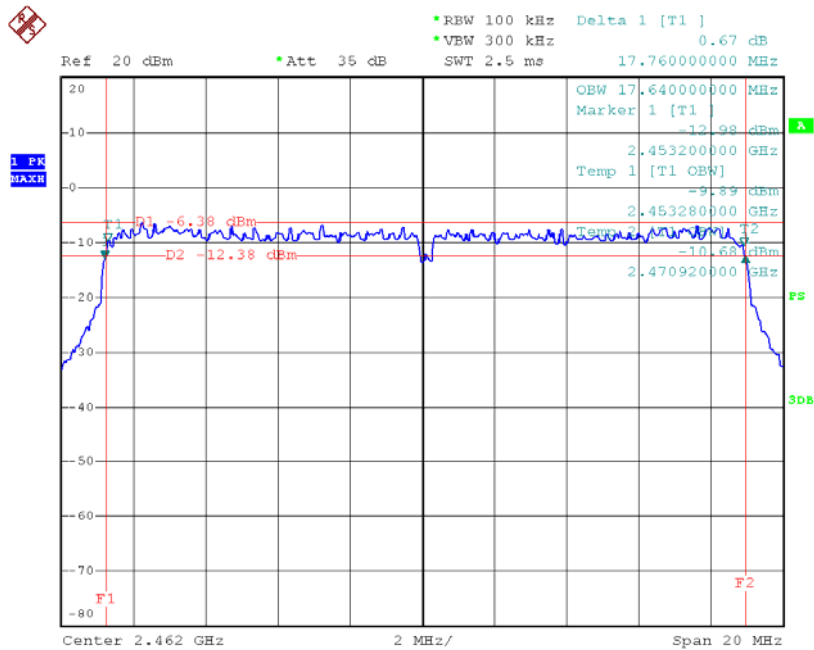

Date: 14.AUG.2013 14:26:47

802.11n(HT40)			
Channel frequency (MHz)	6dB Bandwidth (MHz)	99% Bandwidth (MHz)	Limit
2422	36.48	36.16	>=500 kHz
2437	36.48	36.16	>=500 kHz
2452	36.56	36.16	>=500 kHz

2422 MHz

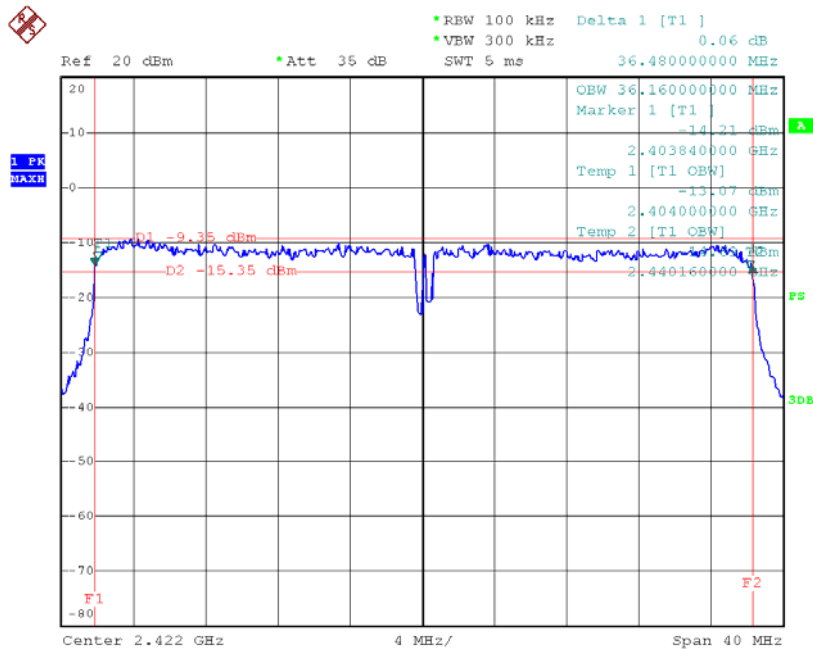

Date: 14.AUG.2013 14:42:38

### 2437 MHz

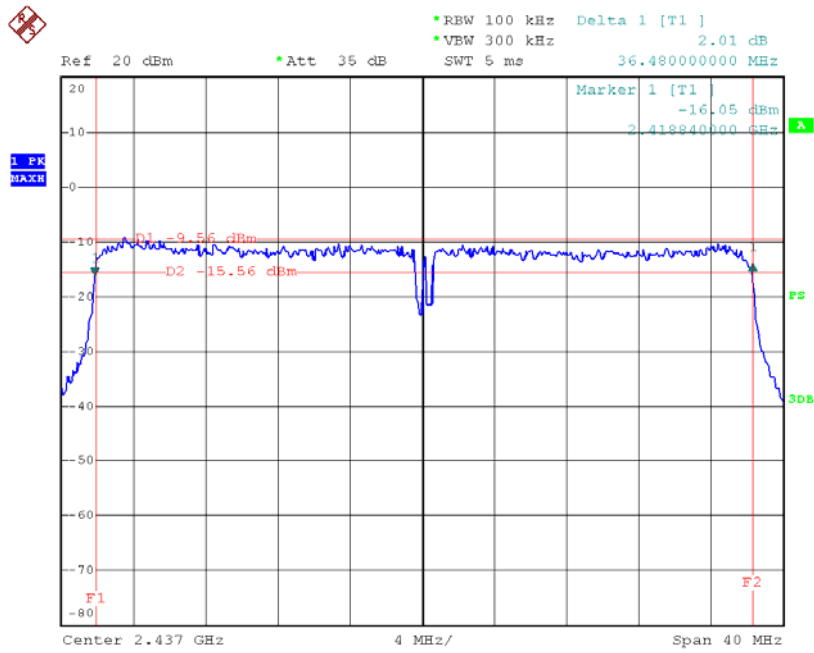

Date: 14.AUG.2013 14:59:58

### 2452 MHz

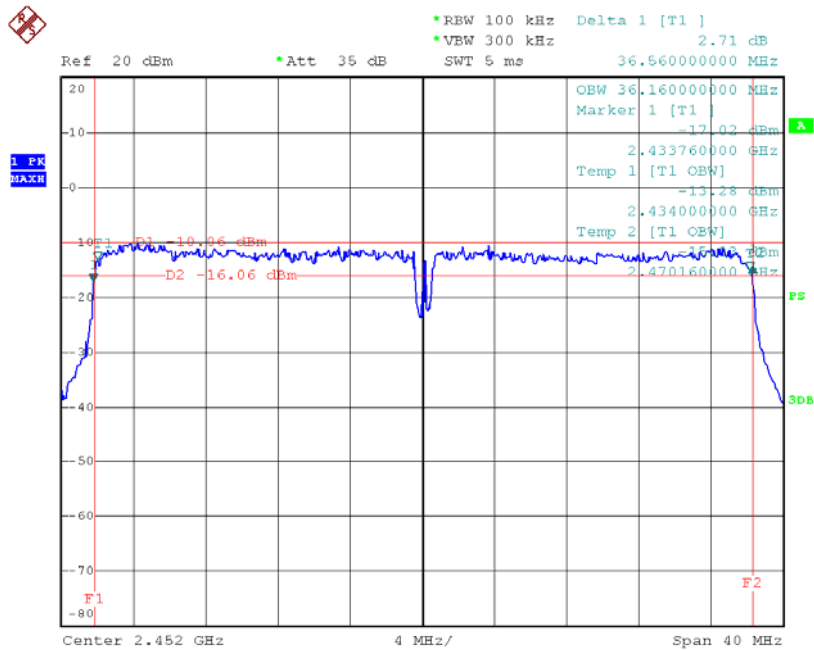

Date: 14.AUG.2013 14:50:57

## 7. Peak Output Power Test

### 7.1 Test Standard and Limit

#### 9.1.1 Test Standard

FCC Part 15.247 (b)/ RSS-210 A8.4 (4)

#### 9.1.2 Test Limit

FCC Part 15 Subpart C(15.247)/RSS-210		
Test Item	Limit	Frequency Range(MHz)
Peak Output Power	1 Watt or 30 dBm	2400~2483.5

### 7.2 Test Setup

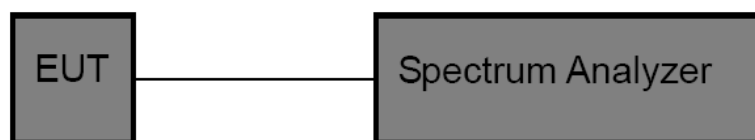

### 7.3 Test Procedure

The EUT was directly connected to the Spectrum Analyzer and antenna output port as show in the block diagram above.

### 7.4 EUT Operating Condition

The EUT was set to continuously transmitting in the max power during the test.

### 7.5 Test Equipment

Description	Manufacturer	Model No.	Serial No.	Cal. Date	Cal. Due Date
Spectrum Analyzer	ROHDE& SCHWARZ	FSP30	DE25181	2012-12-31	2013-12-30

### 7.6 Test Data



801.11b Mode			
Test Channel	Frequency (MHz)	Peak Output Power (dBm)	Limit (dBm)
CH01	2412	17.09	30
CH 06	2437	17.09	30
CH11	2462	17.02	30

### 2412 MHz

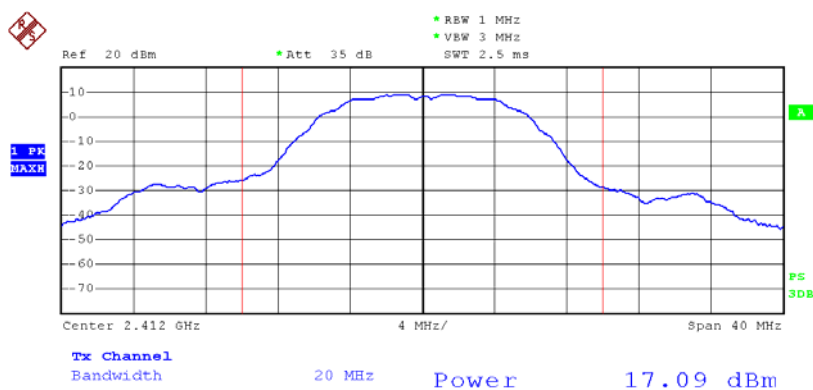

Date: 30.JUL.2013 14:35:16

### 2437 MHz

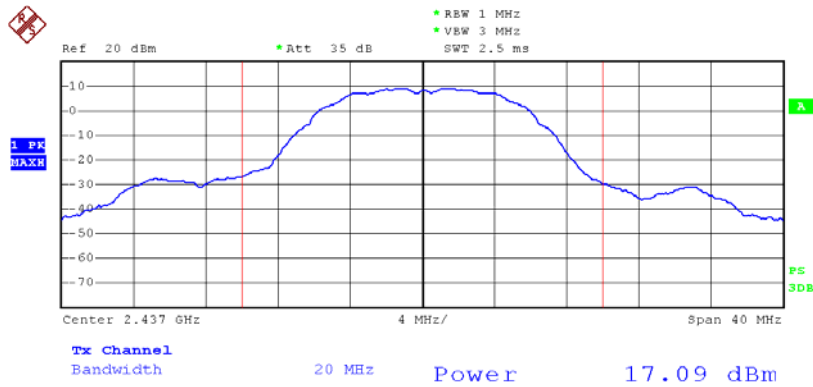

Date: 30.JUL.2013 14:36:44

### 2462 MHz

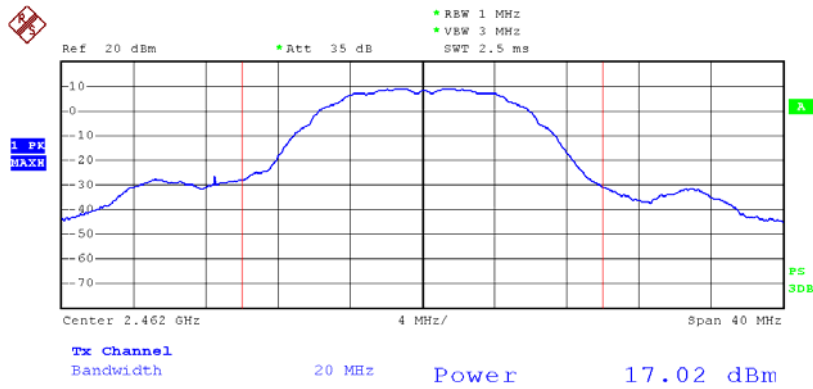

Date: 30.JUL.2013 14:38:06

801.11g Mode			
Test Channel	Frequency (MHz)	Peak Output Power (dBm)	Limit (dBm)
CH01	2412	16.79	30
CH 06	2437	16.92	30
CH11	2462	16.82	30

### 2412 MHz

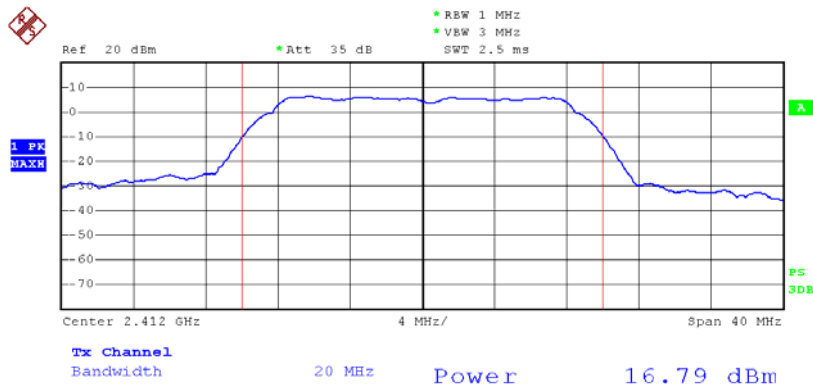

Date: 30.JUL.2013 14:44:36

### 2437 MHz

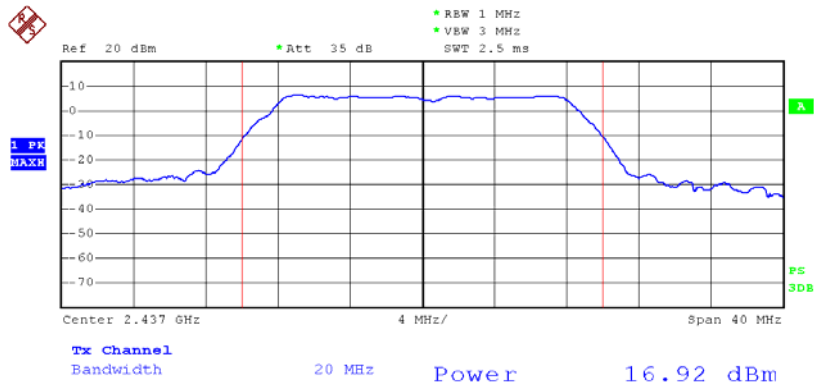

Date: 30.JUL.2013 14:42:30

### 2462 MHz

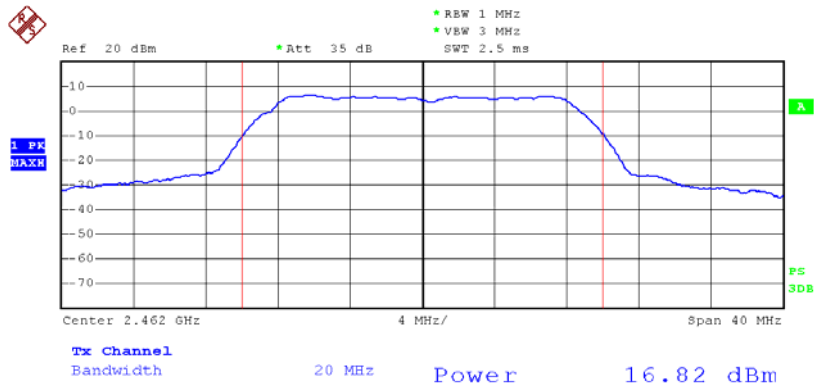

Date: 30.JUL.2013 14:41:04

801.11n(HT20) Mode			
Test Channel	Frequency (MHz)	Peak Output Power (dBm)	Limit (dBm)
CH01	2412	15.52	30
CH 06	2437	15.76	30
CH11	2462	15.62	30

### 2412 MHz

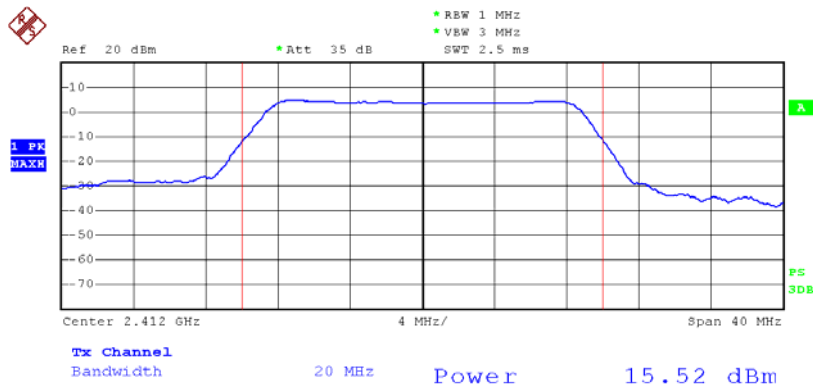

Date: 30.JUL.2013 14:46:04

### 2437 MHz

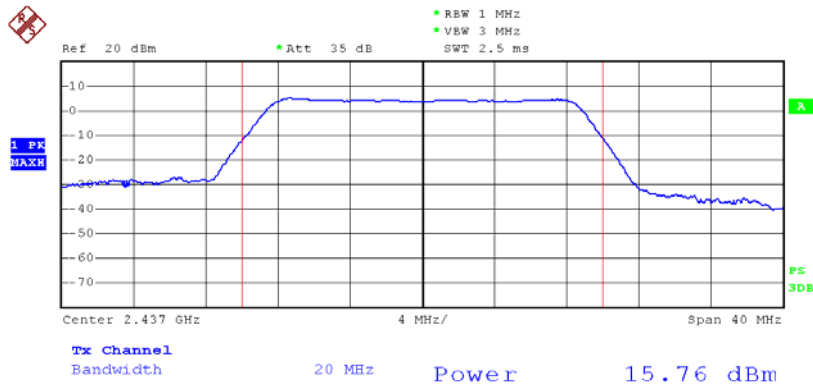

Date: 30.JUL.2013 14:46:54

### 2462 MHz

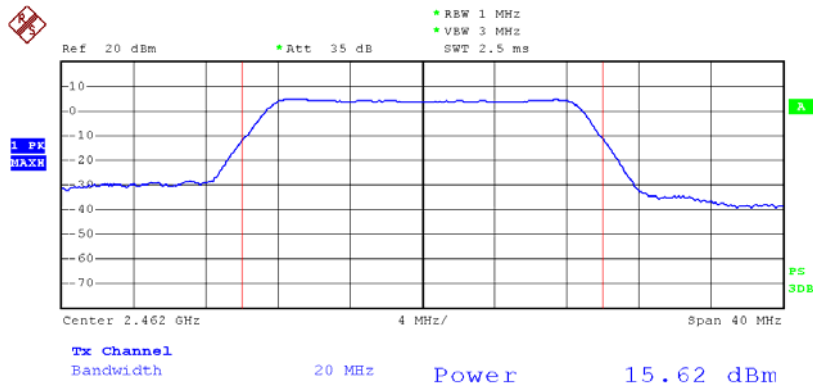

Date: 30.JUL.2013 14:48:25

801.11n(HT40) Mode			
Test Channel	Frequency (MHz)	Peak Output Power (dBm)	Limit (dBm)
CH03	2422	14.74	30
CH 06	2437	14.75	30
CH09	2452	14.56	30

### 2422 MHz

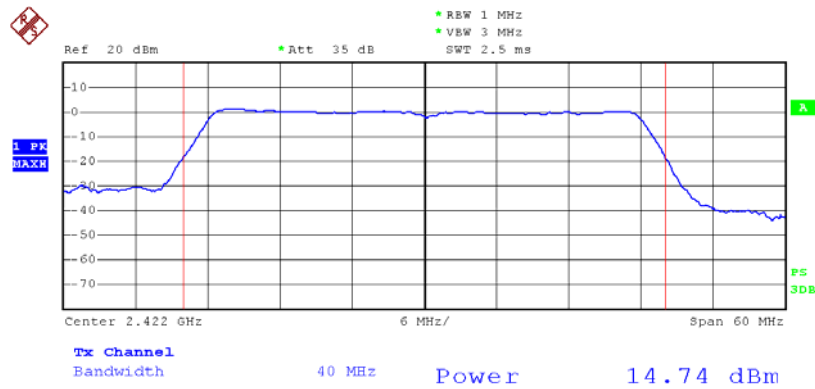

Date: 30.JUL.2013 14:53:42

### 2437 MHz

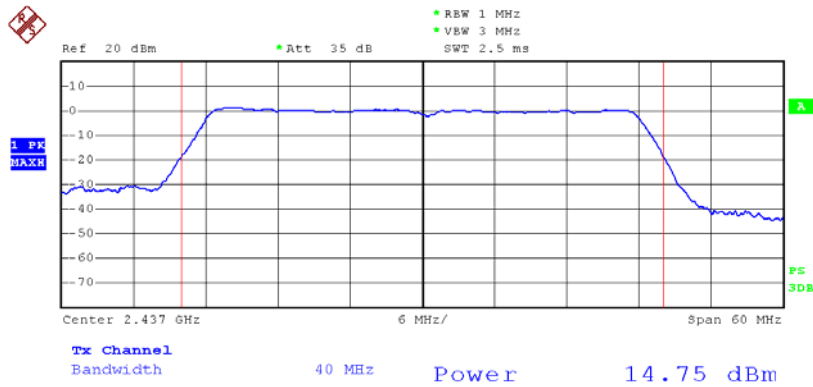

Date: 30.JUL.2013 14:51:55

### 2452 MHz

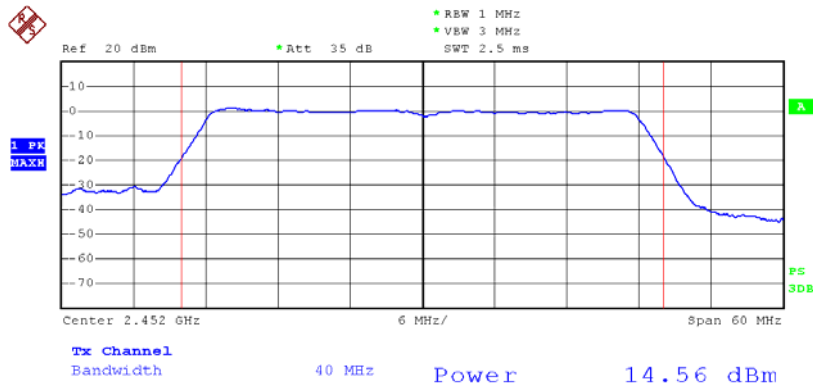

Date: 30.JUL.2013 14:50:47



## 8. Power Spectral Density Test

### 8.1 Test Standard and Limit

#### 8.1.1 Test Standard

FCC Part 15.247 (e)/RSS-210

#### 8.1.2 Test Limit

FCC Part 15 Subpart C(15.247)		
Test Item	Limit	Frequency Range(MHz)
Power Spectral Density	8dBm(in any 3 kHz)	2400~2483.5

### 8.2 Test Setup

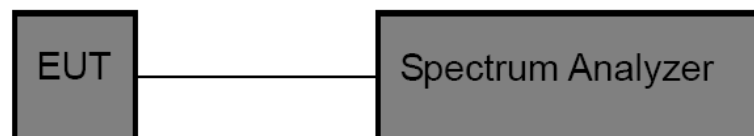

### 8.3 Test Procedure

- (1) The EUT was directly connected to the spectrum analyzer and antenna output port as show in the block diagram above.
- (2) Measure the spectral power density the spectrum analyzer was set to Resolution Bandwidth=100 kHz, and Video Bandwidth  $\geq 300$  kHz, Detector: Peak, Span to 5%~30% greater than EBW, Sweep time auto.
- (3) Scale the observed power level to an equivalent value in 3 kHz by adjusting (reducing) the measured power by a BWCF=-15.2 dB.

### 8.4 EUT Operating Condition

The EUT was set to continuously transmitting in each mode and low, middle and high channel for the test.

### 8.5 Test Equipment

Description	Manufacturer	Model No.	Serial No.	Cal. Date	Cal. Due Date
Spectrum Analyzer	ROHDE& SCHWARZ	FSP30	DE25181	2012-12-31	2013-12-30

### 8.6 Test Data



### 2437 MHz

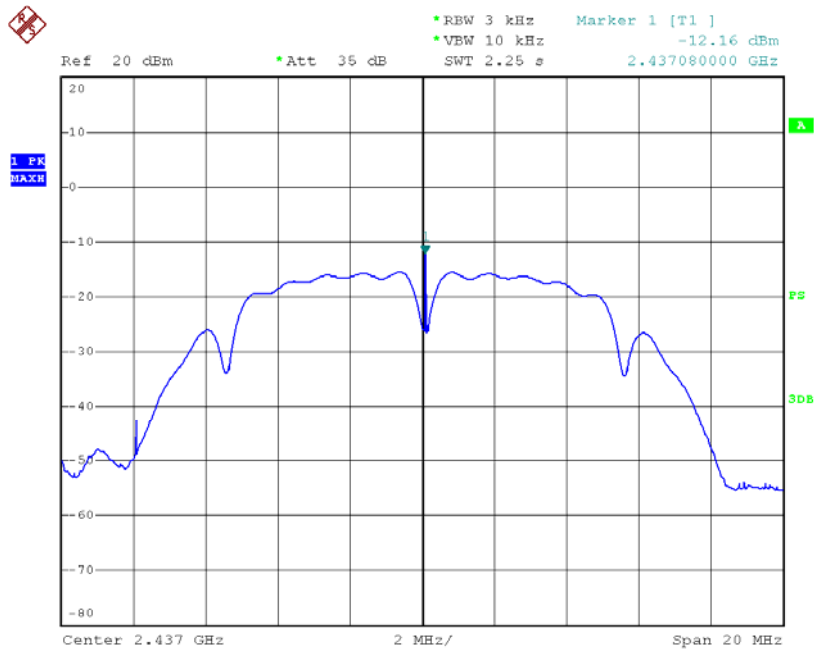

Date: 14.AUG.2013 11:49:49

### 2462 MHz

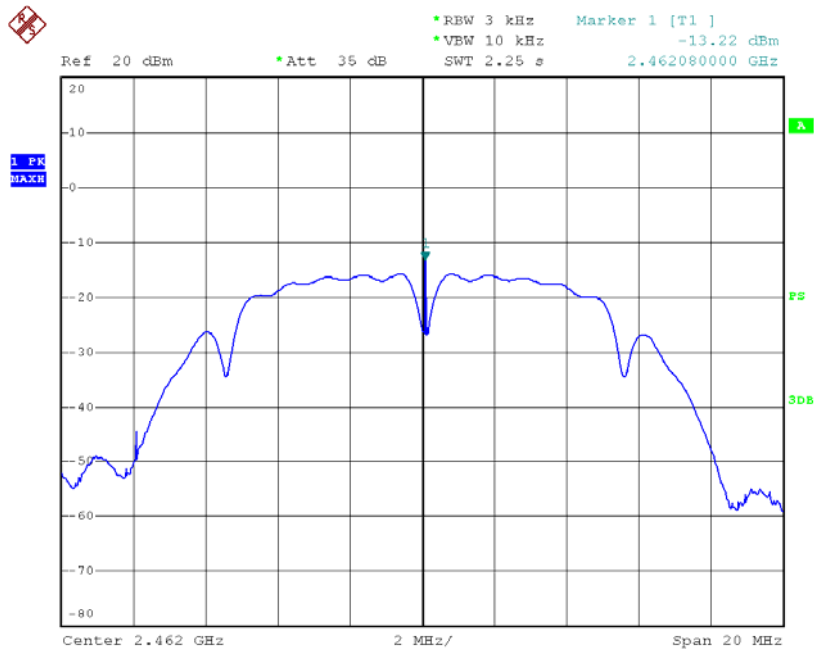

Date: 14.AUG.2013 11:50:36

801.11g Mode			
Test Channel	Frequency (MHz)	Power Density (3 kHz/dBm)	Limit (dBm)
CH 01	2412	-14.86	8
CH 06	2437	-15.33	8
CH 11	2462	-16.25	8

### 2412 MHz

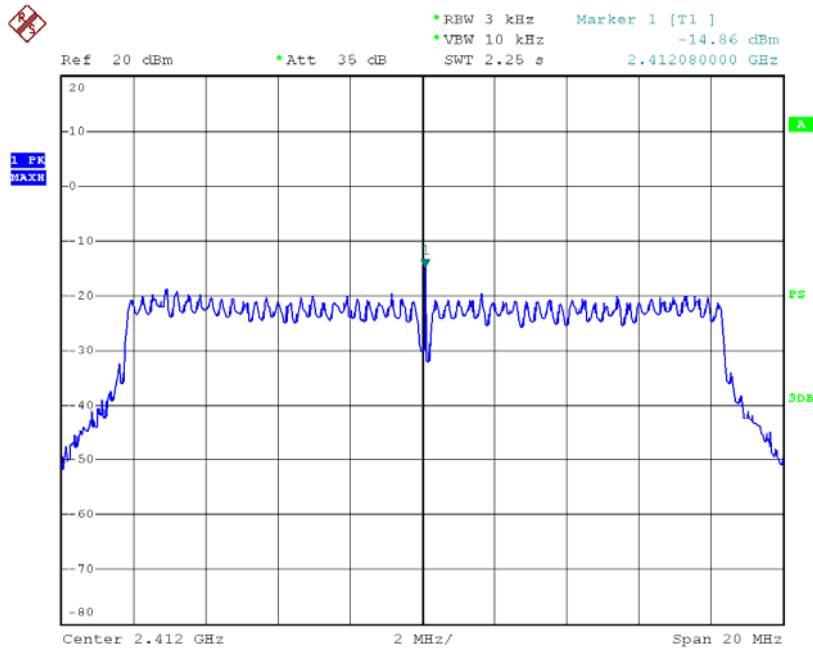

Date: 14.AUG.2013 13:56:32

### 2437 MHz

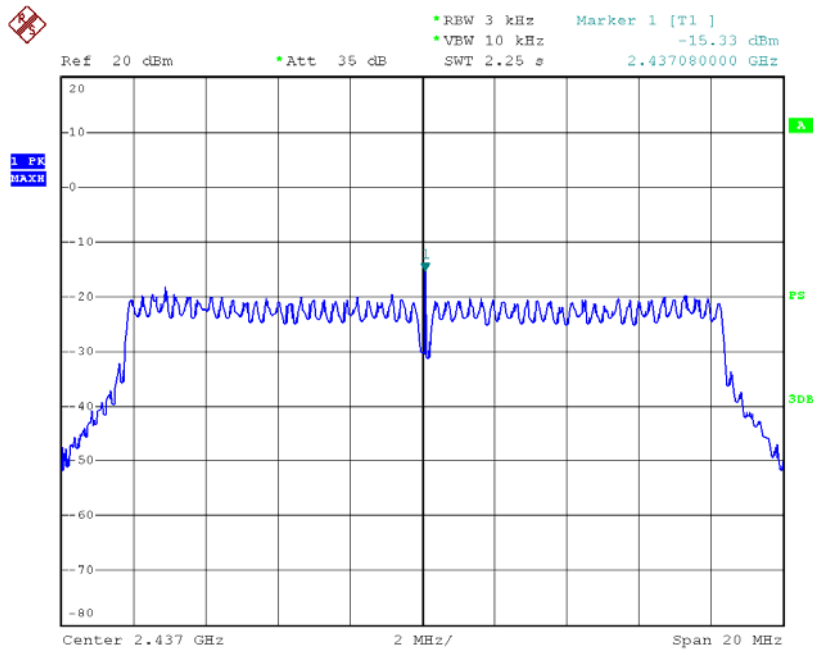

Date: 14.AUG.2013 13:57:46

### 2462 MHz

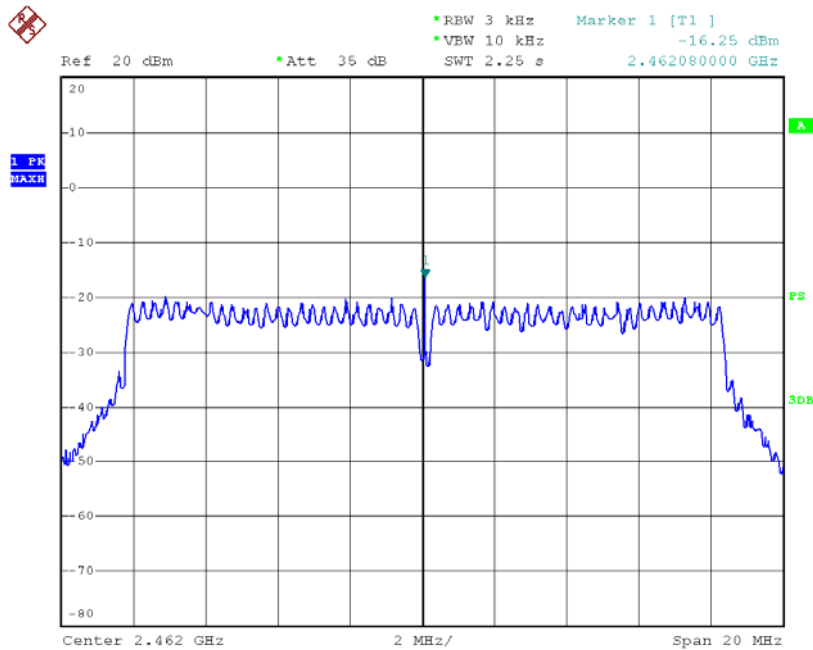

Date: 14.AUG.2013 11:53:43

801.11n(HT20) Mode			
Test Channel	Frequency (MHz)	Power Density (3 kHz/dBm)	Limit (dBm)
CH 01	2412	-14.29	8
CH 06	2437	-15.42	8
CH 11	2462	-15.79	8

2412 MHz

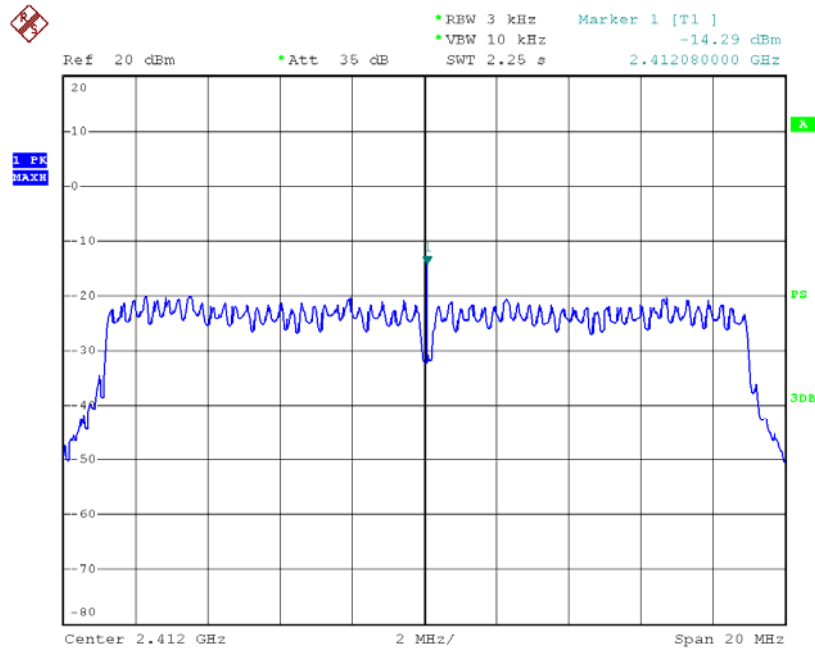

Date: 14.AUG.2013 14:20:08

## 2437 MHz

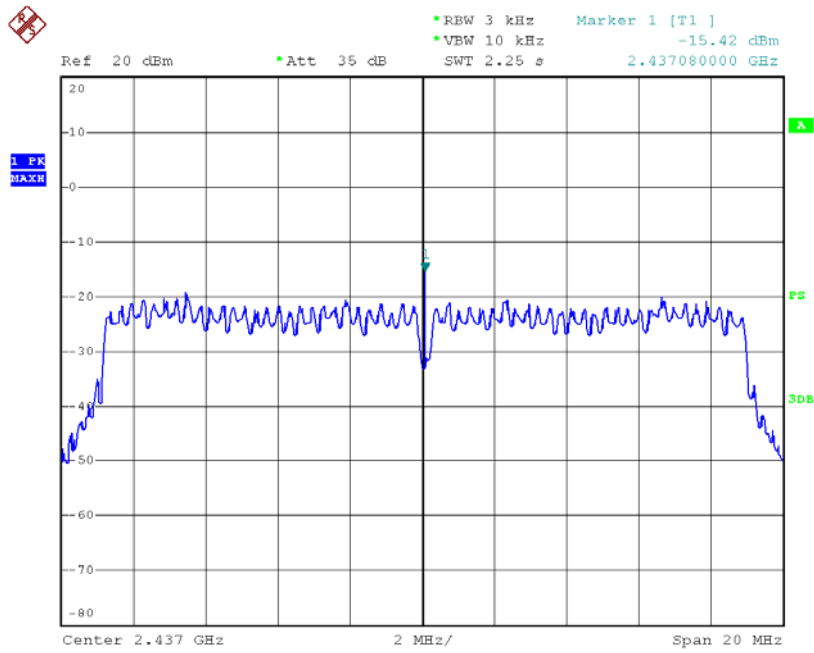

Date: 14.AUG.2013 14:21:51

## 2462 MHz

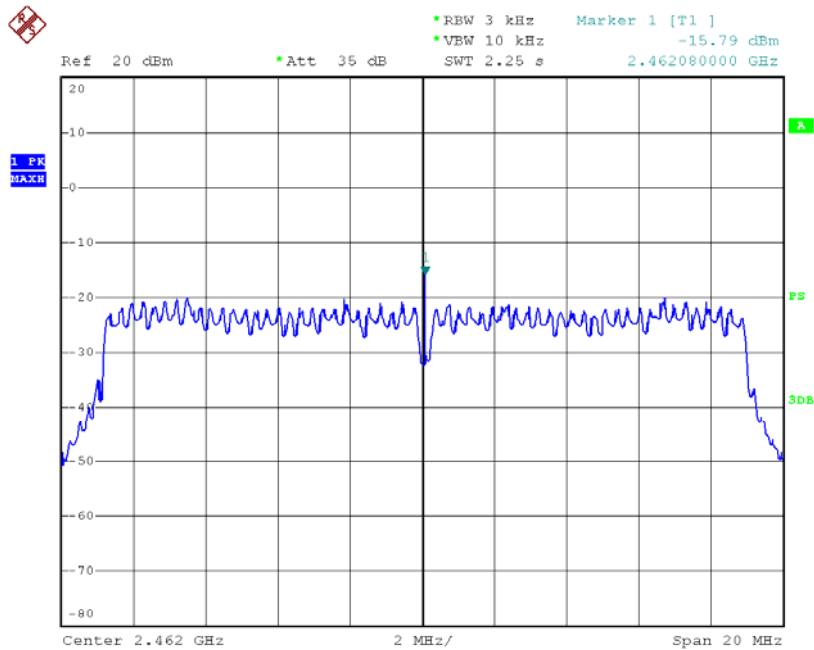

Date: 14.AUG.2013 14:30:53





### 2437 MHz

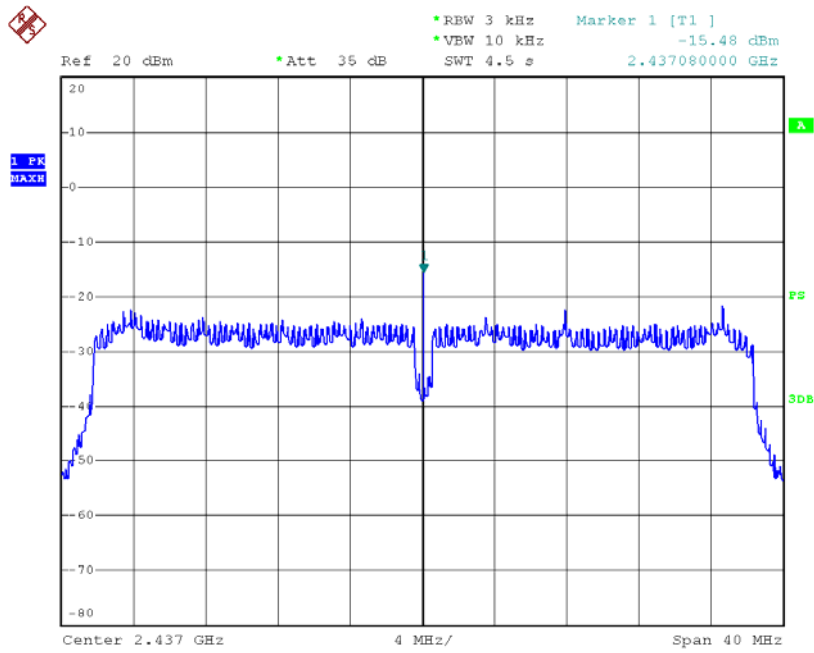

Date: 14.AUG.2013 14:53:36

### 2452 MHz

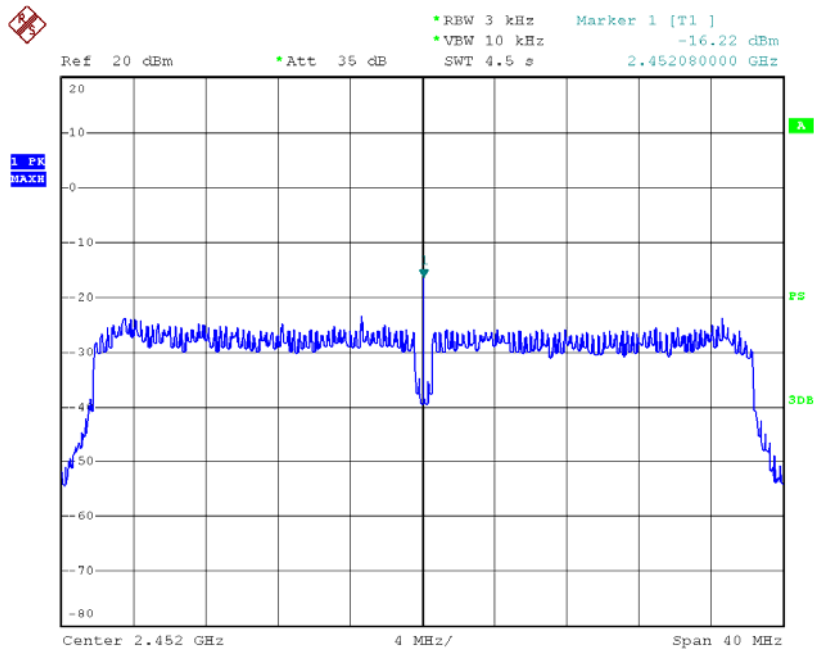

Date: 14.AUG.2013 14:52:09

## 9. Antenna Conducted Spurious Emission

### 9.1 Test Standard and Limit

#### 10.1.1 Test Standard

FCC Part 15.247 (d)/RSS-210 Annex 8 (A8.5)

#### 10.1.2 Test Limit

In any 100 kHz bandwidth outside the frequency band in which the spread spectrum or digitally modulated intentional radiator is operating, the radio frequency power that is produced by the intentional radiator shall be at least 20 dB below that in the 100 kHz bandwidth within the band that contains the highest level of the desired power. In case the emission fall within the restricted band specified on 15.205(a), then the 15.209(a) limit in the table below has to be followed.

Frequencies (MHz)	Field Strength (microvolt/meter)	Measurement Distance (meters)
0.009~0.490	2400/F(KHz)	300
0.490~1.705	24000/F(KHz)	30
1.705~30.0	30	30
30~88	100	3
88~216	150	3
216~960	200	3
Above~960	500	3

(2)If the peak output power procedure is used to measure the fundamental emission power to demonstrate compliance to 15.247(b)(3) requirements, then the peak conducted output power measured within any 100 kHz outside the authorized frequency band shall be attenuated by at least 20 dB relative to the maximum measured in-band peak PSD level.

### 9.2 Test Setup

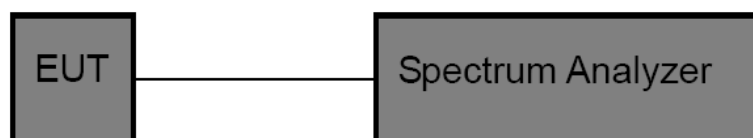

### 9.3 Test Procedure

(1) The EUT was directly connected to the spectrum analyzer and antenna output port as show in the block diagram above.

## (2) Spectrum Setting:

RBW=100 KHz, VBW=300 KHz.

Frequency range: from 30MHz to 26.5 GHz.

**9.4 EUT Operating Condition**

The EUT was set to continuously transmitting in the max power during the test.

**9.5 Test Equipment**

<b>Description</b>	<b>Manufacturer</b>	<b>Model No.</b>	<b>Serial No.</b>	<b>Cal. Date</b>	<b>Cal. Due Date</b>
Spectrum Analyzer	ROHDE& SCHWARZ	FSP30	DE25181	2012-12-31	2013-12-30

**9.6 Test Data**

802.11b Mode TX CH 01 2412MHz

Above 1 GHz

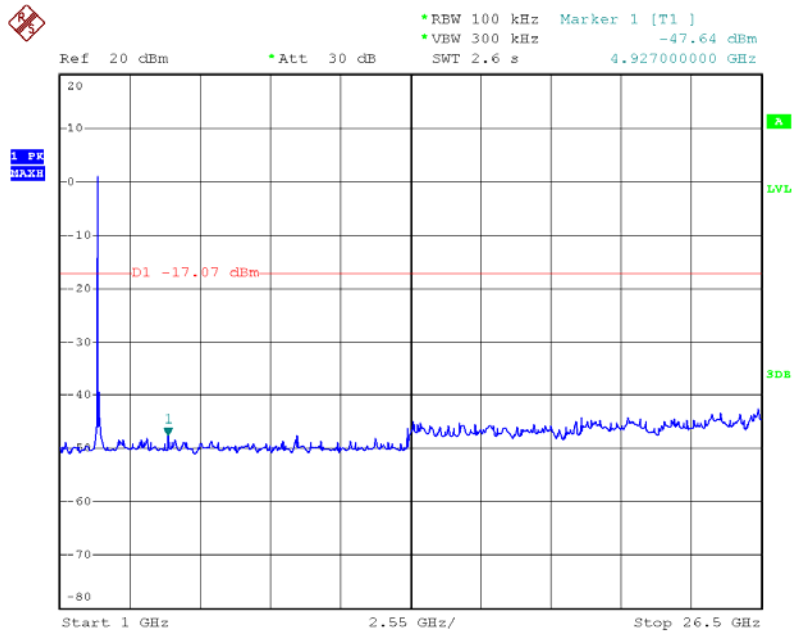

Date: 14.AUG.2013 15:12:26

Bellow 1 GHz

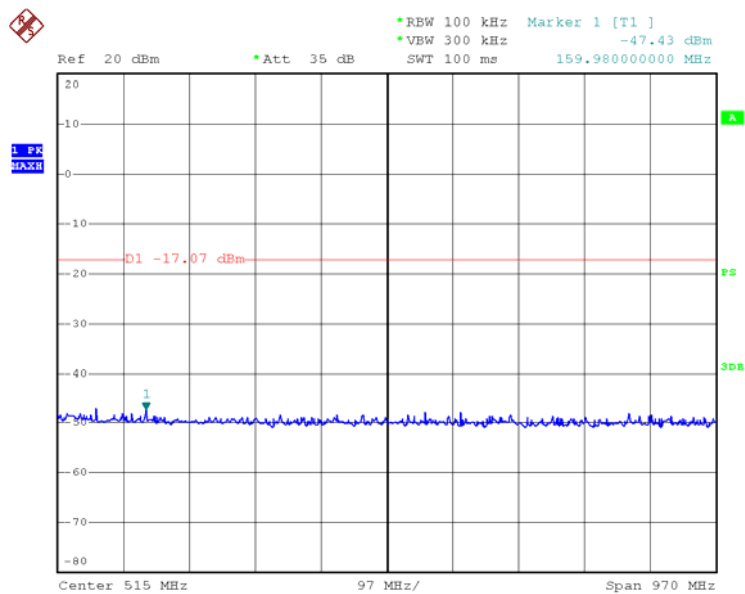

Date: 14.AUG.2013 15:07:26

802.11b Mode TX CH 06 2437MHz

Above 1 GHz

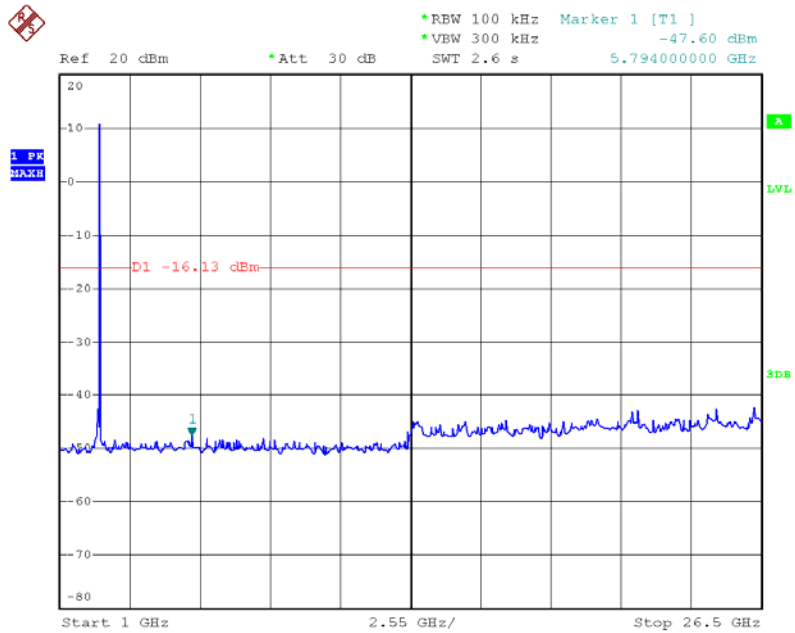

Date: 14.AUG.2013 15:14:23

Bellow 1 GHz

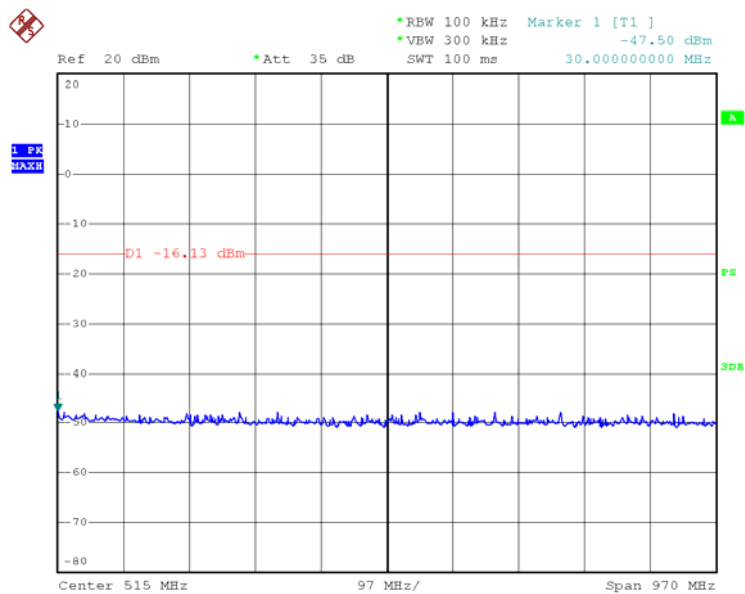

Date: 14.AUG.2013 15:08:25

802.11b Mode

TX CH 11 2462MHz

Above 1 GHz

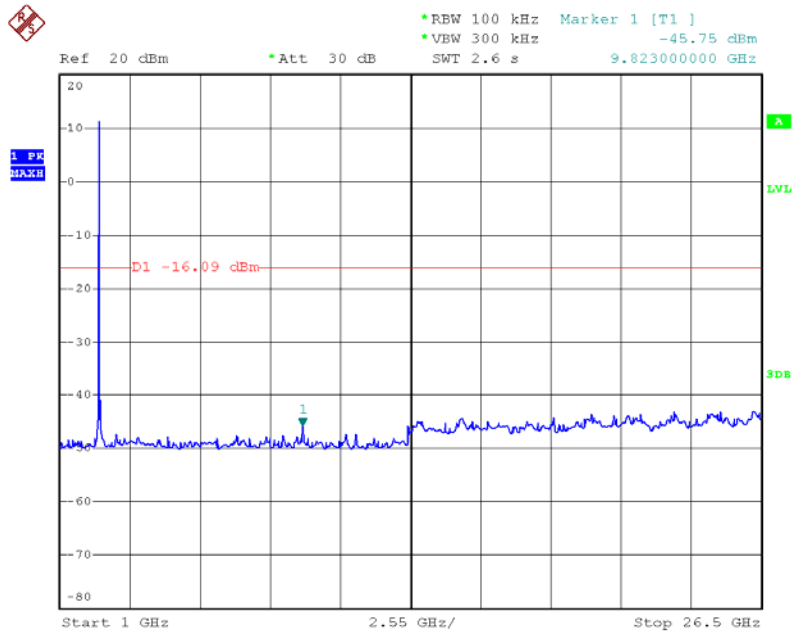

Date: 14.AUG.2013 15:21:34

Bellow 1 GHz

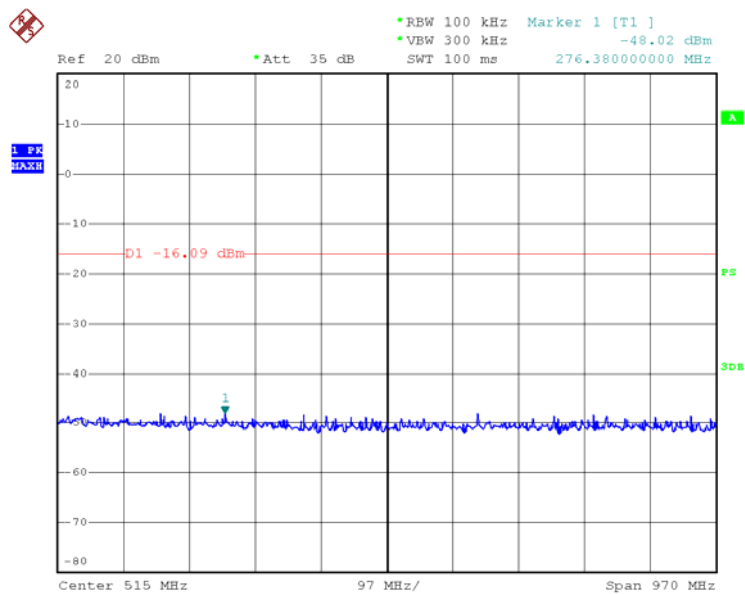

Date: 14.AUG.2013 15:09:12

802.11g Mode TX CH 01 2412MHz

Above 1 GHz

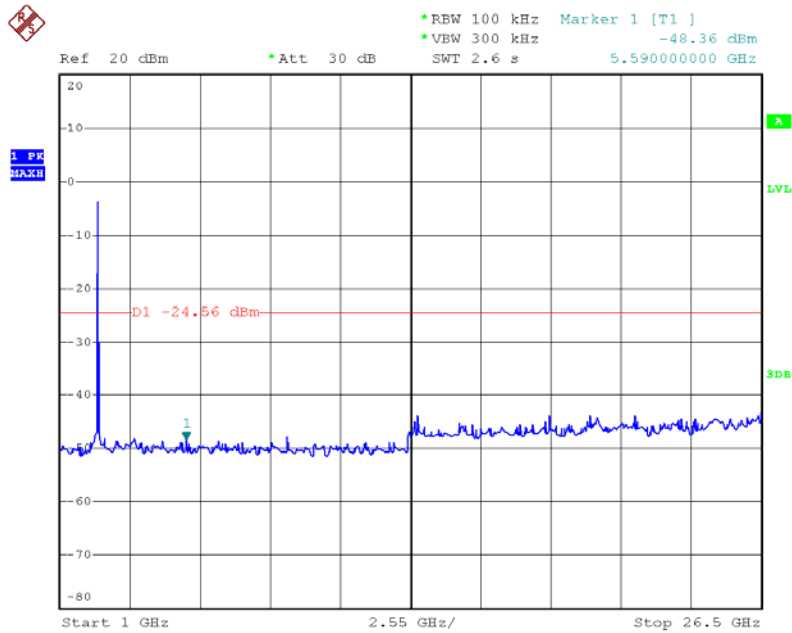

Date: 14.AUG.2013 15:31:33

Bellow 1 GHz

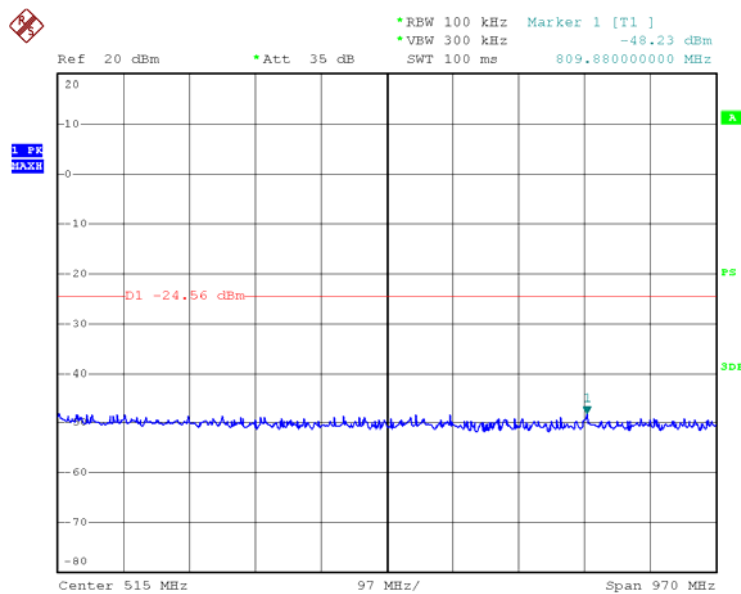

Date: 14.AUG.2013 15:10:45

802.11g Mode TX CH 06 2437MHz

Above 1 GHz

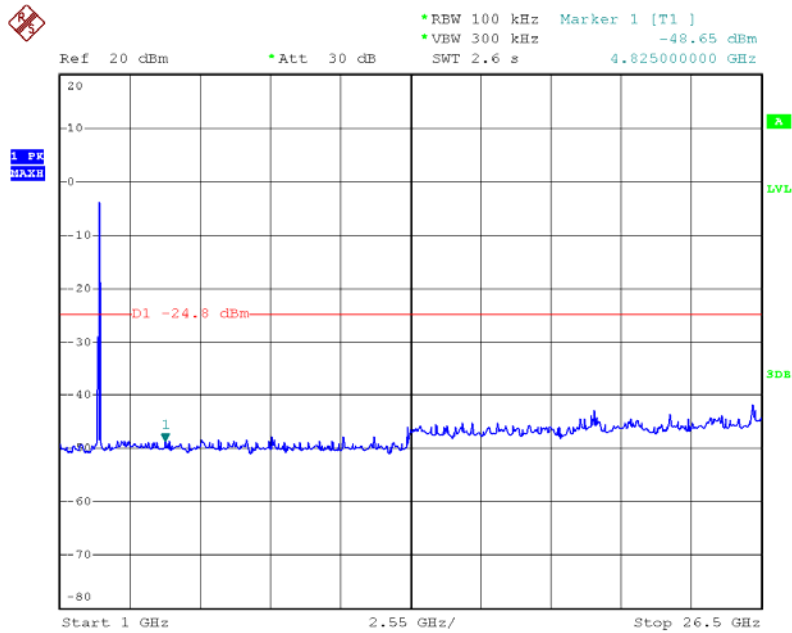

Date: 14.AUG.2013 15:29:49

Bellow 1 GHz

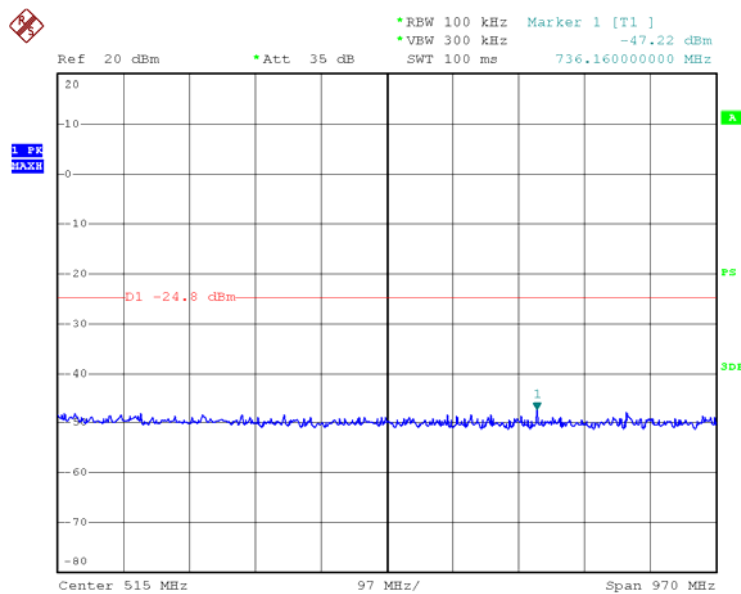

Date: 14.AUG.2013 15:11:32



802.11g Mode

TX CH 11 2462MHz

Above 1 GHz

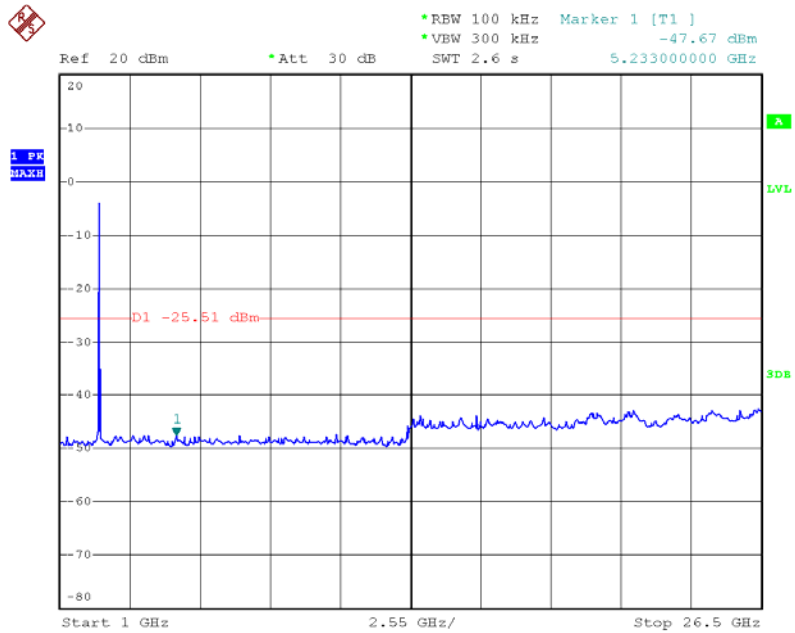

Date: 14.AUG.2013 15:25:47

Bellow 1 GHz

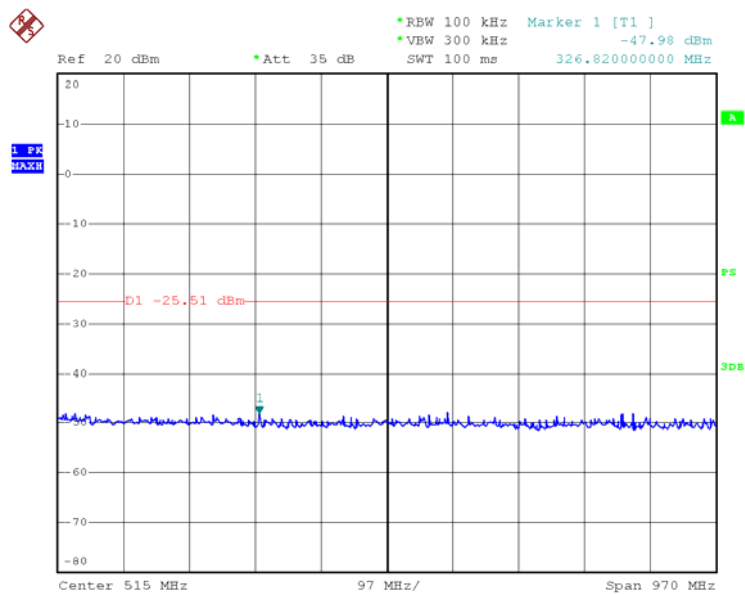

Date: 14.AUG.2013 15:12:22

802.11n (HT20) Mode TX CH 01 2412MHz

Above 1 GHz

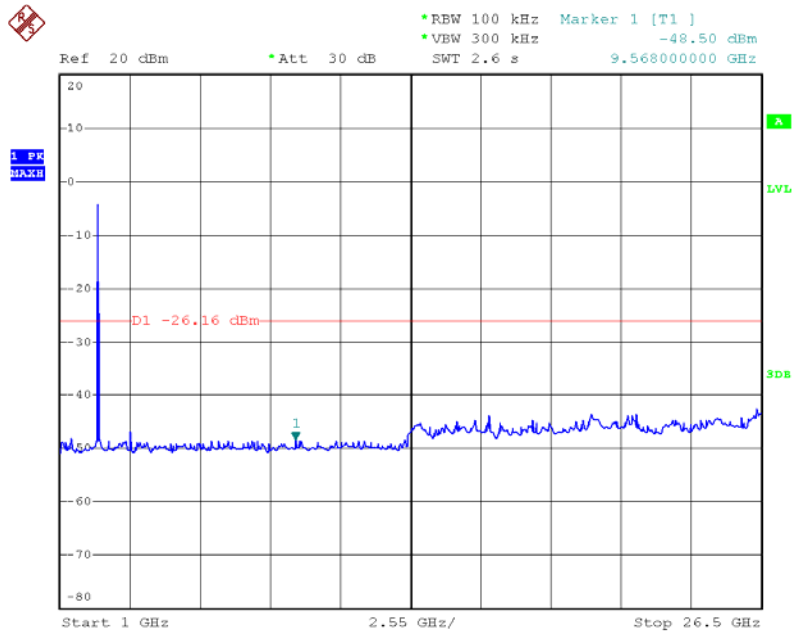

Date: 14.AUG.2013 15:35:44

Bellow 1 GHz

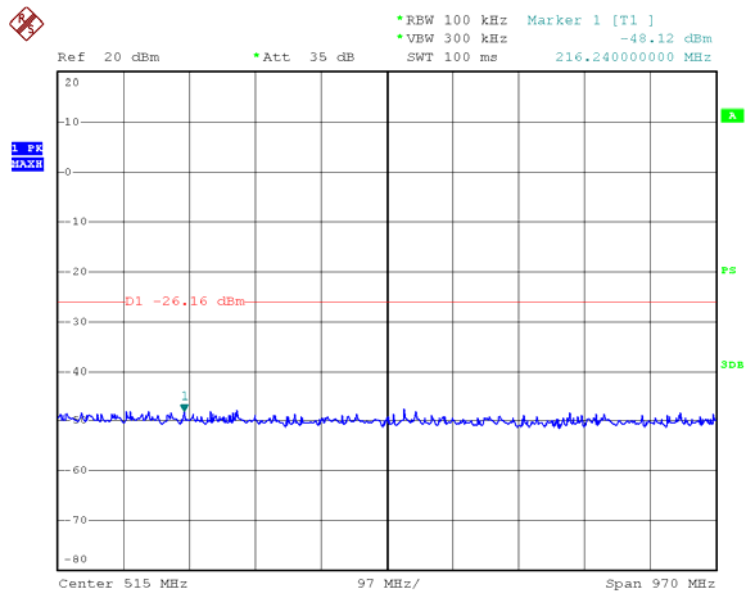

Date: 14.AUG.2013 15:15:35

802.11n (HT20) Mode TX CH 06 2437MHz

Above 1 GHz

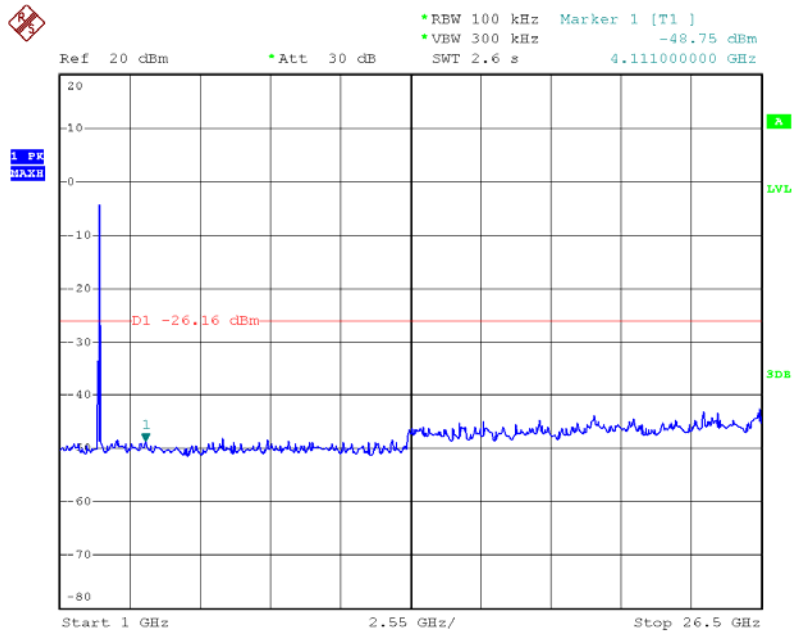

Date: 14.AUG.2013 15:39:05

Bellow 1 GHz

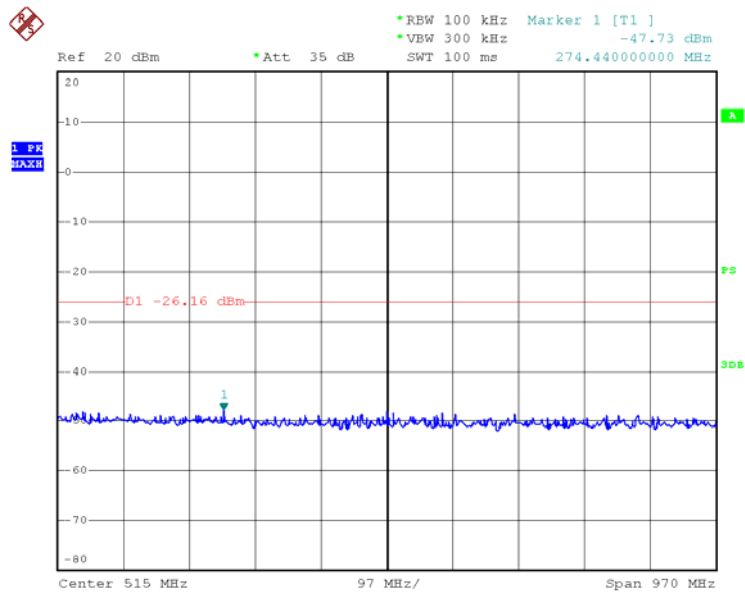

Date: 14.AUG.2013 15:16:19

802.11n (HT20) Mode

TX CH 11 2462MHz

Above 1 GHz

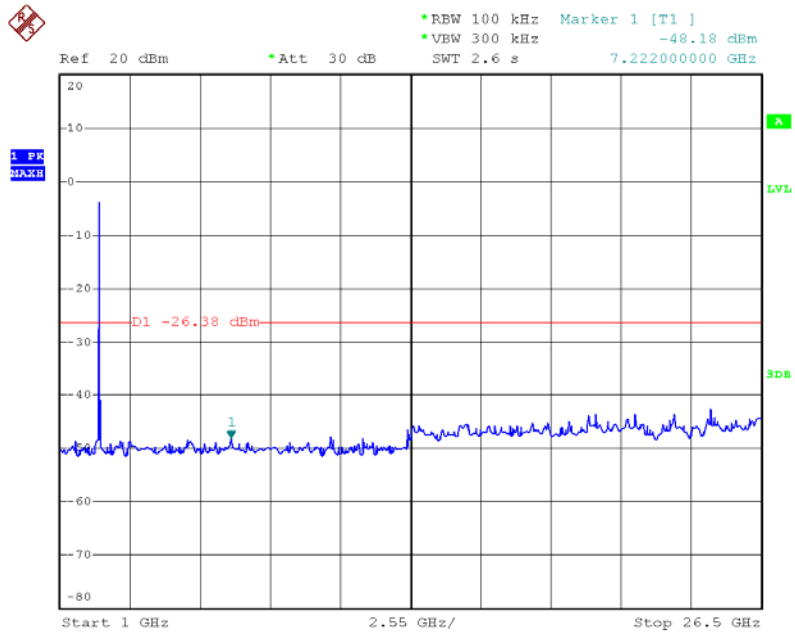

Date: 14.AUG.2013 15:41:26

Bellow 1 GHz

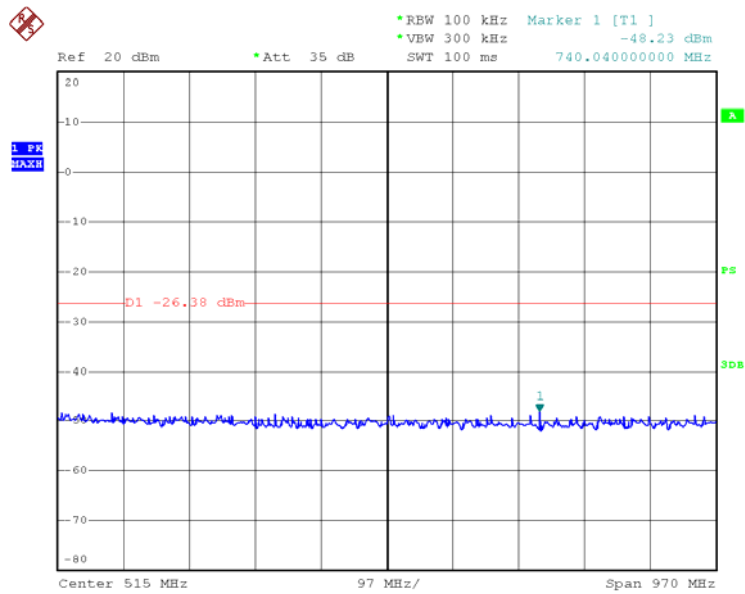

Date: 14.AUG.2013 15:16:54

802.11n (HT40) Mode TX CH 03 2422MHz

Above 1 GHz

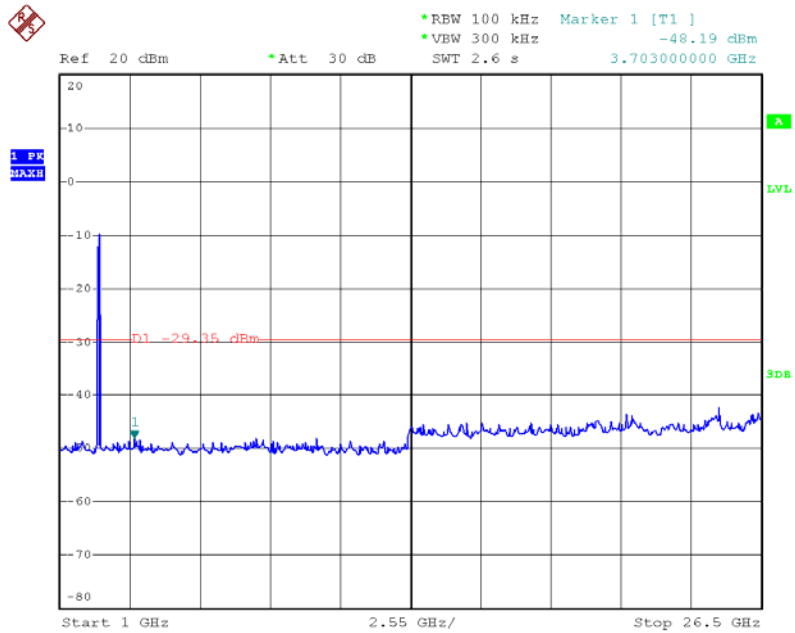

Date: 14.AUG.2013 15:13:34

Bellow 1 GHz

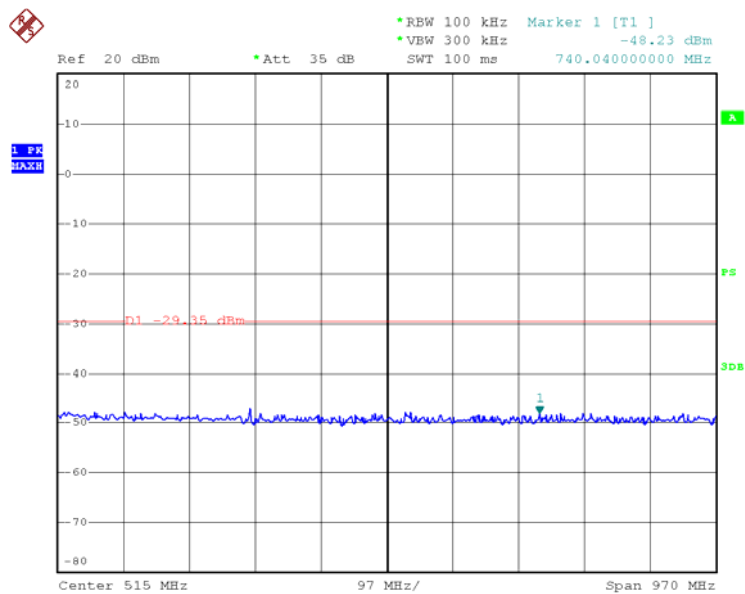

Date: 14.AUG.2013 15:18:20

802.11n (HT40) Mode TX CH 06 2437MHz

Above 1 GHz

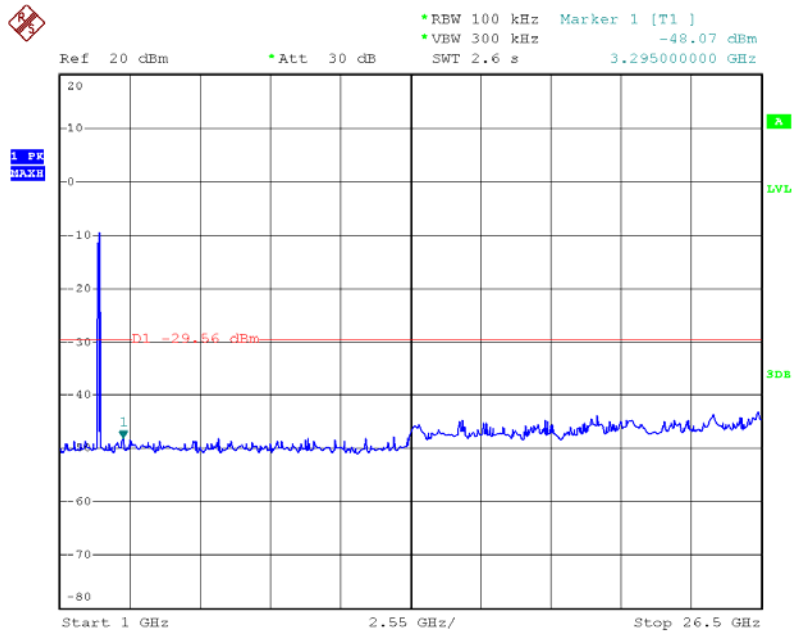

Date: 14.AUG.2013 15:09:22

Bellow 1 GHz

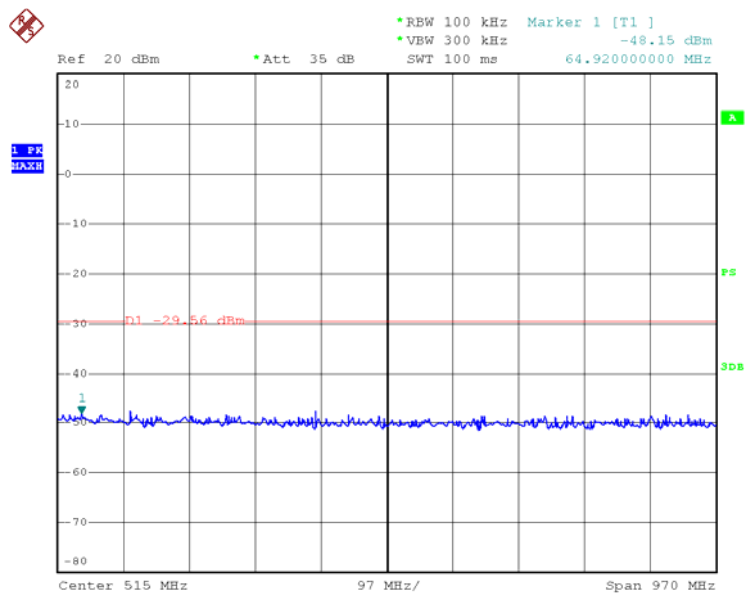

Date: 14.AUG.2013 15:19:02

802.11n (HT40) Mode

TX CH 09 2452MHz

Above 1 GHz

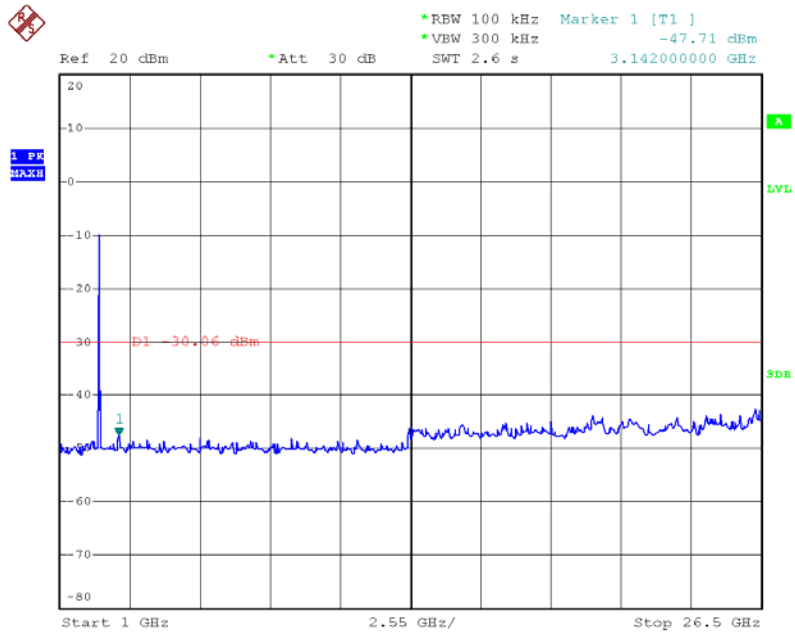

Date: 14.AUG.2013 15:07:59

Bellow 1 GHz

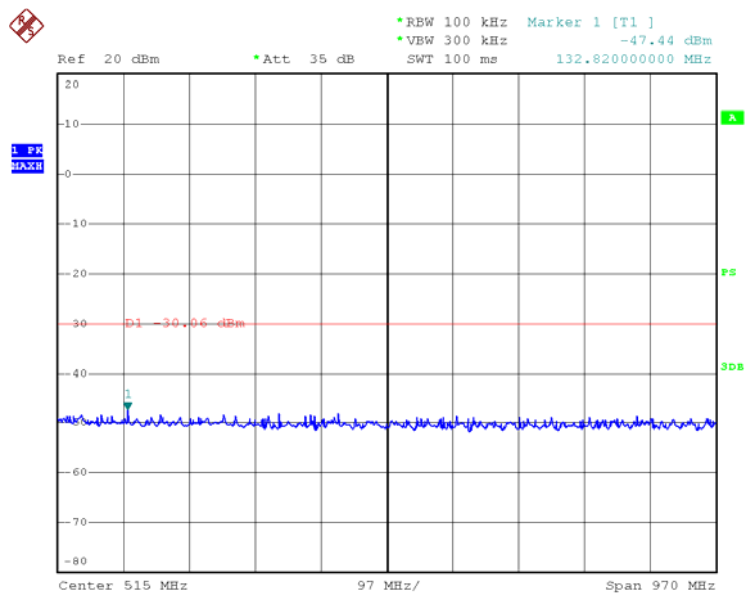

Date: 14.AUG.2013 15:20:14

## 10. Antenna Requirement

### 10.1 Standard Requirement

#### 11.1.1 Standard

FCC Part 15.203

#### 11.1.2 Requirement

An intentional radiator shall be designed to ensure that no antenna other than that furnished by the responsible party shall be used with the device. The use of a permanently attached antenna or of an antenna that uses a unique coupling to the intentional radiator shall be considered sufficient to comply with the provisions of this Section. The manufacturer may design the unit so that a broken antenna can be replaced by the user, but the use of a standard antenna jack or electrical connector is prohibited.

### 10.2 Antenna Connected Construction

The directional gains of the antenna used for transmitting is 2dBi, and the antenna de-signed with permanent attachment and no consideration of replacement. Please see the EUT photo for details.

### 10.2 Result

The EUT antenna is an Integrated Antenna. It complies with the standard requirement.