

FCC Part 15 EMI TEST REPORT

of

E.U.T. : Wireless LAN PC Card

FCC ID. : P8S-ACPC2000

MODEL : ACPC2000-11

for

APPLICANT : AboveCable, Inc.

ADDRESS : 8403 Colesville Rd., Suite 825 Silver Spring, MD
20910 USA

Test Performed by

ELECTRONICS TESTING CENTER, TAIWAN
NO. 34, LIN 5, DING FU TSUN, LINKOU HSIANG
TAIPEI HSIEN, TAIWAN, R.O.C.

Tel:(02)26023052, 26023054

Fax:(02)26010910

Report Number : ET91R-03-032

TEST REPORT CERTIFICATION

Applicant : AboveCable, Inc.
8403 Colesville Rd., Suite 825 Silver Spring, MD 20910 USA

Manufacturer : Z-COM, INC.
7F-2, NO. 9, PROSEPERITY 1ST RD., SCIENCE-BASED
INDUSTRIAL PARK, HSINCHU, TAIWAN, R.O.C.

Description of EUT :

a) Type of EUT : Wireless LAN PC Card

b) Trade Name : ----

c) Model No. : ACPC2000-11

d) Power Supply : From Notebook PC

Regulation Applied : FCC Rules and Regulations Part 15 Subpart B & C (2001)

I HEREBY CERTIFY THAT: The data shown in this report were made in accordance with the procedures given in ANSI C63.4, and the energy emitted by the device was founded to be within the limits applicable. I assume full responsibility for accuracy and completeness of these data.

Note: 1. The result of the testing report relate only to the item tested.
2. The testing report shall not be reproduced expect in full, without the written approval of ETC.

Issued Date : Mar. 12, 2002

Test Engineer : Jeff Chuang
(Jeff Chuang)

Approve & Authorized Signer : Will Yauo
Will Yauo, Manager
EMC Dept. II of ELECTRONICS
TESTING CENTER, TAIWAN

Table of Contents	Page
1 GENERAL INFORMATION.....	1
1.1 Product Description.....	1
1.2 Characteristics of Device	1
1.3 Test Methodology.....	1
1.4 Test Facility	1
2 PROVISIONS APPLICABLE.....	2
2.1 Definition.....	2
2.2 Requirement for Compliance	3
2.3 Restricted Bands of Operation	5
2.4 Labeling Requirement	5
2.5 User Information.....	6
3. SYSTEM TEST CONFIGURATION.....	7
3.1 Justification.....	7
3.2 Devices for Tested System	7
4 RADIATED EMISSION MEASUREMENT.....	8
4.1 Applicable Standard	8
4.2 Measurement Procedure.....	8
4.3 Measuring Instrument.....	10
4.4 Radiated Emission Data	11
4.4.1 RF Portion.....	11
4.4.2 Other Emission.....	14
4.5 Field Strength Calculation	14
4.6 Photos of Radiation Measuring Setup	15
5 CONDUCTED EMISSION MEASUREMENT.....	16
5.1 Standard Applicable	16
5.2 Measurement Procedure.....	16
5.3 Conducted Emission Data	17
5.4 Result Data Calculation.....	18
5.5 Conducted Measurement Equipment.....	19
5.6 Photos of Conduction Measuring Setup	20
6 ANTENNA REQUIREMENT	21
6.1 Standard Applicable	21
6.2 Antenna Construction and Directional Gain	21
7 EMISSION BANDWIDTH MEASUREMENT	22

7.1 Standard Applicable	22
7.2 Measurement Procedure.....	22
7.3 Measurement Equipment.....	22
7.4 Measurement Data	23
8 OUTPUT POWER MEASUREMENT.....	24
8.1 Standard Applicable	24
8.2 Measurement Procedure.....	24
8.3 Measurement Equipment.....	24
8.4 Measurement Data	25
9 100 kHz BANDWIDTH OF BAND EDGES MEASUREMENT.....	26
9.1 Standard Applicable	26
9.2 Measurement Procedure.....	26
9.3 Measurement Equipment.....	26
9.4 Measurement Data	27
10 POWER DENSITY MEASUREMENT.....	28
10.1 Standard Applicable	28
10.2 Measurement Procedure.....	28
10.3 Measurement Equipment.....	28
10.4 Measurement Data	29
11 PROCESSING GAIN MEASUREMENT	30
11.1 Standard Applicable	30
11.2 Measurement Description.....	30
11.3 Measurement Instrument.....	33
11.4 Measurement Data	33
APPENDIX 1 : PLOTTED DATAS OF POWER LINE CONDUCTED EMISSIONS.....	34
APPENDIX 2 : ENGINEERING GRAPH OF ANTENNA CONSTRUCTION	35
APPENDIX 3 : PLOTTED DATAS OF EMISSIONS BANDWIDTH.....	36
APPENDIX 4 : PLOTTED DATAS OF OUTPUT PEAK POWER.....	37
APPENDIX 5 : PLOTTED DATAS OF BAND EDGE EMISSION.....	38
APPENDIX 6 : PLOTTED DATAS OF POWER DENSITY.....	39
APPENDIX 7 : PROCESSING GAIN TESTED DATA SHEETS.....	40

1 GENERAL INFORMATION

1.1 Product Description

- a) Type of EUT : Wireless LAN PC Card
- b) Trade Name : ----
- c) Model No. : ACPC2000-11
- d) Power Supply : From Notebook PC

1.2 Characteristics of Device

The Wireless LAN PC Card designed with a transmitting method of direct sequence spread spectrum is for local area network operation, which operates at 2.4 GHz ISM band and data rate up to 11 Mbps. The spread spectrum unit is HFA3861 and the rated output power is 10.8 dBm (12.0 mW).

1.3 Test Methodology

The Wireless LAN PC Card designed with a transmitting method of direct sequence spread spectrum is for local area network operation, which operates at 2.4 GHz ISM band and data rate up to 11 Mbps. The spread spectrum unit is HFA3861 and the rated output power is 10.8 dBm (12.0 mW).

1.4 Test Facility

The open area test site and conducted measurement facility used to collect the radiated data is located on the roof top of Building at No. 34, Lin 5, Ding Fu Tsun, Linkou Hsiang, Taipei Hsien, Taiwan 244, R.O.C.

This site has been fully described in a report submitted to your office, and accepted in a letter dated Feb. 10, 2000.

2 PROVISIONS APPLICABLE

2.1 Definition

Unintentional radiator:

A device that intentionally generates and radio frequency energy for use within the device, or that sends radio frequency signals by conduction to associated equipment via connecting wiring, but which is not intended to emit RF energy by radiation or induction.

Class A Digital Device:

A digital device which is marketed for use in commercial or business environment; exclusive of a device which is market for use by the general public, or which is intended to be used in the home.

Class B Digital Device :

A digital device which is marketed for use in a residential environment notwithstanding use in a commercial, business of industrial environment. Example of such devices that are marketed for the general public.

Note : A manufacturer may also qualify a device intended to be marketed in a commercial, business, or industrial environment as a Class B digital device, and in fact is encouraged to do so, provided the device complies with the technical specifications for a Class B Digital Device. In the event that a particular type of device has been found to repeatedly cause harmful interference to radio communications, the Commission may classify such a digital device as a Class B Digital Device, Regardless of its intended use.

Intentional radiator:

A device that intentionally generates and emits radio frequency energy by radiation or induction.

2.2 Requirement for Compliance

(1) Conducted Emission Requirement

For unintentional device, according to § 15.107(a) Line Conducted Emission Limits is as following:

Frequency MHz	Emissions μ V	Emissions dB μ V
0.45 - 30.0	250	48.0

For intentional device, according to § 15.207(a) Line Conducted Emission Limits is same as above table.

(2) Radiated Emission Requirement

For unintentional device, according to § 15.109(a), except for Class A digital devices, the field strength of radiated emissions from unintentional radiators at a distance of 3 meters shall not exceed the following values:

Frequency MHz	Distance Meters	Radiated dB μ V/m	Radiated μ V/m
30 - 88	3	40.0	100
88 - 216	3	43.5	150
216 - 960	3	46.0	200
Above 960	3	54.0	500

For intentional device, according to § 15.209(a), the general requirement of field strength of radiated emissions from intentional radiators at a distance of 3 meters shall not exceed the above table.

(3) Antenna Requirement

For intentional device, according to § 15.203, an intentional radiator shall be designed to ensure that no antenna other than that furnished by the responsible party shall be used with the device.

(4) Bandwidth Requirement

For direct sequence system, according to 15.247(a)(2), the minimum 6dB bandwidth shall be at least 500 kHz.

(5) Output Power Requirement

For direct sequence system, according to 15.247(b), the maximum peak output power of the transmitter shall not exceed 1 Watt. If transmitting antennas of directional gain greater than 6 dBi are used, the power shall be reduced by the amount in dB that the directional gain of the antenna exceeds 6 dBi.

(6) 100 kHz Bandwidth of Frequency Band Edges Requirement

According to 15.247(c), if any 100 kHz bandwidth outside these frequency bands, the radio frequency power that is produced by the modulation products of the spreading sequence, the information sequence and the carrier frequency shall be either at least 20 dB below that in any 100 kHz bandwidth within the band that contains the highest level of the desired power or shall not exceed the general levels specified in § 15.209(a), whichever results in the lesser attenuation.

(7) Power Density Requirement

According to 15.247(d), for direct sequence systems, the transmitted power density averaged over any 1 second interval shall not be greater than 8 dBm in any 3 kHz bandwidth within these bands.

(8) Processing Gain Requirement

According to 15.247(e), the processing gain of a direct sequence system shall be at least 10 dB. The processing gain shall be determined from the ratio in dB of the signal to noise ratio with the system spreading code turned off to the signal to noise ratio with the system spreading code turned on, as measured at the demodulated output of the receiver.

2.3 Restricted Bands of Operation

Only spurious emissions are permitted in any of the frequency bands listed below :

MHz	MHz	MHz	GHz
0.090 - 0.110	16.42-16.423	399.9-410	4.5-5.25
0.495 - 0.505 **	16.69475 - 16.69525	608-614	5.35-5.46
2.1735 - 2.1905	16.80425 - 16.80475	960-1240	7.25-7.75
4.125-4.128	25.5-25.67	1300-1427	8.025-8.5
4.17725-4.17775	37.5-38.25	1435-1626.5	9.0-9.2
4.20725-4.20775	73-74.6	1645.5-1646.5	9.3-9.5
6.215-6.218	74.8-75.2	1660-1710	10.6-12.7
6.26775-6.26825	108-121.94	1718.8-1722.2	13.25-13.4
6.31175-6.31225	123-138	2200-2300	14.47-14.5
8.291-8.294	149.9-150.05	2310-2390	15.35-16.2
8.362-8.366	156.52475 - 156.52525	2483.5-2500	17.7-21.4
8.37625-8.38675	156.7-156.9	2655-2900	22.01-23.12
8.41425-8.41475	162.0125-167.17	3260-3267	23.6-24.0
12.29-12.293	167.72-173.2	3332-3339	31.2-31.8
12.51975-12.52025	240-285	3345.8-3358	36.43-36.5
12.57675-12.57725	322-335.4	3360-4400	Above 38.6
13.36-13.41			

** : Until February 1, 1999, this restricted band shall be 0.490-0.510 MHz

2.4 Labeling Requirement

The device shall bear the following statement in a conspicuous location on the device :

This device complies with part 15 of the FCC Rules. Operation is subject to the following two conditions : (1) This device may not cause harmful interference, and (2) this device must accept any interference received, including interference that may cause undesired operation.

2.5 User Information

The users manual or instruction manual for an intentional or unintentional radiator shall caution the user that changes or modifications not expressly approved by the party responsible for compliance could void the user's authority to operate the equipment.

For a Class B digital device or peripheral, the instructions furnished the user shall include the following or similar statement, placed in a prominent location in the text of the manual.

The Federal Communications Commission Radio Frequency Interference Statement includes the following paragraph.

This equipment has been tested and found to comply with the limits for a Class B Digital Device, pursuant to Part 15 of the FCC Rules. These limits are designed to provide reasonable protection against harmful interference in a residential installation.

This equipment generates, uses and can radiate radio frequency energy and, if not installed and used in accordance with the instruction may cause harmful interference to radio communication. However, there is no guarantee that interference will not occur in a particular installation.

If this equipment does cause harmful interference to radio or television reception, which can be determined by turning the equipment off and on, the user is encouraged to try to correct the interference by one or more of the following measures:

- Reorient or relocate the receiving antenna.
- Increase the separation between the equipment and receiver.
- Connect the equipment into an outlet on a circuit different from that to which the receiver is connected.
- Consult the dealer or an experienced radio / TV technician for help.

3. SYSTEM TEST CONFIGURATION

3.1 Justification

For both radiated and conducted emissions below 1 GHz, the system was configured for testing in a typical fashion as a customer would normally use it. The peripherals other than EUT were connected in normally standing by situation. Measurement was performed under the condition that a computer program was exercised to simulate data communication of EUT, and the transmission rate was set to maximum allowed by EUT. Three highest emissions were verified with varying placement of the transmitting antenna connected to EUT to maximize the emission from EUT.

For conducted emissions, only measured on TX and RX operation, for the digital circuits portion also function normally whenever TX or RX is operated. For radiated emissions, whichever RF channel is operated, the digital circuits function identically. As the reason, measurement of radiated emissions from digital circuits is only performed with channel 7 by transmitting mode.

During the preliminary test, the worse case is the antenna with a cable, and data presented in this test report just shows the worse case.

3.2 Devices for Tested System

Device	Manufacture	Model	Cable Description
Wireless LAN PC Card *	Z-COM, INC.	ACPC2000-11	----
Note Book Computer	Tatung	TNB-5900	2.5m Unshielded AC Adaptor Poewr Cord
Printer	Hewlett-Packard	2225C+	1.2m Shielded Cable
Modem	Smar TEAM Co.	1200AT	2.0m Shielded Cable

Remark “*” means equipment under test.

4 RADIATED EMISSION MEASUREMENT

4.1 Applicable Standard

For unintentional radiator, the radiated emission shall comply with § 15.109(a).

For intentional radiators, according to § 15.247 (a), operation under this provision is limited to frequency hopping and direct sequence spread spectrum, and the out band emission shall be comply with § 15.247 (c)

4.2 Measurement Procedure

1. Setup the configuration per figure 5 and 6 for frequencies measured below and above 1 GHz respectively.
2. For emission frequencies measured below 1 GHz, a pre-scan is performed in a shielded chamber to determine the accurate frequencies of higher emissions will be checked on a open test site. As the same purpose, for emission frequencies measured above 1 GHz, a pre-scan also be performed with a 1 meter measuring distance before final test.
3. For emission frequencies measured below and above 1 GHz, set the spectrum analyzer on a 100 kHz and 1 MHz resolution bandwidth respectively for each frequency measured in step 2.
4. The search antenna is to be raised and lowered over a range from 1 to 4 meters in horizontally polarized orientation. Position the highness when the highest value is indicated on spectrum analyzer, then change the orientation of EUT on test table over a range from 0 ° to 360 ° with a speed as slow as possible, and keep the azimuth that highest emission is indicated on the spectrum analyzer. Vary the antenna position again and record the highest value as a final reading. A RF test receiver is also used to confirm emissions measured.

Note : A band pass filter was used to avoid pre-amplifier saturated when measure TX operation mode in frequency band above 1 GHz.

5. Repeat step 4 until all frequencies need to be measured were complete.
6. Repeat step 5 with search antenna in vertical polarized orientations.
7. Check the three frequencies of highest emission with varying the placement of cables associated with EUT to obtain the worse case and record the result.

Figure 1 : Frequencies measured below 1 GHz configuration

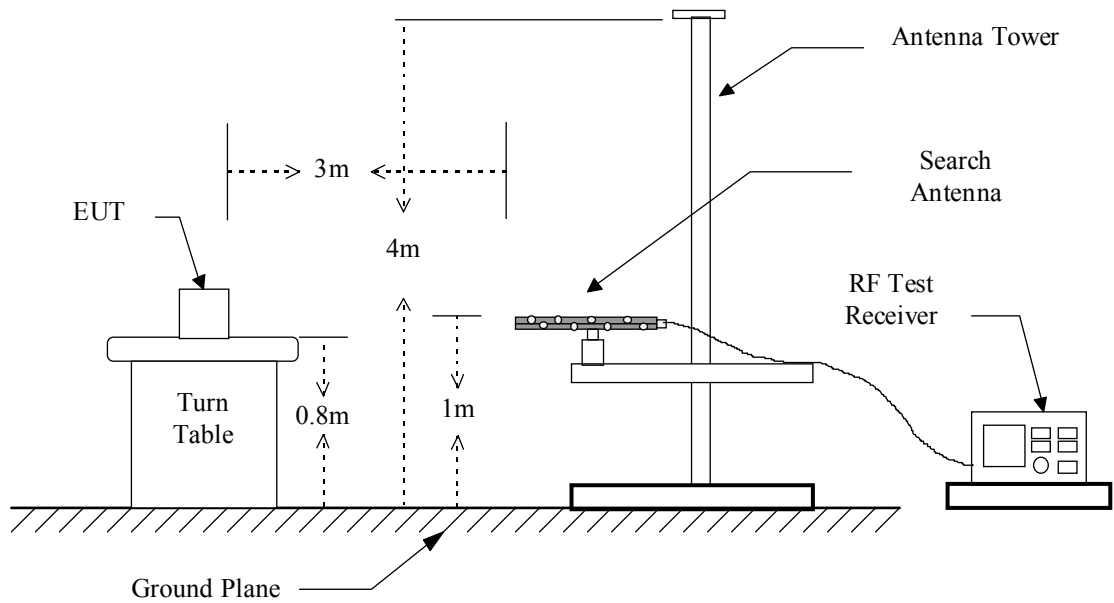
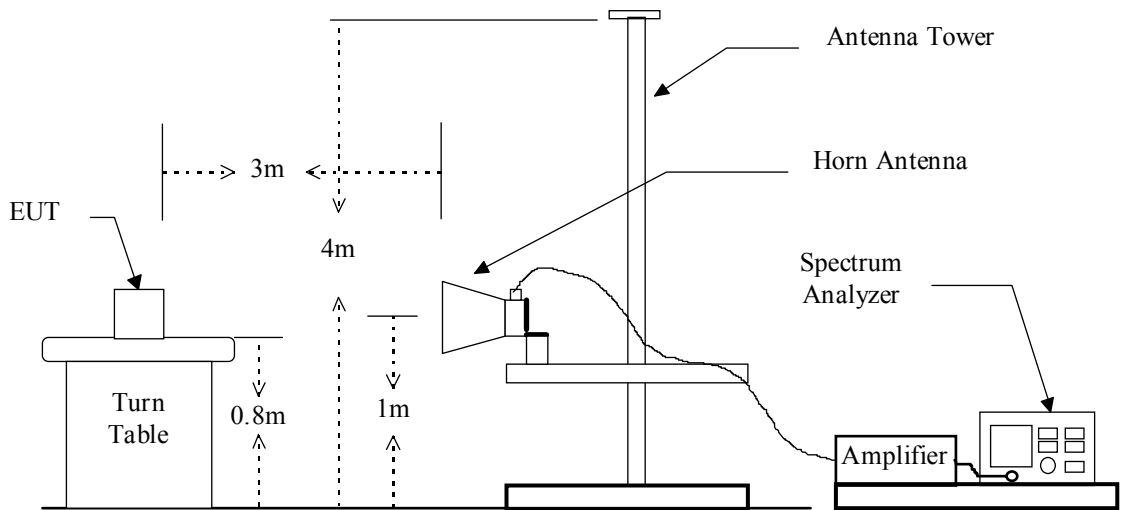

Figure 2 : Frequencies measured above 1 GHz configuration



4.3 Measuring Instrument

The following instrument are used for radiated emissions measurement:

Equipment	Manufacturer	Model No.	Next Cal. Due
Spectrum Analyzer	Hewlett-Packard	8568B	01/10/2003
Pre-selector	Hewlett-Packard	85685A	01/10/2003
Quasi Peak Detector	Hewlett-Packard	85650A	01/10/2003
Spectrum Analyzer	Adventest	R3271	09/09/2002
RF Test Receiver	Rohde & Schwarz	ESVS 30	08/05/2002
Horn Antenna	EMCO	3115	05/09/2002
Log periodic Antenna	EMCO	3146	11/04/2002
Biconical Antenna	EMCO	3110B	11/04/2002
Preamplifier	Hewlett-Packard	8449B	05/10/2002
Preamplifier	Hewlett-Packard	8447D	10/14/2002
Spectrum Analyzer	Hewlett-Packard	8564E	04/22/2002

Measuring instrument setup in measured frequency band when specified detector function is used :

Frequency Band (MHz)	Instrument	Function	Resolution bandwidth	Video Bandwidth
30 to 1000	RF Test Receiver	Quasi-Peak	120 kHz	N/A
	Spectrum Analyzer	Peak	100 kHz	100 kHz
Above 1000	Spectrum Analyzer	Peak	1 MHz	1 MHz
	Spectrum Analyzer	Average	1 MHz	300 Hz

4.4 Radiated Emission Data

4.4.1 RF Portion

a) Channel 1

Operation Mode : Receiving/Transmitting

Fundamental Frequency : 2412 MHz (Local Frequency : 2038 MHz)

Test Date : Feb. 19, 2002

Temperature : 25 °C

Humidity : 60 %

Frequency (MHz)	Reading (dBuV)				Factor (dB) Corr.	Result @3m (dBuV/m)		Limit @3m (dBuV/m)		Margin (dB)	Table Deg. (Deg.)	Ant. High (m)
	H		V			Peak	Ave	Peak	Ave.			
*2038.042	52.8	49.7	56.5	55.3	-4.5	52.0	50.8	74.0	54.0	-3.2	0	1.00
*4076.084	43.4	34.4	45.7	42.8	2.0	47.7	44.8	74.0	54.0	-9.2	270	1.50
*6114.126	41.8	30.4	43.7	34.1	4.5	48.2	38.6	74.0	54.0	-15.4	85	1.50
*8152.168	---	---	---	---	6.5	---	---	74.0	54.0	---	---	---
*10190.210	---	---	---	---	7.6	---	---	74.0	54.0	---	---	---
4826.824	---	---	---	---	2.6	---	---	74.0	54.0	---	---	---
7240.236	---	---	---	---	5.8	---	---	74.0	54.0	---	---	---
9653.648	---	---	---	---	7.3	---	---	74.0	54.0	---	---	---
12067.060	---	---	---	---	9.2	---	---	74.0	54.0	---	---	---
14480.472	---	---	---	---	11.6	---	---	74.0	54.0	---	---	---
16893.884	---	---	---	---	12.2	---	---	74.0	54.0	---	---	---
19307.296	---	---	---	---	8.8	---	---	74.0	54.0	---	---	---
21720.708	---	---	---	---	9.8	---	---	74.0	54.0	---	---	---
24134.120	---	---	---	---	10.4	---	---	74.0	54.0	---	---	---

Note :

1. Item of margin shown in above table refer to average limit.
2. It is considered that the results of average comply with average limit when measuring data with a peak function detector meet the average limit. Mark “***” means that Peak result is meet average limit.
3. Remark “---” means that the emissions level is too low to be measured.
4. Item “Margin” referred to Average limit while there is only peak result.
5. The expanded uncertainty of the radiated emission tests is 3.53 dB.

b) Channel 6

Operation Mode : Receiving / Transmitting

Fundamental Frequency : 2437 MHz (Local Frequency : 2063 MHz)

Test Date : Feb. 19, 2002

Temperature : 25 °C

Humidity : 60 %

Frequency (MHz)	Reading (dBuV)				Factor (dB) Corr.	Result @3m (dBuV/m)		Limit @3m (dBuV/m)		Margin (dB)	Table Deg. (Deg.)	Ant. High (m)
	H		V			Peak	Ave	Peak	Ave.			
*2063.042	53.0	50.2	56.7	55.5	-4.4	52.3	51.1	74.0	54.0	-2.9	0	1.00
*4126.084	44.1	37.3	48.6	45.4	2.0	50.6	47.4	74.0	54.0	-6.6	270	1.50
*6189.126	41.8	30.0	43.1	35.5	4.5	47.6	40.0	74.0	54.0	-14.0	85	1.50
*8252.168	---	---	---	---	6.6	---	---	74.0	54.0	---	---	---
*10315.210	---	---	---	---	7.7	---	---	74.0	54.0	---	---	---
4876.822	---	---	---	---	2.7	---	---	74.0	54.0	---	---	---
7315.233	---	---	---	---	5.9	---	---	74.0	54.0	---	---	---
9753.644	---	---	---	---	7.3	---	---	74.0	54.0	---	---	---
12192.055	---	---	---	---	9.3	---	---	74.0	54.0	---	---	---
14630.466	---	---	---	---	11.6	---	---	74.0	54.0	---	---	---
17068.877	---	---	---	---	13.2	---	---	74.0	54.0	---	---	---
19507.288	---	---	---	---	8.5	---	---	74.0	54.0	---	---	---
21945.699	---	---	---	---	9.9	---	---	74.0	54.0	---	---	---
24384.110	---	---	---	---	10.7	---	---	74.0	54.0	---	---	---

Note :

1. Item of margin shown in above table refer to average limit.
2. It is considered that the results of average comply with average limit when measuring data with a peak function detector meet the average limit. Mark "***" means that Peak result is meet average limit.
3. Remark "---" means that the emissions level is too low to be measured.
4. Item "Margin" referred to Average limit while there is only peak result.
5. The expanded uncertainty of the radiated emission tests is 3.53 dB.

c) Channel 11

Operation Mode : Receiving / Transmitting

Fundamental Frequency : 2462 MHz (Local Frequency : 2088 MHz)

Test Date : Feb. 19, 2002

Temperature : 25 °C

Humidity : 60 %

Frequency (MHz)	Reading (dBuV)				Factor (dB) Corr.	Result @3m (dBuV/m)		Limit @3m (dBuV/m)		Margin (dB)	Table Deg. (Deg.)	Ant. High (m)
	H Peak	Ave	V Peak	Ave		Peak	Ave	Peak	Ave.			
*2088.017	54.1	51.2	55.6	54.0	-4.3	51.3	49.7	74.0	54.0	-4.3	0	1.00
*4176.034	44.7	37.7	46.5	45.5	2.0	48.5	47.5	74.0	54.0	-6.5	270	1.50
*6264.051	42.3	30.4	44.3	35.7	4.5	48.8	40.2	74.0	54.0	-13.8	85	1.50
*8352.068	---	---	---	---	6.7	---	---	74.0	54.0	---	---	---
*10440.085	---	---	---	---	7.8	---	---	74.0	54.0	---	---	---
4926.822	---	---	---	---	2.8	---	---	74.0	54.0	---	---	---
7390.233	---	---	---	---	6.0	---	---	74.0	54.0	---	---	---
9853.644	---	---	---	---	7.3	---	---	74.0	54.0	---	---	---
12317.055	---	---	---	---	9.3	---	---	74.0	54.0	---	---	---
14780.466	---	---	---	---	11.5	---	---	74.0	54.0	---	---	---
17243.877	---	---	---	---	14.4	---	---	74.0	54.0	---	---	---
19707.288	---	---	---	---	8.5	---	---	74.0	54.0	---	---	---
22170.699	---	---	---	---	10.0	---	---	74.0	54.0	---	---	---
24634.110	---	---	---	---	10.9	---	---	74.0	54.0	---	---	---

Note :

1. Item of margin shown in above table refer to average limit.
2. It is considered that the results of average comply with average limit when measuring data with a peak function detector meet the average limit. Mark “***” means that Peak result is meet average limit.
3. Remark “---” means that the emissions level is too low to be measured.
4. Item “Margin” referred to Average limit while there is only peak result.
5. The expanded uncertainty of the radiated emission tests is 3.53 dB.

4.4.2 Other Emission

a) Emission frequencies below 1 GHz

Test Date : Feb. 19, 2002

Temperature : 25 °C

Humidity : 60 %

Frequency (MHz)	Ant-Pol H/V	Meter Reading (dBuV)	Corrected Factor (dB)	Result @3m (dBuV/m)	Limit @3m (dBuV/m)	Margin (dB)	Table Degree (Deg.)	Ant. High (m)
80.814	V	46.1	-14.9	31.2	40.0	-8.8	270	1.00
133.686	V	44.4	-11.2	33.2	43.5	-10.3	85	1.00
192.064	H	45.7	-8.1	37.6	43.5	-5.9	90	4.00
200.450	H	44.9	-7.1	37.8	43.5	-5.7	90	4.00
233.886	H	41.9	-4.9	37.0	46.0	-9.0	15	4.00
334.086	H	46.3	-8.1	38.2	46.0	-7.8	0	3.50
467.072	V	41.0	-4.8	36.2	46.0	-9.8	15	1.30

Note :

1. Remark "---" means that the emissions level is too low to be measured.
2. The expanded uncertainty of the radiated emission tests is 3.53 dB.

b) Emission frequencies above 1 GHz

Radiated emission frequencies above 1 GHz to 5 GHz were too low to be measured with a pre-amplifier of 35 dB.

4.5 Field Strength Calculation

The field strength is calculated by adding the Antenna Factor, High Pass Filter Loss(if used) and Cable Loss, and subtracting the Amplifier Gain (if any) from the measured reading. The basic equation calculation is as follows:

$$\text{Result} = \text{Reading} + \text{Corrected Factor}$$

where

Corrected Factor = Antenna FACTOR + Cable Loss + High Pass Filter Loss - Amplifier Gain

4.6 Photos of Radiation Measuring Setup

Please see setup Photos in Exhibit F.

5 CONDUCTED EMISSION MEASUREMENT

5.1 Standard Applicable

For unintentional and intentional device, Line Conducted Emission Limits are in accordance to § 15.107(a) and § 15.207(a) respectively. Both Limits are identical specification.

5.2 Measurement Procedure

1. Setup the configuration per figure 3.
2. A preliminary scan with a spectrum monitor is performed to identify the frequency of emission that has the highest amplitude relative to the limit by operating the EUT in selected modes of operation, typical cable positions, and with a typical system configuration.
3. Record the 6 or 8 highest emissions relative to the limit.
4. Measure each frequency obtained from step 3 by a test receiver set on quasi peak detector function, and then record the accuracy frequency and emission level. If all emissions measured in the specified band are attenuated more than 20 dB from the limit, this step would be ignored, and the peak detector function would be used.
5. Confirm the highest three emissions with variation of the EUT cable configuration and record the final data.
6. Repeat all above procedures on measuring each operation mode of EUT.

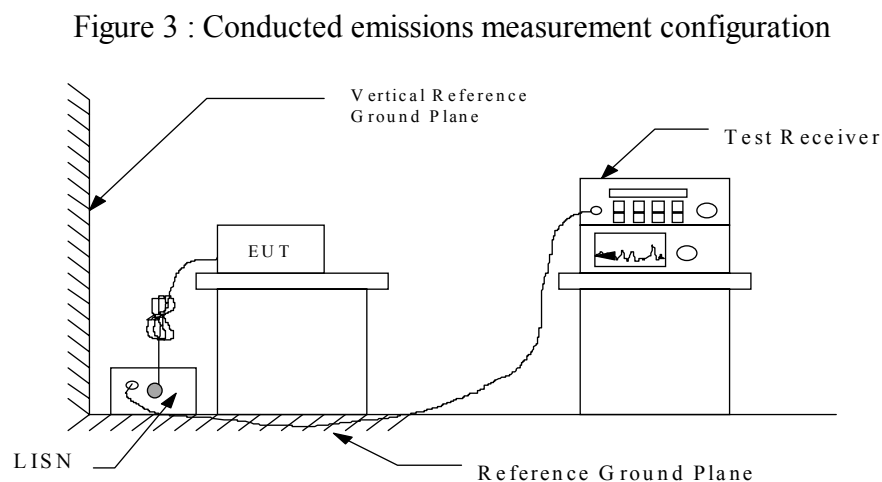

5.3 Conducted Emission Data

a) Channel 1

Operation Mode : Transmitting / Receiving

Test Date : Feb. 19, 2002 Temperature : 24 °C Humidity: 71 %

Frequency (MHz)	Reading (dBuV)		Factor (dB)	Result (dBuV)		Limit (dBuV)	Margin (dB)
	Va	Vb		Va	Vb		
0.460	31.8	28.7	0.2	32.0	28.9	48.0	-16.0
0.538	27.0	32.7	0.2	27.2	32.9	48.0	-15.1
3.540	25.6	27.0	0.3	25.9	27.3	48.0	-20.7
3.619	27.4	27.2	0.3	27.7	27.5	48.0	-20.3
3.697	28.8	25.6	0.3	29.1	25.9	48.0	-18.9
11.700	36.8	25.7	0.6	37.4	26.3	48.0	-10.6
17.786	25.7	24.6	0.9	26.6	25.5	48.0	-21.4

b) Channel 6

Operation Mode : Transmitting / Receiving

Test Date : Feb. 19, 2002 Temperature : 24 °C Humidity: 71 %

Frequency (MHz)	Reading (dBuV)		Factor (dB)	Result (dBuV)		Limit (dBuV)	Margin (dB)
	Va	Vb		Va	Vb		
0.460	31.7	28.5	0.2	31.9	28.7	48.0	-16.1
0.538	26.8	32.6	0.2	27.0	32.8	48.0	-15.2
3.540	25.5	26.8	0.3	25.8	27.1	48.0	-20.9
3.619	27.2	27.1	0.3	27.5	27.4	48.0	-20.5
3.697	28.7	25.4	0.3	29.0	25.7	48.0	-19.0
11.700	36.7	25.5	0.6	37.3	26.1	48.0	-10.7
17.786	25.5	24.5	0.9	26.4	25.4	48.0	-21.6

c) Channel 11

Operation Mode : Transmitting / Receiving

Test Date : Feb. 19, 2002Temperature : 24 °CHumidity: 71 %

Frequency (MHz)	Reading (dBuV)		Factor (dB)	Result (dBuV)		Limit (dBuV)	Margin (dB)
	Va	Vb		Va	Vb		
0.460	31.6	28.6	0.2	31.8	28.8	48.0	-16.2
0.538	26.9	32.5	0.2	27.1	32.7	48.0	-15.3
3.540	25.4	26.9	0.3	25.7	27.2	48.0	-20.8
3.619	27.3	27.0	0.3	27.6	27.3	48.0	-20.4
3.697	28.6	25.5	0.3	28.9	25.8	48.0	-19.1
11.700	36.5	25.6	0.6	37.1	26.2	48.0	-10.9
17.786	25.6	24.4	0.9	26.5	25.3	48.0	-21.5

Note : 1. Please see appendix 3 for Plotted Data

2. The expanded uncertainty of the conducted emission tests is 2.45 dB.

5.4 Result Data Calculation

The result data is calculated by adding the LISN Factor to the measured reading. The basic equation with a sample calculation is as follows:

$$\mathbf{RESULT = READING + LISN FACTOR}$$

Assume a receiver reading of 22.5 dB μ V is obtained, and LISN Factor is 0.1 dB, then the total of disturbance voltage is 22.6 dB μ V.

$$RESULT = 22.5 + 0.1 = 22.6 \text{ dB } \mu \text{ V}$$

$$\begin{aligned} \text{Level in } \mu \text{ V} &= \text{Common Antilogarithm}[(22.6 \text{ dB } \mu \text{ V})/20] \\ &= 13.48 \mu \text{ V} \end{aligned}$$

5.5 Conducted Measurement Equipment

The following test equipment are used during the conducted test .

Equipment	Manufacturer	Model No.	Next Cal. Due
RF Test Receiver	Rohde and Schwarz	ESH3	01/03/2003
Spectrum Monitor	Rohde and Schwarz	EZM	N.C.R.
Line Impedance Stabilization network	Kyoritsu	KNW-407	12/02/2002
Line Impedance Stabilization network	Rohde and Schwarz	ESH2-Z5	08/05/2002
Plotter	Hewlett-Packard	7440A	N/A
Shielded Room	Riken		N.C.R.

5.6 Photos of Conduction Measuring Setup

Please see setup Photos in Exhibit F.

6 ANTENNA REQUIREMENT

6.1 Standard Applicable

For intentional device, according to § 15.203, an intentional radiator shall be designed to ensure that no antenna other than that furnished by the responsible party shall be used with the device.

And according to § 15.247 (b), if transmitting antennas of directional gain greater than 6 dBi are used, the power shall be reduced by the amount in dB that the directional gain of the antenna exceeds 6 dBi.

6.2 Antenna Construction and Directional Gain

The antenna terminal of this unit is designed with a reversed MMCX Connector. Please see construction Photos Of Exhibit B for details.

The directional gain of antenna used for transmitting is 2dBi, and the details antenna construction please see *Appendix 2*.

7 EMISSION BANDWIDTH MEASUREMENT

7.1 Standard Applicable

According to 15.247(a)(2), for direct sequence system, the minimum 6dB bandwidth shall be at least 500 kHz.

7.2 Measurement Procedure

1. Check the calibration of the measuring instrument using either an internal calibrator or a known signal from an external generator.
2. Position the EUT as shown in figure 5 without connection to measurement instrument. Turn on the EUT and connect it to measurement instrument. Then set it to any one convenient frequency within its operating range. Set a reference level on the measuring instrument equal to the highest peak value.
3. Measure the frequency difference of two frequencies that were attenuated 6 dB from the reference level. Record the frequency difference as the emission bandwidth.
4. Repeat above procedures until all frequencies measured were complete.

Figure 4: Emission bandwidth measurement configuration.

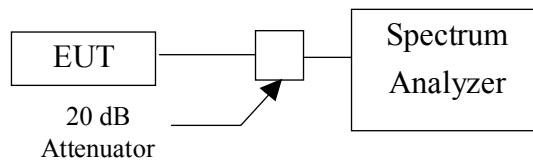

7.3 Measurement Equipment

Equipment	Manufacturer	Model No.	Next Cal. Due
RF Test Receiver	Rohde & Schwarz	ESBI	05/15/2002
Plotter	Hewlett-Packard	7440A	N/A
Attenuator	Weinschel Engineering	AS3667	N/A

7.4 Measurement Data

Test Date : Feb. 19, 2002 Temperature : 24 °C Humidity: 71 %

- a) Channel 01 : 6 dB Emission Bandwidth is 11.08 MHz
- b) Channel 06 : 6 dB Emission Bandwidth is 11.06 MHz
- c) Channel 11 : 6 dB Emission Bandwidth is 11.06 MHz

Note : 1. Please see appendix 3 for Plotted Data

2. The expanded uncertainty of the emission bandwidth tests is 1500Hz.

8 OUTPUT POWER MEASUREMENT

8.1 Standard Applicable

For direct sequence system, according to 15.247(b), the maximum peak output power of the transmitter shall not exceed 1 Watt. If transmitting antennas of directional gain greater than 6 dBi are used, the power shall be reduced by the amount in dB that the directional gain of the antenna exceeds 6 dBi.

8.2 Measurement Procedure

1. Check the calibration of the measuring instrument using either an internal calibrator or a known signal from an external generator.
2. Position the EUT as shown in figure 5 without connection to measurement instrument. Turn on the EUT and connect its antenna terminal to measurement instrument via a low loss cable. Then set it to any one measured frequency within its operating range and make sure the instrument is operated in its linear range.
3. Set RBW of spectrum analyzer to 3 MHz and VBW to 3 MHz.
4. Measure the highest amplitude appearing on spectral display and record the level to calculate result data.
5. Repeat above procedures until all frequencies measured were complete.

Figure 5: Output power and measurement configuration.

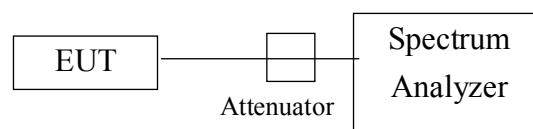

8.3 Measurement Equipment

Equipment	Manufacturer	Model No.	Next Cal. Due
RF Test Receiver	Rohde & Schwarz	ESBI	05/15/2002
Plotter	Hewlett-Packard	7440A	N/A

8.4 Measurement Data

Test Date : Feb. 19, 2002 Temperature : 24 °C Humidity: 71 %

- a) Channel 01 : Output Peak Power is 10.80 dBm or 12.0 mW
- b) Channel 06 : Output Peak Power is 9.58 dBm or 9.1 mW
- c) Channel 11 : Output Peak Power is 8.72 dBm or 7.4 mW

Note : 1. Please see appendix 4 for Plotted Data

2. The expanded uncertainty of the output power tests is 2dB.

9 100 kHz BANDWIDTH OF BAND EDGES MEASUREMENT

9.1 Standard Applicable

According to 15.247(c), if any 100 kHz bandwidth outside these frequency bands, the radio frequency power that is produced by the modulation products of the spreading sequence, the information sequence and the carrier frequency shall be either at least 20 dB below that in any 100 kHz bandwidth within the band that contains the highest level of the desired power or shall not exceed the general levels specified in § 15.209(a), whichever results in the lesser attenuation.

9.2 Measurement Procedure

1. Check the calibration of the measuring instrument using either an internal calibrator or a known signal from an external generator.
2. Position the EUT as shown in figure 5 without connection to measurement instrument. Turn on the EUT and connect its antenna terminal to measurement instrument via a low loss cable. Then set it to any one measured frequency within its operating range and make sure the instrument is operated in its linear range.
3. Set both RBW and VBW of spectrum analyzer to 300 kHz with a convenient frequency span including 100kHz bandwidth from band edge.
4. Measure the highest amplitude appearing on spectral display and set it as a reference level. Plot the graph with marking the highest point and edge frequency.
5. Repeat above procedures until all measured frequencies were complete.

9.3 Measurement Equipment

Equipment	Manufacturer	Model No.	Next Cal. Due
RF Test Receiver	Rohde & Schwarz	ESBI	05/15/2002
Attenuator	Weinschel Engineering	1	N/A
Plotter	Hewlett-Packard	7440A	N/A

9.4 Measurement Data

Test Date : Feb. 19, 2002 Temperature : 24 °C Humidity: 71 %

- a) Lower Band Edge : maximum value is -37.75 dBm that is attenuated more than 20 dB
- b) Upper Band Edge : maximum value is -40.06 dBm that is attenuated more than 20 dB

Note : 1. Please see appendix 5 for Plotted Data

2. The expanded uncertainty of the 100 khz bandwidth of band edges tests is 2dB.

10 POWER DENSITY MEASUREMENT

10.1 Standard Applicable

According to 15.247(d), for direct sequence systems, the transmitted power density averaged over any 1 second interval shall not be greater than 8 dBm in any 3 kHz bandwidth within these bands.

10.2 Measurement Procedure

1. Check the calibration of the measuring instrument using either an internal calibrator or a known signal from an external generator.
2. Position the EUT as shown in figure 4 without connection to measurement instrument. Turn on the EUT and connect its antenna terminal to measurement instrument via a low loss cable. Then set EUT to any one measured frequency within its operating range and make sure the instrument is operated in its linear range.
3. Adjust the center frequency of spectrum analyzer on highest level appearing on spectral display within a 300 kHz frequency span.
4. Set the spectrum analyzer on a 3 kHz resolution bandwidth and 300 kHz video bandwidth as well as max. hold function. Also turn on SA level corrected function by 21 dB and then record the measurement result.
5. Repeat above procedures until all measured frequencies were complete.

10.3 Measurement Equipment

Equipment	Manufacturer	Model No.	Next Cal. Due
RF Test Receiver	Rohde & Schwarz	ESBI	05/15/2002
Attenuator	Weinschel Engineering	1	N/A
Plotter	Hewlett-Packard	7440A	N/A

10.4 Measurement Data

Test Date : Feb. 19, 2002 Temperature : 24 °C Humidity: 71 %

- a) Channel 01 : Maximun Power Density of 3 kHz Bandwidth is -16.22 dBm
- b) Channel 06 : Maximun Power Density of 3 kHz Bandwidth is -17.34 dBm
- c) Channel 11 : Maximun Power Density of 3 kHz Bandwidth is -18.02 dBm

Note : 1. Please see appendix 6 for Plotted Data

2. The expanded uncertainty of the power density tests is 2dB.

11 PROCESSING GAIN MEASUREMENT

11.1 Standard Applicable

According to 15.247(e), the processing gain of a direct sequence system shall be at least 10 dB. The processing gain shall be determined from the ratio in dB of the signal to noise ratio with the system spreading code turned off to the signal to noise ratio with the system spreading code turned on, as measured at the demodulated output of the receiver.

11.2 Measurement Description

The processing gain measurement is based upon the CW jamming margin method suggested in the FCC document entitled "GUIDANCE ON MEASUREMENTS FOR DIRECT SEQUENCE SPREAD SPECTRUM SYSTEMS, 54597, July 12,1995"

The test consists of stepping a CW signal generator in 50KHz increment across pass band of each three channels within 2400 – 2483 MHz band. This CW signal represents the jamming signal. The selected three channels are as followings:

Channel 01: centered at 2412 MHz

Channel 06: centered at 2437 MHz

Channel 11: centered at 2462 MHz

These three channels represents the Low, Mid and High frequency bands of the EUT, respectively. And, the processing gain of the EUT determined for these bands should be representative of the entire band.

(1). Measurement Configuration

The measurement configuration (draw in next page) is according to FCC document 54797,page3.

(2)Procedures

- (a) The test-firmware loaded into EUT(Tx) transmits a length of random data packet that is generated by Hp3784 BER tester. After receiving a Tx command from host PC, EUT sends a clock to synchronize with BER tester (Hp3784A).
- (b) After receiving a Rx command from host PC, the test-firmware loaded into the EUT(Rx) will force EUT enter into Rx mode. The EUT (Rx) then, demodulates received data without CRC check, sends them to BER Tester. The BER Tester checks received data and the data stored in flash ROM, then calculates BER and accumulates the result.
- (c) The remote PC acts as a command bridge between RS-232 port and PCMCIA bus.
- (d) The host PC controls RF signal generator and spectrum analyzer via GPIB interface to get an appropriate J/S ratio.
- (e) The host PC issues TX command to EUT(Tx) then issues Rx query command received, the good Rx packet counter will be increased. When a fixed number of

good Rx packets had been reached, the accumulated error bits will be read from EUT(Rx) via RS-232 and Remote PC. The J/S ratio will be re-measured at the same time.

- (f) The test program in host PC increases or decreases jamming power and repeats step (d) and (e) to get a chosen BER, then records the J/S ratio.
- (g) The test program in Host PC repeats step (f) by increasing CW jamming frequency in 50KHz step across entire pass band of each test channel.

(3) Test Condition

- (a) The test configuration and procedure are according to the FCC document 54797, page 2-3.
- (b) The pass band of each channel is 22MHz.
- (c) The received data bit length executed in Host PC is fixed to 6.29×10^6 . The chosen bit error rate (BER) is sustained to 1×10^{-5} .
- (d) The power value of Signal and Jammer listed in the test results are read and recorded automatically by the program. The value is read directly from the function of "channel power measurement " of HP8563E Spectrum analyzer with the turn-off of signal or Jammer.

(4) Derivation of the Processing Gain

- (a) The Processing Gain (Gp) is calculated according to the following equations:

$$G_p = (S/N)_o + M_j + L_{sys} \dots (4-1) \dots \text{Refer to FCC document 54797 Page 3}$$

Where $M_j = J/S$ ratio (dB)

L_{sys} = System losses (assumed to be 2 dB)

$(S/N)_o$ = the required signal to noise ratio at the receiver output for a given received signal quality

- (b) Since the EUT uses coherent DBPSK/DQPSK demodulation, A $(S/N)_o = 16.4$ dB is required to sustain a BER of 1×10^{-5} . The curve is shown in Fig.7.2, Viterbi, A.J. Principles of Coherent Communications, Page 192 (New York; McGraw-Hill, 1996), recommended by FCC document 54797.

Therefore, from equation (4-1)

$$G_p = 16.4 + J/S + 2 \text{ (dB)} = 18.4 + J/S \text{ (dB)} \dots (4-2)$$

(5) Test Results

The tested data are listed in the following pages. After discarding the worst 20% of the J/S ratio data points, the lowest remaining J/S ratio is used to determine the processing gain (PG), according to the derivative equation(4/2), of each tested channel.

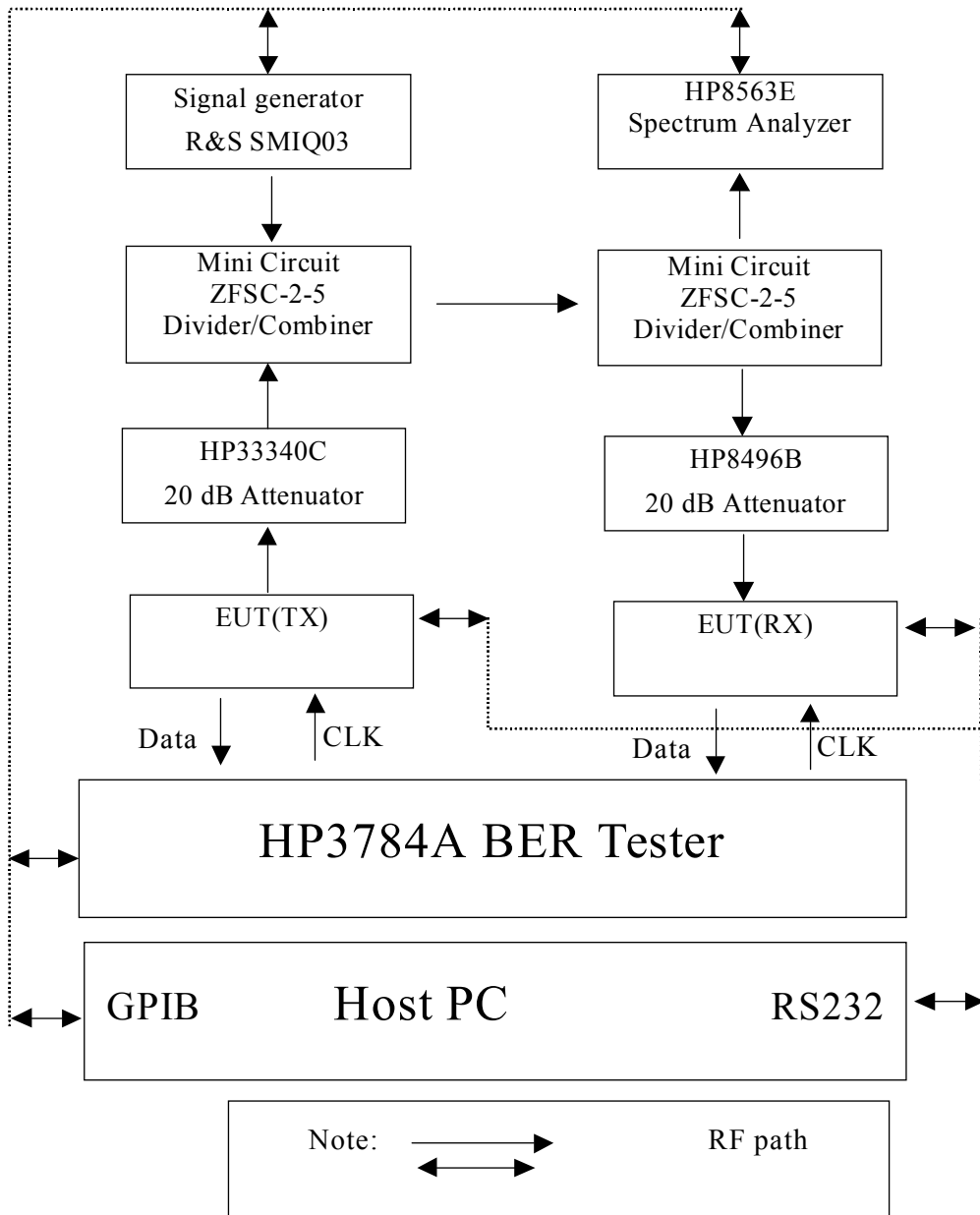

11.3 Measurement Instrument

Equipment	Manufacturer	Model No.	Next Cal. Due
Spectrum Analyzer	Hewlett-Packard	HP8563E	07/04/2002
RF Signal Generator	Rohde & Schwarz	SMIQ03	11/02/2002
Attenuator	Hewlett-Packard	AP33341C 20dB	N/A
Attenuator	Hewlett-Packard	HP8496B 20dB	N/A
Combiner / Splitter	Mini Circuit	ZFSC-2-5	N/A

11.4 Measurement Data

Test Date : Feb. 19, 2002 Temperature : 24 °C Humidity: 71 %

The processing gain is greater than 10 dB, please see Appendix 7 for details.

Data Rate = 2Mbps

For BPSK channel 1, PG =12.0 (2412 MHz)

BPSK channel 6, PG =12.6 (2437 MHz)

BPSK channel 11, PG =11.9 (2462 MHz)

Data Rate = 2Mbps

For QPSK channel 1, PG =11.5 (2412 MHz)

QPSK channel 6, PG =10.6 (2437 Mhz)

QPSK channel 11, PG =11.7 (2462 MHz)

In these three channels, the processing-gain values of EUT are all greater than 10dB, which satisfies §15.247(e).

Appendix 1 : Ploted Datas of Power Line Conducted Emissions

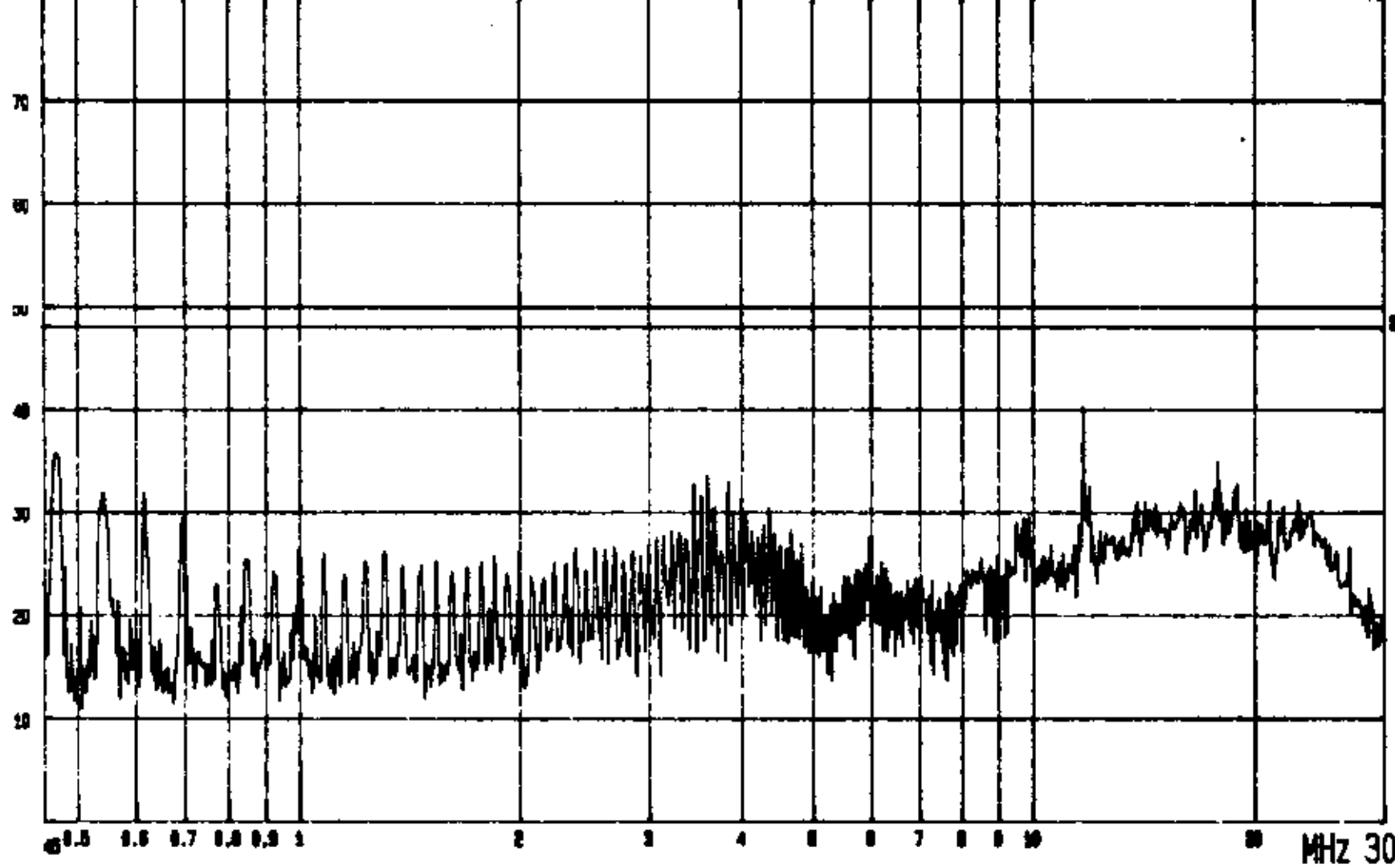

FCC CONDUCTED TEST

EUT: Wire e LAN Card
 POWER: From Notebook PC

LISN: N 2: GP
 MODE: TX/RX CH: J

CLASS B LIMIT
 ETC EMI LAB

dBuV

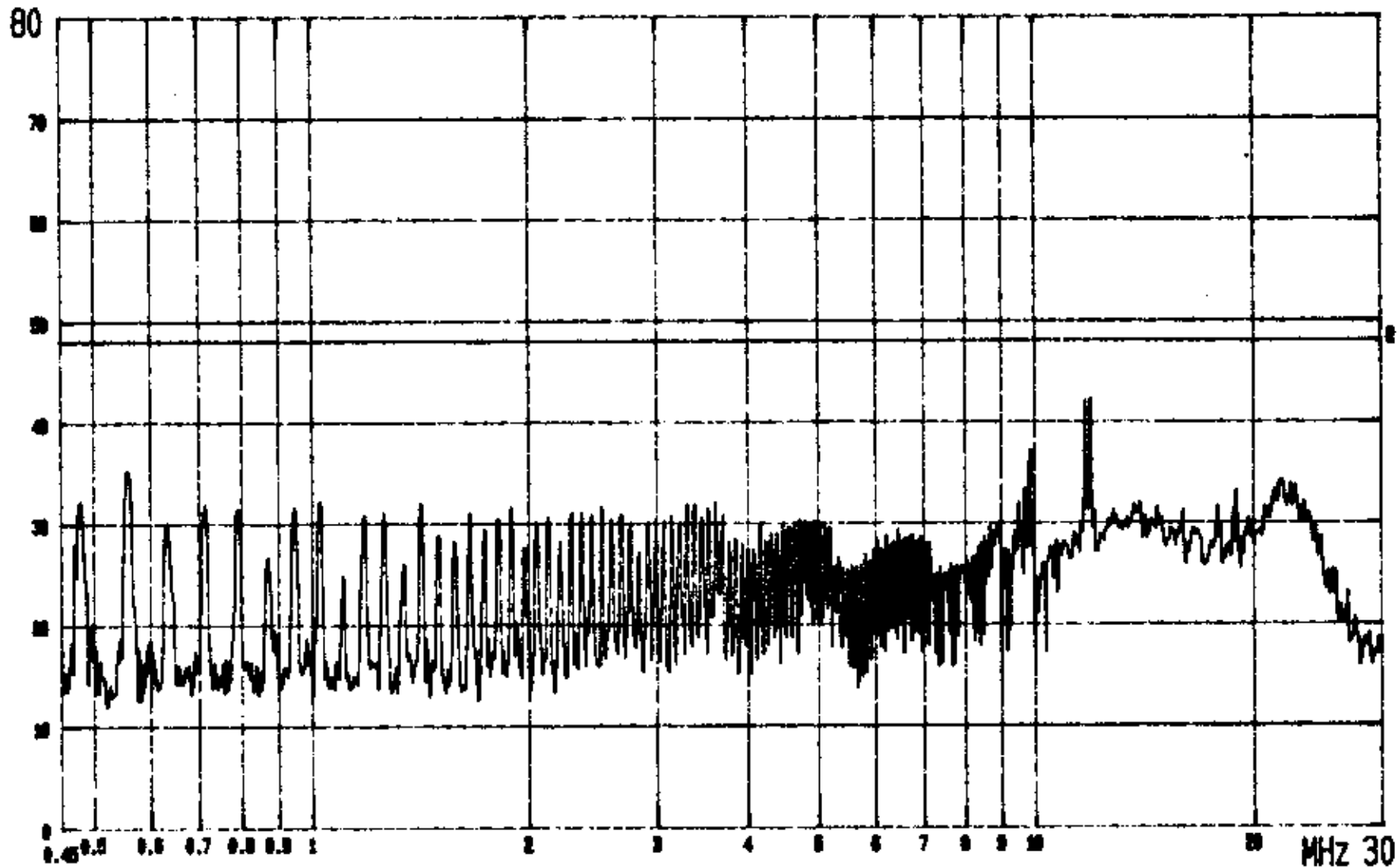

FCC CONDUCTED TEST

EUT: Wireless LAN Card
POWER: From NoteBook PC

LISN: L1 2: GP., CLASS B LIMIT
MODE: TX/RX (CH1) ETC EMI LAB.

dBuV

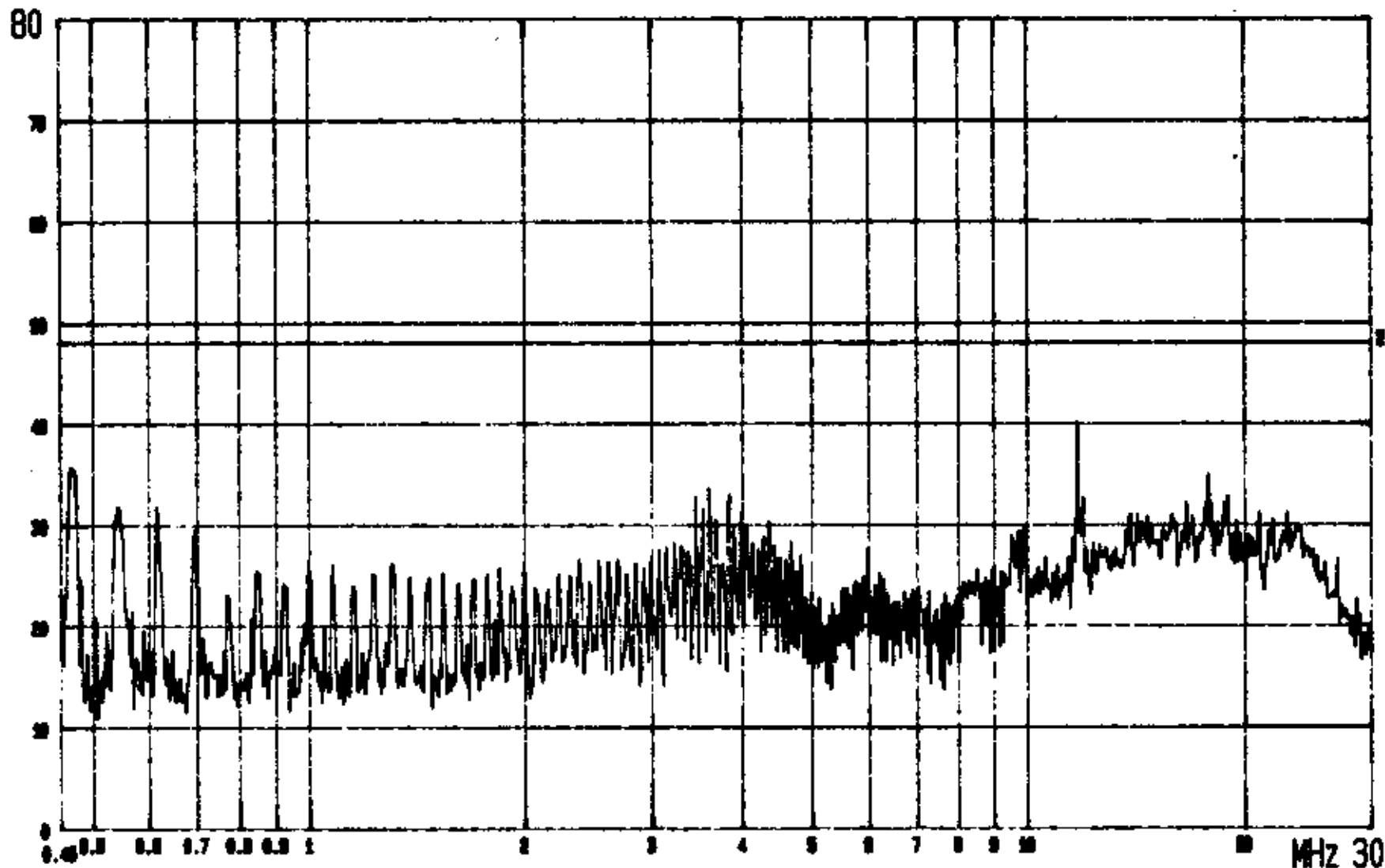

FCC CONDUCTED TEST

EUT: Wireless LAN Card
POWER: From Notebook PC

LISN: N 2 GP.,
MODE: TX/RX (CH6)

CLASS B LIMIT
ETC EMI LAB.

dBuV

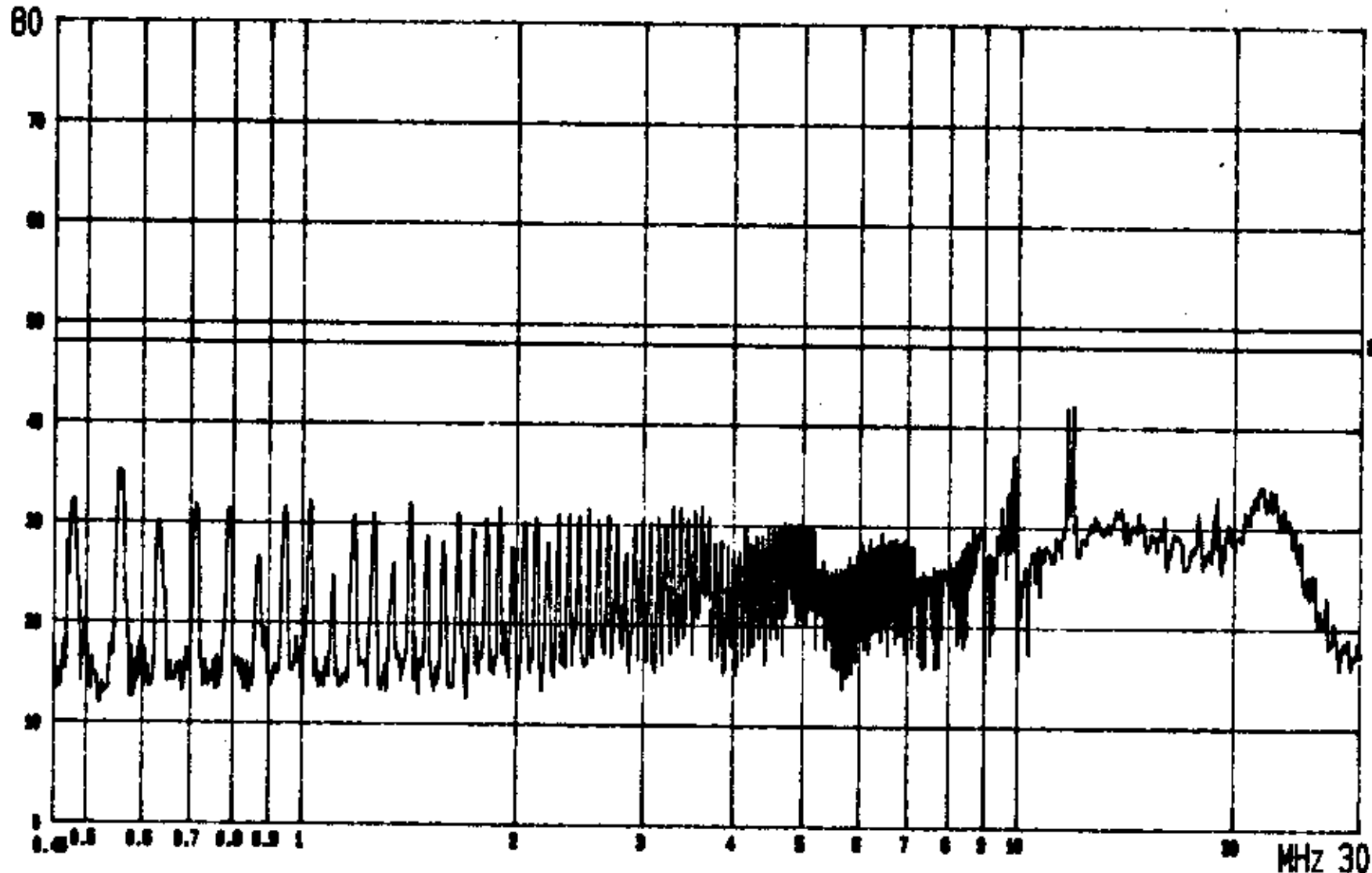

FCC CONDUCTED TEST EUT: Wireless LAN Card LISN: L1 2: GP., CLASS B LIMIT
POWER: From NoteBook PC MODE: TX/RX (CH6) ETC EMI LAB.

dBuV

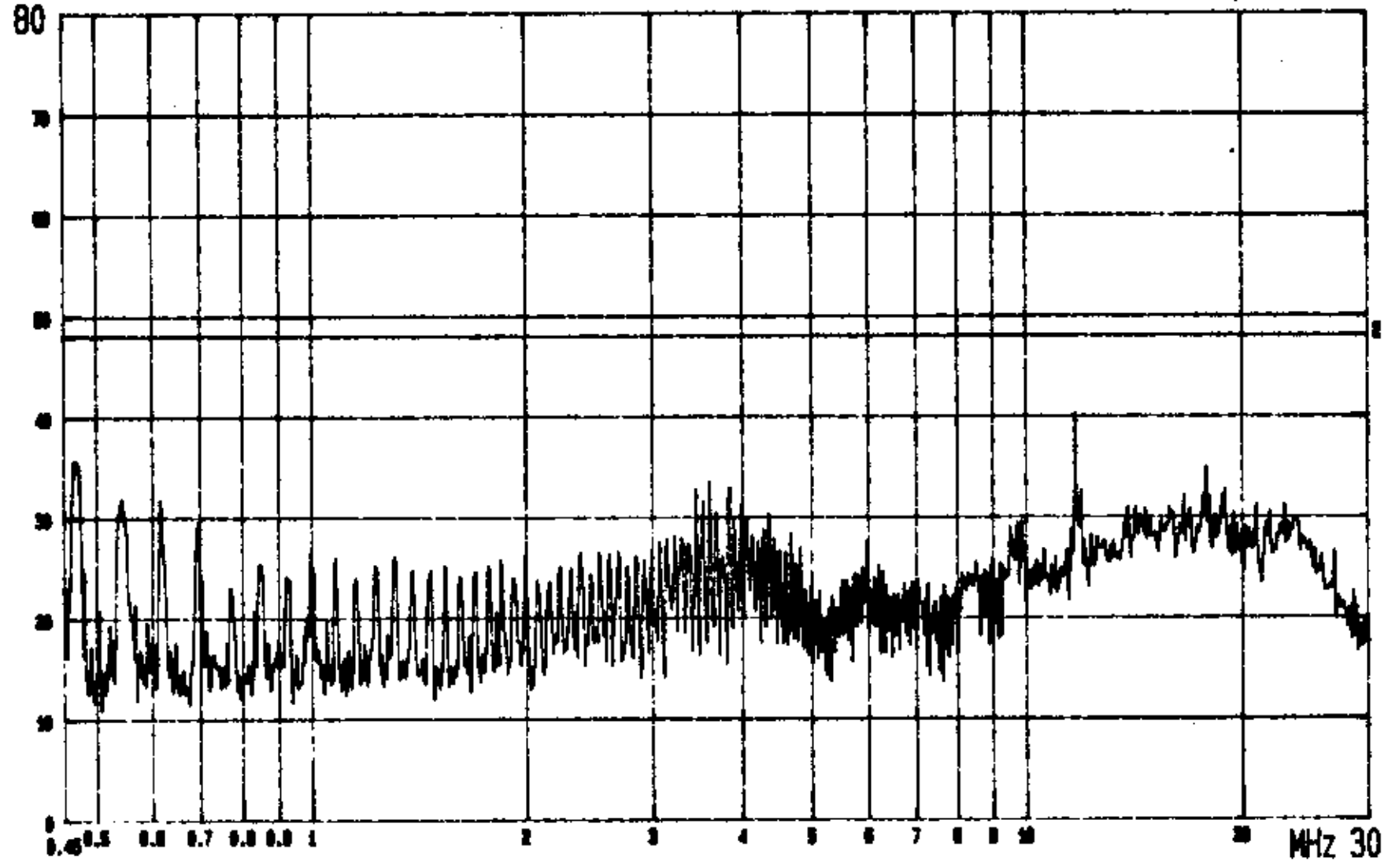

FCC CONDUCTED TEST EUT: Wireless LAN Card LISN: N 2: GP., CLASS B LIMIT
POWER: From NoteBook PC MODE: TX/RX (CH11) ETC EMI LAB.

dBuV

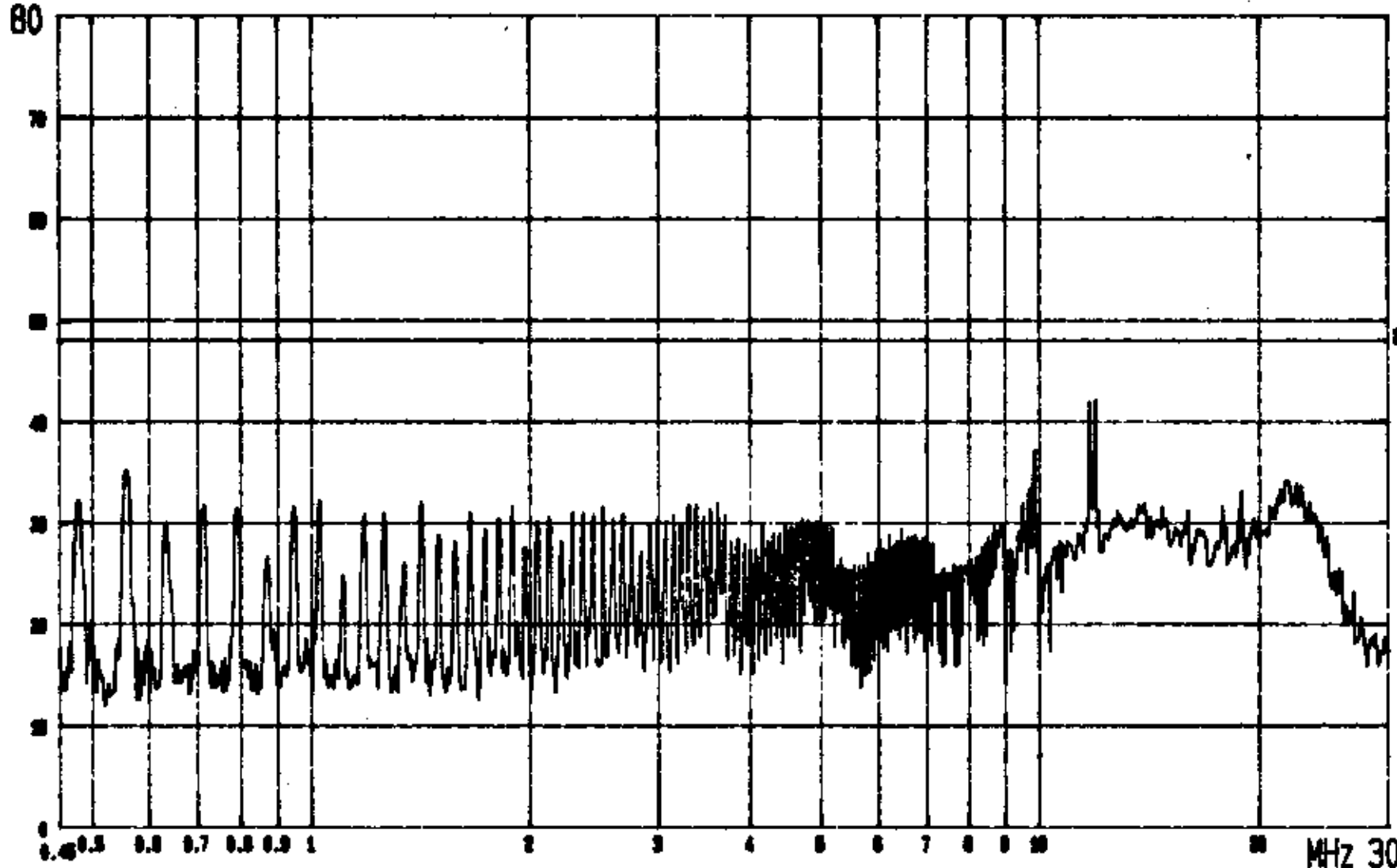

FCC CONDUCTED TEST EUT: Wireless LAN Card LISN: L1 2: GP., CLASS B LIMIT
POWER: From NoteBook PC MODE: TX/RX (CH11) ETC EMI LAB.

Appendix 2 : Engineering Graph of Antenna Construction



Antenna Specification

Model No : XI-300

NO	Items	Specifications
1	Antenna shape	patch
2	RF frequency band	2.4~2.5 GHz
3	Power Handling	1000mw
4	impedance	50Ω
5	VSWR	Less than 1.8
6	Polarization	Linearity
7	Left Antenna Gain (VERTICAL)	-0.85dBi(max) -4.9 dBi(AVG.)
8	Left Antenna Gain (HORIZONTAL)	-0.44 dBi(max) -5.0dBi(AVG.)
9	Right Antenna Gain (VERTICAL)	-1.08 dBi(max) -3.7dBi(AVG.)
10	Right Antenna Gain (HORIZONTAL)	0.23dBi(max) -4.5dBi(AVG.)
11	Antenna directivity	Azimuth: Omni-directional Elevation: DOUBLE OVAL
12	Operating Temperature	0°C ~ +55°C
13	Notice	

XI-300 Patch Antenna

Radiation Pattern and Directivity Illustrations

File No	Illustrations	Directivity
Z09E1.DAT	Antenna 1, Horizontal Polarization Pattern @ 2.4GHz	
Z09E1.DAT	Antenna 1, Horizontal Polarization Pattern @ 2.45GHz	Reference to "Appendix (一)"
Z09E1.DAT	Antenna 1, Horizontal Polarization Pattern @ 2.5GHz	
Z09H1.DAT	Antenna 1, Vertical Polarization Pattern @ 2.4GHz	
Z09H1.DAT	Antenna 1, Vertical Polarization Pattern @ 2.45GHz	Reference to "Appendix (二)"
Z09H1.DAT	Antenna 1, Vertical Polarization Pattern @ 2.5GHz	
Z09E2.DAT	Antenna 2, Horizontal Polarization Pattern @ 2.4GHz	
Z09E2.DAT	Antenna 2, Horizontal Polarization Pattern @ 2.45GHz	Reference to "Appendix (三)"
Z09E2.DAT	Antenna 2, Horizontal Polarization Pattern @ 2.5GHz	
Z09H2.DAT	Antenna 2, Vertical Polarization Pattern @ 2.4GHz	
Z09H2.DAT	Antenna 2, Vertical Polarization Pattern @ 2.45GHz	Reference to "Appendix (四)"
Z09H2.DAT	Antenna 2, Vertical Polarization Pattern @ 2.5GHz	

Appendix (一) : Antenna 1_ Horizontal Pattern & Directivity Chart

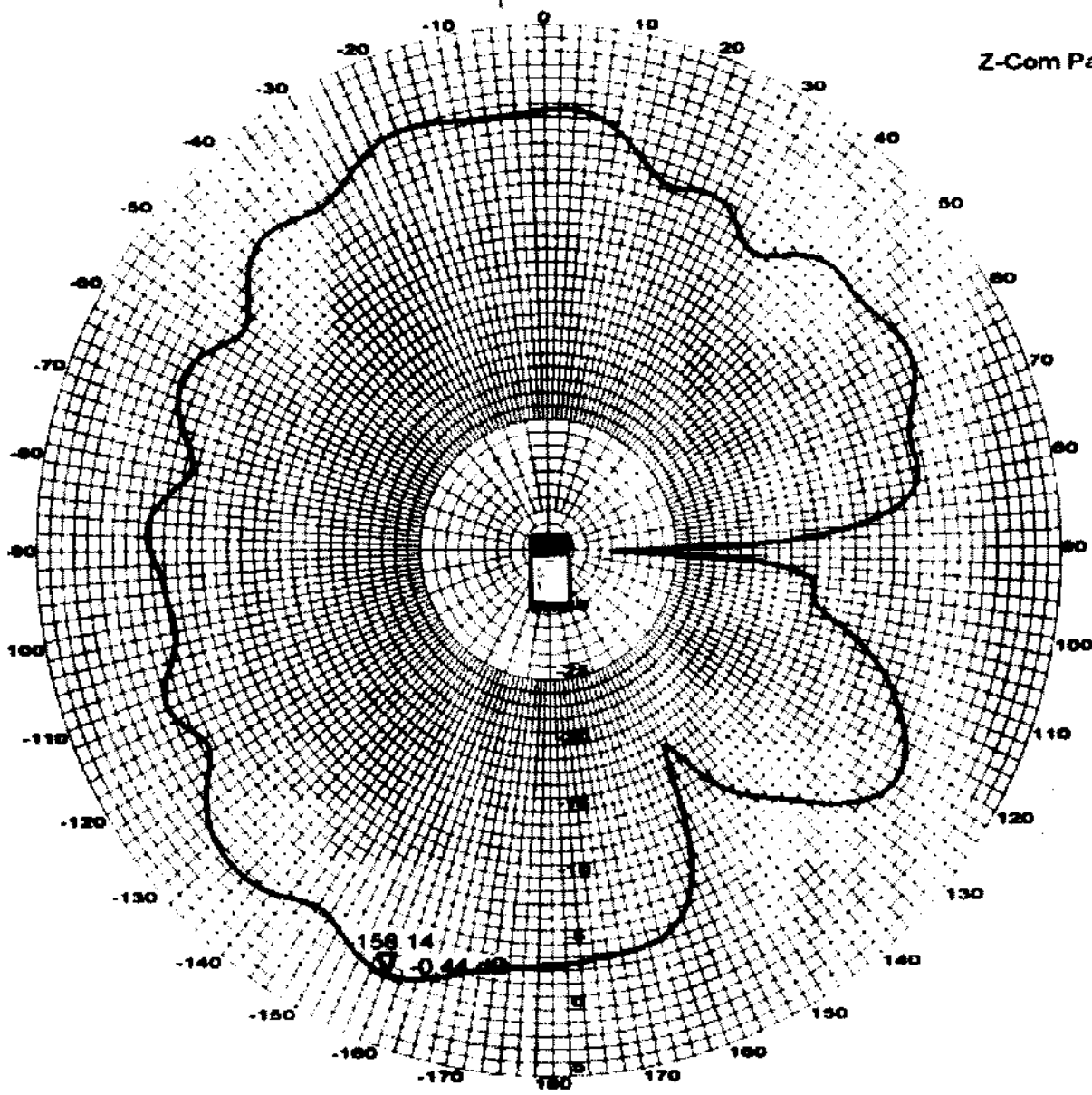

Z-Com Patch Antenna Pattern Measurement

File: Z09E1.DAT
 Date: 16-Mar-2000
 Time: 9:29
 Operator: W.B KANG
 Ser. no.:
 Channel: Pattern Tx pol: None Rx: None
 Frequency: 2.450 GHz

Calibration status:
 File: Z09E1.DAT
 Table: NARDA 645
 Chan: Pattern
 Units: dBi

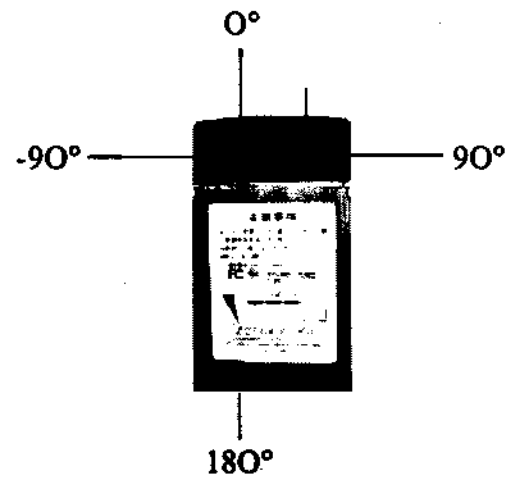

Appendix (二) : Antenna 1_Verical Pattern & Directivity Chart

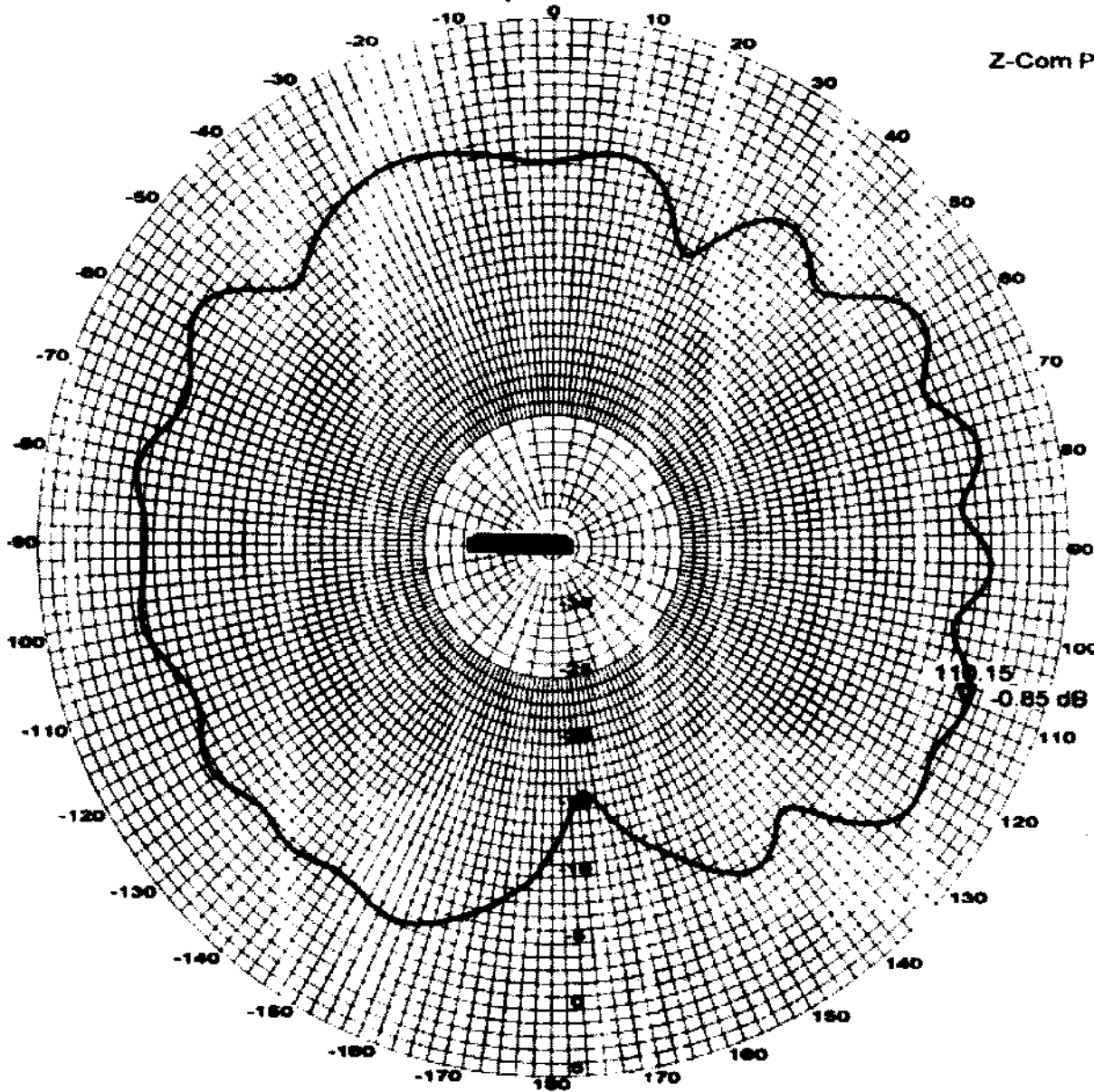

Z-Com Patch Antenna Pattern Measurement

File: Z09H1.DAT
Date: 16-Mar-2000
Time: 11:12
Operator: W.B.KANG
Ser. no.:
Channel: Pattern Tx pol: None Rx: None
Frequency: 2.450 GHz

Calibration status:
File: Z09H1.DAT
Table: NARDA 645
Chan: Pattern
Units: dBi

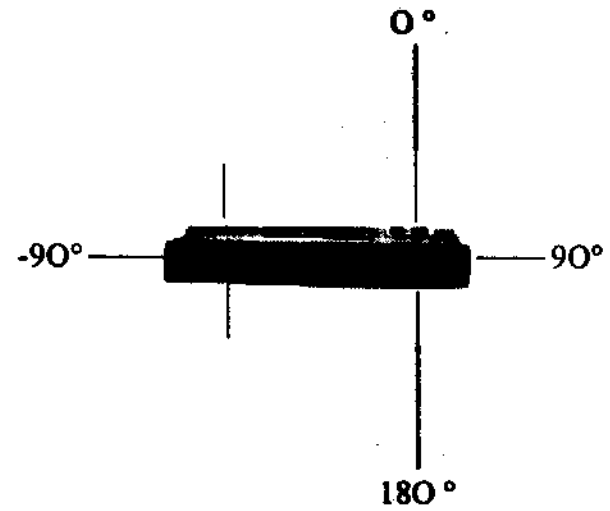

Appendix (三) : Antenna 2_ Horizontal Pattern & Directivity Chart

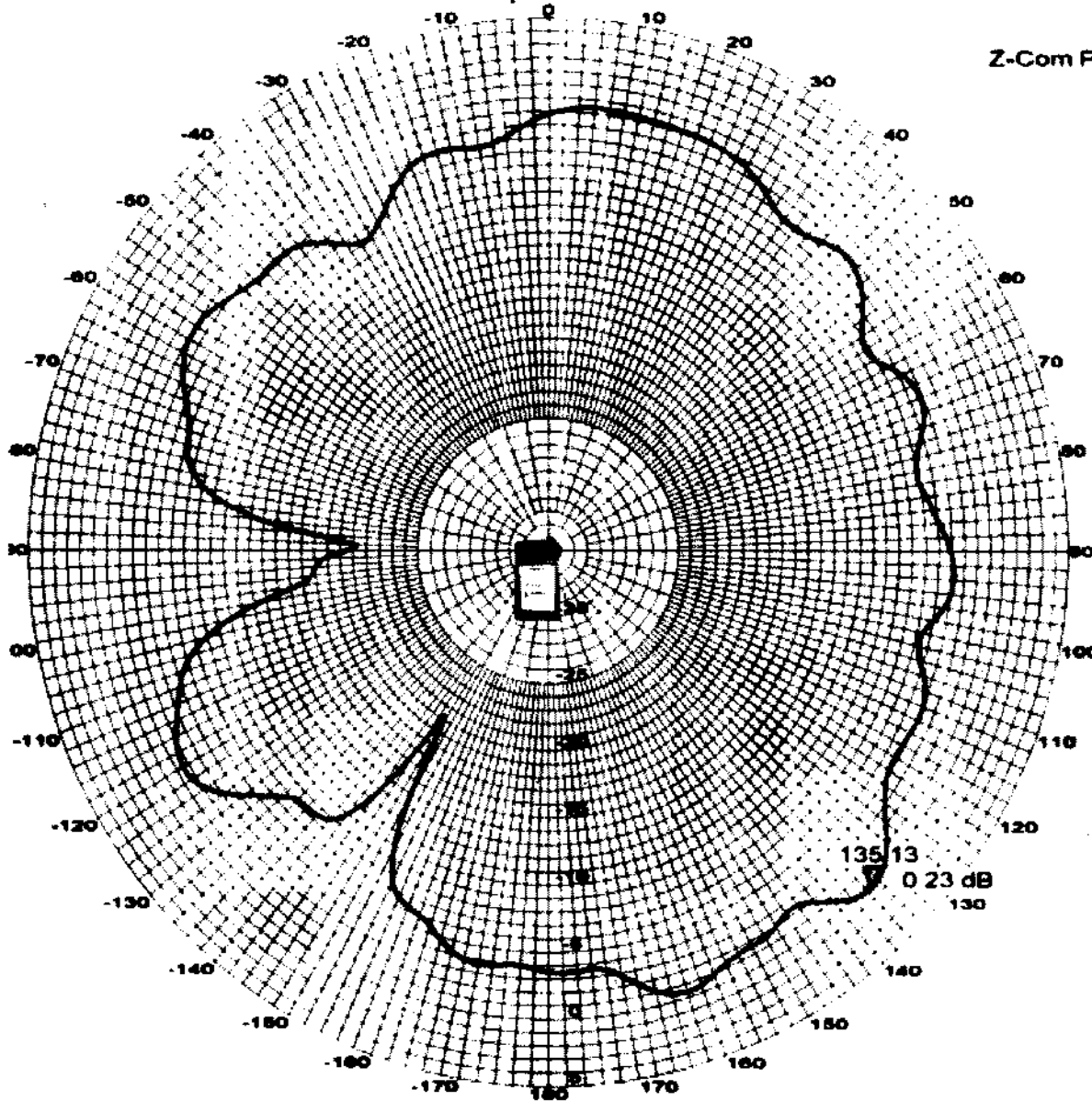

Z-Com Patch Antenna Pattern Measurement

File: Z09E2.DAT
Date: 16-Mar-2000
Time: 9:41
Operator: W.B.KANG
Ser. no.:
Channel: Pattern Tx pol: None Rx: None
Frequency: 2.450 GHz

Calibration status:
File: Z09E2.DAT
Table: NARDA 645
Chan.: Pattern
Units: dBi

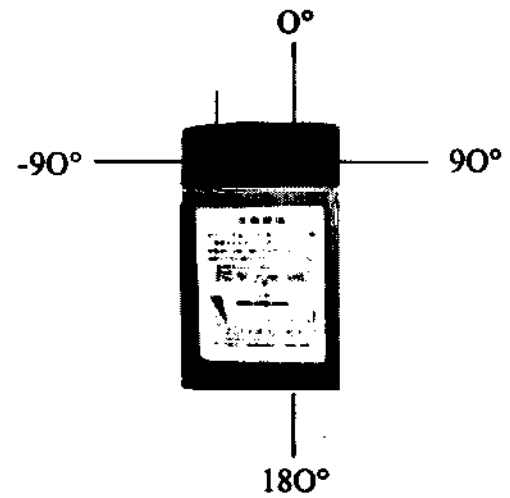

Appendix (四) : Antenna 2_ Vertical Pattern & Directivity Chart

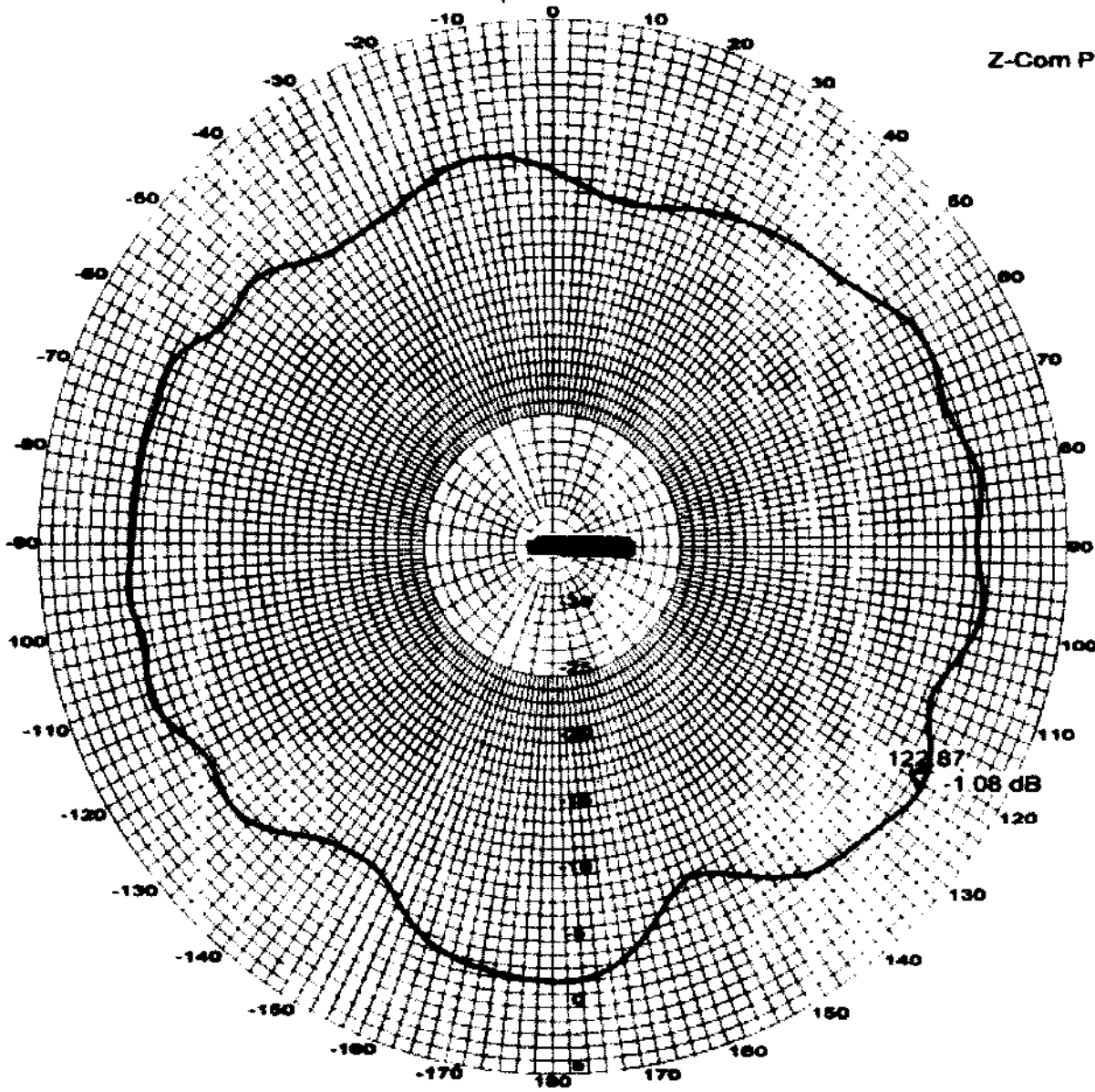

Z-Com Patch Antenna Pattern Measurement

File: Z09H2.DAT
Date: 16-Mar-2000
Time: 10:47
Operator: W.B.KANG
Ser. no.:
Channel: Pattern Tx pol: None Rx: None
Frequency: 2.450 GHz

Calibration status:
File: Z09H2.DAT
Table: NARDA 645
Chan: Pattern
Units: dBi

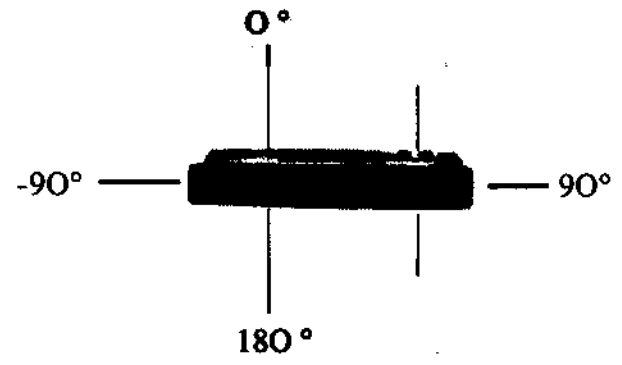

Appendix 3 : Ploted Datas of Emissions Bandwidth



LVLOFF

Res.Bw 100.0 kHz [3dB]

Vid.Bw 300 kHz

300 kHz

Ref.Lvl
30.50 dBm

Delta

0.30 dB
11.08 MHz

TG.Lvl
CF.Stp

off
2.000 MHz

RF.Att
Unit

20 dB
[dBm]

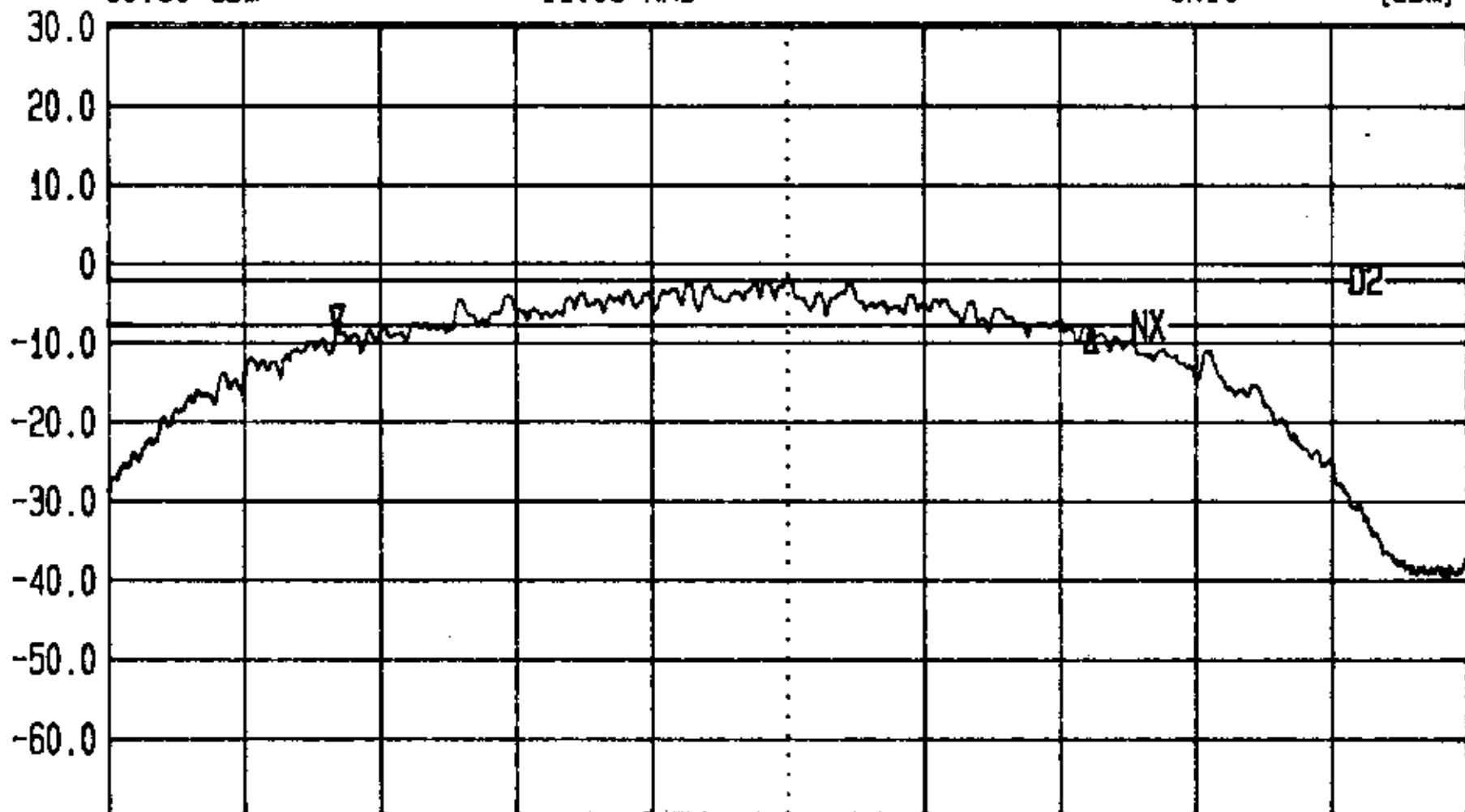

Start
2.40297 GHz

Span
20 MHz

Center
2.41297 GHz

Sweep
2.0 s

Stop
2.42297 GHz

LVLOFF

Res.Bw 100.0 kHz [3dB]

Vid.Bw 300 kHz



Ref.Lvl
30.50 dBm

Delta

0.28 dB
11.06 MHz

TG.Lvl

off

CF.Stp

2.000 MHz

RF.Att
Unit

20 dB
[dBm]

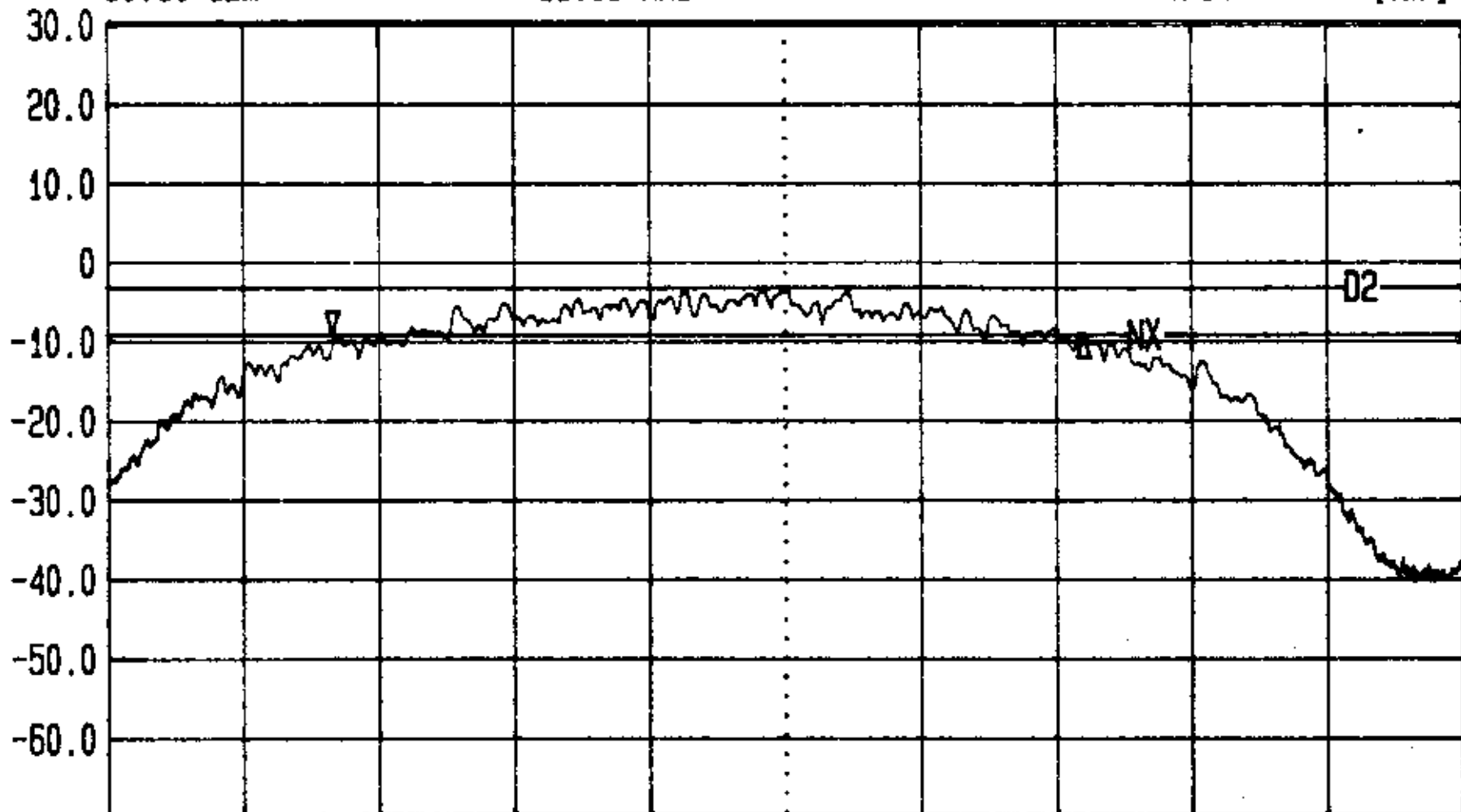

Start
2.42799 GHz

Span
20 MHz

Center
2.43799 GHz

Sweep
2.0 s

Stop
2.44799 GHz



LVLOFF

Res.Bw 100.0 kHz [3dB]
TG.Lvl off
CF.Stp 2.000 MHz

Vid.Bw 300 kHz
RF.Att 20 dB
Unit [dBm]

Ref.Lvl 30.50 dBm
Delta 0.76 dB
11.06 MHz

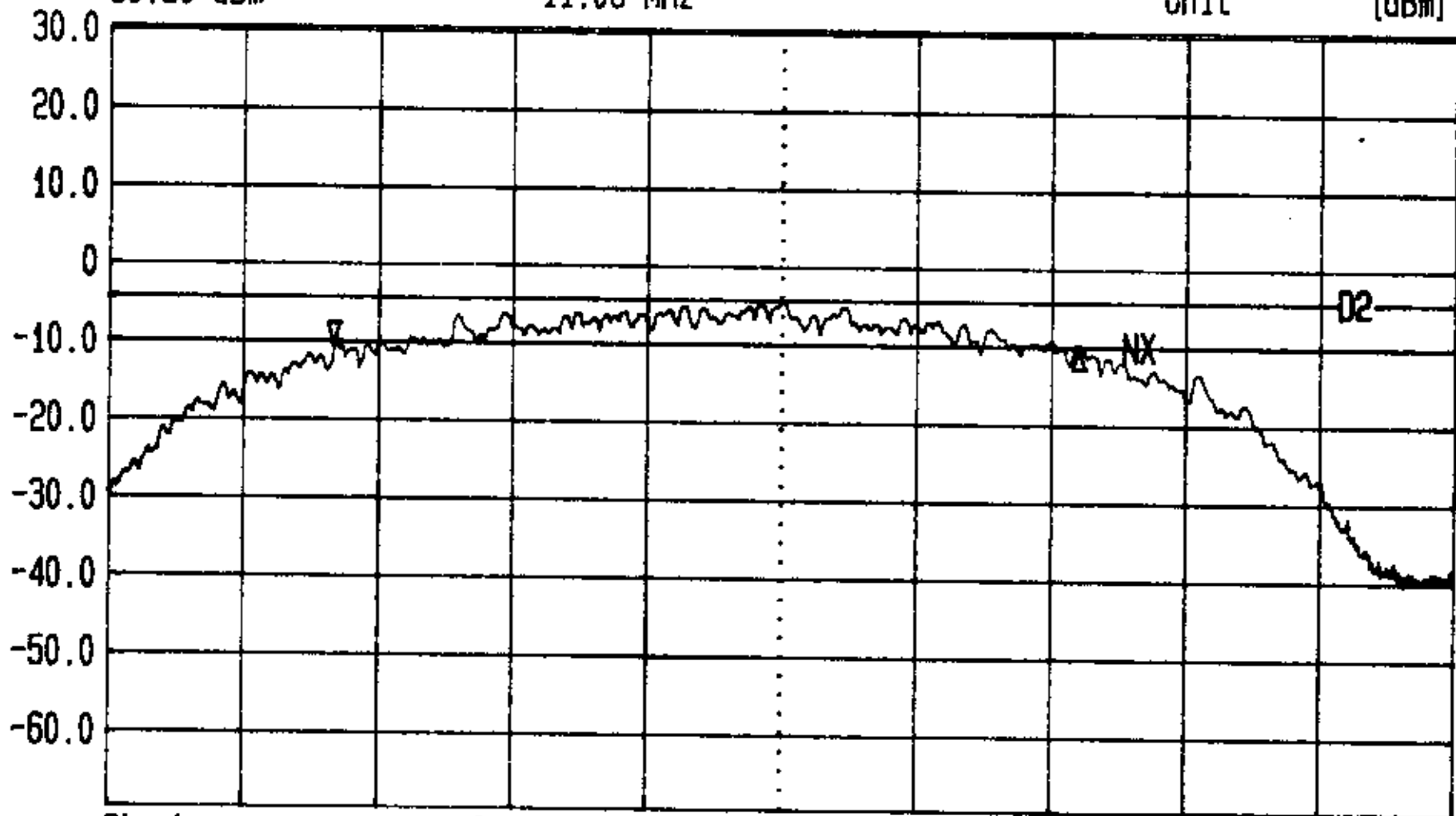

Start
2.45297 GHz

Span
20 MHz

Center
2.46297 GHz

Sweep
2.0 s

Stop
2.47297 GHz

Appendix 4 : Ploted Datas of Output Peak Power



LVLOFF

Res.Bw 3.0 MHz [3dB]
TG.Lvl off
CF.Stp 5.000 MHz

Vid.Bw 3 MHz
RF.Att 20 dB
Unit [dBm]

Ref.Lvl 30.50 dBm
Marker 10.80 dBm
2.41133 GHz

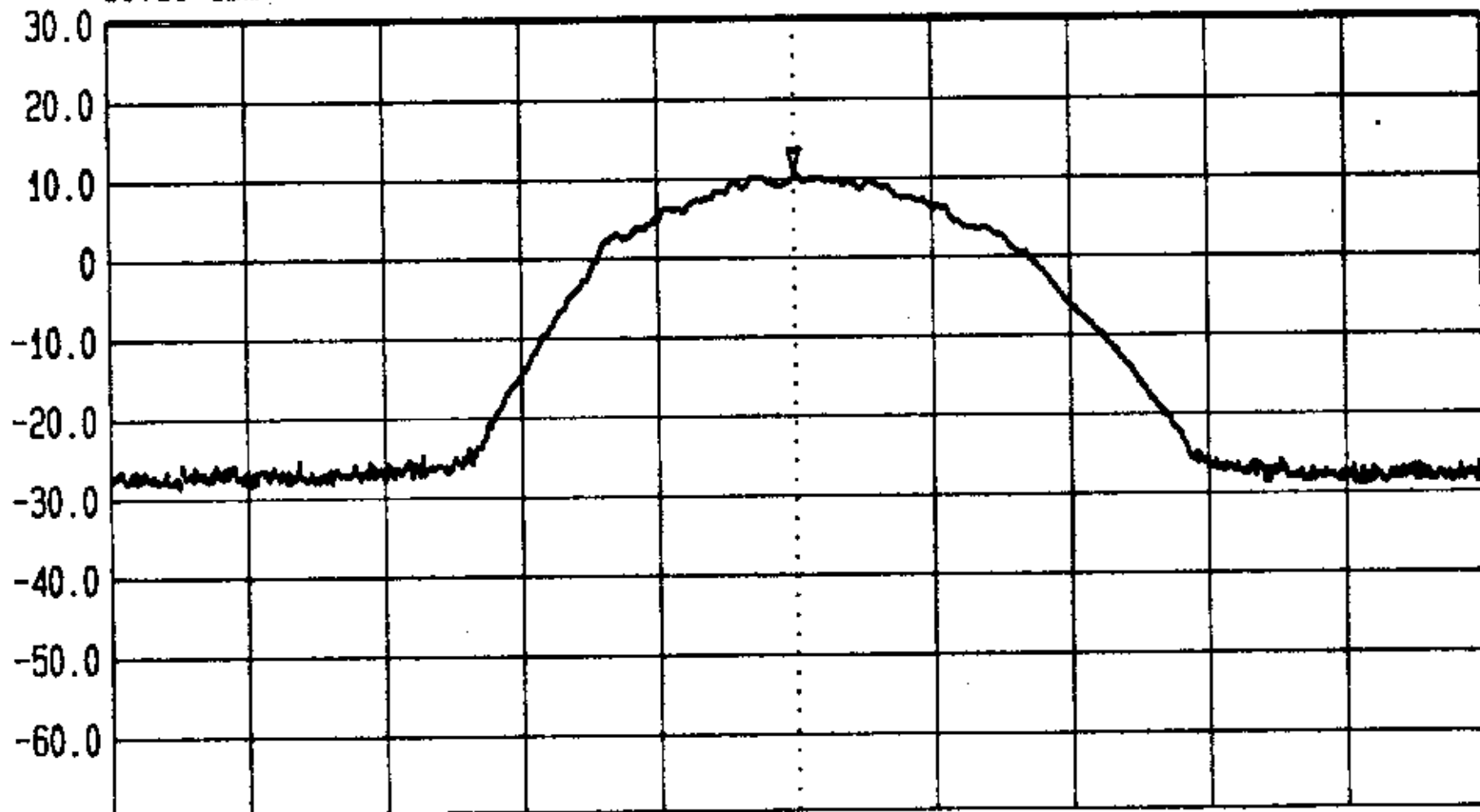

Start 2.38627 GHz Span 50 MHz Center 2.41127 GHz Sweep 600 ms Stop 2.43627 GHz



LVLOFF

Res.Bw 3.0 MHz [3dB] Vid.Bw 3 MHz

TG.Lvl off

Ref.Lvl 30.50 dBm

Marker 9.58 dBm
2.43633 GHz

CF.Stp 5.000 MHz

RF.Att Unit 20 dB [dBm]

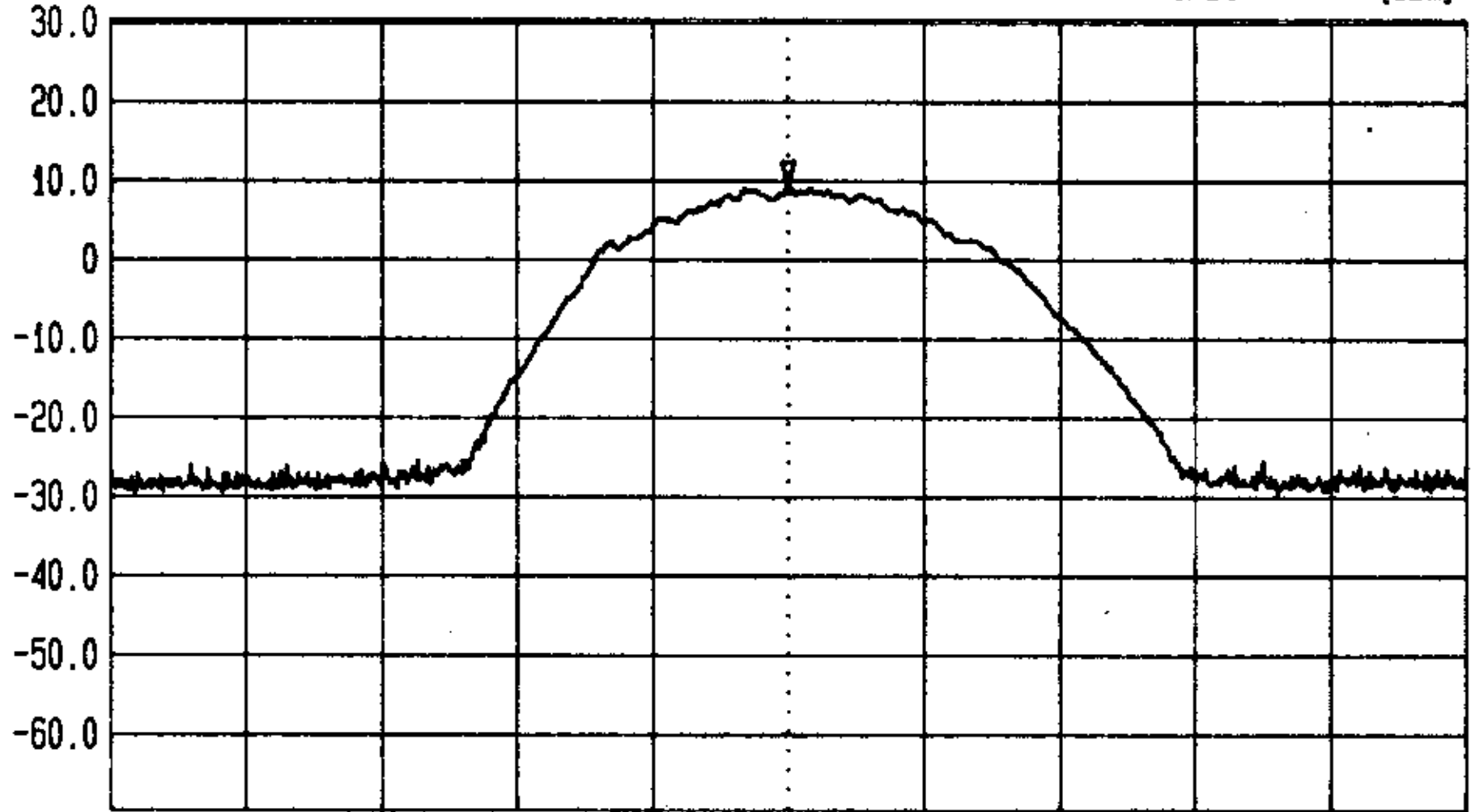

Start 2.41133 GHz

Span 50 MHz

Center 2.43633 GHz

Sweep 600 ms

Stop 2.46133 GHz



LVLOFF

Res.Bw
TG.Lvl
CF.Stp

3.0 MHz [3dB]
off
5.000 MHz

Vid.Bw
RF.Att
Unit

3 MHz
20 dB
[dBm]

Ref.Lvl
30.50 dBm

Marker

8.72 dBm
2.46133 GHz

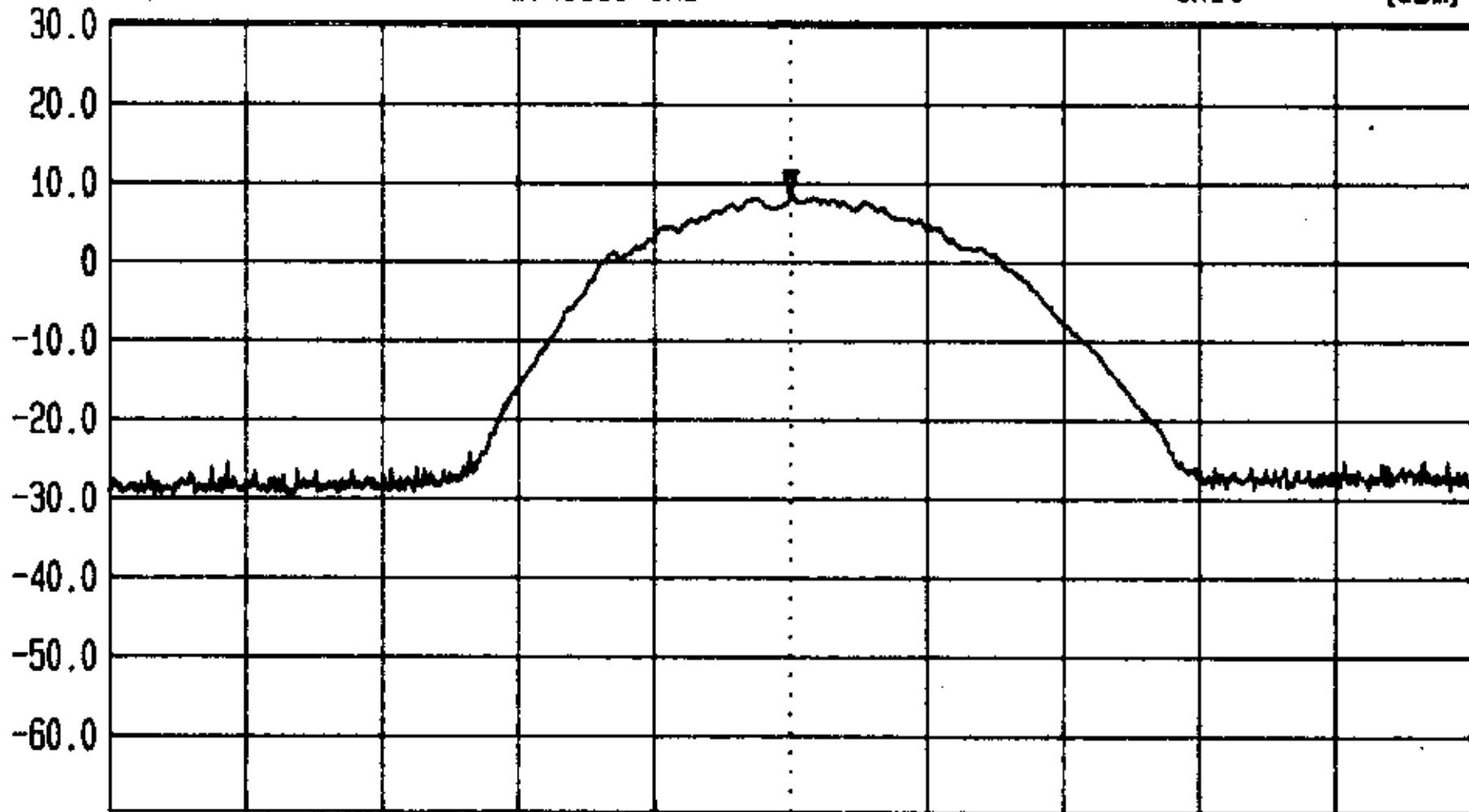

Start
2.43627 GHz

Span
50 MHz

Center
2.46127 GHz

Sweep
600 ms

Stop
2.48627 GHz

Appendix 5 : Ploted Datas of Band Edge Emission



LVLOFF

Res.Bw 100.0 kHz [3dB]

Vid.Bw 100 kHz

TG.Lvl off

Ref.Lvl
30.50 dBm

Marker
-37.75 dBm
2.40022 GHz

CF.Stp
8.000 MHz

RF.Att
Unit
20 dB
[dBm]

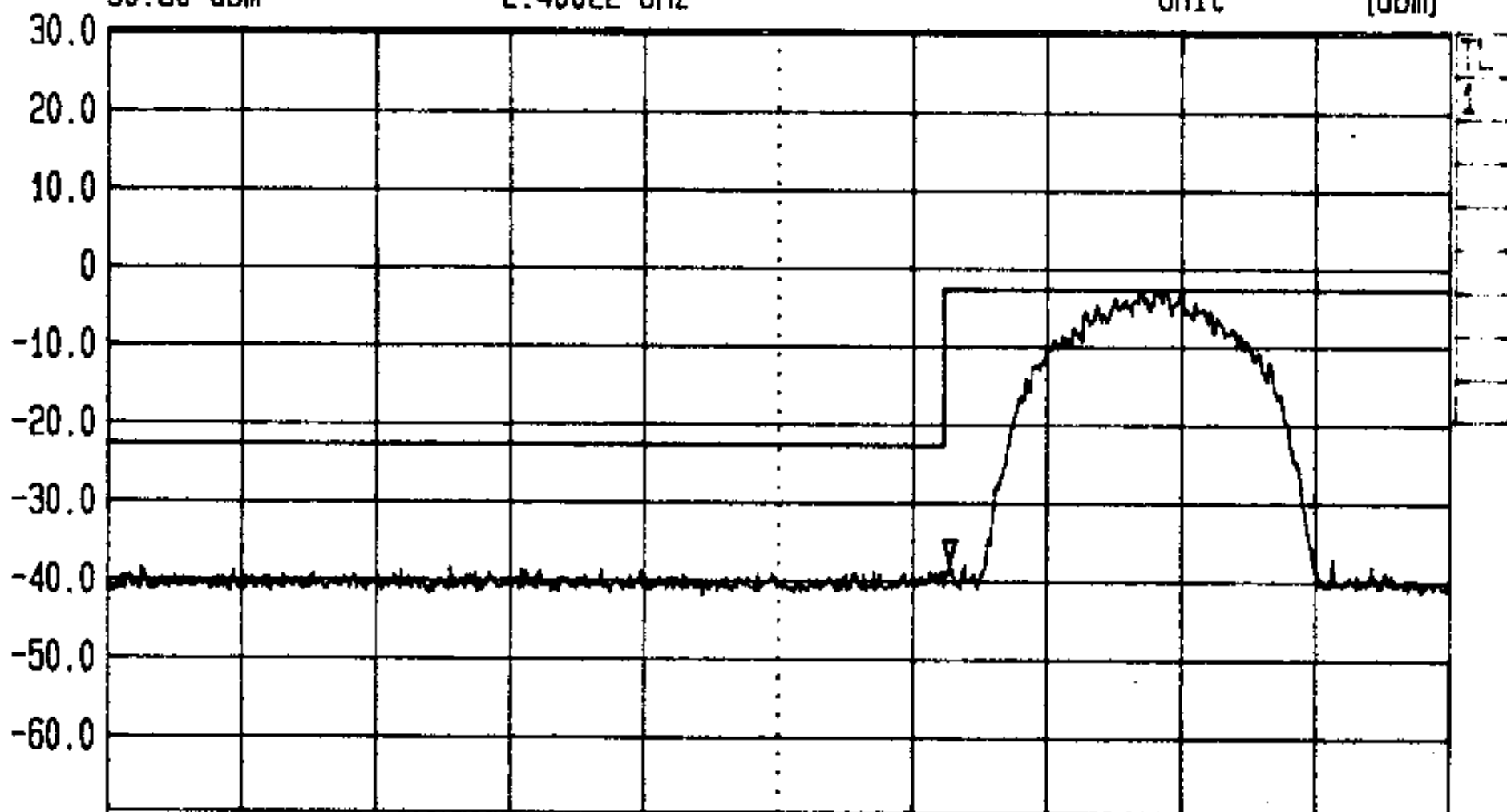

Start
2.35 GHz

Span
80 MHz

Center
2.39 GHz

Sweep
200 ms

Stop
2.43 GHz



LVLOFF

Res.Bw 100.0 kHz [3dB] Vid.Bw 100 kHz
TG.Lvl off
CF.Stp 10.000 MHz RF.Att 20 dB
Unit [dBm]

Ref.Lvl 30.50 dBm
Marker -40.06 dBm
2.4836 GHz

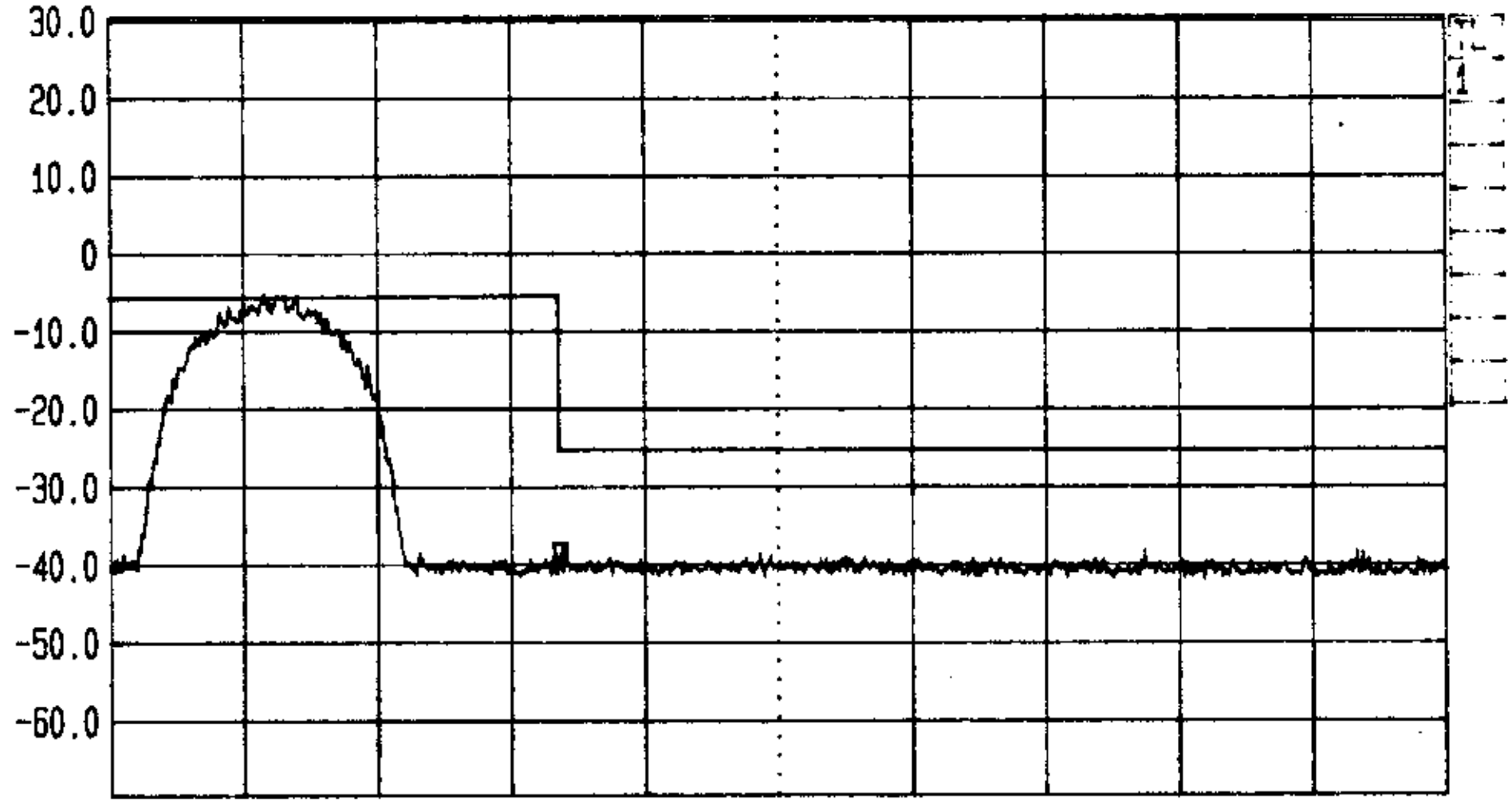

Start 2.45 GHz Span 100 MHz Center 2.5 GHz Sweep 200 ms Stop 2.55 GHz

Appendix 6 : Ploted Datas of Power Density



LVLOFF

Res.Bw

3.0 kHz [3dB]

Vid.Bw

3 kHz

TG.Lvl

off

CF.Stp

30.000 kHz

RF.Att

20 dB

Unit

[dBm]

Ref.Lvl

Marker

-16.22 dBm

30.50 dBm

2.4134114 GHz

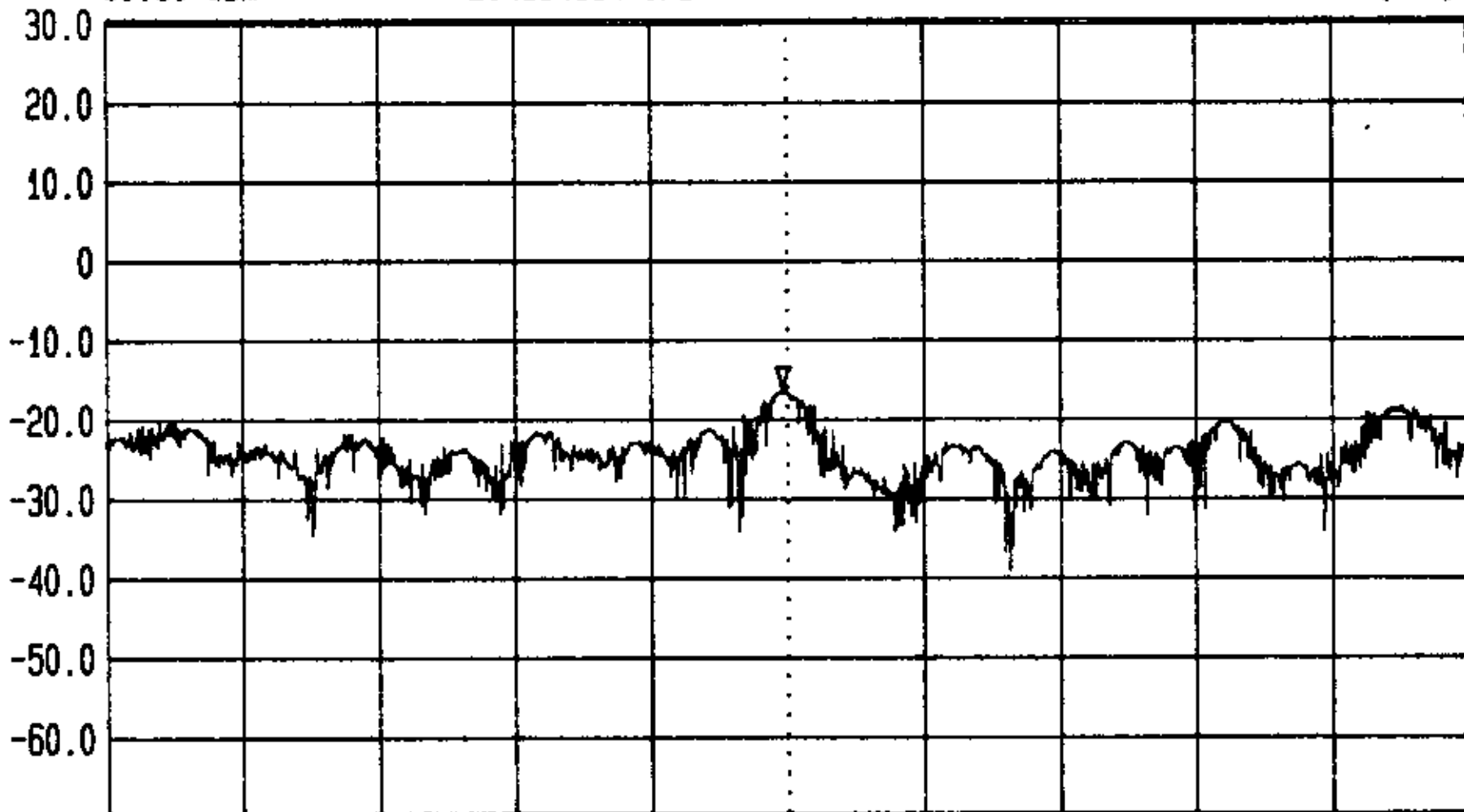

Start

2.413262494 GHz

Span

300 kHz

Center

2.413412494 GHz

Sweep

100 s

Stop

2.413562494 GHz



LVLOFF

Res.Bw
TG.Lvl
CF.Stp

3.0 kHz [3dB]
off
30.000 kHz

Vid.Bw
RF.Att
Unit

3 kHz
20 dB
[dBm]

Ref.Lvl
30.50 dBm
Marker
-17.34 dBm
2.4384111 GHz

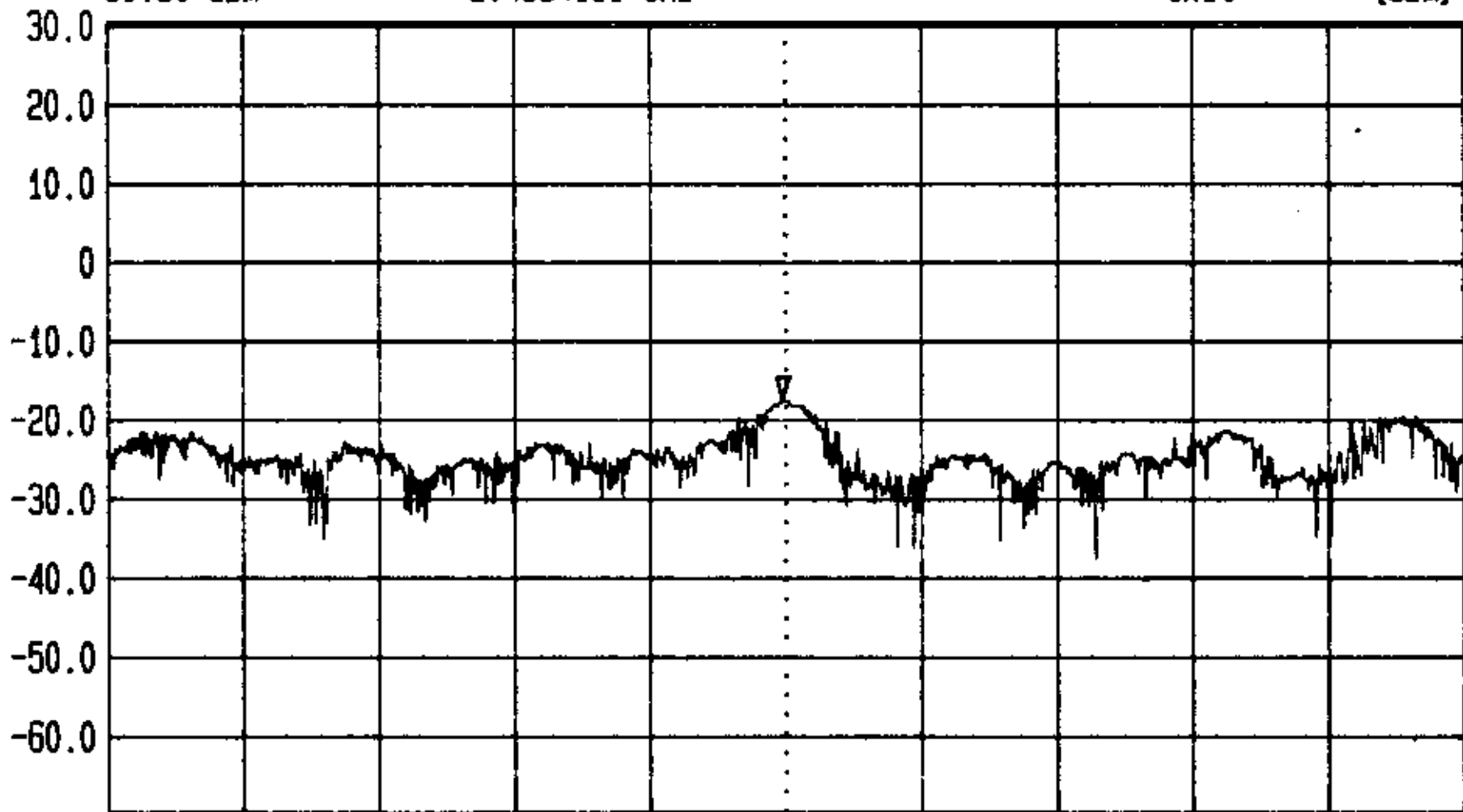

Start 2.438261455 GHz Span 300 kHz Center 2.438411455 GHz Sweep 100 s Stop 2.438561455 GHz



LVLOFF

Res.Bw
TG.Lvl
CF.Stp

3.0 kHz [3dB]
off
30.000 kHz

Vid.Bw
RF.Att
Unit

3 kHz
20 dB
[dBm]

Ref.Lvl
30.50 dBm

Marker
-18.02 dBm
2.4634108 GHz

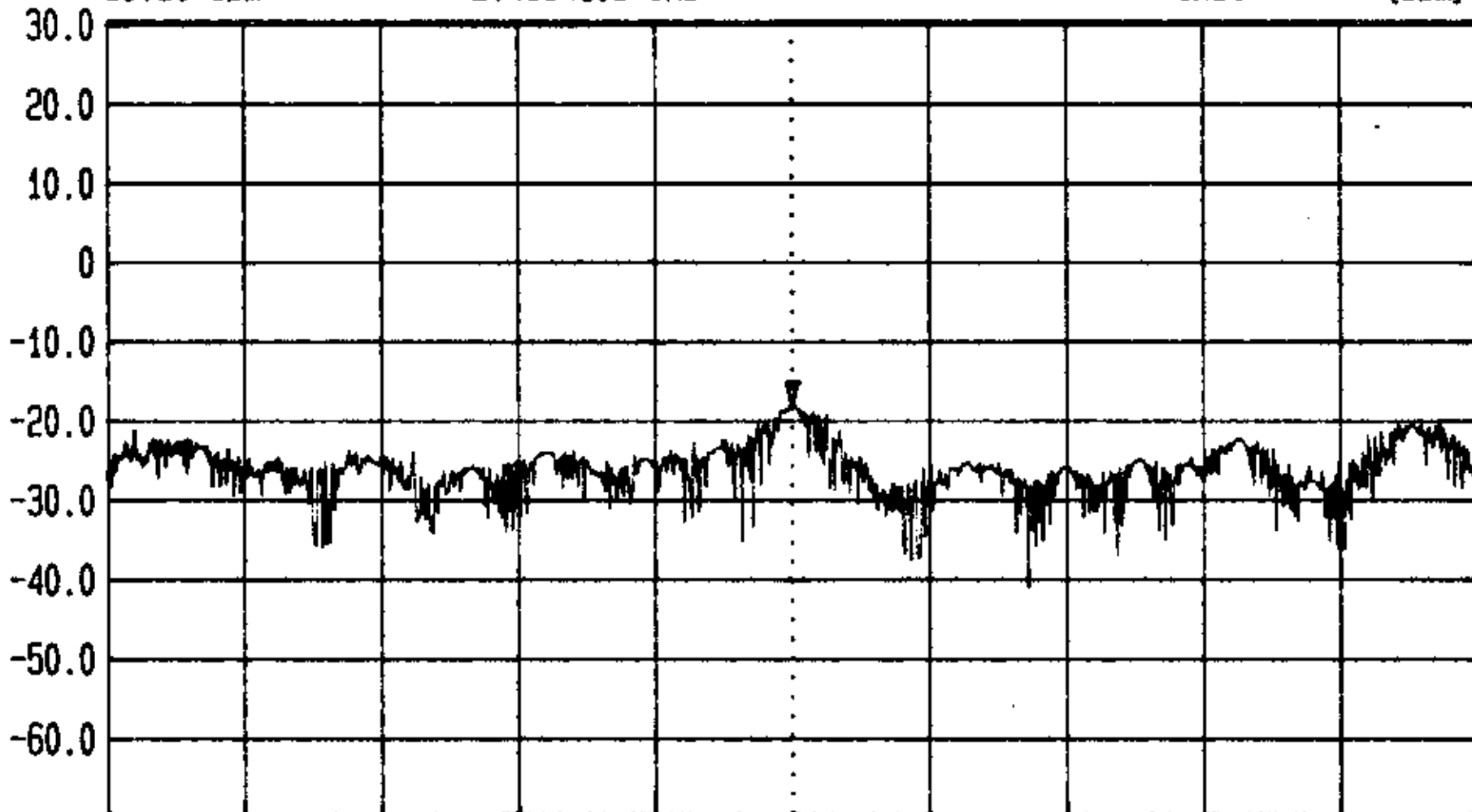

Start
2.463260856 GHz

Span
300 kHz

Center
2.463410856 GHz

Sweep
100 s

Stop
2.463560856 GHz

Appendix 7 : Processing Gain Tested Data Sheets

2Mbps Channel 1 Processing Gain							
Gp=(S/N)o+Mj+Lsys							
Freq. (MHz)	Gp (dB)	(S/N)o (dB)	Mj = J/S (dB)	Lsys (dB)	Jammer (dBm)	Lvl (dBm)	FE R
2403.50	17.4	12.6	2.8	2	-27.2	-30	5.8
2403.55	17	12.6	2.4	2	-27.6	-30	6.7
2403.60	16.7	12.6	2.1	2	-27.9	-30	6.5
2403.65	16.6	12.6	2	2	-28	-30	6
2403.70	16.5	12.6	1.9	2	-28.1	-30	6.3
2403.75	16.4	12.6	1.8	2	-28.2	-30	6.8
2403.80	16.3	12.6	1.7	2	-28.3	-30	6
2403.85	16.4	12.6	1.8	2	-28.2	-30	5.9
2403.90	16.5	12.6	1.9	2	-28.1	-30	6.4
2403.95	16.5	12.6	1.9	2	-28.1	-30	5.6
2404.00	16.6	12.6	2	2	-28	-30	6.7
2404.05	16.6	12.6	2	2	-28	-30	6.3
2404.10	16.4	12.6	1.8	2	-28.2	-30	6.2
2404.15	16.5	12.6	1.9	2	-28.1	-30	5.4
2404.20	16.5	12.6	1.9	2	-28.1	-30	5.2
2404.25	16.4	12.6	1.8	2	-28.2	-30	6
2404.30	16.3	12.6	1.7	2	-28.3	-30	5.6
2404.35	16.2	12.6	1.6	2	-28.4	-30	6.4
2404.40	16.1	12.6	1.5	2	-28.5	-30	6.2
2404.45	16	12.6	1.4	2	-28.6	-30	6.7
2404.50	15.9	12.6	1.3	2	-28.7	-30	7.3
2404.55	15.7	12.6	1.1	2	-28.9	-30	6.1
2404.60	15.5	12.6	0.9	2	-29.1	-30	5.8
2404.65	15.4	12.6	0.8	2	-29.2	-30	6.9
2404.70	15.4	12.6	0.8	2	-29.2	-30	6.3
2404.75	15.3	12.6	0.7	2	-29.3	-30	6.4
2404.80	15.3	12.6	0.7	2	-29.3	-30	5.7
2404.85	15.2	12.6	0.6	2	-29.4	-30	5.6
2404.90	15.3	12.6	0.7	2	-29.3	-30	5.4
2404.95	15.4	12.6	0.8	2	-29.2	-30	5.1
2405.00	15.4	12.6	0.8	2	-29.2	-30	4.8
2405.05	15.5	12.6	0.9	2	-29.1	-30	5.1
2405.10	15.5	12.6	0.9	2	-29.1	-30	6.3

2405.15	15.5	12.6	0.9	2	-29.1	-30	6.2
2405.20	15.6	12.6	1	2	-29	-30	5.7
2405.25	15.5	12.6	0.9	2	-29.1	-30	5.6
2405.30	15.4	12.6	0.8	2	-29.2	-30	4.7
2405.35	15.3	12.6	0.7	2	-29.3	-30	5.8
2405.40	15.3	12.6	0.7	2	-29.3	-30	6.3
2405.45	14.8	12.6	0.2	2	-29.8	-30	6.7
2405.50	15.7	12.6	1.1	2	-28.9	-30	6.5
2405.55	14.3	12.6	-0.3	2	-30.3	-30	7.3
2405.60	14.2	12.6	-0.4	2	-30.4	-30	6.2
2405.65	14.1	12.6	-0.5	2	-30.5	-30	5.1
2405.70	14.1	12.6	-0.5	2	-30.5	-30	5.5
2405.75	14.1	12.6	-0.5	2	-30.5	-30	5.7
2405.80	14.1	12.6	-0.5	2	-30.5	-30	6
2405.85	14.1	12.6	-0.5	2	-30.5	-30	5.9
2405.90	14.3	12.6	-0.3	2	-30.3	-30	6.1
2405.95	14.4	12.6	-0.2	2	-30.2	-30	7.3
2406.00	14.5	12.6	-0.1	2	-30.1	-30	7.1
2406.05	14.8	12.6	0.2	2	-29.8	-30	6.5
2406.10	15	12.6	0.4	2	-29.6	-30	6.3
2406.15	14.9	12.6	0.3	2	-29.7	-30	6.1
2406.20	15.5	12.6	0.9	2	-29.1	-30	5.5
2406.25	16	12.6	1.4	2	-28.6	-30	5.8
2406.30	17.1	12.6	2.5	2	-27.5	-30	6.6
2406.35	16.8	12.6	2.2	2	-27.8	-30	6.1
2406.40	15.9	12.6	1.3	2	-28.7	-30	6.7
2406.45	16.3	12.6	1.7	2	-28.3	-30	6.5
2406.50	16.1	12.6	1.5	2	-28.5	-30	7.6
2406.55	15.7	12.6	1.1	2	-28.9	-30	7.1
2406.60	16	12.6	1.4	2	-28.6	-30	7.3
2406.65	16.2	12.6	1.6	2	-28.4	-30	6.8
2406.70	15.8	12.6	1.2	2	-28.8	-30	6.2
2406.75	15.6	12.6	1	2	-29	-30	5.9
2406.80	15.2	12.6	0.6	2	-29.4	-30	5.6
2406.85	14.9	12.6	0.3	2	-29.7	-30	5.4
2406.90	14.2	12.6	-0.4	2	-30.4	-30	5.9

2406.95	13.8	12.6	-0.8	2	-30.8	-30	6
2407.00	13.7	12.6	-0.9	2	-30.9	-30	5.3
2407.05	13.4	12.6	-1.2	2	-31.2	-30	5.1
2407.10	13.6	12.6	-1	2	-31	-30	4.8
2407.15	13.5	12.6	-1.1	2	-31.1	-30	5.3
2407.20	13.1	12.6	-1.5	2	-31.5	-30	5.8
2407.25	13.2	12.6	-1.4	2	-31.4	-30	6.7
2407.30	13.5	12.6	-1.1	2	-31.1	-30	6.3
2407.35	13.1	12.6	-1.5	2	-31.5	-30	6.1
2407.40	13.5	12.6	-1.1	2	-31.1	-30	7.2
2407.45	13.6	12.6	-1	2	-31	-30	6.3
2407.50	13.8	12.6	-0.8	2	-30.8	-30	5.6
2407.55	14	12.6	-0.6	2	-30.6	-30	5.7
2407.60	13.8	12.6	-0.8	2	-30.8	-30	6.2
2407.65	13.7	12.6	-0.9	2	-30.9	-30	5.6
2407.70	13.8	12.6	-0.8	2	-30.8	-30	5.8
2407.75	13.8	12.6	-0.8	2	-30.8	-30	7.1
2407.80	13.7	12.6	-0.9	2	-30.9	-30	6.3
2407.85	13.7	12.6	-0.9	2	-30.9	-30	6.2
2407.90	13.7	12.6	-0.9	2	-30.9	-30	5.4
2407.95	13.6	12.6	-1	2	-31	-30	5.2
2408.00	13.6	12.6	-1	2	-31	-30	6.1
2408.05	13.3	12.6	-1.3	2	-31.3	-30	6.3
2408.10	13.1	12.6	-1.5	2	-31.5	-30	5.8
2408.15	13.1	12.6	-1.5	2	-31.5	-30	7.4
2408.20	12.9	12.6	-1.7	2	-31.7	-30	6.4
2408.25	13.1	12.6	-1.5	2	-31.5	-30	6.1
2408.30	12.8	12.6	-1.8	2	-31.8	-30	4.8
2408.35	12.8	12.6	-1.8	2	-31.8	-30	5.7
2408.40	12.8	12.6	-1.8	2	-31.8	-30	6.2
2408.45	12.9	12.6	-1.7	2	-31.7	-30	6.7
2408.50	12.9	12.6	-1.7	2	-31.7	-30	5.4
2408.55	12.8	12.6	-1.8	2	-31.8	-30	5.2
2408.60	13.1	12.6	-1.5	2	-31.5	-30	5.8
2408.65	13.2	12.6	-1.4	2	-31.4	-30	6.1
2408.70	12.8	12.6	-1.8	2	-31.8	-30	6.7

2408.75	12.8	12.6	-1.8	2	-31.8	-30	6.6
2408.80	12.9	12.6	-1.7	2	-31.7	-30	5.7
2408.85	12.7	12.6	-1.9	2	-31.9	-30	5.6
2408.90	12.7	12.6	-1.9	2	-31.9	-30	6.2
2408.95	12.5	12.6	-2.1	2	-32.1	-30	6.4
2409.00	12.4	12.6	-2.2	2	-32.2	-30	4.8
2409.05	12.2	12.6	-2.4	2	-32.4	-30	6.3
2409.10	12.4	12.6	-2.2	2	-32.2	-30	5.4
2409.15	12.1	12.6	-2.5	2	-32.5	-30	6.1
2409.20	12.7	12.6	-1.9	2	-31.9	-30	6.2
2409.25	12.1	12.6	-2.5	2	-32.5	-30	5.8
2409.30	12.1	12.6	-2.5	2	-32.5	-30	6.7
2409.35	12.2	12.6	-2.4	2	-32.4	-30	6.2
2409.40	11.9	12.6	-2.7	2	-32.7	-30	6.3
2409.45	12.2	12.6	-2.4	2	-32.4	-30	6.6
2409.50	12.1	12.6	-2.5	2	-32.5	-30	6.5
2409.55	12	12.6	-2.6	2	-32.6	-30	6.9
2409.60	12.1	12.6	-2.5	2	-32.5	-30	7.6
2409.65	12.3	12.6	-2.3	2	-32.3	-30	6.3
2409.70	12.1	12.6	-2.5	2	-32.5	-30	5.9
2409.75	12	12.6	-2.6	2	-32.6	-30	6.4
2409.80	12.1	12.6	-2.5	2	-32.5	-30	6.1
2409.85	12.3	12.6	-2.3	2	-32.3	-30	6.2
2409.90	12	12.6	-2.6	2	-32.6	-30	5.8
2409.95	12	12.6	-2.6	2	-32.6	-30	5.3
2410.00	11.8	12.6	-2.8	2	-32.8	-30	5.6
2410.05	11.8	12.6	-2.8	2	-32.8	-30	5.5
2410.10	11.5	12.6	-3.1	2	-33.1	-30	6.3
2410.15	11.8	12.6	-2.8	2	-32.8	-30	9.8
2410.20	11.2	12.6	-3.4	2	-33.4	-30	6.6
2410.25	11.6	12.6	-3	2	-33	-30	6.1
2410.30	11.3	12.6	-3.3	2	-33.3	-30	6.7
2410.35	11.6	12.6	-3	2	-33	-30	5.7
2410.40	11.6	12.6	-3	2	-33	-30	7.6
2410.45	11.7	12.6	-2.9	2	-32.9	-30	7.2
2410.50	11.8	12.6	-2.8	2	-32.8	-30	7.1

2410.55	11.9	12.6	-2.7	2	-32.7	-30	6.8
2410.60	11.9	12.6	-2.7	2	-32.7	-30	6.3
2410.65	12	12.6	-2.6	2	-32.6	-30	6.5
2410.70	11.9	12.6	-2.7	2	-32.7	-30	6.1
2410.75	11.9	12.6	-2.7	2	-32.7	-30	6.2
2410.80	11.9	12.6	-2.7	2	-32.7	-30	6.9
2410.85	12.1	12.6	-2.5	2	-32.5	-30	6.6
2410.90	11.9	12.6	-2.7	2	-32.7	-30	6.1
2410.95	11.7	12.6	-2.9	2	-32.9	-30	6.7
2411.00	11.5	12.6	-3.1	2	-33.1	-30	6.6
2411.05	11.4	12.6	-3.2	2	-33.2	-30	6.3
2411.10	11	12.6	-3.6	2	-33.6	-30	6.8
2411.15	11.2	12.6	-3.4	2	-33.4	-30	6.1
2411.20	11	12.6	-3.6	2	-33.6	-30	6.7
2411.25	11.1	12.6	-3.5	2	-33.5	-30	6.4
2411.30	11.1	12.6	-3.5	2	-33.5	-30	4.8
2411.35	11.3	12.6	-3.3	2	-33.3	-30	5.6
2411.40	11.2	12.6	-3.4	2	-33.4	-30	6.3
2411.45	11.3	12.6	-3.3	2	-33.3	-30	6.7
2411.50	11.6	12.6	-3	2	-33	-30	6.2
2411.55	12.4	12.6	-2.2	2	-32.2	-30	6.8
2411.60	12.6	12.6	-2	2	-32	-30	6.3
2411.65	12.8	12.6	-1.8	2	-31.8	-30	5.9
2411.70	13.7	12.6	-0.9	2	-30.9	-30	6
2411.75	16	12.6	1.4	2	-28.6	-30	5.7
2411.80	16.4	12.6	1.8	2	-28.2	-30	7.9
2411.85	16.3	12.6	1.7	2	-28.3	-30	6.4
2411.90	16.6	12.6	2	2	-28	-30	4.8
2411.95	16.8	12.6	2.2	2	-27.8	-30	6.9
2412.00	16.5	12.6	1.9	2	-28.1	-30	5.4
2412.05	15.8	12.6	1.2	2	-28.8	-30	6.5
2412.10	15.7	12.6	1.1	2	-28.9	-30	7.6
2412.15	15.4	12.6	0.8	2	-29.2	-30	7.1
2412.20	15.2	12.6	0.6	2	-29.4	-30	6.7
2412.25	14.3	12.6	-0.3	2	-30.3	-30	5.6
2412.30	13	12.6	-1.6	2	-31.6	-30	7.4

2412.35	12	12.6	-2.6	2	-32.6	-30	6.8
2412.40	11.8	12.6	-2.8	2	-32.8	-30	6.3
2412.45	11.5	12.6	-3.1	2	-33.1	-30	5.9
2412.50	11.5	12.6	-3.1	2	-33.1	-30	6.2
2412.55	10.9	12.6	-3.7	2	-33.7	-30	7.1
2412.60	10.6	12.6	-4	2	-34	-30	7.3
2412.65	10.1	12.6	-4.5	2	-34.5	-30	7.4
2412.70	11	12.6	-3.6	2	-33.6	-30	6.8
2412.75	10.8	12.6	-3.8	2	-33.8	-30	5.8
2412.80	11.1	12.6	-3.5	2	-33.5	-30	6.7
2412.85	11.5	12.6	-3.1	2	-33.1	-30	6.6
2412.90	11.1	12.6	-3.5	2	-33.5	-30	6.9
2412.95	11.7	12.6	-2.9	2	-32.9	-30	7
2413.00	12	12.6	-2.6	2	-32.6	-30	7.6
2413.05	11.9	12.6	-2.7	2	-32.7	-30	6.3
2413.10	11.8	12.6	-2.8	2	-32.8	-30	5.2
2413.15	12	12.6	-2.6	2	-32.6	-30	5.4
2413.20	11.9	12.6	-2.7	2	-32.7	-30	4.6
2413.25	11.8	12.6	-2.8	2	-32.8	-30	5.6
2413.30	11.7	12.6	-2.9	2	-32.9	-30	7.4
2413.35	11.9	12.6	-2.7	2	-32.7	-30	6.8
2413.40	11.8	12.6	-2.8	2	-32.8	-30	6.3
2413.45	12.3	12.6	-2.3	2	-32.3	-30	5.9
2413.50	11.6	12.6	-3	2	-33	-30	6.2
2413.55	11.7	12.6	-2.9	2	-32.9	-30	7.1
2413.60	11.3	12.6	-3.3	2	-33.3	-30	7.3
2413.65	11.5	12.6	-3.1	2	-33.1	-30	7.4
2413.70	11	12.6	-3.6	2	-33.6	-30	6.1
2413.75	11.4	12.6	-3.2	2	-33.2	-30	5.8
2413.80	11.6	12.6	-3	2	-33	-30	6.7
2413.85	11.5	12.6	-3.1	2	-33.1	-30	5.3
2413.90	11.3	12.6	-3.3	2	-33.3	-30	5.8
2413.95	11.7	12.6	-2.9	2	-32.9	-30	6.3
2414.00	11.9	12.6	-2.7	2	-32.7	-30	6.7
2414.05	11.8	12.6	-2.8	2	-32.8	-30	6.2
2414.10	11.9	12.6	-2.7	2	-32.7	-30	5.6

2414.15	12	12.6	-2.6	2	-32.6	-30	6.3
2414.20	12	12.6	-2.6	2	-32.6	-30	6.8
2414.25	12	12.6	-2.6	2	-32.6	-30	6.1
2414.30	12.1	12.6	-2.5	2	-32.5	-30	6.9
2414.35	12	12.6	-2.6	2	-32.6	-30	6.2
2414.40	12.3	12.6	-2.3	2	-32.3	-30	5.9
2414.45	12.1	12.6	-2.5	2	-32.5	-30	6.1
2414.50	11.8	12.6	-2.8	2	-32.8	-30	5.7
2414.55	12	12.6	-2.6	2	-32.6	-30	6.6
2414.60	12.2	12.6	-2.4	2	-32.4	-30	4.8
2414.65	11.9	12.6	-2.7	2	-32.7	-30	5
2414.70	12	12.6	-2.6	2	-32.6	-30	4.4
2414.75	11.9	12.6	-2.7	2	-32.7	-30	5.8
2414.80	12.3	12.6	-2.3	2	-32.3	-30	7.1
2414.85	11.9	12.6	-2.7	2	-32.7	-30	4.8
2414.90	12.1	12.6	-2.5	2	-32.5	-30	5.7
2414.95	12	12.6	-2.6	2	-32.6	-30	6.5
2415.00	12.4	12.6	-2.2	2	-32.2	-30	5.8
2415.05	12.3	12.6	-2.3	2	-32.3	-30	6.7
2415.10	12.4	12.6	-2.2	2	-32.2	-30	6.6
2415.15	12.1	12.6	-2.5	2	-32.5	-30	6.1
2415.20	12.5	12.6	-2.1	2	-32.1	-30	5.9
2415.25	12.8	12.6	-1.8	2	-31.8	-30	6.2
2415.30	13.1	12.6	-1.5	2	-31.5	-30	5.6
2415.35	12.9	12.6	-1.7	2	-31.7	-30	6.8
2415.40	13.1	12.6	-1.5	2	-31.5	-30	6.3
2415.45	13	12.6	-1.6	2	-31.6	-30	5.9
2415.50	12.9	12.6	-1.7	2	-31.7	-30	5.7
2415.55	12.8	12.6	-1.8	2	-31.8	-30	6.3
2415.60	12.9	12.6	-1.7	2	-31.7	-30	6
2415.65	12.8	12.6	-1.8	2	-31.8	-30	6.1
2415.70	12.6	12.6	-2	2	-32	-30	5.7
2415.75	12.4	12.6	-2.2	2	-32.2	-30	5.9
2415.80	12.8	12.6	-1.8	2	-31.8	-30	5.5
2415.85	13	12.6	-1.6	2	-31.6	-30	5.3
2415.90	13.1	12.6	-1.5	2	-31.5	-30	5.4

2415.95	13.5	12.6	-1.1	2	-31.1	-30	5.1
2416.00	13.5	12.6	-1.1	2	-31.1	-30	5.4
2416.05	14.4	12.6	-0.2	2	-30.2	-30	6.3
2416.10	13.8	12.6	-0.8	2	-30.8	-30	7.6
2416.15	13.8	12.6	-0.8	2	-30.8	-30	7.1
2416.20	13.8	12.6	-0.8	2	-30.8	-30	7
2416.25	14.2	12.6	-0.4	2	-30.4	-30	6.3
2416.30	14	12.6	-0.6	2	-30.6	-30	5.4
2416.35	14.1	12.6	-0.5	2	-30.5	-30	5.8
2416.40	13.8	12.6	-0.8	2	-30.8	-30	6.2
2416.45	13.9	12.6	-0.7	2	-30.7	-30	7
2416.50	13.7	12.6	-0.9	2	-30.9	-30	6.3
2416.55	13.8	12.6	-0.8	2	-30.8	-30	6.9
2416.60	13.7	12.6	-0.9	2	-30.9	-30	5.7
2416.65	13.3	12.6	-1.3	2	-31.3	-30	5.2
2416.70	13.3	12.6	-1.3	2	-31.3	-30	7.1
2416.75	13	12.6	-1.6	2	-31.6	-30	6.7
2416.80	12.8	12.6	-1.8	2	-31.8	-30	6.3
2416.85	13.8	12.6	-0.8	2	-30.8	-30	6.4
2416.90	13.3	12.6	-1.3	2	-31.3	-30	6.8
2416.95	13.9	12.6	-0.7	2	-30.7	-30	7
2417.00	13.9	12.6	-0.7	2	-30.7	-30	6.3
2417.05	13.9	12.6	-0.7	2	-30.7	-30	6.7
2417.10	14.1	12.6	-0.5	2	-30.5	-30	6
2417.15	13.9	12.6	-0.7	2	-30.7	-30	6.3
2417.20	14.5	12.6	-0.1	2	-30.1	-30	6.6
2417.25	14.3	12.6	-0.3	2	-30.3	-30	7.2
2417.30	14.8	12.6	0.2	2	-29.8	-30	6.1
2417.35	16	12.6	1.4	2	-28.6	-30	6.4
2417.40	16.8	12.6	2.2	2	-27.8	-30	6.9
2417.45	16.5	12.6	1.9	2	-28.1	-30	6.8
2417.50	17.3	12.6	2.7	2	-27.3	-30	7.1
2417.55	16.9	12.6	2.3	2	-27.7	-30	6.3
2417.60	16.6	12.6	2	2	-28	-30	5.8
2417.65	16.3	12.6	1.7	2	-28.3	-30	6.5
2417.70	16.7	12.6	2.1	2	-27.9	-30	6.3

2417.75	16.1	12.6	1.5	2	-28.5	-30	5.7
2417.80	15.8	12.6	1.2	2	-28.8	-30	5.9
2417.85	14.8	12.6	0.2	2	-29.8	-30	6.1
2417.90	15	12.6	0.4	2	-29.6	-30	6
2417.95	15.1	12.6	0.5	2	-29.5	-30	6.3
2418.00	14.4	12.6	-0.2	2	-30.2	-30	5.9
2418.05	13.9	12.6	-0.7	2	-30.7	-30	6.5
2418.10	14.2	12.6	-0.4	2	-30.4	-30	7.1
2418.15	14.5	12.6	-0.1	2	-30.1	-30	6.7
2418.20	14	12.6	-0.6	2	-30.6	-30	6
2418.25	14.1	12.6	-0.5	2	-30.5	-30	6.4
2418.30	14.4	12.6	-0.2	2	-30.2	-30	6.6
2418.35	14.7	12.6	0.1	2	-29.9	-30	6.3
2418.40	14.6	12.6	0	2	-30	-30	6.2
2418.45	15.5	12.6	0.9	2	-29.1	-30	5.9
2418.50	15.1	12.6	0.5	2	-29.5	-30	6.2
2418.55	15.4	12.6	0.8	2	-29.2	-30	5.8
2418.60	15.2	12.6	0.6	2	-29.4	-30	5.6
2418.65	15	12.6	0.4	2	-29.6	-30	4.9
2418.70	15.3	12.6	0.7	2	-29.3	-30	5
2418.75	15.2	12.6	0.6	2	-29.4	-30	5.3
2418.80	15.4	12.6	0.8	2	-29.2	-30	5.7
2418.85	15.6	12.6	1	2	-29	-30	6
2418.90	15.4	12.6	0.8	2	-29.2	-30	6.2
2418.95	15.1	12.6	0.5	2	-29.5	-30	6
2419.00	15.1	12.6	0.5	2	-29.5	-30	6.1
2419.05	15.5	12.6	0.9	2	-29.1	-30	5.8
2419.10	15.3	12.6	0.7	2	-29.3	-30	5.6
2419.15	15.1	12.6	0.5	2	-29.5	-30	5.7
2419.20	15.3	12.6	0.7	2	-29.3	-30	5.2
2419.25	15.2	12.6	0.6	2	-29.4	-30	5.8
2419.30	15.4	12.6	0.8	2	-29.2	-30	6.4
2419.35	15.1	12.6	0.5	2	-29.5	-30	9.9
2419.40	15.6	12.6	1	2	-29	-30	7.4
2419.45	15.8	12.6	1.2	2	-28.8	-30	6.3
2419.50	15.9	12.6	1.3	2	-28.7	-30	5.6

2419.55	16.2	12.6	1.6	2	-28.4	-30	6.4
2419.60	15.9	12.6	1.3	2	-28.7	-30	7.6
2419.65	16.3	12.6	1.7	2	-28.3	-30	6.8
2419.70	16.4	12.6	1.8	2	-28.2	-30	6.6
2419.75	16.6	12.6	2	2	-28	-30	6.2
2419.80	16.4	12.6	1.8	2	-28.2	-30	6.8
2419.85	16.3	12.6	1.7	2	-28.3	-30	6.5
2419.90	16	12.6	1.4	2	-28.6	-30	6.3
2419.95	15.8	12.6	1.2	2	-28.8	-30	6.9
2420.00	16.4	12.6	1.8	2	-28.2	-30	7.3
2420.05	16	12.6	1.4	2	-28.6	-30	6.6
2420.10	16.2	12.6	1.6	2	-28.4	-30	6.8
2420.15	16	12.6	1.4	2	-28.6	-30	5.1
2420.20	16.3	12.6	1.7	2	-28.3	-30	6.3
2420.25	16.2	12.6	1.6	2	-28.4	-30	7.1
2420.30	16.1	12.6	1.5	2	-28.5	-30	6.6
2420.35	16.1	12.6	1.5	2	-28.5	-30	6.1
2420.40	16.4	12.6	1.8	2	-28.2	-30	5.7
2420.45	16.2	12.6	1.6	2	-28.4	-30	6.4
2420.50	16.7	12.6	2.1	2	-27.9	-30	6.2
Processing Gain (dB) @20th Percentile=				12			

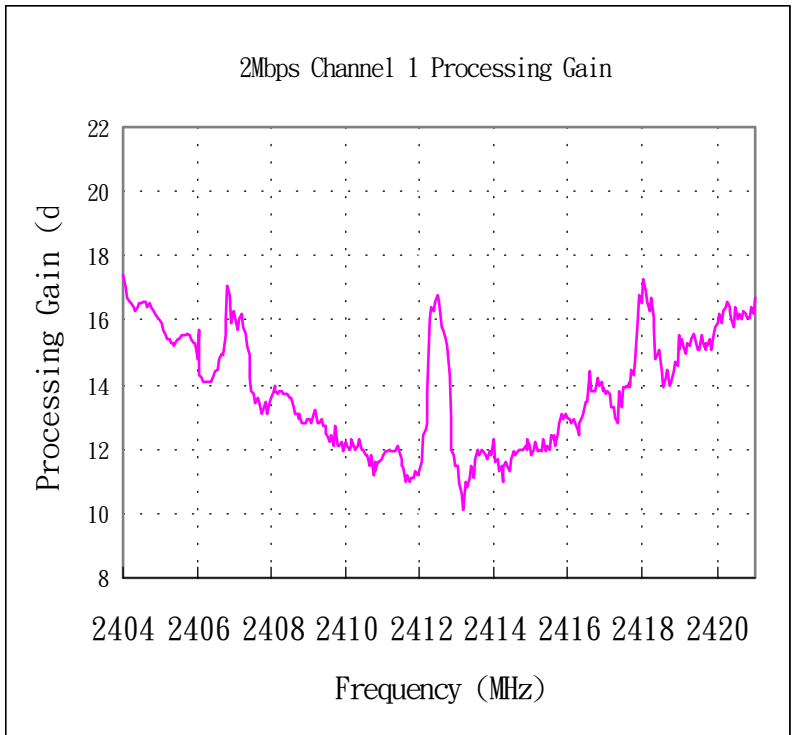

2Mbps Channel 6 Processing Gain							
Gp=(S/N)o+Mj+Lsys							
Freq. (MHz)	Gp (dB)	(S/N)o (dB)	Mj = J/S (dB)	Lsys (dB)	Jammer (dBm)	Lvl (dBm)	FE R
2428.50	18.3	12.6	3.7	2	-28.5	-32.2	7
2428.55	17.5	12.6	2.9	2	-29.3	-32.2	6.8
2428.60	18.6	12.6	4	2	-28.2	-32.2	6.5
2428.65	18.5	12.6	3.9	2	-28.3	-32.2	6.7
2428.70	18.4	12.6	3.8	2	-28.4	-32.2	7.5
2428.75	18.4	12.6	3.8	2	-28.4	-32.2	7.2
2428.80	18.4	12.6	3.8	2	-28.4	-32.2	7.4
2428.85	18.5	12.6	3.9	2	-28.3	-32.2	7.6
2428.90	18.3	12.6	3.7	2	-28.5	-32.2	7.5
2428.95	18.3	12.6	3.7	2	-28.5	-32.2	6.5
2429.00	18.2	12.6	3.6	2	-28.6	-32.2	6.3
2429.05	18.1	12.6	3.5	2	-28.7	-32.2	5.9
2429.10	17.9	12.6	3.3	2	-28.9	-32.2	6.5
2429.15	17.7	12.6	3.1	2	-29.1	-32.2	6
2429.20	17.6	12.6	3	2	-29.2	-32.2	5.7
2429.25	17.5	12.6	2.9	2	-29.3	-32.2	5.8
2429.30	17.4	12.6	2.8	2	-29.4	-32.2	6.8
2429.35	17.33	12.6	2.73	2	-29.47	-32.2	6.2
2429.40	17.3	12.6	2.7	2	-29.5	-32.2	7
2429.45	17.2	12.6	2.6	2	-29.6	-32.2	6.4
2429.50	17	12.6	2.4	2	-29.8	-32.2	7.3
2429.55	16.9	12.6	2.3	2	-29.9	-32.2	5.8
2429.60	16.8	12.6	2.2	2	-30	-32.2	5.1
2429.65	16.7	12.6	2.1	2	-30.1	-32.2	6.3
2429.70	16.6	12.6	2	2	-30.2	-32.2	6.9
2429.75	16.6	12.6	2	2	-30.2	-32.2	7
2429.80	16.5	12.6	1.9	2	-30.3	-32.2	5.4
2429.85	16.5	12.6	1.9	2	-30.3	-32.2	7.1
2429.90	16.6	12.6	2	2	-30.2	-32.2	7.6
2429.95	16.5	12.6	1.9	2	-30.3	-32.2	6.8
2430.00	16.6	12.6	2	2	-30.2	-32.2	6.8
2430.05	16.6	12.6	2	2	-30.2	-32.2	6.2

2430.10	16.6	12.6	2	2	-30.2	-32.2	5.6
2430.15	16.7	12.6	2.1	2	-30.1	-32.2	6.3
2430.20	16.8	12.6	2.2	2	-30	-32.2	6.7
2430.25	16.6	12.6	2	2	-30.2	-32.2	4.8
2430.30	16.6	12.6	2	2	-30.2	-32.2	5.6
2430.35	16.5	12.6	1.9	2	-30.3	-32.2	5.1
2430.40	16.4	12.6	1.8	2	-30.4	-32.2	7
2430.45	16.3	12.6	1.7	2	-30.5	-32.2	5.3
2430.50	16.2	12.6	1.6	2	-30.6	-32.2	6.7
2430.55	15.8	12.6	1.2	2	-31	-32.2	7.3
2430.60	15.6	12.6	1	2	-31.2	-32.2	5.7
2430.65	15.6	12.6	1	2	-31.2	-32.2	6.4
2430.70	15.5	12.6	0.9	2	-31.3	-32.2	5.9
2430.75	15.4	12.6	0.8	2	-31.4	-32.2	5.7
2430.80	15.3	12.6	0.7	2	-31.5	-32.2	5.6
2430.85	15.1	12.6	0.5	2	-31.7	-32.2	5.7
2430.90	15.1	12.6	0.5	2	-31.7	-32.2	5.6
2430.95	15.3	12.6	0.7	2	-31.5	-32.2	6
2431.00	15.6	12.6	1	2	-31.2	-32.2	7.6
2431.05	15.7	12.6	1.1	2	-31.1	-32.2	6.4
2431.10	15.7	12.6	1.1	2	-31.1	-32.2	5.3
2431.15	15.9	12.6	1.3	2	-30.9	-32.2	5.9
2431.20	16.6	12.6	2	2	-30.2	-32.2	6.1
2431.25	16.5	12.6	1.9	2	-30.3	-32.2	6.3
2431.30	16.3	12.6	1.7	2	-30.5	-32.2	5.7
2431.35	16.2	12.6	1.6	2	-30.6	-32.2	6.4
2431.40	16	12.6	1.4	2	-30.8	-32.2	7.2
2431.45	15.8	12.6	1.2	2	-31	-32.2	7.3
2431.50	15.6	12.6	1	2	-31.2	-32.2	6.2
2431.55	15.8	12.6	1.2	2	-31	-32.2	6.3
2431.60	15.8	12.6	1.2	2	-31	-32.2	6.5
2431.65	15.4	12.6	0.8	2	-31.4	-32.2	6.7
2431.70	15.2	12.6	0.6	2	-31.6	-32.2	6.8
2431.75	15.4	12.6	0.8	2	-31.4	-32.2	7.1
2431.80	15.2	12.6	0.6	2	-31.6	-32.2	5.8
2431.85	15	12.6	0.4	2	-31.8	-32.2	5.9

2431.90	14.8	12.6	0.2	2	-32	-32.2	5.6
2431.95	15	12.6	0.4	2	-31.8	-32.2	6.2
2432.00	14.8	12.6	0.2	2	-32	-32.2	6.3
2432.05	14.6	12.6	0	2	-32.2	-32.2	6
2432.10	14.3	12.6	-0.3	2	-32.5	-32.2	7.5
2432.15	14.2	12.6	-0.4	2	-32.6	-32.2	6.8
2432.20	14.1	12.6	-0.5	2	-32.7	-32.2	7.4
2432.25	14.2	12.6	-0.4	2	-32.6	-32.2	7.1
2432.30	14.3	12.6	-0.3	2	-32.5	-32.2	7.7
2432.35	14.4	12.6	-0.2	2	-32.4	-32.2	7.3
2432.40	14.4	12.6	-0.2	2	-32.4	-32.2	6
2432.45	14.6	12.6	0	2	-32.2	-32.2	5.4
2432.50	14.7	12.6	0.1	2	-32.1	-32.2	6.1
2432.55	14.6	12.6	0	2	-32.2	-32.2	7.1
2432.60	14.4	12.6	-0.2	2	-32.4	-32.2	5.7
2432.65	15	12.6	0.4	2	-31.8	-32.2	6.1
2432.70	14.8	12.6	0.2	2	-32	-32.2	5.6
2432.75	14.9	12.6	0.3	2	-31.9	-32.2	6.3
2432.80	14.8	12.6	0.2	2	-32	-32.2	5.7
2432.85	14.8	12.6	0.2	2	-32	-32.2	5.8
2432.90	14.7	12.6	0.1	2	-32.1	-32.2	7.3
2432.95	14.4	12.6	-0.2	2	-32.4	-32.2	5.9
2433.00	14	12.6	-0.6	2	-32.8	-32.2	7.4
2433.05	13.9	12.6	-0.7	2	-32.9	-32.2	6.3
2433.10	13.7	12.6	-0.9	2	-33.1	-32.2	5.7
2433.15	13.5	12.6	-1.1	2	-33.3	-32.2	6.8
2433.20	13.5	12.6	-1.1	2	-33.3	-32.2	6.3
2433.25	13.6	12.6	-1	2	-33.2	-32.2	6.2
2433.30	13.7	12.6	-0.9	2	-33.1	-32.2	5.2
2433.35	13.7	12.6	-0.9	2	-33.1	-32.2	5.8
2433.40	13.8	12.6	-0.8	2	-33	-32.2	4.5
2433.45	13.7	12.6	-0.9	2	-33.1	-32.2	6.2
2433.50	13.8	12.6	-0.8	2	-33	-32.2	5.6
2433.55	13.9	12.6	-0.7	2	-32.9	-32.2	5.7
2433.60	14	12.6	-0.6	2	-32.8	-32.2	5.4
2433.65	13.9	12.6	-0.7	2	-32.9	-32.2	6

2433.70	13.8	12.6	-0.8	2	-33	-32.2	5.6
2433.75	13.7	12.6	-0.9	2	-33.1	-32.2	6.3
2433.80	13.6	12.6	-1	2	-33.2	-32.2	6.3
2433.85	13.5	12.6	-1.1	2	-33.3	-32.2	6.4
2433.90	13.4	12.6	-1.2	2	-33.4	-32.2	5.5
2433.95	13.3	12.6	-1.3	2	-33.5	-32.2	5.8
2434.00	13.2	12.6	-1.4	2	-33.6	-32.2	5.6
2434.05	14.2	12.6	-0.4	2	-32.6	-32.2	5.7
2434.10	13	12.6	-1.6	2	-33.8	-32.2	5.7
2434.15	13	12.6	-1.6	2	-33.8	-32.2	5.9
2434.20	12.8	12.6	-1.8	2	-34	-32.2	5.6
2434.25	14.2	12.6	-0.4	2	-32.6	-32.2	6.1
2434.30	13.9	12.6	-0.7	2	-32.9	-32.2	6.4
2434.35	13.8	12.6	-0.8	2	-33	-32.2	6.3
2434.40	12.8	12.6	-1.8	2	-34	-32.2	5.6
2434.45	13	12.6	-1.6	2	-33.8	-32.2	6.4
2434.50	13	12.6	-1.6	2	-33.8	-32.2	6.6
2434.55	12.9	12.6	-1.7	2	-33.9	-32.2	4.9
2434.60	13	12.6	-1.6	2	-33.8	-32.2	5.7
2434.65	12.9	12.6	-1.7	2	-33.9	-32.2	4.8
2434.70	12.8	12.6	-1.8	2	-34	-32.2	6.2
2434.75	12.9	12.6	-1.7	2	-33.9	-32.2	5.1
2434.80	12.9	12.6	-1.7	2	-33.9	-32.2	6.3
2434.85	12.9	12.6	-1.7	2	-33.9	-32.2	5.8
2434.90	12.8	12.6	-1.8	2	-34	-32.2	6.1
2434.95	12.6	12.6	-2	2	-34.2	-32.2	5.7
2435.00	12.4	12.6	-2.2	2	-34.4	-32.2	6.8
2435.05	12.3	12.6	-2.3	2	-34.5	-32.2	6.1
2435.10	12	12.6	-2.6	2	-34.8	-32.2	6.4
2435.15	11.8	12.6	-2.8	2	-35	-32.2	6.3
2435.20	11.8	12.6	-2.8	2	-35	-32.2	5.6
2435.25	12	12.6	-2.6	2	-34.8	-32.2	6.4
2435.30	12	12.6	-2.6	2	-34.8	-32.2	5.3
2435.35	12.1	12.6	-2.5	2	-34.7	-32.2	5.7
2435.40	12.1	12.6	-2.5	2	-34.7	-32.2	5.7
2435.45	12.3	12.6	-2.3	2	-34.5	-32.2	5.8

2435.50	12.4	12.6	-2.2	2	-34.4	-32.2	7
2435.55	12.6	12.6	-2	2	-34.2	-32.2	6
2435.60	12.7	12.6	-1.9	2	-34.1	-32.2	6.4
2435.65	12.6	12.6	-2	2	-34.2	-32.2	6.3
2435.70	12.6	12.6	-2	2	-34.2	-32.2	6.7
2435.75	12.6	12.6	-2	2	-34.2	-32.2	6.5
2435.80	12.6	12.6	-2	2	-34.2	-32.2	7.3
2435.85	11.7	12.6	-2.9	2	-35.1	-32.2	5.7
2435.90	12.6	12.6	-2	2	-34.2	-32.2	6
2435.95	11.9	12.6	-2.7	2	-34.9	-32.2	7.1
2436.00	12.1	12.6	-2.5	2	-34.7	-32.2	6.7
2436.05	11.8	12.6	-2.8	2	-35	-32.2	7.4
2436.10	11.5	12.6	-3.1	2	-35.3	-32.2	6.9
2436.15	11.4	12.6	-3.2	2	-35.4	-32.2	6.8
2436.20	11.3	12.6	-3.3	2	-35.5	-32.2	5.2
2436.25	11.4	12.6	-3.2	2	-35.4	-32.2	5.6
2436.30	11.4	12.6	-3.2	2	-35.4	-32.2	5.4
2436.35	11.6	12.6	-3	2	-35.2	-32.2	6.1
2436.40	11.6	12.6	-3	2	-35.2	-32.2	5.2
2436.45	12	12.6	-2.6	2	-34.8	-32.2	6.3
2436.50	12.2	12.6	-2.4	2	-34.6	-32.2	5.2
2436.55	13.3	12.6	-1.3	2	-33.5	-32.2	5.7
2436.60	14.9	12.6	0.3	2	-31.9	-32.2	6.8
2436.65	14.8	12.6	0.2	2	-32	-32.2	5.3
2436.70	14.7	12.6	0.1	2	-32.1	-32.2	6.2
2436.75	15.4	12.6	0.8	2	-31.4	-32.2	6.1
2436.80	15.7	12.6	1.1	2	-31.1	-32.2	3.2
2436.85	16.6	12.6	2	2	-30.2	-32.2	4.2
2436.90	17.3	12.6	2.7	2	-29.5	-32.2	4.8
2436.95	17.5	12.6	2.9	2	-29.3	-32.2	5.5
2437.00	17.6	12.6	3	2	-29.2	-32.2	7.4
2437.05	17.5	12.6	2.9	2	-29.3	-32.2	5.2
2437.10	17.1	12.6	2.5	2	-29.7	-32.2	5.4
2437.15	16.9	12.6	2.3	2	-29.9	-32.2	5.3
2437.20	15.5	12.6	0.9	2	-31.3	-32.2	5.3
2437.25	15.2	12.6	0.6	2	-31.6	-32.2	6.2

2437.30	14.1	12.6	-0.5	2	-32.7	-32.2	5.2
2437.35	12.3	12.6	-2.3	2	-34.5	-32.2	6.7
2437.40	12.8	12.6	-1.8	2	-34	-32.2	4.8
2437.45	12.4	12.6	-2.2	2	-34.4	-32.2	6.8
2437.50	12	12.6	-2.6	2	-34.8	-32.2	6.1
2437.55	11.8	12.6	-2.8	2	-35	-32.2	7.1
2437.60	11.5	12.6	-3.1	2	-35.3	-32.2	6.3
2437.65	11.3	12.6	-3.3	2	-35.5	-32.2	7.3
2437.70	11.1	12.6	-3.5	2	-35.7	-32.2	6.6
2437.75	11.6	12.6	-3	2	-35.2	-32.2	5.8
2437.80	11.3	12.6	-3.3	2	-35.5	-32.2	5.4
2437.85	11.5	12.6	-3.1	2	-35.3	-32.2	5.4
2437.90	11.7	12.6	-2.9	2	-35.1	-32.2	6.3
2437.95	11.8	12.6	-2.8	2	-35	-32.2	5.3
2438.00	12	12.6	-2.6	2	-34.8	-32.2	5.2
2438.05	11.9	12.6	-2.7	2	-34.9	-32.2	6.6
2438.10	12.1	12.6	-2.5	2	-34.7	-32.2	5.7
2438.15	11.8	12.6	-2.8	2	-35	-32.2	6
2438.20	12.5	12.6	-2.1	2	-34.3	-32.2	6
2438.25	12.6	12.6	-2	2	-34.2	-32.2	7.1
2438.30	12.7	12.6	-1.9	2	-34.1	-32.2	6.2
2438.35	12.6	12.6	-2	2	-34.2	-32.2	5.9
2438.40	12.4	12.6	-2.2	2	-34.4	-32.2	5.3
2438.45	12.3	12.6	-2.3	2	-34.5	-32.2	6.1
2438.50	11.8	12.6	-2.8	2	-35	-32.2	6.5
2438.55	12	12.6	-2.6	2	-34.8	-32.2	6.3
2438.60	11.8	12.6	-2.8	2	-35	-32.2	7
2438.65	11.7	12.6	-2.9	2	-35.1	-32.2	4.8
2438.70	11.2	12.6	-3.4	2	-35.6	-32.2	5.4
2438.75	11.5	12.6	-3.1	2	-35.3	-32.2	5.7
2438.80	11.9	12.6	-2.7	2	-34.9	-32.2	6.9
2438.85	12.1	12.6	-2.5	2	-34.7	-32.2	7
2438.90	12.2	12.6	-2.4	2	-34.6	-32.2	7
2438.95	12.3	12.6	-2.3	2	-34.5	-32.2	5.8
2439.00	12.4	12.6	-2.2	2	-34.4	-32.2	7.3
2439.05	12.4	12.6	-2.2	2	-34.4	-32.2	5.3

2439.10	12.5	12.6	-2.1	2	-34.3	-32.2	4.9
2439.15	12.6	12.6	-2	2	-34.2	-32.2	5.3
2439.20	12.6	12.6	-2	2	-34.2	-32.2	5.1
2439.25	12.8	12.6	-1.8	2	-34	-32.2	5.6
2439.30	12.7	12.6	-1.9	2	-34.1	-32.2	6.8
2439.35	12.8	12.6	-1.8	2	-34	-32.2	5.3
2439.40	12.7	12.6	-1.9	2	-34.1	-32.2	7.4
2439.45	12.7	12.6	-1.9	2	-34.1	-32.2	7.9
2439.50	12.6	12.6	-2	2	-34.2	-32.2	6.6
2439.55	12.6	12.6	-2	2	-34.2	-32.2	6.3
2439.60	12.5	12.6	-2.1	2	-34.3	-32.2	5.7
2439.65	12.5	12.6	-2.1	2	-34.3	-32.2	5.7
2439.70	12.4	12.6	-2.2	2	-34.4	-32.2	7.2
2439.75	12.4	12.6	-2.2	2	-34.4	-32.2	7.3
2439.80	12.5	12.6	-2.1	2	-34.3	-32.2	7
2439.85	12.8	12.6	-1.8	2	-34	-32.2	6.8
2439.90	12.8	12.6	-1.8	2	-34	-32.2	6.6
2439.95	12.9	12.6	-1.7	2	-33.9	-32.2	6.2
2440.00	12.8	12.6	-1.8	2	-34	-32.2	5.6
2440.05	12.9	12.6	-1.7	2	-33.9	-32.2	5.8
2440.10	12.8	12.6	-1.8	2	-34	-32.2	6.7
2440.15	13.5	12.6	-1.1	2	-33.3	-32.2	6.3
2440.20	13.3	12.6	-1.3	2	-33.5	-32.2	6.3
2440.25	13.4	12.6	-1.2	2	-33.4	-32.2	5.9
2440.30	13.6	12.6	-1	2	-33.2	-32.2	5.4
2440.35	13.5	12.6	-1.1	2	-33.3	-32.2	5.3
2440.40	13.4	12.6	-1.2	2	-33.4	-32.2	7.3
2440.45	13.5	12.6	-1.1	2	-33.3	-32.2	5.7
2440.50	13.6	12.6	-1	2	-33.2	-32.2	5.9
2440.55	13.5	12.6	-1.1	2	-33.3	-32.2	6.1
2440.60	13.4	12.6	-1.2	2	-33.4	-32.2	6.3
2440.65	13.4	12.6	-1.2	2	-33.4	-32.2	5.8
2440.70	13.4	12.6	-1.2	2	-33.4	-32.2	5.4
2440.75	13.6	12.6	-1	2	-33.2	-32.2	5.6
2440.80	13.6	12.6	-1	2	-33.2	-32.2	5
2440.85	13.7	12.6	-0.9	2	-33.1	-32.2	7.3

2440.90	13.7	12.6	-0.9	2	-33.1	-32.2	6.3
2440.95	14.1	12.6	-0.5	2	-32.7	-32.2	5.8
2441.00	14.1	12.6	-0.5	2	-32.7	-32.2	7.2
2441.05	14.3	12.6	-0.3	2	-32.5	-32.2	5.9
2441.10	14.3	12.6	-0.3	2	-32.5	-32.2	6
2441.15	14.8	12.6	0.2	2	-32	-32.2	5.8
2441.20	14.7	12.6	0.1	2	-32.1	-32.2	6.2
2441.25	14.6	12.6	0	2	-32.2	-32.2	6.1
2441.30	14.5	12.6	-0.1	2	-32.3	-32.2	5.2
2441.35	14.7	12.6	0.1	2	-32.1	-32.2	5.3
2441.40	14.8	12.6	0.2	2	-32	-32.2	7.3
2441.45	14.8	12.6	0.2	2	-32	-32.2	7.1
2441.50	14.8	12.6	0.2	2	-32	-32.2	6.6
2441.55	14.6	12.6	0	2	-32.2	-32.2	6.8
2441.60	14.3	12.6	-0.3	2	-32.5	-32.2	6.7
2441.65	14.3	12.6	-0.3	2	-32.5	-32.2	4.9
2441.70	14	12.6	-0.6	2	-32.8	-32.2	6.3
2441.75	13.9	12.6	-0.7	2	-32.9	-32.2	5.1
2441.80	13.8	12.6	-0.8	2	-33	-32.2	6.4
2441.85	13.9	12.6	-0.7	2	-32.9	-32.2	5.3
2441.90	14	12.6	-0.6	2	-32.8	-32.2	5.8
2441.95	14.7	12.6	0.1	2	-32.1	-32.2	5.7
2442.00	14.4	12.6	-0.2	2	-32.4	-32.2	5.3
2442.05	14.8	12.6	0.2	2	-32	-32.2	5.1
2442.10	14.8	12.6	0.2	2	-32	-32.2	6.1
2442.15	15.2	12.6	0.6	2	-31.6	-32.2	5.8
2442.20	15.7	12.6	1.1	2	-31.1	-32.2	4.9
2442.25	16	12.6	1.4	2	-30.8	-32.2	5.7
2442.30	16.6	12.6	2	2	-30.2	-32.2	5.8
2442.35	16.4	12.6	1.8	2	-30.4	-32.2	5.9
2442.40	16.52	12.6	1.92	2	-30.28	-32.2	6.1
2442.45	16.8	12.6	2.2	2	-30	-32.2	7.1
2442.50	17.2	12.6	2.6	2	-29.6	-32.2	4.8
2442.55	17.1	12.6	2.5	2	-29.7	-32.2	7.3
2442.60	17.4	12.6	2.8	2	-29.4	-32.2	4.7
2442.65	17	12.6	2.4	2	-29.8	-32.2	7.4

2442.70	17.1	12.6	2.5	2	-29.7	-32.2	5.2
2442.75	17.5	12.6	2.9	2	-29.3	-32.2	5.6
2442.80	16.7	12.6	2.1	2	-30.1	-32.2	4.8
2442.85	16.7	12.6	2.1	2	-30.1	-32.2	6.3
2442.90	15	12.6	0.4	2	-31.8	-32.2	6.4
2442.95	14.8	12.6	0.2	2	-32	-32.2	6.3
2443.00	14.7	12.6	0.1	2	-32.1	-32.2	4.9
2443.05	14.6	12.6	0	2	-32.2	-32.2	5.7
2443.10	14.7	12.6	0.1	2	-32.1	-32.2	5.7
2443.15	14.6	12.6	0	2	-32.2	-32.2	6.1
2443.20	14.4	12.6	-0.2	2	-32.4	-32.2	6.8
2443.25	14.7	12.6	0.1	2	-32.1	-32.2	6.3
2443.30	14.8	12.6	0.2	2	-32	-32.2	6.9
2443.35	14.9	12.6	0.3	2	-31.9	-32.2	5.7
2443.40	15	12.6	0.4	2	-31.8	-32.2	5.6
2443.45	15.2	12.6	0.6	2	-31.6	-32.2	6.2
2443.50	15.4	12.6	0.8	2	-31.4	-32.2	6.1
2443.55	15.8	12.6	1.2	2	-31	-32.2	6.3
2443.60	16	12.6	1.4	2	-30.8	-32.2	5.8
2443.65	16	12.6	1.4	2	-30.8	-32.2	7.1
2443.70	15.9	12.6	1.3	2	-30.9	-32.2	4.8
2443.75	16.1	12.6	1.5	2	-30.7	-32.2	6.8
2443.80	16.2	12.6	1.6	2	-30.6	-32.2	6.6
2443.85	16.1	12.6	1.5	2	-30.7	-32.2	6.3
2443.90	15.8	12.6	1.2	2	-31	-32.2	5.1
2443.95	15.8	12.6	1.2	2	-31	-32.2	5.7
2444.00	15.5	12.6	0.9	2	-31.3	-32.2	4.8
2444.05	15.7	12.6	1.1	2	-31.1	-32.2	6.5
2444.10	15.7	12.6	1.1	2	-31.1	-32.2	5.3
2444.15	15.7	12.6	1.1	2	-31.1	-32.2	5.8
2444.20	15.6	12.6	1	2	-31.2	-32.2	5.7
2444.25	15.4	12.6	0.8	2	-31.4	-32.2	6.2
2444.30	15.7	12.6	1.1	2	-31.1	-32.2	6.1
2444.35	15.6	12.6	1	2	-31.2	-32.2	6.3
2444.40	15.9	12.6	1.3	2	-30.9	-32.2	5.8
2444.45	16	12.6	1.4	2	-30.8	-32.2	6.5

2444.50	16.1	12.6	1.5	2	-30.7	-32.2	6.2
2444.55	16.3	12.6	1.7	2	-30.5	-32.2	5.8
2444.60	16.4	12.6	1.8	2	-30.4	-32.2	5.8
2444.65	16.7	12.6	2.1	2	-30.1	-32.2	5.9
2444.70	16.8	12.6	2.2	2	-30	-32.2	6.1
2444.75	16.9	12.6	2.3	2	-29.9	-32.2	7.2
2444.80	17	12.6	2.4	2	-29.8	-32.2	7.5
2444.85	16.9	12.6	2.3	2	-29.9	-32.2	7.3
2444.90	16.7	12.6	2.1	2	-30.1	-32.2	4.9
2444.95	16.7	12.6	2.1	2	-30.1	-32.2	5.9
2445.00	16.7	12.6	2.1	2	-30.1	-32.2	6.7
2445.05	16.9	12.6	2.3	2	-29.9	-32.2	6.3
2445.10	17	12.6	2.4	2	-29.8	-32.2	5.9
2445.15	16.8	12.6	2.2	2	-30	-32.2	5.8
2445.20	17	12.6	2.4	2	-29.8	-32.2	7.2
2445.25	16.8	12.6	2.2	2	-30	-32.2	6.2
2445.30	17	12.6	2.4	2	-29.8	-32.2	7.1
2445.35	16.8	12.6	2.2	2	-30	-32.2	6.3
2445.40	17.2	12.6	2.6	2	-29.6	-32.2	6.2
2445.45	17.1	12.6	2.5	2	-29.7	-32.2	5.8
2445.50	17.3	12.6	2.7	2	-29.5	-32.2	6.7
Processing Gain (dB) @20th Percentile=				12.6			

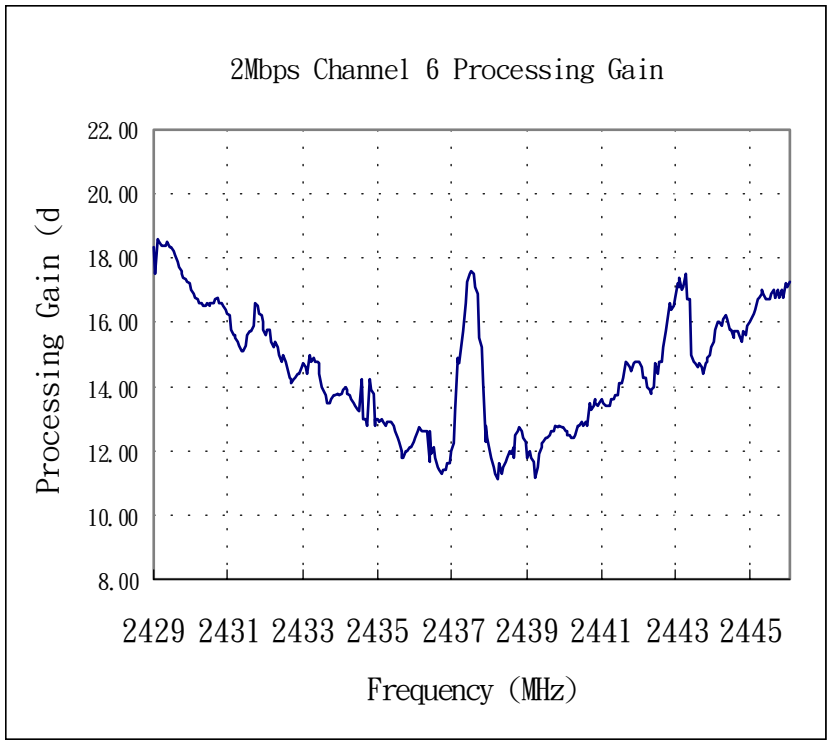

2Mbps Channel 11 Processing Gain							
Gp=(S/N)o+Mj+Lsys							
Freq. (MHz)	Gp (dB)	(S/N)o (dB)	Mj = J/S (dB)	Lsys (dB)	Jammer (dBm)	Lvl (dBm)	FE R
2453.50	15.2	12.6	0.6	2	-31.4	-32	6.8
2453.55	16.9	12.6	2.3	2	-29.7	-32	6.7
2453.60	16.9	12.6	2.3	2	-29.7	-32	7.3
2453.65	16.6	12.6	2	2	-30	-32	6.8
2453.70	16.7	12.6	2.1	2	-29.9	-32	7.1
2453.75	16.6	12.6	2	2	-30	-32	6.5
2453.80	16.8	12.6	2.2	2	-29.8	-32	7.3
2453.85	16.9	12.6	2.3	2	-29.7	-32	5.7
2453.90	16.9	12.6	2.3	2	-29.7	-32	7.4
2453.95	17	12.6	2.4	2	-29.6	-32	6.1
2454.00	16.6	12.6	2	2	-30	-32	6.3
2454.05	15.9	12.6	1.3	2	-30.7	-32	6.5
2454.10	16.2	12.6	1.6	2	-30.4	-32	5.8
2454.15	15.9	12.6	1.3	2	-30.7	-32	7.1
2454.20	15.7	12.6	1.1	2	-30.9	-32	6.1
2454.25	15.8	12.6	1.2	2	-30.8	-32	6.3
2454.30	15.8	12.6	1.2	2	-30.8	-32	5.8
2454.35	15.7	12.6	1.1	2	-30.9	-32	7.2
2454.40	15.7	12.6	1.1	2	-30.9	-32	7.3
2454.45	15.6	12.6	1	2	-31	-32	5.9
2454.50	15.5	12.6	0.9	2	-31.1	-32	4.8
2454.55	15.6	12.6	1	2	-31	-32	7.1
2454.60	15.6	12.6	1	2	-31	-32	7.3
2454.65	15.6	12.6	1	2	-31	-32	5.7
2454.70	15.4	12.6	0.8	2	-31.2	-32	5.8
2454.75	15.3	12.6	0.7	2	-31.3	-32	5.2
2454.80	15.2	12.6	0.6	2	-31.4	-32	6.1
2454.85	15.2	12.6	0.6	2	-31.4	-32	6.3
2454.90	15.1	12.6	0.5	2	-31.5	-32	6.4
2454.95	15	12.6	0.4	2	-31.6	-32	7.1
2455.00	15.1	12.6	0.5	2	-31.5	-32	5.8
2455.05	15	12.6	0.4	2	-31.6	-32	6.3

2455.10	15.1	12.6	0.5	2	-31.5	-32	6.5
2455.15	15.1	12.6	0.5	2	-31.5	-32	7.3
2455.20	15.1	12.6	0.5	2	-31.5	-32	5.9
2455.25	15	12.6	0.4	2	-31.6	-32	5.8
2455.30	15	12.6	0.4	2	-31.6	-32	6.3
2455.35	14.9	12.6	0.3	2	-31.7	-32	6.4
2455.40	14.8	12.6	0.2	2	-31.8	-32	6.6
2455.45	14.7	12.6	0.1	2	-31.9	-32	6.3
2455.50	14.6	12.6	0	2	-32	-32	7.3
2455.55	14.5	12.6	-0.1	2	-32.1	-32	7.3
2455.60	14.4	12.6	-0.2	2	-32.2	-32	7.8
2455.65	14.2	12.6	-0.4	2	-32.4	-32	5.1
2455.70	14	12.6	-0.6	2	-32.6	-32	7.3
2455.75	13.9	12.6	-0.7	2	-32.7	-32	5.8
2455.80	13.8	12.6	-0.8	2	-32.8	-32	7.3
2455.85	13.2	12.6	-1.4	2	-33.4	-32	7.1
2455.90	14	12.6	-0.6	2	-32.6	-32	6.3
2455.95	14.1	12.6	-0.5	2	-32.5	-32	6.5
2456.00	14.1	12.6	-0.5	2	-32.5	-32	6.7
2456.05	14.3	12.6	-0.3	2	-32.3	-32	7.3
2456.10	14.5	12.6	-0.1	2	-32.1	-32	5.8
2456.15	15	12.6	0.4	2	-31.6	-32	5.9
2456.20	15.6	12.6	1	2	-31	-32	6.1
2456.25	15.8	12.6	1.2	2	-30.8	-32	6.3
2456.30	16.2	12.6	1.6	2	-30.4	-32	6.5
2456.35	16.1	12.6	1.5	2	-30.5	-32	7
2456.40	15.8	12.6	1.2	2	-30.8	-32	7.3
2456.45	15.6	12.6	1	2	-31	-32	5.8
2456.50	15.4	12.6	0.8	2	-31.2	-32	5.9
2456.55	15.2	12.6	0.6	2	-31.4	-32	6.1
2456.60	15.1	12.6	0.5	2	-31.5	-32	5.3
2456.65	15	12.6	0.4	2	-31.6	-32	6
2456.70	15.1	12.6	0.5	2	-31.5	-32	5.3
2456.75	15	12.6	0.4	2	-31.6	-32	4.7
2456.80	14.7	12.6	0.1	2	-31.9	-32	4.9
2456.85	14.5	12.6	-0.1	2	-32.1	-32	7.3

2456.90	14.3	12.6	-0.3	2	-32.3	-32	7.8
2456.95	14.1	12.6	-0.5	2	-32.5	-32	7.2
2457.00	13.5	12.6	-1.1	2	-33.1	-32	6.3
2457.05	13.4	12.6	-1.2	2	-33.2	-32	7.1
2457.10	13.1	12.6	-1.5	2	-33.5	-32	7.3
2457.15	13.3	12.6	-1.3	2	-33.3	-32	5.1
2457.20	12.7	12.6	-1.9	2	-33.9	-32	7.1
2457.25	12.5	12.6	-2.1	2	-34.1	-32	5.9
2457.30	12.8	12.6	-1.8	2	-33.8	-32	6.1
2457.35	13	12.6	-1.6	2	-33.6	-32	6.5
2457.40	13.1	12.6	-1.5	2	-33.5	-32	6
2457.45	13.3	12.6	-1.3	2	-33.3	-32	7.1
2457.50	13.4	12.6	-1.2	2	-33.2	-32	9.1
2457.55	13.1	12.6	-1.5	2	-33.5	-32	9.5
2457.60	12.9	12.6	-1.7	2	-33.7	-32	7.3
2457.65	12.9	12.6	-1.7	2	-33.7	-32	5.7
2457.70	12.9	12.6	-1.7	2	-33.7	-32	7.2
2457.75	14.6	12.6	0	2	-32	-32	7.3
2457.80	13.9	12.6	-0.7	2	-32.7	-32	4.8
2457.85	13.8	12.6	-0.8	2	-32.8	-32	5.3
2457.90	14.4	12.6	-0.2	2	-32.2	-32	5.7
2457.95	14.5	12.6	-0.1	2	-32.1	-32	6.3
2458.00	13.5	12.6	-1.1	2	-33.1	-32	6.1
2458.05	13.4	12.6	-1.2	2	-33.2	-32	6.4
2458.10	13.2	12.6	-1.4	2	-33.4	-32	6.5
2458.15	13	12.6	-1.6	2	-33.6	-32	7.1
2458.20	12.8	12.6	-1.8	2	-33.8	-32	7.2
2458.25	12.9	12.6	-1.7	2	-33.7	-32	5.8
2458.30	13	12.6	-1.6	2	-33.6	-32	6
2458.35	13.1	12.6	-1.5	2	-33.5	-32	6.3
2458.40	13.2	12.6	-1.4	2	-33.4	-32	6.2
2458.45	13.3	12.6	-1.3	2	-33.3	-32	5.9
2458.50	13.5	12.6	-1.1	2	-33.1	-32	5.8
2458.55	13.8	12.6	-0.8	2	-32.8	-32	6.1
2458.60	14	12.6	-0.6	2	-32.6	-32	5.1
2458.65	13.9	12.6	-0.7	2	-32.7	-32	5.7

2458.70	13.9	12.6	-0.7	2	-32.7	-32	5.6
2458.75	13.4	12.6	-1.2	2	-33.2	-32	5.7
2458.80	13.8	12.6	-0.8	2	-32.8	-32	6.3
2458.85	13.7	12.6	-0.9	2	-32.9	-32	6.4
2458.90	13.6	12.6	-1	2	-33	-32	6.5
2458.95	13.5	12.6	-1.1	2	-33.1	-32	6.9
2459.00	12.7	12.6	-1.9	2	-33.9	-32	6.1
2459.05	12.4	12.6	-2.2	2	-34.2	-32	5.8
2459.10	12.3	12.6	-2.3	2	-34.3	-32	5.1
2459.15	11.8	12.6	-2.8	2	-34.8	-32	5.3
2459.20	12	12.6	-2.6	2	-34.6	-32	5.7
2459.25	12	12.6	-2.6	2	-34.6	-32	6.1
2459.30	11.9	12.6	-2.7	2	-34.7	-32	6.3
2459.35	12	12.6	-2.6	2	-34.6	-32	6.4
2459.40	11.9	12.6	-2.7	2	-34.7	-32	7.4
2459.45	11.9	12.6	-2.7	2	-34.7	-32	4.8
2459.50	12	12.6	-2.6	2	-34.6	-32	5.9
2459.55	12.1	12.6	-2.5	2	-34.5	-32	5.7
2459.60	12.2	12.6	-2.4	2	-34.4	-32	5.9
2459.65	12.1	12.6	-2.5	2	-34.5	-32	6.6
2459.70	12	12.6	-2.6	2	-34.6	-32	6.1
2459.75	12	12.6	-2.6	2	-34.6	-32	4.8
2459.80	12	12.6	-2.6	2	-34.6	-32	4.9
2459.85	12.2	12.6	-2.4	2	-34.4	-32	5.3
2459.90	12	12.6	-2.6	2	-34.6	-32	7.3
2459.95	12.2	12.6	-2.4	2	-34.4	-32	7.5
2460.00	11.6	12.6	-3	2	-35	-32	6.8
2460.05	11.4	12.6	-3.2	2	-35.2	-32	6.1
2460.10	11.3	12.6	-3.3	2	-35.3	-32	6.3
2460.15	11.2	12.6	-3.4	2	-35.4	-32	6.1
2460.20	11	12.6	-3.6	2	-35.6	-32	6.3
2460.25	11.1	12.6	-3.5	2	-35.5	-32	6.4
2460.30	11	12.6	-3.6	2	-35.6	-32	6.5
2460.35	11.1	12.6	-3.5	2	-35.5	-32	6.7
2460.40	11.2	12.6	-3.4	2	-35.4	-32	6.6
2460.45	11.1	12.6	-3.5	2	-35.5	-32	6.3

2460.50	11.5	12.6	-3.1	2	-35.1	-32	6.5
2460.55	11.6	12.6	-3	2	-35	-32	7.1
2460.60	11.7	12.6	-2.9	2	-34.9	-32	7.3
2460.65	11.6	12.6	-3	2	-35	-32	7.4
2460.70	11.7	12.6	-2.9	2	-34.9	-32	5.8
2460.75	11.8	12.6	-2.8	2	-34.8	-32	5.9
2460.80	11.8	12.6	-2.8	2	-34.8	-32	7
2460.85	11.8	12.6	-2.8	2	-34.8	-32	7.1
2460.90	11.7	12.6	-2.9	2	-34.9	-32	6.2
2460.95	11.5	12.6	-3.1	2	-35.1	-32	6.8
2461.00	11.1	12.6	-3.5	2	-35.5	-32	6.6
2461.05	10.9	12.6	-3.7	2	-35.7	-32	6.4
2461.10	10.7	12.6	-3.9	2	-35.9	-32	5.8
2461.15	10.4	12.6	-4.2	2	-36.2	-32	5.9
2461.20	10.3	12.6	-4.3	2	-36.3	-32	6.1
2461.25	10.3	12.6	-4.3	2	-36.3	-32	6.2
2461.30	10.4	12.6	-4.2	2	-36.2	-32	5.8
2461.35	10.6	12.6	-4	2	-36	-32	6.3
2461.40	10.8	12.6	-3.8	2	-35.8	-32	5.7
2461.45	11	12.6	-3.6	2	-35.6	-32	7.3
2461.50	11.6	12.6	-3	2	-35	-32	7.5
2461.55	11.8	12.6	-2.8	2	-34.8	-32	5.8
2461.60	12.5	12.6	-2.1	2	-34.1	-32	6.1
2461.65	13	12.6	-1.6	2	-33.6	-32	6.3
2461.70	14.2	12.6	-0.4	2	-32.4	-32	5.8
2461.75	14.6	12.6	0	2	-32	-32	7.1
2461.80	15.6	12.6	1	2	-31	-32	7.3
2461.85	16.2	12.6	1.6	2	-30.4	-32	6.5
2461.90	16.7	12.6	2.1	2	-29.9	-32	6.7
2461.95	17.3	12.6	2.7	2	-29.3	-32	6.3
2462.00	17.5	12.6	2.9	2	-29.1	-32	7.1
2462.05	16.8	12.6	2.2	2	-29.8	-32	7.4
2462.10	16.6	12.6	2	2	-30	-32	5.8
2462.15	15.6	12.6	1	2	-31	-32	7
2462.20	15	12.6	0.4	2	-31.6	-32	7.3
2462.25	14.7	12.6	0.1	2	-31.9	-32	4.9

2462.30	13.5	12.6	-1.1	2	-33.1	-32	5.7
2462.35	13.2	12.6	-1.4	2	-33.4	-32	6.1
2462.40	12.2	12.6	-2.4	2	-34.4	-32	6.2
2462.45	11.8	12.6	-2.8	2	-34.8	-32	6.8
2462.50	11.3	12.6	-3.3	2	-35.3	-32	6.3
2462.55	10.9	12.6	-3.7	2	-35.7	-32	6.4
2462.60	10.7	12.6	-3.9	2	-35.9	-32	6.5
2462.65	10.5	12.6	-4.1	2	-36.1	-32	6.6
2462.70	10.4	12.6	-4.2	2	-36.2	-32	6.7
2462.75	10.5	12.6	-4.1	2	-36.1	-32	7.2
2462.80	10.6	12.6	-4	2	-36	-32	7.4
2462.85	10.9	12.6	-3.7	2	-35.7	-32	5.8
2462.90	11	12.6	-3.6	2	-35.6	-32	6.3
2462.95	11.2	12.6	-3.4	2	-35.4	-32	6.5
2463.00	11.5	12.6	-3.1	2	-35.1	-32	7.3
2463.05	11.6	12.6	-3	2	-35	-32	5.8
2463.10	11.7	12.6	-2.9	2	-34.9	-32	6.3
2463.15	11.8	12.6	-2.8	2	-34.8	-32	5.7
2463.20	11.9	12.6	-2.7	2	-34.7	-32	5.4
2463.25	11.8	12.6	-2.8	2	-34.8	-32	5.3
2463.30	11.9	12.6	-2.7	2	-34.7	-32	6.2
2463.35	11.9	12.6	-2.7	2	-34.7	-32	6.3
2463.40	11.9	12.6	-2.7	2	-34.7	-32	6.1
2463.45	11.6	12.6	-3	2	-35	-32	5.9
2463.50	11.5	12.6	-3.1	2	-35.1	-32	6.2
2463.55	11.3	12.6	-3.3	2	-35.3	-32	6.7
2463.60	11.2	12.6	-3.4	2	-35.4	-32	6.3
2463.65	11.1	12.6	-3.5	2	-35.5	-32	5.7
2463.70	11	12.6	-3.6	2	-35.6	-32	7.8
2463.75	10.9	12.6	-3.7	2	-35.7	-32	6.3
2463.80	11	12.6	-3.6	2	-35.6	-32	6.5
2463.85	11.2	12.6	-3.4	2	-35.4	-32	6.3
2463.90	11.5	12.6	-3.1	2	-35.1	-32	6
2463.95	11.6	12.6	-3	2	-35	-32	5.3
2464.00	11.8	12.6	-2.8	2	-34.8	-32	6.3
2464.05	11.8	12.6	-2.8	2	-34.8	-32	6.5

2464.10	11.9	12.6	-2.7	2	-34.7	-32	5.7
2464.15	12	12.6	-2.6	2	-34.6	-32	6
2464.20	11.9	12.6	-2.7	2	-34.7	-32	6.3
2464.25	12	12.6	-2.6	2	-34.6	-32	6.1
2464.30	12.1	12.6	-2.5	2	-34.5	-32	5.7
2464.35	12	12.6	-2.6	2	-34.6	-32	5.6
2464.40	12.1	12.6	-2.5	2	-34.5	-32	0.2
2464.45	12	12.6	-2.6	2	-34.6	-32	5.8
2464.50	11.9	12.6	-2.7	2	-34.7	-32	4.9
2464.55	12	12.6	-2.6	2	-34.6	-32	5.3
2464.60	11.9	12.6	-2.7	2	-34.7	-32	5.3
2464.65	11.8	12.6	-2.8	2	-34.8	-32	5.7
2464.70	11.7	12.6	-2.9	2	-34.9	-32	6.3
2464.75	11.2	12.6	-3.4	2	-35.4	-32	6.5
2464.80	12	12.6	-2.6	2	-34.6	-32	6.6
2464.85	12.2	12.6	-2.4	2	-34.4	-32	6.3
2464.90	12.3	12.6	-2.3	2	-34.3	-32	5.7
2464.95	12.4	12.6	-2.2	2	-34.2	-32	7.3
2465.00	12.5	12.6	-2.1	2	-34.1	-32	7.5
2465.05	12.6	12.6	-2	2	-34	-32	4.8
2465.10	12.6	12.6	-2	2	-34	-32	5.7
2465.15	12.5	12.6	-2.1	2	-34.1	-32	5.8
2465.20	12.6	12.6	-2	2	-34	-32	5.6
2465.25	12.7	12.6	-1.9	2	-33.9	-32	5.7
2465.30	12.8	12.6	-1.8	2	-33.8	-32	6.2
2465.35	12.2	12.6	-2.4	2	-34.4	-32	6.3
2465.40	13	12.6	-1.6	2	-33.6	-32	6.5
2465.45	12.9	12.6	-1.7	2	-33.7	-32	6.7
2465.50	13	12.6	-1.6	2	-33.6	-32	6.3
2465.55	13.2	12.6	-1.4	2	-33.4	-32	5.7
2465.60	13	12.6	-1.6	2	-33.6	-32	7.1
2465.65	12.9	12.6	-1.7	2	-33.7	-32	7.3
2465.70	12.7	12.6	-1.9	2	-33.9	-32	7.1
2465.75	12.5	12.6	-2.1	2	-34.1	-32	7.3
2465.80	12.6	12.6	-2	2	-34	-32	7.8
2465.85	12.8	12.6	-1.8	2	-33.8	-32	6.8

2465.90	13	12.6	-1.6	2	-33.6	-32	7.1
2465.95	13.2	12.6	-1.4	2	-33.4	-32	5.7
2466.00	13.4	12.6	-1.2	2	-33.2	-32	7.3
2466.05	13.5	12.6	-1.1	2	-33.1	-32	6.3
2466.10	13.6	12.6	-1	2	-33	-32	7.1
2466.15	13.5	12.6	-1.1	2	-33.1	-32	6.5
2466.20	13.6	12.6	-1	2	-33	-32	7.5
2466.25	13.9	12.6	-0.7	2	-32.7	-32	6.5
2466.30	14	12.6	-0.6	2	-32.6	-32	7.7
2466.35	13.9	12.6	-0.7	2	-32.7	-32	7.3
2466.40	14	12.6	-0.6	2	-32.6	-32	7.8
2466.45	13.9	12.6	-0.7	2	-32.7	-32	6.8
2466.50	13.8	12.6	-0.8	2	-32.8	-32	7.3
2466.55	13.6	12.6	-1	2	-33	-32	5.8
2466.60	13.5	12.6	-1.1	2	-33.1	-32	6.8
2466.65	13.2	12.6	-1.4	2	-33.4	-32	6.7
2466.70	13.1	12.6	-1.5	2	-33.5	-32	7.3
2466.75	13.2	12.6	-1.4	2	-33.4	-32	6.7
2466.80	13.1	12.6	-1.5	2	-33.5	-32	7.7
2466.85	13	12.6	-1.6	2	-33.6	-32	6.8
2466.90	13.2	12.6	-1.4	2	-33.4	-32	7.1
2466.95	13.6	12.6	-1	2	-33	-32	6.3
2467.00	13.9	12.6	-0.7	2	-32.7	-32	7.8
2467.05	14	12.6	-0.6	2	-32.6	-32	5.7
2467.10	14.1	12.6	-0.5	2	-32.5	-32	7.3
2467.15	14.4	12.6	-0.2	2	-32.2	-32	7.1
2467.20	15.6	12.6	1	2	-31	-32	7.5
2467.25	15.5	12.6	0.9	2	-31.1	-32	6.8
2467.30	16.5	12.6	1.9	2	-30.1	-32	7.1
2467.35	16.4	12.6	1.8	2	-30.2	-32	6.9
2467.40	16.2	12.6	1.6	2	-30.4	-32	7.1
2467.45	16	12.6	1.4	2	-30.6	-32	6.8
2467.50	15.9	12.6	1.3	2	-30.7	-32	5.7
2467.55	15.8	12.6	1.2	2	-30.8	-32	6.2
2467.60	15.6	12.6	1	2	-31	-32	6.5
2467.65	15.7	12.6	1.1	2	-30.9	-32	6.7

2467.70	15.8	12.6	1.2	2	-30.8	-32	7.3
2467.75	15.8	12.6	1.2	2	-30.8	-32	7.1
2467.80	15.7	12.6	1.1	2	-30.9	-32	7.7
2467.85	15.2	12.6	0.6	2	-31.4	-32	7.6
2467.90	15.1	12.6	0.5	2	-31.5	-32	7.1
2467.95	14.6	12.6	0	2	-32	-32	6.8
2468.00	14.4	12.6	-0.2	2	-32.2	-32	7.6
2468.05	14.3	12.6	-0.3	2	-32.3	-32	6.7
2468.10	14.2	12.6	-0.4	2	-32.4	-32	7.8
2468.15	14.1	12.6	-0.5	2	-32.5	-32	6.8
2468.20	14.1	12.6	-0.5	2	-32.5	-32	7.8
2468.25	14	12.6	-0.6	2	-32.6	-32	6.7
2468.30	14.1	12.6	-0.5	2	-32.5	-32	7.5
2468.35	14.2	12.6	-0.4	2	-32.4	-32	6.6
2468.40	14.3	12.6	-0.3	2	-32.3	-32	7.1
2468.45	14.6	12.6	0	2	-32	-32	6.7
2468.50	14.7	12.6	0.1	2	-31.9	-32	7.3
2468.55	15	12.6	0.4	2	-31.6	-32	6.6
2468.60	15.2	12.6	0.6	2	-31.4	-32	7.6
2468.65	15.3	12.6	0.7	2	-31.3	-32	6.4
2468.70	15.5	12.6	0.9	2	-31.1	-32	6.6
2468.75	15.5	12.6	0.9	2	-31.1	-32	6.3
2468.80	15.6	12.6	1	2	-31	-32	7.3
2468.85	15.4	12.6	0.8	2	-31.2	-32	6.5
2468.90	15.5	12.6	0.9	2	-31.1	-32	7.8
2468.95	15.3	12.6	0.7	2	-31.3	-32	6.6
2469.00	15.2	12.6	0.6	2	-31.4	-32	6.8
2469.05	15.1	12.6	0.5	2	-31.5	-32	6.7
2469.10	15	12.6	0.4	2	-31.6	-32	7.5
2469.15	14.9	12.6	0.3	2	-31.7	-32	5.7
2469.20	14.9	12.6	0.3	2	-31.7	-32	7.7
2469.25	15	12.6	0.4	2	-31.6	-32	6.3
2469.30	15.1	12.6	0.5	2	-31.5	-32	7.8
2469.35	15.2	12.6	0.6	2	-31.4	-32	6.7
2469.40	15.3	12.6	0.7	2	-31.3	-32	7.7
2469.45	15.5	12.6	0.9	2	-31.1	-32	6.3

2469.50	15.7	12.6	1.1	2	-30.9	-32	6.5
2469.55	16.1	12.6	1.5	2	-30.5	-32	6.1
2469.60	16.2	12.6	1.6	2	-30.4	-32	7.2
2469.65	16.1	12.6	1.5	2	-30.5	-32	7.3
2469.70	16.3	12.6	1.7	2	-30.3	-32	7.5
2469.75	16.4	12.6	1.8	2	-30.2	-32	6.8
2469.80	16.3	12.6	1.7	2	-30.3	-32	7.3
2469.85	16.2	12.6	1.6	2	-30.4	-32	6.2
2469.90	16.1	12.6	1.5	2	-30.5	-32	7.5
2469.95	16	12.6	1.4	2	-30.6	-32	6.8
2470.00	16.2	12.6	1.6	2	-30.4	-32	7.1
2470.05	16	12.6	1.4	2	-30.6	-32	5.7
2470.10	15.8	12.6	1.2	2	-30.8	-32	7.8
2470.15	15.8	12.6	1.2	2	-30.8	-32	6.8
2470.20	15.9	12.6	1.3	2	-30.7	-32	7.8
2470.25	15.8	12.6	1.2	2	-30.8	-32	7.1
2470.30	16	12.6	1.4	2	-30.6	-32	7.9
2470.35	16.1	12.6	1.5	2	-30.5	-32	7.3
2470.40	16.2	12.6	1.6	2	-30.4	-32	7.5
2470.45	16.1	12.6	1.5	2	-30.5	-32	6.8
2470.50	16	12.6	1.4	2	-30.6	-32	5.2
Processing Gain (dB) @20th Percentile=				11.9			

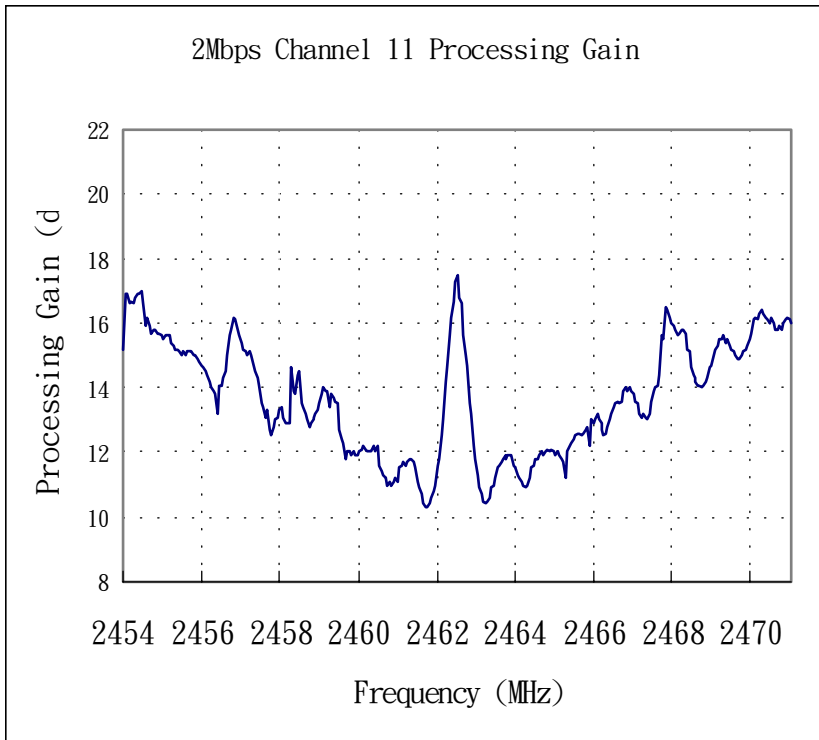

11Mbps Channel 1 Processing Gain							
Gp=(S/N)o+Mj+Lsys							
Freq. (MHz)	Gp (dB)	(S/N)o (dB)	Mj = J/S (dB)	Lsys (dB)	Jammer (dBm)	Lvl (dBm)	FE R
2403.50	17.4	16.4	-1	2	-31	-30	6.1
2403.55	17.4	16.4	-1	2	-31	-30	6.3
2403.60	17.4	16.4	-1	2	-31	-30	7
2403.65	16.4	16.4	-2	2	-32	-30	6.3
2403.70	16.2	16.4	-2.2	2	-32.2	-30	4.5
2403.75	16.3	16.4	-2.1	2	-32.1	-30	4.9
2403.80	16	16.4	-2.4	2	-32.4	-30	7.4
2403.85	15.9	16.4	-2.5	2	-32.5	-30	6.5
2403.90	16.4	16.4	-2	2	-32	-30	7.9
2403.95	16.6	16.4	-1.8	2	-31.8	-30	6.5
2404.00	16.8	16.4	-1.6	2	-31.6	-30	7.1
2404.05	16.6	16.4	-1.8	2	-31.8	-30	6.8
2404.10	16.4	16.4	-2	2	-32	-30	7.2
2404.15	15.4	16.4	-3	2	-33	-30	7.6
2404.20	15.5	16.4	-2.9	2	-32.9	-30	7.1
2404.25	15.3	16.4	-3.1	2	-33.1	-30	7.8
2404.30	14.9	16.4	-3.5	2	-33.5	-30	7.8
2404.35	15	16.4	-3.4	2	-33.4	-30	6
2404.40	14.9	16.4	-3.5	2	-33.5	-30	7.5
2404.45	15.5	16.4	-2.9	2	-32.9	-30	6.8
2404.50	15.5	16.4	-2.9	2	-32.9	-30	7.2
2404.55	15.8	16.4	-2.6	2	-32.6	-30	7.5
2404.60	14.8	16.4	-3.6	2	-33.6	-30	7.9
2404.65	14.6	16.4	-3.8	2	-33.8	-30	7.9
2404.70	14.9	16.4	-3.5	2	-33.5	-30	7.7
2404.75	14.5	16.4	-3.9	2	-33.9	-30	7.9
2404.80	14.3	16.4	-4.1	2	-34.1	-30	7.3
2404.85	14.5	16.4	-3.9	2	-33.9	-30	7.3
2404.90	14.6	16.4	-3.8	2	-33.8	-30	7.3
2404.95	14.9	16.4	-3.5	2	-33.5	-30	7.7
2405.00	15.2	16.4	-3.2	2	-33.2	-30	7.4
2405.05	14.4	16.4	-4	2	-34	-30	7.4

2405.10	15.1	16.4	-3.3	2	-33.3	-30	7.5
2405.15	14.5	16.4	-3.9	2	-33.9	-30	7.8
2405.20	14.6	16.4	-3.8	2	-33.8	-30	7.4
2405.25	14.8	16.4	-3.6	2	-33.6	-30	7.6
2405.30	14.4	16.4	-4	2	-34	-30	7.9
2405.35	14.4	16.4	-4	2	-34	-30	7.5
2405.40	14.4	16.4	-4	2	-34	-30	7.7
2405.45	14.1	16.4	-4.3	2	-34.3	-30	7.6
2405.50	14.1	16.4	-4.3	2	-34.3	-30	7.6
2405.55	13.8	16.4	-4.6	2	-34.6	-30	7.9
2405.60	14.4	16.4	-4	2	-34	-30	7.8
2405.65	14.5	16.4	-3.9	2	-33.9	-30	7.7
2405.70	14.4	16.4	-4	2	-34	-30	7.6
2405.75	14.7	16.4	-3.7	2	-33.7	-30	7.9
2405.80	14.3	16.4	-4.1	2	-34.1	-30	7.6
2405.85	14.5	16.4	-3.9	2	-33.9	-30	7.7
2405.90	14.4	16.4	-4	2	-34	-30	7.7
2405.95	14.6	16.4	-3.8	2	-33.8	-30	7.8
2406.00	14.2	16.4	-4.2	2	-34.2	-30	7.9
2406.05	14.6	16.4	-3.8	2	-33.8	-30	7.9
2406.10	14.5	16.4	-3.9	2	-33.9	-30	7.6
2406.15	15.1	16.4	-3.3	2	-33.3	-30	7.8
2406.20	15	16.4	-3.4	2	-33.4	-30	7.7
2406.25	14.8	16.4	-3.6	2	-33.6	-30	7.7
2406.30	14.4	16.4	-4	2	-34	-30	7.9
2406.35	14.1	16.4	-4.3	2	-34.3	-30	7.9
2406.40	14.2	16.4	-4.2	2	-34.2	-30	7.9
2406.45	14	16.4	-4.4	2	-34.4	-30	7.5
2406.50	13.7	16.4	-4.7	2	-34.7	-30	7.9
2406.55	13.9	16.4	-4.5	2	-34.5	-30	7.5
2406.60	14.1	16.4	-4.3	2	-34.3	-30	7.3
2406.65	14.3	16.4	-4.1	2	-34.1	-30	7.6
2406.70	14.5	16.4	-3.9	2	-33.9	-30	7.9
2406.75	14.3	16.4	-4.1	2	-34.1	-30	7.4
2406.80	14.7	16.4	-3.7	2	-33.7	-30	7.5
2406.85	15	16.4	-3.4	2	-33.4	-30	7.9

2406.90	14.8	16.4	-3.6	2	-33.6	-30	7.7
2406.95	14.4	16.4	-4	2	-34	-30	7.5
2407.00	14	16.4	-4.4	2	-34.4	-30	7.7
2407.05	13.6	16.4	-4.8	2	-34.8	-30	7.7
2407.10	13.6	16.4	-4.8	2	-34.8	-30	7.5
2407.15	13.6	16.4	-4.8	2	-34.8	-30	7.9
2407.20	13.5	16.4	-4.9	2	-34.9	-30	7.9
2407.25	13.6	16.4	-4.8	2	-34.8	-30	7.8
2407.30	13.6	16.4	-4.8	2	-34.8	-30	7.5
2407.35	13.7	16.4	-4.7	2	-34.7	-30	7.5
2407.40	14	16.4	-4.4	2	-34.4	-30	7.9
2407.45	14	16.4	-4.4	2	-34.4	-30	7.7
2407.50	14.2	16.4	-4.2	2	-34.2	-30	7.9
2407.55	13.9	16.4	-4.5	2	-34.5	-30	7.8
2407.60	13.8	16.4	-4.6	2	-34.6	-30	7.9
2407.65	13.5	16.4	-4.9	2	-34.9	-30	7.9
2407.70	13.1	16.4	-5.3	2	-35.3	-30	7.7
2407.75	12.8	16.4	-5.6	2	-35.6	-30	7.8
2407.80	12.6	16.4	-5.8	2	-35.8	-30	7.9
2407.85	12.5	16.4	-5.9	2	-35.9	-30	7.5
2407.90	12.5	16.4	-5.9	2	-35.9	-30	7.6
2407.95	12.5	16.4	-5.9	2	-35.9	-30	7.3
2408.00	12.7	16.4	-5.7	2	-35.7	-30	7.6
2408.05	12.8	16.4	-5.6	2	-35.6	-30	7.9
2408.10	13	16.4	-5.4	2	-35.4	-30	7.4
2408.15	13	16.4	-5.4	2	-35.4	-30	7.6
2408.20	13.1	16.4	-5.3	2	-35.3	-30	7.6
2408.25	13.1	16.4	-5.3	2	-35.3	-30	7.9
2408.30	12.8	16.4	-5.6	2	-35.6	-30	7.5
2408.35	12.9	16.4	-5.5	2	-35.5	-30	7.7
2408.40	12.6	16.4	-5.8	2	-35.8	-30	7.5
2408.45	12.4	16.4	-6	2	-36	-30	7.5
2408.50	12.2	16.4	-6.2	2	-36.2	-30	7.9
2408.55	11.9	16.4	-6.5	2	-36.5	-30	7.7
2408.60	11.5	16.4	-6.9	2	-36.9	-30	7.5
2408.65	11.5	16.4	-6.9	2	-36.9	-30	7.6

2408.70	11.5	16.4	-6.9	2	-36.9	-30	7.5
2408.75	11.6	16.4	-6.8	2	-36.8	-30	7.7
2408.80	11.8	16.4	-6.6	2	-36.6	-30	7.7
2408.85	11.8	16.4	-6.6	2	-36.6	-30	7.8
2408.90	11.8	16.4	-6.6	2	-36.6	-30	7.6
2408.95	11.9	16.4	-6.5	2	-36.5	-30	7.7
2409.00	11.9	16.4	-6.5	2	-36.5	-30	7.5
2409.05	11.8	16.4	-6.6	2	-36.6	-30	7.9
2409.10	11.6	16.4	-6.8	2	-36.8	-30	7.5
2409.15	11.5	16.4	-6.9	2	-36.9	-30	7.5
2409.20	11.3	16.4	-7.1	2	-37.1	-30	7.8
2409.25	11.2	16.4	-7.2	2	-37.2	-30	7.8
2409.30	10.9	16.4	-7.5	2	-37.5	-30	7.9
2409.35	10.8	16.4	-7.6	2	-37.6	-30	7.7
2409.40	10.7	16.4	-7.7	2	-37.7	-30	7.8
2409.45	10.7	16.4	-7.7	2	-37.7	-30	7.5
2409.50	10.7	16.4	-7.7	2	-37.7	-30	7.6
2409.55	10.9	16.4	-7.5	2	-37.5	-30	7.6
2409.60	11	16.4	-7.4	2	-37.4	-30	7.9
2409.65	11.1	16.4	-7.3	2	-37.3	-30	7.7
2409.70	11.1	16.4	-7.3	2	-37.3	-30	7.2
2409.75	11.2	16.4	-7.2	2	-37.2	-30	7.9
2409.80	11.2	16.4	-7.2	2	-37.2	-30	7.7
2409.85	11.2	16.4	-7.2	2	-37.2	-30	7.8
2409.90	11.1	16.4	-7.3	2	-37.3	-30	7.2
2409.95	11.1	16.4	-7.3	2	-37.3	-30	7.5
2410.00	11	16.4	-7.4	2	-37.4	-30	7.3
2410.05	10.9	16.4	-7.5	2	-37.5	-30	7.4
2410.10	10.8	16.4	-7.6	2	-37.6	-30	7.6
2410.15	10.7	16.4	-7.7	2	-37.7	-30	7.7
2410.20	10.7	16.4	-7.7	2	-37.7	-30	7.3
2410.25	10.7	16.4	-7.7	2	-37.7	-30	7.2
2410.30	10.8	16.4	-7.6	2	-37.6	-30	7.5
2410.35	11	16.4	-7.4	2	-37.4	-30	7.4
2410.40	11.2	16.4	-7.2	2	-37.2	-30	7.5
2410.45	11.3	16.4	-7.1	2	-37.1	-30	7.9

2410.50	11.5	16.4	-6.9	2	-36.9	-30	7.9
2410.55	11.6	16.4	-6.8	2	-36.8	-30	7.6
2410.60	11.6	16.4	-6.8	2	-36.8	-30	7.7
2410.65	11.6	16.4	-6.8	2	-36.8	-30	7.2
2410.70	11.7	16.4	-6.7	2	-36.7	-30	7.9
2410.75	11.7	16.4	-6.7	2	-36.7	-30	7.6
2410.80	11.5	16.4	-6.9	2	-36.9	-30	7.3
2410.85	11.4	16.4	-7	2	-37	-30	8
2410.90	11.4	16.4	-7	2	-37	-30	7.7
2410.95	11.4	16.4	-7	2	-37	-30	7.9
2411.00	11.3	16.4	-7.1	2	-37.1	-30	7.3
2411.05	11	16.4	-7.4	2	-37.4	-30	7.8
2411.10	11	16.4	-7.4	2	-37.4	-30	7.8
2411.15	11.4	16.4	-7	2	-37	-30	7.8
2411.20	11.6	16.4	-6.8	2	-36.8	-30	7.7
2411.25	11.9	16.4	-6.5	2	-36.5	-30	7.8
2411.30	11.9	16.4	-6.5	2	-36.5	-30	7.9
2411.35	12.1	16.4	-6.3	2	-36.3	-30	7.9
2411.40	12.3	16.4	-6.1	2	-36.1	-30	7.9
2411.45	12.3	16.4	-6.1	2	-36.1	-30	7.9
2411.50	12.3	16.4	-6.1	2	-36.1	-30	8
2411.55	12.1	16.4	-6.3	2	-36.3	-30	7.9
2411.60	12.1	16.4	-6.3	2	-36.3	-30	7.5
2411.65	11.9	16.4	-6.5	2	-36.5	-30	7.6
2411.70	11.8	16.4	-6.6	2	-36.6	-30	7.1
2411.75	11.6	16.4	-6.8	2	-36.8	-30	7.8
2411.80	11.4	16.4	-7	2	-37	-30	7.2
2411.85	11.4	16.4	-7	2	-37	-30	7.8
2411.90	11.3	16.4	-7.1	2	-37.1	-30	7.7
2411.95	11.5	16.4	-6.9	2	-36.9	-30	7.9
2412.00	11.2	16.4	-7.2	2	-37.2	-30	7.7
2412.05	11.1	16.4	-7.3	2	-37.3	-30	7.7
2412.10	11.4	16.4	-7	2	-37	-30	7.2
2412.15	11.6	16.4	-6.8	2	-36.8	-30	7.4
2412.20	11.9	16.4	-6.5	2	-36.5	-30	7.6
2412.25	11.8	16.4	-6.6	2	-36.6	-30	7.4

2412.30	11.8	16.4	-6.6	2	-36.6	-30	7.9
2412.35	11.6	16.4	-6.8	2	-36.8	-30	7.9
2412.40	11.4	16.4	-7	2	-37	-30	7.3
2412.45	11.2	16.4	-7.2	2	-37.2	-30	7.2
2412.50	11.1	16.4	-7.3	2	-37.3	-30	7.2
2412.55	11	16.4	-7.4	2	-37.4	-30	7.2
2412.60	11	16.4	-7.4	2	-37.4	-30	7.2
2412.65	11	16.4	-7.4	2	-37.4	-30	7.9
2412.70	11.2	16.4	-7.2	2	-37.2	-30	7.3
2412.75	11.4	16.4	-7	2	-37	-30	7.4
2412.80	11.6	16.4	-6.8	2	-36.8	-30	7.3
2412.85	12.1	16.4	-6.3	2	-36.3	-30	7.5
2412.90	12.2	16.4	-6.2	2	-36.2	-30	7.4
2412.95	12.3	16.4	-6.1	2	-36.1	-30	7.5
2413.00	12.2	16.4	-6.2	2	-36.2	-30	7.2
2413.05	12.2	16.4	-6.2	2	-36.2	-30	7.8
2413.10	11.9	16.4	-6.5	2	-36.5	-30	7.9
2413.15	11.6	16.4	-6.8	2	-36.8	-30	7.9
2413.20	11.4	16.4	-7	2	-37	-30	7.8
2413.25	11.2	16.4	-7.2	2	-37.2	-30	8
2413.30	11	16.4	-7.4	2	-37.4	-30	7.4
2413.35	10.9	16.4	-7.5	2	-37.5	-30	7.5
2413.40	11	16.4	-7.4	2	-37.4	-30	7.5
2413.45	11	16.4	-7.4	2	-37.4	-30	7.6
2413.50	11.2	16.4	-7.2	2	-37.2	-30	7.9
2413.55	11.4	16.4	-7	2	-37	-30	7.4
2413.60	11.6	16.4	-6.8	2	-36.8	-30	7.9
2413.65	11.7	16.4	-6.7	2	-36.7	-30	7.6
2413.70	11.8	16.4	-6.6	2	-36.6	-30	7.4
2413.75	11.8	16.4	-6.6	2	-36.6	-30	7.4
2413.80	11.8	16.4	-6.6	2	-36.6	-30	7.8
2413.85	11.6	16.4	-6.8	2	-36.8	-30	8
2413.90	11.4	16.4	-7	2	-37	-30	7.7
2413.95	11.2	16.4	-7.2	2	-37.2	-30	7.3
2414.00	11	16.4	-7.4	2	-37.4	-30	7.8
2414.05	10.8	16.4	-7.6	2	-37.6	-30	7.3

2414.10	10.7	16.4	-7.7	2	-37.7	-30	7.7
2414.15	10.8	16.4	-7.6	2	-37.6	-30	7.6
2414.20	11	16.4	-7.4	2	-37.4	-30	7.8
2414.25	11.2	16.4	-7.2	2	-37.2	-30	7.6
2414.30	11.4	16.4	-7	2	-37	-30	7.4
2414.35	11.7	16.4	-6.7	2	-36.7	-30	7.6
2414.40	11.8	16.4	-6.6	2	-36.6	-30	7.3
2414.45	11.9	16.4	-6.5	2	-36.5	-30	7.2
2414.50	12	16.4	-6.4	2	-36.4	-30	7.7
2414.55	12	16.4	-6.4	2	-36.4	-30	7.6
2414.60	12	16.4	-6.4	2	-36.4	-30	7.8
2414.65	11.7	16.4	-6.7	2	-36.7	-30	7.6
2414.70	11.7	16.4	-6.7	2	-36.7	-30	7.6
2414.75	11.5	16.4	-6.9	2	-36.9	-30	7.7
2414.80	11.5	16.4	-6.9	2	-36.9	-30	7.8
2414.85	11.5	16.4	-6.9	2	-36.9	-30	7.6
2414.90	11.6	16.4	-6.8	2	-36.8	-30	7.9
2414.95	11.6	16.4	-6.8	2	-36.8	-30	7.4
2415.00	11.9	16.4	-6.5	2	-36.5	-30	7.4
2415.05	12.1	16.4	-6.3	2	-36.3	-30	7.9
2415.10	12.2	16.4	-6.2	2	-36.2	-30	7.8
2415.15	12.5	16.4	-5.9	2	-35.9	-30	8
2415.20	12.6	16.4	-5.8	2	-35.8	-30	7.9
2415.25	12.7	16.4	-5.7	2	-35.7	-30	7.5
2415.30	12.8	16.4	-5.6	2	-35.6	-30	8
2415.35	12.8	16.4	-5.6	2	-35.6	-30	7.7
2415.40	12.7	16.4	-5.7	2	-35.7	-30	7.6
2415.45	12.7	16.4	-5.7	2	-35.7	-30	7.7
2415.50	12.5	16.4	-5.9	2	-35.9	-30	8
2415.55	12.5	16.4	-5.9	2	-35.9	-30	7.6
2415.60	12.4	16.4	-6	2	-36	-30	7.7
2415.65	12.4	16.4	-6	2	-36	-30	7.5
2415.70	12.3	16.4	-6.1	2	-36.1	-30	7.9
2415.75	12.6	16.4	-5.8	2	-35.8	-30	7.4
2415.80	12.7	16.4	-5.7	2	-35.7	-30	7.3
2415.85	12.8	16.4	-5.6	2	-35.6	-30	8

2415.90	12.9	16.4	-5.5	2	-35.5	-30	7.2
2415.95	13.1	16.4	-5.3	2	-35.3	-30	7.5
2416.00	13.3	16.4	-5.1	2	-35.1	-30	7.4
2416.05	13.3	16.4	-5.1	2	-35.1	-30	7.8
2416.10	13.4	16.4	-5	2	-35	-30	7.3
2416.15	13.5	16.4	-4.9	2	-34.9	-30	7.9
2416.20	13.5	16.4	-4.9	2	-34.9	-30	7.5
2416.25	13.4	16.4	-5	2	-35	-30	7.5
2416.30	13.4	16.4	-5	2	-35	-30	7.1
2416.35	13.4	16.4	-5	2	-35	-30	7.4
2416.40	13.4	16.4	-5	2	-35	-30	7.6
2416.45	13.4	16.4	-5	2	-35	-30	7.8
2416.50	13.4	16.4	-5	2	-35	-30	7.5
2416.55	13.4	16.4	-5	2	-35	-30	7.3
2416.60	13.5	16.4	-4.9	2	-34.9	-30	7.6
2416.65	13.8	16.4	-4.6	2	-34.6	-30	8
2416.70	14	16.4	-4.4	2	-34.4	-30	7.8
2416.75	14.2	16.4	-4.2	2	-34.2	-30	7.3
2416.80	14.4	16.4	-4	2	-34	-30	7.6
2416.85	14.6	16.4	-3.8	2	-33.8	-30	7.6
2416.90	14.8	16.4	-3.6	2	-33.6	-30	7.6
2416.95	14.8	16.4	-3.6	2	-33.6	-30	7.3
2417.00	15	16.4	-3.4	2	-33.4	-30	7.4
2417.05	15	16.4	-3.4	2	-33.4	-30	7.9
2417.10	15	16.4	-3.4	2	-33.4	-30	7.3
2417.15	15	16.4	-3.4	2	-33.4	-30	7.7
2417.20	14.9	16.4	-3.5	2	-33.5	-30	7.7
2417.25	14.8	16.4	-3.6	2	-33.6	-30	7.9
2417.30	15	16.4	-3.4	2	-33.4	-30	8
2417.35	15.1	16.4	-3.3	2	-33.3	-30	7.4
2417.40	14.8	16.4	-3.6	2	-33.6	-30	6.8
2417.45	14.6	16.4	-3.8	2	-33.8	-30	7.2
2417.50	14.4	16.4	-4	2	-34	-30	7.1
2417.55	14.2	16.4	-4.2	2	-34.2	-30	6.5
2417.60	14.3	16.4	-4.1	2	-34.1	-30	6.4
2417.65	14.1	16.4	-4.3	2	-34.3	-30	5.3

2417.70	13.9	16.4	-4.5	2	-34.5	-30	7.1
2417.75	14.5	16.4	-3.9	2	-33.9	-30	6.8
2417.80	14.6	16.4	-3.8	2	-33.8	-30	7.5
2417.85	14.8	16.4	-3.6	2	-33.6	-30	7.1
2417.90	14.8	16.4	-3.6	2	-33.6	-30	6.3
2417.95	14.8	16.4	-3.6	2	-33.6	-30	6.5
2418.00	14.9	16.4	-3.5	2	-33.5	-30	5.8
2418.05	15	16.4	-3.4	2	-33.4	-30	5.9
2418.10	15.1	16.4	-3.3	2	-33.3	-30	6.1
2418.15	15.2	16.4	-3.2	2	-33.2	-30	6.2
2418.20	15.3	16.4	-3.1	2	-33.1	-30	6
2418.25	15.4	16.4	-3	2	-33	-30	5.7
2418.30	15.3	16.4	-3.1	2	-33.1	-30	5.8
2418.35	15.4	16.4	-3	2	-33	-30	5.7
2418.40	15.2	16.4	-3.2	2	-33.2	-30	7
2418.45	15.5	16.4	-2.9	2	-32.9	-30	6.8
2418.50	15.6	16.4	-2.8	2	-32.8	-30	6.7
2418.55	15.2	16.4	-3.2	2	-33.2	-30	6.8
2418.60	15	16.4	-3.4	2	-33.4	-30	5.9
2418.65	15.3	16.4	-3.1	2	-33.1	-30	7.3
2418.70	15.5	16.4	-2.9	2	-32.9	-30	7.2
2418.75	15.6	16.4	-2.8	2	-32.8	-30	7.1
2418.80	15.5	16.4	-2.9	2	-32.9	-30	7
2418.85	15.6	16.4	-2.8	2	-32.8	-30	6.8
2418.90	15.7	16.4	-2.7	2	-32.7	-30	6.7
2418.95	15.6	16.4	-2.8	2	-32.8	-30	6.8
2419.00	14.6	16.4	-3.8	2	-33.8	-30	5.9
2419.05	14.8	16.4	-3.6	2	-33.6	-30	6.1
2419.10	15.4	16.4	-3	2	-33	-30	5.7
2419.15	15.3	16.4	-3.1	2	-33.1	-30	6.1
2419.20	15.2	16.4	-3.2	2	-33.2	-30	6.2
2419.25	14.5	16.4	-3.9	2	-33.9	-30	6.3
2419.30	14.7	16.4	-3.7	2	-33.7	-30	6.1
2419.35	14.6	16.4	-3.8	2	-33.8	-30	5.8
2419.40	14.6	16.4	-3.8	2	-33.8	-30	5.9
2419.45	15.2	16.4	-3.2	2	-33.2	-30	6.1

2419.50	15.1	16.4	-3.3	2	-33.3	-30	7.1
2419.55	15	16.4	-3.4	2	-33.4	-30	7.3
2419.60	15.2	16.4	-3.2	2	-33.2	-30	7.4
2419.65	15.4	16.4	-3	2	-33	-30	7.5
2419.70	15	16.4	-3.4	2	-33.4	-30	7.6
2419.75	15.2	16.4	-3.2	2	-33.2	-30	7.1
2419.80	14.9	16.4	-3.5	2	-33.5	-30	7.4
2419.85	15.8	16.4	-2.6	2	-32.6	-30	5.9
2419.90	15.4	16.4	-3	2	-33	-30	5.6
2419.95	15	16.4	-3.4	2	-33.4	-30	5.8
2420.00	15.4	16.4	-3	2	-33	-30	6.3
2420.05	15.5	16.4	-2.9	2	-32.9	-30	6.1
2420.10	15.2	16.4	-3.2	2	-33.2	-30	6.2
2420.15	15.3	16.4	-3.1	2	-33.1	-30	6.3
2420.20	15.7	16.4	-2.7	2	-32.7	-30	6.1
2420.25	15.5	16.4	-2.9	2	-32.9	-30	6.5
2420.30	16.1	16.4	-2.3	2	-32.3	-30	6.3
2420.35	15.8	16.4	-2.6	2	-32.6	-30	6.4
2420.40	15.9	16.4	-2.5	2	-32.5	-30	6.5
2420.45	16.2	16.4	-2.2	2	-32.2	-30	6.2
2420.50	16.1	16.4	-2.3	2	-32.3	-30	6.5
Processing Gain (dB) @20th Percentile=				11.5			

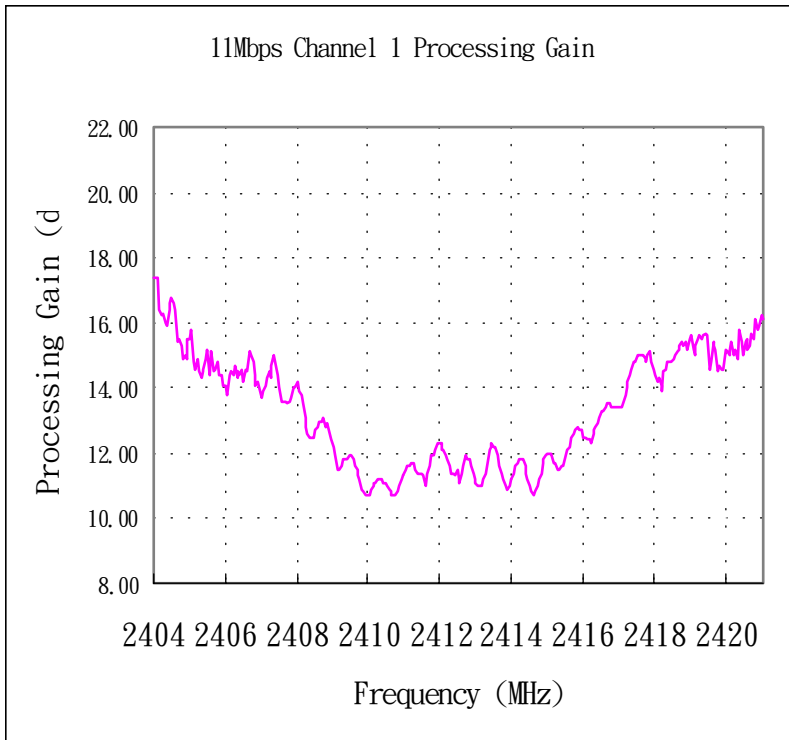

11Mbps Channel 6 Processing Gain							
Gp=(S/N)o+Mj+Lsys							
Freq. (MHz)	Gp (dB)	(S/N)o (dB)	Mj = J/S (dB)	Lsys (dB)	Jammer (dBm)	Lvl (dBm)	FE R
2428.50	21.4	16.4	3	2	-29.2	-32.2	7.2
2428.55	20.9	16.4	2.5	2	-29.7	-32.2	6.7
2428.60	21.4	16.4	3	2	-29.2	-32.2	7.6
2428.65	20.9	16.4	2.5	2	-29.7	-32.2	6.5
2428.70	21.1	16.4	2.7	2	-29.5	-32.2	7.8
2428.75	21.2	16.4	2.8	2	-29.4	-32.2	7.3
2428.80	20.9	16.4	2.5	2	-29.7	-32.2	6.5
2428.85	20.6	16.4	2.2	2	-30	-32.2	9.7
2428.90	20.4	16.4	2	2	-30.2	-32.2	6.9
2428.95	20.8	16.4	2.4	2	-29.8	-32.2	7.2
2429.00	20.7	16.4	2.3	2	-29.9	-32.2	6.9
2429.05	21	16.4	2.6	2	-29.6	-32.2	7.9
2429.10	21.3	16.4	2.9	2	-29.3	-32.2	7.4
2429.15	20.9	16.4	2.5	2	-29.7	-32.2	7.4
2429.20	20.8	16.4	2.4	2	-29.8	-32.2	7
2429.25	20.7	16.4	2.3	2	-29.9	-32.2	6.7
2429.30	20.6	16.4	2.2	2	-30	-32.2	6.5
2429.35	20.5	16.4	2.1	2	-30.1	-32.2	7.6
2429.40	20.4	16.4	2	2	-30.2	-32.2	7.4
2429.45	20.25	16.4	1.85	2	-30.35	-32.2	7.3
2429.50	20.2	16.4	1.8	2	-30.4	-32.2	7.3
2429.55	20	16.4	1.6	2	-30.6	-32.2	5.3
2429.60	19.8	16.4	1.4	2	-30.8	-32.2	5.6
2429.65	19.9	16.4	1.5	2	-30.7	-32.2	6.7
2429.70	20.1	16.4	1.7	2	-30.5	-32.2	6.8
2429.75	19.8	16.4	1.4	2	-30.8	-32.2	6.7
2429.80	19.7	16.4	1.3	2	-30.9	-32.2	5.5
2429.85	19.6	16.4	1.2	2	-31	-32.2	7.5
2429.90	19.5	16.4	1.1	2	-31.1	-32.2	7.8
2429.95	19.4	16.4	1	2	-31.2	-32.2	7.6
2430.00	19.4	16.4	1	2	-31.2	-32.2	5.6
2430.05	19	16.4	0.6	2	-31.6	-32.2	6.7

2430.10	18.9	16.4	0.5	2	-31.7	-32.2	5.7
2430.15	18.7	16.4	0.3	2	-31.9	-32.2	6.3
2430.20	18.7	16.4	0.3	2	-31.9	-32.2	7.6
2430.25	18.45	16.4	0.05	2	-32.15	-32.2	7
2430.30	18.3	16.4	-0.1	2	-32.3	-32.2	7.1
2430.35	18.2	16.4	-0.2	2	-32.4	-32.2	7.4
2430.40	18	16.4	-0.4	2	-32.6	-32.2	7.5
2430.45	17.8	16.4	-0.6	2	-32.8	-32.2	5.6
2430.50	17.7	16.4	-0.7	2	-32.9	-32.2	6.1
2430.55	17.5	16.4	-0.9	2	-33.1	-32.2	5.6
2430.60	17.2	16.4	-1.2	2	-33.4	-32.2	5.1
2430.65	16.8	16.4	-1.6	2	-33.8	-32.2	6.9
2430.70	16.6	16.4	-1.8	2	-34	-32.2	6.9
2430.75	16.3	16.4	-2.1	2	-34.3	-32.2	7.3
2430.80	16.3	16.4	-2.1	2	-34.3	-32.2	7.5
2430.85	16.2	16.4	-2.2	2	-34.4	-32.2	6.8
2430.90	16	16.4	-2.4	2	-34.6	-32.2	7.4
2430.95	16.2	16.4	-2.2	2	-34.4	-32.2	6.8
2431.00	16.1	16.4	-2.3	2	-34.5	-32.2	7.9
2431.05	16	16.4	-2.4	2	-34.6	-32.2	7.2
2431.10	16	16.4	-2.4	2	-34.6	-32.2	7.9
2431.15	15.6	16.4	-2.8	2	-35	-32.2	7
2431.20	15.6	16.4	-2.8	2	-35	-32.2	6.2
2431.25	15.4	16.4	-3	2	-35.2	-32.2	6.5
2431.30	15.3	16.4	-3.1	2	-35.3	-32.2	6.9
2431.35	15.1	16.4	-3.3	2	-35.5	-32.2	6.4
2431.40	15.3	16.4	-3.1	2	-35.3	-32.2	6.8
2431.45	14.9	16.4	-3.5	2	-35.7	-32.2	6.1
2431.50	14.9	16.4	-3.5	2	-35.7	-32.2	6.3
2431.55	14.7	16.4	-3.7	2	-35.9	-32.2	6.6
2431.60	14.8	16.4	-3.6	2	-35.8	-32.2	7
2431.65	14.7	16.4	-3.7	2	-35.9	-32.2	6.8
2431.70	14.6	16.4	-3.8	2	-36	-32.2	6.4
2431.75	14.5	16.4	-3.9	2	-36.1	-32.2	6.2
2431.80	14.6	16.4	-3.8	2	-36	-32.2	6.3
2431.85	14.3	16.4	-4.1	2	-36.3	-32.2	6.3

2431.90	14.1	16.4	-4.3	2	-36.5	-32.2	5.9
2431.95	13.5	16.4	-4.9	2	-37.1	-32.2	6.7
2432.00	13.4	16.4	-5	2	-37.2	-32.2	7.2
2432.05	13.3	16.4	-5.1	2	-37.3	-32.2	7.1
2432.10	13.4	16.4	-5	2	-37.2	-32.2	7.5
2432.15	13	16.4	-5.4	2	-37.6	-32.2	6.8
2432.20	12.8	16.4	-5.6	2	-37.8	-32.2	5.9
2432.25	13.1	16.4	-5.3	2	-37.5	-32.2	6.5
2432.30	13	16.4	-5.4	2	-37.6	-32.2	6.9
2432.35	12.8	16.4	-5.6	2	-37.8	-32.2	5.1
2432.40	13	16.4	-5.4	2	-37.6	-32.2	7.6
2432.45	13.2	16.4	-5.2	2	-37.4	-32.2	6.3
2432.50	12.8	16.4	-5.6	2	-37.8	-32.2	5
2432.55	13	16.4	-5.4	2	-37.6	-32.2	6.6
2432.60	12.8	16.4	-5.6	2	-37.8	-32.2	5.6
2432.65	12.7	16.4	-5.7	2	-37.9	-32.2	6.7
2432.70	12.6	16.4	-5.8	2	-38	-32.2	6.8
2432.75	12.4	16.4	-6	2	-38.2	-32.2	6.1
2432.80	12.3	16.4	-6.1	2	-38.3	-32.2	5.4
2432.85	12.2	16.4	-6.2	2	-38.4	-32.2	7
2432.90	12.1	16.4	-6.3	2	-38.5	-32.2	7.2
2432.95	11.9	16.4	-6.5	2	-38.7	-32.2	5.2
2433.00	11.6	16.4	-6.8	2	-39	-32.2	4.2
2433.05	11.9	16.4	-6.5	2	-38.7	-32.2	7.9
2433.10	11.9	16.4	-6.5	2	-38.7	-32.2	7.8
2433.15	11.9	16.4	-6.5	2	-38.7	-32.2	6.5
2433.20	11.9	16.4	-6.5	2	-38.7	-32.2	7.8
2433.25	11.8	16.4	-6.6	2	-38.8	-32.2	5.9
2433.30	11.7	16.4	-6.7	2	-38.9	-32.2	5.8
2433.35	11.7	16.4	-6.7	2	-38.9	-32.2	7.1
2433.40	11.6	16.4	-6.8	2	-39	-32.2	6.9
2433.45	11.6	16.4	-6.8	2	-39	-32.2	6.5
2433.50	11.4	16.4	-7	2	-39.2	-32.2	6
2433.55	11.4	16.4	-7	2	-39.2	-32.2	6.8
2433.60	11.4	16.4	-7	2	-39.2	-32.2	6.9
2433.65	11.1	16.4	-7.3	2	-39.5	-32.2	5.2

2433.70	11.1	16.4	-7.3	2	-39.5	-32.2	4.8
2433.75	11.1	16.4	-7.3	2	-39.5	-32.2	4.7
2433.80	11.2	16.4	-7.2	2	-39.4	-32.2	7.8
2433.85	11.1	16.4	-7.3	2	-39.5	-32.2	5.3
2433.90	11	16.4	-7.4	2	-39.6	-32.2	0.2
2433.95	10.8	16.4	-7.6	2	-39.8	-32.2	6.7
2434.00	10.7	16.4	-7.7	2	-39.9	-32.2	7.1
2434.05	10.8	16.4	-7.6	2	-39.8	-32.2	4.3
2434.10	10.4	16.4	-8	2	-40.2	-32.2	5.1
2434.15	10.8	16.4	-7.6	2	-39.8	-32.2	4.9
2434.20	10	16.4	-8.4	2	-40.6	-32.2	7.2
2434.25	10.4	16.4	-8	2	-40.2	-32.2	6.7
2434.30	10.8	16.4	-7.6	2	-39.8	-32.2	5.3
2434.35	10.7	16.4	-7.7	2	-39.9	-32.2	4.9
2434.40	10.4	16.4	-8	2	-40.2	-32.2	5.3
2434.45	10.6	16.4	-7.8	2	-40	-32.2	6.8
2434.50	10.4	16.4	-8	2	-40.2	-32.2	7.2
2434.55	10.3	16.4	-8.1	2	-40.3	-32.2	6.8
2434.60	10	16.4	-8.4	2	-40.6	-32.2	5.3
2434.65	10	16.4	-8.4	2	-40.6	-32.2	6.1
2434.70	10.1	16.4	-8.3	2	-40.5	-32.2	5.9
2434.75	10.1	16.4	-8.3	2	-40.5	-32.2	4.8
2434.80	10.1	16.4	-8.3	2	-40.5	-32.2	5.8
2434.85	10.1	16.4	-8.3	2	-40.5	-32.2	5.3
2434.90	10.1	16.4	-8.3	2	-40.5	-32.2	7.8
2434.95	10.1	16.4	-8.3	2	-40.5	-32.2	5.2
2435.00	10	16.4	-8.4	2	-40.6	-32.2	6.8
2435.05	10.2	16.4	-8.2	2	-40.4	-32.2	6.5
2435.10	10.8	16.4	-7.6	2	-39.8	-32.2	7.4
2435.15	10.4	16.4	-8	2	-40.2	-32.2	6.4
2435.20	10.4	16.4	-8	2	-40.2	-32.2	7.2
2435.25	10.4	16.4	-8	2	-40.2	-32.2	5.8
2435.30	10.4	16.4	-8	2	-40.2	-32.2	6.2
2435.35	10.4	16.4	-8	2	-40.2	-32.2	4.8
2435.40	10.4	16.4	-8	2	-40.2	-32.2	6.3
2435.45	10.1	16.4	-8.3	2	-40.5	-32.2	7.2

2435.50	10.2	16.4	-8.2	2	-40.4	-32.2	6.8
2435.55	10.3	16.4	-8.1	2	-40.3	-32.2	5.6
2435.60	10.2	16.4	-8.2	2	-40.4	-32.2	7.3
2435.65	10.4	16.4	-8	2	-40.2	-32.2	6.8
2435.70	10.4	16.4	-8	2	-40.2	-32.2	6.2
2435.75	10.8	16.4	-7.6	2	-39.8	-32.2	7.9
2435.80	10.4	16.4	-8	2	-40.2	-32.2	6.3
2435.85	10.9	16.4	-7.5	2	-39.7	-32.2	6.5
2435.90	10.4	16.4	-8	2	-40.2	-32.2	6.8
2435.95	10.8	16.4	-7.6	2	-39.8	-32.2	7.6
2436.00	10.7	16.4	-7.7	2	-39.9	-32.2	6.8
2436.05	10.6	16.4	-7.8	2	-40	-32.2	5.6
2436.10	10.4	16.4	-8	2	-40.2	-32.2	4.4
2436.15	10.6	16.4	-7.8	2	-40	-32.2	4.4
2436.20	10.8	16.4	-7.6	2	-39.8	-32.2	5.6
2436.25	10.8	16.4	-7.6	2	-39.8	-32.2	6.7
2436.30	11	16.4	-7.4	2	-39.6	-32.2	5.6
2436.35	10.6	16.4	-7.8	2	-40	-32.2	6.8
2436.40	10.8	16.4	-7.6	2	-39.8	-32.2	7.2
2436.45	10.7	16.4	-7.7	2	-39.9	-32.2	5.6
2436.50	10.8	16.4	-7.6	2	-39.8	-32.2	4.2
2436.55	10.8	16.4	-7.6	2	-39.8	-32.2	6.8
2436.60	10.9	16.4	-7.5	2	-39.7	-32.2	4.7
2436.65	10.6	16.4	-7.8	2	-40	-32.2	6.8
2436.70	10.7	16.4	-7.7	2	-39.9	-32.2	6.2
2436.75	10.4	16.4	-8	2	-40.2	-32.2	7.4
2436.80	10.5	16.4	-7.9	2	-40.1	-32.2	7.3
2436.85	10.7	16.4	-7.7	2	-39.9	-32.2	6.9
2436.90	10.8	16.4	-7.6	2	-39.8	-32.2	6.8
2436.95	10.3	16.4	-8.1	2	-40.3	-32.2	7.2
2437.00	10.4	16.4	-8	2	-40.2	-32.2	5.7
2437.05	10.4	16.4	-8	2	-40.2	-32.2	6.2
2437.10	10.5	16.4	-7.9	2	-40.1	-32.2	5.6
2437.15	10.5	16.4	-7.9	2	-40.1	-32.2	6.8
2437.20	10.5	16.4	-7.9	2	-40.1	-32.2	7.2
2437.25	10.7	16.4	-7.7	2	-39.9	-32.2	6.2

2437.30	10.8	16.4	-7.6	2	-39.8	-32.2	5.6
2437.35	11	16.4	-7.4	2	-39.6	-32.2	6.8
2437.40	11.1	16.4	-7.3	2	-39.5	-32.2	7.2
2437.45	11.1	16.4	-7.3	2	-39.5	-32.2	7
2437.50	11	16.4	-7.4	2	-39.6	-32.2	6.9
2437.55	11	16.4	-7.4	2	-39.6	-32.2	7.2
2437.60	10.8	16.4	-7.6	2	-39.8	-32.2	6.8
2437.65	10.8	16.4	-7.6	2	-39.8	-32.2	7.4
2437.70	10.7	16.4	-7.7	2	-39.9	-32.2	6.8
2437.75	10.8	16.4	-7.6	2	-39.8	-32.2	7.3
2437.80	10.7	16.4	-7.7	2	-39.9	-32.2	6.7
2437.85	10.7	16.4	-7.7	2	-39.9	-32.2	6.8
2437.90	10	16.4	-8.4	2	-40.6	-32.2	4.2
2437.95	9.8	16.4	-8.6	2	-40.8	-32.2	3.5
2438.00	10.7	16.4	-7.7	2	-39.9	-32.2	4.3
2438.05	10.7	16.4	-7.7	2	-39.9	-32.2	5.6
2438.10	10.6	16.4	-7.8	2	-40	-32.2	6.2
2438.15	10.5	16.4	-7.9	2	-40.1	-32.2	4.3
2438.20	10.5	16.4	-7.9	2	-40.1	-32.2	5.7
2438.25	10.8	16.4	-7.6	2	-39.8	-32.2	5.6
2438.30	10.8	16.4	-7.6	2	-39.8	-32.2	6.8
2438.35	10.6	16.4	-7.8	2	-40	-32.2	7.2
2438.40	10.6	16.4	-7.8	2	-40	-32.2	6.8
2438.45	10.6	16.4	-7.8	2	-40	-32.2	6.8
2438.50	10.6	16.4	-7.8	2	-40	-32.2	5.4
2438.55	10.5	16.4	-7.9	2	-40.1	-32.2	4.3
2438.60	10.5	16.4	-7.9	2	-40.1	-32.2	6.8
2438.65	10.5	16.4	-7.9	2	-40.1	-32.2	7.2
2438.70	11	16.4	-7.4	2	-39.6	-32.2	7.1
2438.75	10.8	16.4	-7.6	2	-39.8	-32.2	7.3
2438.80	10.7	16.4	-7.7	2	-39.9	-32.2	5.2
2438.85	10.4	16.4	-8	2	-40.2	-32.2	6.8
2438.90	10.1	16.4	-8.3	2	-40.5	-32.2	7.2
2438.95	10.2	16.4	-8.2	2	-40.4	-32.2	6.8
2439.00	10.3	16.4	-8.1	2	-40.3	-32.2	7.2
2439.05	10.3	16.4	-8.1	2	-40.3	-32.2	6.8

2439.10	10.5	16.4	-7.9	2	-40.1	-32.2	6.5
2439.15	10.6	16.4	-7.8	2	-40	-32.2	5.6
2439.20	10.5	16.4	-7.9	2	-40.1	-32.2	6.2
2439.25	10.6	16.4	-7.8	2	-40	-32.2	5.6
2439.30	10.6	16.4	-7.8	2	-40	-32.2	6.8
2439.35	10.6	16.4	-7.8	2	-40	-32.2	7.6
2439.40	10.8	16.4	-7.6	2	-39.8	-32.2	7.2
2439.45	10.6	16.4	-7.8	2	-40	-32.2	
2439.50	10.8	16.4	-7.6	2	-39.8	-32.2	
2439.55	10.5	16.4	-7.9	2	-40.1	-32.2	
2439.60	10.6	16.4	-7.8	2	-40	-32.2	
2439.65	10.6	16.4	-7.8	2	-40	-32.2	
2439.70	10.6	16.4	-7.8	2	-40	-32.2	
2439.75	10.6	16.4	-7.8	2	-40	-32.2	
2439.80	10.7	16.4	-7.7	2	-39.9	-32.2	
2439.85	10.7	16.4	-7.7	2	-39.9	-32.2	
2439.90	10.9	16.4	-7.5	2	-39.7	-32.2	
2439.95	11.2	16.4	-7.2	2	-39.4	-32.2	
2440.00	11.4	16.4	-7	2	-39.2	-32.2	7.7
2440.05	11.4	16.4	-7	2	-39.2	-32.2	7.2
2440.10	11.5	16.4	-6.9	2	-39.1	-32.2	6.9
2440.15	11.4	16.4	-7	2	-39.2	-32.2	6.8
2440.20	11.5	16.4	-6.9	2	-39.1	-32.2	6.5
2440.25	11.5	16.4	-6.9	2	-39.1	-32.2	6.8
2440.30	11.6	16.4	-6.8	2	-39	-32.2	6.5
2440.35	11.6	16.4	-6.8	2	-39	-32.2	6.2
2440.40	11.7	16.4	-6.7	2	-38.9	-32.2	5.6
2440.45	11.7	16.4	-6.7	2	-38.9	-32.2	5.4
2440.50	11.8	16.4	-6.6	2	-38.8	-32.2	5.6
2440.55	11.7	16.4	-6.7	2	-38.9	-32.2	4.8
2440.60	11.8	16.4	-6.6	2	-38.8	-32.2	3.4
2440.65	11.7	16.4	-6.7	2	-38.9	-32.2	6.7
2440.70	11.6	16.4	-6.8	2	-39	-32.2	6.1
2440.75	12	16.4	-6.4	2	-38.6	-32.2	5.6
2440.80	12.2	16.4	-6.2	2	-38.4	-32.2	5.1
2440.85	12.1	16.4	-6.3	2	-38.5	-32.2	6.2

2440.90	12.1	16.4	-6.3	2	-38.5	-32.2	5.6
2440.95	12	16.4	-6.4	2	-38.6	-32.2	7
2441.00	12	16.4	-6.4	2	-38.6	-32.2	7.1
2441.05	11.9	16.4	-6.5	2	-38.7	-32.2	5.8
2441.10	11.9	16.4	-6.5	2	-38.7	-32.2	6.2
2441.15	11.9	16.4	-6.5	2	-38.7	-32.2	5.3
2441.20	12	16.4	-6.4	2	-38.6	-32.2	5.6
2441.25	12.6	16.4	-5.8	2	-38	-32.2	6.2
2441.30	12.7	16.4	-5.7	2	-37.9	-32.2	7.2
2441.35	13	16.4	-5.4	2	-37.6	-32.2	5.1
2441.40	13.1	16.4	-5.3	2	-37.5	-32.2	6.8
2441.45	13	16.4	-5.4	2	-37.6	-32.2	6.5
2441.50	12.9	16.4	-5.5	2	-37.7	-32.2	6.7
2441.55	13	16.4	-5.4	2	-37.6	-32.2	5.8
2441.60	13.1	16.4	-5.3	2	-37.5	-32.2	6.2
2441.65	13.1	16.4	-5.3	2	-37.5	-32.2	6.8
2441.70	13.1	16.4	-5.3	2	-37.5	-32.2	2.2
2441.75	13.2	16.4	-5.2	2	-37.4	-32.2	4.6
2441.80	13.3	16.4	-5.1	2	-37.3	-32.2	6.2
2441.85	13.4	16.4	-5	2	-37.2	-32.2	5.4
2441.90	13.5	16.4	-4.9	2	-37.1	-32.2	6.8
2441.95	13.6	16.4	-4.8	2	-37	-32.2	6.2
2442.00	13.7	16.4	-4.7	2	-36.9	-32.2	5.6
2442.05	13.7	16.4	-4.7	2	-36.9	-32.2	6.8
2442.10	14.7	16.4	-3.7	2	-35.9	-32.2	4.2
2442.15	14.6	16.4	-3.8	2	-36	-32.2	5.9
2442.20	14.6	16.4	-3.8	2	-36	-32.2	4.4
2442.25	14.5	16.4	-3.9	2	-36.1	-32.2	6.6
2442.30	14.4	16.4	-4	2	-36.2	-32.2	7.1
2442.35	14.2	16.4	-4.2	2	-36.4	-32.2	5.6
2442.40	14.6	16.4	-3.8	2	-36	-32.2	6.4
2442.45	14.7	16.4	-3.7	2	-35.9	-32.2	6.3
2442.50	15	16.4	-3.4	2	-35.6	-32.2	6.9
2442.55	15.4	16.4	-3	2	-35.2	-32.2	7.2
2442.60	15.5	16.4	-2.9	2	-35.1	-32.2	6.2
2442.65	15.7	16.4	-2.7	2	-34.9	-32.2	5.4

2442.70	15.8	16.4	-2.6	2	-34.8	-32.2	5.1
2442.75	15.9	16.4	-2.5	2	-34.7	-32.2	4.3
2442.80	16	16.4	-2.4	2	-34.6	-32.2	6.2
2442.85	16	16.4	-2.4	2	-34.6	-32.2	5.8
2442.90	16.1	16.4	-2.3	2	-34.5	-32.2	7.2
2442.95	16.3	16.4	-2.1	2	-34.3	-32.2	6.3
2443.00	16.4	16.4	-2	2	-34.2	-32.2	5.7
2443.05	16.5	16.4	-1.9	2	-34.1	-32.2	6.5
2443.10	16.6	16.4	-1.8	2	-34	-32.2	5.5
2443.15	16.8	16.4	-1.6	2	-33.8	-32.2	5.9
2443.20	16.8	16.4	-1.6	2	-33.8	-32.2	6.4
2443.25	16.9	16.4	-1.5	2	-33.7	-32.2	6.7
2443.30	16.9	16.4	-1.5	2	-33.7	-32.2	6.2
2443.35	17.1	16.4	-1.3	2	-33.5	-32.2	5.4
2443.40	17.2	16.4	-1.2	2	-33.4	-32.2	5.1
2443.45	17.6	16.4	-0.8	2	-33	-32.2	5.6
2443.50	17.7	16.4	-0.7	2	-32.9	-32.2	4.8
2443.55	18.1	16.4	-0.3	2	-32.5	-32.2	6.8
2443.60	18.2	16.4	-0.2	2	-32.4	-32.2	4.3
2443.65	18.4	16.4	0	2	-32.2	-32.2	4.2
2443.70	18.4	16.4	0	2	-32.2	-32.2	5.6
2443.75	18.6	16.4	0.2	2	-32	-32.2	6.7
2443.80	18.6	16.4	0.2	2	-32	-32.2	7.8
2443.85	18.7	16.4	0.3	2	-31.9	-32.2	5.4
2443.90	19.5	16.4	1.1	2	-31.1	-32.2	4.9
2443.95	19.6	16.4	1.2	2	-31	-32.2	7
2444.00	19.8	16.4	1.4	2	-30.8	-32.2	5.6
2444.05	19.8	16.4	1.4	2	-30.8	-32.2	6.8
2444.10	19.7	16.4	1.3	2	-30.9	-32.2	5.3
2444.15	19.7	16.4	1.3	2	-30.9	-32.2	5.9
2444.20	19.8	16.4	1.4	2	-30.8	-32.2	5.2
2444.25	19.7	16.4	1.3	2	-30.9	-32.2	6.3
2444.30	19.7	16.4	1.3	2	-30.9	-32.2	4.8
2444.35	19.7	16.4	1.3	2	-30.9	-32.2	5.4
2444.40	20.2	16.4	1.8	2	-30.4	-32.2	4.7
2444.45	20.3	16.4	1.9	2	-30.3	-32.2	5.9

2444.50	20.6	16.4	2.2	2	-30	-32.2	7
2444.55	20.7	16.4	2.3	2	-29.9	-32.2	6.7
2444.60	20.7	16.4	2.3	2	-29.9	-32.2	4.7
2444.65	20.7	16.4	2.3	2	-29.9	-32.2	4.8
2444.70	20.7	16.4	2.3	2	-29.9	-32.2	6
2444.75	20.8	16.4	2.4	2	-29.8	-32.2	6.1
2444.80	20.8	16.4	2.4	2	-29.8	-32.2	5.9
2444.85	20.8	16.4	2.4	2	-29.8	-32.2	6.2
2444.90	20.7	16.4	2.3	2	-29.9	-32.2	7.2
2444.95	20.7	16.4	2.3	2	-29.9	-32.2	6.5
2445.00	20.6	16.4	2.2	2	-30	-32.2	6.7
2445.05	20.7	16.4	2.3	2	-29.9	-32.2	6.3
2445.10	20.9	16.4	2.5	2	-29.7	-32.2	6.2
2445.15	20.8	16.4	2.4	2	-29.8	-32.2	5.4
2445.20	20.7	16.4	2.3	2	-29.9	-32.2	5.2
2445.25	20.4	16.4	2	2	-30.2	-32.2	6
2445.30	20.1	16.4	1.7	2	-30.5	-32.2	5.6
2445.35	20.1	16.4	1.7	2	-30.5	-32.2	6.4
2445.40	20.1	16.4	1.7	2	-30.5	-32.2	6.2
2445.45	20.4	16.4	2	2	-30.2	-32.2	6.7
2445.50	20.5	16.4	2.1	2	-30.1	-32.2	7.3
Processing Gain (dB) @20th Percentile=				10.6			

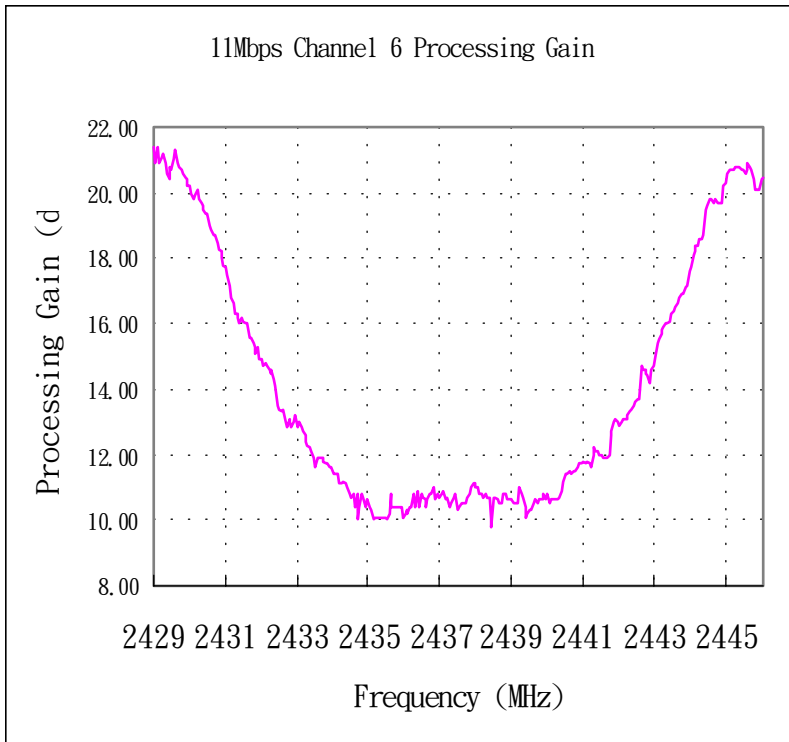

Gp=(S/N)o+Mj+Lsys							
Freq. (MHz)	Gp (dB)	(S/N)o (dB)	Mj = J/S (dB)	Lsys (dB)	Jammer (dBm)	Lvl (dBm)	FE R
2453.50	23.2	16.4	4.8	2	-27.2	-32	7.4
2453.55	23	16.4	4.6	2	-27.4	-32	5.8
2453.60	22.9	16.4	4.5	2	-27.5	-32	6.2
2453.65	22.5	16.4	4.1	2	-27.9	-32	6.4
2453.70	22.4	16.4	4	2	-28	-32	6.3
2453.75	22.3	16.4	3.9	2	-28.1	-32	5.8
2453.80	22.2	16.4	3.8	2	-28.2	-32	6.5
2453.85	22.3	16.4	3.9	2	-28.1	-32	6.9
2453.90	22.8	16.4	4.4	2	-27.6	-32	7.8
2453.95	22.6	16.4	4.2	2	-27.8	-32	7.2
2454.00	22.9	16.4	4.5	2	-27.5	-32	7.8
2454.05	22.7	16.4	4.3	2	-27.7	-32	5.8
2454.10	22.7	16.4	4.3	2	-27.7	-32	5.3
2454.15	22.5	16.4	4.1	2	-27.9	-32	6.2
2454.20	22.7	16.4	4.3	2	-27.7	-32	5.8
2454.25	22.5	16.4	4.1	2	-27.9	-32	6.2
2454.30	21.4	16.4	3	2	-29	-32	5.1
2454.35	21.4	16.4	3	2	-29	-32	6.2
2454.40	21.2	16.4	2.8	2	-29.2	-32	5.8
2454.45	21.2	16.4	2.8	2	-29.2	-32	5.8
2454.50	20.9	16.4	2.5	2	-29.5	-32	7.5
2454.55	20.8	16.4	2.4	2	-29.6	-32	6.3
2454.60	20.7	16.4	2.3	2	-29.7	-32	6.5
2454.65	20.6	16.4	2.2	2	-29.8	-32	5.8
2454.70	20.7	16.4	2.3	2	-29.7	-32	8.3
2454.75	20.6	16.4	2.2	2	-29.8	-32	6.2
2454.80	20.3	16.4	1.9	2	-30.1	-32	5.6
2454.85	20.2	16.4	1.8	2	-30.2	-32	6.8
2454.90	20.2	16.4	1.8	2	-30.2	-32	7.5
2454.95	20.2	16.4	1.8	2	-30.2	-32	6.8
2455.00	20.2	16.4	1.8	2	-30.2	-32	7.8
2455.05	20.1	16.4	1.7	2	-30.3	-32	6.5
2455.10	19.9	16.4	1.5	2	-30.5	-32	6

2455.15	19.8	16.4	1.4	2	-30.6	-32	6.8
2455.20	19.5	16.4	1.1	2	-30.9	-32	7
2455.25	19.5	16.4	1.1	2	-30.9	-32	6.5
2455.30	19.2	16.4	0.8	2	-31.2	-32	6.3
2455.35	19.1	16.4	0.7	2	-31.3	-32	6.8
2455.40	18.9	16.4	0.5	2	-31.5	-32	7.7
2455.45	18.3	16.4	-0.1	2	-32.1	-32	5.8
2455.50	18.3	16.4	-0.1	2	-32.1	-32	6.2
2455.55	18.2	16.4	-0.2	2	-32.2	-32	6.8
2455.60	17.9	16.4	-0.5	2	-32.5	-32	5.2
2455.65	17.5	16.4	-0.9	2	-32.9	-32	5.6
2455.70	16.7	16.4	-1.7	2	-33.7	-32	6.3
2455.75	17.3	16.4	-1.1	2	-33.1	-32	5.8
2455.80	17.1	16.4	-1.3	2	-33.3	-32	6.8
2455.85	16.9	16.4	-1.5	2	-33.5	-32	5.2
2455.90	16.9	16.4	-1.5	2	-33.5	-32	6.2
2455.95	16.8	16.4	-1.6	2	-33.6	-32	6.4
2456.00	16.7	16.4	-1.7	2	-33.7	-32	5.8
2456.05	16.5	16.4	-1.9	2	-33.9	-32	6.2
2456.10	16.3	16.4	-2.1	2	-34.1	-32	5.9
2456.15	16.2	16.4	-2.2	2	-34.2	-32	5.8
2456.20	16	16.4	-2.4	2	-34.4	-32	6.2
2456.25	16	16.4	-2.4	2	-34.4	-32	5.6
2456.30	16.6	16.4	-1.8	2	-33.8	-32	4.2
2456.35	16.3	16.4	-2.1	2	-34.1	-32	5.1
2456.40	15.9	16.4	-2.5	2	-34.5	-32	6.3
2456.45	15.2	16.4	-3.2	2	-35.2	-32	4.9
2456.50	16.5	16.4	-1.9	2	-33.9	-32	5.1
2456.55	15.6	16.4	-2.8	2	-34.8	-32	5.8
2456.60	14.8	16.4	-3.6	2	-35.6	-32	6.4
2456.65	15.1	16.4	-3.3	2	-35.3	-32	5.9
2456.70	15	16.4	-3.4	2	-35.4	-32	5.6
2456.75	15	16.4	-3.4	2	-35.4	-32	6.1
2456.80	15	16.4	-3.4	2	-35.4	-32	7
2456.85	14.8	16.4	-3.6	2	-35.6	-32	6
2456.90	14.7	16.4	-3.7	2	-35.7	-32	5.9

2456.95	14.6	16.4	-3.8	2	-35.8	-32	5.8
2457.00	14.5	16.4	-3.9	2	-35.9	-32	6
2457.05	14.3	16.4	-4.1	2	-36.1	-32	7.5
2457.10	14.7	16.4	-3.7	2	-35.7	-32	7.2
2457.15	14.3	16.4	-4.1	2	-36.1	-32	6.8
2457.20	14	16.4	-4.4	2	-36.4	-32	7.1
2457.25	14.1	16.4	-4.3	2	-36.3	-32	6.3
2457.30	14.9	16.4	-3.5	2	-35.5	-32	5.6
2457.35	14	16.4	-4.4	2	-36.4	-32	4.5
2457.40	13.8	16.4	-4.6	2	-36.6	-32	6.6
2457.45	13.8	16.4	-4.6	2	-36.6	-32	7.4
2457.50	13.7	16.4	-4.7	2	-36.7	-32	7
2457.55	13.7	16.4	-4.7	2	-36.7	-32	7.4
2457.60	13.6	16.4	-4.8	2	-36.8	-32	9
2457.65	13.5	16.4	-4.9	2	-36.9	-32	5.3
2457.70	13.4	16.4	-5	2	-37	-32	5.6
2457.75	12.9	16.4	-5.5	2	-37.5	-32	5.2
2457.80	12.9	16.4	-5.5	2	-37.5	-32	5.9
2457.85	12.7	16.4	-5.7	2	-37.7	-32	6.2
2457.90	12.8	16.4	-5.6	2	-37.6	-32	7.2
2457.95	12.8	16.4	-5.6	2	-37.6	-32	6.7
2458.00	12.7	16.4	-5.7	2	-37.7	-32	6.7
2458.05	12.8	16.4	-5.6	2	-37.6	-32	6.7
2458.10	12.7	16.4	-5.7	2	-37.7	-32	6.1
2458.15	12.8	16.4	-5.6	2	-37.6	-32	5.7
2458.20	12.8	16.4	-5.6	2	-37.6	-32	7.2
2458.25	12.8	16.4	-5.6	2	-37.6	-32	6.6
2458.30	12.7	16.4	-5.7	2	-37.7	-32	6.4
2458.35	12.6	16.4	-5.8	2	-37.8	-32	6.6
2458.40	12.5	16.4	-5.9	2	-37.9	-32	5.2
2458.45	12.5	16.4	-5.9	2	-37.9	-32	5.6
2458.50	12.4	16.4	-6	2	-38	-32	5.4
2458.55	12.3	16.4	-6.1	2	-38.1	-32	6
2458.60	12.1	16.4	-6.3	2	-38.3	-32	5.7
2458.65	12.1	16.4	-6.3	2	-38.3	-32	6
2458.70	12	16.4	-6.4	2	-38.4	-32	5.8

2458.75	12.1	16.4	-6.3	2	-38.3	-32	6.2
2458.80	12.1	16.4	-6.3	2	-38.3	-32	7.1
2458.85	11.8	16.4	-6.6	2	-38.6	-32	5.6
2458.90	11.6	16.4	-6.8	2	-38.8	-32	4.8
2458.95	11.6	16.4	-6.8	2	-38.8	-32	6.7
2459.00	11.5	16.4	-6.9	2	-38.9	-32	7.2
2459.05	11.3	16.4	-7.1	2	-39.1	-32	6.8
2459.10	11.2	16.4	-7.2	2	-39.2	-32	6.3
2459.15	11.2	16.4	-7.2	2	-39.2	-32	6.5
2459.20	11.3	16.4	-7.1	2	-39.1	-32	7.2
2459.25	11.2	16.4	-7.2	2	-39.2	-32	6.6
2459.30	11.1	16.4	-7.3	2	-39.3	-32	4.8
2459.35	11.2	16.4	-7.2	2	-39.2	-32	6.8
2459.40	11.1	16.4	-7.3	2	-39.3	-32	5.8
2459.45	11.2	16.4	-7.2	2	-39.2	-32	6.3
2459.50	11.2	16.4	-7.2	2	-39.2	-32	5.3
2459.55	11.3	16.4	-7.1	2	-39.1	-32	7.2
2459.60	11.2	16.4	-7.2	2	-39.2	-32	6.6
2459.65	11.3	16.4	-7.1	2	-39.1	-32	6.5
2459.70	11.3	16.4	-7.1	2	-39.1	-32	6.4
2459.75	11.3	16.4	-7.1	2	-39.1	-32	7.2
2459.80	11.2	16.4	-7.2	2	-39.2	-32	6.8
2459.85	11.2	16.4	-7.2	2	-39.2	-32	7.1
2459.90	11.2	16.4	-7.2	2	-39.2	-32	6.8
2459.95	11.2	16.4	-7.2	2	-39.2	-32	5.3
2460.00	11.1	16.4	-7.3	2	-39.3	-32	7.7
2460.05	11.1	16.4	-7.3	2	-39.3	-32	4.8
2460.10	11.2	16.4	-7.2	2	-39.2	-32	6.2
2460.15	11.3	16.4	-7.1	2	-39.1	-32	5.6
2460.20	11.4	16.4	-7	2	-39	-32	4.6
2460.25	11.4	16.4	-7	2	-39	-32	6.5
2460.30	11.4	16.4	-7	2	-39	-32	5.5
2460.35	11.3	16.4	-7.1	2	-39.1	-32	6.5
2460.40	11.3	16.4	-7.1	2	-39.1	-32	6.3
2460.45	11.3	16.4	-7.1	2	-39.1	-32	6.7
2460.50	11.5	16.4	-6.9	2	-38.9	-32	5.4

2460.55	11.3	16.4	-7.1	2	-39.1	-32	5.6
2460.60	11.1	16.4	-7.3	2	-39.3	-32	3.6
2460.65	11.4	16.4	-7	2	-39	-32	5.6
2460.70	11.7	16.4	-6.7	2	-38.7	-32	6.1
2460.75	11.7	16.4	-6.7	2	-38.7	-32	5.9
2460.80	11.8	16.4	-6.6	2	-38.6	-32	6
2460.85	11.7	16.4	-6.7	2	-38.7	-32	5.8
2460.90	11.5	16.4	-6.9	2	-38.9	-32	4.3
2460.95	11.7	16.4	-6.7	2	-38.7	-32	5.2
2461.00	11.8	16.4	-6.6	2	-38.6	-32	5.8
2461.05	11.8	16.4	-6.6	2	-38.6	-32	4.7
2461.10	11.7	16.4	-6.7	2	-38.7	-32	5.4
2461.15	11.7	16.4	-6.7	2	-38.7	-32	5.2
2461.20	11.7	16.4	-6.7	2	-38.7	-32	4.6
2461.25	11.7	16.4	-6.7	2	-38.7	-32	4.8
2461.30	11.6	16.4	-6.8	2	-38.8	-32	4.5
2461.35	11.7	16.4	-6.7	2	-38.7	-32	5.8
2461.40	11.8	16.4	-6.6	2	-38.6	-32	5.5
2461.45	11.8	16.4	-6.6	2	-38.6	-32	6.4
2461.50	11.9	16.4	-6.5	2	-38.5	-32	6.8
2461.55	11.9	16.4	-6.5	2	-38.5	-32	6
2461.60	12.1	16.4	-6.3	2	-38.3	-32	5.8
2461.65	11.9	16.4	-6.5	2	-38.5	-32	6.4
2461.70	12.1	16.4	-6.3	2	-38.3	-32	7.5
2461.75	11.9	16.4	-6.5	2	-38.5	-32	7.2
2461.80	11.7	16.4	-6.7	2	-38.7	-32	7.8
2461.85	11.6	16.4	-6.8	2	-38.8	-32	6.7
2461.90	11.4	16.4	-7	2	-39	-32	7.6
2461.95	11.6	16.4	-6.8	2	-38.8	-32	6.2
2462.00	11.4	16.4	-7	2	-39	-32	5.8
2462.05	11.4	16.4	-7	2	-39	-32	6.5
2462.10	11	16.4	-7.4	2	-39.4	-32	5.7
2462.15	11.4	16.4	-7	2	-39	-32	5.8
2462.20	11.6	16.4	-6.8	2	-38.8	-32	6.2
2462.25	11.7	16.4	-6.7	2	-38.7	-32	6.4
2462.30	11.9	16.4	-6.5	2	-38.5	-32	6.2

2462.35	11.8	16.4	-6.6	2	-38.6	-32	5.7
2462.40	11.7	16.4	-6.7	2	-38.7	-32	4.5
2462.45	11.8	16.4	-6.6	2	-38.6	-32	6.8
2462.50	11.9	16.4	-6.5	2	-38.5	-32	7.4
2462.55	11.9	16.4	-6.5	2	-38.5	-32	6.5
2462.60	11.9	16.4	-6.5	2	-38.5	-32	6.3
2462.65	11.9	16.4	-6.5	2	-38.5	-32	6.7
2462.70	11.9	16.4	-6.5	2	-38.5	-32	5.8
2462.75	11.8	16.4	-6.6	2	-38.6	-32	5.8
2462.80	11.8	16.4	-6.6	2	-38.6	-32	6.8
2462.85	11.9	16.4	-6.5	2	-38.5	-32	5.4
2462.90	12	16.4	-6.4	2	-38.4	-32	4.8
2462.95	12.1	16.4	-6.3	2	-38.3	-32	5.8
2463.00	12.2	16.4	-6.2	2	-38.2	-32	6
2463.05	12.2	16.4	-6.2	2	-38.2	-32	6.9
2463.10	12	16.4	-6.4	2	-38.4	-32	7.3
2463.15	12	16.4	-6.4	2	-38.4	-32	5.7
2463.20	11.8	16.4	-6.6	2	-38.6	-32	5.9
2463.25	11.8	16.4	-6.6	2	-38.6	-32	6.2
2463.30	11.8	16.4	-6.6	2	-38.6	-32	5.6
2463.35	11.9	16.4	-6.5	2	-38.5	-32	6.2
2463.40	11.7	16.4	-6.7	2	-38.7	-32	5.2
2463.45	11.7	16.4	-6.7	2	-38.7	-32	6.2
2463.50	11.6	16.4	-6.8	2	-38.8	-32	7.5
2463.55	11.6	16.4	-6.8	2	-38.8	-32	6.3
2463.60	11.7	16.4	-6.7	2	-38.7	-32	5.8
2463.65	11.7	16.4	-6.7	2	-38.7	-32	6.3
2463.70	11.7	16.4	-6.7	2	-38.7	-32	7.9
2463.75	11.8	16.4	-6.6	2	-38.6	-32	6.4
2463.80	11.8	16.4	-6.6	2	-38.6	-32	7.2
2463.85	11.6	16.4	-6.8	2	-38.8	-32	5.5
2463.90	11.4	16.4	-7	2	-39	-32	6.9
2463.95	11.4	16.4	-7	2	-39	-32	6.8
2464.00	11.3	16.4	-7.1	2	-39.1	-32	5.5
2464.05	11.4	16.4	-7	2	-39	-32	5.6
2464.10	11.5	16.4	-6.9	2	-38.9	-32	5.3

2464.15	11.6	16.4	-6.8	2	-38.8	-32	6.8
2464.20	11.6	16.4	-6.8	2	-38.8	-32	7.5
2464.25	11.6	16.4	-6.8	2	-38.8	-32	5.4
2464.30	11.5	16.4	-6.9	2	-38.9	-32	4.5
2464.35	11.6	16.4	-6.8	2	-38.8	-32	6.8
2464.40	11.8	16.4	-6.6	2	-38.6	-32	6.4
2464.45	11.6	16.4	-6.8	2	-38.8	-32	6.3
2464.50	11.5	16.4	-6.9	2	-38.9	-32	6.2
2464.55	11.6	16.4	-6.8	2	-38.8	-32	6.4
2464.60	11.8	16.4	-6.6	2	-38.6	-32	6.8
2464.65	11.7	16.4	-6.7	2	-38.7	-32	5.8
2464.70	11.7	16.4	-6.7	2	-38.7	-32	5.2
2464.75	11.8	16.4	-6.6	2	-38.6	-32	5.4
2464.80	12	16.4	-6.4	2	-38.4	-32	4.3
2464.85	12.1	16.4	-6.3	2	-38.3	-32	5.7
2464.90	12.2	16.4	-6.2	2	-38.2	-32	6.8
2464.95	12.3	16.4	-6.1	2	-38.1	-32	6.8
2465.00	12.4	16.4	-6	2	-38	-32	7.2
2465.05	12.4	16.4	-6	2	-38	-32	6.3
2465.10	12.3	16.4	-6.1	2	-38.1	-32	6.5
2465.15	12.5	16.4	-5.9	2	-37.9	-32	6.9
2465.20	12.6	16.4	-5.8	2	-37.8	-32	7.1
2465.25	12.4	16.4	-6	2	-38	-32	7.2
2465.30	12.4	16.4	-6	2	-38	-32	7
2465.35	12.6	16.4	-5.8	2	-37.8	-32	7.4
2465.40	12.6	16.4	-5.8	2	-37.8	-32	6.6
2465.45	12.7	16.4	-5.7	2	-37.7	-32	7
2465.50	12.8	16.4	-5.6	2	-37.6	-32	6.5
2465.55	12.9	16.4	-5.5	2	-37.5	-32	7.4
2465.60	13	16.4	-5.4	2	-37.4	-32	7
2465.65	13	16.4	-5.4	2	-37.4	-32	6.8
2465.70	13.1	16.4	-5.3	2	-37.3	-32	7.1
2465.75	13.2	16.4	-5.2	2	-37.2	-32	7.1
2465.80	13.2	16.4	-5.2	2	-37.2	-32	6.6
2465.85	13.2	16.4	-5.2	2	-37.2	-32	6.7
2465.90	13.1	16.4	-5.3	2	-37.3	-32	6.9

2465.95	13.1	16.4	-5.3	2	-37.3	-32	7.2
2466.00	13.1	16.4	-5.3	2	-37.3	-32	7.3
2466.05	13.2	16.4	-5.2	2	-37.2	-32	6.9
2466.10	13.3	16.4	-5.1	2	-37.1	-32	6.8
2466.15	13.4	16.4	-5	2	-37	-32	7
2466.20	13.5	16.4	-4.9	2	-36.9	-32	6.7
2466.25	13.7	16.4	-4.7	2	-36.7	-32	6.2
2466.30	13.8	16.4	-4.6	2	-36.6	-32	6.5
2466.35	14	16.4	-4.4	2	-36.4	-32	7.3
2466.40	14.2	16.4	-4.2	2	-36.2	-32	7.8
2466.45	14.2	16.4	-4.2	2	-36.2	-32	6.8
2466.50	14.3	16.4	-4.1	2	-36.1	-32	6.3
2466.55	14	16.4	-4.4	2	-36.4	-32	7.3
2466.60	14.1	16.4	-4.3	2	-36.3	-32	6.6
2466.65	14.1	16.4	-4.3	2	-36.3	-32	6.5
2466.70	14.2	16.4	-4.2	2	-36.2	-32	7.3
2466.75	14.2	16.4	-4.2	2	-36.2	-32	7.9
2466.80	14.3	16.4	-4.1	2	-36.1	-32	6.6
2466.85	14.5	16.4	-3.9	2	-35.9	-32	7.4
2466.90	14.6	16.4	-3.8	2	-35.8	-32	6.2
2466.95	14.9	16.4	-3.5	2	-35.5	-32	6.9
2467.00	15.1	16.4	-3.3	2	-35.3	-32	6.8
2467.05	15.3	16.4	-3.1	2	-35.1	-32	6.5
2467.10	15.4	16.4	-3	2	-35	-32	7.3
2467.15	16.3	16.4	-2.1	2	-34.1	-32	5.7
2467.20	15.9	16.4	-2.5	2	-34.5	-32	5.8
2467.25	15.7	16.4	-2.7	2	-34.7	-32	5.2
2467.30	16	16.4	-2.4	2	-34.4	-32	6.1
2467.35	16.3	16.4	-2.1	2	-34.1	-32	6.3
2467.40	16.1	16.4	-2.3	2	-34.3	-32	6.4
2467.45	16.6	16.4	-1.8	2	-33.8	-32	7.1
2467.50	17.2	16.4	-1.2	2	-33.2	-32	5.8
2467.55	16.5	16.4	-1.9	2	-33.9	-32	6.3
2467.60	16.9	16.4	-1.5	2	-33.5	-32	6.5
2467.65	17.3	16.4	-1.1	2	-33.1	-32	7.3
2467.70	17	16.4	-1.4	2	-33.4	-32	5.9

2467.75	17.2	16.4	-1.2	2	-33.2	-32	5.8
2467.80	17.3	16.4	-1.1	2	-33.1	-32	6.3
2467.85	17.8	16.4	-0.6	2	-32.6	-32	6.7
2467.90	17	16.4	-1.4	2	-33.4	-32	6.5
2467.95	17.6	16.4	-0.8	2	-32.8	-32	7.3
2468.00	17.3	16.4	-1.1	2	-33.1	-32	6.2
2468.05	17.8	16.4	-0.6	2	-32.6	-32	5.1
2468.10	17.9	16.4	-0.5	2	-32.5	-32	5.5
2468.15	18.6	16.4	0.2	2	-31.8	-32	5.7
2468.20	18.1	16.4	-0.3	2	-32.3	-32	6
2468.25	18.2	16.4	-0.2	2	-32.2	-32	5.9
2468.30	18.3	16.4	-0.1	2	-32.1	-32	6.1
2468.35	18.4	16.4	0	2	-32	-32	7.3
2468.40	18.5	16.4	0.1	2	-31.9	-32	7.1
2468.45	18.6	16.4	0.2	2	-31.8	-32	6.5
2468.50	18.5	16.4	0.1	2	-31.9	-32	6.3
2468.55	18.4	16.4	0	2	-32	-32	6.1
2468.60	19.4	16.4	1	2	-31	-32	5.5
2468.65	19.2	16.4	0.8	2	-31.2	-32	5.8
2468.70	19	16.4	0.6	2	-31.4	-32	5.6
2468.75	19.4	16.4	1	2	-31	-32	5.7
2468.80	19.3	16.4	0.9	2	-31.1	-32	5.7
2468.85	19.4	16.4	1	2	-31	-32	5.9
2468.90	19.5	16.4	1.1	2	-30.9	-32	5.6
2468.95	20.3	16.4	1.9	2	-30.1	-32	6.1
2469.00	20	16.4	1.6	2	-30.4	-32	6.4
2469.05	19.8	16.4	1.4	2	-30.6	-32	6.3
2469.10	20.8	16.4	2.4	2	-29.6	-32	5.6
2469.15	20.8	16.4	2.4	2	-29.6	-32	6.4
2469.20	20.8	16.4	2.4	2	-29.6	-32	7.4
2469.25	20.9	16.4	2.5	2	-29.5	-32	6.9
2469.30	21.2	16.4	2.8	2	-29.2	-32	6.7
2469.35	21.2	16.4	2.8	2	-29.2	-32	6.7
2469.40	21.2	16.4	2.8	2	-29.2	-32	6.7
2469.45	21.4	16.4	3	2	-29	-32	7.6
2469.50	21.6	16.4	3.2	2	-28.8	-32	7.7

2469.55	21.8	16.4	3.4	2	-28.6	-32	7.1
2469.60	21.8	16.4	3.4	2	-28.6	-32	6.3
2469.65	22	16.4	3.6	2	-28.4	-32	6.9
2469.70	21.9	16.4	3.5	2	-28.5	-32	6.7
2469.75	22	16.4	3.6	2	-28.4	-32	6.5
2469.80	22	16.4	3.6	2	-28.4	-32	7.1
2469.85	22	16.4	3.6	2	-28.4	-32	7.8
2469.90	22	16.4	3.6	2	-28.4	-32	7.4
2469.95	21.9	16.4	3.5	2	-28.5	-32	6.5
2470.00	22	16.4	3.6	2	-28.4	-32	6.5
2470.05	21.7	16.4	3.3	2	-28.7	-32	7
2470.10	21.9	16.4	3.5	2	-28.5	-32	6.7
2470.15	21.9	16.4	3.5	2	-28.5	-32	6.6
2470.20	21.9	16.4	3.5	2	-28.5	-32	7.8
2470.25	21.9	16.4	3.5	2	-28.5	-32	6.9
2470.30	22	16.4	3.6	2	-28.4	-32	6.5
2470.35	42.1	16.4	23.7	2	-8.3	-32	6.9
2470.40	22.1	16.4	3.7	2	-28.3	-32	6.7
2470.45	22.1	16.4	3.7	2	-28.3	-32	6.3
2470.50	22.3	16.4	3.9	2	-28.1	-32	7.1
Processing Gain (dB) @20th Percentile=				11.7			

