

PROPRIETARY NOTICE
 THIS DOCUMENT AND THE INFORMATION DISCLOSED HEREIN ARE PROPRIETARY DATA OF ACSS, LLC. NEITHER THIS DOCUMENT NOR THE INFORMATION CONTAINED HEREIN SHALL BE REPRODUCED, USED, OR DISCLOSED TO OTHERS WITHOUT THE WRITTEN AUTHORIZATION OF ACSS, LLC

NOTICE
 FREEDOM OF INFORMATION ACT (5 USC 552) AND DISCLOSURE OF CONFIDENTIAL INFORMATION GENERALLY (18 USC 1905)
 THIS DOCUMENT IS BEING FURNISHED IN CONFIDENCE BY ACSS, LLC. THE INFORMATION DISCLOSED HEREIN FALLS WITHIN EXEMPTION (b) (4) OF 5 USC 552 AND THE PROHIBITIONS OF 18 USC 1905.

REVISIONS	
CRNO.	DESCRIPTION
008133	INITIAL RELEASE

12-15-04

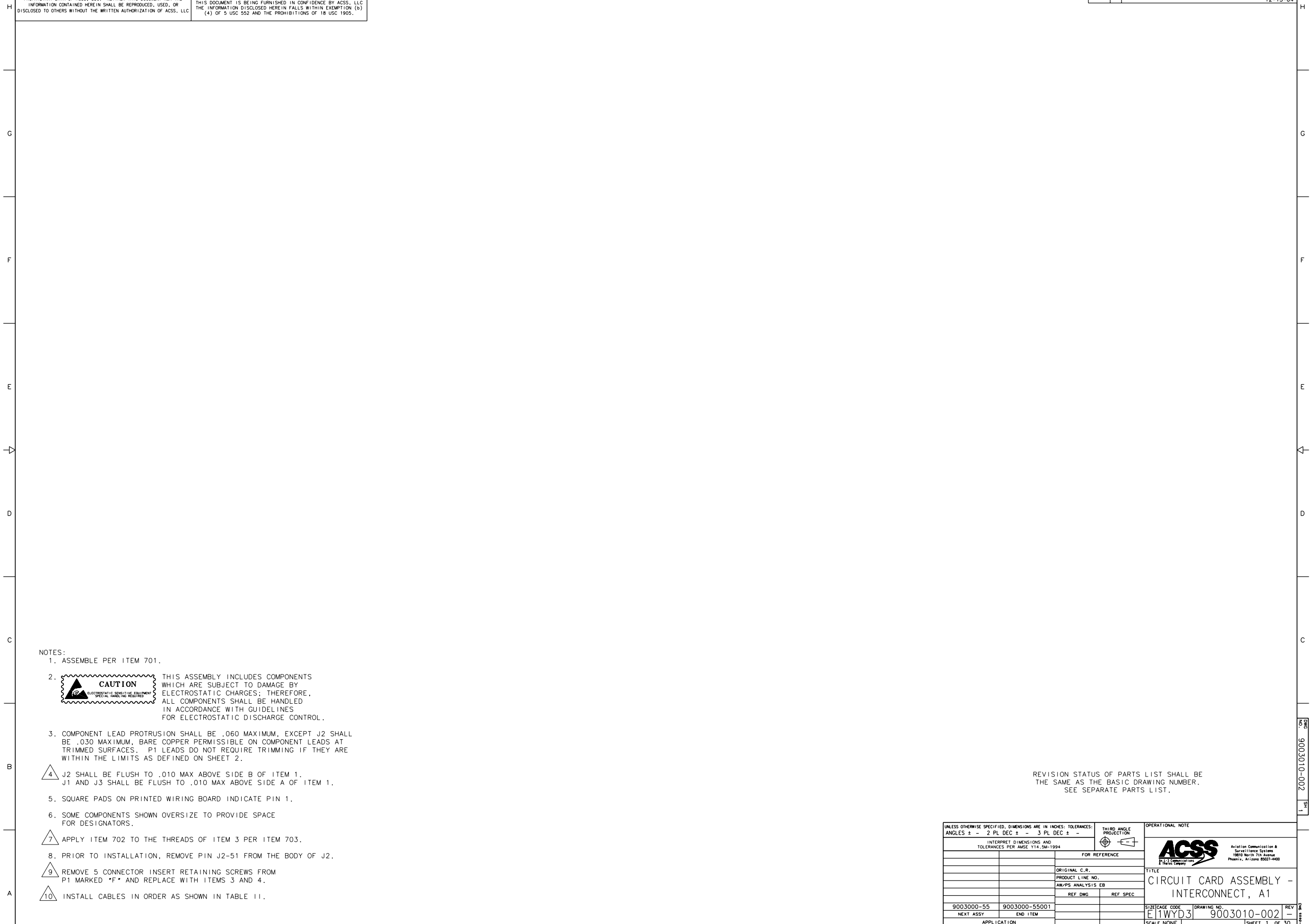



NOTES:

- ASSEMBLE PER ITEM 701.
- 
 THIS ASSEMBLY INCLUDES COMPONENTS WHICH ARE SUBJECT TO DAMAGE BY ELECTROSTATIC CHARGES; THEREFORE, ALL COMPONENTS SHALL BE HANDLED IN ACCORDANCE WITH GUIDELINES FOR ELECTROSTATIC DISCHARGE CONTROL.
- COMPONENT LEAD PROTRUSION SHALL BE .060 MAXIMUM, EXCEPT J2 SHALL BE .030 MAXIMUM. BARE COPPER PERMISSIBLE ON COMPONENT LEADS AT TRIMMED SURFACES. P1 LEADS DO NOT REQUIRE TRIMMING IF THEY ARE WITHIN THE LIMITS AS DEFINED ON SHEET 2.
- J2 SHALL BE FLUSH TO .010 MAX ABOVE SIDE B OF ITEM 1. J1 AND J3 SHALL BE FLUSH TO .010 MAX ABOVE SIDE A OF ITEM 1.
- SQUARE PADS ON PRINTED WIRING BOARD INDICATE PIN 1.
- SOME COMPONENTS SHOWN OVERSIZE TO PROVIDE SPACE FOR DESIGNATORS.
- APPLY ITEM 702 TO THE THREADS OF ITEM 3 PER ITEM 703.
- PRIOR TO INSTALLATION, REMOVE PIN J2-51 FROM THE BODY OF J2.
- REMOVE 5 CONNECTOR INSERT RETAINING SCREWS FROM P1 MARKED *F* AND REPLACE WITH ITEMS 3 AND 4.
- INSTALL CABLES IN ORDER AS SHOWN IN TABLE 11.

REVISION STATUS OF PARTS LIST SHALL BE THE SAME AS THE BASIC DRAWING NUMBER. SEE SEPARATE PARTS LIST.

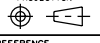
SH 1
 9003010-002

UNLESS OTHERWISE SPECIFIED, DIMENSIONS ARE IN INCHES: TOLERANCES: ANGLES ± - 2 PL DEC ± - 3 PL DEC ± -		THIRD ANGLE PROJECTION	OPERATIONAL NOTE	
INTERPRET DIMENSIONS AND TOLERANCES PER AMSE Y14.5M-1994				
FOR REFERENCE				
ORIGINAL C.R.	PRODUCT LINE NO.	REF. DWG.	REF. SPEC.	TITLE
AW/PS ANALYSIS EB				CIRCUIT CARD ASSEMBLY - INTERCONNECT, A1
9003000-55	9003000-55001			SIZE/CAGE CODE
NEXT ASSY	END ITEM			E11WYD3
APPLICATION				DRAWING NO. 9003010-002
				SCALE NONE
				REV 1 OF 30

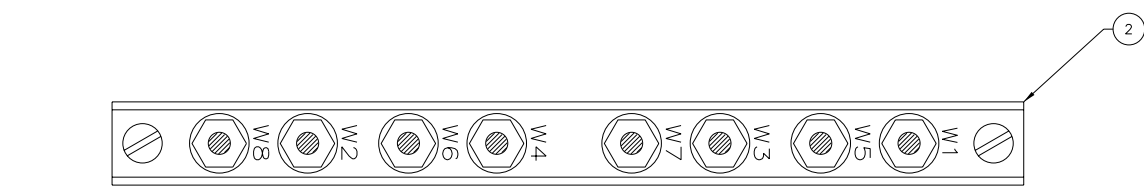
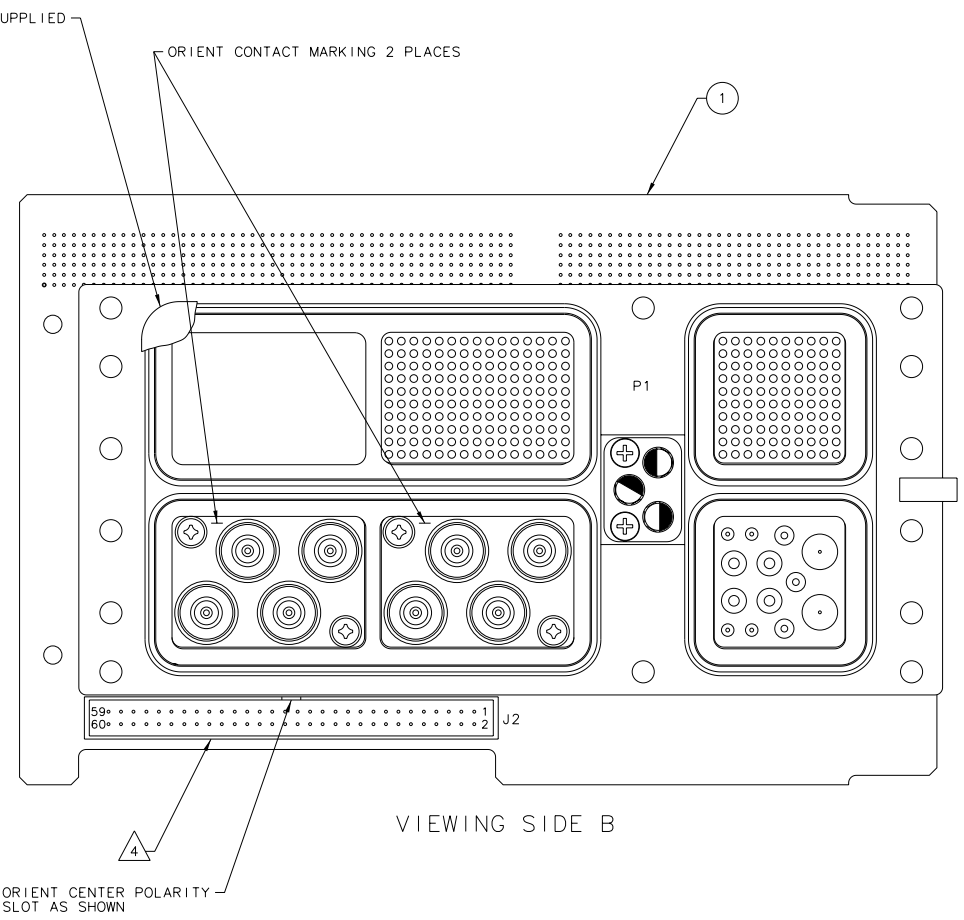
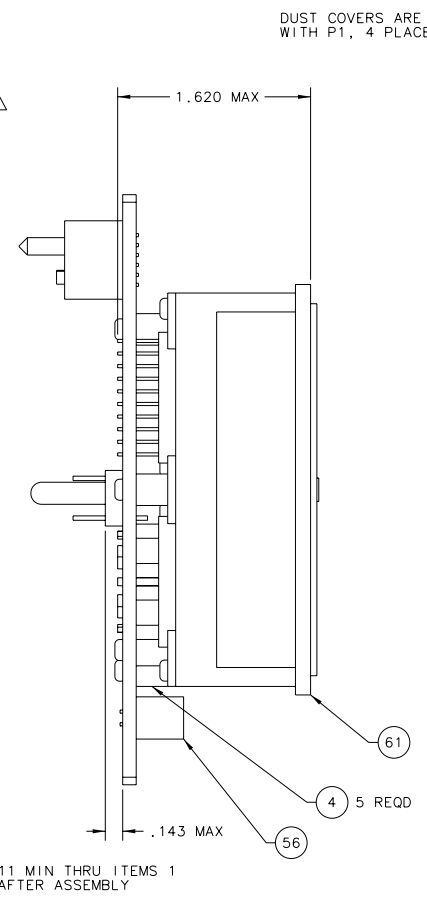
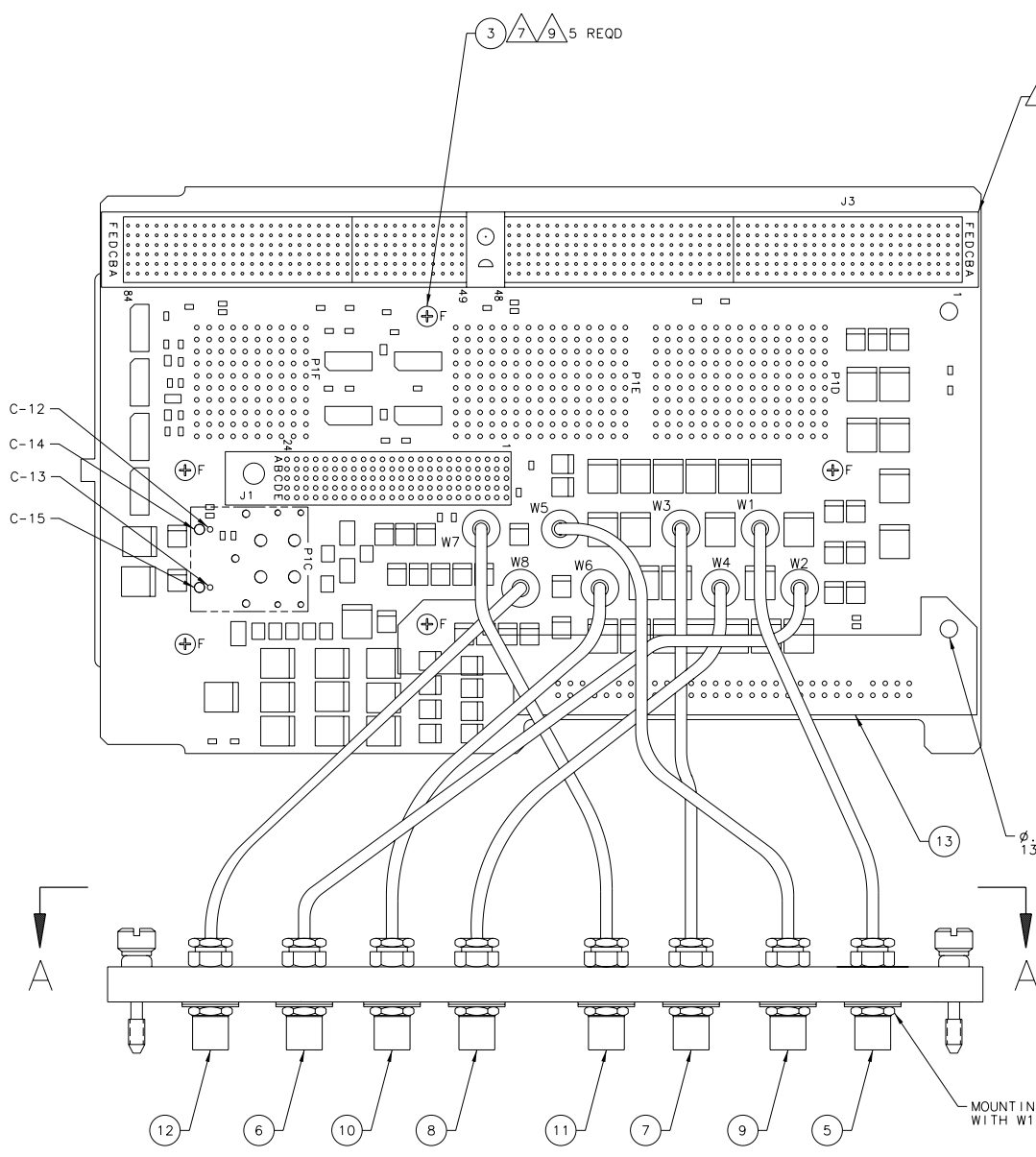

MOUNTING HARDWARE SUPPLIED WITH W1 THRU W8 CONNECTORS

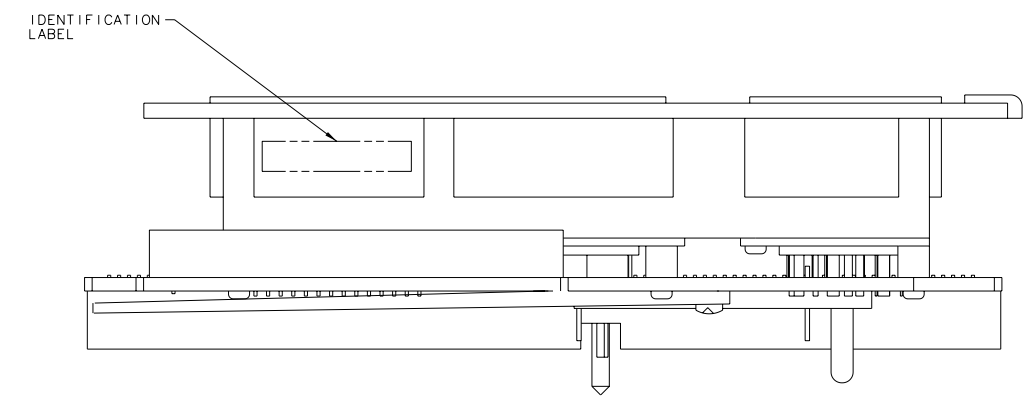

1	W8
2	W7
3	W6
4	W3
5	W4
6	W2
7	W5
8	W1

VIEW A-A

REVISIONS	
CRNO.	REV

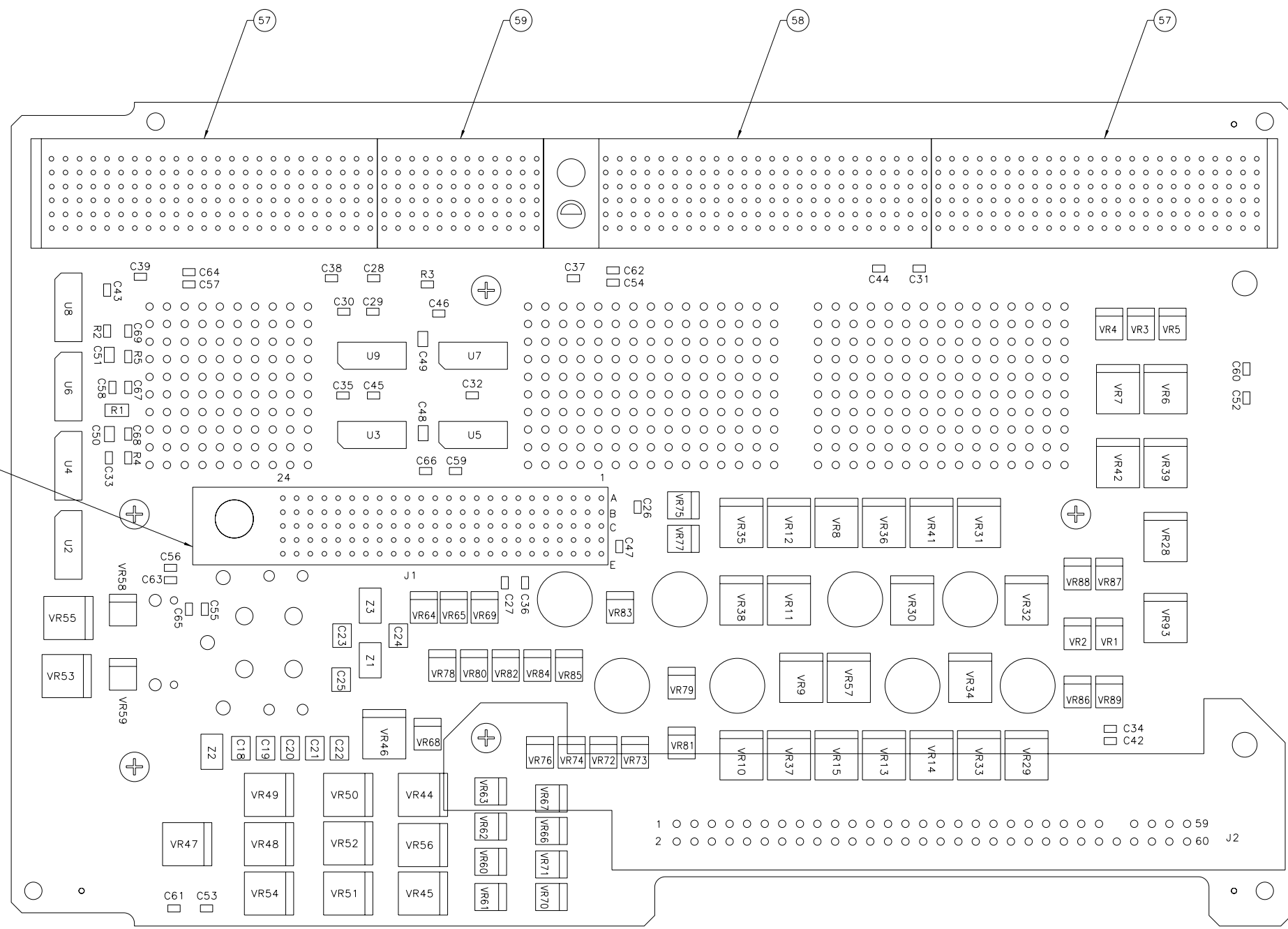

VIEWING SIDE A

	SEE FIRST SHEET FOR CONTRACT NUMBER, USE OR DISCLOSURE OF INFORMATION ON THIS SHEET IS SUBJECT TO THE RESTRICTIONS ON THE FIRST SHEET OF THIS DOCUMENT.	SIZE/CAGE CODE E11WYD3	DRAWING NO. 9003010-002	REV -
	SCALE 4/1	SHEET 3	REV 4	

9003010-002 SH 3

REVISIONS	
REV	DESCRIPTION

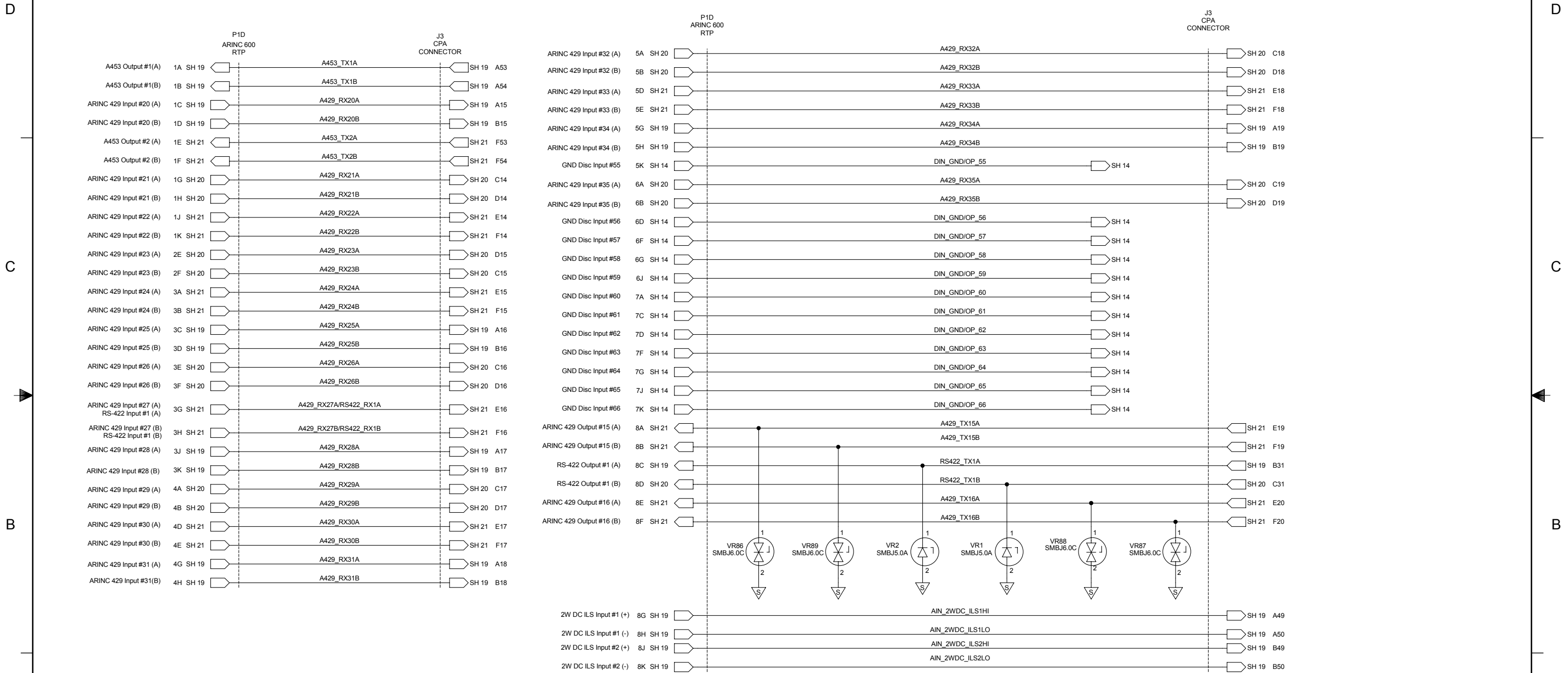

**ARINC 600 CONNECTOR
A1 REAR INTERCONNECT ASSEMBLY
SHEET NO. 1 OF 27**

COMPUTER GENERATED

ACSS	SEE FIRST SHEET FOR CONTRACT NUMBER. USE OR DISCLOSURE OF INFORMATION ON THIS SHEET IS SUBJECT TO THE RESTRICTIONS ON THE FIRST SHEET OF THIS DOCUMENT.	SIZE D	CAGE CODE 1WYD3	DWG. NO. 9003010-002	REV -
	SCALE: NONE	SHEET 04			

REVISIONS	
REV	DESCRIPTION

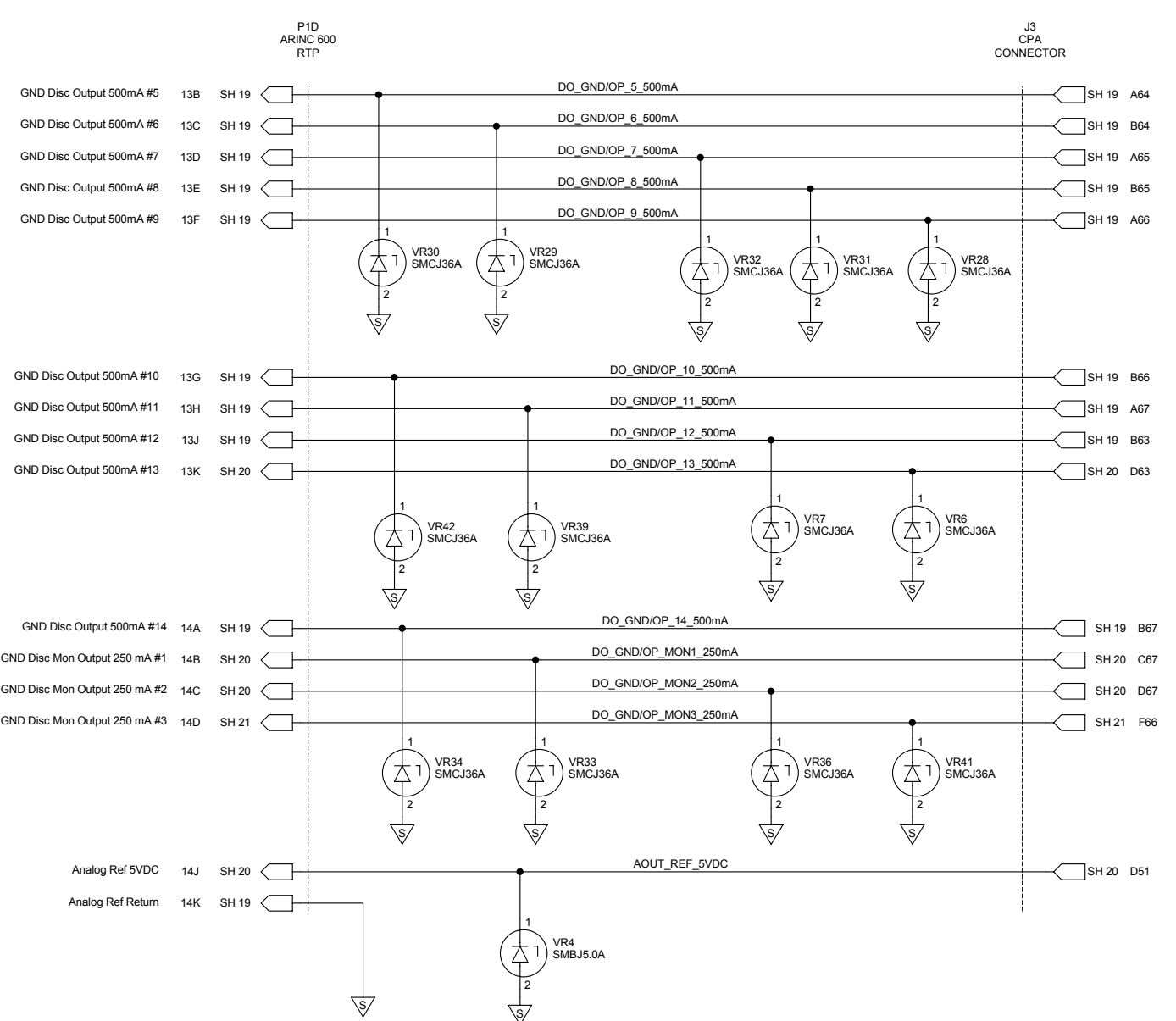
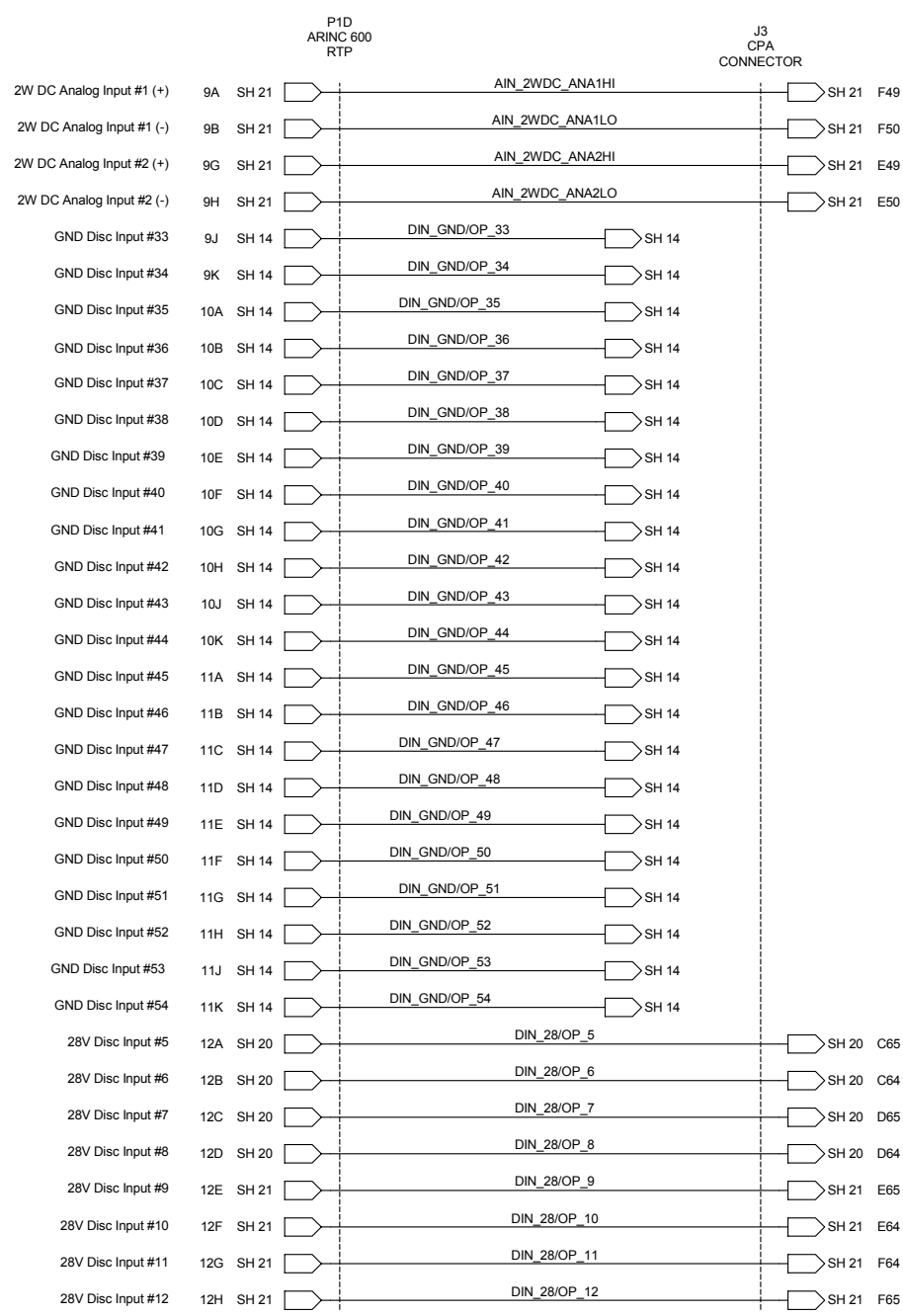

ARINC 600 CONNECTOR
 A1 REAR INTERCONNECT ASSEMBLY
 SHEET NO. 2 OF 27

COMPUTER GENERATED

ACSS	SEE FIRST SHEET FOR CONTRACT NUMBER. USE OR DISCLOSURE OF INFORMATION ON THIS SHEET IS SUBJECT TO THE RESTRICTIONS ON THE FIRST SHEET OF THIS DOCUMENT.	SIZE D	CAGE CODE 1WYD3	DWG. NO. 9003010-002	REV -
	SCALE: NONE	SHEET 05			

REVISIONS	
REV	DESCRIPTION

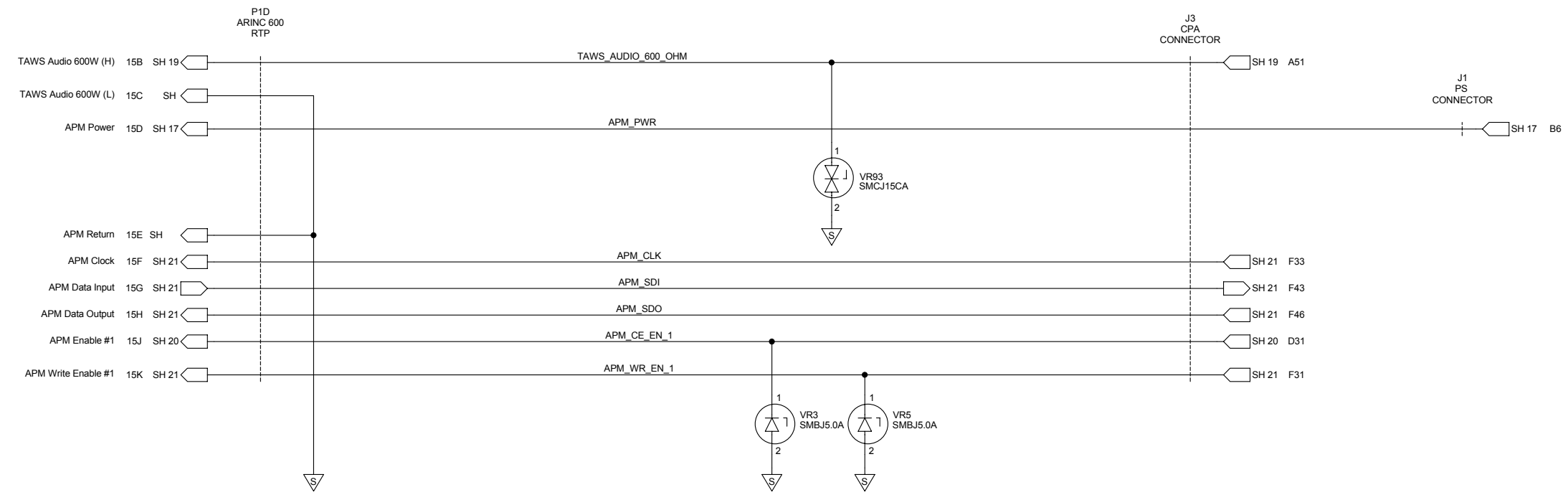

ARINC 600 CONNECTOR
A1 REAR INTERCONNECT ASSEMBLY
SHEET NO. 3 OF 27

COMPUTER GENERATED

REVISIONS	
REV	DESCRIPTION

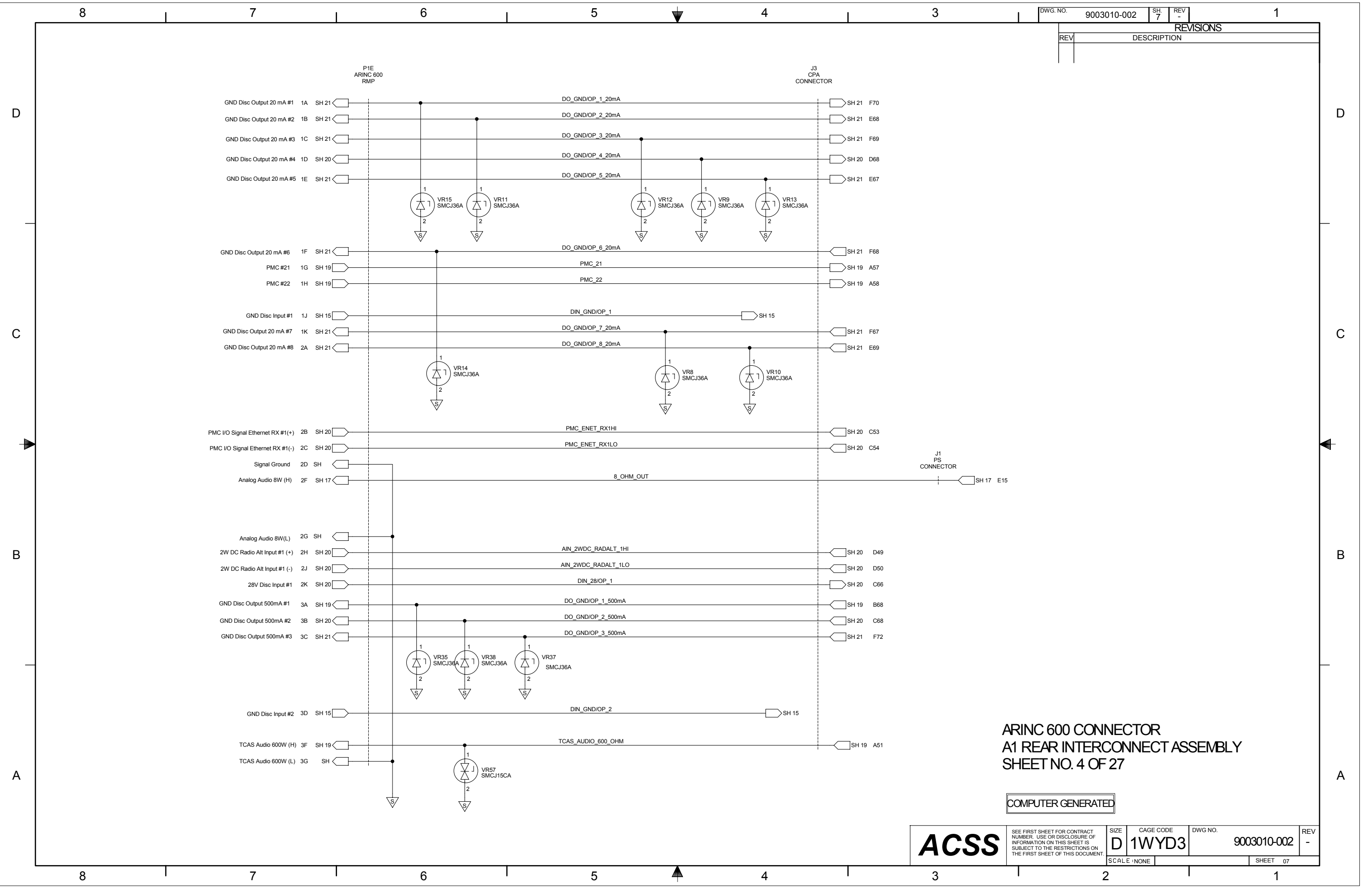

ARINC 600 CONNECTOR
A1 REAR INTERCONNECT ASSEMBLY
SHEET NO. 4 OF 27

COMPUTER GENERATED

ACSS	SEE FIRST SHEET FOR CONTRACT NUMBER. USE OR DISCLOSURE OF INFORMATION ON THIS SHEET IS SUBJECT TO THE RESTRICTIONS ON THE FIRST SHEET OF THIS DOCUMENT.	SIZE D	CAGE CODE 1WYD3	DWG. NO. 9003010-002	REV -
	SCALE: NONE	SHEET 07			

REVISIONS	
REV	DESCRIPTION

D
C
B
A

D
C
B
A

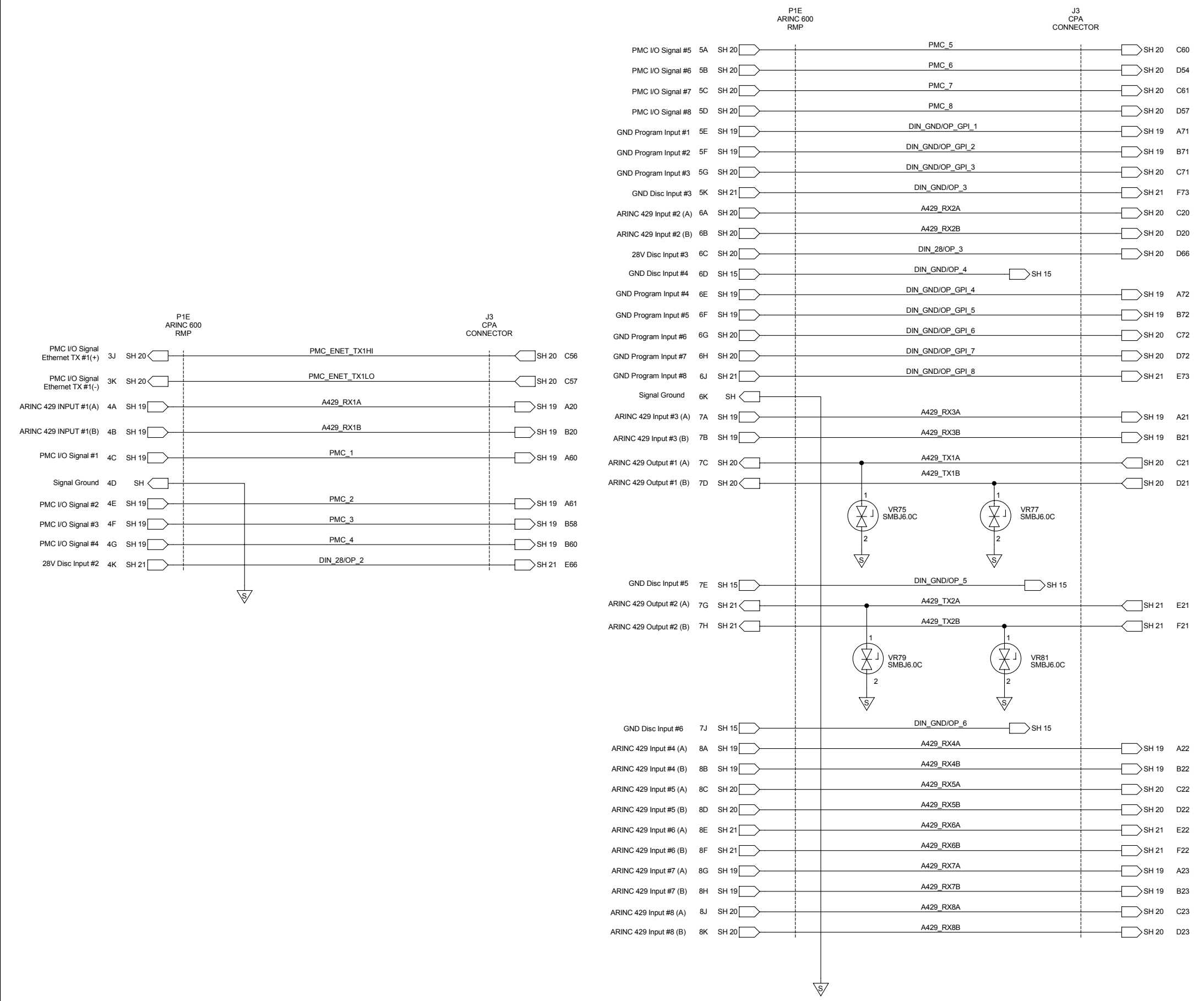

**ARINC 600 CONNECTOR
A1 REAR INTERCONNECT ASSEMBLY
SHEET NO. 5 OF 27**

COMPUTER GENERATED

8
7
6
5
4
3
2
1

7
6
5
4
3
2
1

6
5
4
3
2
1

5
4
3
2
1

4
3
2
1

3
2
1

2
1

1

REVISIONS	
REV	DESCRIPTION

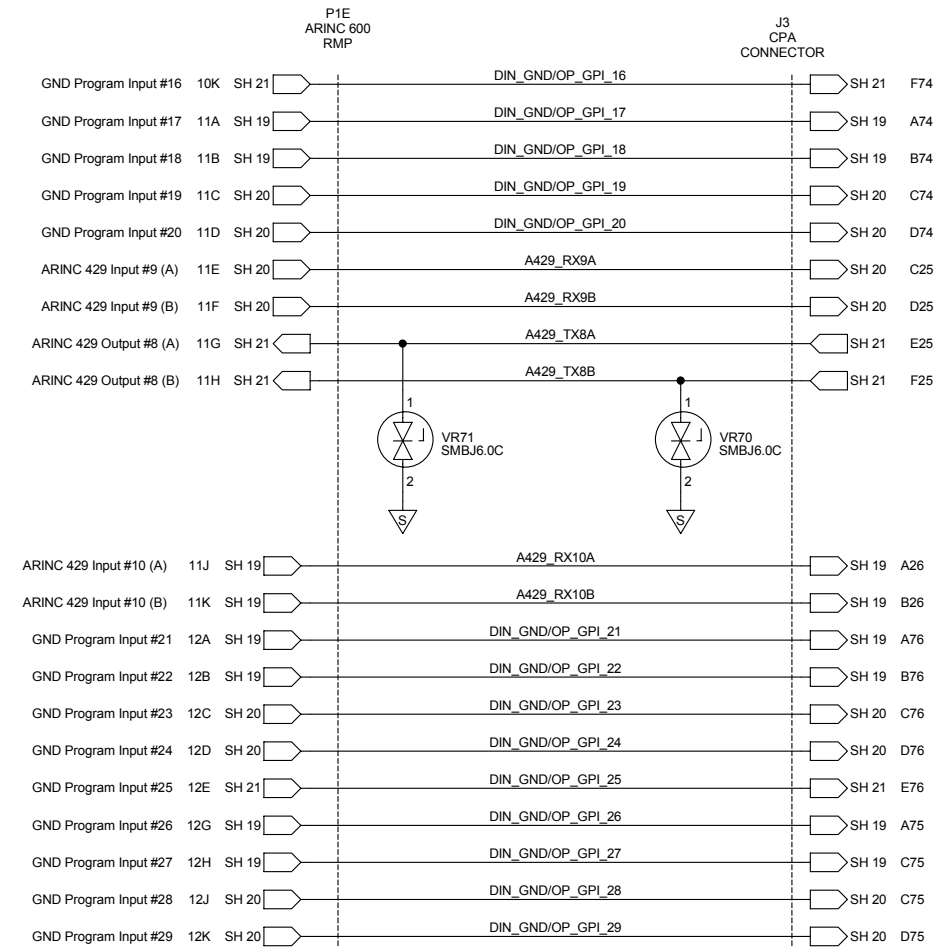
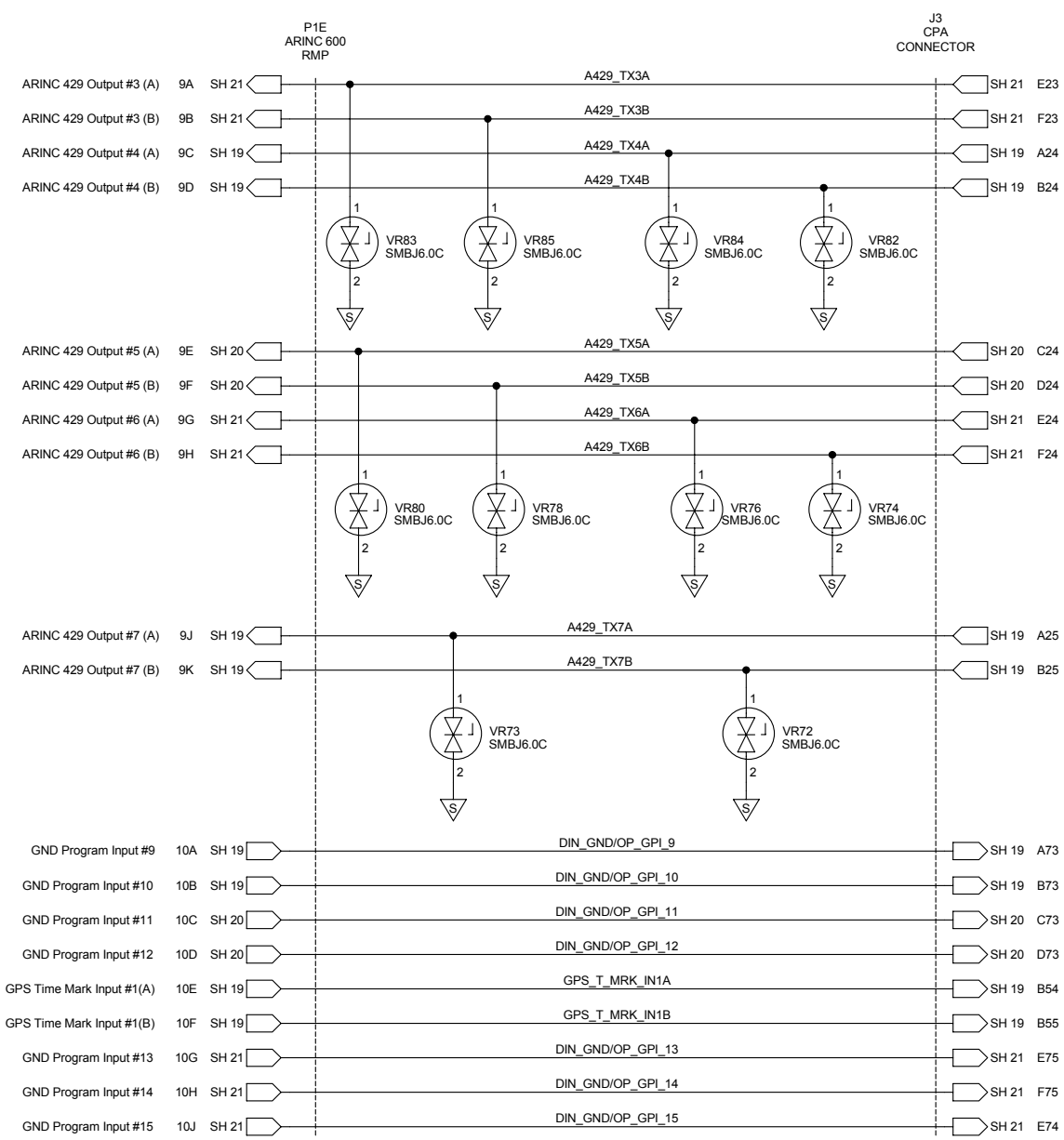

**ARINC 600 CONNECTOR
 A1 REAR INTERCONNECT ASSEMBLY
 SHEET NO. 6 OF 27**

COMPUTER GENERATED

REVISIONS	
REV	DESCRIPTION

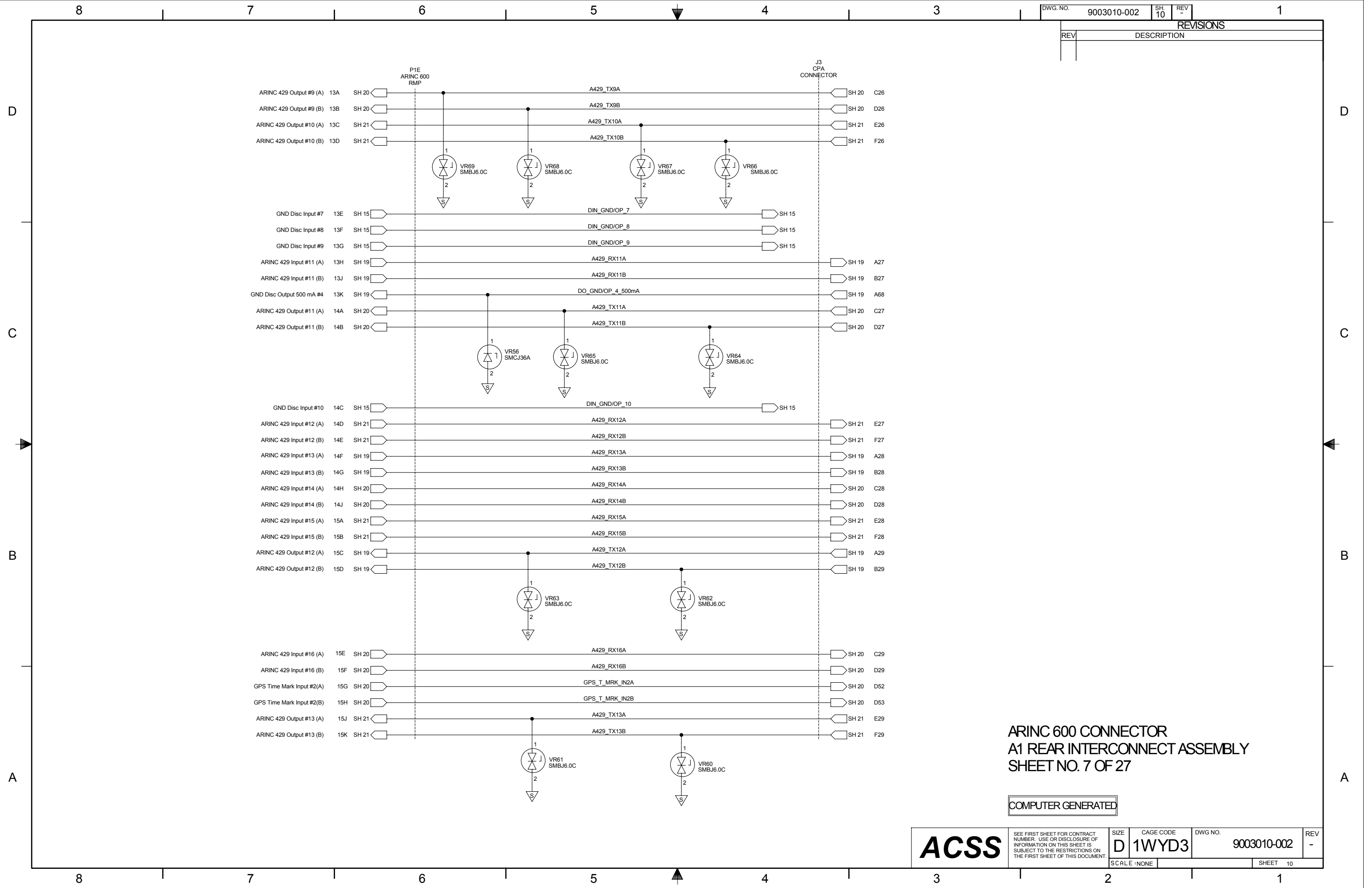

**ARINC 600 CONNECTOR
A1 REAR INTERCONNECT ASSEMBLY
SHEET NO. 7 OF 27**

COMPUTER GENERATED

ACSS	SEE FIRST SHEET FOR CONTRACT NUMBER. USE OR DISCLOSURE OF INFORMATION ON THIS SHEET IS SUBJECT TO THE RESTRICTIONS ON THE FIRST SHEET OF THIS DOCUMENT.	SIZE D	CAGE CODE 1WYD3	DWG NO. 9003010-002	REV -
	SCALE: NONE	SHEET 10			

REVISIONS	
REV	DESCRIPTION

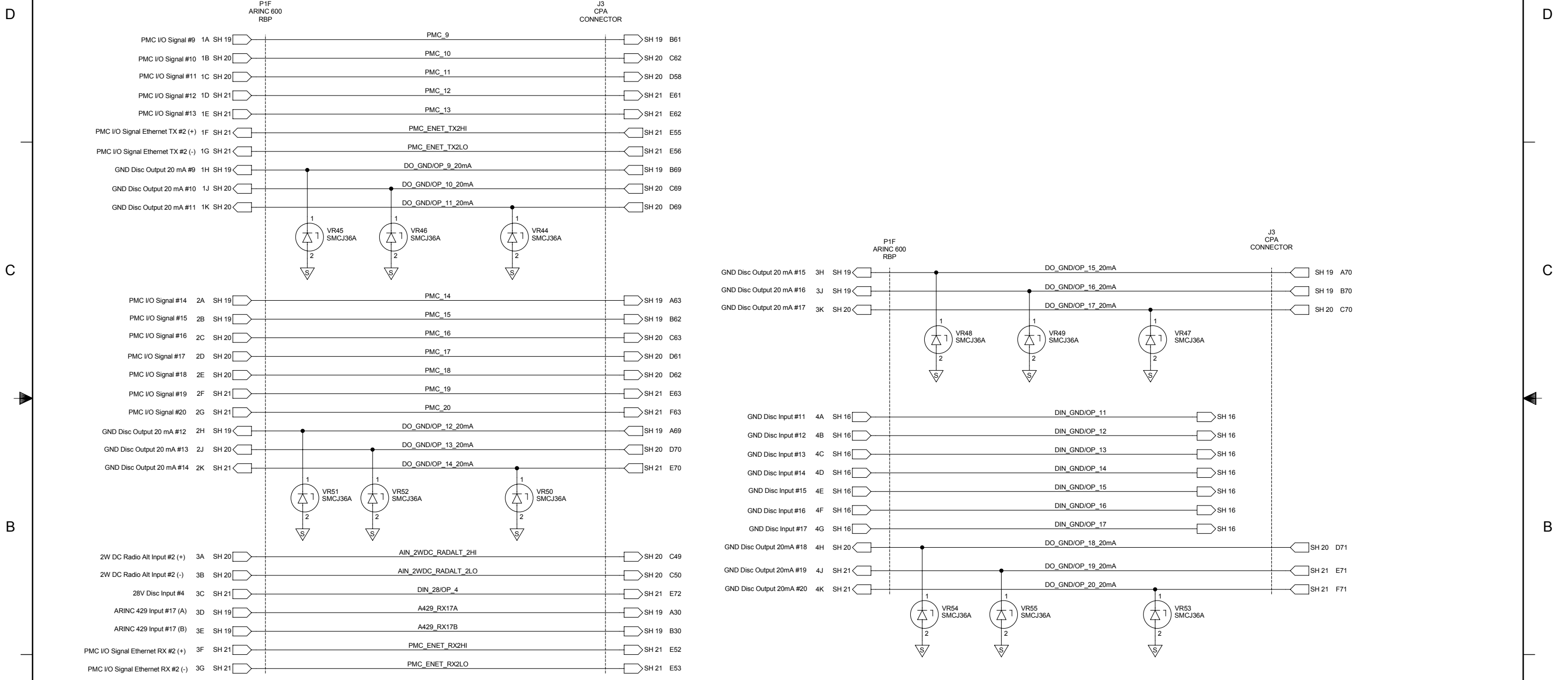

**ARINC 600 CONNECTOR
A1 REAR INTERCONNECT ASSEMBLY
SHEET NO. 8 OF 27**

COMPUTER GENERATED

ACSS	SEE FIRST SHEET FOR CONTRACT NUMBER. USE OR DISCLOSURE OF INFORMATION ON THIS SHEET IS SUBJECT TO THE RESTRICTIONS ON THE FIRST SHEET OF THIS DOCUMENT.	SIZE	CAGE CODE	DWG NO.	REV
		D	1WYD3	9003010-002	-
SCALE: NONE		SHEET		11	

REVISIONS	
REV	DESCRIPTION

D
C
B
A

D
C
B
A

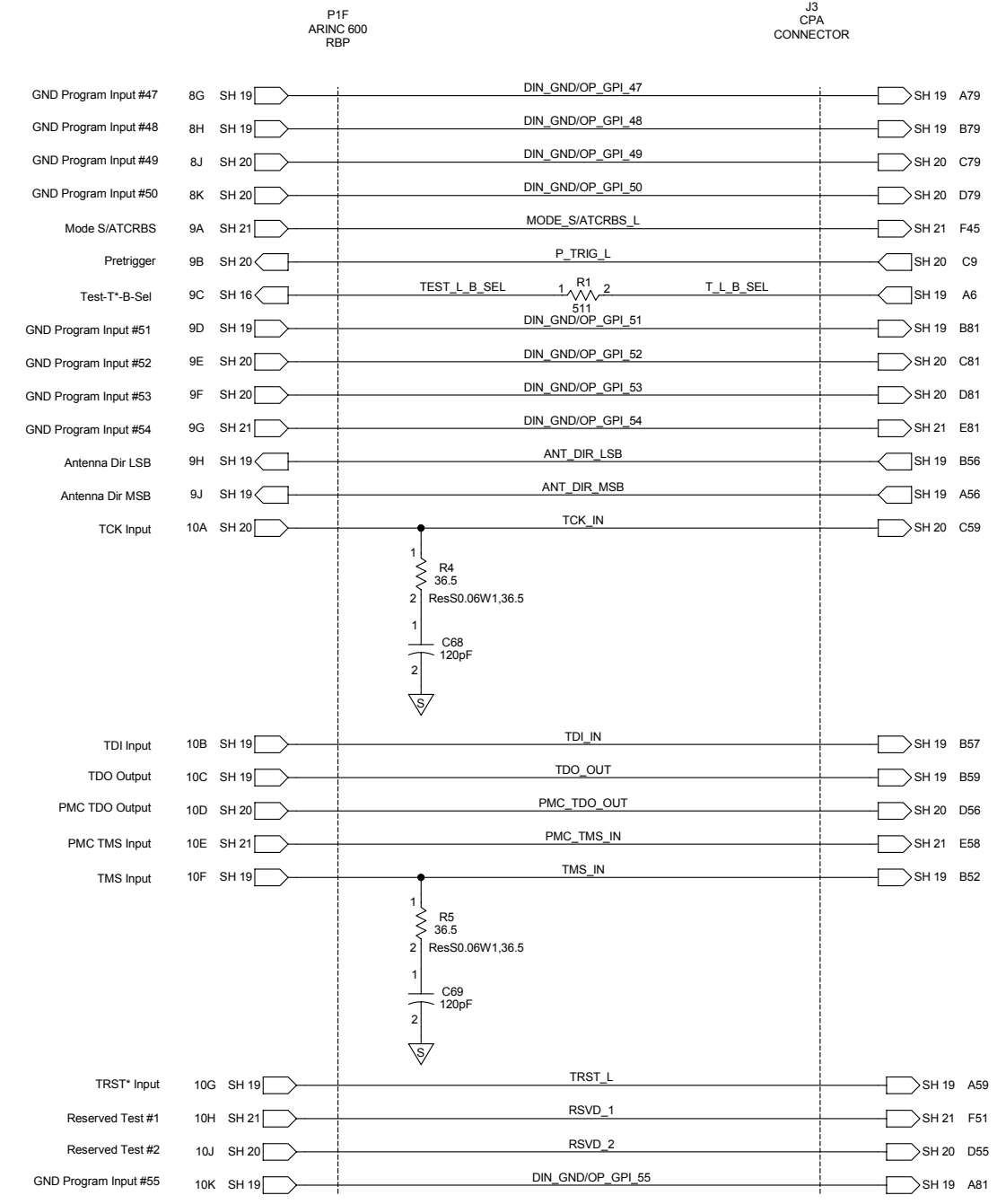
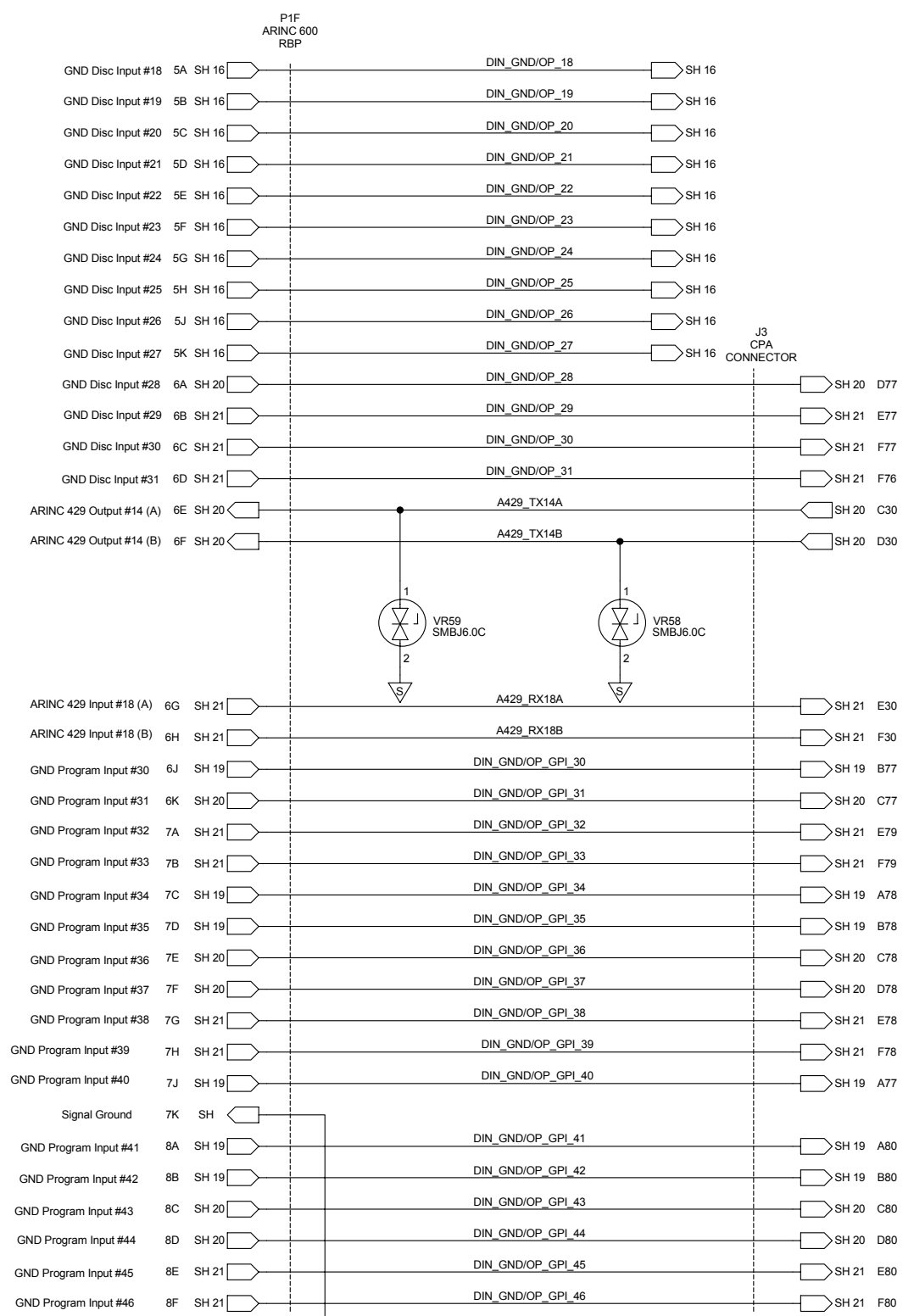

**ARINC 600 CONNECTOR
A1 REAR INTERCONNECT ASSEMBLY
SHEET NO. 9 OF 27**

COMPUTER GENERATED

REVISIONS	
REV	DESCRIPTION

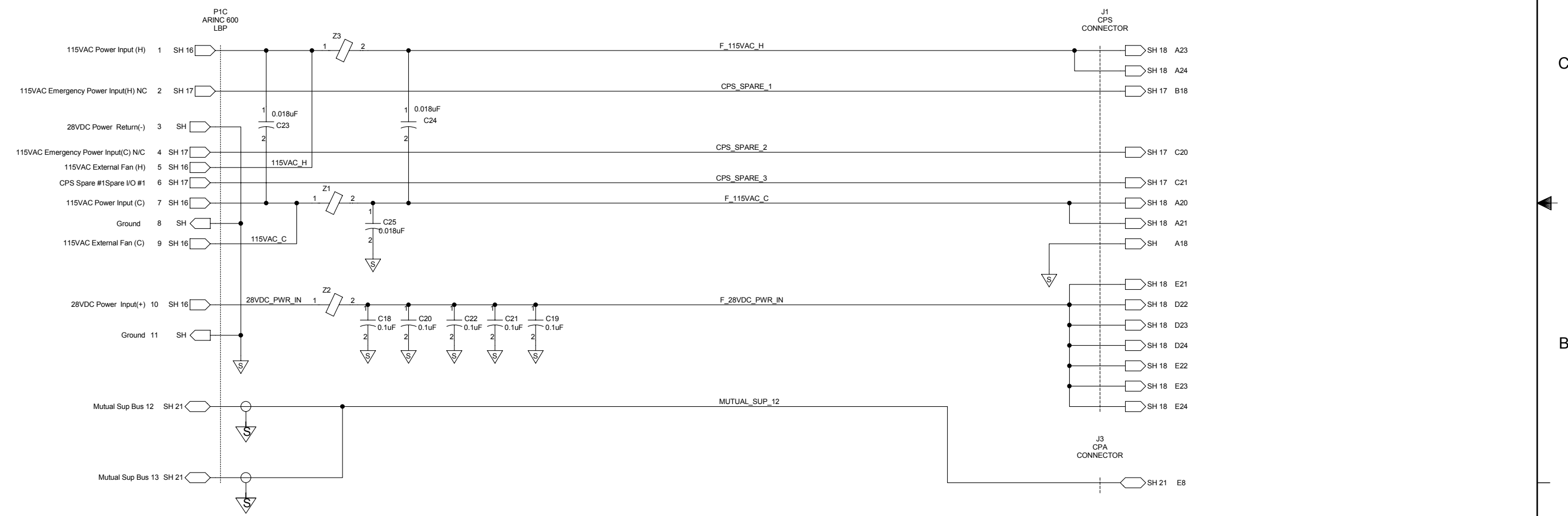
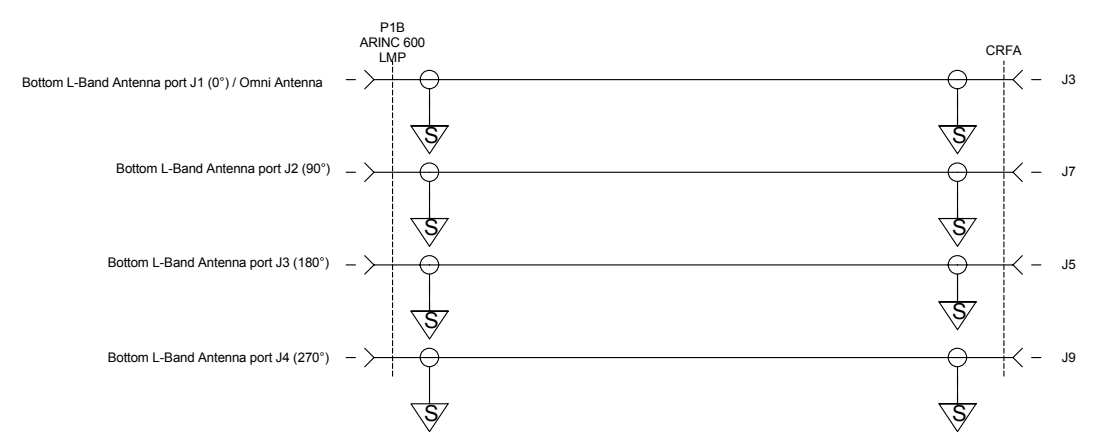
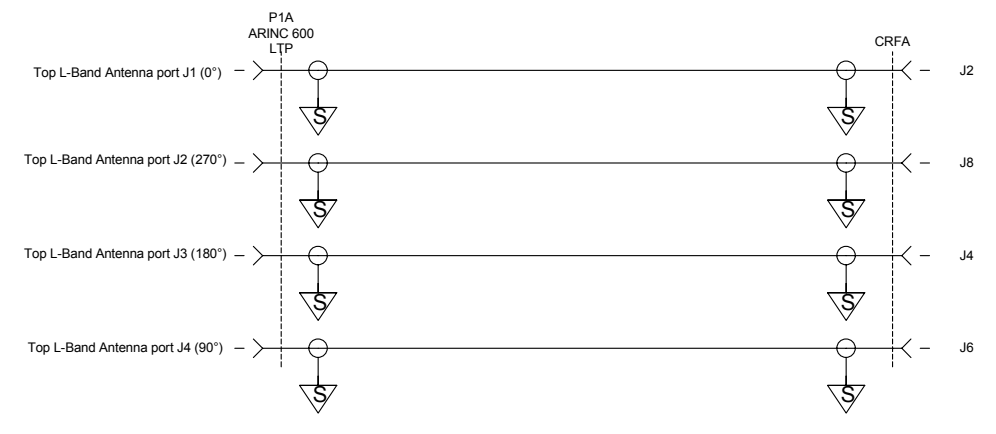

ARINC 600 CONNECTOR
A1 REAR INTERCONNECT ASSEMBLY
SHEET NO. 10 OF 27

COMPUTER GENERATED

REVISIONS	
REV	DESCRIPTION

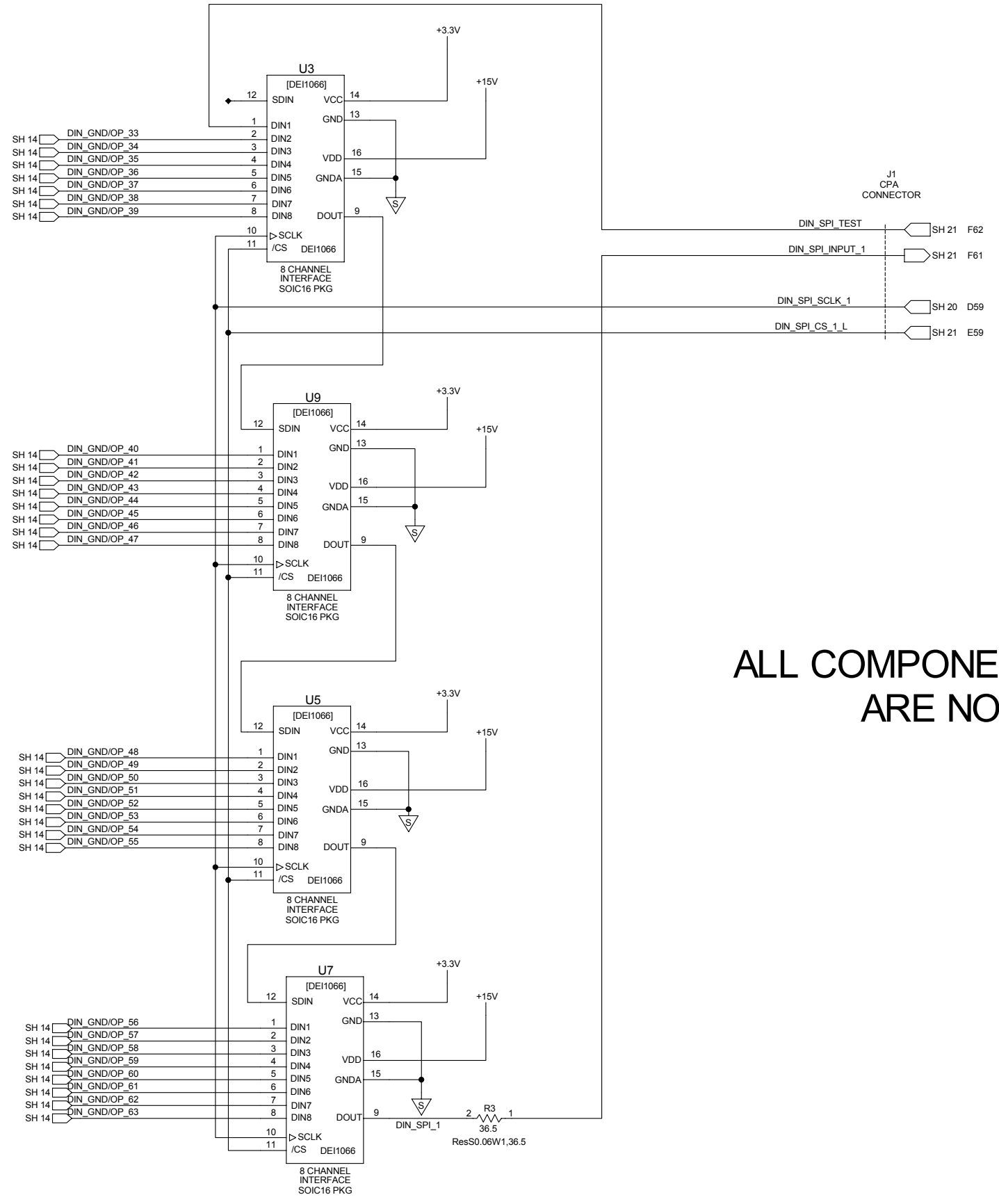

ALL COMPONENTS ON THIS SHEET
ARE NOT INSTALLED

TAWS DISCRETE IN OCTAL BUFFERS
A1 REAR INTERCONNECT ASSEMBLY
SHEET NO. 11 OF 27

COMPUTER GENERATED

ACSS	SEE FIRST SHEET FOR CONTRACT NUMBER. USE OR DISCLOSURE OF INFORMATION ON THIS SHEET IS SUBJECT TO THE RESTRICTIONS ON THE FIRST SHEET OF THIS DOCUMENT.	SIZE D	CAGE CODE 1WYD3	DWG NO. 9003010-002	REV -
	SCALE: NONE	SHEET 14			

REVISIONS	
REV	DESCRIPTION

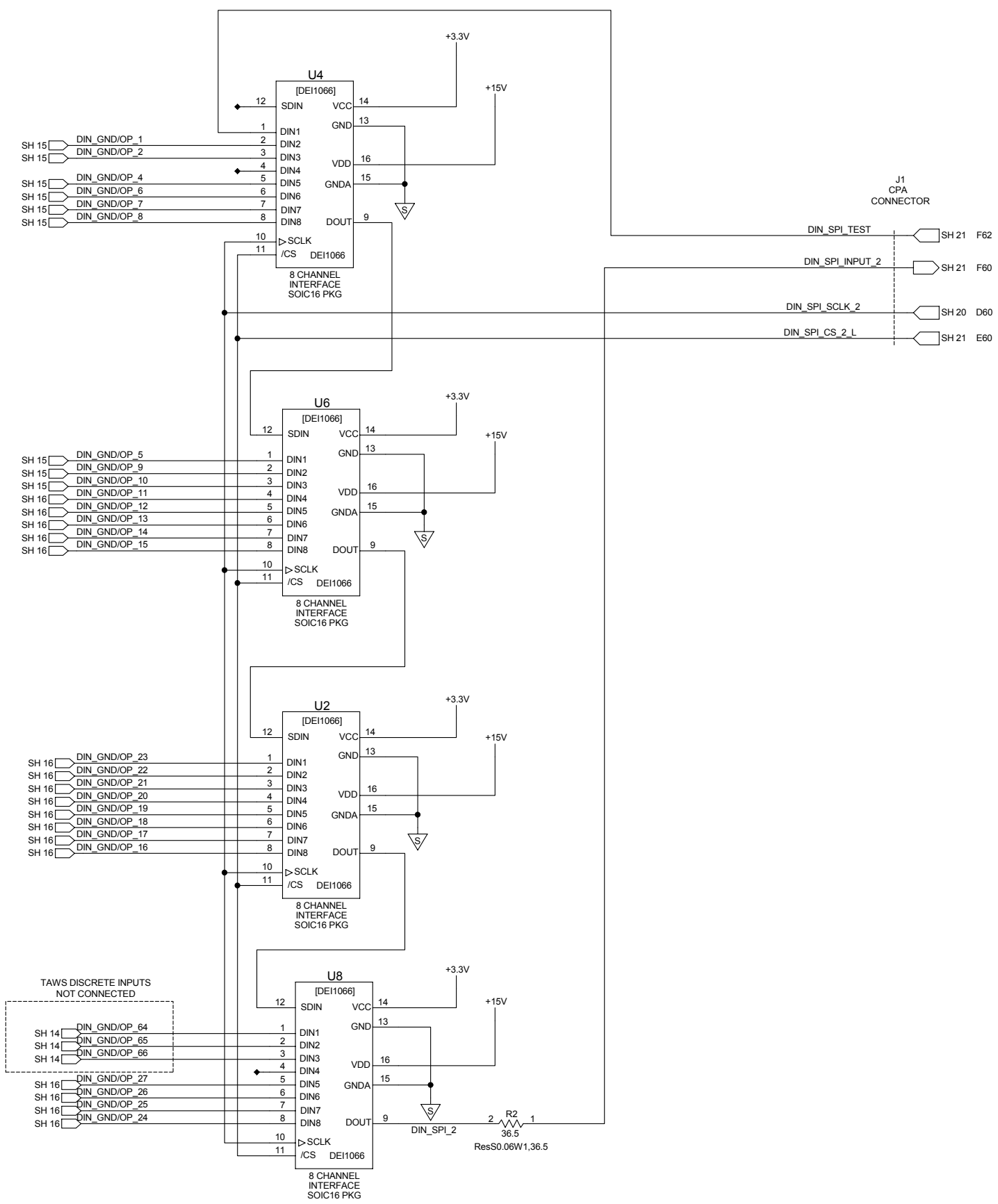

TAWs DISCRETE INPUTS
NOT CONNECTED

TCAS DISCRETE IN OCTAL BUFFERS
A1 REAR INTERCONNECT ASSEMBLY
SHEET NO. 12 OF 27

COMPUTER GENERATED

REVISIONS	
REV	DESCRIPTION

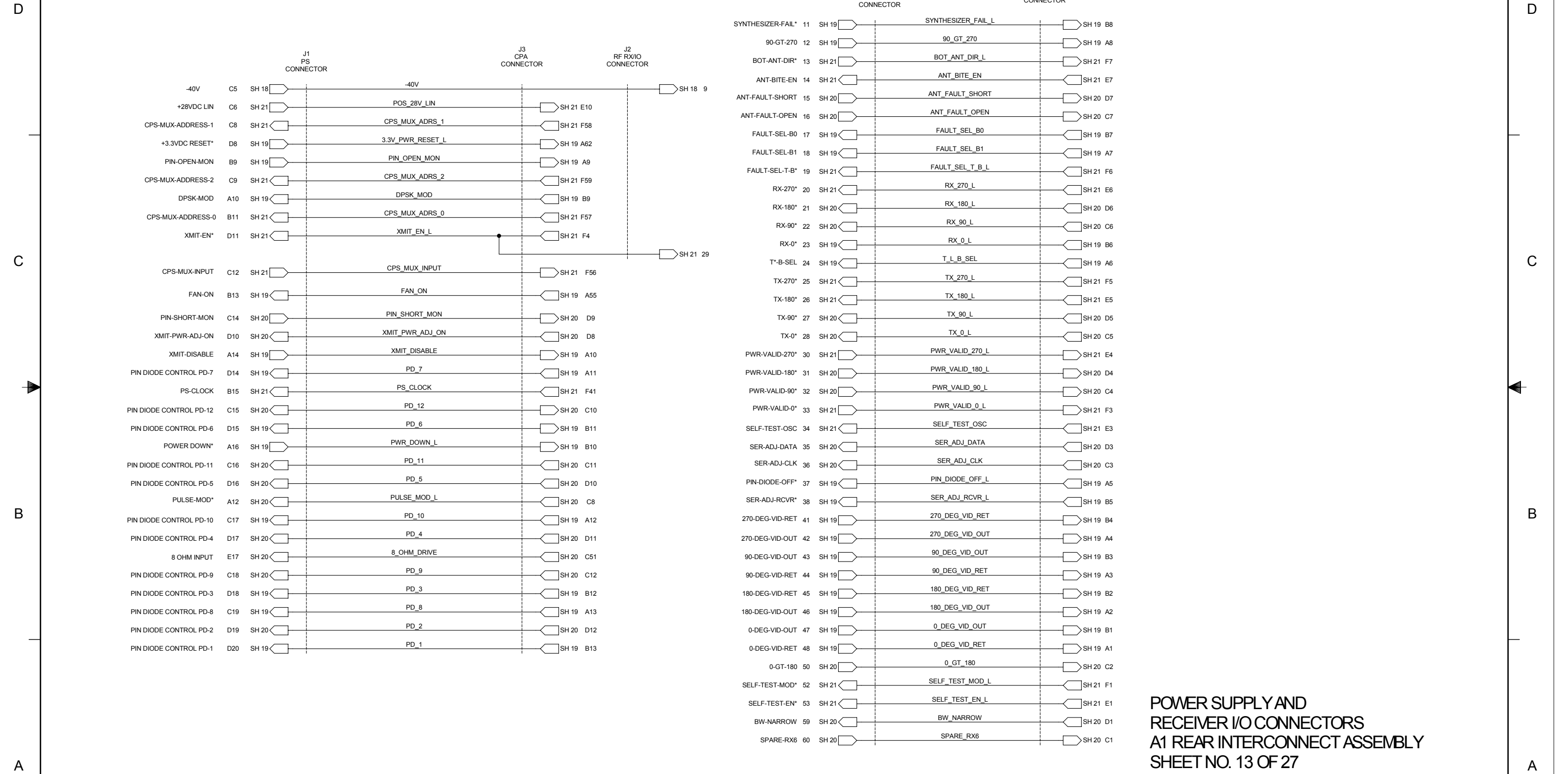

POWER SUPPLY AND
RECEIVER I/O CONNECTORS
A1 REAR INTERCONNECT ASSEMBLY
SHEET NO. 13 OF 27

COMPUTER GENERATED

REVISIONS	
REV	DESCRIPTION

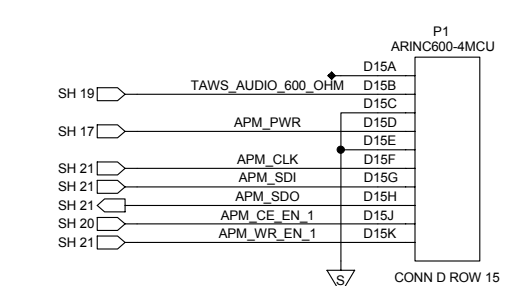
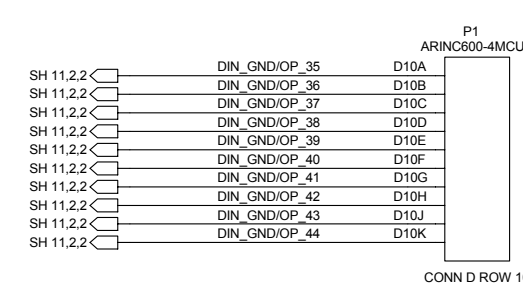
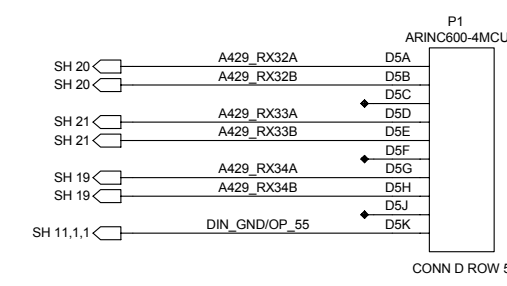
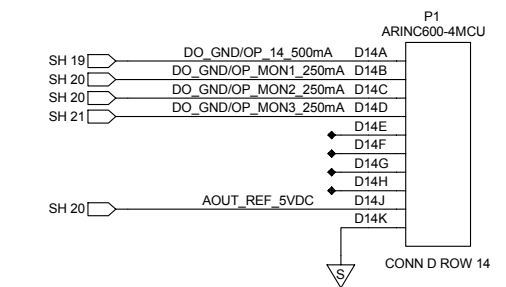
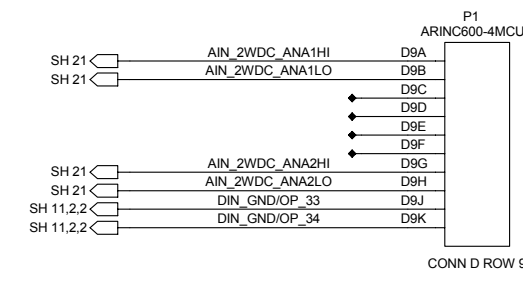
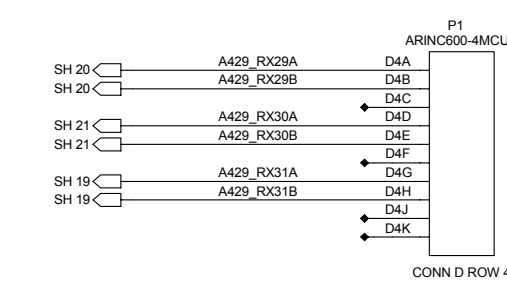
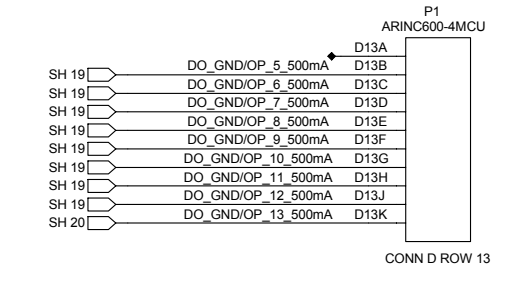
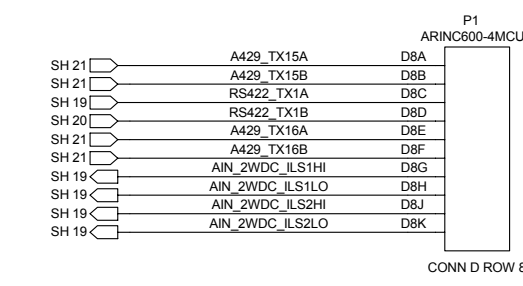
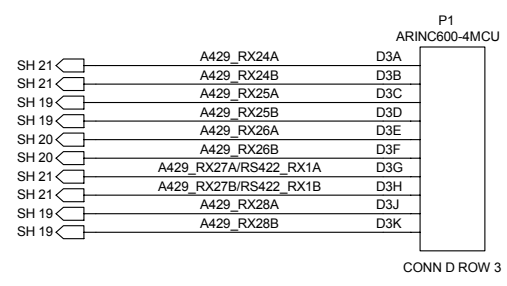
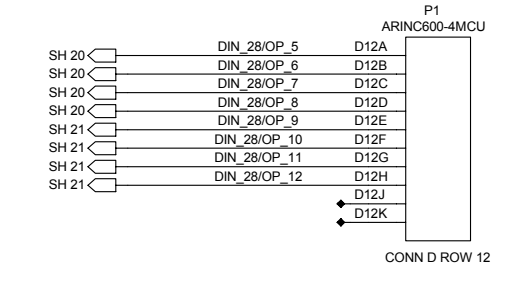
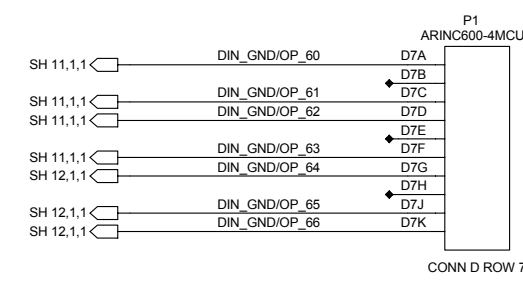
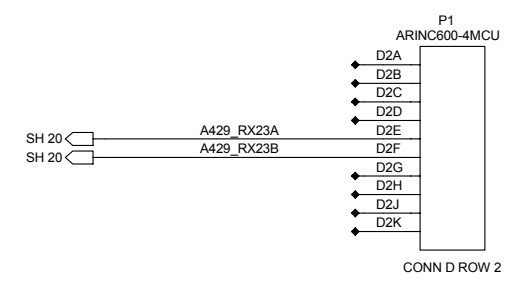
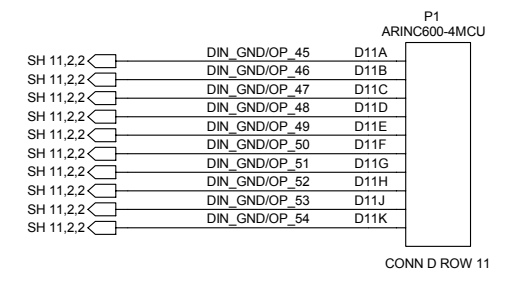
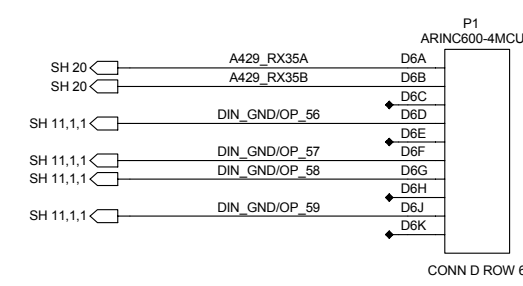
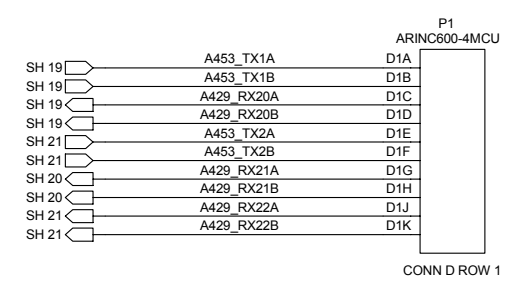

**ARINC 600 CONNECTOR (RTP)
A1 REAR INTERCONNECT ASSEMBLY
SHEET NO. 14 OF 27**

COMPUTER GENERATED

ACSS	SEE FIRST SHEET FOR CONTRACT NUMBER. USE OR DISCLOSURE OF INFORMATION ON THIS SHEET IS SUBJECT TO THE RESTRICTIONS ON THE FIRST SHEET OF THIS DOCUMENT.	SIZE D	CAGE CODE 1WYD3	DWG NO. 9003010-002	REV -
	SCALE: NONE	SHEET 17			

REVISIONS	
REV	DESCRIPTION

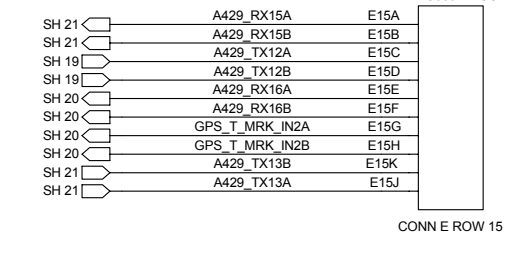
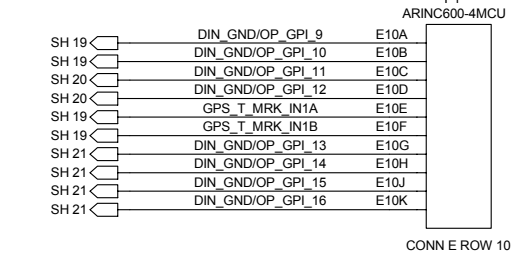
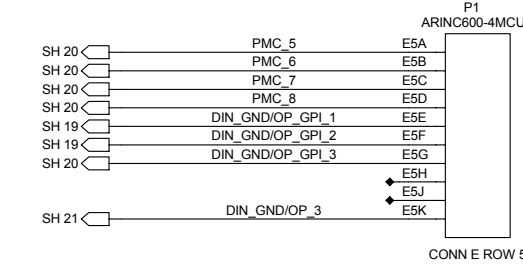
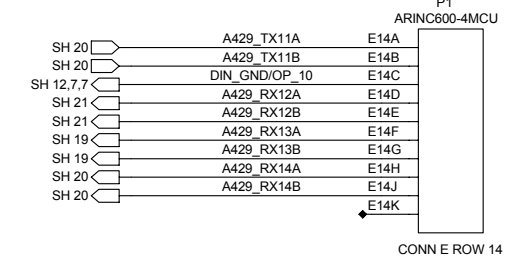
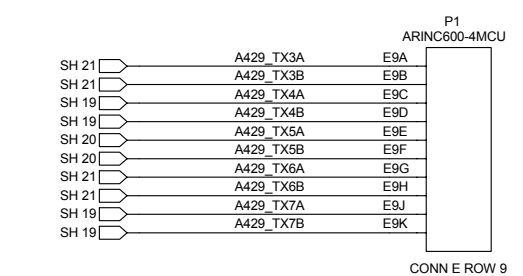
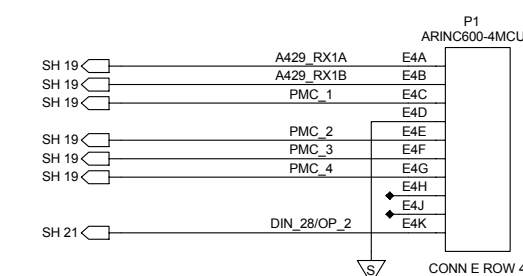
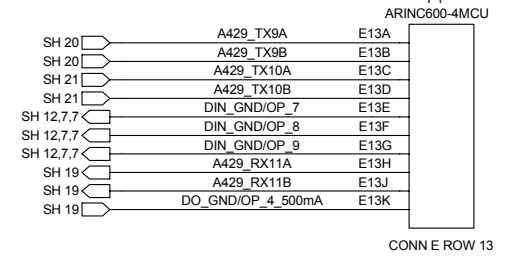
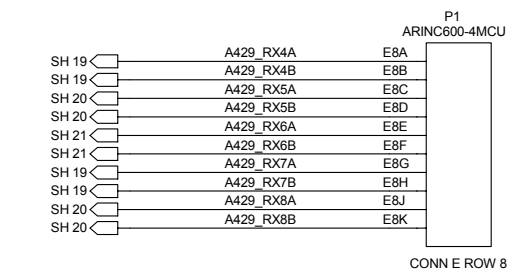
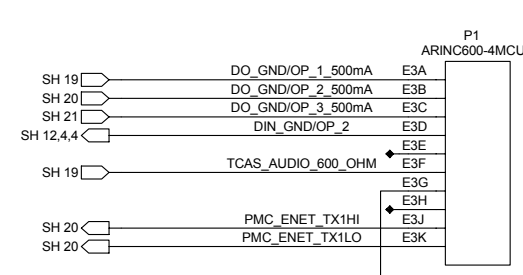
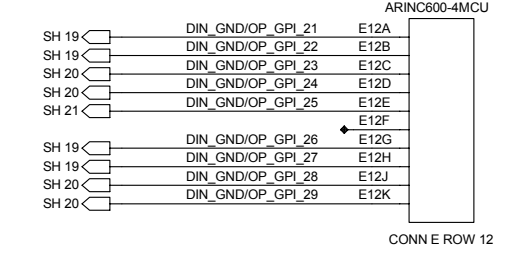
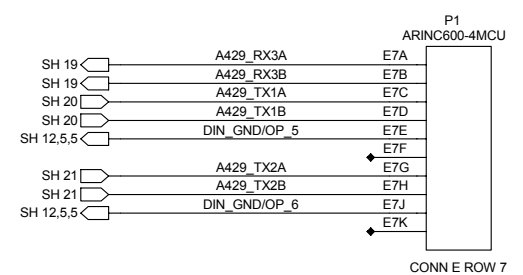
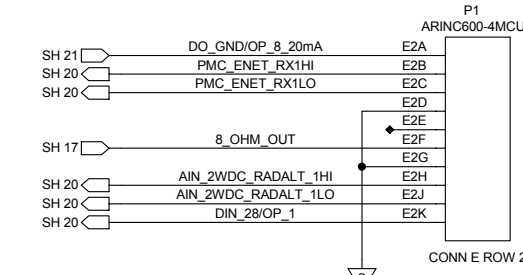
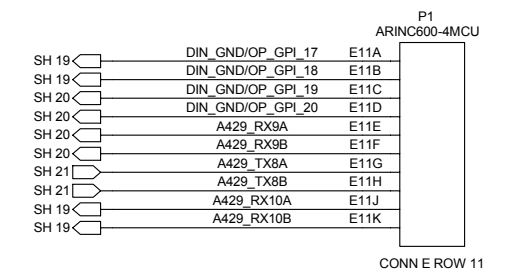
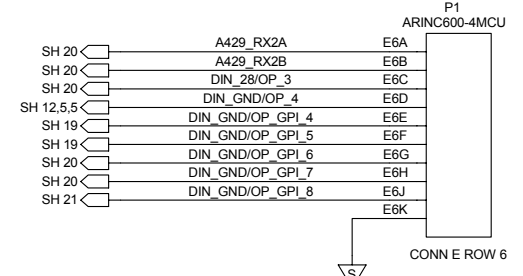
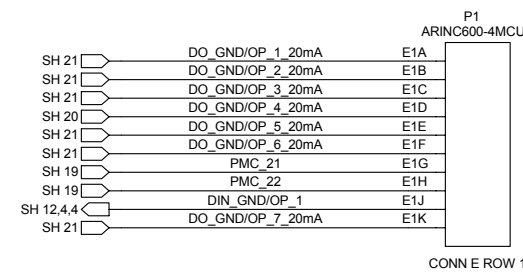

**ARINC 600 CONNECTOR (RMP)
A1 REAR INTERCONNECT ASSEMBLY
SHEET NO. 15 OF 27**

COMPUTER GENERATED

ACSS	SEE FIRST SHEET FOR CONTRACT NUMBER. USE OR DISCLOSURE OF INFORMATION ON THIS SHEET IS SUBJECT TO THE RESTRICTIONS ON THE FIRST SHEET OF THIS DOCUMENT.	SIZE	CAGE CODE	DWG NO.	REV
		D	1WYD3	9003010-002	-
SCALE: NONE		SHEET		18	

REVISIONS	
REV	DESCRIPTION

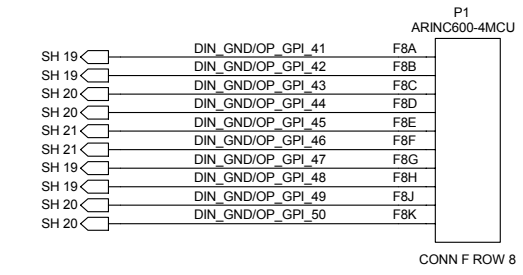
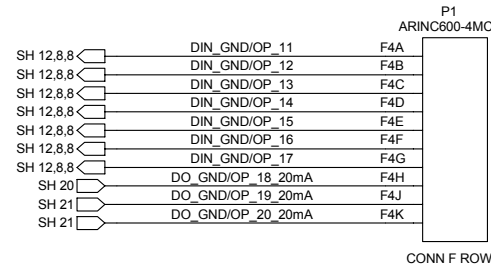
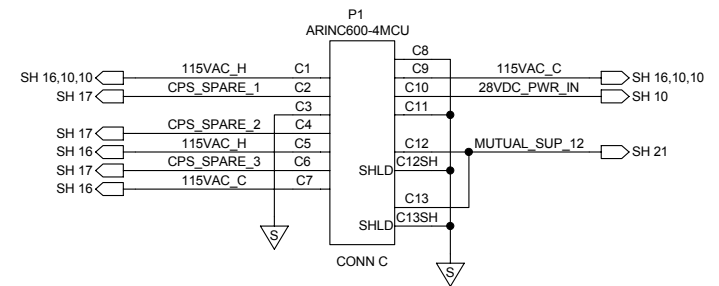
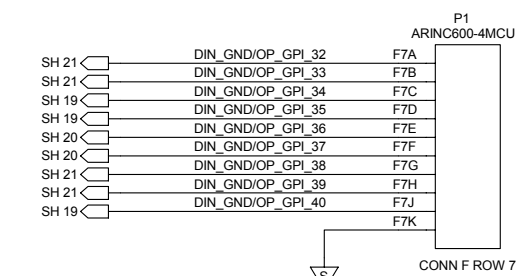
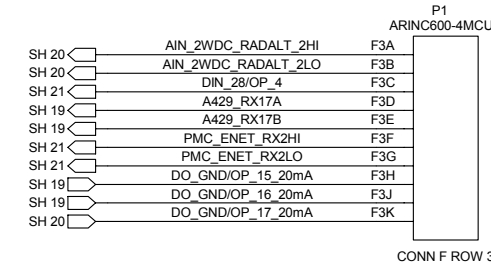
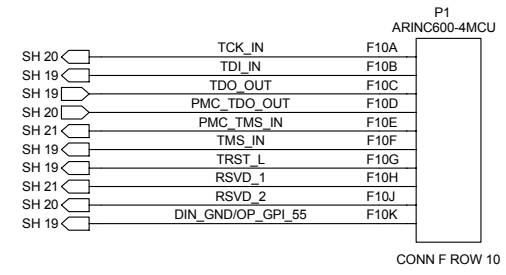
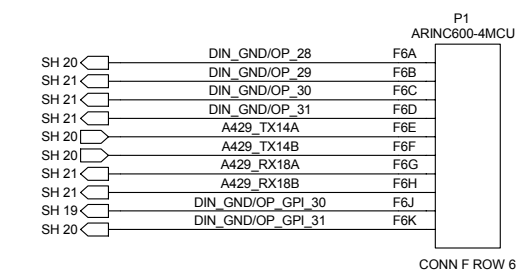
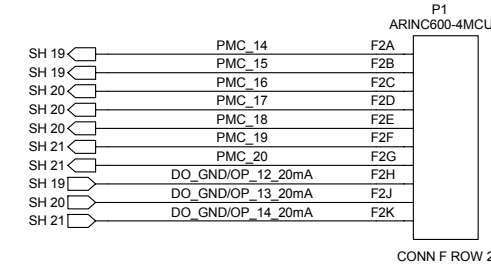
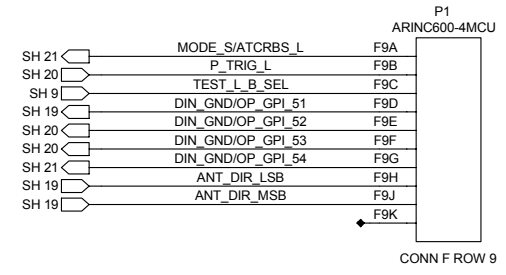
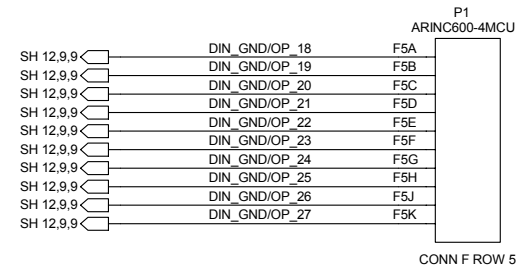
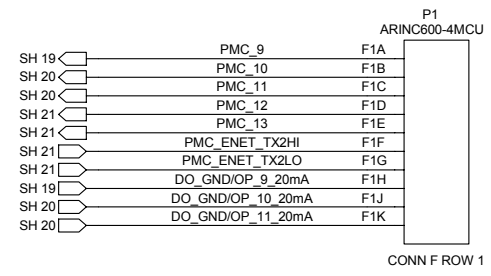

ARINC 600 CONNECTOR (RBP)
A1 REAR INTERCONNECT ASSEMBLY
SHEET NO. 16 OF 27

COMPUTER GENERATED

ACSS	SEE FIRST SHEET FOR CONTRACT NUMBER. USE OR DISCLOSURE OF INFORMATION ON THIS SHEET IS SUBJECT TO THE RESTRICTIONS ON THE FIRST SHEET OF THIS DOCUMENT.	SIZE	CAGE CODE	DWG. NO.	REV
		D	1WYD3	9003010-002	-
SCALE: NONE		SHEET		19	

REVISONS	
REV	DESCRIPTION

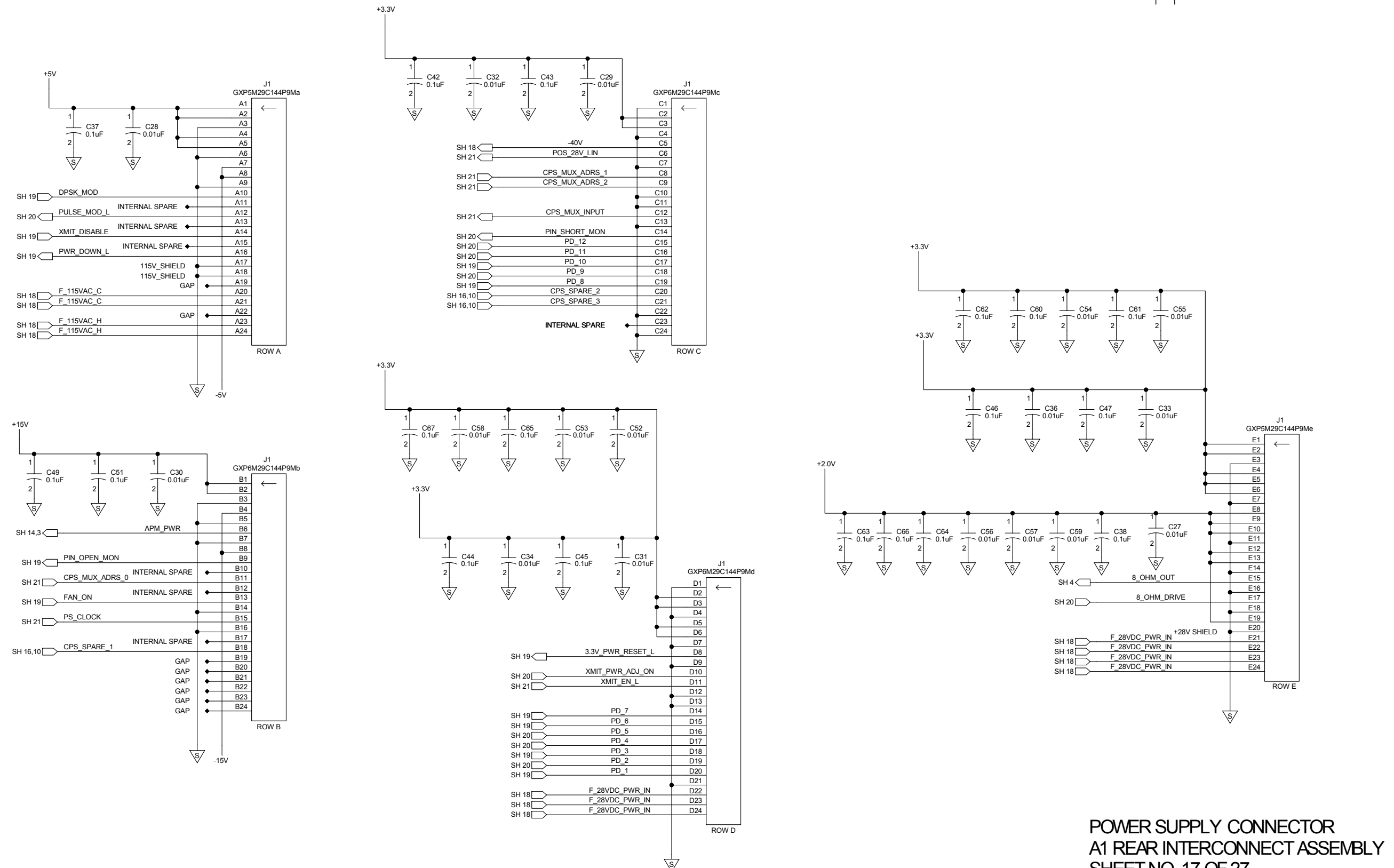

POWER SUPPLY CONNECTOR
A1 REAR INTERCONNECT ASSEMBLY
SHEET NO. 17 OF 27

COMPUTER GENERATED

REVISIONS	
REV	DESCRIPTION

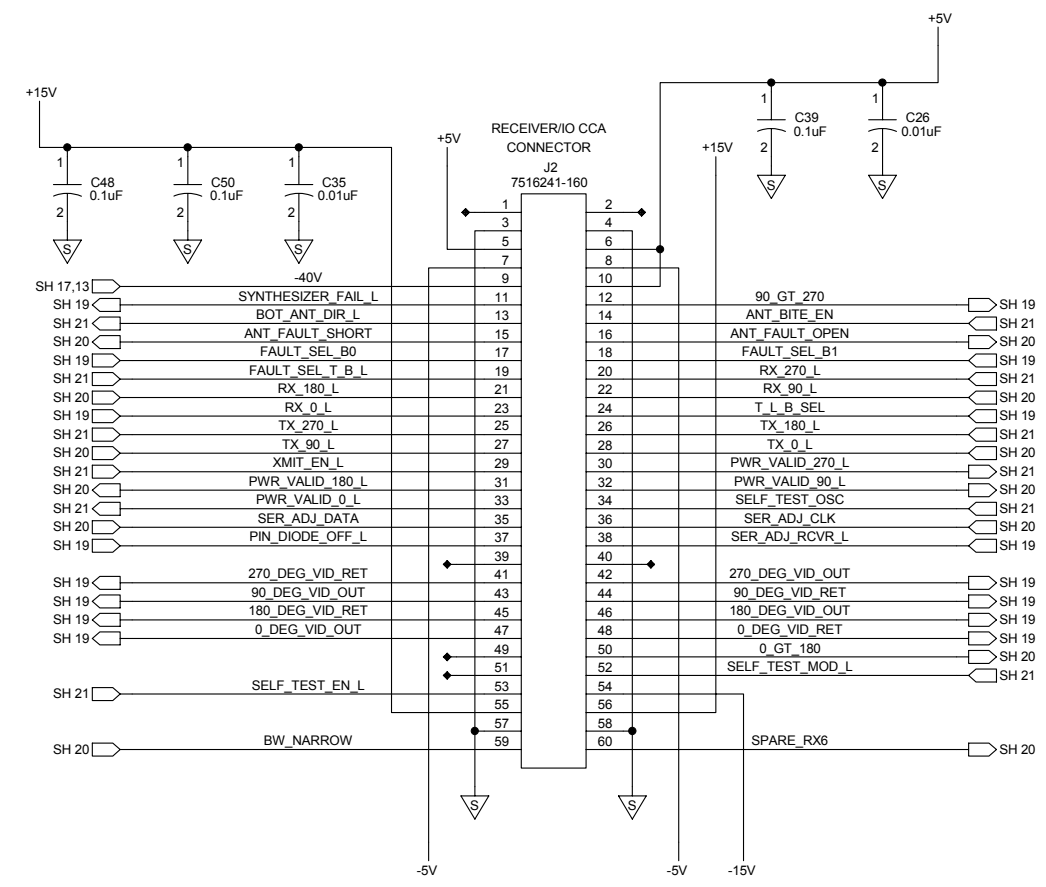

RECEIVER I/O & PDL CONNECTORS
A1 REAR INTERCONNECT ASSEMBLY
SHEET NO. 18 OF 27

COMPUTER GENERATED

ACSS	SEE FIRST SHEET FOR CONTRACT NUMBER. USE OR DISCLOSURE OF INFORMATION ON THIS SHEET IS SUBJECT TO THE RESTRICTIONS ON THE FIRST SHEET OF THIS DOCUMENT.	SIZE	CAGE CODE	DWG NO.	REV
		D	1WYD3	9003010-002	-
SCALE: NONE		SHEET 21			

REVISIONS	
REV	DESCRIPTION

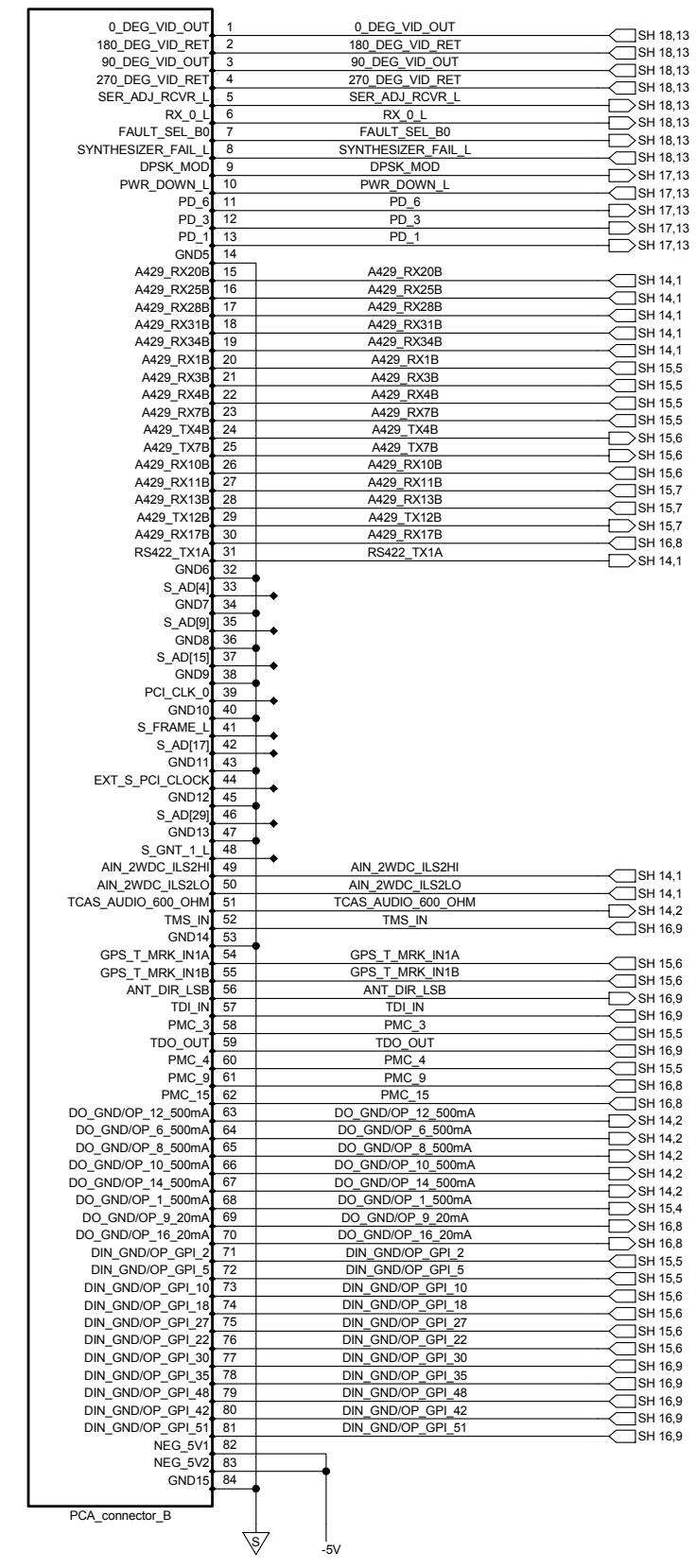
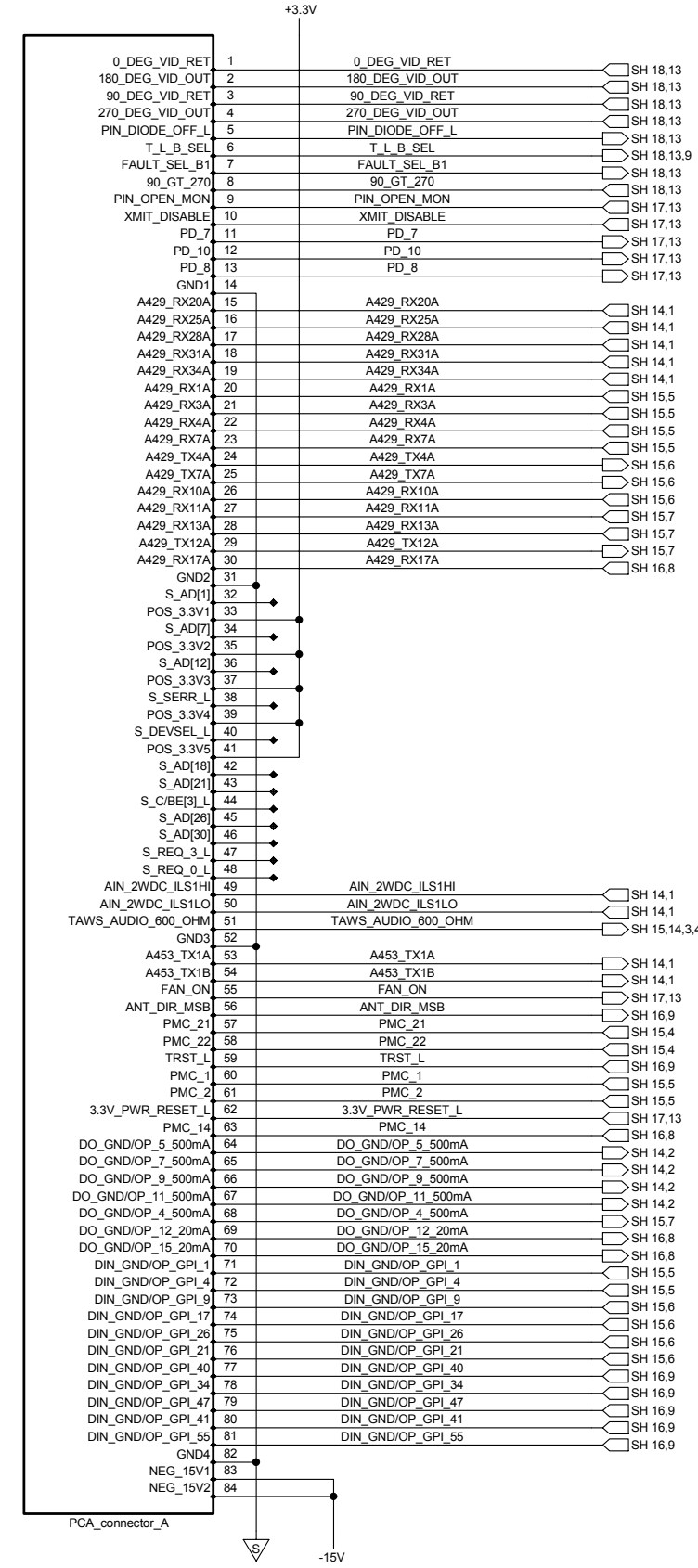

CPA CONNECTOR (ROW A & B)
A1 REAR INTERCONNECT ASSEMBLY
SHEET NO. 19 OF 27

COMPUTER GENERATED

REVISIONS	
REV	DESCRIPTION

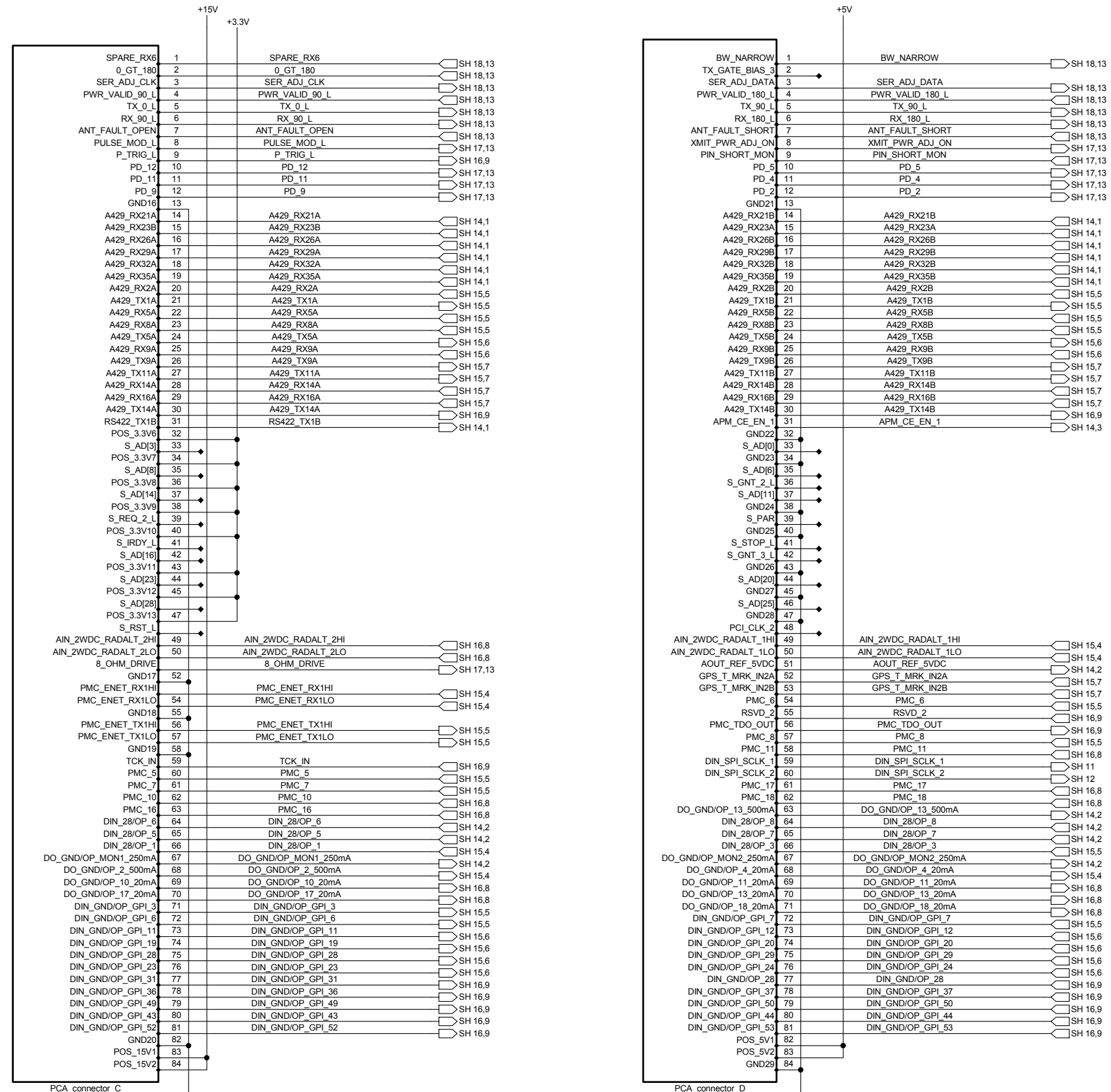

CPA CONNECTOR (ROW C & D)
A1 REAR INTERCONNECT ASSEMBLY
SHEET NO. 20 OF 27

COMPUTER GENERATED

ACSS	SEE FIRST SHEET FOR CONTRACT NUMBER. USE OR DISCLOSURE OF INFORMATION ON THIS SHEET IS SUBJECT TO THE RESTRICTIONS ON THE FIRST SHEET OF THIS DOCUMENT.	SIZE	CAGE CODE	DWG NO.	REV
		D	1WYD3	9003010-002	-
SCALE: NONE		SHEET		23	

REVISIONS	
REV	DESCRIPTION

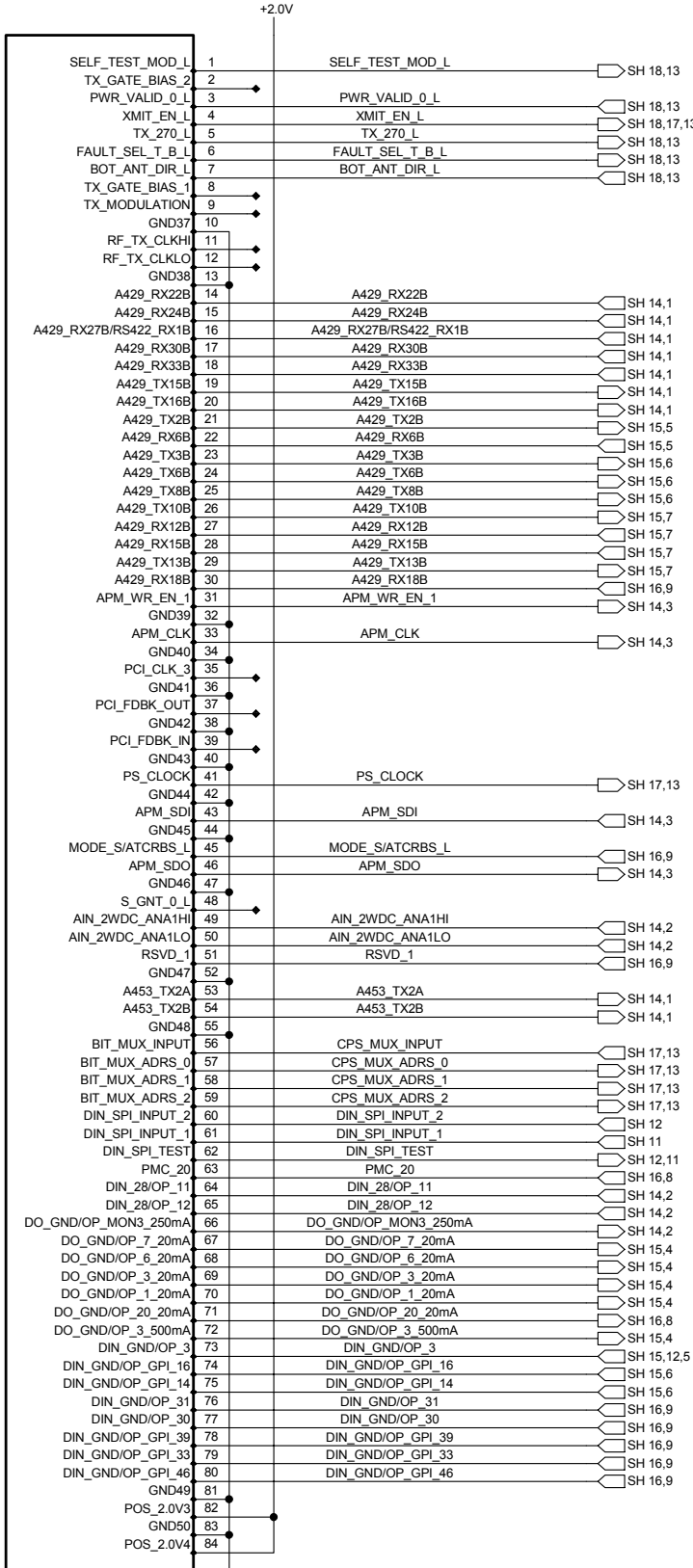
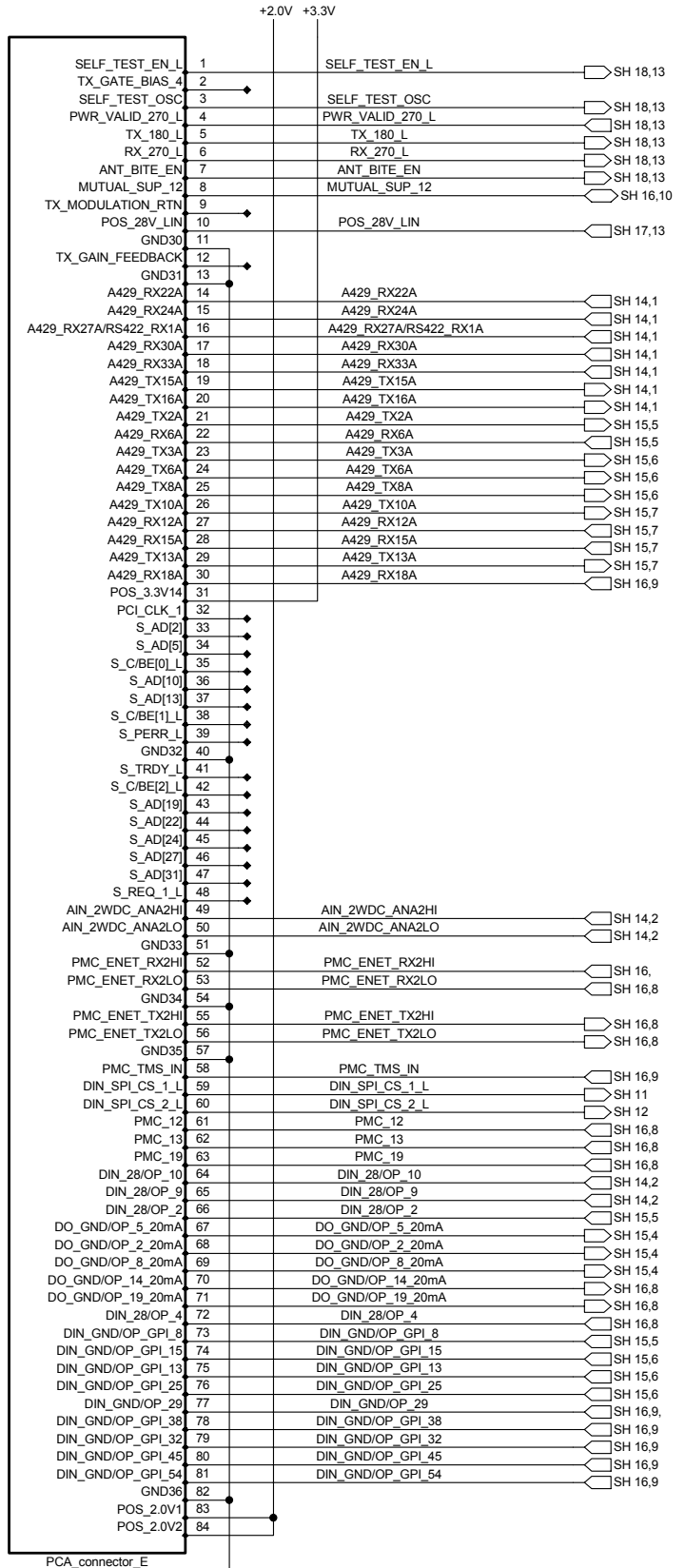

CPA CONNECTOR (ROW E & F)
A1 REAR INTERCONNECT ASSEMBLY
SHEET NO. 21 OF 27

COMPUTER GENERATED

REVISIONS	
REV	DESCRIPTION

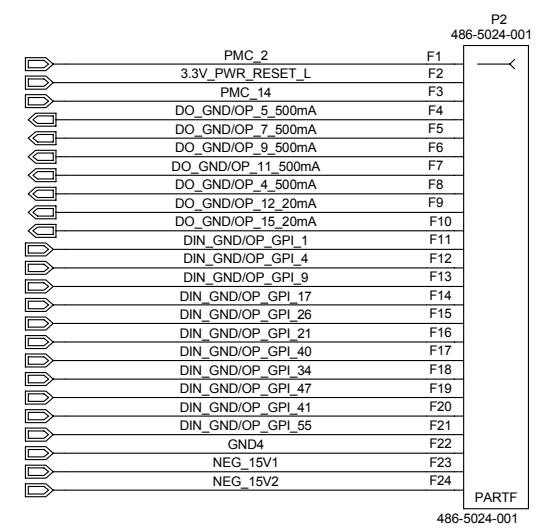
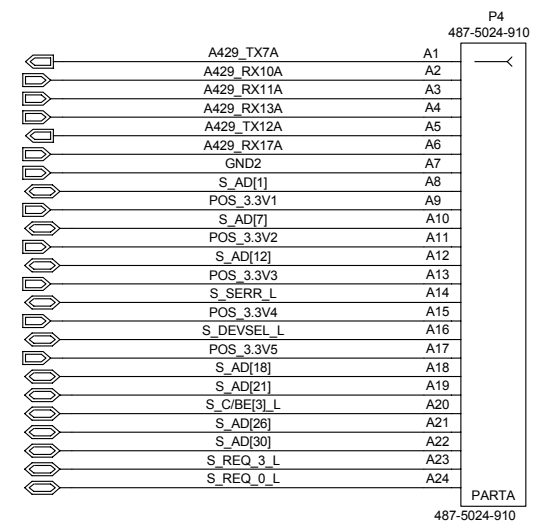
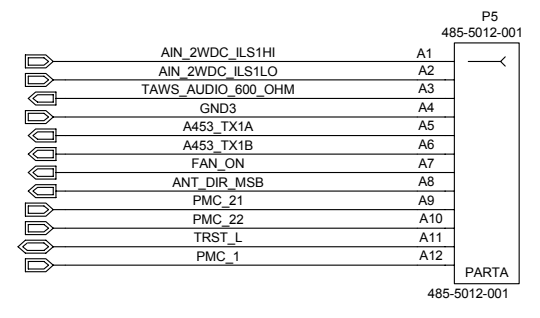
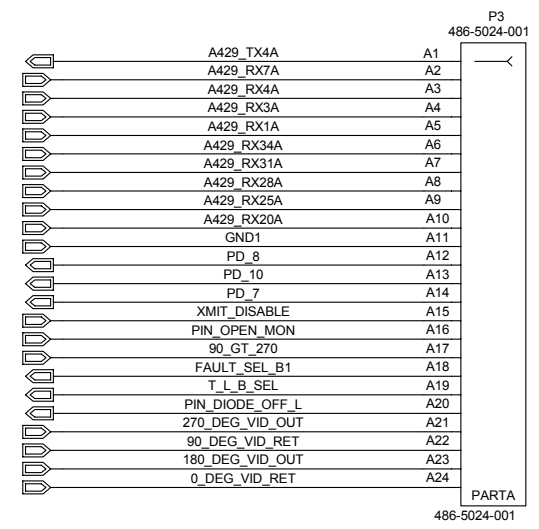

NOTE:
FOR TROUBLESHOOTING PURPOSES, USE
HEIRARCHICAL CPA CONNECTIONS

CPA CONNECTOR (ROW A)
A1 REAR INTERCONNECT ASSEMBLY
SHEET NO. 22 OF 27

COMPUTER GENERATED

ACSS	SEE FIRST SHEET FOR CONTRACT NUMBER. USE OR DISCLOSURE OF INFORMATION ON THIS SHEET IS SUBJECT TO THE RESTRICTIONS ON THE FIRST SHEET OF THIS DOCUMENT.	SIZE D	CAGE CODE 1WYD3	DWG NO. 9003010-002	REV -
	SCALE: NONE	SHEET 25			

REVISIONS	
REV	DESCRIPTION

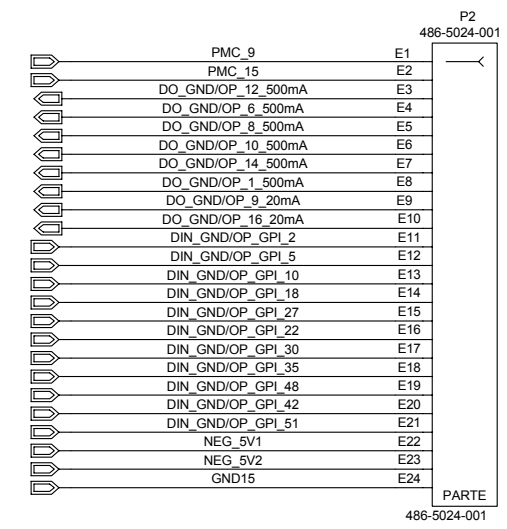
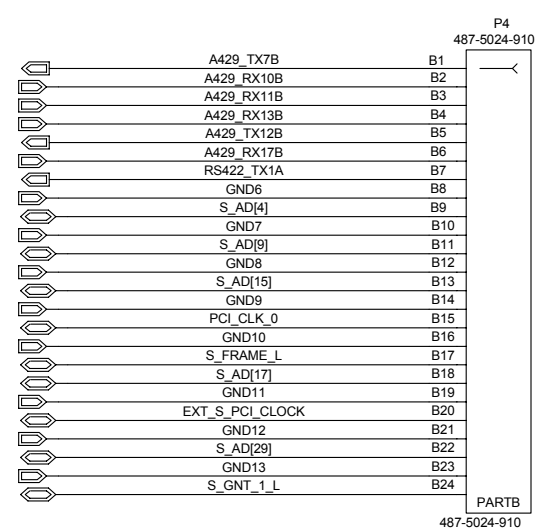
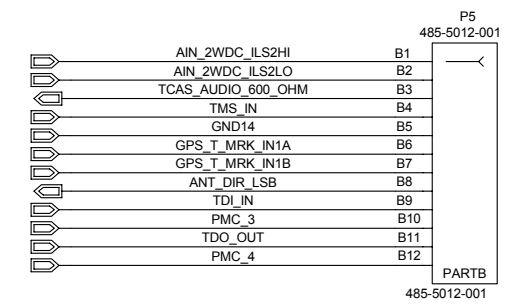
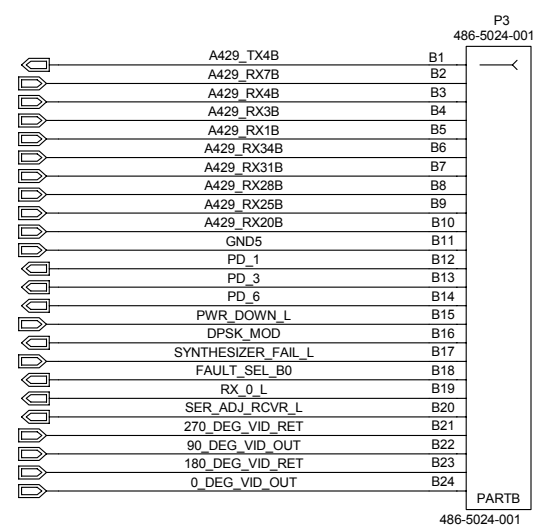

CPA CONNECTOR (ROW B)
A1 REAR INTERCONNECT ASSEMBLY
SHEET NO. 23 OF 27

NOTE:
FOR TROUBLESHOOTING PURPOSES, USE
HEIRARCHICAL CPA CONNECTIONS

COMPUTER GENERATED

REVISIONS	
REV	DESCRIPTION

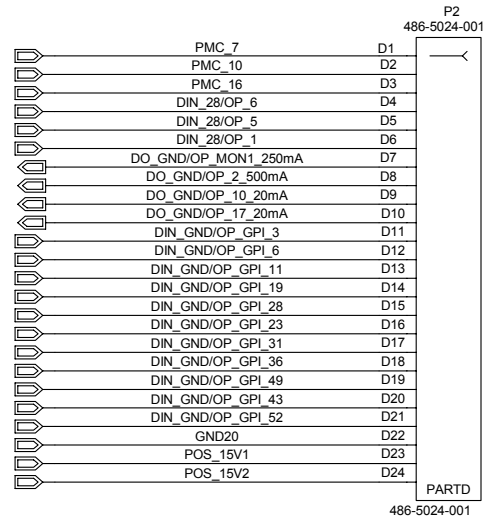
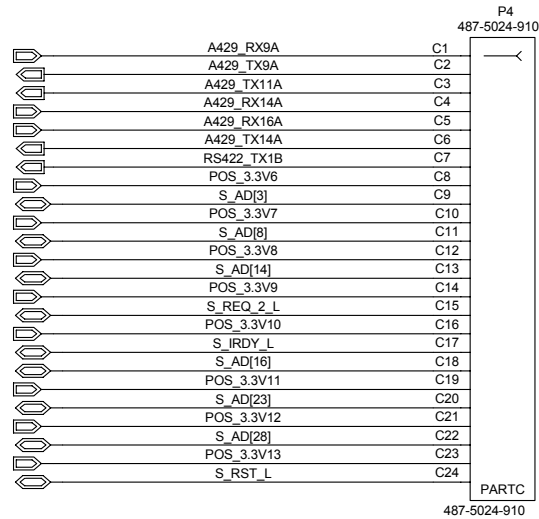
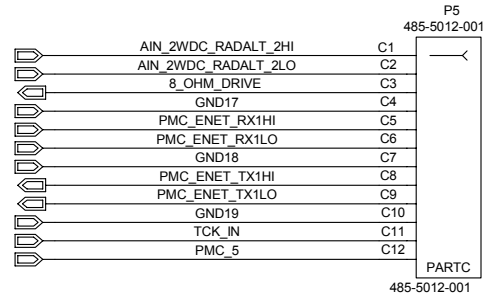
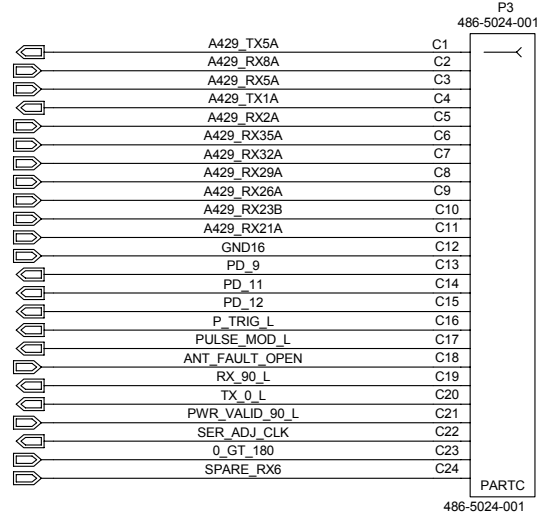

NOTE:
FOR TROUBLESHOOTING PURPOSES, USE
HEIRARCHICAL CPA CONNECTIONS

CPA CONNECTOR (ROW C)
A1 REAR INTERCONNECT ASSEMBLY
SHEET NO. 24 OF 27

COMPUTER GENERATED

ACSS	SEE FIRST SHEET FOR CONTRACT NUMBER. USE OR DISCLOSURE OF INFORMATION ON THIS SHEET IS SUBJECT TO THE RESTRICTIONS ON THE FIRST SHEET OF THIS DOCUMENT.	SIZE	CAGE CODE	DWG NO.	REV
		D	1WYD3	9003010-002	-
SCALE: NONE		SHEET		27	

REVISIONS	
REV	DESCRIPTION

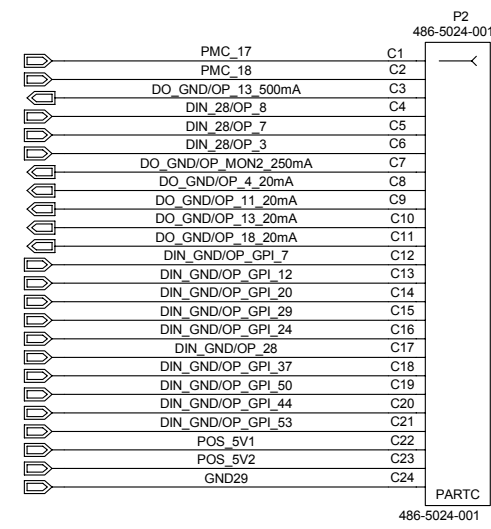
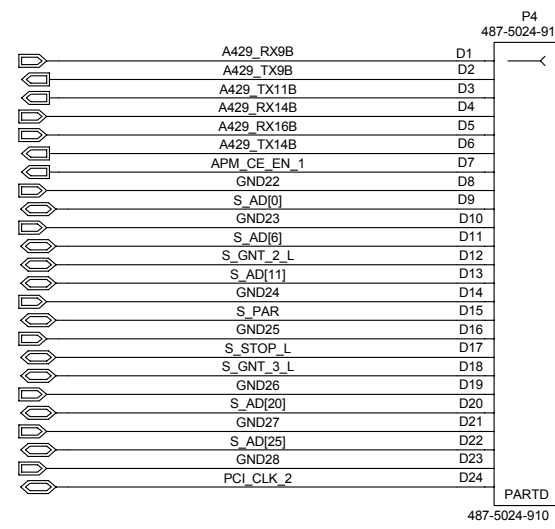
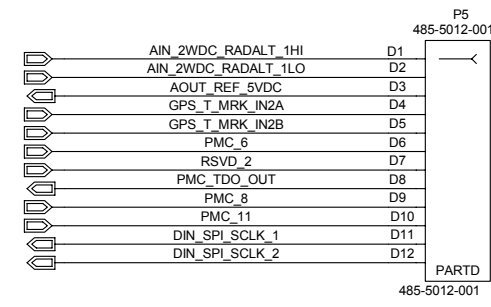
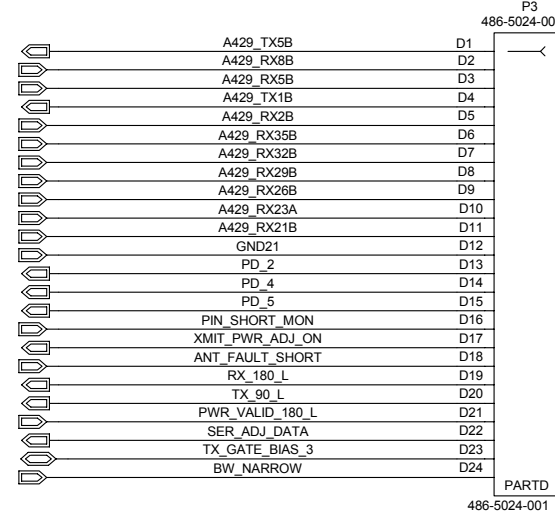

NOTE:
FOR TROUBLESHOOTING PURPOSES, USE
HEIRARCHICAL CPA CONNECTIONS

CPA CONNECTOR (ROW D)
A1 REAR INTERCONNECT ASSEMBLY
SHEET NO. 25 OF 27

COMPUTER GENERATED

ACSS	SEE FIRST SHEET FOR CONTRACT NUMBER. USE OR DISCLOSURE OF INFORMATION ON THIS SHEET IS SUBJECT TO THE RESTRICTIONS ON THE FIRST SHEET OF THIS DOCUMENT.	SIZE D	CAGE CODE 1WYD3	DWG NO. 9003010-002	REV -
	SCALE: NONE	SHEET 28			

REVISIONS	
REV	DESCRIPTION

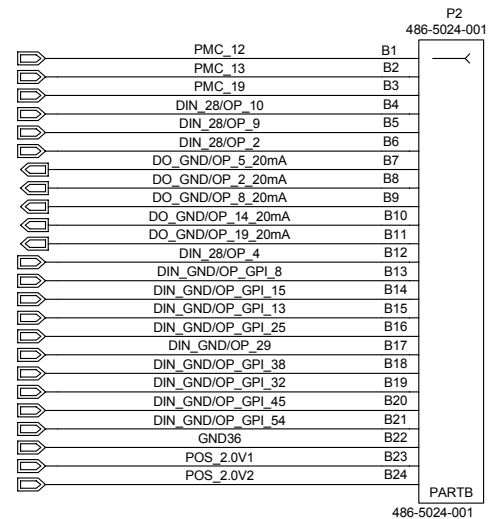
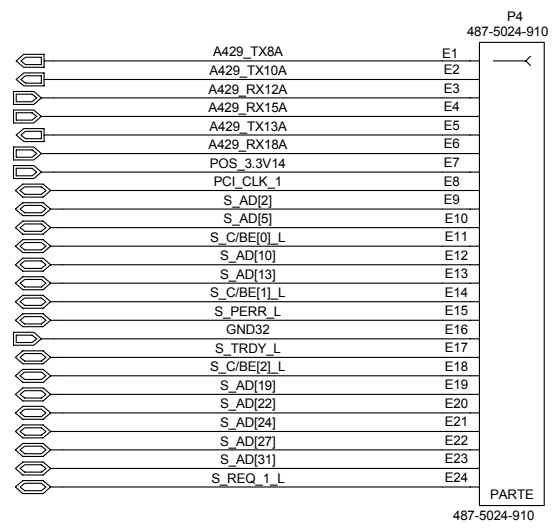
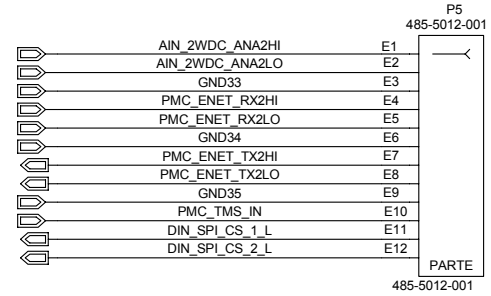
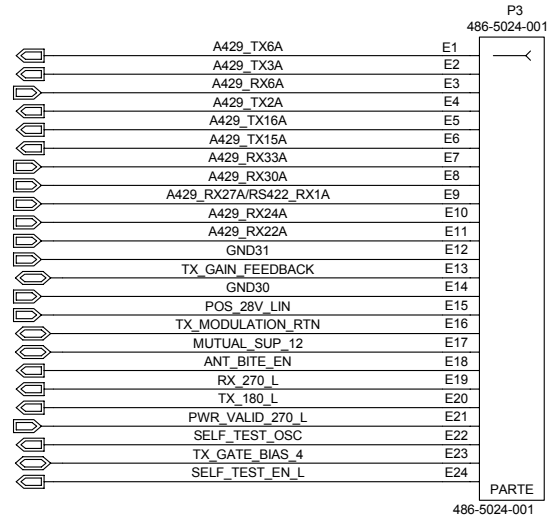

NOTE:
FOR TROUBLESHOOTING PURPOSES, USE
HEIRARCHICAL CPA CONNECTIONS

CPA CONNECTOR (ROW E)
A1 REAR INTERCONNECT ASSEMBLY
SHEET NO. 26 OF 27

COMPUTER GENERATED

REVISIONS	
REV	DESCRIPTION

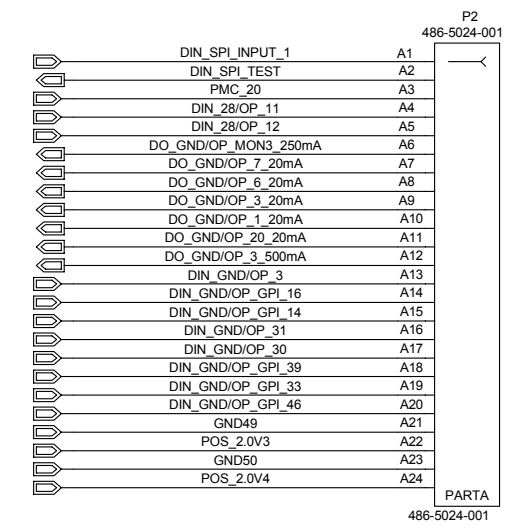
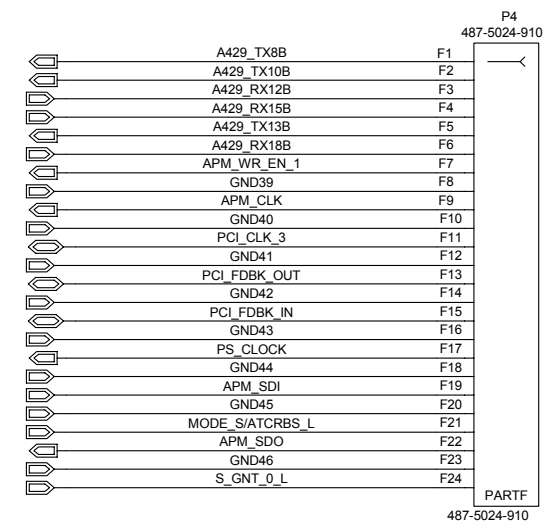
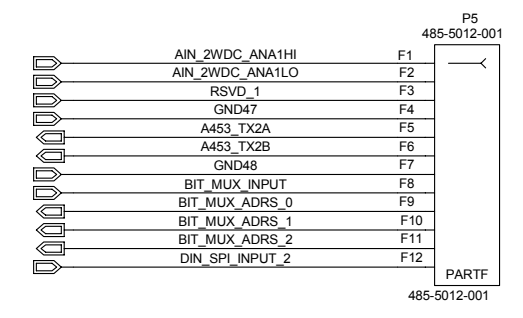
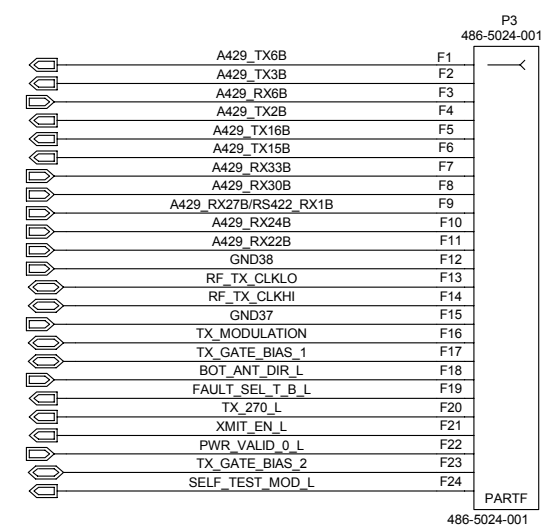

NOTE:
FOR TROUBLESHOOTING PURPOSES, USE
HEIRARCHICAL CPA CONNECTIONS

CPA CONNECTOR (ROW F)
A1 REAR INTERCONNECT ASSEMBLY
SHEET NO. 27 OF 27

COMPUTER GENERATED