



























8 PROPRIETARY NOTICE
 THIS DOCUMENT AND THE INFORMATION DISCLOSED HEREIN ARE PROPRIETARY DATA OF ACSS, LLC. NEITHER THIS DOCUMENT NOR THE INFORMATION CONTAINED HEREIN SHALL BE REPRODUCED, USED, OR DISCLOSED TO OTHERS WITHOUT THE WRITTEN AUTHORIZATION OF ACSS, LLC

7 NOTICE
 FREEDOM OF INFORMATION ACT (5 USC 552) AND DISCLOSURE OF CONFIDENTIAL INFORMATION GENERALLY (18 USC 1905)
 THIS DOCUMENT IS BEING FURNISHED IN CONFIDENCE BY ACSS, LLC THE INFORMATION DISCLOSED HEREIN FALLS WITHIN EXEMPTION (B) (4) OF 5 USC 552 AND THE PROHIBITIONS OF 18 USC 1905.

REVISONS		DESCRIPTION	DATE
007642	—	INITIAL RELEASE	08-27-04
008398	A	SEE DESCRIPTION PER CHANGE REQUEST	05-08-05
008898	B	SEE DESCRIPTION PER CHANGE REQUEST	08-10-05
009089	C	UPDATED NOTE 9.	11-08-05

NOTES:

- ASSEMBLE PER ITEM 701.
-  CAUTION THIS DEVICE IS SUBJECT TO DAMAGE BY ELECTROSTATIC CHARGES.
-  SCREWS ON CCA (ITEM 5) MUST BE REMOVED, 2 PLACES, AND DISCARDED FOR INSTALLATION OF SHIELD (ITEM 18) AND SCREWS (ITEM 29).
-  INSTALL COVER, ITEM 33, USING 24 SCREWS, ITEMS 32, APPLY LOCTITE, ITEM 707, TO THREADS OF ITEM 32 PER ITEM 703 PRIOR TO ASSEMBLY.
-  ROUTE W2 RIBBON CABLE AS SHOWN.
-  DARKENED PORTION INDICATES SOLID PART OF POLARIZING KEYS.
-  ORIENT W1J1 KEYWAY AS SHOWN.
-  FOOT OF A1P1 SHALL BE FLUSH TO .010 BELOW SURFACE A.
-  ORIENT W1E1, W1E2 AND ITEM 14 APPROXIMATELY AS SHOWN.
-  PRIOR TO MOUNTING W1S1 TO ITEM 11, DISCARD NUT SUPPLIED WITH W1S1. APPLY LACQUER (ITEM 706) TO W1S1 BODY AND ITEM 11. CAUTION DO NOT ALLOW ITEM 706 TO CONTACT W1S1 PUSH BUTTON.
-  MARK IDENTIFICATION LABEL USING MATERIALS PER ITEM 702, METHOD R.
- FULLY MATE THE FOLLOWING CONNECTORS:

FROM	TO
 A4J3	W1P1
 A1J2	W2P1
 A1J3	A2P1
 A1J1	A4P2
 A3A2J1	A4P1
 A3A2J2	W3P1
 W3P2	A5J10
 A3A1J1	W4P1
 W4P2	A5J11
 A5J1	W2P2
 A2J6	W1P2
 A2J7	W1P3
 T1P1	A4J1
 A4J2	A6P1
-  ACSS P/N 7517945-903 IS AN ACCEPTABLE SUBSTITUTE FOR A5 (ITEM 5).
-  PRIOR TO INSTALLATION OF ITEM 37 BOND ITEM 36 TO ITEM 4 USING ITEM 709.
-  POSITION ITEM 39 AS SHOWN (CUP FACING DOWNWARD).

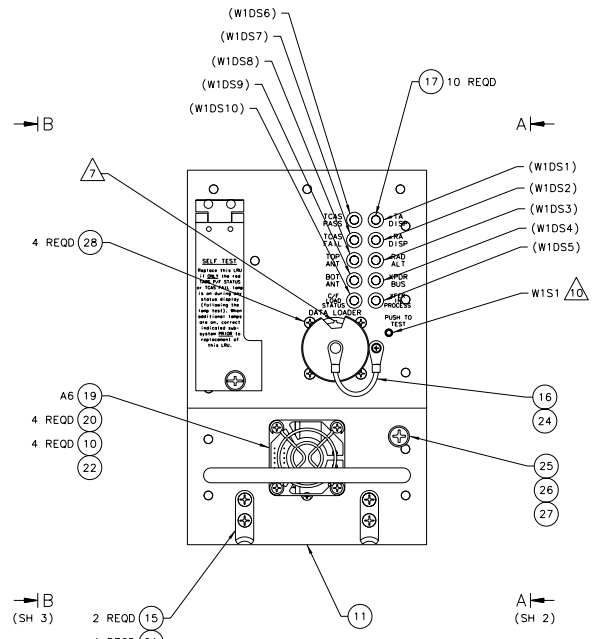

REVISION STATUS OF PARTS LIST SHALL BE THE SAME AS THE BASIC DRAWING NUMBER. SEE SEPARATE PARTS LIST.

UNLESS OTHERWISE SPECIFIED, DIMENSIONS ARE IN INCHES; TOLERANCES: ANGLES ± 2 PL DEC ± 3 PL DEC ±		THIRD ANGLE PROJECTION	OPERATIONAL NOTE
INTERPRET DIMENSIONS AND TOLERANCES PER ANSI Y14.5M-1994		FOR REFERENCE	 Aviation Communication & Surveillance Systems 1800 North 7th Avenue Phoenix, Arizona 85027-4400
ORIGINAL C.R.			
PRODUCT LINE NO.		TITLE	
AW/PS ANALYSIS EB		ASSEMBLY, TCAS 3000 4MCU	
REF. DNG.		DRAWING NO.	
REF. SPEC.		E11WYD31	
9003000-65001	9003000-65001	1318 CASE CODE	9003000-6510
NEXT ASSY	END ITEM	DRAWING NO.	9003000-6510
APPLICATION		SCALE	1/1
		SHEET	1 OF 4

REVISIONS	
CRNG.	REV
008398	A
SEE DESCRIPTION PER CHANGE REQUEST	
05-08-05	

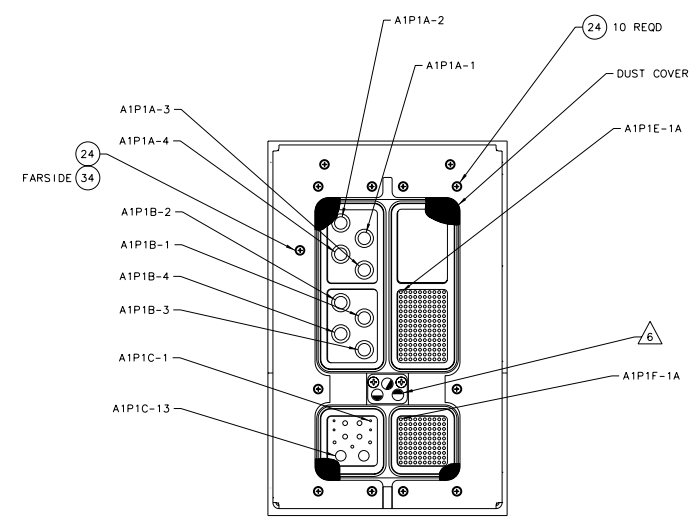
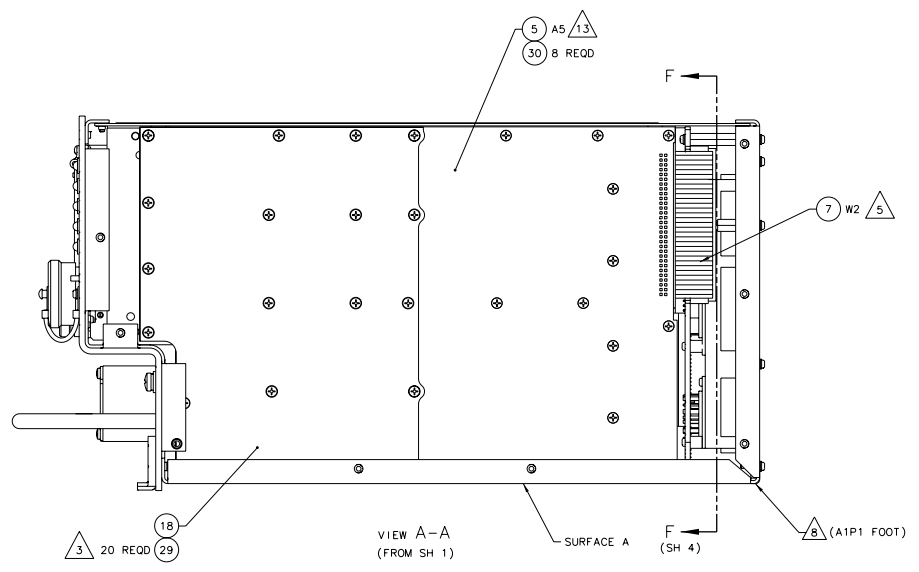
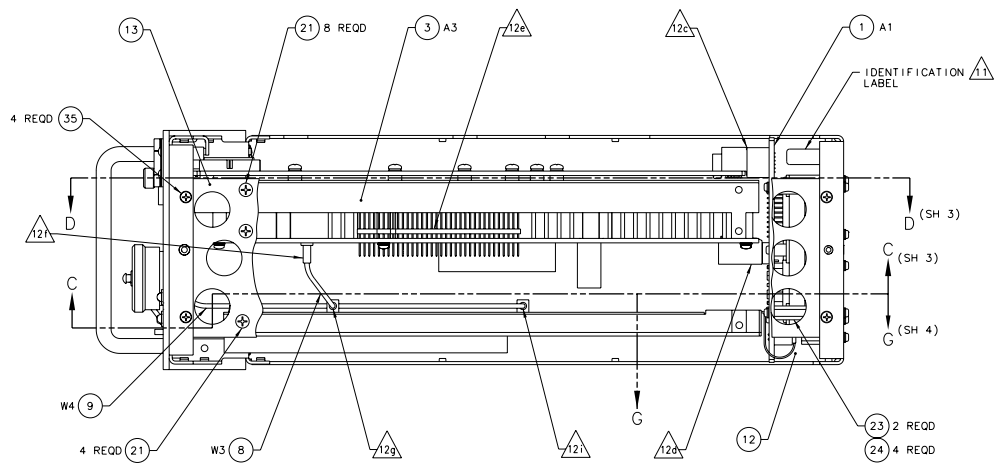

REVISONS		DESCRIPTION	DATE
008398	A	SEE DESCRIPTION PER CHANGE REQUEST	05-08-05
008898	B	SEE DESCRIPTION PER CHANGE REQUEST	08-10-05
009089	C	UPDATED VIEW E-E	11-08-05

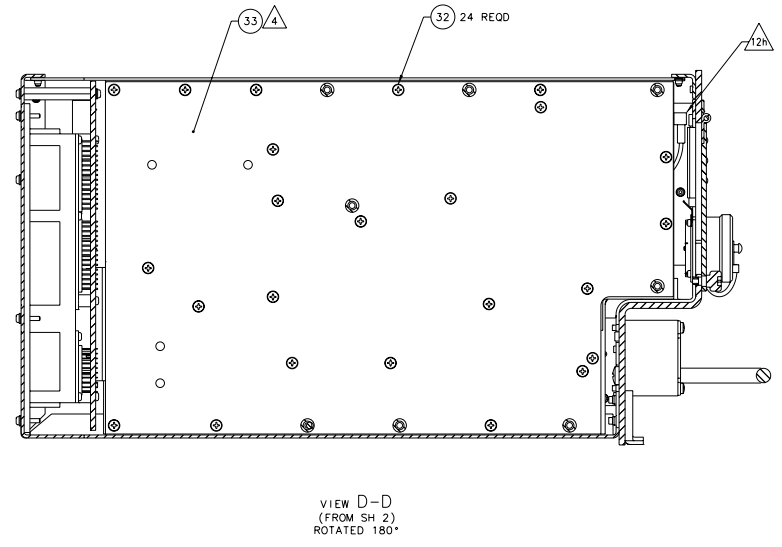
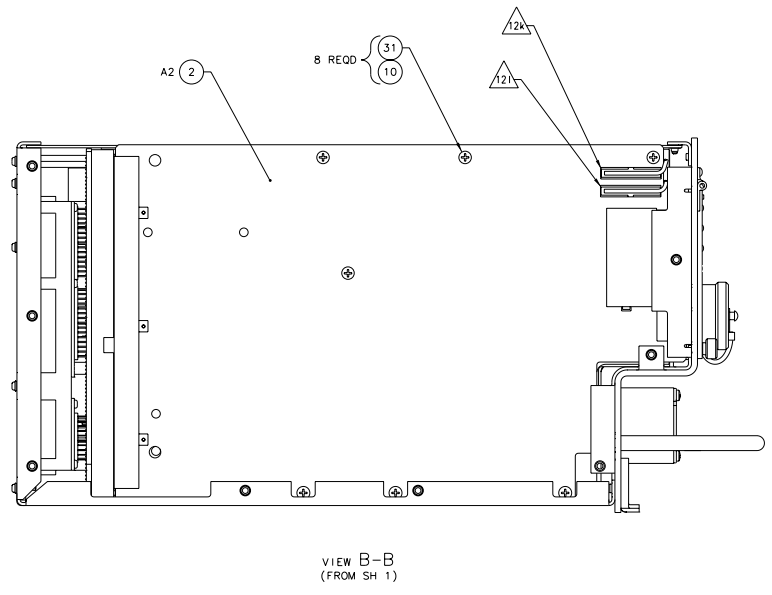
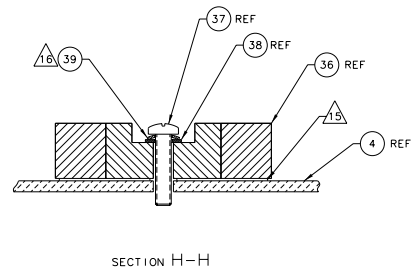
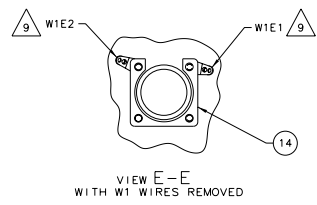
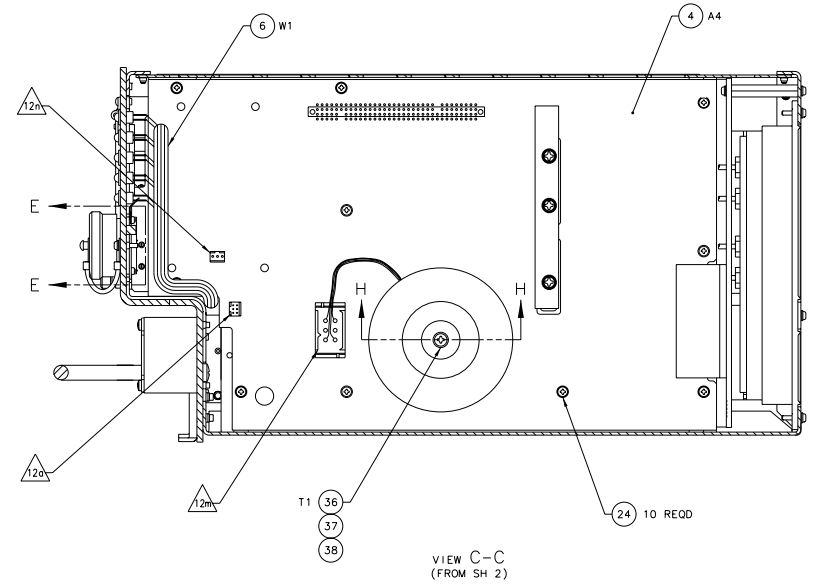

REV ISIONS		DESCRIPTION	
CRNG.	REV	DESCRIPTION	
008398	A	SEE DESCRIPTION PER CHANGE REQUEST	05-08-05

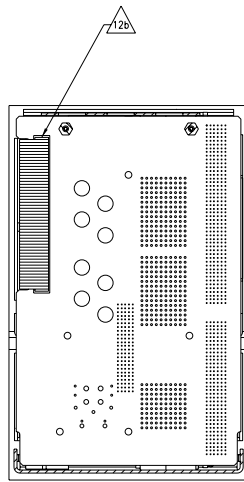

VIEW F-F
(FROM SH 2)
ARINC CONNECTOR (A1P1)
OMITTED FOR CLARITY

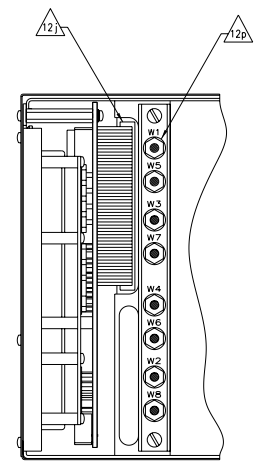

VIEW G-G
(FROM SH 2)
ROTATED 180°