



SHENZHEN HQT SCIENCE & TECHNOLOGY CO., LTD.

For more information, please visit <http://www.hqt-tech.com>

All rights reserved to HQT. Pictures shown in this manual are for your reference only, if there is fluctuation, according to the real object, please.



User Manual
TH-288

Professional Two-way Radio

Welcome

Thank you for your purchase. We are confident that the function and quality will bring you stable, reliable, and clear communication. Please read this manual before operating the radio.

- Ergonomic & Light Design
- 16 Channels
- LED Indicator Light
- Voice Prompts
- VOX
- Time-out-Timer



- Scan
- CTCSS/DCS
- Programmable Key
- Auto Battery Save
- Wired Cloning
- PC Programming

Table of Contents

Safety Information	02	Voice Prompts	14
Product Inspection	04	TOT	14
Getting Started	05	Squelch	14
Attaching & Removing	06	VOX.....	14
Radio Overview.....	08	Scan	14
Basic Operation.....	10	Low Power Alert	15
Advanced Operation.....	12	Battery Saving	15
Monitor.....	13	Wired Clone	16
Battery Power Check	13	Optional Accessories	17
CTCSS & DCS	13	Trouble Shooting	18
Busy Channel Lockout	13	Care and Maintenance	19
DTMF Encode	13	Warranty Statement	20

Appendix I: Specification 21

Appendix II: Technical Terms 22

Safety Information

Please read the following safety guidelines. Nonobservance of these guidelines may cause danger or violation of law.



Warning

Don't transmit with antenna detached from the radio or don't damage or change antenna type. Strong electronic waves are emitted from the radio and damages or changes to the antenna may effect the performance of the radio, and it may cause the radio to be defective and not covered under warranty.



Warning

Don't use other manufacturers' accessories. Unknown or unauthorized accessories may cause the radio to be defective and not covered under warranty.



Warning

Don't disassemble the radio. Disassembly of the radio may cause a serious defect or malfunction and not be covered under warranty.



Warning

Don't give an excessive shock to the radio.
Don't place the radio where the direct sunlight or high temperature occurs.
Don't make a damage to the battery pack by sharp substance or an excessive shock.



Warning

Turn off the radio before boarding on an airplane.
Don't use the radio in the hospital without any pre-approval.
Don't use the radio at the place of where computer or other electronic devices are being used.



Warning

- Please keep the radio at least 1 inch away from the human body.
- Don't give any damage to antenna.
- When using earphone, please reduce the volume to a low level. If not, unexpected high sound may have harmful effect to your ear.
- Don't touch the conductive metal of the battery radio with wet hands. It may cause damage on your hands.
- Please be careful when putting the battery in a pocket or a bag.

• FCC RF EXPOSURE COMPLIANCE REQUIREMENTS FOR OCCUPATIONAL USE ONLY

The Federal Communications Commission (FCC), with its action in General Docket 93-62, November 7, 1997, has adopted a safety standard for human exposure to Radio Frequency (RF) electromagnetic energy emitted by FCC regulated equipment. Proper operation of this radio will result in user exposure far below the Occupational Safety and Health Act (OSHA) and Federal Communications Commission limits.

- **DO NOT** transmit for more than 50% of total radio use time (50% duty cycle). Transmitting more than 50% of the time can cause FCC RF exposure compliance requirements to be exceeded.
- This radio is **NOT** approved for use by the general population in an uncontrolled environment. This radio is restricted to occupational use, work related operations only where radio operator must have the knowledge to control the user's exposure conditions for satisfying the higher exposure limit allowed for occupational use.
- When transmitting, hold the radio in a vertical position with its microphone 1 inch (2.5cm) away from your mouth.
- The radio is transmitting when the red LED on the front of the radio is illuminated. You can cause the radio to transmit by pressing the PTT bar on the radio.
- These are required operating configurations for meeting FCC RF exposure compliance. Failure to observe these restrictions mean violation.

Caution

Any Changes or modifications not expressly approved by the party responsible for compliance could void user's authority to operate the equipment.

This device complies with part 15 of the FCC Rules. Operation is subject to the following two conditions:
(1) This device may not cause harmful interference, and (2) this device must accept any interference received, including interference that may cause undesired operation.

Product Inspection

Thanks for choosing the HQT TH-288 Series radio. Before use, please check that the following contents are included:

Items



Radio TH-288
Qty: 1



Antenna
Qty: 1



Li-Ion battery
Qty: 1



Charger
Qty: 1



Adapler
Qty: 1



Belt Clip with screws
Qty: 1

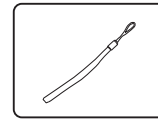

Lanyard Strap
Qty: 1



User Manual
Qty: 1

For any damage or lost contents, please contact your Authorized TecNet Dealer.

 **Note:** For antenna identification, the frequency is marked on the color circle at the bottom of the antenna.

Getting Started

Charging the Battery

Please charge the battery as follows:

1. Turn off the radio for optimum charging.
2. Plug the AC connector of the adaptor into an AC (110~240V) outlet.
3. Insert the battery or radio equipped with battery into the charger.
 - Red LED indicates battery is charging. Green LED indicates charging is complete.
 - The battery is not charged at the factory.

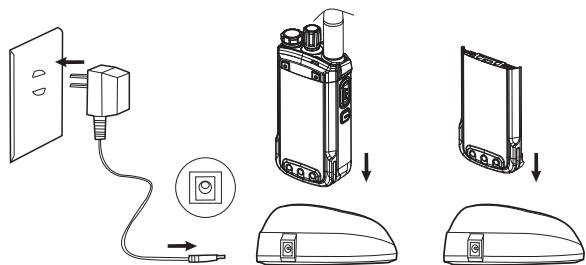

Attaching & Removing

Attaching & Removing the Battery

1. For attaching, slide the battery up from the bottom until it locks securely into place. (figure 1)
2. Before removing, make sure the radio is turned off. For removal, push the battery lock and slide the battery downwards. (figure 2)

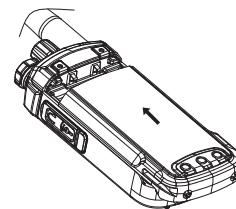

(figure 1)

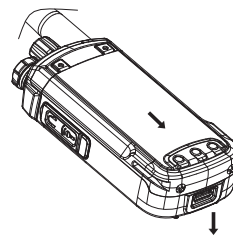

(figure 2)

Attaching & Removing the Belt Clip

To attach the belt clip, secure the belt clip with the 2 screws provided (Phillips head screwdriver required). To remove, reverse the screws and the belt clip can be removed. (figure3). Note: the belt clip does not need to be removed to remove the battery.

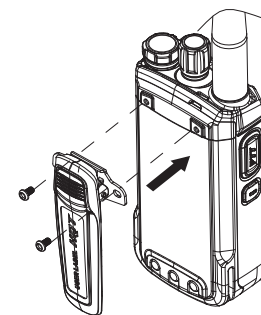

(figure 3)

Attaching & Removing the Antenna

1. To attach, insert the antenna into the connector on the top of the radio by holding the antenna at its base and rotate the antenna clockwise to fasten it. (figure 4) **IMPORTANT: Do not over tighten antenna as it will cause damage to the radio.**

2. To remove, hold the antenna at its base and rotate the antenna counter clockwise until you can remove it. (figure 5)



(figure 4)

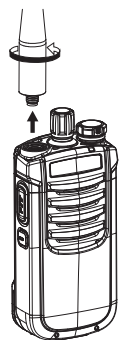

(figure 5)

Attaching External Audio Accessories

Pull down the cover of earphone/microphone jack and insert the correct audio accessory into the jack. Please make sure that the proper audio accessory is being used and that it is properly seated in the jack. (figure 6)

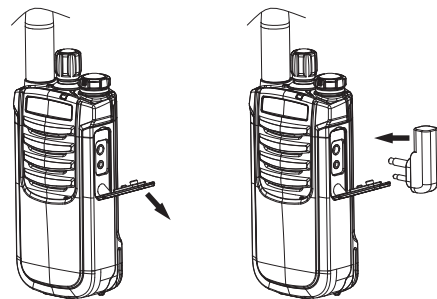

(figure 6)

Radio Overview

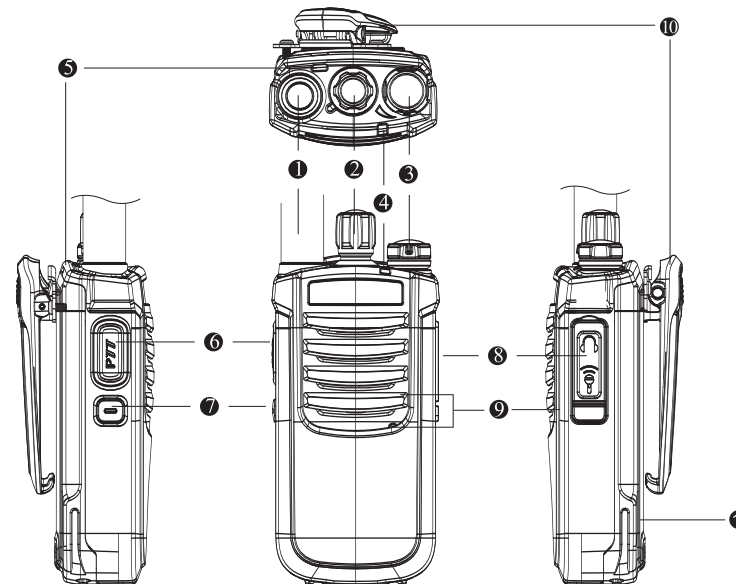

- ① **Antenna**
Antenna with screwed connector is required for proper transmit and receive of radio.
- ② **Channel Selector**
Rotate clockwise or counter clockwise to select operating channel.
- ③ **Power Switch/Volume Control**
Rotate the knob clockwise until a click sounds to turn on the radio. Keep turning clockwise to increase volume. Turn counter clockwise to decrease volume. Keep rotating counter clockwise until a click sounds to turn off radio.
- ④ **LED Indicator**
LED glows red during transmitting; glows green during receiving; flashes red when battery power is insufficient; flashes green during scanning.
- ⑤ **Strap Hole**
For use with lanyard strap.
- ⑥ **Push-To-Talk (PTT)**
Press PTT key to transmit; release it to receive.
- ⑦ **Programmable Key**
Default is battery check with short press and monitor function with long press.
- ⑧ **Audio Jack/Data Port**
Connect the earphone/microphone or data cable.
- ⑨ **Speaker/Microphone**
- ⑩ **Belt Clip**
- ⑪ **Li-Ion Battery**

Basic Operation

1. Turn On/Off

Turn on the radio by rotating Power Switch/Volume Control knob clockwise until a click is sounded. Turn off the radio by rotating Power Switch/Volume Control knob counter clockwise until a click is sounded.



2. Adjust Volume

Rotate Power Switch/Volume Control knob to adjust volume when the radio is on.



Note: The volume can also be adjusted in accordance with background noise during monitoring.

3. Channel Selection

Rotate the channel knob to select operating channel from 1-16 or (15+Scan), according to the numbers and symbols on the bottom of channel selector knob or channel annunciation.



4. Make a Call

To make a call, press PTT key and speak into the microphone with a normal voice. Keep the radio/microphone area 2" (5 cm) away from your mouth.

5. Receive a Call

Calls can be received when PTT is released and the radio is in standby mode.

Advanced Operation

Certain functions can be made possible through programming software as programmed by an Authorized TecNet Dealer.

PC Programming

1. Turn off the radio and connect the programming cable between the radio and PC. (See figure 7)
2. For the setting of parameters and writing to the radio, please refer to the Help documents of the software.

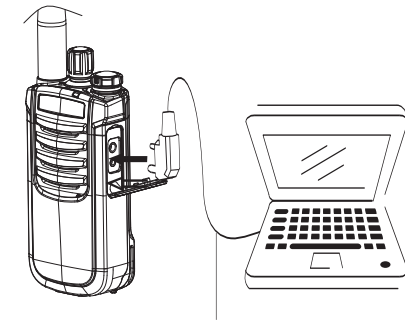
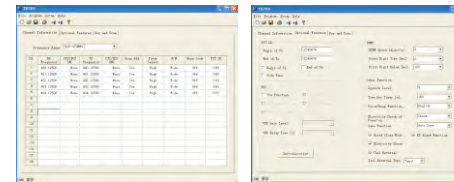

Programming Cable (optional)

(figure 7)

Monitoring

- 1.The receiving status of the selected channel can be checked by a long press of the side button located below the PTT (programmable key). This allows the squelch to open on the radio so any received audio can be heard. Default Mode: Press and hold of the monitor button for up to 2 seconds to monitor the channel for activity.
- 2.When this function is on, the volume can be adjusted with the Volume Control.

Battery Power Check

- 1.The battery level/condition can be checked by a short press of the side button located below the PTT (programmable key). Default Mode: Press momentary and release. The radio will announce the power level as “high battery power”, “battery middle power”, “low battery power” or “please charge”.
- 2.This function is disabled/enabled through the programming software (default is on).

CTCSS/DCS

- 1.With this function, users can receive calls in

corresponding channels only with the same CTCSS/DCS; without this function, users can receive calling from all corresponding channels using the same frequency.

- 2.This function is disabled/enabled through the programming software.

Busy Channel Lockout (BCL)

1. When BCL is activated, it prohibits transmitting on the channel if occupied by other users. This is indicated by an audio alarm when pressing the PTT.
2. When the channel becomes unoccupied, users can resume talk.
3. This function is disabled/enabled through the programming software (default is off).

DTMF Encode

- 1.This function is disabled/enabled through the programming software (default is off).
- 2.If enabled, users can send DTMF code at start or the end of transmission.

Voice Prompts

- 1.Channel voice: the radio would report the channel information when you change the channel.
- 2.Low Power prompt: the radio would report low battery information when the voltage reaches the minimum operating voltage.
- 3.Scan Operation Prompt: the radio would report the information when the channel sets to the designated scanning channel.
- 4.These prompts can be disabled/enabled through the programming software.

Time Out Timer (TOT)

1. The TOT function prevents extended periods of transmitting, which can cause possible damage to the circuitry of the radio.
2. If transmitting occurs longer than the set time, the radio will stop transmitting and an alarm will sound. Cease pressing the PTT. Press PTT again to resume transmitting.
- 3.Default is 180 seconds. The time duration can be changed through the programming software.

Squelch Levels

- 1.Through adjusting squelch level, the radio with a lower squelch level allows weak signals to be received.
- 2.Default level is 4. Levels can be changed through the programming software, which ranges from 0-9. When you choose 0, the squelch is open. Higher numbers tighten the squelch reducing the noise and interference.

VOX

- 1.VOX can be enabled to transmit without pressing the PTT key when the voice signal is transmitted through the microphone of the radio.
- 2.This function is disabled/enabled through the programming software (default is off).

Scan

- 1.This function is disabled/enabled through the programming software (default is off).
2. When the scan function is enabled, channel 16 becomes the scan channel. The LED flashes green and the radio will scan those channels assigned to scan. If a signal is received, the radio will cease

scanning and stop on that channel for the duration of the call.

Low Power Alert

1. When the battery power becomes low during transmitting, receiving, or standby mode, the LED will flash red and the radio will announce “battery low”. You must charge the current battery or replace with a fully charged battery.

Battery Saving

1. If there is no signal or operation after 5 seconds, the battery saving function will occur automatically; when signal is received or transmitted, the radio will switch to normal power mode.
2. Multiple battery save functions can be done through the programming software (default is on).

Wired Clone

1. Cloning can be done with the programming software and cloning cable.
2. Connect the master radio to the slave radio with the cloning cable, and then turn on the slave radio.
3. Press left lower key on master radio for about 3 seconds until LED glows red, release it, then LED glows red and green at the same time, which means the master radio is ready for cloning.
4. Short-press left lower key on master radio again, the red light flashes, and green light on slave radio flashes at the same time, after they stop flashing, clone is finishing.
5. Change another slave radio, connect it to master radio, and press left lower key on master radio again for more same operation.

Note:

If red and green lights on both master and slave radios flash at the same time, it means cloning has failed.

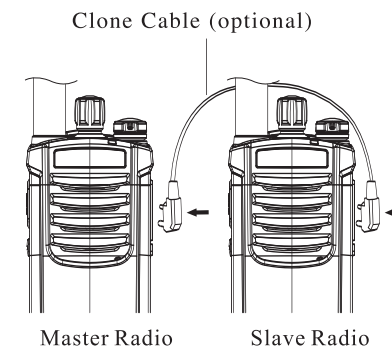

Optional Accessories

Optional Accessories are available according to your requirements, including:



Programming Cable



Audio Accessories

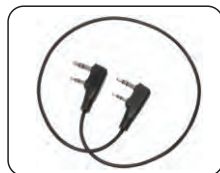

Clone Cable

Trouble Shooting

Problem	Solution
No Power	<ul style="list-style-type: none"> The battery power may be insufficient. Please charge current battery or change to a fully charged battery.
The battery power consumes quickly after charge.	<ul style="list-style-type: none"> The battery life is finished; a new battery would be required.
Can not communicate with other members.	<ul style="list-style-type: none"> Please check if your frequency and CTCSS/DCS are the same with other members in your group. Possibility of being too far away from other members. Please check if you are within communication range.
Voices of non-group members are heard on the channel.	<ul style="list-style-type: none"> Please change CTCSS/DCS, and change those of your members also.
No sound or very low sound are received by partner when transmitting.	<ul style="list-style-type: none"> Please check if the volume is turned to its highest level. Be sure to speak directly into the microphone on the radio.
No reception on the channel.	<ul style="list-style-type: none"> You may be too far away from other members and cannot receive. Please check if you are within communication range and try again.

Care and Maintenance

These recommendations can help you use the radio effectively and years of continued use.

- Keep the radio dry. Rain, moisture or other liquid may cause damage to the radio.
- Do not throw, hit or vibrate the radio. This may cause damage to the inner IC or other elements and void the warranty.
- Do not hold the radio by the antenna or external audio accessories.
- Please use the original or standard antenna. Unapproved antenna or modifications of accessories may cause damage to the radio.
- Cover the earphone/microphone pad when not using the radio for a long time.

- Use a mild detergent (not corrosive chemicals) and cloth to clean the casing.



Note:

All recommendations above also refer to the battery, charger and accessories.

Warranty Statement

Shenzhen HQT Science & Technology Co. Ltd. offers to the original end user:

One (1) Year Limited Warranty on HQT Spartan Series Radios (separate warranty period on accessories).

One (1) Year Limited Warranty on Accessories (includes, but not limited to, batteries, antennas, belt clips, chargers, audio accessories, nylon cases, leather cases, etc.) .

HQT warrants each new radio product manufactured or supplied by it to be free from defects in material and workmanship under normal use and service for the time period stated, provided that the user has complied with the requirements stated herein. The warranty period begins on the date of purchase from an Authorized HQT Dealer. This warranty is not assignable or transferable. This warranty is void if the product serial number is altered, defaced or removed. HQT is not responsible for any equipment that is attached to or used in conjunction with our products.

During the warranty period, if the product fails to function under normal use, because of manufacturing defects or workmanship, it should be returned to the Authorized HQT Dealer from which it was purchased. The Authorized HQT Dealer will repair the product or return the product for repair to HQT or its Authorized Repair Depot. The user is responsible for the removal of the product from a vehicle or any equipment attached to it, or other site of its use; transportation of the product to the Authorized HQT Dealer; for the return of the repaired or replacement product to the site of its use and

for the reinstallation of the product.

HQT shall have no obligation to make repairs or replacement of product which results from normal wear and tear, or is necessitated by catastrophe, fault, or negligence of the user; improper or unauthorized alterations or repairs to the product, incorrect wiring, use for which it was not designed or by causes external to the product. HQT's sole obligation shall be to replace or repair the product covered by the warranty. Replacement is done at HQT's discretion and may consist of a similar or higher featured product. Repair may include the replacement of parts with functionally equivalent new or reconditioned parts. All replaced parts and accessories are warranted for the balance of the original time period. All parts and accessories that are replaced become the property of Shenzhen HQT Science & Technology Co. Ltd.

THE EXPRESS WARRANTIES CONTAINED HEREIN ARE IN LIEU OF ALL OTHER WARRANTIES, EITHER EXPRESSED OR IMPLIED OR STATUTORY, INCLUDING, WITHOUT LIMITATION, ANY WARRANTY OF MERCHANTABILITY OR FITNESS FOR A PARTICULAR PURPOSE.

FOR ANY PRODUCT THAT DOES NOT COMPLY WITH THE WARRANTY SPECIFIED, THE SOLE REMEDY WILL BE REPAIR OR REPLACEMENT. IN NO EVENT WILL HQT BE LIABLE FOR ANY DAMAGES, INCLUDING ANY SPECIAL, INCIDENTAL, INDIRECT OR CONSEQUENTIAL DAMAGES, OR THE LOSS OF PROFIT, REVENUE OR DATA ARISING OUT OF THE USE OF OR THE INABILITY TO USE THE PRODUCT.

Appendix

Appendix I: Specification

Item	TH-288
Frequency Range	136~174MHz/400~470MHz
Channel Number	16
Normal Voltage	DC 3.8V
Working Temperature	-25°C ~55°C
Li-ion Battery	2000mAh
Antenna Impedance	50 Ω
Output Power	2W/1W

Modulation Mode	8k Φ F3E
Max. Frequency Deviation	≤ ±2.5kHz
Audio Distortion	≤5%
Frequency Stability	±2.5PPM
Receiving Sensitivity	0.2μV
Audio Power	700mW
Weight	170g
Dimension	105×54×30mm

Appendix II: Technical Terms

Name	Description
Standby	The radio is in receiving mode when no key is operated.
CTCSS / DCS	CTCSS/DCS is a tone attached to an audio signal. If the CTCSS or DCS tone of the transmitter matches that of the receiver, the speaker is unmuted and the audio will be heard. If they do not match, no audio will be heard.
Battery Save	If there is no signal being received or no operation being conducted for some time, the radio will enter into power saving mode. In this mode, the radio will stop working at regular intervals to save power.
TOT	The Time Out Timer (TOT) is used to prevent extended periods of transmitting. If an extended period of transmitting occurs, this can cause damage to the circuitry of the radio.
Squelch	This is to solve the problem of talk quality and noise. Squelch is to suppress the background noise and keep the radio quiet when no signal is received. It can mute the radio when no signal is received. Turn on the Squelch, and you will hear the sound from the speaker.

Squelch On	In the on condition, the radio is receiving all audio signals.
Monitor	This function enables you to hear all the calls even with unmatched CTCSS/DCS.
Scan	Allows the radio to receive calls on multiple channels.
BCL	When this channel is in use by other users, your radio is prohibited to transmit on the channel to avoid interference.
VOX	VOX enables user to speak into the radio without pressing [PTT] key and the sound is transmitted.
Wired Clone	This is a way to clone parameters from one radio to another one.
Revert Channel	Revert channel refers to the current working channel when pressing [PTT] key during scan.

Appendix III: Frequency & Tone Chart

Channel	Transmit (TX) Frequency	Receive (RX) Frequency	CTCSS Tone TX and RX	Bandwidth W/N
1				
2				
3				
4				
5				
6				
7				
8				
9				
10				
11				
12				
13				
14				
15				
16				