

Company: Alien Technology

Test of: ALR-F800

To: FCC Part 15 Subpart C 15.247 (DTS) & IC RSS-247

Report No.: ALNT60-U2 Rev A



CONDUCTED TEST REPORT

FROM



Test of: Alien Technology ALR-F800

to

To: FCC CFR 47 Part 15 Subpart C 15.247 (DTS)

Test Report Serial No.: ALNT60-U2 Rev A

This report supersedes: NONE

Applicant: Alien Technology, LLC
845 Embedded Way
San Jose, California 95138
USA

Product Function: RFID Reader

Issue Date: 17th August 2015

This Test Report is Issued Under the Authority of:

MiCOM Labs, Inc.
575 Boulder Court
Pleasanton California 94566
USA
Phone: +1 (925) 462-0304
Fax: +1 (925) 462-0306
www.micomlabs.com



MiCOM Labs is an ISO 17025 Accredited Testing Laboratory



Table of Contents

1. ACCREDITATION, LISTINGS & RECOGNITION	4
1.1. TESTING ACCREDITATION.....	4
1.2. RECOGNITION	5
1.3. PRODUCT CERTIFICATION	6
2. DOCUMENT HISTORY	7
3. TEST RESULT CERTIFICATE	8
4. REFERENCES AND MEASUREMENT UNCERTAINTY	9
4.1. Normative References	9
4.2. Test and Uncertainty Procedure	10
5. PRODUCT DETAILS AND TEST CONFIGURATIONS	11
5.1. Technical Details	11
5.2. Scope Of Test Program	12
5.3. Equipment Model(s) and Serial Number(s)	13
5.4. Antenna Details	13
5.5. Cabling and I/O Ports	13
5.6. Test Configurations.....	13
5.7. Equipment Modifications	14
5.8. Deviations from the Test Standard	14
6. TEST SUMMARY	15
7. TEST EQUIPMENT CONFIGURATION(S)	16
7.1. Conducted	16
7.2. Radiated Emissions.....	18
7.3. ac Wireline Emission.....	20
8. MEASUREMENT AND PRESENTATION OF TEST DATA	21
9. TEST RESULTS	22
9.1. 20 dB & 99% Bandwidth	22
9.2. Number Of Channels	24
9.3. Channel Spacing	26
9.4. Dwell Time & Channel Occupancy	28
9.5. Conducted Output Power	30
9.6. Conducted Spurious Emissions.....	33
9.6.1. Conducted Emissions	33
9.6.1.1. Spurious Emissions.....	33
9.6.1.2. Band-Edge Emissions	35
9.7. Radiated Testing.....	37
9.4.1. Radiated Spurious Emissions	37
9.4.2. Digital Emissions (0.03 – 1 GHz)	45
9.8. ac Wireline Emissions.....	55
A. APPENDIX - GRAPHICAL IMAGES	59
A.1. 20 dB & 99% Bandwidth	60
A.2. Number Of Channels.....	63
A.3. Channel Spacing	66
A.4. Dwell Time & Channel Occupancy.....	67
A.5. Emissions	69
A.5.1. Conducted Emissions.....	69
A.5.1.1. Conducted Spurious Emissions	69
A.5.1.2. Conducted Band-Edge Emissions	72

This test report may be reproduced in full only. The document may only be updated by MiCOM Labs personnel. All changes will be noted in the Document History section of the report.

1. ACCREDITATION, LISTINGS & RECOGNITION

1.1. TESTING ACCREDITATION

MiCOM Labs, Inc. is an accredited Electrical testing laboratory per the international standard ISO/IEC 17025:2005. The company is accredited by the American Association for Laboratory Accreditation (A2LA) www.a2la.org test laboratory number 2381.01. MiCOM Labs test schedule is available at the following URL; <http://www.a2la.org/scopepdf/2381-01.pdf>



This test report may be reproduced in full only. The document may only be updated by MiCOM Labs personnel. All changes will be noted in the Document History section of the report.



Title: Alien Technology ALR-F800
To: FCC CFR 47 Part 15 Subpart C 15.247 (DTS)
Serial #: ALNT60-U2 Rev A
Issue Date: 17th August 2015
Page: 5 of 74

1.2. RECOGNITION

MiCOM Labs, Inc has widely recognized wireless testing capabilities. Our international recognition includes Conformity Assessment Body designation by APEC MRA countries. MiCOM Labs test reports are accepted globally.

Country	Recognition Body	Status	Phase	Identification No.
USA	Federal Communications Commission (FCC)	TCB	-	US0159 Listing #: 102167
Canada	Industry Canada (IC)	FCB	APEC MRA 2	US0159 Listing #: 4143A-2 4143A-3
Japan	MIC (Ministry of Internal Affairs and Communication)	CAB	APEC MRA 2	RCB 210
	VCCI	--	--	A-0012
Europe	European Commission	NB	EU MRA	NB 2280
Australia	Australian Communications and Media Authority (ACMA)	CAB	APEC MRA 1	US0159
Hong Kong	Office of the Telecommunication Authority (OFTA)	CAB	APEC MRA 1	
Korea	Ministry of Information and Communication Radio Research Laboratory (RRL)	CAB	APEC MRA 1	
Singapore	Infocomm Development Authority (IDA)	CAB	APEC MRA 1	
Taiwan	National Communications Commission (NCC) Bureau of Standards, Metrology and Inspection (BSMI)	CAB	APEC MRA 1	
Vietnam	Ministry of Communication (MIC)	CAB	APEC MRA 1	

EU MRA – European Union Mutual Recognition Agreement.

NB – Notified Body

APEC MRA – Asia Pacific Economic Community Mutual Recognition Agreement. Recognition agreement under which test lab is accredited to regulatory standards of the APEC member countries.

Phase I - recognition for product testing

Phase II – recognition for both product testing and certification

This test report may be reproduced in full only. The document may only be updated by MiCOM Labs personnel. All changes will be noted in the Document History section of the report.

1.3. PRODUCT CERTIFICATION

MiCOM Labs, Inc. is an accredited Product Certification Body per the international standard ISO/IEC 17065:2012. The company is accredited by the American Association for Laboratory Accreditation (A2LA) www.a2la.org test laboratory number 2381.02. MiCOM Labs test schedule is available at the following URL; <http://www.a2la.org/scopepdf/2381-02.pdf>



American Association for Laboratory Accreditation

Accredited Product Certification Body

A2LA has accredited

MICOM LABS

Pleasanton, CA

for technical competence as a

Product Certification Body

This product certification body is accredited in accordance with the recognized International Standard ISO/IEC 17065:2012 - *Requirements for bodies certifying products, processes and services*. This accreditation demonstrates technical competence for a defined scope and the operation of a quality management system.

Presented this 28th day of February 2014.



President & CEO
For the Accreditation Council
Certificate Number 2381.02
Valid to November 30, 2015

For the product certification schemes to which this accreditation applies, please refer to the organization's Product Certification Scope of Accreditation

United States of America – Telecommunication Certification Body (TCB)
Industry Canada – Certification Body, CAB Identifier – US0159
Europe – Notified Body (NB), NB Identifier - 2280
Japan – Recognized Certification Body (RCB), RCB Identifier - 210

This test report may be reproduced in full only. The document may only be updated by MiCOM Labs personnel. All changes will be noted in the Document History section of the report.



Title: Alien Technology ALR-F800
To: FCC CFR 47 Part 15 Subpart C 15.247 (DTS)
Serial #: ALNT60-U2 Rev A
Issue Date: 17th August 2015
Page: 7 of 74

2. DOCUMENT HISTORY

Document History		
Revision	Date	Comments
Draft	13 th August 2015	
Rev A	17 th August 2015	Initial Release
.		
.		
.		
.		
.		

In the above table the latest report revision will replace all earlier versions.

This test report may be reproduced in full only. The document may only be updated by MiCOM Labs personnel. All changes will be noted in the Document History section of the report.



Title: Alien Technology ALR-F800
To: FCC CFR 47 Part 15 Subpart C 15.247 (DTS)
Serial #: ALNT60-U2 Rev A
Issue Date: 17th August 2015
Page: 8 of 74

3. TEST RESULT CERTIFICATE

Manufacturer: Alien Technology, LLC 845 Embedded Way San Jose California 95138 USA	Tested By: MiCOM Labs, Inc. 575 Boulder Court, Pleasanton California 94566 USA
Model: ALR-F800	Telephone: +1 925 462 0304 Fax: +1 925 462 0306
Type Of Equipment: RFID Reader	
S/N's: Engineering Sample	
Test Date(s): 5 th – 12 th August 2015	Website: www.micomlabs.com

STANDARD(S)	TEST RESULTS
FCC CFR 47 Part 15 Subpart C 15.247 (DTS)	EQUIPMENT COMPLIES

MiCOM Labs, Inc. tested the equipment mentioned in accordance with the requirements set forth in the above standards. Test results indicate that the equipment tested is capable of demonstrating compliance with the requirements as documented within this report.

Notes:

1. This document reports conditions under which testing was conducted and the results of testing performed.
2. Details of test methods used have been recorded and kept on file by the laboratory.
3. Test results apply only to the item(s) tested.

Approved & Released for MiCOM Labs, Inc. by:



Graeme Grieve
Quality Manager MiCOM Labs, Inc.

Gordon Hurst
President & CEO MiCOM Labs, Inc.

This test report may be reproduced in full only. The document may only be updated by MiCOM Labs personnel. All changes will be noted in the Document History section of the report.



Title: Alien Technology ALR-F800
To: FCC CFR 47 Part 15 Subpart C 15.247 (DTS)
Serial #: ALNT60-U2 Rev A
Issue Date: 17th August 2015
Page: 9 of 74

4. REFERENCES AND MEASUREMENT UNCERTAINTY

4.1. Normative References

REF.	PUBLICATION	YEAR	TITLE
I	KDB 662911	Oct 31 2013	Guidance for measurement of output emission of devices that employ single transmitter with multiple outputs or systems with multiple transmitters operating simultaneously in the same frequency band
II	KDB 558074 D01 v03r03	9th June 2015	Guidance for performing compliance measurements on Digital Transmission Systems (DTS) operating under section 15.247.
III	A2LA	June 2015	R105 - Requirement's When Making Reference to A2LA Accreditation Status
IV	ANSI C63.10	2013	American National Standard for Testing Unlicensed Wireless Devices
V	ANSI C63.4	2014	American National Standards for Methods of Measurement of Radio-Noise Emissions from Low-Voltage Electrical and Electronic Equipment in the Range of 9 kHz to 40 GHz
VI	CISPR 22	2008	Information technology equipment - Radio disturbance characteristics - Limits and methods of measurement
VII	ETSI TR 100 028	2001-12	Parts 1 and 2 Electromagnetic compatibility and Radio Spectrum Matters (ERM); Uncertainties in the measurement of mobile radio equipment characteristics
VIII	FCC 47 CFR Part 15.247	2014	Radio Frequency Devices; Subpart C – Intentional Radiators
IX	ICES-003	Issue 5 2012	Spectrum Management and Telecommunications; Interference-Causing Equipment Standard. Information Technology Equipment (ITE) – Limits and methods of measurement.
X	M 3003	Edition 3 Nov. 2012	Expression of Uncertainty and Confidence in Measurements
XI	RSS-247 Issue 1	May 2015	Digital Transmission Systems (DTSs), Frequency Hopping System (FHSs) and Licence-Exempt Local Area Network (LE-LEN) Devices
XII	RSS-Gen Issue 4	November 2014	General Requirements and Information for the Certification of Radiocommunication Equipment
XIII	KDB 644545 D03 v01	August 14th 2014	Guidance for IEEE 802.11ac New Rules
XIV	FCC 47 CFR Part 2.1033	2014	FCC requirements and rules regarding photographs and test setup diagrams.

This test report may be reproduced in full only. The document may only be updated by MiCOM Labs personnel. All changes will be noted in the Document History section of the report.



Title: Alien Technology ALR-F800
To: FCC CFR 47 Part 15 Subpart C 15.247 (DTS)
Serial #: ALNT60-U2 Rev A
Issue Date: 17th August 2015
Page: 10 of 74

4.2. Test and Uncertainty Procedure

Conducted and radiated emission measurements were conducted in accordance with American National Standards Institute ANSI C63.4, listed in the Normative References section of this report.

Measurement uncertainty figures are calculated in accordance with ETSI TR 100 028 Parts 1 and 2.

Measurement uncertainties stated are based on a standard uncertainty multiplied by a coverage factor $k = 2$, providing a level of confidence of approximately 95 % in accordance with UKAS document M 3003 listed in the Normative References section of this report.

This test report may be reproduced in full only. The document may only be updated by MiCOM Labs personnel. All changes will be noted in the Document History section of the report.



Title: Alien Technology ALR-F800
To: FCC CFR 47 Part 15 Subpart C 15.247 (DTS)
Serial #: ALNT60-U2 Rev A
Issue Date: 17th August 2015
Page: 11 of 74

5. PRODUCT DETAILS AND TEST CONFIGURATIONS

5.1. Technical Details

Details	Description
Purpose:	Test of the Alien Technology ALR-F800 to FCC CFR 47 Part 15 Subpart C 15.247 (DTS). Radio Frequency Devices; Subpart C – Intentional Radiators
Applicant:	Alien Technology, LLC 845 Embedded Way San Jose California 95138 USA
Manufacturer:	As Applicant
Laboratory performing the tests:	MiCOM Labs, Inc. 575 Boulder Court Pleasanton California 94566 USA
Test report reference number:	ALNT60 - ALR F800 FCC IC
Date EUT received:	04 August 2015
Standard(s) applied:	FCC CFR 47 Part 15 Subpart C 15.247 (DTS)
Dates of test (from - to):	05 - 05 August 2015
No of Units Tested:	2
Type of Equipment:	RFID Reader
Product Family Name:	ALR-F800
Model(s):	ALR-F800
Location for use:	Indoor
Declared Frequency Range(s):	902 - 928 MHz;
Primary function of equipment:	RFID Reader
Secondary function of equipment:	None Provided
Type of Modulation:	PRSK
Declared Nominal Output Power (Ave):	+30 dBm
Transmit/Receive Operation:	Transceiver
Rated Input Voltage and Current:	POE (POE adaptor sold with unit) 48Vdc
Operating Temperature Range:	Declared Range -20°C to 55°C
ITU Emission Designator:	67K0A1D
Equipment Dimensions:	20.2cm (H) x 19.1cm (W) x 2.8cm (D)
Weight:	0.85kg
Hardware Rev:	Rev. A
Firmware Rev:	15.07.23.00

This test report may be reproduced in full only. The document may only be updated by MiCOM Labs personnel. All changes will be noted in the Document History section of the report.

5.2. Scope Of Test Program

Alien Technology ALR-F800

The scope of the test program was to test the Alien Technology ALR-F800, DRM configurations in the frequency ranges 902 - 928 MHz; for compliance against the following specification:

FCC CFR 47 Part 15 Subpart C 15.247 (DTS)

Radio Frequency Devices; Subpart C – Intentional Radiators

Alien Technology ALR-F800



This test report may be reproduced in full only. The document may only be updated by MiCOM Labs personnel. All changes will be noted in the Document History section of the report.



Title: Alien Technology ALR-F800
To: FCC CFR 47 Part 15 Subpart C 15.247 (DTS)
Serial #: ALNT60-U2 Rev A
Issue Date: 17th August 2015
Page: 13 of 74

5.3. Equipment Model(s) and Serial Number(s)

Type	Description	Manufacturer	Model	Serial no.	Delivery Date
EUT	RFID Reader	Alien Technology	ALR-F800	Engineering Sample	5 th August 2015

5.4. Antenna Details

Type	Manufacturer	Model	Family	Gain (dBi)	BF Gain	Dir BW	X-Pol	Frequency Band (MHz)
external	Times-7	A6590C	Select One	6.0	-	80	-	902 - 928
external	Alien Technology	ALR-8696	Select One	5.5	-	65	-	902 - 928

BF Gain - Beamforming Gain
Dir BW - Directional BeamWidth
X-Pol - Cross Polarization

5.5. Cabling and I/O Ports

Port Type	Max Cable Length	# Of Ports	Screened	Conn Type	Data Type
USB	15m	1	Y	Type A	Digital
USB	15m	1	Y	Type B	Digital
RS232		1	N	DB-9	Digital
Ethernet	100m	1	N	RJ-45	Packet Data
dc Jack		1	N	Jack	Vdc

5.6. Test Configurations

Results for the following configurations are provided in this report:

Channel Frequency (MHz)		
Low	Mid	High
902.0 – 928.0 MHz		
902.75	915.25	927.25

This test report may be reproduced in full only. The document may only be updated by MiCOM Labs personnel. All changes will be noted in the Document History section of the report.



Title: Alien Technology ALR-F800
To: FCC CFR 47 Part 15 Subpart C 15.247 (DTS)
Serial #: ALNT60-U2 Rev A
Issue Date: 17th August 2015
Page: 14 of 74

5.7. Equipment Modifications

The following modifications were required to bring the equipment into compliance:

1. NONE

5.8. Deviations from the Test Standard

The following deviations from the test standard were required in order to complete the test program:

1. NONE

This test report may be reproduced in full only. The document may only be updated by MiCOM Labs personnel. All changes will be noted in the Document History section of the report.



Title: Alien Technology ALR-F800
To: FCC CFR 47 Part 15 Subpart C 15.247 (DTS)
Serial #: ALNT60-U2 Rev A
Issue Date: 17th August 2015
Page: 15 of 74

6. TEST SUMMARY

List of Measurements

Test Header	Result	Data Link
Conducted Test Results		
15.247(a)(2) 20 dB & 99% Bandwidth	Complies	View Data
15.247(b), 15.31(e) Conducted Output Power	Complies	View Data
15.247(d) Emissions	-	-
(1) Conducted Emissions	-	-
(i) Conducted Spurious Emissions	Complies	View Data
(ii) Conducted Band-Edge Emissions	Complies	View Data
15.247(e) Power Spectral Density	Complies	View Data
Radiated Test Results		
Radiated Spurious Emissions	Complies	View Data
Radiated Digital Emissions	Complies	View Data
ac Wireline Emissions		
ac Wireline Emissions	Complies	View Data

This test report may be reproduced in full only. The document may only be updated by MiCOM Labs personnel. All changes will be noted in the Document History section of the report.

7. TEST EQUIPMENT CONFIGURATION(S)

7.1. Conducted

Conducted RF Emission Test Set-up(s)

The following tests were performed using the conducted test set-up shown in the diagram below

1. 20 dB & 99% Bandwidth
2. Conducted Output Power
3. Conducted Spurious Emissions
4. Conducted Spurious Band-Edge Emissions

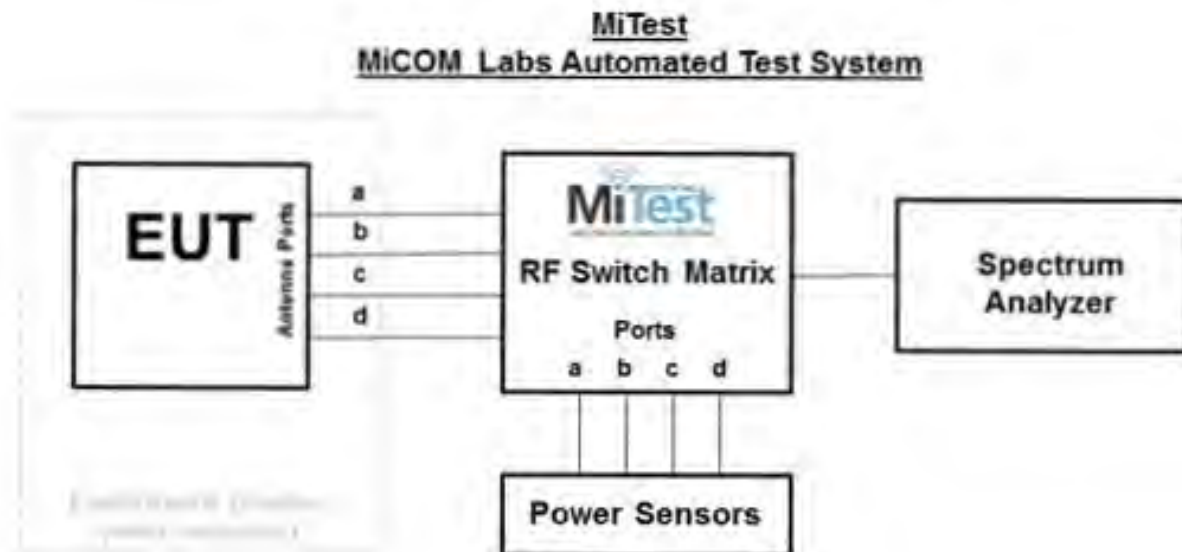

Conducted Test Measurement Setup

A full system calibration was performed on the test station and any resulting system losses (or gains) were taken into account in the production of all final measurement data.



Title: Alien Technology ALR-F800
To: FCC CFR 47 Part 15 Subpart C 15.247 (DTS)
Serial #: ALNT60-U2 Rev A
Issue Date: 17th August 2015
Page: 17 of 74

Asset#	Description	Manufacturer	Model#	Serial#	Calibration Due Date
158	Barometer/Thermometer	Control Company	4196	E2846	04 Dec 2015
248	Resistance Thermometer	Thermotronics	GR2105-02	9340 #1	30 Oct 2015
287	Rohde & Schwarz 40 GHz Receiver	Rhode & Schwarz	ESIB40	100201	31 Jul 2016
376	USB 10MHz - 18GHz Average Power Sensor	Agilent	U2000A	MY51440005	28 Oct 2015
381	4x4 RF Switch Box	MiCOM Labs	MiTest RF Switch Box	MIC002	20 Dec 2015
419	Laptop with Labview Software	Lenova	W520	TS02	Not Required
420	USB to GPIB Interface	National Instruments	GPIB-USB HS	1346738	Not Required
460	Dell Computer with installation of MiTest executable.	Dell	Optiplex330	BC944G1	Not Required
RF#2 GPIB#1	GPIB cable to Power Supply	HP	GPIB	None	Not Required
RF#2 SMA#1	EUT to Mitest box port 1	Flexco	SMA Cable port1	None	20 Dec 2015
RF#2 USB#1	USB Cable to Mitest Box	Dynex	USB Cable	None	Not Required

This test report may be reproduced in full only. The document may only be updated by MiCOM Labs personnel. All changes will be noted in the Document History section of the report.

7.2. Radiated Emissions

The following tests were performed using the conducted test set-up shown in the diagram below.

1. Section 9.4.1 Spurious Emissions
2. Section 9.4.2 Restricted Band-Edge Emissions
3. Section 9.5 Radiated Digital Emissions

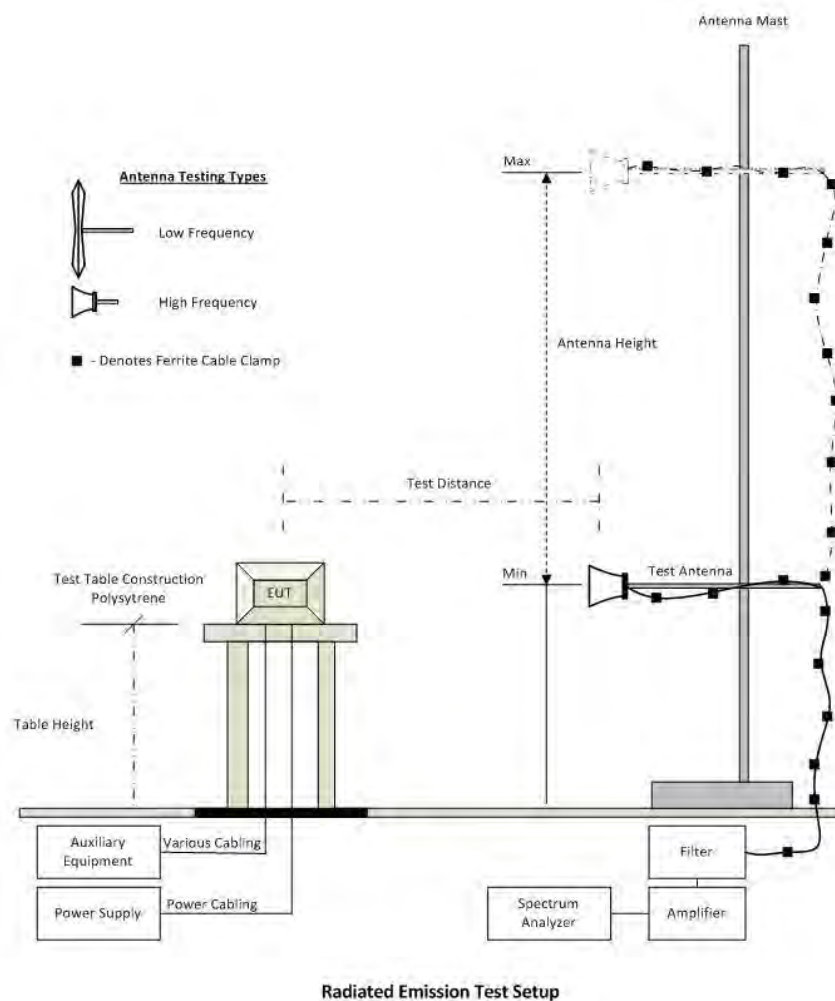

A full system calibration was performed on the test station and any resulting system losses (or gains) were taken into account in the production of all final measurement data.

This test report may be reproduced in full only. The document may only be updated by MiCOM Labs personnel. All changes will be noted in the Document History section of the report.



Title: Alien Technology ALR-F800
To: FCC CFR 47 Part 15 Subpart C 15.247 (DTS)
Serial #: ALNT60-U2 Rev A
Issue Date: 17th August 2015
Page: 19 of 74

Asset#	Description	Manufacturer	Model#	Serial#	Calibration Due Date
158	Barometer/Thermometer	Control Company	4196	E2846	04 Dec 2015
170	Video System Controller for Semi Anechoic Chamber	Panasonic	WV-CY101	04R08507	Not Required
287	Rohde & Schwarz 40 GHz Receiver	Rhode & Schwarz	ESIB40	100201	31 Jul 2016
310	SMA Cable	Micro-Coax	UFA210A-0-0787-3G03G0	209089-001	30 Oct 2015
338	Sunol 30 to 3000 MHz Antenna	Sunol	JB3	A052907	14 Aug 2015
393	DC - 1050 MHz Low Pass Filter	Microcircuits	VLFX-1050	N/A	08 Oct 2015
397	Amp 10 - 2500MHz	MiCOM Labs	Amp 10 - 2500 MHz	NA	23 Oct 2015
399	ETS 1-18 GHz Horn Antenna	ETS	3117	00154575	10 Oct 2015
406	Amplifier for Radiated Emissions	MiCOM Labs	40dB 1 to 18GHz Amp	0406	28 May 2016
410	Desktop Computer	Dell	Inspiron 620	WS38	Not Required
411	Mast/Turntable Controller	Sunol Sciences	SC98V	060199-1D	Not Required
412	USB to GPIB Interface	National Instruments	GPIB-USB HS	11B8DC2	Not Required
413	Mast Controller	Sunol Science	TWR95-4	030801-3	Not Required
415	Turntable Controller	Sunol Sciences	Turntable Controller	None	Not Required
416	Gigabit ethernet filter	ETS-Lingren	Gigafoil 260366	None	Not Required
462	Schwarzbeck cable from Antenna to Amplifier.	Schwarzbeck	AK 9513	462	25 Aug 2015
463	Schwarzbeck cable from Amplifier to Bulkhead.	Schwarzbeck	AK 9513	463	25 Aug 2015
464	Schwarzbeck cable from Bulkhead to Receiver	Schwarzbeck	AK 9513	464	25 Aug 2015
465	Low Pass Filter DC-1000 MHz	Mini-Circuits	NLP-1200+	VUU01901402	25 Aug 2015
468	Low pass filter	Mini Circuits	SLP-550	None	30 Sep 2015
469	Low pass filter	Mini Circuit	SLP-1000	None	30 Sep 2015
470	High Pass filter	Mini Circuits	SHP-700	None	30 Sep 2015
CC05	Confidence Check	MiCOM	CC05	None	1 Aug 2015

This test report may be reproduced in full only. The document may only be updated by MiCOM Labs personnel. All changes will be noted in the Document History section of the report.

7.3. ac Wireline Emission

The following tests were performed using the conducted test set-up shown in the diagram below.

1. Section 9.6 ac Wireline Conducted Emissions

Test Measurement Set up

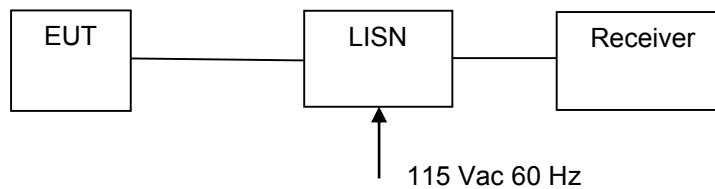

Measurement set up for AC Wireline Conducted Emissions Test

Traceability of Test Equipment Utilized for ac Wireline Emission Testing

Asset#	Description	Manufacturer	Model#	Serial#	Calibration Due Date
158	Barometer/Thermometer	Control Company	4196	E2846	04 Dec 2015
184	Pulse Limiter	Rhode & Schwarz	ESH3Z2	357.8810.52	Cal when used
190	LISN (two-line V-network)	Rhode & Schwarz	ESH3Z5	836679/006	12 Sep 2015
287	Rohde & Schwarz 40 GHz Receiver	Rhode & Schwarz	ESIB40	100201	31 Jul 2016
316	Dell desktop computer workstation with Vasona	Dell	Desktop	WS04	Not Required

This test report may be reproduced in full only. The document may only be updated by MiCOM Labs personnel. All changes will be noted in the Document History section of the report.

8. MEASUREMENT AND PRESENTATION OF TEST DATA

The measurement and graphical data presented in this test report was generated automatically using state-of-the-art technology creating an easy to read report structure. Numerical measurement data is separated from supporting graphical data (plots) through hyperlinks. Numerical measurement data can be reviewed without scrolling through numerous graphical pages to arrive at the next data matrix.

Plots have been relegated into the Appendix 'Graphical Data'.

Test and report automation was performed by [MiTest](#). [MiTest](#) is an automated test system developed by MiCOM Labs. [MiTest](#) is the first cloud based modular test system enabling end-to-end automation of regulatory compliance testing for conducted RF testing.



The MiCOM Labs "[MiTest](#)" Automated Test System" (Patent Pending)

This test report may be reproduced in full only. The document may only be updated by MiCOM Labs personnel. All changes will be noted in the Document History section of the report.



Title: Alien Technology ALR-F800
To: FCC CFR 47 Part 15 Subpart C 15.247 (DTS)
Serial #: ALNT60-U2 Rev A
Issue Date: 17th August 2015
Page: 22 of 74

9. TEST RESULTS

9.1. 20 dB & 99% Bandwidth

Conducted Test Conditions for 20 dB and 99% Bandwidth			
Standard:	FCC CFR 47:15.247	Ambient Temp. (°C):	24.0 - 27.5
Test Heading:	20 dB and 99 % Bandwidth	Rel. Humidity (%):	32 - 45
Standard Section(s):	15.247 (a)(2)	Pressure (mBars):	999 - 1001
Reference Document(s):	See Normative References		

Test Procedure for 20 dB and 99% Bandwidth Measurement

The bandwidth at 20 dB and 99 % was measured with a spectrum analyzer connected to the antenna terminal, while EUT is operating in transmission mode at the appropriate center frequency.

Testing was performed under ambient conditions at nominal voltage. Where the device operated with multiple antenna ports i.e. MIMO device, each port was measured and reported.

Test configuration and setup used for the measurement was per the Conducted Test Set-up specified in this document.

Limits for 20 dB and 99% Bandwidth

(a) Operation under the provisions of this Section is limited to frequency hopping and digitally modulated intentional radiators that comply with the following provisions:

(i) For frequency hopping systems operating in the 902-928 MHz band: if the 20 dB bandwidth of the hopping channel is less than 250 kHz, the system shall use at least 50 hopping frequencies and the average time of occupancy on any frequency shall not be greater than 0.4 seconds within a 20 second period; if the 20 dB bandwidth of the hopping channel is 250 kHz or greater, the system shall use at least 25 hopping frequencies and the average time of occupancy on any frequency shall not be greater than 0.4 seconds within a 10 second period. The maximum allowed 20 dB bandwidth of the hopping channel is 500 kHz.

This test report may be reproduced in full only. The document may only be updated by MiCOM Labs personnel. All changes will be noted in the Document History section of the report.



Title: Alien Technology ALR-F800
To: FCC CFR 47 Part 15 Subpart C 15.247 (DTS)
Serial #: ALNT60-U2 Rev A
Issue Date: 17th August 2015
Page: 23 of 74

Equipment Configuration for 20 dB & 99% Bandwidth

Variant:	PRSK	Duty Cycle (%):	99.00
Data Rate:	25.00 Tari	Antenna Gain (dBi):	5.30
Modulation:	PRSK	Beam Forming Gain (Y)(dB):	Not Applicable
TPC:	Not Applicable	Tested By:	CC
Engineering Test Notes:			

Test Measurement Results

Test Frequency	Measured 20 dB Bandwidth (MHz)				20 dB Bandwidth (MHz)		Limit	Lowest Margin
	Port(s)				Highest	Lowest		
	MHz	a	b	c			d	KHz
902.8	0.028	--	--	--	0.028	0.028	≤500.0	-0.472
915.3	0.077	--	--	--	0.077	0.077	≤500.0	-0.423
927.3	0.077	--	--	--	0.077	0.077	≤500.0	-0.423

Test Frequency	Measured 99% Bandwidth (MHz)				Maximum 99% Bandwidth (MHz)		
	Port(s)						
	MHz	a	b	c	d		
902.8	0.025	--	--	--	0.025		
915.3	0.066	--	--	--	0.066		
927.3	0.067	--	--	--	0.067		

Traceability to Industry Recognized Test Methodologies	
Work Instruction:	WI-03 MEASURING RF SPECTRUM MASK
Measurement Uncertainty:	±2.81 dB

Note: click the links in the above matrix to view the graphical image (plot).

This test report may be reproduced in full only. The document may only be updated by MiCOM Labs personnel. All changes will be noted in the Document History section of the report.



Title: Alien Technology ALR-F800
To: FCC CFR 47 Part 15 Subpart C 15.247 (DTS)
Serial #: ALNT60-U2 Rev A
Issue Date: 17th August 2015
Page: 24 of 74

9.2. Number Of Channels

Conducted Test Conditions for Number Of Channels			
Standard:	FCC CFR 47:15.247	Ambient Temp. (°C):	24.0 - 27.5
Test Heading:	Number of Channels	Rel. Humidity (%):	32 - 45
Standard Section(s):	15.247 (a)(2)	Pressure (mBars):	999 - 1001
Reference Document(s):	See Normative References		

Test Procedure

The number of channels and channel occupancy is measured with a spectrum analyzer connected to the antenna terminal, while the EUT is operating in transmission mode at the appropriate center frequency and modulation.

Testing was performed under ambient conditions at nominal voltage. Where the device operated with multiple antenna ports i.e. MIMO device, each port was measured and reported.

Test configuration and setup used for the measurement was per the Conducted Test Set-up specified in this document.

Limit

For frequency hopping systems operating in the 902-928 MHz band: if the 20 dB bandwidth of the hopping channel is less than 250 kHz, the system shall use at least 50 hopping frequencies; if the 20 dB bandwidth of the hopping channel is 250 kHz or greater, the system shall use at least 25 hopping frequencies.

This test report may be reproduced in full only. The document may only be updated by MiCOM Labs personnel. All changes will be noted in the Document History section of the report.



Title: Alien Technology ALR-F800
To: FCC CFR 47 Part 15 Subpart C 15.247 (DTS)
Serial #: ALNT60-U2 Rev A
Issue Date: 17th August 2015
Page: 25 of 74

Equipment Configuration for Hopping Sequence			
Variant:	PRSK	Duty Cycle (%):	99.00
Data Rate:	25.00 Tari	Antenna Gain (dBi):	5.30
Modulation:	PRSK	Beam Forming Gain (Y)(dB):	Not Applicable
TPC:	Not Applicable	Tested By:	CC
Engineering Test Notes:			

Test Measurement Results					
Modulation	Frequency Range (MHz)	Number of Hopping Channels	Limit	Total Number of Hops	Results
			No of Hopping Channels		
PRSK	900.00 – 912.00	19	≥ 50	19	
PRSK	912.00 – 920.00	16	≥ 50	16	
PRSK	920.00 – 928.00	15	≥ 50	15	
Total No. of Hopping Channels:				50	Pass

Traceability to Industry Recognized Test Methodologies	
Work Instruction:	WI-03 MEASURING RF SPECTRUM MASK
Measurement Uncertainty:	±2.81 dB

Note: click the links in the above matrix to view the graphical image (plot).

This test report may be reproduced in full only. The document may only be updated by MiCOM Labs personnel. All changes will be noted in the Document History section of the report.



Title: Alien Technology ALR-F800
To: FCC CFR 47 Part 15 Subpart C 15.247 (DTS)
Serial #: ALNT60-U2 Rev A
Issue Date: 17th August 2015
Page: 26 of 74

9.3. Channel Spacing

Conducted Test Conditions for 6 dB and 99% Bandwidth			
Standard:	FCC CFR 47:15.247	Ambient Temp. (°C):	24.0 - 27.5
Test Heading:	Channel Spacing	Rel. Humidity (%):	32 - 45
Standard Section(s):	15.247 (a)(2)	Pressure (mBars):	999 - 1001
Reference Document(s):	See Normative References		

Test Procedure
The number of channels and channel occupancy is measured with a spectrum analyzer connected to the antenna terminal, while the EUT is operating in transmission mode at the appropriate center frequency and modulation.

Testing was performed under ambient conditions at nominal voltage. Where the device operated with multiple antenna ports i.e. MIMO device, each port was measured and reported.

Test configuration and setup used for the measurement was per the Conducted Test Set-up specified in this document.

Limit
(1) Frequency hopping systems shall have hopping channel carrier frequencies separated by a minimum of 25 kHz or the 20 dB bandwidth of the hopping channel, whichever is greater. Alternatively, frequency hopping systems operating in the 2400-2483.5 MHz band may have hopping channel carrier frequencies that are separated by 25 kHz or two-thirds of the 20 dB bandwidth of the hopping channel, whichever is greater, provided the systems operate with an output power no greater than 125 mW. The system shall hop to channel frequencies that are selected at the system hopping rate from a pseudo randomly ordered list of hopping frequencies. Each frequency must be used equally on the average by each transmitter. The system receivers shall have input bandwidths that match the hopping channel bandwidths of their corresponding transmitters and shall shift frequencies in synchronization with the transmitted signals.

This test report may be reproduced in full only. The document may only be updated by MiCOM Labs personnel. All changes will be noted in the Document History section of the report.



Title: Alien Technology ALR-F800
To: FCC CFR 47 Part 15 Subpart C 15.247 (DTS)
Serial #: ALNT60-U2 Rev A
Issue Date: 17th August 2015
Page: 27 of 74

Equipment Configuration for Channel Separation

Variant:	PRSK	Duty Cycle (%):	Not Applicable
Data Rate:	25.00 Tari	Antenna Gain (dBi):	Not Applicable
Modulation:	PRSK	Beam Forming Gain (Y)(dB):	Not Applicable
TPC:	Not Applicable	Tested By:	CC
Engineering Test Notes:			

Test Measurement Results

Center Frequency	Packet Type	Chan Separation	Limit (20 dB Occ. BW)	Result
MHz		MHz	MHz	
902.75	PRSK	0.507	> 0.077	Pass

Traceability to Industry Recognized Test Methodologies

Measurement Uncertainty:	±2.81 dB (Spectrum/Amplitude), ±0.86 ppm (Frequency)
--------------------------	--

Note: click the links in the above matrix to view the graphical image (plot).

This test report may be reproduced in full only. The document may only be updated by MiCOM Labs personnel. All changes will be noted in the Document History section of the report.



Title: Alien Technology ALR-F800
To: FCC CFR 47 Part 15 Subpart C 15.247 (DTS)
Serial #: ALNT60-U2 Rev A
Issue Date: 17th August 2015
Page: 28 of 74

9.4. Dwell Time & Channel Occupancy

Conducted Test Conditions for Channel Occupancy			
Standard:	FCC CFR 47:15.247	Ambient Temp. (°C):	24.0 - 27.5
Test Heading:	Dwell Time & Channel Occupancy	Rel. Humidity (%):	32 - 45
Standard Section(s):	15.247 (a)(2)	Pressure (mBars):	999 - 1001
Reference Document(s):	See Normative References		

Test Procedure

The number of channels and channel occupancy is measured with a spectrum analyzer connected to the antenna terminal, while the EUT is operating in transmission mode at the appropriate center frequency and modulation.

Testing was performed under ambient conditions at nominal voltage. Where the device operated with multiple antenna ports i.e. MIMO device, each port was measured and reported.

Test configuration and setup used for the measurement was per the Conducted Test Set-up specified in this document.

Limit

(i) For frequency hopping systems operating in the 902-928 MHz band: if the 20 dB bandwidth of the hopping channel is less than 250 kHz, the average time of occupancy on any frequency shall not be greater than 0.4 seconds within a 20 second period; if the 20 dB bandwidth of the hopping channel is 250 kHz or greater, the average time of occupancy on any frequency shall not be greater than 0.4 seconds within a 10 second period.

This test report may be reproduced in full only. The document may only be updated by MiCOM Labs personnel. All changes will be noted in the Document History section of the report.



Title: Alien Technology ALR-F800
To: FCC CFR 47 Part 15 Subpart C 15.247 (DTS)
Serial #: ALNT60-U2 Rev A
Issue Date: 17th August 2015
Page: 29 of 74

Equipment Configuration for Dwell Time & Channel Occupancy

Variant:	PRSK	Duty Cycle (%):	Not Applicable
Data Rate:	25.00 Tari	Antenna Gain (dBi):	Not Applicable
Modulation:	PRSK	Beam Forming Gain (Y)(dB):	Not Applicable
TPC:	Not Applicable	Tested By:	CC
Engineering Test Notes:			

Test Measurement Results

Center Frequency MHz	Packet Type	Dwell Time (Single Channel)	Limit (Single Channel)	Channel Occupancy Limit	Result
		mS	mS	s	
902.75	PRSK	395.00	400	20	Pass

Traceability to Industry Recognized Test Methodologies

Measurement Uncertainty:	±2.81 dB (Spectrum/Amplitude), ±0.86 ppm (Frequency)
--------------------------	--

Note: click the links in the above matrix

This test report may be reproduced in full only. The document may only be updated by MiCOM Labs personnel. All changes will be noted in the Document History section of the report.



9.5. Conducted Output Power

Conducted Test Conditions for Fundamental Emission Output Power			
Standard:	FCC CFR 47:15.247	Ambient Temp. (°C):	24.0 - 27.5
Test Heading:	Output Power	Rel. Humidity (%):	32 - 45
Standard Section(s):	15.247 (b) & (c)	Pressure (mBars):	999 - 1001
Reference Document(s):	See Normative References		

Test Procedure for Fundamental Emission Output Power Measurement
In the case of average power measurements an average power sensor was utilized.

For peak power measurements the spectrum analyzer built-in power function was used to integrate peak power over the 20 dB bandwidth.

Testing was performed under ambient conditions at nominal voltage only. Where the device operated with multiple antenna ports i.e. MIMO device, each port was measured, summed (Σ) and reported.

Test configuration and setup used for the measurement was per the Conducted Test Set-up specified in this document.

Supporting Information
Calculated Power = $A + G + Y + 10 \log (1/x)$ dBm

A = Total Power [$10 \cdot \text{Log}_{10} (10^{a/10} + 10^{b/10} + 10^{c/10} + 10^{d/10})$]
G = Antenna Gain
Y = Beamforming Gain
x = Duty Cycle (average power measurements only)

Limits for Fundamental Emission Output Power

(b) The maximum peak conducted output power of the intentional radiator shall not exceed the following for non-frequency hopping systems:

(3) For systems using digital modulation in the 902-928 MHz and 2400-2483.5 MHz bands: 1 Watt. As an alternative to a peak power measurement, compliance with the one Watt limit can be based on a measurement of the maximum conducted output power. Maximum Conducted Output Power is defined as the total transmit power delivered to all antennas and antenna elements averaged across all symbols in the signaling alphabet when the transmitter is operating at its maximum power control level. Power must be summed across all antennas and antenna elements. The average must not include any time intervals during which the transmitter is off or is transmitting at a reduced power level. If multiple modes of operation are possible (e.g., alternative modulation methods), the maximum conducted output power is the highest total transmit power occurring in any mode.

(4) The conducted output power limit specified in paragraph (b) of this section is based on the use of antennas with directional gains that do not exceed 6 dBi. Except as shown in paragraph (c) of this section, if transmitting antennas of directional gain greater than 6 dBi are used, the conducted output power from the intentional radiator shall be reduced below the stated values in paragraphs (b)(3) of this section, as appropriate, by the amount in dB that the directional gain of the antenna exceeds 6 dBi.

(c) Operation with directional antenna gains greater than 6 dBi.

(1) Fixed point-to-point operation:

(i) Systems operating in the 2400-2483.5 MHz band that are used exclusively for fixed, point-to-point operations may employ transmitting antennas with directional gain greater than 6 dBi provided the maximum conducted output power of the intentional radiator is reduced by 1 dB for every 3 dB that the directional gain of the antenna exceeds 6 dBi.

(iii) Fixed, point-to-point operation, as used in paragraphs (c)(1)(i) and (c)(1)(ii) of this section, excludes the use of point-to-multipoint systems, omnidirectional applications, and multiple co-located intentional radiators transmitting the same information. The operator of the spread spectrum or digitally modulated intentional radiator or, if the equipment is professionally installed, the installer is responsible for ensuring that the system is used exclusively for fixed, point-to-point operations. The instruction manual furnished with the intentional radiator shall contain language in the installation

This test report may be reproduced in full only. The document may only be updated by MiCOM Labs personnel. All changes will be noted in the Document History section of the report.



Title: Alien Technology ALR-F800
To: FCC CFR 47 Part 15 Subpart C 15.247 (DTS)
Serial #: ALNT60-U2 Rev A
Issue Date: 17th August 2015
Page: 31 of 74

instructions informing the operator and the installer of this responsibility.

(2) In addition to the provisions in paragraphs (b)(3), (b)(4) and (c)(1)(i) of this section, transmitters operating in the 2400-2483.5 MHz band that emit multiple directional beams, simultaneously or sequentially, for the purpose of directing signals to individual receivers or to groups of receivers provided the emissions comply with the following:

(i) Different information must be transmitted to each receiver.

(ii) If the transmitter employs an antenna system that emits multiple directional beams but does not do emit multiple directional beams simultaneously, the total output power conducted to the array or arrays that comprise the device, i.e., the sum of the power supplied to all antennas, antenna elements, staves, etc. and summed across all carriers or frequency channels, shall not exceed the limit specified in paragraph (b)(1) or (b)(3) of this section, as applicable. However, the total conducted output power shall be reduced by 1 dB below the specified limits for each 3 dB that the directional gain of the antenna/antenna array exceeds 6 dBi. The directional antenna gain shall be computed as follows:

(A) The directional gain shall be calculated as the sum of 10 log (number of array elements or staves) plus the directional gain of the element or stave having the highest gain.

(B) A lower value for the directional gain than that calculated in paragraph (c)(2)(ii)(A) of this section will be accepted if sufficient evidence is presented, e.g., due to shading of the array or coherence loss in the beamforming.

(iii) If a transmitter employs an antenna that operates simultaneously on multiple directional beams using the same or different frequency channels, the power supplied to each emission beam is subject to the power limit specified in paragraph (c)(2)(ii) of this section. If transmitted beams overlap, the power shall be reduced to ensure that their aggregate power does not exceed the limit specified in paragraph (c)(2)(ii) of this section. In addition, the aggregate power transmitted simultaneously on all beams shall not exceed the limit specified in paragraph (c)(2)(ii) of this section by more than 8 dB.

(iv) Transmitters that emit a single directional beam shall operate under the provisions of paragraph (c)(1) of this section.

This test report may be reproduced in full only. The document may only be updated by MiCOM Labs personnel. All changes will be noted in the Document History section of the report.



Title: Alien Technology ALR-F800
To: FCC CFR 47 Part 15 Subpart C 15.247 (DTS)
Serial #: ALNT60-U2 Rev A
Issue Date: 17th August 2015
Page: 32 of 74

Equipment Configuration for Average Output Power

Variant:	PRSK	Duty Cycle (%):	99.00
Data Rate:	25.00 Tari	Antenna Gain (dBi):	5.30
Modulation:	PRSK	Beam Forming Gain (Y)(dB):	Not Applicable
TPC:	Not Applicable	Tested By:	CC
Engineering Test Notes:			

Test Measurement Results

Test Frequency MHz	Measured Output Power (dBm)				Calculated Total Power Σ Port(s) + DCCF (+0.04 dB) dBm	Limit dBm	Margin dB	EUT Power Setting
	a	b	c	d				
902.8	28.74	--	--	--	28.78	30.00	-1.22	315.00
915.3	28.57	--	--	--	28.61	30.00	-1.39	315.00
927.3	28.51	--	--	--	28.55	30.00	-1.45	315.00

Traceability to Industry Recognized Test Methodologies

Work Instruction:	WI-01 MEASURING RF OUTPUT POWER
Measurement Uncertainty:	± 1.33 dB

DCCF - Duty Cycle Correction Factor

This test report may be reproduced in full only. The document may only be updated by MiCOM Labs personnel. All changes will be noted in the Document History section of the report.



Title: Alien Technology ALR-F800
To: FCC CFR 47 Part 15 Subpart C 15.247 (DTS)
Serial #: ALNT60-U2 Rev A
Issue Date: 17th August 2015
Page: 33 of 74

9.6. Conducted Spurious Emissions

9.6.1. Conducted Emissions

9.6.1.1. Spurious Emissions

Conducted Test Conditions for Transmitter Conducted Spurious and Band-Edge Emissions			
Standard:	FCC CFR 47:15.247	Ambient Temp. (°C):	24.0 - 27.5
Test Heading:	Max Unwanted Emission Levels	Rel. Humidity (%):	32 - 45
Standard Section(s):	15.247 (d)	Pressure (mBars):	999 - 1001
Reference Document(s):	See Normative References		

Test Procedure for Transmitter Conducted Spurious and Band-Edge Emissions Measurement

Transmitter Conducted Spurious and Band-Edge emissions were measured at a limit of 30 dBc (average detector) or 20 dBc (peak detector) below the highest in-band spectral density measured with a spectrum analyzer connected to the antenna terminal. Measurements were made while EUT was operating in transmit mode of operation at the appropriate centre frequency closest to the band-edge. Emissions were maximized during the measurement and limits derived from the peak spectral power and drawn on each plot.

Where the device operated with multiple antenna ports i.e. MIMO device, each port was measured separately. Testing was performed under ambient conditions at nominal voltage only.

Test configuration and setup used for the measurement was per the Conducted Test Set-up specified in this document.

Limits Transmitter Conducted Spurious and Band-Edge Emissions

(d) In any 100 kHz bandwidth outside the frequency band in which the spread spectrum or digitally modulated intentional radiator is operating, the radio frequency power that is produced by the intentional radiator shall be at least 20 dB below that in the 100 kHz bandwidth within the band that contains the highest level of the desired power, based on either an RF conducted or a radiated measurement, provided the transmitter demonstrates compliance with the peak conducted power limits. If the transmitter complies with the conducted power limits based on the use of RMS averaging over a time interval, as permitted under paragraph (b)(3) of this section, the attenuation required under this paragraph shall be 30 dB instead of 20 dB. Attenuation below the general limits specified in §15.209(a) is not required. In addition, radiated emissions which fall in the restricted bands, as defined in §15.205(a), must also comply with the radiated emission limits specified in §15.209(a) (see §15.205(c)).

This test report may be reproduced in full only. The document may only be updated by MiCOM Labs personnel. All changes will be noted in the Document History section of the report.



Title: Alien Technology ALR-F800
To: FCC CFR 47 Part 15 Subpart C 15.247 (DTS)
Serial #: ALNT60-U2 Rev A
Issue Date: 17th August 2015
Page: 34 of 74

Equipment Configuration for Transmitter Conducted Spurious Emissions

Variant:	PRSK	Duty Cycle (%):	99.00
Data Rate:	25.00 Tari	Antenna Gain (dBi):	Not Applicable
Modulation:	PRSK	Beam Forming Gain (Y):	Not Applicable
TPC:	Not Applicable	Tested By:	CC
Engineering Test Notes:			

Test Measurement Results

Test Frequency	Frequency Range	Transmitter Conducted Spurious Emissions (dBm)							
		Port a		Port b		Port c		Port d	
MHz	MHz	SE	Limit	SE	Limit	SE	Limit	SE	Limit
902.8	30.0 - 26000.0	-52.300	-26.33	--	--	--	--	--	--
915.3	30.0 - 26000.0	-51.926	-26.52	--	--	--	--	--	--
927.3	30.0 - 26000.0	-51.863	-27.13	--	--	--	--	--	--

Traceability to Industry Recognized Test Methodologies

Work Instruction:	WI-05 MEASUREMENT OF SPURIOUS EMISSIONS
Measurement Uncertainty:	<=40 GHz ±2.37 dB, > 40 GHz ±4.6 dB

Note: click the links in the above matrix to view the graphical image (plot).

This test report may be reproduced in full only. The document may only be updated by MiCOM Labs personnel. All changes will be noted in the Document History section of the report.



Title: Alien Technology ALR-F800
To: FCC CFR 47 Part 15 Subpart C 15.247 (DTS)
Serial #: ALNT60-U2 Rev A
Issue Date: 17th August 2015
Page: 35 of 74

9.6.1.2. Band-Edge Emissions

Equipment Configuration for Conducted Low Band-Edge Emissions - Average

Variant:	PRSK	Duty Cycle (%):	99.0
Data Rate:	25.00 Tari	Antenna Gain (dBi):	5.30
Modulation:	PRSK	Beam Forming Gain (Y)(dB):	Not Applicable
TPC:	Not Applicable	Tested By:	CC
Engineering Test Notes:			

Test Measurement Results

Channel Frequency:	902.8 MHz					
Band-Edge Frequency:	902.0 MHz					
Test Frequency Range:	850.0 - 915.0 MHz					
Port(s)	Band-Edge Markers and Limit			Revised Limit		Margin
	M1 Amplitude (dBm)	Plot Limit (dBm)	M2 Frequency (MHz)	Amplitude (dBm)	M2A Frequency (MHz)	(MHz)
a	-56.77	-1.83	902.50	--	--	-0.500

Traceability to Industry Recognized Test Methodologies

Work Instruction:	WI-05 MEASUREMENT OF SPURIOUS EMISSIONS
Measurement Uncertainty:	<=40 GHz ±2.37 dB, > 40 GHz ±4.6 dB

Note: click the links in the above matrix to view the graphical image (plot).

This test report may be reproduced in full only. The document may only be updated by MiCOM Labs personnel. All changes will be noted in the Document History section of the report.



Title: Alien Technology ALR-F800
To: FCC CFR 47 Part 15 Subpart C 15.247 (DTS)
Serial #: ALNT60-U2 Rev A
Issue Date: 17th August 2015
Page: 36 of 74

Equipment Configuration for Conducted High Band-Edge Emissions - Average

Variant:	PRSK	Duty Cycle (%):	99.00
Data Rate:	25.00 Tari	Antenna Gain (dBi):	5.30
Modulation:	PRSK	Beam Forming Gain (Y)(dB):	Not Applicable
TPC:	Not Applicable	Tested By:	CC
Engineering Test Notes:			

Test Measurement Results

Channel Frequency:	927.3 MHz					
Band-Edge Frequency:	928.0 MHz					
Test Frequency Range:	915.0 - 978.0 MHz					
Port(s)	Band-Edge Markers and Limit			Revised Limit		Margin
	M3 Amplitude (dBm)	Plot Limit (dBm)	M2 Frequency (MHz)	Amplitude (dBm)	M2A Frequency (MHz)	(MHz)
a	-56.75	-3.15	927.40	--	--	-0.600

Traceability to Industry Recognized Test Methodologies

Work Instruction:	WI-05 MEASUREMENT OF SPURIOUS EMISSIONS
Measurement Uncertainty:	<=40 GHz ±2.37 dB, > 40 GHz ±4.6 dB

Note: click the links in the above matrix to view the graphical image (plot).

This test report may be reproduced in full only. The document may only be updated by MiCOM Labs personnel. All changes will be noted in the Document History section of the report.



Title: Alien Technology ALR-F800
To: FCC CFR 47 Part 15 Subpart C 15.247 (DTS)
Serial #: ALNT60-U2 Rev A
Issue Date: 17th August 2015
Page: 37 of 74

9.7. Radiated Testing

9.4.1. Radiated Spurious Emissions

FCC, Part 15 Subpart C §15.247(d) 15.205; 15.209

Test Procedure

Radiated emissions above 1 GHz are measured in the anechoic chamber at a 3-meter distance on every azimuth in both horizontal and vertical polarities. The emissions are recorded and maximized as a function of azimuth by rotation through 360° with a spectrum analyzer in peak hold mode. Depending on the frequency band spanned a notch filter and waveguide filter was used to remove the fundamental frequency. The highest emissions relative to the limit are listed for each frequency spanned.

All measurements on any frequency or frequencies over 1 MHz are based on the use of measurement instrumentation employing an average detector function. All measurements above 1 GHz were performed using a minimum resolution bandwidth of 1 MHz.

Operational Modes

Operational mode(s) tested for spurious emissions were the modes which delivered maximum spectral density

This test report may be reproduced in full only. The document may only be updated by MiCOM Labs personnel. All changes will be noted in the Document History section of the report.



Title: Alien Technology ALR-F800
To: FCC CFR 47 Part 15 Subpart C 15.247 (DTS)
Serial #: ALNT60-U2 Rev A
Issue Date: 17th August 2015
Page: 38 of 74

Field Strength Calculation

The field strength is calculated by adding the Antenna Factor and Cable Loss, and subtracting Amplifier Gain from the measured reading. All factors are included in the reported data.

$FS = R + AF + CORR - FO$
where: FS = Field Strength
R = Measured Spectrum analyzer Input Amplitude
AF = Antenna Factor
CORR = Correction Factor = CL – AG + NFL
CL = Cable Loss
AG = Amplifier Gain
FO = Distance Falloff Factor
NFL = Notch Filter Loss or Waveguide Loss

For example:

Given receiver input reading of 51.5 dB μ V; Antenna Factor of 8.5 dB; Cable Loss of 1.3 dB; Falloff Factor of 0 dB, an Amplifier Gain of 26 dB and Notch Filter Loss of 1 dB. The Field Strength of the measured emission is:

$$FS = 51.5 + 8.5 + 1.3 - 26.0 + 1 = 36.3 \text{ dB}\mu\text{V/m}$$

Conversion between dB μ V/m (or dB μ V) and μ V/m (or μ V) are done as:

$$\text{Level (dB}\mu\text{V/m)} = 20 * \text{Log (level (\mu\text{V/m}))}$$

$$40 \text{ dB}\mu\text{V/m} = 100 \mu\text{V/m}$$

$$48 \text{ dB}\mu\text{V/m} = 250 \mu\text{V/m}$$

NOTE: KDB 662911 was implemented for Out-of-Band measurements. Where necessary Option (2) Measure and add 10 log (N) dB was implemented

Traceability

Test Methodology	Measurement Uncertainty
Measurements were made per work instruction WI-03 'Measurement of Radiated Emissions'	+5.6/ -4.5 dB

This test report may be reproduced in full only. The document may only be updated by MiCOM Labs personnel. All changes will be noted in the Document History section of the report.



Title: Alien Technology ALR-F800
To: FCC CFR 47 Part 15 Subpart C 15.247 (DTS)
Serial #: ALNT60-U2 Rev A
Issue Date: 17th August 2015
Page: 39 of 74

Equipment Configuration for Radiated Spurious - Restricted Band Emissions

Antenna:	Alien Technology ALR-8696	Variant:	FHSS
Antenna Gain (dBi):	5.50	Modulation:	PRSK
Beam Forming Gain (Y):	Not Applicable	Duty Cycle (%):	99
Channel Frequency (MHz):	902.75	Data Rate:	25.00 Tari
Power Setting:	275	Tested By:	SB

Test Measurement Results

RADIATED SPURIOUS - RESTRICTED BAND EMISSIONS



Variant: FHSS, Test Freq: 902.75 MHz, Antenna: Alien Technologies ALR-8696, Power Setting: 275, Duty Cycle (%): 99

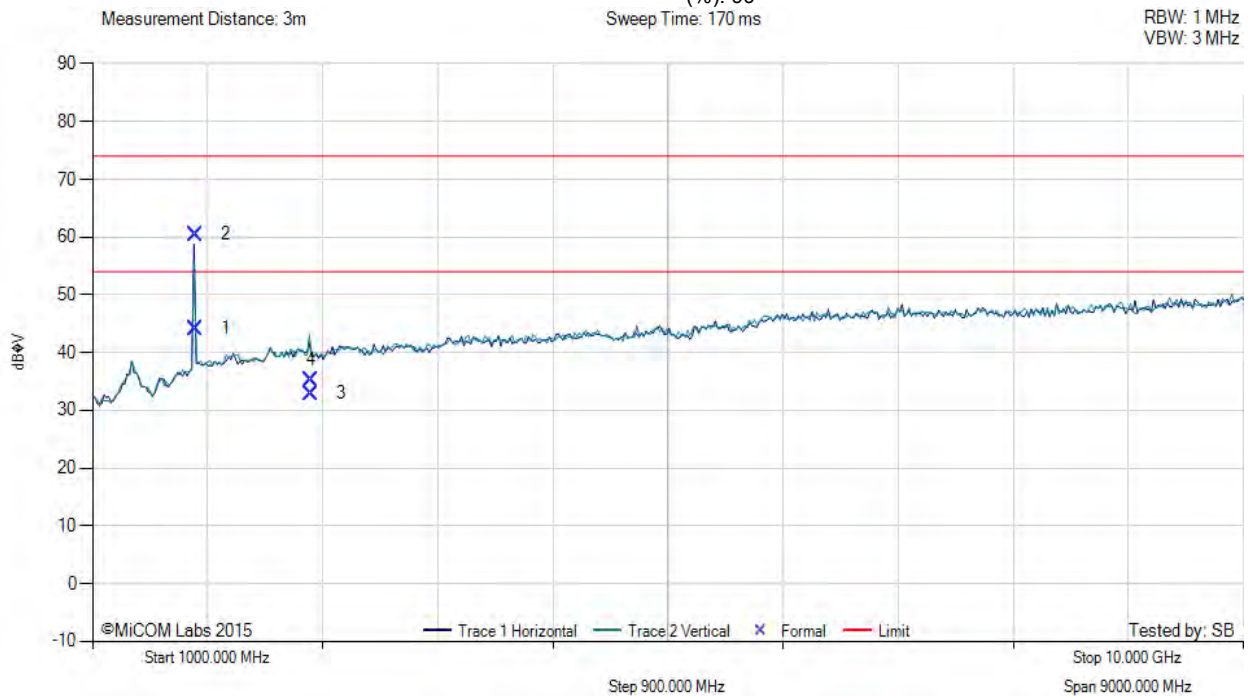

Num	Frequency MHz	Raw dBµV	Cable Loss	AF dB	Level dBµV/m	Measurement Type	Pol	Hgt cm	Azt Deg	Limit dBµV/m	Margin dB	Pass /Fail
1	1805.57	54.33	3.48	-13.63	44.18	Max Avg	Horizontal	101	328	54.0	-9.8	Pass
2	1805.57	70.66	3.48	-13.63	60.51	Max Peak	Horizontal	101	328	74.0	-13.5	Pass
3	2708.33	29.99	4.30	-21.37	32.92	Max Avg	Vertical	100	64	54.0	-21.1	Pass
4	2708.33	32.32	4.30	-21.37	35.25	Max Peak	Vertical	100	64	74.0	-38.8	Pass

Test Notes: w/o 50 ohm load on ant ports 1, 2, and 3

This test report may be reproduced in full only. The document may only be updated by MiCOM Labs personnel. All changes will be noted in the Document History section of the report.



Title: Alien Technology ALR-F800
To: FCC CFR 47 Part 15 Subpart C 15.247 (DTS)
Serial #: ALNT60-U2 Rev A
Issue Date: 17th August 2015
Page: 40 of 74

Equipment Configuration for Radiated Spurious - Restricted Band Emissions

Antenna:	Alien Technology ALR-8696	Variant:	FHSS
Antenna Gain (dBi):	5.50	Modulation:	PRSK
Beam Forming Gain (Y):	Not Applicable	Duty Cycle (%):	99
Channel Frequency (MHz):	914.25	Data Rate:	25.00 Tari
Power Setting:	60	Tested By:	SB

Test Measurement Results

RADIATED SPURIOUS - RESTRICTED BAND EMISSIONS



Variant: FHSS, Test Freq: 914.25 MHz, Antenna: Alien Technologies ALR-8696, Power Setting: 60, Duty Cycle (%): 99

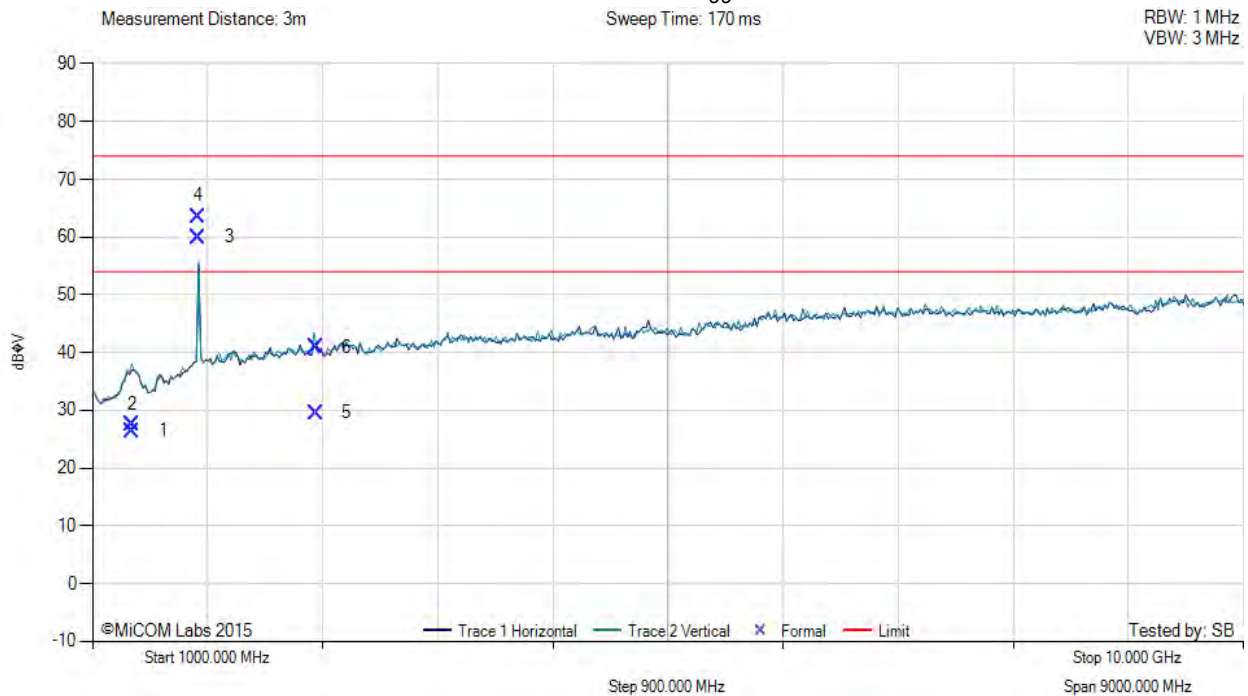

Num	Frequency MHz	Raw dBµV	Cable Loss	AF dB	Level dBµV/m	Measurement Type	Pol	Hgt cm	Azt Deg	Limit dBµV/m	Margin dB	Pass /Fail
1	1313.26	38.42	2.93	-14.86	26.49	Max Avg	Vertical	165	55	54.0	-27.5	Pass
2	1313.26	49.51	2.93	-14.86	27.58	Max Peak	Vertical	165	55	74.0	-46.4	Pass
3	1830.42	70.04	3.50	-13.54	60.00	Max Avg	Horizontal	100	356	54.0	6.0	Pass
4	1830.42	73.60	3.50	-13.54	63.56	Max Peak	Horizontal	100	356	74.0	10.4	Pass
5	2745.44	26.56	4.31	-21.35	29.52	Max Avg	Vertical	100	92	54.0	-24.5	Pass
6	2745.44	38.00	4.31	-21.35	40.96	Max Peak	Vertical	100	92	74.0	-33.0	Pass

Test Notes: no 50 ohm load

This test report may be reproduced in full only. The document may only be updated by MiCOM Labs personnel. All changes will be noted in the Document History section of the report.



Title: Alien Technology ALR-F800
To: FCC CFR 47 Part 15 Subpart C 15.247 (DTS)
Serial #: ALNT60-U2 Rev A
Issue Date: 17th August 2015
Page: 41 of 74

Equipment Configuration for Radiated Spurious - Restricted Band Emissions

Antenna:	Alien Technologies ALR-8696	Variant:	FHSS
Antenna Gain (dBi):	5.50	Modulation:	PRSK
Beam Forming Gain (Y):	Not Applicable	Duty Cycle (%):	99
Channel Frequency (MHz):	927.25	Data Rate:	25.00 Tari
Power Setting:	275	Tested By:	SB

Test Measurement Results

RADIATED SPURIOUS - RESTRICTED BAND EMISSIONS



Variant: FHSS, Test Freq: 927.25 MHz, Antenna: Alien Technologies ALR-8696, Power Setting: 275, Duty Cycle (%): 99

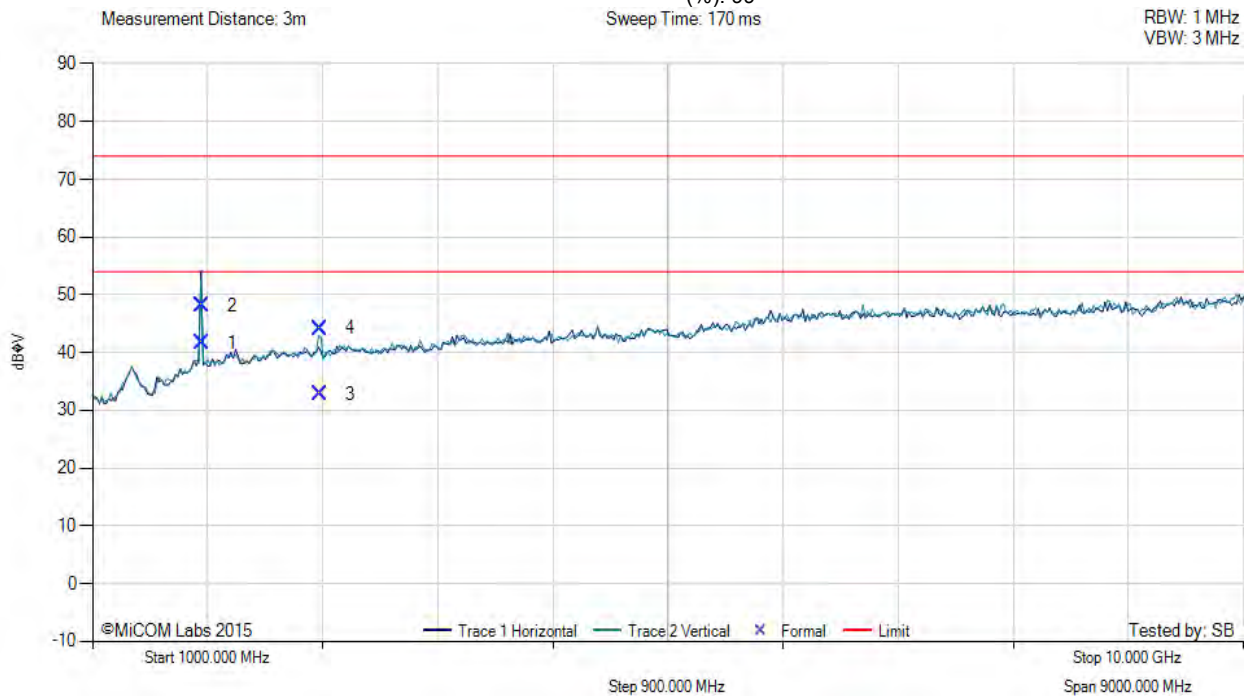

Num	Frequency MHz	Raw dBµV	Cable Loss	AF dB	Level dBµV/m	Measurement Type	Pol	Hgt cm	Azt Deg	Limit dBµV/m	Margin dB	Pass /Fail
1	1854.61	51.54	3.51	-13.42	41.63	Max Avg	Horizontal	142	126	54.0	-12.4	Pass
2	1854.61	58.04	3.51	-13.42	48.13	Max Peak	Horizontal	142	126	74.0	-25.9	Pass
3	2781.59	39.80	4.37	-11.33	32.84	Max Avg	Vertical	117	94	54.0	-21.2	Pass
4	2781.59	51.18	4.37	-11.33	44.22	Max Peak	Vertical	117	94	74.0	-29.8	Pass

Test Notes: w/o 50 ohm load on ant ports 1, 2, and 3

This test report may be reproduced in full only. The document may only be updated by MiCOM Labs personnel. All changes will be noted in the Document History section of the report.



Title: Alien Technology ALR-F800
To: FCC CFR 47 Part 15 Subpart C 15.247 (DTS)
Serial #: ALNT60-U2 Rev A
Issue Date: 17th August 2015
Page: 42 of 74

Equipment Configuration for Radiated Spurious - Restricted Band Emissions

Antenna:	Times-7 A6590C	Variant:	FHSS
Antenna Gain (dBi):	6.00	Modulation:	PRSK
Beam Forming Gain (Y):	Not Applicable	Duty Cycle (%):	99
Channel Frequency (MHz):	902.75	Data Rate:	25.00 Tari
Power Setting:	275	Tested By:	SB

Test Measurement Results



RADIATED SPURIOUS - RESTRICTED BAND EMISSIONS

Variant: FHSS, Test Freq: 902.75 MHz, Antenna: Times-7 A6590C, Power Setting: 275, Duty Cycle (%): 99

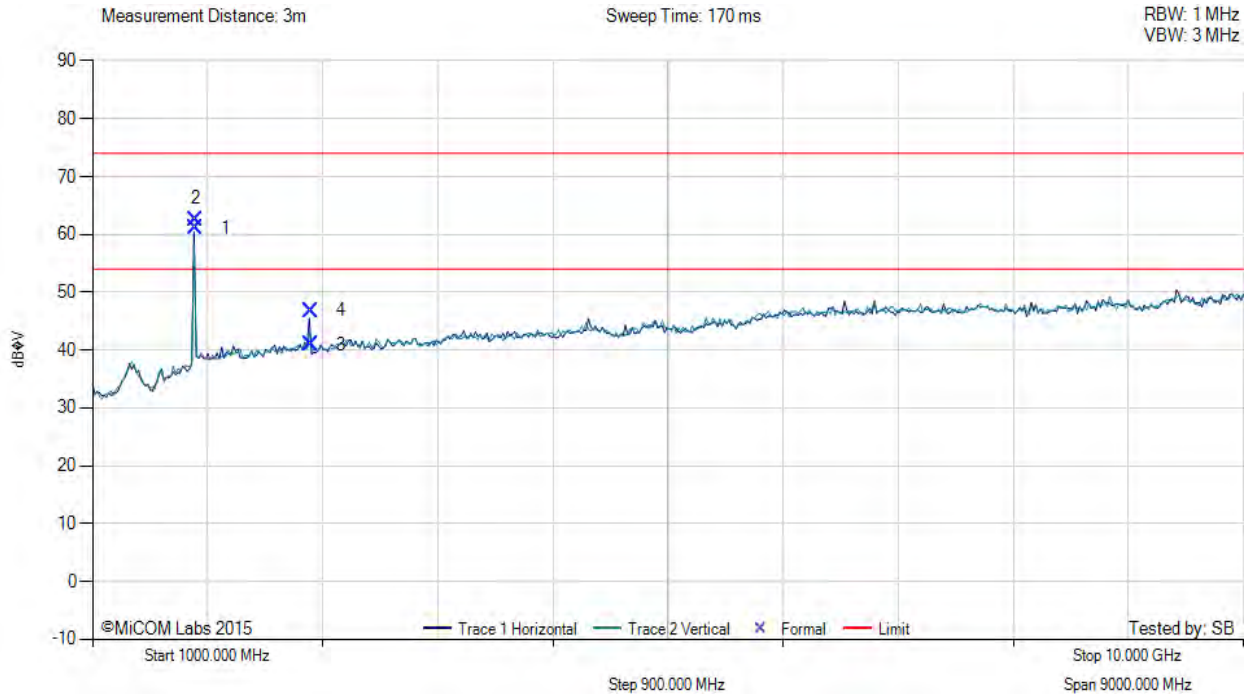

Num	Frequency MHz	Raw dBµV	Cable Loss	AF dB	Level dBµV/m	Measurement Type	Pol	Hgt cm	Azt Deg	Limit dBµV/m	Margin dB	Pass /Fail
1	1805.54	71.29	3.48	-13.63	61.14	Max Avg	Horizontal	103	43	54.0	7.1	Pass
2	1805.54	72.75	3.48	-13.63	62.60	Max Peak	Horizontal	103	43	74.0	-11.4	Pass
3	2708.33	48.07	4.30	-11.37	41.00	Max Avg	Horizontal	100	47	54.0	-13.0	Pass
4	2708.33	53.87	4.30	-11.37	46.80	Max Peak	Horizontal	100	47	74.0	-27.2	Pass

Test Notes: w/o 50 ohm load on ant ports 1-3

This test report may be reproduced in full only. The document may only be updated by MiCOM Labs personnel. All changes will be noted in the Document History section of the report.



Title: Alien Technology ALR-F800
To: FCC CFR 47 Part 15 Subpart C 15.247 (DTS)
Serial #: ALNT60-U2 Rev A
Issue Date: 17th August 2015
Page: 43 of 74

Equipment Configuration for Radiated Spurious - Restricted Band Emissions

Antenna:	Times-7 A6590C	Variant:	FHSS
Antenna Gain (dBi):	6.00	Modulation:	PRSK
Beam Forming Gain (Y):	Not Applicable	Duty Cycle (%):	99
Channel Frequency (MHz):	914.25	Data Rate:	25.00 Tari
Power Setting:	275	Tested By:	SB

Test Measurement Results



RADIATED SPURIOUS - RESTRICTED BAND EMISSIONS

Variant: FHSS, Test Freq: 914.25 MHz, Antenna: Times-7 A6590C, Power Setting: 275, Duty Cycle (%): 99

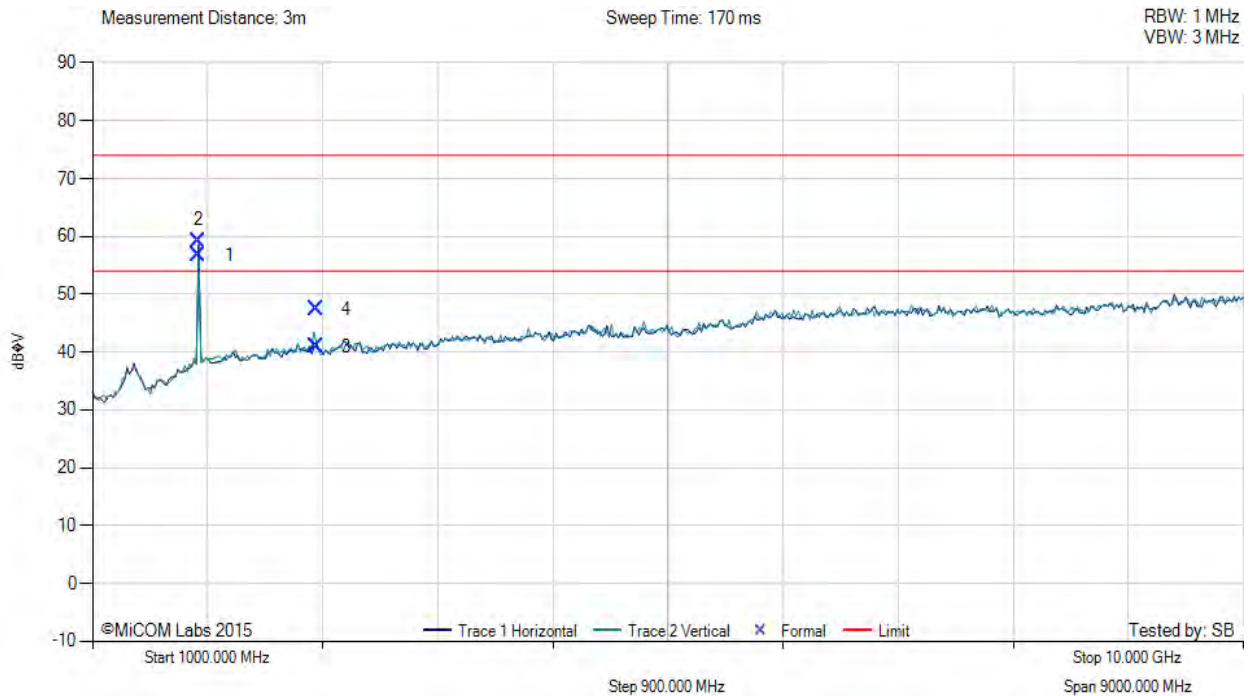

Num	Frequency MHz	Raw dBµV	Cable Loss	AF dB	Level dBµV/m	Measurement Type	Pol	Hgt cm	Azt Deg	Limit dBµV/m	Margin dB	Pass /Fail
1	1830.52	66.71	3.50	-13.53	56.68	Max Avg	Horizontal	100	40	54.0	2.7	Pass
2	1830.52	69.31	3.50	-13.53	59.28	Max Peak	Horizontal	100	40	74.0	-14.7	Pass
3	2745.78	48.05	4.31	-11.35	41.01	Max Avg	Vertical	100	340	54.0	-13.0	Pass
4	2745.78	54.41	4.31	-11.35	47.37	Max Peak	Vertical	100	340	74.0	-26.6	Pass

Test Notes: w/o 50 ohm load on ant ports 1-3

This test report may be reproduced in full only. The document may only be updated by MiCOM Labs personnel. All changes will be noted in the Document History section of the report.



Title: Alien Technology ALR-F800
To: FCC CFR 47 Part 15 Subpart C 15.247 (DTS)
Serial #: ALNT60-U2 Rev A
Issue Date: 17th August 2015
Page: 44 of 74

Equipment Configuration for Radiated Spurious - Restricted Band Emissions

Antenna:	Times-7 A6590C	Variant:	FHSS
Antenna Gain (dBi):	6.00	Modulation:	PRSK
Beam Forming Gain (Y):	Not Applicable	Duty Cycle (%):	99
Channel Frequency (MHz):	927.25	Data Rate:	25.00 Tari
Power Setting:	275	Tested By:	SB

Test Measurement Results



RADIATED SPURIOUS - RESTRICTED BAND EMISSIONS

Variant: FHSS, Test Freq: 927.25 MHz, Antenna: Times-7 A6590C, Power Setting: 275, Duty Cycle (%): 99

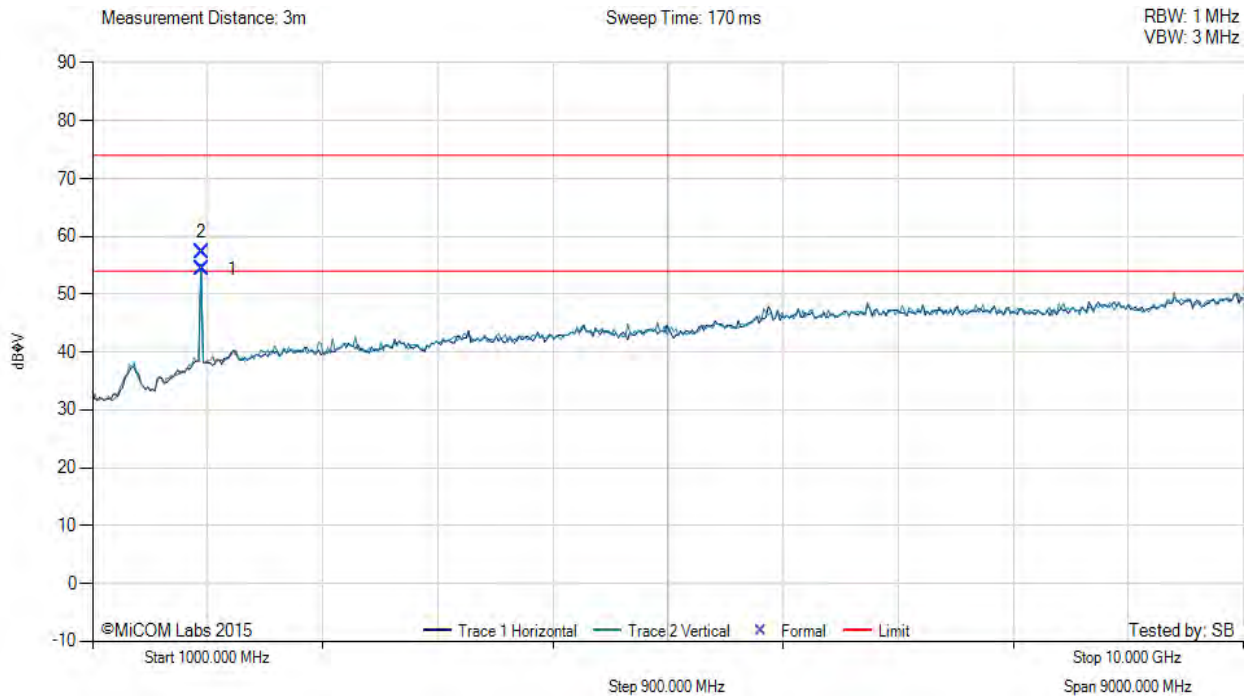

Num	Frequency MHz	Raw dBµV	Cable Loss	AF dB	Level dBµV/m	Measurement Type	Pol	Hgt cm	Azt Deg	Limit dBµV/m	Margin dB	Pass /Fail
1	1854.55	64.33	3.51	-13.42	54.42	Max Avg	Horizontal	100	45	54.0	0.4	Pass
2	1854.55	67.17	3.51	-13.42	57.26	Max Peak	Horizontal	100	45	74.0	-16.7	Pass

Test Notes: w/o 50 ohm load on ant ports 1-3

This test report may be reproduced in full only. The document may only be updated by MiCOM Labs personnel. All changes will be noted in the Document History section of the report.



9.4.2. Digital Emissions (0.03 – 1 GHz)

FCC, Part 15 Subpart C §15.205/ §15.209

Test Procedure

Testing 30M-1 GHz was performed in a 3-meter anechoic chamber using a CISPR compliant receiver. Preliminary radiated emissions were measured on every azimuth and with the receiving antenna in both horizontal and vertical polarizations. To further maximize emissions the receive antenna was varied between 1 and 4 meters. The emissions are recorded with receiver in peak hold mode. Emissions closest to the limits are measured in the quasi-peak mode with the tuned receiver using a bandwidth of 120 kHz. Only the highest emissions relative to the limit are listed. The anechoic chamber test set-up is identified in Section 6 Test Set-Up Photographs.

Field Strength Calculation

The field strength is calculated by adding the Antenna Factor and Cable Loss, and subtracting Amplifier Gain from the measured reading. In this test facility, the Antenna Factor, Cable Loss, and Amplifier Gains are loaded into the Rohde & Schwarz Receiver and the corrected field strength can be read directly on the receiver.

where:

$$FS = R + AF + CORR$$

FS = Field Strength
R = Measured Receiver Input Amplitude
AF = Antenna Factor
CORR = Correction Factor = CL – AG + NFL
CL = Cable Loss
AG = Amplifier Gain

For example:

Given a Receiver input reading of 51.5dB μ V; Antenna Factor of 8.5dB; Cable Loss of 1.3dB; Falloff Factor of 0dB, an Amplifier Gain of 26dB and Notch Filter Loss of 1dB. The Field Strength of the measured emission is:

$$FS = 51.5 + 8.5 + 1.3 - 26.0 + 1 = 36.3\text{dB}\mu\text{V/m}$$

Conversion between dB μ V/m (or dB μ V) and μ V/m (or μ V) are done as:

$$\text{Level (dB}\mu\text{V/m)} = 20 * \text{Log (level (\mu\text{V/m}))}$$

$$40 \text{ dB}\mu\text{V/m} = 100\mu\text{V/m}$$

$$48 \text{ dB}\mu\text{V/m} = 250\mu\text{V/m}$$



Title: Alien Technology ALR-F800
To: FCC CFR 47 Part 15 Subpart C 15.247 (DTS)
Serial #: ALNT60-U2 Rev A
Issue Date: 17th August 2015
Page: 46 of 74

Traceability

Test Methodology	Laboratory Measurement Uncertainty
Measurements were made per work instruction WI-03 'Measurement of Radiated Emissions'	+5.6/ -4.5 dB

This test report may be reproduced in full only. The document may only be updated by MiCOM Labs personnel. All changes will be noted in the Document History section of the report.



Title: Alien Technology ALR-F800
To: FCC CFR 47 Part 15 Subpart C 15.247 (DTS)
Serial #: ALNT60-U2 Rev A
Issue Date: 17th August 2015
Page: 47 of 74

Equipment Configuration for Digital Emissions (0.03 - 1 GHz)

Antenna:	Times-7 A6590C	Variant:	FHSS
Antenna Gain (dBi):	6.00	Modulation:	PRSK
Beam Forming Gain (Y):	Not Applicable	Duty Cycle (%):	99
Channel Frequency (MHz):	902.75	Data Rate:	25.00 Tari
Power Setting:	275	Tested By:	SB

Test Measurement Results



DIGITAL EMISSIONS (0.03 - 1 GHz)

Variant: FHSS, Test Freq: 902.75 MHz, Antenna: Times-7 A6590C, Power Setting: 275, Duty Cycle (%): 99

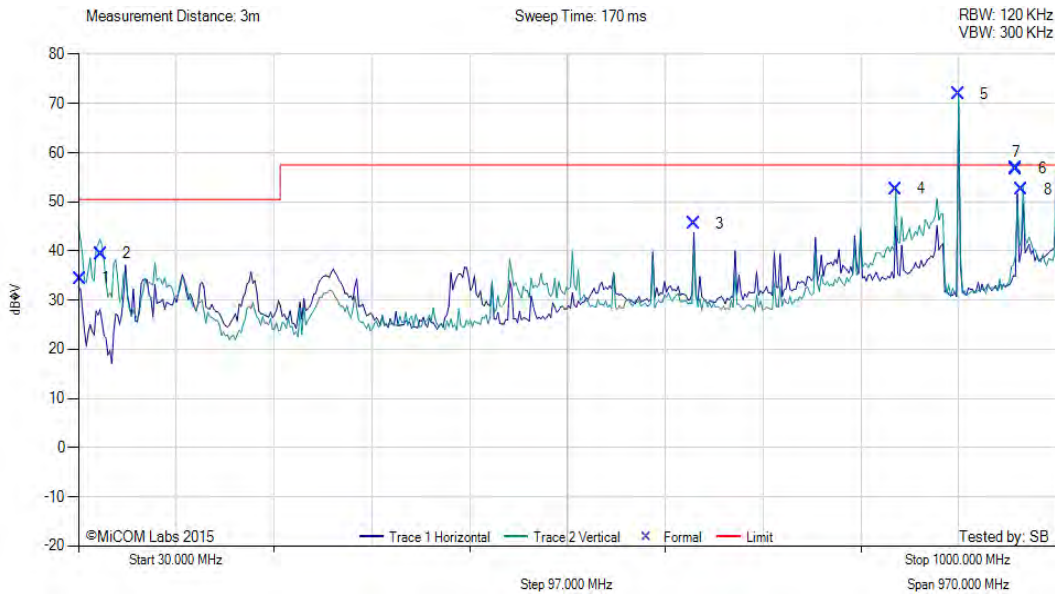

Num	Frequency MHz	Raw dBµV	Cable Loss	AF dB	Level dBµV/m	Measurement Type	Pol	Hgt cm	Azt Deg	Limit dBµV/m	Margin dB	Pass /Fail
1	31.80	42.18	3.44	-11.21	34.41	MaxQP	Vertical	128	46	50.5	-16.0	Pass
2	52.58	59.78	3.59	-23.92	39.45	MaxQP	Vertical	100	0	50.5	-11.1	Pass
3	639.98	50.47	5.72	-10.59	45.60	MaxQP	Horizontal	109	138	57.0	-11.4	Pass
4	840.00	54.85	6.22	-8.49	52.58	MaxQP	Vertical	107	1	57.0	-4.4	Pass
5	902.77	73.30	6.34	-7.75	71.89	Fundamental	Vertical					
6	959.96	57.41	6.49	-7.15	56.75	MaxQP	Vertical	100	5	57.0	-0.3	Pass
7	959.96	57.25	6.49	-7.15	56.59	MaxQP	Vertical	102	5	57.0	-0.4	Pass
8	965.49	53.10	6.49	-7.05	52.54	MaxQP	Vertical	100	6	57.0	-4.5	Pass
9	1000.00	52.51	6.60	-6.41	52.70	MaxQP	Horizontal	114	337	57.0	-4.3	Pass

Test Notes: The ALR-F800 is a Class A device

This test report may be reproduced in full only. The document may only be updated by MiCOM Labs personnel. All changes will be noted in the Document History section of the report.



Title: Alien Technology ALR-F800
To: FCC CFR 47 Part 15 Subpart C 15.247 (DTS)
Serial #: ALNT60-U2 Rev A
Issue Date: 17th August 2015
Page: 48 of 74

Equipment Configuration for Digital Emissions (0.03 - 1 GHz)

Antenna:	Times-7 A6590C	Variant:	FHSS
Antenna Gain (dBi):	6.00	Modulation:	PRSK
Beam Forming Gain (Y):	Not Applicable	Duty Cycle (%):	99
Channel Frequency (MHz):	914.25	Data Rate:	25.00 Tari
Power Setting:	275	Tested By:	SB

Test Measurement Results



DIGITAL EMISSIONS (0.03 - 1 GHz)

Variant: FHSS, Test Freq: 902.75 MHz, Antenna: Times-7 A6590C, Power Setting: 275, Duty Cycle (%): 99

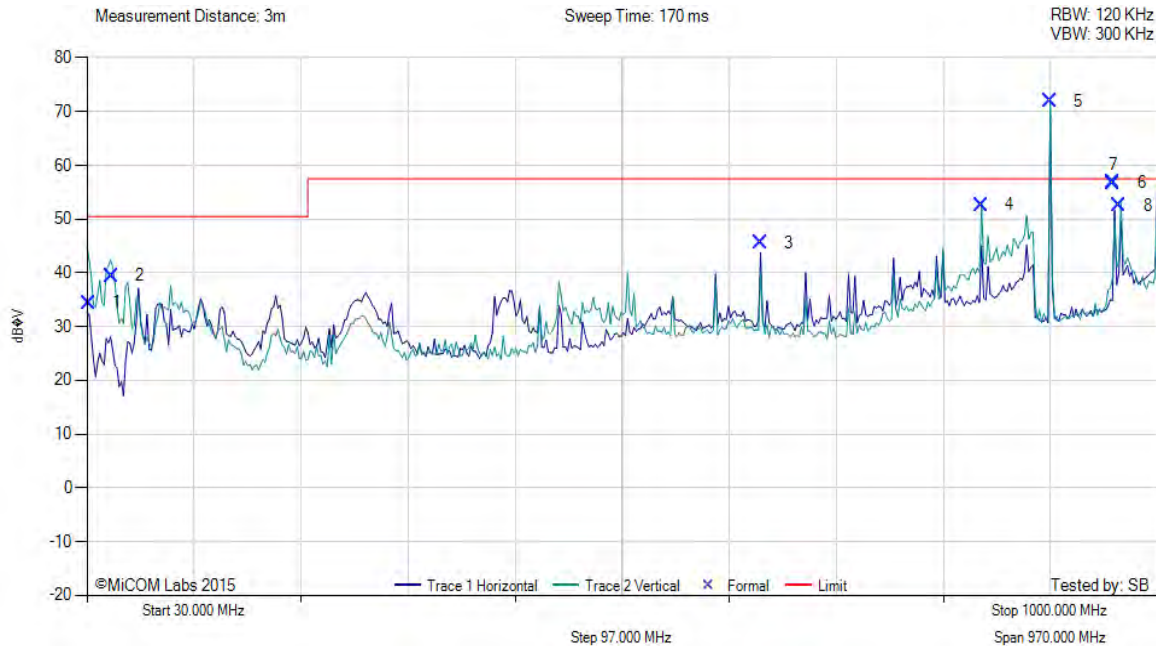

Num	Frequency MHz	Raw dBµV	Cable Loss	AF dB	Level dBµV/m	Measurement Type	Pol	Hgt cm	Azt Deg	Limit dBµV/m	Margin dB	Pass /Fail
1	31.80	42.18	3.44	-11.21	34.41	MaxQP	Vertical	128	46	50.5	-16.0	Pass
2	52.58	59.78	3.59	-23.92	39.45	MaxQP	Vertical	100	0	50.5	-11.1	Pass
3	639.98	50.47	5.72	-10.59	45.60	MaxQP	Horizontal	109	138	57.0	-11.4	Pass
4	840.00	54.85	6.22	-8.49	52.58	MaxQP	Vertical	107	1	57.0	-4.4	Pass
5	902.77	73.30	6.34	-7.75	71.89	Fundamental	Vertical					
6	959.96	57.41	6.49	-7.15	56.75	MaxQP	Vertical	100	5	57.0	-0.3	Pass
7	959.96	57.25	6.49	-7.15	56.59	MaxQP	Vertical	102	5	57.0	-0.4	Pass
8	965.49	53.10	6.49	-7.05	52.54	MaxQP	Vertical	100	6	57.0	-4.5	Pass
9	1000.00	52.51	6.60	-6.41	52.70	MaxQP	Horizontal	114	337	57.0	-4.3	Pass

Test Notes: The ALR-F800 is a Class A device

This test report may be reproduced in full only. The document may only be updated by MiCOM Labs personnel. All changes will be noted in the Document History section of the report.



Title: Alien Technology ALR-F800
To: FCC CFR 47 Part 15 Subpart C 15.247 (DTS)
Serial #: ALNT60-U2 Rev A
Issue Date: 17th August 2015
Page: 49 of 74

Equipment Configuration for Digital Emissions (0.03 - 1 GHz)

Antenna:	Times-7 A6590C	Variant:	FHSS
Antenna Gain (dBi):	6.00	Modulation:	PRSK
Beam Forming Gain (Y):	Not Applicable	Duty Cycle (%):	99
Channel Frequency (MHz):	927.25	Data Rate:	25.00 Tari
Power Setting:	275	Tested By:	SB

Test Measurement Results



DIGITAL EMISSIONS (0.03 - 1 GHz)

Variant: FHSS, Test Freq: 914.25 MHz, Antenna: Times-7 A6590C, Power Setting: 275, Duty Cycle (%): 99

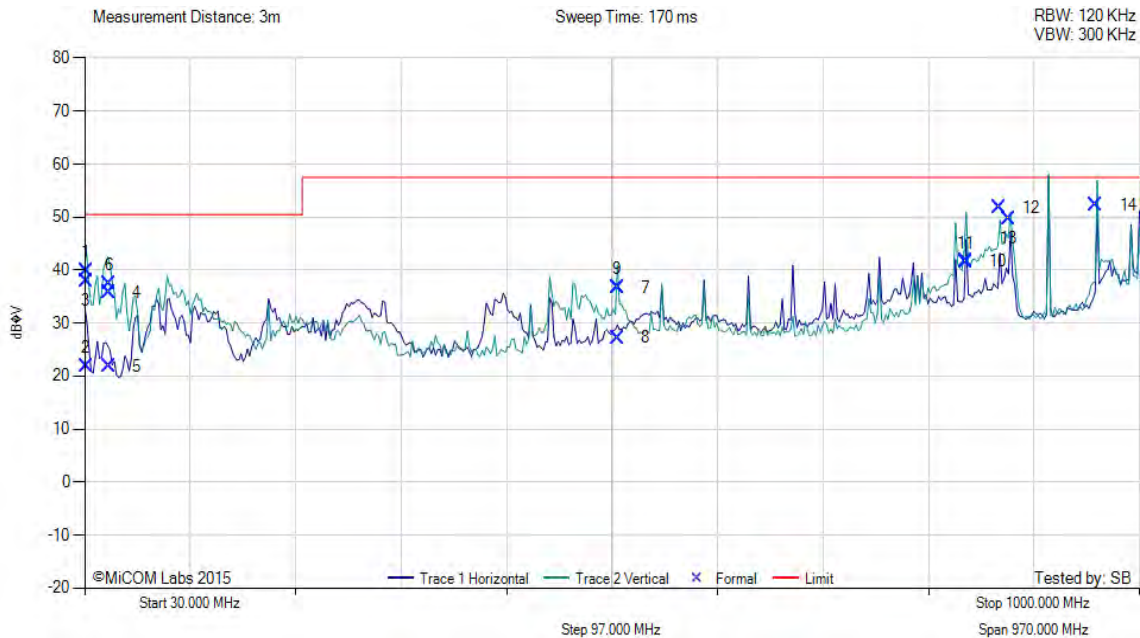

Num	Frequency MHz	Raw dBµV	Cable Loss	AF dB	Level dBµV/m	Measurement Type	Pol	Hgt cm	Azt Deg	Limit dBµV/m	Margin dB	Pass /Fail
1	31.24	47.06	3.43	-10.61	39.88	MaxQP	Vertical	110	167	50.5	-10.6	Pass
2	31.24	29.09	3.43	-10.61	21.91	MaxQP	Horizontal	107	88	50.5	-28.6	Pass
3	31.24	45.05	3.43	-10.61	37.87	MaxQP	Vertical	100	118	50.5	-12.6	Pass
4	52.48	55.67	3.59	-23.53	35.73	MaxQP	Vertical	112	84	50.5	-14.8	Pass
5	52.48	41.80	3.59	-23.53	21.86	MaxQP	Horizontal	108	1	50.5	-28.6	Pass
6	52.48	57.39	3.59	-23.53	37.45	MaxQP	Vertical	105	101	50.5	-13.1	Pass
7	519.94	43.91	5.38	-12.58	36.71	MaxQP	Vertical	100	4	57.0	-20.3	Pass
8	519.94	34.47	5.38	-12.58	27.27	MaxQP	Horizontal	104	313	57.0	-29.7	Pass
9	519.94	43.92	5.38	-12.58	36.72	MaxQP	Vertical	100	0	57.0	-20.3	Pass
10	840.10	43.95	6.22	-8.49	41.68	MaxQP	Vertical	103	0	57.0	-15.3	Pass
11	840.10	43.76	6.22	-8.49	41.49	MaxQP	Vertical	100	3	57.0	-15.5	Pass

This test report may be reproduced in full only. The document may only be updated by MiCOM Labs personnel. All changes will be noted in the Document History section of the report.



Title: Alien Technology ALR-F800
To: FCC CFR 47 Part 15 Subpart C 15.247 (DTS)
Serial #: ALNT60-U2 Rev A
Issue Date: 17th August 2015
Page: 50 of 74

12	870.50	53.64	6.26	-8.18	51.72	MaxQP	Vertical	100	3	57.0	-5.3	Pass
13	880.02	51.56	6.28	-8.20	49.64	MaxQP	Vertical	100	0	57.0	-7.4	Pass
14	959.92	52.97	6.49	-7.15	52.31	MaxQP	Vertical	100	6	57.0	-4.7	Pass
15	1000.00	52.24	6.60	-6.41	52.43	MaxQP	Vertical	100	9	57.0	-4.6	Pass

Test Notes: The ALR-F800 is a Class A device

This test report may be reproduced in full only. The document may only be updated by MiCOM Labs personnel. All changes will be noted in the Document History section of the report.



Title: Alien Technology ALR-F800
To: FCC CFR 47 Part 15 Subpart C 15.247 (DTS)
Serial #: ALNT60-U2 Rev A
Issue Date: 17th August 2015
Page: 51 of 74

Equipment Configuration for Digital Emissions (0.03 - 1 GHz)

Antenna:	Alien Technology ALR-8696	Variant:	FHSS
Antenna Gain (dBi):	5.50	Modulation:	PRSK
Beam Forming Gain (Y):	Not Applicable	Duty Cycle (%):	99
Channel Frequency (MHz):	902.75	Data Rate:	25.00 Tari
Power Setting:	275	Tested By:	SB

Test Measurement Results

DIGITAL EMISSIONS (0.03 - 1 GHz)



Variant: FHSS, Test Freq: 902.75 MHz, Antenna: Alien Technologies ALR-8696, Power Setting: 275, Duty Cycle (%): 99

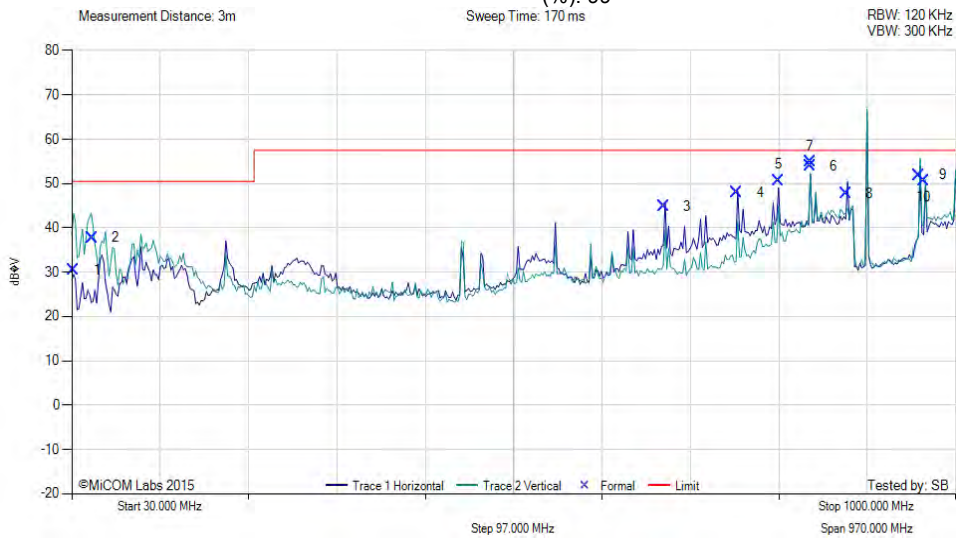

Num	Frequency MHz	Raw dBµV	Cable Loss	AF dB	Level dBµV/m	Measurement Type	Pol	Hgt cm	Azt Deg	Limit dBµV/m	Margin dB	Pass /Fail
1	31.94	38.25	3.44	-11.21	30.48	MaxQP	Vertical	100	127	50.5	-20.0	Pass
2	52.53	58.13	3.59	-23.92	37.80	MaxQP	Vertical	117	302	50.5	-12.7	Pass
3	679.96	49.45	5.81	-10.45	44.81	MaxQP	Horizontal	108	2	57.0	-12.2	Pass
4	759.98	51.30	6.02	-9.30	48.02	MaxQP	Horizontal	100	8	57.0	-9.0	Pass
5	805.49	53.51	6.10	-8.93	50.68	MaxQP	Horizontal	145	354	57.0	-6.3	Pass
6	839.98	56.23	6.22	-8.49	53.96	MaxQP	Vertical	113	14	57.0	-3.0	Pass
7	840.00	57.17	6.22	-8.49	54.90	MaxQP	Horizontal	150	346	57.0	-2.1	Pass
8	880.02	49.67	6.28	-8.20	47.75	MaxQP	Horizontal	100	21	57.0	-9.8	Pass
9	960.04	52.55	6.49	-7.15	51.89	MaxQP	Vertical	100	5	57.0	-5.1	Pass
10	965.48	51.09	6.49	-7.05	50.53	MaxQP	Vertical	101	19	57.0	-6.5	Pass
11	1000.00	52.48	6.60	-6.41	52.67	MaxQP	Vertical	100	0	57.0	-4.3	Pass

Test Notes: The ALR-F800 is a Class A device

This test report may be reproduced in full only. The document may only be updated by MiCOM Labs personnel. All changes will be noted in the Document History section of the report.



Title: Alien Technology ALR-F800
To: FCC CFR 47 Part 15 Subpart C 15.247 (DTS)
Serial #: ALNT60-U2 Rev A
Issue Date: 17th August 2015
Page: 52 of 74

Equipment Configuration for Digital Emissions (0.03 - 1 GHz)

Antenna:	Alien Technology ALR-8696	Variant:	FHSS
Antenna Gain (dBi):	5.50	Modulation:	PRSK
Beam Forming Gain (Y):	Not Applicable	Duty Cycle (%):	99
Channel Frequency (MHz):	914.25	Data Rate:	25.00 Tari
Power Setting:	275	Tested By:	SB

Test Measurement Results

DIGITAL EMISSIONS (0.03 - 1 GHz)



Variant: FHSS, Test Freq: 914.25 MHz, Antenna: Alien Technologies ALR-8696, Power Setting: 275, Duty Cycle (%): 99

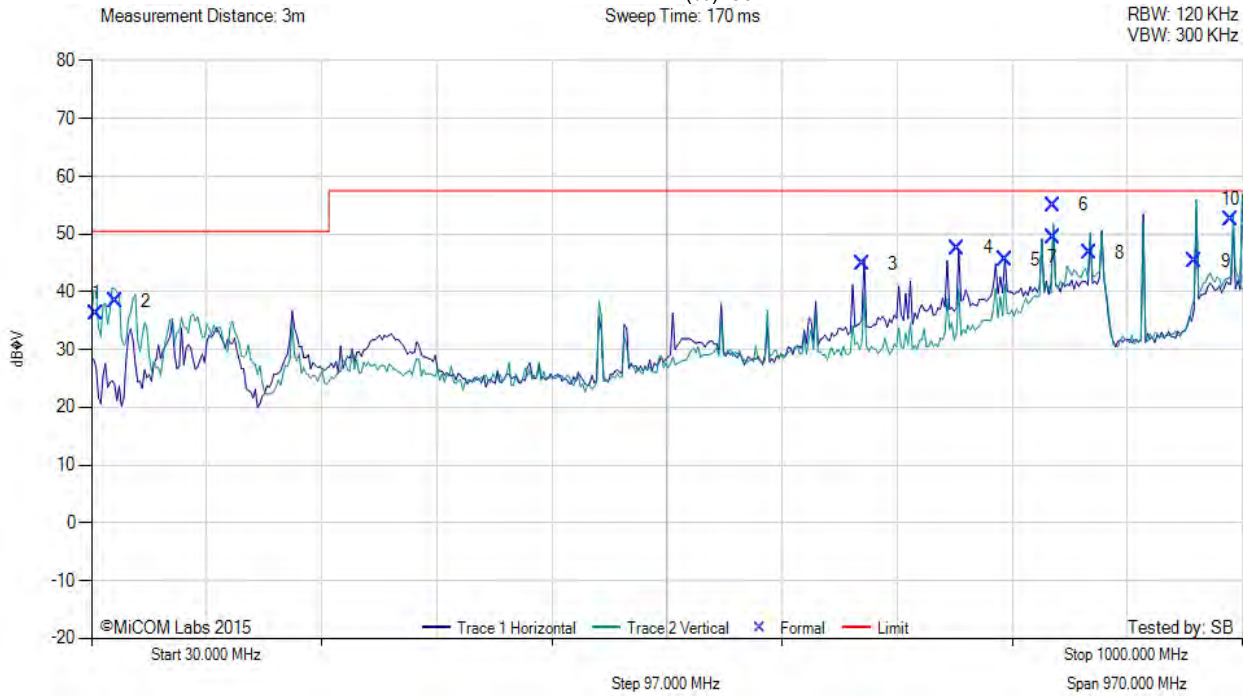

Num	Frequency MHz	Raw dBµV	Cable Loss	AF dB	Level dBµV/m	Measurement Type	Pol	Hgt cm	Azt Deg	Limit dBµV/m	Margin dB	Pass /Fail
1	34.10	45.65	3.45	-12.88	36.22	MaxQP	Vertical	100	104	50.5	-14.3	Pass
2	49.80	57.96	3.57	-23.14	38.39	MaxQP	Vertical	112	333	50.5	-12.1	Pass
3	679.96	49.52	5.81	-10.45	44.88	MaxQP	Horizontal	105	353	57.0	-12.1	Pass
4	759.98	50.90	6.02	-9.30	47.62	MaxQP	Horizontal	100	12	57.0	-9.4	Pass
5	799.98	48.39	6.08	-8.93	45.54	MaxQP	Horizontal	100	356	57.0	-11.5	Pass
6	839.98	57.26	6.22	-8.49	54.99	MaxQP	Horizontal	150	350	57.0	-2.0	Pass
7	840.04	51.79	6.22	-8.49	49.52	MaxQP	Vertical	111	14	57.0	-7.5	Pass
8	870.54	48.59	6.26	-8.16	46.69	MaxQP	Vertical	112	6	57.0	-10.4	Pass
9	960.04	45.91	6.49	-7.15	45.25	MaxQP	Vertical	100	2	57.0	-11.8	Pass

This test report may be reproduced in full only. The document may only be updated by MiCOM Labs personnel. All changes will be noted in the Document History section of the report.



Title: Alien Technology ALR-F800
To: FCC CFR 47 Part 15 Subpart C 15.247 (DTS)
Serial #: ALNT60-U2 Rev A
Issue Date: 17th August 2015
Page: 53 of 74

10	990.49	52.63	6.55	-6.61	52.57	MaxQP	Vertical	100	1	57.0	-4.4	Pass
11	1000.00	53.62	6.60	-6.41	53.81	MaxQP	Vertical	100	353	57.0	-3.2	Pass

Test Notes: The ALR-F800 is a Class A device

This test report may be reproduced in full only. The document may only be updated by MiCOM Labs personnel. All changes will be noted in the Document History section of the report.



Title: Alien Technology ALR-F800
To: FCC CFR 47 Part 15 Subpart C 15.247 (DTS)
Serial #: ALNT60-U2 Rev A
Issue Date: 17th August 2015
Page: 54 of 74

Equipment Configuration for Digital Emissions (0.03 - 1 GHz)

Antenna:	Alien Technology ALR-8696	Variant:	FHSS
Antenna Gain (dBi):	5.50	Modulation:	PRSK
Beam Forming Gain (Y):	Not Applicable	Duty Cycle (%):	99
Channel Frequency (MHz):	927.25	Data Rate:	25.00 Tari
Power Setting:	275	Tested By:	SB

Test Measurement Results

DIGITAL EMISSIONS (0.03 - 1 GHz)



Variant: FHSS, Test Freq: 927.25 MHz, Antenna: Alien Technologies ALR-8696, Power Setting: 275, Duty Cycle (%): 99

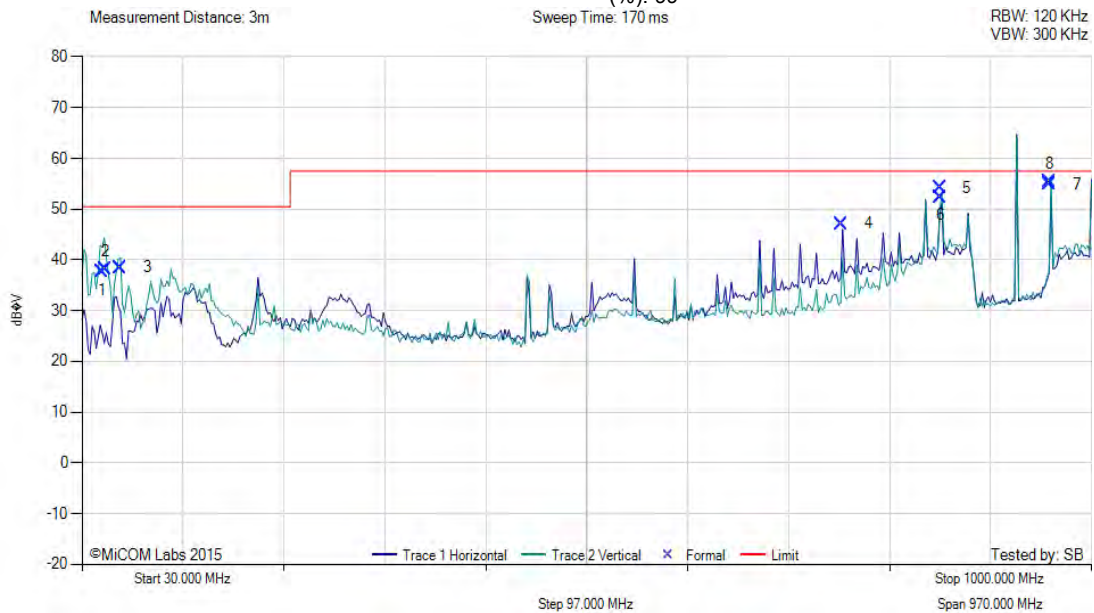

Num	Frequency MHz	Raw dBµV	Cable Loss	AF dB	Level dBµV/m	Measurement Type	Pol	Hgt cm	Azt Deg	Limit dBµV/m	Margin dB	Pass /Fail
1	48.89	56.95	3.56	-22.83	37.68	MaxQP	Vertical	100	93	50.5	-12.8	Pass
2	52.78	58.53	3.59	-23.92	38.20	MaxQP	Vertical	122	309	50.5	-12.3	Pass
3	66.93	58.13	3.69	-23.30	38.52	MaxQP	Vertical	186	219	50.5	-12.0	Pass
4	759.98	50.41	6.02	-9.30	47.13	MaxQP	Horizontal	100	12	57.0	-9.9	Pass
5	854.51	56.25	6.24	-8.29	54.20	MaxQP	Horizontal	144	356	57.0	-3.8	Pass
6	854.51	54.40	6.24	-8.29	52.35	MaxQP	Vertical	115	17	57.0	-4.7	Pass
7	959.96	55.58	6.49	-7.15	54.92	MaxQP	Vertical	100	8	57.0	-2.1	Pass
8	959.98	55.10	6.49	-7.15	55.44	MaxQP	Horizontal	122	15	57.0	-1.6	Pass
9	1000.00	53.62	6.60	-6.41	53.81	MaxQP	Vertical	100	353	57.0	-3.2	Pass

Test Notes: The ALR-F800 is a Class A device

This test report may be reproduced in full only. The document may only be updated by MiCOM Labs personnel. All changes will be noted in the Document History section of the report.



Title: Alien Technology ALR-F800
To: FCC CFR 47 Part 15 Subpart C 15.247 (DTS)
Serial #: ALNT60-U2 Rev A
Issue Date: 17th August 2015
Page: 55 of 74

9.8. ac Wireline Emissions

FCC, Part 15 Subpart C §15.207

Test Procedure

The EUT is configured in accordance with ANSI C63.4. The conducted emissions are measured in a shielded room with a spectrum analyzer in peak hold in the first instance. Emissions closest to the limit are measured in the quasi-peak mode (QP) with the tuned receiver using a bandwidth of 9 kHz. The emissions are maximized further by cable manipulation. The highest emissions relative to the limit are listed.

This test report may be reproduced in full only. The document may only be updated by MiCOM Labs personnel. All changes will be noted in the Document History section of the report.



Title: Alien Technology ALR-F800
To: FCC CFR 47 Part 15 Subpart C 15.247 (DTS)
Serial #: ALNT60-U2 Rev A
Issue Date: 17th August 2015
Page: 56 of 74

Measurement Results for ac Wireline Conducted Emissions (150 kHz – 30 MHz)

Model Number	POE30U-560(G)	Engineer	SB
Variant	AC Wireline 120Vac 60 Hz	Temp (°C)	10
Freq. Range	0.150 MHz - 30 MHz	Rel. Hum.(%)	37
Power Setting	N/A	Press. (mBars)	1010
Antenna	50 Ohm Termination		
Test Notes 1	120VAC / 1.0A (56VDC / 0.55A);		
Test Notes 2	Class B Limits		

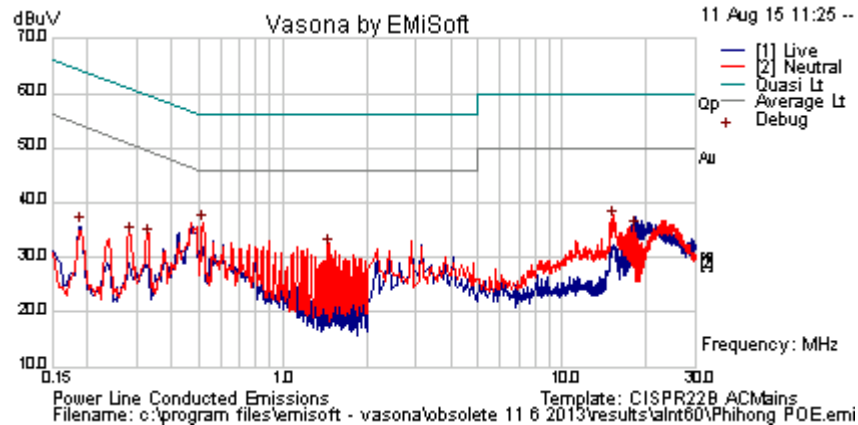

Formally measured emission peaks

Frequency MHz	Raw dBuV	Cable Loss	Factors dB	Level dBuV	Measurement Type	Line	Limit dBuV	Margin dB	Pass /Fail	Comments
0.520	26.0	9.9	0.1	36.0	Peak [Scan]	Neutral	46	-10.0	Pass	
15.373	26.0	10.4	0.6	37.0	Peak [Scan]	Neutral	50	-13.0	Pass	
1.455	21.8	10.0	0.1	31.9	Peak [Scan]	Neutral	46	-14.1	Pass	
18.377	23.9	10.5	0.7	35.1	Peak [Scan]	Live	50	-14.9	Pass	
0.333	23.5	9.9	0.1	33.4	Peak [Scan]	Neutral	49.38	-15.9	Pass	
0.287	24.2	9.9	0.1	34.1	Peak [Scan]	Neutral	50.61	-16.5	Pass	
0.190	25.7	9.9	0.1	35.6	Peak [Scan]	Live	54.04	-18.4	Pass	

Legend: DIG = Digital Device Emission; TX = Transmitter Emission; FUND = Fundamental Frequency
 NRB = Non-Restricted Band, Limit is 20 dB below Fundamental; RB = Restricted Band

This test report may be reproduced in full only. The document may only be updated by MiCOM Labs personnel. All changes will be noted in the Document History section of the report.



Title: Alien Technology ALR-F800
To: FCC CFR 47 Part 15 Subpart C 15.247 (DTS)
Serial #: ALNT60-U2 Rev A
Issue Date: 17th August 2015
Page: 57 of 74

Model Number	PSAC30U-120	Engineer	SB
Variant	AC Wireline 120Vac 60 Hz	Temp (°C)	10
Freq. Range	0.150 MHz - 30 MHz	Rel. Hum.(%)	37
Power Setting	N/A	Press. (mBars)	1010
Antenna	50 Ohm Termination		
Test Notes 1	Switching PSU; Model:		
Test Notes 2	Class B Limits		

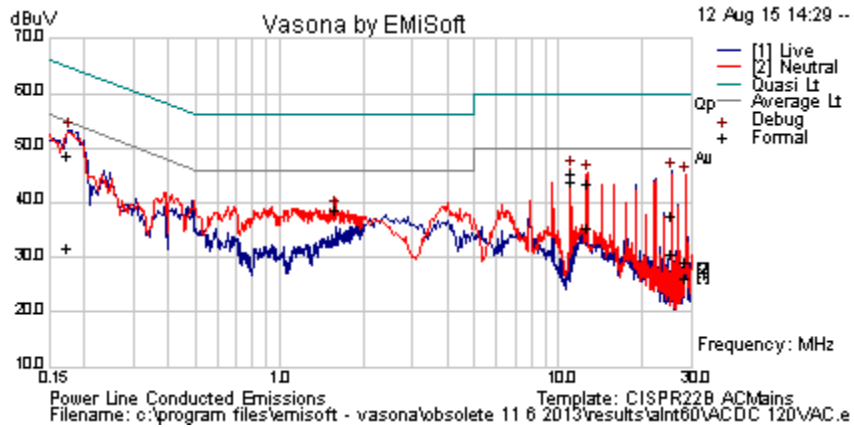

Formally measured emission peaks

Frequency MHz	Raw dBuV	Cable Loss	Factors dB	Level dBuV	Measurement Type	Line	Limit dBuV	Margin dB	Pass /Fail	Comments
0.173	38.7	9.9	0.1	48.7	Quasi Peak	Neutral	64.8	-16.1	Pass	
11.122	34.6	10.3	0.4	45.3	Quasi Peak	Neutral	60.0	-14.7	Pass	
25.429	26.2	10.6	0.9	37.7	Quasi Peak	Neutral	60.0	-22.3	Pass	
12.718	32.5	10.3	0.5	43.4	Quasi Peak	Neutral	60.0	-16.6	Pass	
28.567	17.6	10.8	0.9	29.3	Quasi Peak	Neutral	60.0	-30.7	Pass	
0.173	21.6	9.9	0.1	31.6	Average	Neutral	54.8	-23.2	Pass	
11.122	33.2	10.3	0.4	44.0	Average	Neutral	50.0	-6.1	Pass	
25.429	19.0	10.6	0.9	30.6	Average	Neutral	50.0	-19.4	Pass	
12.718	24.4	10.3	0.5	35.2	Average	Neutral	50.0	-14.8	Pass	
28.567	14.4	10.8	0.9	26.1	Average	Neutral	50.0	-23.9	Pass	
1.598	28.7	10.0	0.1	38.8	Peak [Scan]	Neutral	46.0	-7.2	Pass	

Legend: DIG = Digital Device Emission; TX = Transmitter Emission; FUND = Fundamental Frequency
 NRB = Non-Restricted Band, Limit is 20 dB below Fundamental; RB = Restricted Band

This test report may be reproduced in full only. The document may only be updated by MiCOM Labs personnel. All changes will be noted in the Document History section of the report.



Specification

Limits

§15.207 (a) Except as shown in paragraphs (b) and (c) of this section, for an intentional radiator that is designed to be connected to the public utility (AC) power line, the radio frequency voltage that is conducted back onto the AC power line on any frequency or frequencies within the band 150 kHz to 30 MHz shall not exceed the limits in the following table, as measured using a 50 $\mu\Omega$ line impedance stabilization network (LISN), see §15.207 (a) matrix below. Compliance with the provisions of this paragraph shall be based on the measurement of the radio frequency voltage between each power line and ground at the power terminal.

§15.207 (a) Limit Matrix

The lower limit applies at the boundary between frequency ranges

Frequency of Emission (MHz)	Conducted Limit (dB μ V)	
	Quasi-peak	Average
0.15-0.5	66 to 56*	56 to 46*
0.5-5	56	46
5-30	60	50

* Decreases with the logarithm of the frequency

Traceability

Test Methodology	Laboratory Measurement Uncertainty
Measurements were made per work instruction WI-EMC-01 'Measurement of Conducted Emissions'	± 2.64 dB

This test report may be reproduced in full only. The document may only be updated by MiCOM Labs personnel. All changes will be noted in the Document History section of the report.



Title: Alien Technology ALR-F800
To: FCC CFR 47 Part 15 Subpart C 15.247 (DTS)
Serial #: ALNT60-U2 Rev A
Issue Date: 17th August 2015
Page: 59 of 74

A. APPENDIX - GRAPHICAL IMAGES

This test report may be reproduced in full only. The document may only be updated by MiCOM Labs personnel. All changes will be noted in the Document History section of the report.



A.1. 20 dB & 99% Bandwidth

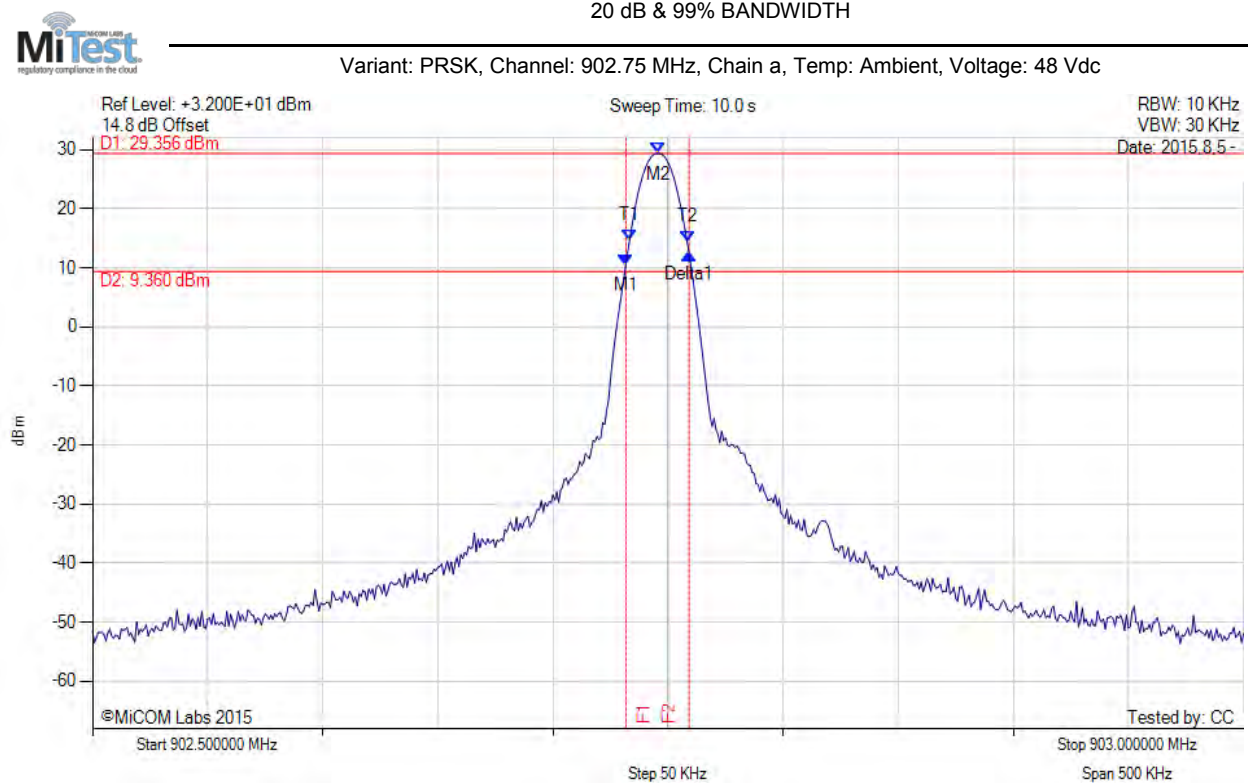

Analyser Setup	Marker:Frequency:Amplitude	Test Results
Detector = POS Sweep Count = 0 RF Atten (dB) = 30 Trace Mode = MAXH	M1 : 902.732 MHz : 10.542 dBm M2 : 902.746 MHz : 29.356 dBm Delta1 : 28 KHz : 1.829 dB T1 : 902.733 MHz : 14.707 dBm T2 : 902.758 MHz : 14.392 dBm OBW : 25 KHz	Measured 6 dB Bandwidth: 0.028 MHz Limit: ≥500.0 kHz Margin: 0.47 MHz

[back to matrix](#)

This test report may be reproduced in full only. The document may only be updated by MiCOM Labs personnel. All changes will be noted in the Document History section of the report.



20 dB & 99% BANDWIDTH



Variant: PRSK, Channel: 915.25 MHz, Chain a, Temp: Ambient, Voltage: 48 Vdc

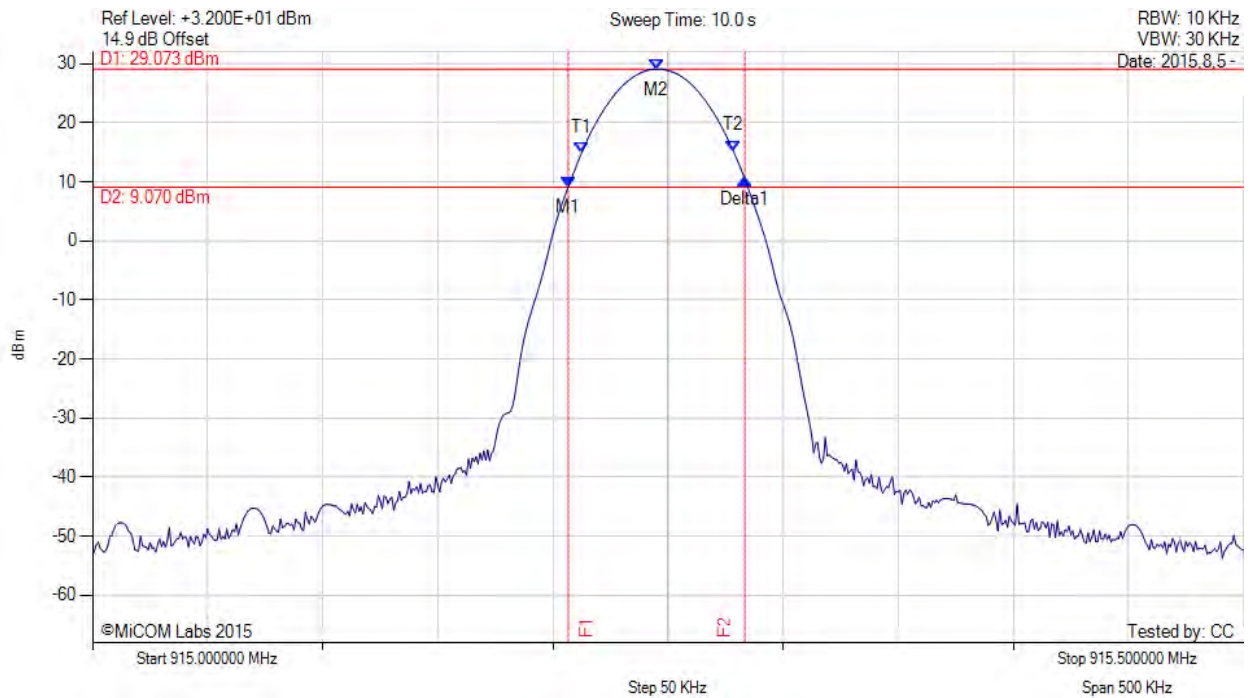

Analyser Setup	Marker:Frequency:Amplitude	Test Results
Detector = POS Sweep Count = 0 RF Atten (dB) = 30 Trace Mode = MAXH	M1 : 915.207 MHz : 9.106 dBm M2 : 915.245 MHz : 29.073 dBm Delta1 : 77 KHz : 1.388 dB T1 : 915.213 MHz : 14.936 dBm T2 : 915.278 MHz : 15.252 dBm OBW : 66 KHz	Measured 6 dB Bandwidth: 0.077 MHz Limit: ≥250.0 kHz Margin: 0.17 MHz

[back to matrix](#)

This test report may be reproduced in full only. The document may only be updated by MiCOM Labs personnel. All changes will be noted in the Document History section of the report.



20 dB & 99% BANDWIDTH



Variant: PRSK, Channel: 927.25 MHz, Chain a, Temp: Ambient, Voltage: 48 Vdc

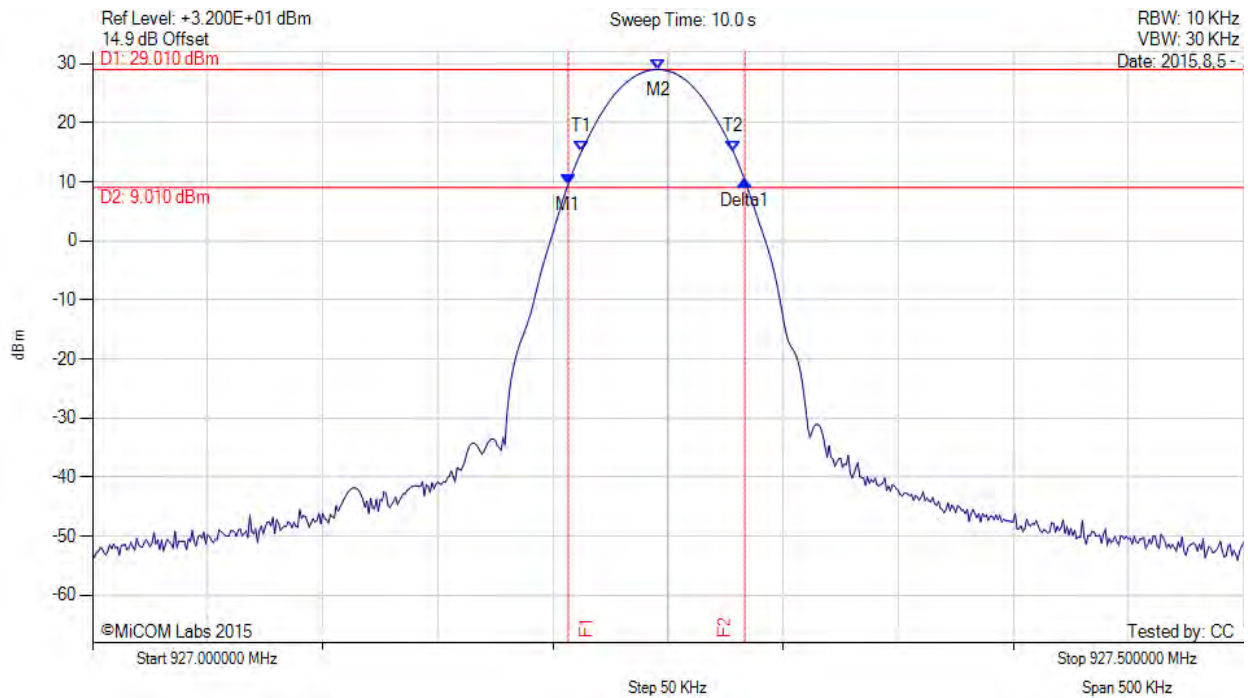

Analyser Setup	Marker:Frequency:Amplitude	Test Results
Detector = POS Sweep Count = 0 RF Atten (dB) = 30 Trace Mode = MAXH	M1 : 927.207 MHz : 9.623 dBm M2 : 927.246 MHz : 29.010 dBm Delta1 : 77 KHz : 0.650 dB T1 : 927.213 MHz : 15.197 dBm T2 : 927.278 MHz : 15.114 dBm OBW : 67 KHz	Measured 6 dB Bandwidth: 0.077 MHz Limit: ≥250.0 kHz Margin: 0.17 MHz

[back to matrix](#)

This test report may be reproduced in full only. The document may only be updated by MiCOM Labs personnel. All changes will be noted in the Document History section of the report.



Title: Alien Technology ALR-F800
To: FCC CFR 47 Part 15 Subpart C 15.247 (DTS)
Serial #: ALNT60-U2 Rev A
Issue Date: 17th August 2015
Page: 63 of 74

A.2. Number Of Channels



Hopping Sequence 902-912

Variant: PRSK, Channel: Hopping, Chain a, Temp: Ambient, Voltage: 12 Vdc

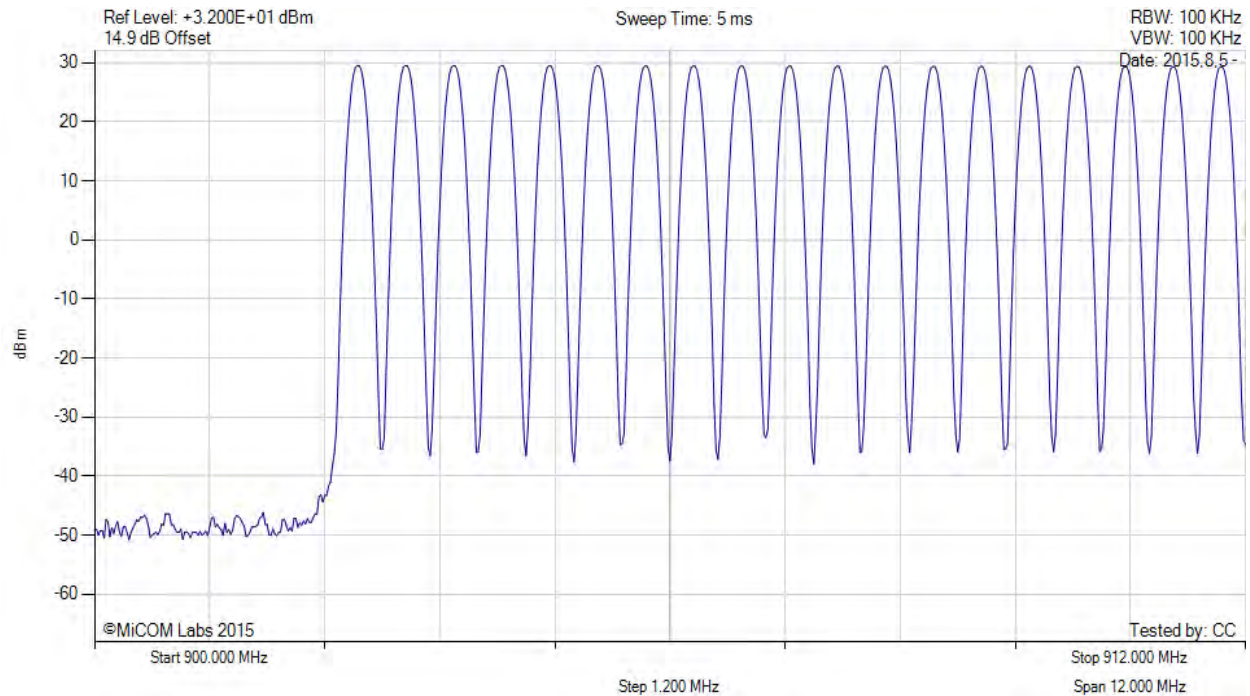

Analyser Setup	Marker:Frequency:Amplitude	Test Results
Detector = POS Sweep Count = 0 RF Atten (dB) = 30 Trace Mode = VIEW		

[back to matrix](#)

This test report may be reproduced in full only. The document may only be updated by MiCOM Labs personnel. All changes will be noted in the Document History section of the report.



Title: Alien Technology ALR-F800
To: FCC CFR 47 Part 15 Subpart C 15.247 (DTS)
Serial #: ALNT60-U2 Rev A
Issue Date: 17th August 2015
Page: 64 of 74

Hopping Sequence 912-920 MHz



Variant: PRSK, Channel: Hopping, Chain a, Temp: Ambient, Voltage: 12 Vdc

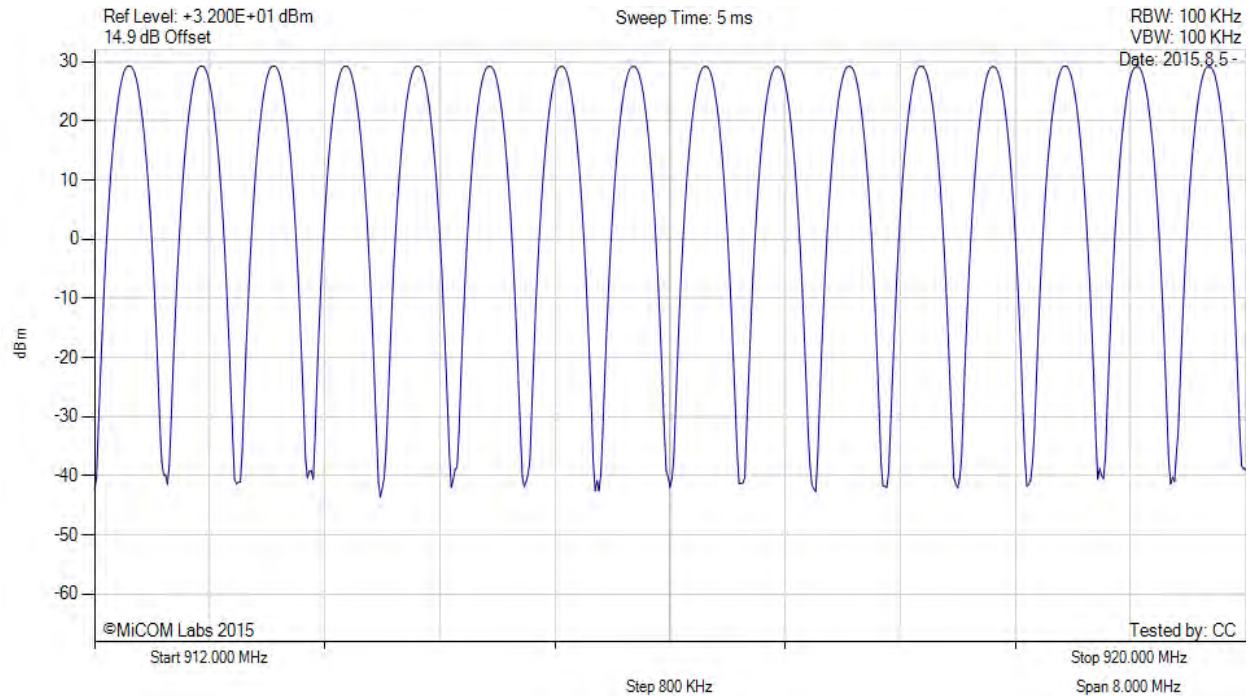

Analyser Setup	Marker:Frequency:Amplitude	Test Results
Detector = POS Sweep Count = 0 RF Atten (dB) = 30 Trace Mode = VIEW		

[back to matrix](#)

This test report may be reproduced in full only. The document may only be updated by MiCOM Labs personnel. All changes will be noted in the Document History section of the report.



Title: Alien Technology ALR-F800
To: FCC CFR 47 Part 15 Subpart C 15.247 (DTS)
Serial #: ALNT60-U2 Rev A
Issue Date: 17th August 2015
Page: 65 of 74

Hopping Sequence 920-928 MHz



Variant: PRSK, Channel: Hopping, Chain a, Temp: Ambient, Voltage: 12 Vdc

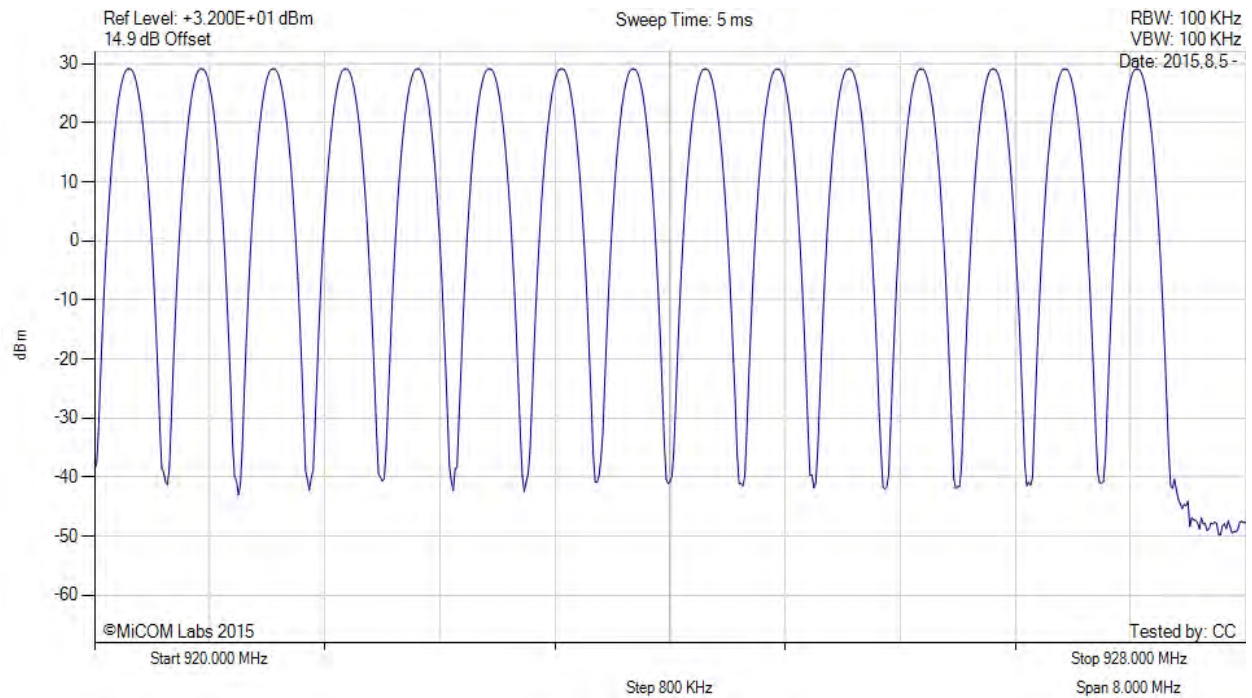

Analyser Setup	Marker:Frequency:Amplitude	Test Results
Detector = POS Sweep Count = 0 RF Atten (dB) = 30 Trace Mode = VIEW		

[back to matrix](#)

This test report may be reproduced in full only. The document may only be updated by MiCOM Labs personnel. All changes will be noted in the Document History section of the report.



Title: Alien Technology ALR-F800
To: FCC CFR 47 Part 15 Subpart C 15.247 (DTS)
Serial #: ALNT60-U2 Rev A
Issue Date: 17th August 2015
Page: 66 of 74

A.3. Channel Spacing



Channel Spacing

Variant: PRSK, Channel: 902.75 MHz, Chain a, Temp: Ambient, Voltage: 12 Vdc

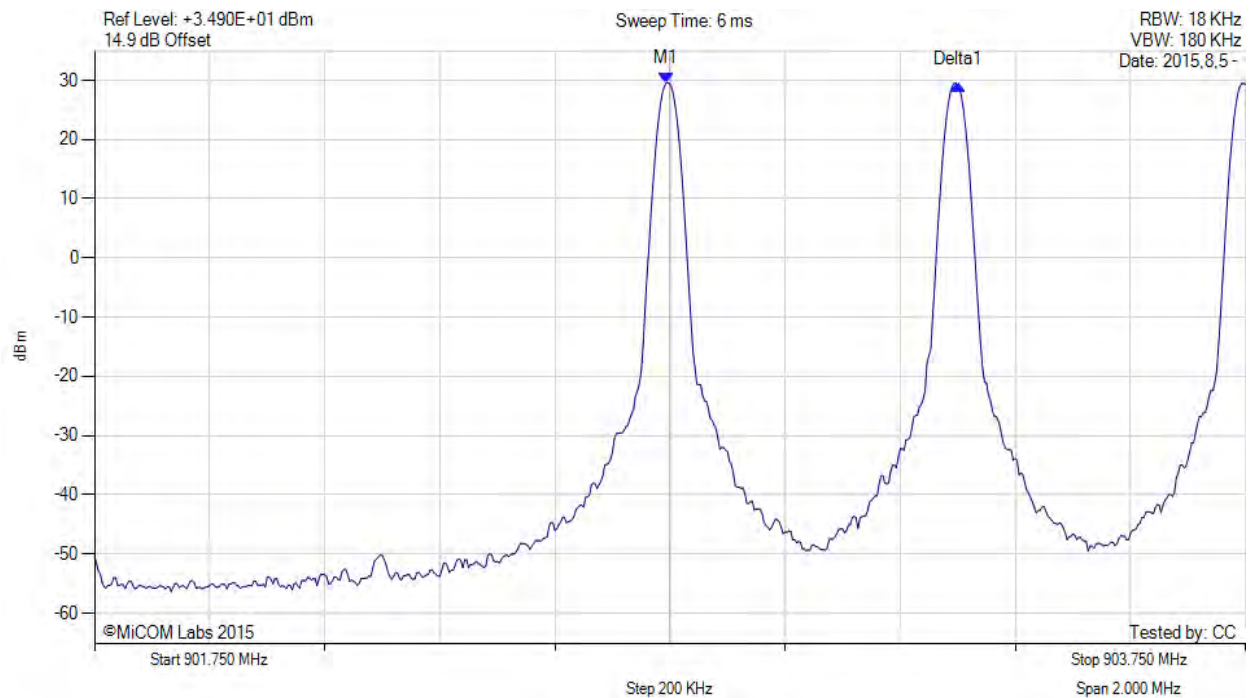

Analyser Setup	Marker:Frequency:Amplitude	Test Results
Detector = POS Sweep Count = 0 RF Atten (dB) = 30 Trace Mode = MAXH	M1 : 902.743 MHz : 29.470 dBm Delta1 : 507 KHz : -0.115 dB	Channel Frequency: 902.75 MHz

[back to matrix](#)

This test report may be reproduced in full only. The document may only be updated by MiCOM Labs personnel. All changes will be noted in the Document History section of the report.



Title: Alien Technology ALR-F800
To: FCC CFR 47 Part 15 Subpart C 15.247 (DTS)
Serial #: ALNT60-U2 Rev A
Issue Date: 17th August 2015
Page: 67 of 74

A.4. Dwell Time & Channel Occupancy



Dwell Time

Variant: PRSK, Channel: 927.25 MHz, Chain a, Temp: Ambient, Voltage: 12 Vdc

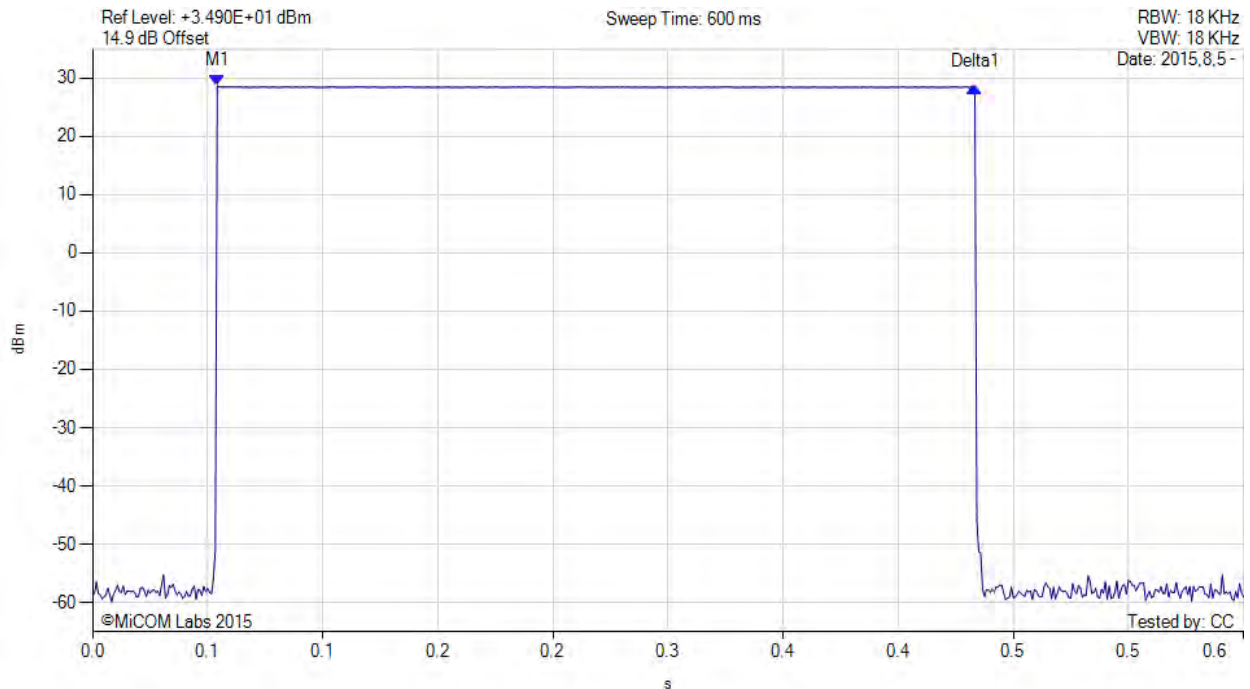

Analyser Setup	Marker:Time:Amplitude	Test Results
Detector = POS Sweep Count = 0 RF Atten (dB) = 30 Trace Mode = VIEW	M1(927.25 MHz) : 0.065 s : 28.640 dBm Delta1(927.25 MHz) : 0.395 s : -0.241 dB	Channel Frequency: 927.25 MHz

[back to matrix](#)

This test report may be reproduced in full only. The document may only be updated by MiCOM Labs personnel. All changes will be noted in the Document History section of the report.



Title: Alien Technology ALR-F800
To: FCC CFR 47 Part 15 Subpart C 15.247 (DTS)
Serial #: ALNT60-U2 Rev A
Issue Date: 17th August 2015
Page: 68 of 74

Channel Occupancy



Variant: PRSK, Channel: 927.25 MHz, Chain a, Temp: Ambient, Voltage: 12 Vdc

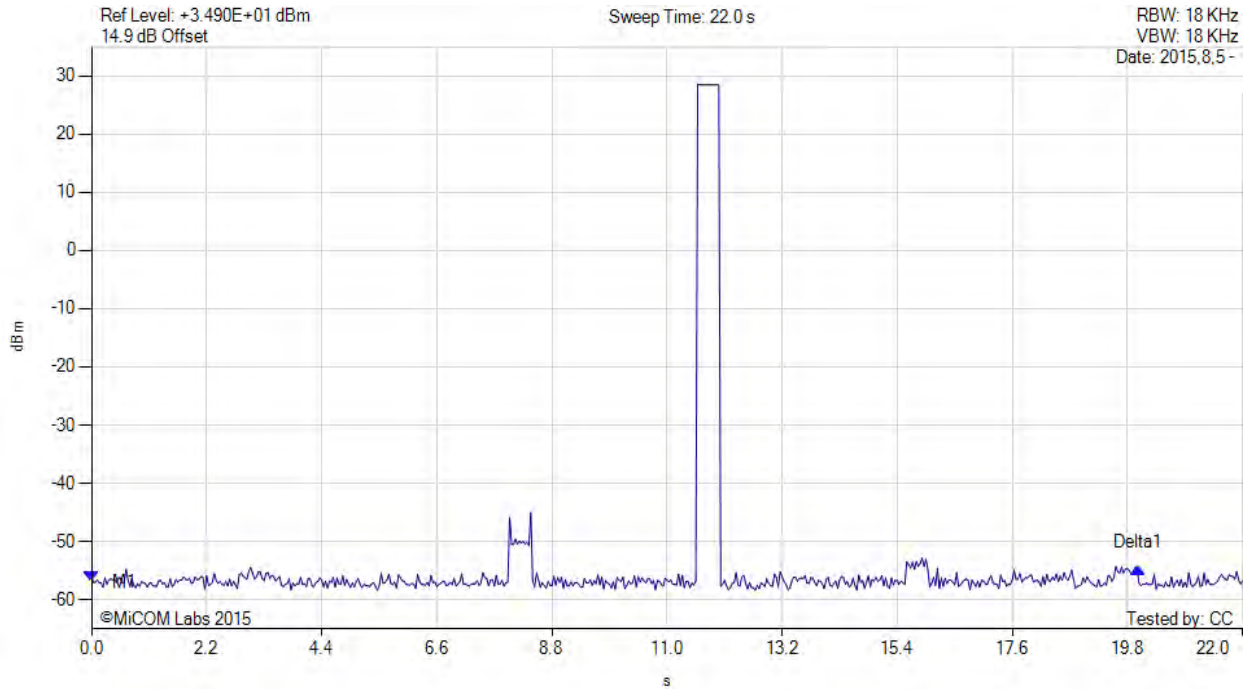

Analyser Setup	Marker:Time:Amplitude	Test Results
Detector = POS Sweep Count = 0 RF Atten (dB) = 30 Trace Mode = VIEW	M1(927.25 MHz) : 0.000 s : -56.920 dBm Delta1(927.25 MHz) : 20.000 s : 2.409 dB	Channel Frequency: 927.25 MHz

[back to matrix](#)

This test report may be reproduced in full only. The document may only be updated by MiCOM Labs personnel. All changes will be noted in the Document History section of the report.



Title: Alien Technology ALR-F800
To: FCC CFR 47 Part 15 Subpart C 15.247 (DTS)
Serial #: ALNT60-U2 Rev A
Issue Date: 17th August 2015
Page: 69 of 74

A.5. Emissions

A.5.1. Conducted Emissions

A.5.1.1. Conducted Spurious Emissions

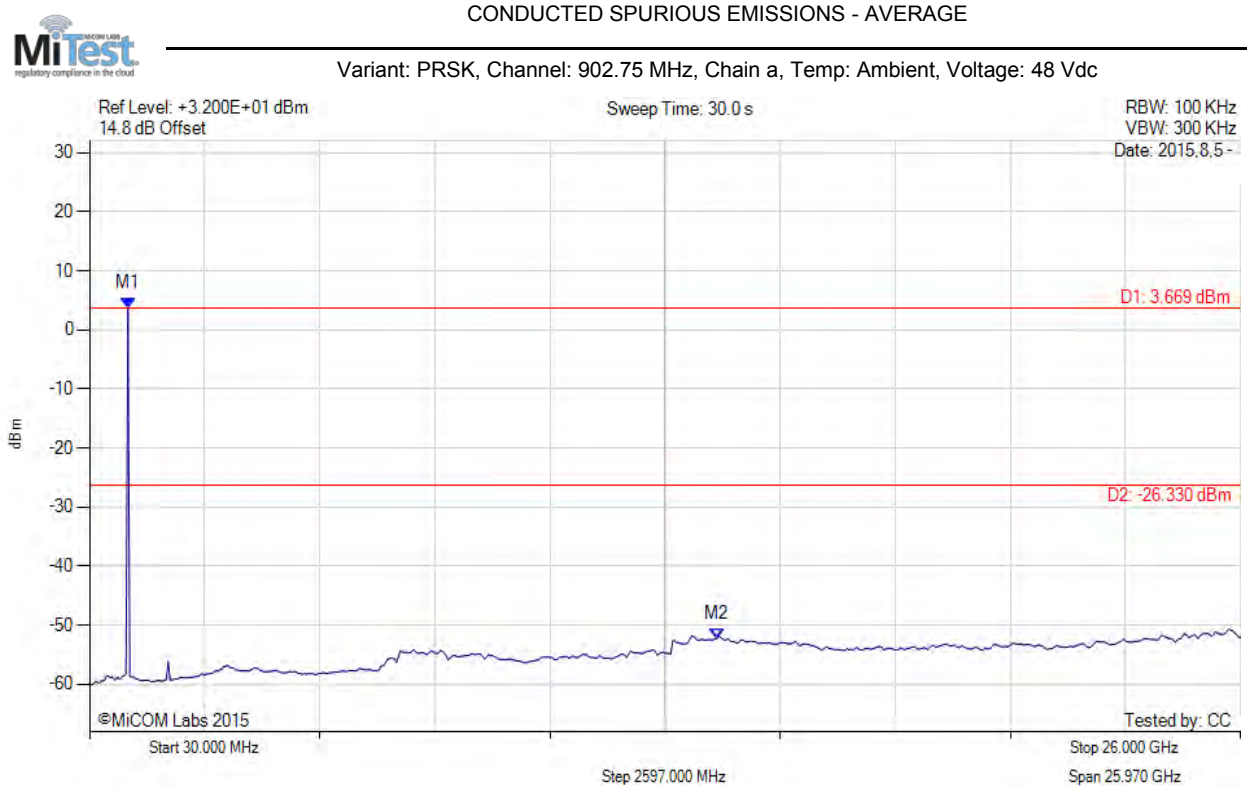

Analyser Setup	Marker:Frequency:Amplitude	Test Results
Detector = AVER Sweep Count = 0 RF Atten (dB) = 30 Trace Mode = VIEW	M1 : 900.000 MHz : 3.669 dBm M2 : 14.180 GHz : -52.300 dBm	Limit: -26.33 dBm Margin: -25.97 dB

[back to matrix](#)

This test report may be reproduced in full only. The document may only be updated by MiCOM Labs personnel. All changes will be noted in the Document History section of the report.



Title: Alien Technology ALR-F800
To: FCC CFR 47 Part 15 Subpart C 15.247 (DTS)
Serial #: ALNT60-U2 Rev A
Issue Date: 17th August 2015
Page: 70 of 74

CONDUCTED SPURIOUS EMISSIONS - AVERAGE



Variant: PRSK, Channel: 915.25 MHz, Chain a, Temp: Ambient, Voltage: 48 Vdc

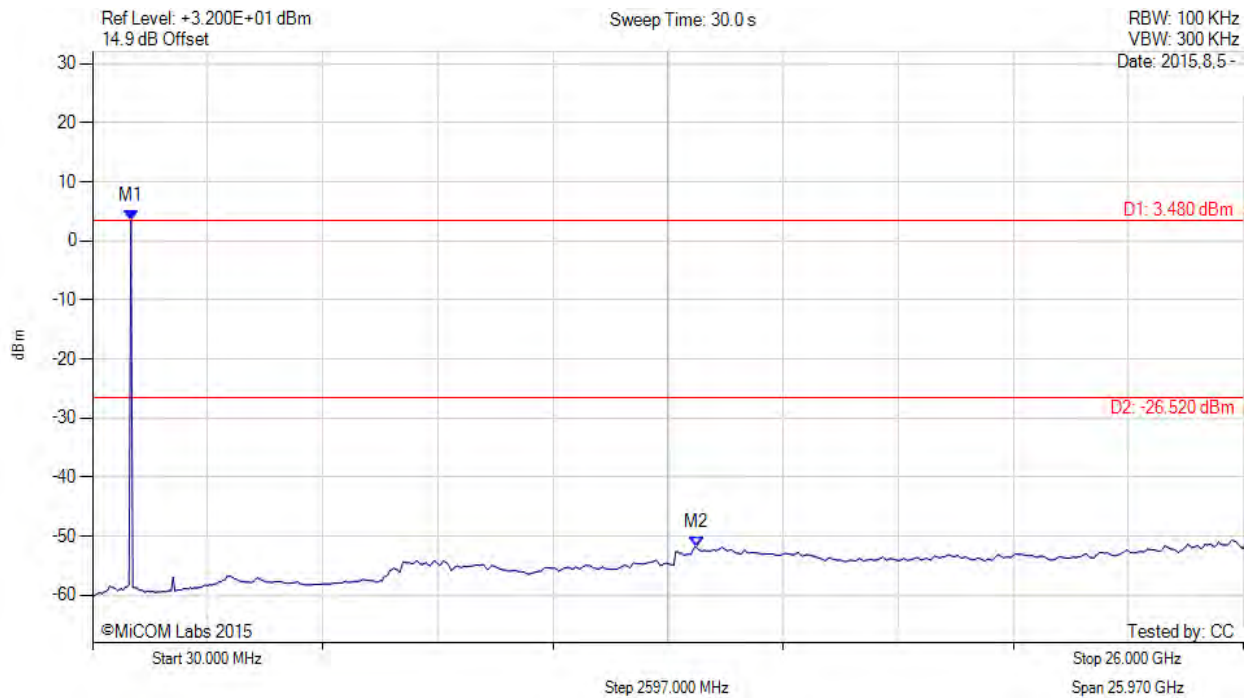

Analyser Setup	Marker:Frequency:Amplitude	Test Results
Detector = AVER Sweep Count = 0 RF Atten (dB) = 30 Trace Mode = VIEW	M1 : 900.000 MHz : 3.480 dBm M2 : 13.660 GHz : -51.926 dBm	Limit: -26.52 dBm Margin: -25.41 dB

[back to matrix](#)

This test report may be reproduced in full only. The document may only be updated by MiCOM Labs personnel. All changes will be noted in the Document History section of the report.



Title: Alien Technology ALR-F800
To: FCC CFR 47 Part 15 Subpart C 15.247 (DTS)
Serial #: ALNT60-U2 Rev A
Issue Date: 17th August 2015
Page: 71 of 74

CONDUCTED SPURIOUS EMISSIONS - AVERAGE



Variant: PRSK, Channel: 927.25 MHz, Chain a, Temp: Ambient, Voltage: 48 Vdc

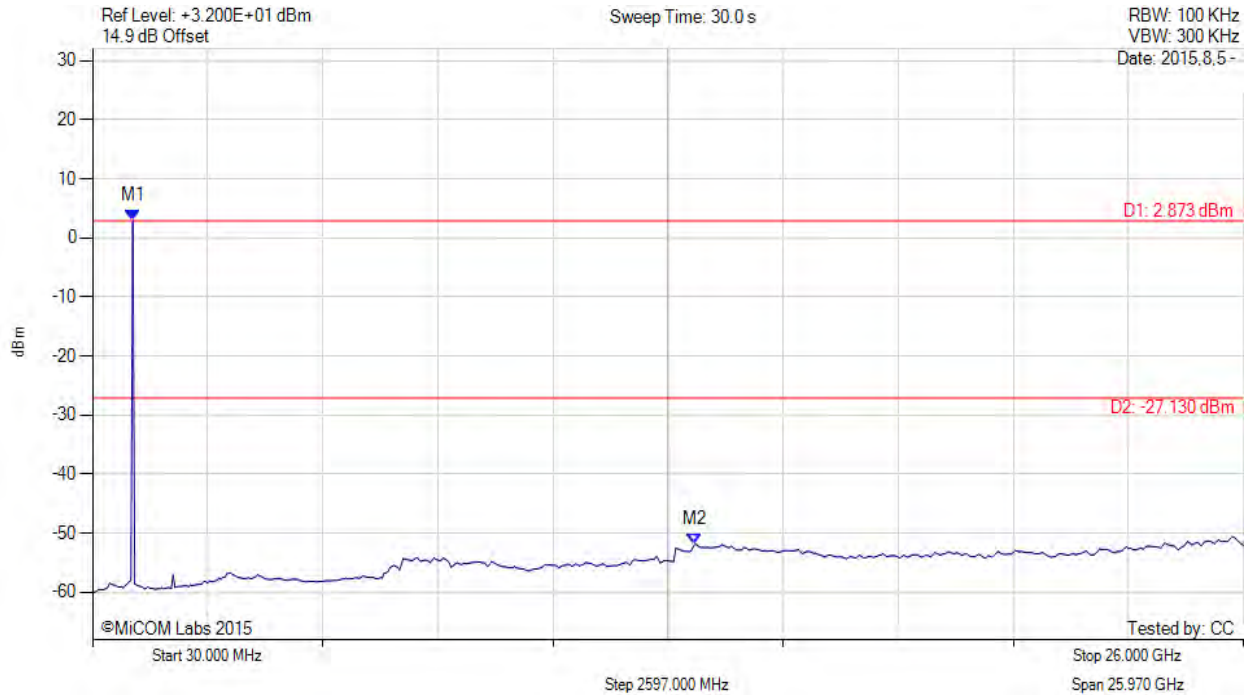

Analyser Setup	Marker:Frequency:Amplitude	Test Results
Detector = AVER Sweep Count = 0 RF Atten (dB) = 30 Trace Mode = VIEW	M1 : 940.000 MHz : 2.873 dBm M2 : 13.620 GHz : -51.863 dBm	Limit: -27.13 dBm Margin: -24.73 dB

[back to matrix](#)

This test report may be reproduced in full only. The document may only be updated by MiCOM Labs personnel. All changes will be noted in the Document History section of the report.



Title: Alien Technology ALR-F800
To: FCC CFR 47 Part 15 Subpart C 15.247 (DTS)
Serial #: ALNT60-U2 Rev A
Issue Date: 17th August 2015
Page: 72 of 74

A.5.1.2. Conducted Band-Edge Emissions



CONDUCTED LOW BAND-EDGE EMISSIONS - AVERAGE

Variant: PRSK, Channel: 902.75 MHz, Chain a, Temp: Ambient, Voltage: 48 Vdc

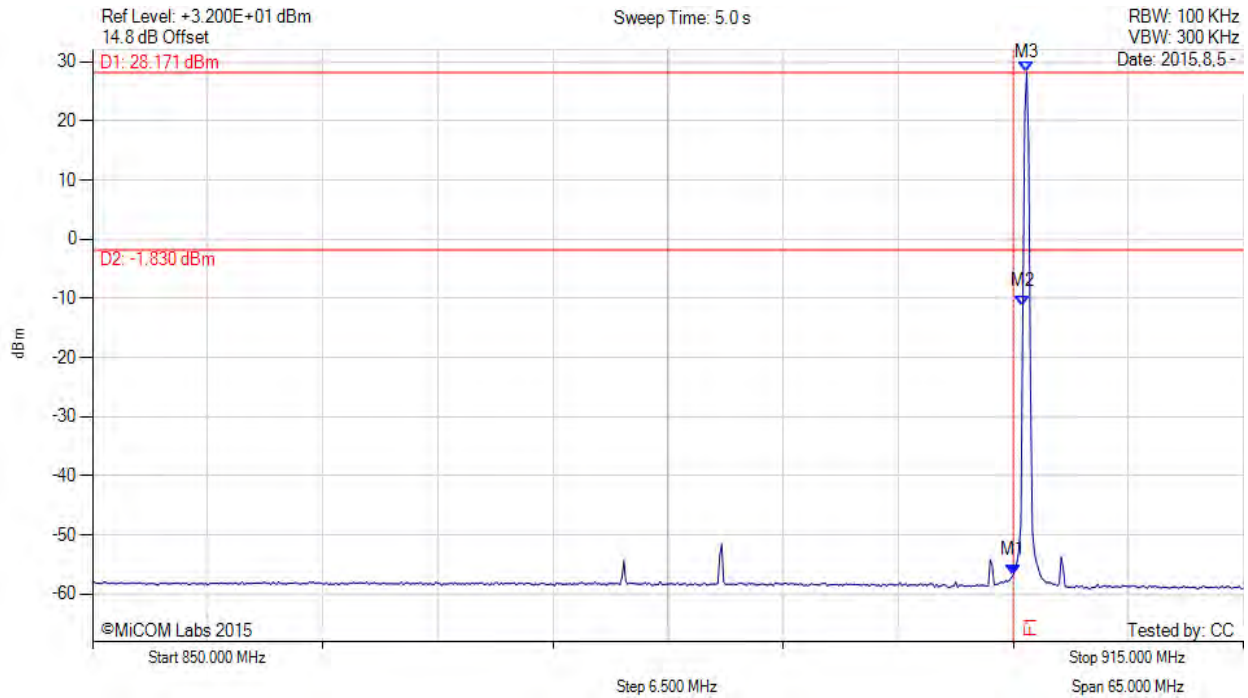

Analyser Setup	Marker:Frequency:Amplitude	Test Results
Detector = AVER Sweep Count = 0 RF Atten (dB) = 30 Trace Mode = VIEW	M1 : 902.000 MHz : -56.769 dBm M2 : 902.540 MHz : -11.456 dBm M3 : 902.760 MHz : 28.171 dBm	Channel Frequency: 902.75 MHz

[back to matrix](#)

This test report may be reproduced in full only. The document may only be updated by MiCOM Labs personnel. All changes will be noted in the Document History section of the report.



Title: Alien Technology ALR-F800
To: FCC CFR 47 Part 15 Subpart C 15.247 (DTS)
Serial #: ALNT60-U2 Rev A
Issue Date: 17th August 2015
Page: 73 of 74

CONDUCTED HIGH BAND-EDGE EMISSIONS - AVERAGE



Variant: PRSK, Channel: 927.25 MHz, Chain a, Temp: Ambient, Voltage: 48 Vdc

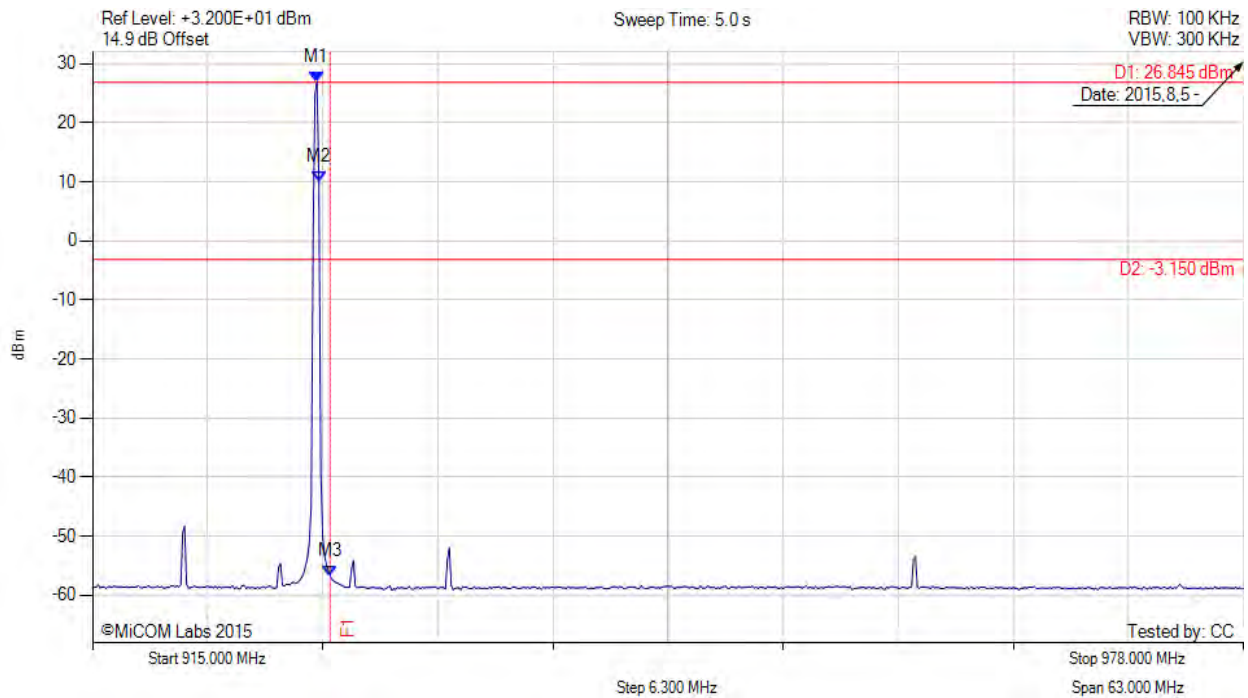

Analyser Setup	Marker:Frequency:Amplitude	Test Results
Detector = AVER Sweep Count = 0 RF Atten (dB) = 30 Trace Mode = VIEW	M1 : 927.280 MHz : 26.845 dBm M2 : 927.390 MHz : 10.021 dBm M3 : 928.000 MHz : -56.752 dBm	Channel Frequency: 927.25 MHz

[back to matrix](#)

This test report may be reproduced in full only. The document may only be updated by MiCOM Labs personnel. All changes will be noted in the Document History section of the report.



575 Boulder Court
Pleasanton, California 94566, USA
Tel: +1 (925) 462 0304
Fax: +1 (925) 462 0306
www.micomlabs.com