

ALIEN TECHNOLOGY®

HARDWARE SETUP GUIDE

ALR-9800

July 12, 2005

**U.S. Multi-static 915 MHz
RFID Tag Reader**



ALIEN®

ALR-9800

Legal Notices

Copyright © 2005 Alien Technology Corporation. All rights reserved.

Alien Technology Corporation has intellectual property rights relating to technology embodied in the products described in this document, including without limitation certain patents or patent pending applications in the U.S. or other countries.

This document and the products to which it pertains are distributed under licenses restricting their use, copying, distribution and decompilation. No part of this product documentation may be reproduced in any form or by any means without the prior written consent of Alien Technology Corporation and its licensors, if any. Third party software is copyrighted and licensed from Licensors. Alien, Alien Technology, the Alien logo, Nanoblock, FSA, Gen2Ready, Squiggle, the Squiggle logo, Nanoscanner and other graphics, logos, and service names used in this document are trademarks of Alien Technology Corporation in the U.S. and other countries. All other trademarks are the property of their respective owners. U.S. Government approval required when exporting the product described in this documentation.

Federal Acquisitions: Commercial Software -- Government Users Subject to Standard License Terms and Conditions. U.S. Government: If this Software is being acquired by or on behalf of the U.S. Government or by a U.S. Government prime contractor or subcontractor (at any tier), then the Government's rights in the Software and accompanying documentation shall be only as set forth in this license; this is in accordance with 48 C.F.R. 227.7201 through 227.7202-4 (for Department of Defense (DoD) acquisitions) and with 48 C.F.R. 2.101 and 12.212 (for non-DoD acquisitions).

DOCUMENTATION IS PROVIDED "AS IS" AND ALL EXPRESS OR IMPLIED CONDITIONS, REPRESENTATIONS AND WARRANTIES, INCLUDING ANY IMPLIED WARRANTY OF MERCHANTABILITY, FITNESS FOR A PARTICULAR PURPOSE OR NON-INFRINGEMENT ARE HEREBY DISCLAIMED, EXCEPT TO THE EXTENT THAT SUCH DISCLAIMERS ARE HELD TO BE LEGALLY INVALID.

FCC Compliance (pending)

This equipment has been tested and found to comply with the limits for Class A digital device, pursuant to Part 15 of the FCC Rules. These limits are designed to provide reasonable protection against harmful interference when the equipment is operated in a commercial environment. This equipment generates, uses and can radiate radio frequency energy and, if not installed and used in accordance with instruction manual, may cause harmful interference with radio communications. Operation of this equipment in a residential area is likely to cause harmful interference in which case the user will be required to correct the interference at his own expense.

Any change or modification to this product voids the user's authority to operate per FCC Part 15 Subpart A. Section 15.21 regulations.

Industry Canada Compliance (pending)

Operation is subject to the following two conditions: (1) this device may not cause interference and (2) this device must accept any interference, including interference that may cause undesired operation of the device.

This device has been designed to operate with an antenna having a maximum gain of 6dBi. Antenna having a higher gain is strictly prohibited per regulations of Industry Canada. The required antenna impedance is 50 ohms.

To reduce potential radio interference to other users, the antenna type and its gain should be so chosen that the equivalent isotropically radiated power (EIRP) is not more than that required for successful communication.

Caution

Reader antennas should be positioned so that personnel in the area for prolonged periods may safely remain at least 23 cm (9 in) in an uncontrolled environment from the antenna's surface. See FCC OET Bulletin 56 "Hazards of radio frequency and electromagnetic fields" and Bulletin 65 "Human exposure to radio frequency electromagnetic fields."

Alien Technology®

Hardware Setup Guide

ALR-9800

July 12, 2005



Table of Contents

CHAPTER 1 INTRODUCTION	1
Audience	1
RFID Reader Overview	2
EPC Class 1 UHF RFID Tags	2
Requirements	3
Specifications	4
RFID Reader	4
RFID Reader External Circular Polarized Antenna	4
RFID Reader External Linear Polarized Antenna	5
Mechanical: Reader Physical Size	6
RS-232 Port Pinouts	7
RS-232 Connector (Female) – Looking at Reader	7
IO Port Terminal Interface	7
I/O Port Screw Terminal (Female) – Looking at Reader	8
System Architecture	8
CHAPTER 2 READER HARDWARE INSTALLATION AND OPERATION	9
Receiving the RFID Reader	9
Reader I/O Panel	10
Antenna Panel	11
System Assembly and Bench Test	12
Bench Test Configuration	12
Bench Test Procedure	15
Installation	15
Requirements	16
Hardware Installation Procedure	16
System Operation: Software Control	18
Reader Interface Guide	18
Demonstration Software Guide	18
Alien RFID Academy	18

(This page intentionally left blank)

CHAPTER 1

Introduction

This *Hardware Setup Guide* provides instructions for installing and operating the ALR-9800 RFID Readers.

This document is designed for use by RFID system integrators and software developers - those who wish to develop software products and extended systems that take full advantage of the RFID Reader's capabilities.

Included with each reader or developer kit is the *Alien RFID Fixed Reader Software Developer's Kit and User Documentation* CD-ROM. This CD contains additional information about RFID and the ALR-9800 including the following:

- *RFID Primer (PN 8101014-000)* – an overview of RFID technology and a glossary of terms.
- *Reader Interface Guide (PN 8101938-000)*– an overview of the communication interfaces for the ALR-9800.
- *Multi-static Application Note (AN17001)* – an overview of multi-static readers.
- *Quick Installation Guide (PN 8102003-000)* – a quick start guide for installing and running the ALR-9800 reader.
- *Quick Reference (PN 8101007-000)* – a quick reference guide summarizing the Alien Reader Protocol command set.
- *Demo Software Guide (PN 8101023-000)* – details installing and operating the Alien RFID Gateway demonstration software.
- *Quick Upgrade Guide (PN 8101051-000)* – briefly explains how to use the demonstration software to upgrade the ALR-9800.

To access these guides, please insert the CD that came with your reader and follow the on-screen prompts.

Audience

For the purposes of this document, we assume the readers of the *Hardware Setup Guide*:

- Are competent PC users
- Have minimal previous knowledge of Radio-Frequency Identification (RFID) technology
- Are experienced in software development and/or hardware systems integration

RFID Reader Overview

The Alien ALR-9800 RFID reader is designed to read and program any EPC Class 1 Generation 1 or 2 tag (see below) and issue event reports to a host computer system. The reader is also designed to read Class 0 tags and to read and program Class 0+ tags. The host computer can be locally connected to the reader via RS-232, or at a remote network location.

The RFID Reader is delivered with the following components and accessories:

- One (1) RFID Reader
- One (1) RS-232 serial cable (to connect to host computer)
- One (1) power supply and cord
- *Alien RFID Fixed Reader Software Developer's Kit and User Documentation* CD-ROM
- *Alien RFID Gateway Application*

EPC Class 1 UHF RFID Tags

The Alien ALR-9800 RFID reader is designed to read and program any EPC Class 1 Generation 1 or 2 tag (see below) and issue event reports to a host computer system. The reader is also designed to read Class 0 tags and to read and program Class 0+ tags.

Class 1 tags are “passive” devices meaning they do not have a battery or other onboard power source. They are powered solely by the RF energy transmitted by an RFID reader.

They communicate with the reader through backscatter modulation in which the tags do not actually transmit RF energy. Instead, they change their reflective characteristics in a systematic way and reflect RF energy back to the reader. An analogy to this is the way you can use a mirror to transmit information by reflecting light from the Sun.

Alien Technology manufactures user-programmable EPC Class 1 tags compliant with all key commercial and DoD mandates. Alien offers a variety of designs capable of delivering optimal performance worldwide, including Europe and Asia.

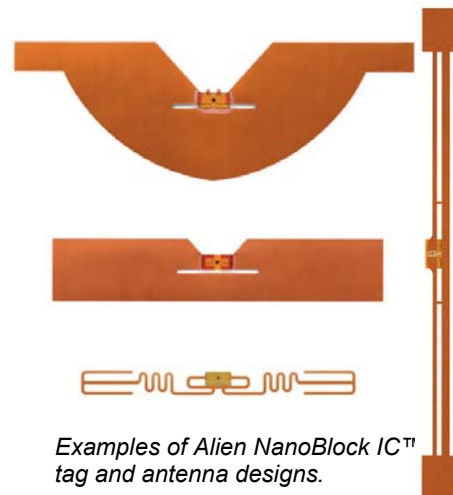

Examples of Alien NanoBlock IC™ tag and antenna designs.

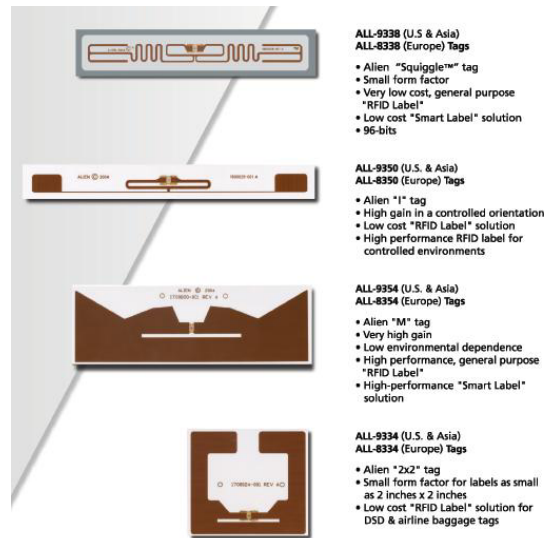

For more information about RFID tags from Alien Technology, please visit our website at <http://www.alientechnology.com>.

Requirements

To interface with the RFID Reader you will need the following:

- A PC running Windows 98 or higher, with CD-ROM drive, an available RS-232 serial port, and Ethernet connectivity
- Standard 120/220 VAC 50/60 Hz
- Power supply and cord (included with reader)
- Host software (Alien Gateway demo software or your own custom software)

Specifications

Specifications for key components of the RFID Reader system are provided in the tables below:

RFID Reader

Name	Alien Multi-Port General Purpose RFID Reader
Model Number	ALR 9800
Architecture	Point-to-multipoint reader network, multi-static
Operating Frequency	902.75 MHz – 927.25 MHz
Hopping Channels	50
Channel Spacing	500 KHz
Channel Dwell Time	< 0.4 Seconds
RF Transmitter	< 30 dBm at the end of 6 m LMR-195 cable.
Modulation Method	On Off Keying (OOK)
20 db Modulation Bandwidth	< 400 KHz
RF Receiver	2 Channels
Power Consumption	45 Watts (120 VAC at 600 mA)
Communications Interface	RS-232 (DB-9 F), TCPI/IP (RJ-45)
Inputs/Outputs	2 or 4 coax antenna, 4/8 optically isolated, com port, LAN, power
Dimensions	(L) 9.0" (22.9 cm) x (W) 11" (28 cm) x (D) 2.22" (5.6 cm)
Weight	Approximately 1.8 kg (4 lb)[d1]
Operating Temperature	0°C to +50°C (+32 °F to +122°F)
LED Indicators	Power, Link, Active, Ant0-3, CPU, Read, Sniff, Fault (red)
Software Support	APIs, sample code, executable demo app (Alien Gateway)
Compliance Certification	FCC Part 15 (Pending)

RFID Reader External Circular Polarized Antenna

Model	ALR-9610-BC
3 dB Beamwidth	E-plane: 65 degrees • H-plane: 65 degrees
Frequency	902-928 MHz
Gain (dBi)	5.73 dBi
Polarization	Circular
RF Connector	6 m LMR-195 with Reverse-Polarity TNC
VSWR	1.5:1
Dimensions	(cm) 22 x 27 x 4 • (in) 8.5 x 10.5 x 1.65
Weight	.57 kg • 1.25 lb

RFID Reader External Linear Polarized Antenna

Model	ALR-9610-AL
3 dB Beamwidth	E-plane: 40 degrees
Frequency	902-928 MHz
Gain (dBi)	6.0 dBi
Polarization	Linear
RF Connector	6 m LMR-195 with Reverse-Polarity TNC
VSWR	1.5:1
Dimensions	(cm) 19.5 x 28 x 4 • (in) 7.75 x 11.25 x 1.65
Weight	.57 kg • 1.25 lb

RS-232 Port Pinouts

RS-232 Connector (Female DB-9F)	
Pin 1	DCD Connected to Pin 6
Pin 2	TR1 Transmit Data (Output)
Pin 3	RC1 Receive Data (Input)
Pin 4	DTR Connected to Pin 6
Pin 5	Ground
Pin 6	DSR Connected to Pin 4
Pin 7	RTS Connected to Pin 8
Pin 8	CTS Connected to Pin 7
Pin 9	Not Connected

RS-232 CONNECTOR (FEMALE) – LOOKING AT READER

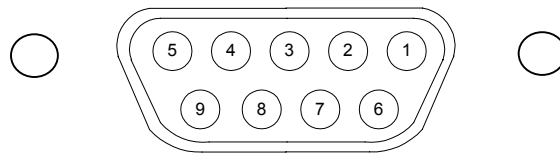

IO Port Terminal Interface

I/O Port Screw Terminal Connector (Female DB-9M)	
Pin 1	V+ Maximum Voltages...[d3]
Pin 2	Output 0 Darlington pair, optically isolated
Pin 3	Output 1 "
Pin 4	Output 2 "
Pin 5	Output 3 "
Pin 6	Output 4 "
Pin 7	Output 5 "
Pin 8	Output 6 "
Pin 9	Output 7 "
Pin 10	Input 0 "
Pin 11	Input 1 "
Pin 12	Input 2 "
Pin 13	Input 3 "
Pin 14	V-

I/O PORT SCREW TERMINAL (FEMALE) – LOOKING AT READER**System Architecture**

Figure 2 - System Architecture for the ALR-9800 Reader

CHAPTER 2

Reader Hardware Installation and Operation

This chapter describes the RFID Reader and provides installation and operation information.

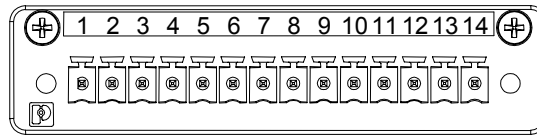
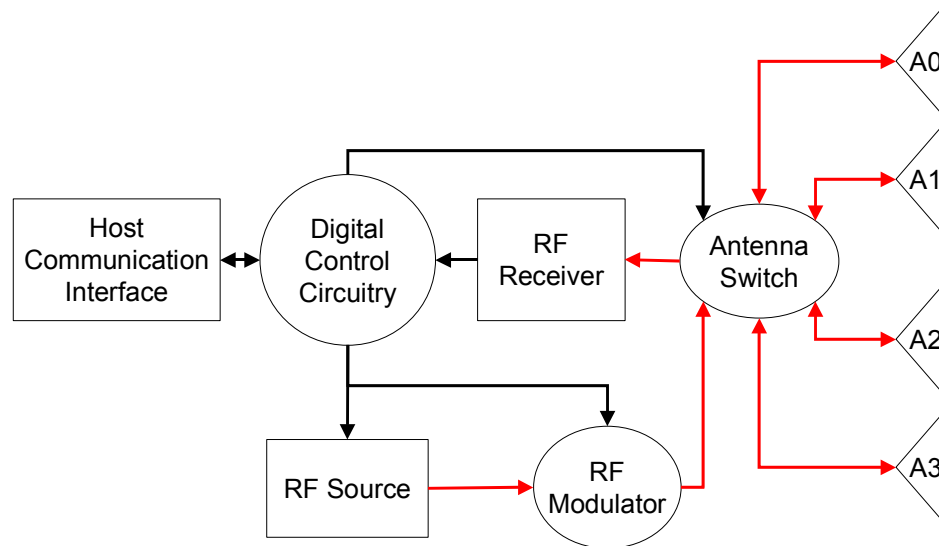
Receiving the RFID Reader

Your RFID Reader Kit is shipped with the items listed below. Please verify the contents of your received shipment before assembling.

- RFID Reader
- Power supply and cables (two sections: one attached, one detached)
- RS-232 reader-to-PC cable
- CD-ROM containing demonstration software, user guides and documentation

The RFID Reader Developer's Kit includes the following additional items:

- Two (2) circular or linear antennas with 6 meter coaxial cables
- Ethernet cable
- Software APIs and example code
- An assortment of Class 1 UHF tags



Figure 3 - ALR-9800 Developer's Kit[d4]

Reader I/O Panel

The I/O panel (shown below) houses the following:

- 14-pin female I/O terminal block
- LAN TCP/IP port
- 9-pin D female RS-232 serial port
- Power connector

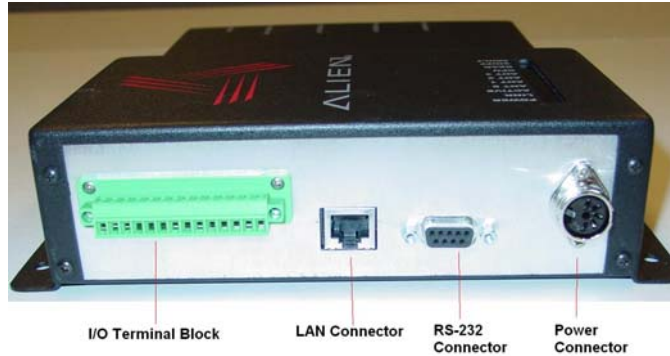

Figure 4 - ALR-9800 Reader Connections

Diagnostic LEDs

The ALR-9800 includes diagnostic LEDs on the face of the reader to provide easy and convenient external indication for various operating conditions:

- **POWER (green)** - indicates power is applied to the reader
- **LINK (green)** – indicates that the reader is connected to the network
- **ACTIVE (green)** – indicates reader is transmitting on the network
- **ANT 0 – ANT 3 (green)** – indicates that the reader is transmitting power on the specified antenna port
- **CPU (green)** – indicates that the CPU has booted successfully and is running normally.
- **READ (green)** – indicates that the reader is receiving data from a tag
- **SNIFF (green)** – indicates a tag signal has been detected, though it may not be strong enough yet to complete a transaction.
- **FAULT (red)** – indicates a fault condition with the reader.

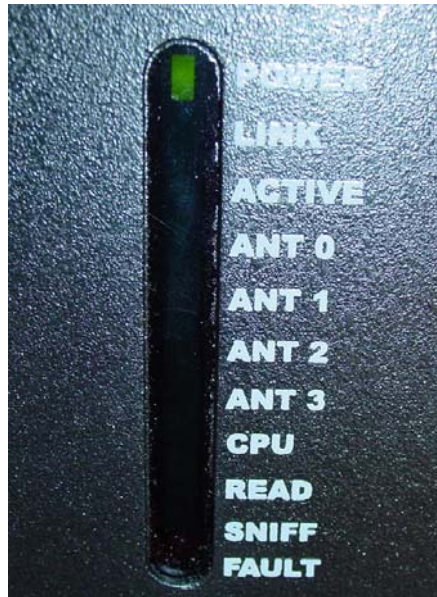

Figure 5 – ALR-9800 Reader Diagnostic LEDs

Antenna Panel

The antenna panel (opposite the reader's I/O panel) contains four coax antenna connector ports as shown below. These are reverse-polarity TNC connectors. Also included on this panel is the Listen Before Talk (LBT) connector which will be available in future models.

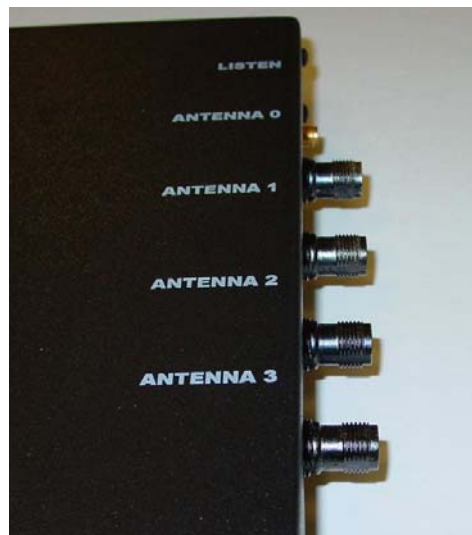

Figure 6 - Antenna Connections

System Assembly and Bench Test

Assembling the RFID Reader system is easy. We recommend you set up the system and verify its operation in a bench test configuration (shown below) before installing it in a production setting.



Figure 7 - Typical Bench Test Setup

Bench Test Configuration

1. **Place the Reader on a tabletop.** Ensure the following conditions:
 - A standard 120 or 220 VAC outlet is nearby.



Figure 8 - RS-232 and Power Connections

- Sufficient space is available on the tabletop for the reader and antenna.
2. **Connect the RS-232 cable to the reader.**
 - Align the male cable connector so that its shape and pins match the shape and holes of the female DB-9 RS-232 port.



Figure 9 - RS-232 Connector

- Push the aligned connector into the port.
 - Finger-tighten the screws to secure the cable/connector to the reader.
- 3. Connect the RS-232 cable to the serial port on the PC.**
- Settings for RS-232 are 115200 Bits per second, 8 data bits, no parity, 1 stop bit, and no flow control.
 - Start up terminal software on the PC, such as HyperTerminal with these settings, and be prepared to observe the reader's messages as it boots up.
 - The RS-232 port serves only as console output for the reader at this time. It displays useful information while the reader boots, including network settings.
- 4. Connect the Ethernet cable to the reader and PC or LAN.**
- You must use TCP/IP to communicate with the reader, so connect a standard ethernet cable from the reader to a nearby LAN drop or network switch.
 - You may alternatively use a cross-over ethernet cable and connect the reader directly to the PC.
 - The reader comes preconfigured to look for a DHCP server to set its network parameters. In the absence of a DHCP server, the reader will use the following settings:
 - IP Address: 192.168.1.100
 - Subnet Mask: 255.255.0.0
 - Gateway: 192.168.1.1
- 5. Connect the power supply to the reader.**
- Using the thin cable attached to power supply, push the connector into the port until it is securely seated. Do not plug the power supply into the wall outlet yet.
 - Finger-tighten the securing ring onto the connector.
- 6. Connect the coaxial cable(s) to antenna ports (in pairs).**
- Antenna port 0 is on the top right-side, if viewing the reader from the front with the flange side down. The ALR-9800 has four (4) antenna

ports. If using the Alien Gateway software, please note that ANT 0 is selected by default when first initialized.

- Antennas must be connected in pairs (one to transmit, one to receive). At this time, the reader pairs antenna 0 with antenna 1, and antenna 2 with antenna 3. This means that when antenna 0 is the active (transmit) antenna, antenna 1 will be the receive antenna, and vice versa. The same pairing applies to antennas 2 and 3.
- Align the coax cable's center pin and push into the port
- Screw the fitting from the cable end onto the reader connector *clockwise* until finger-tight to secure the cable to the reader.

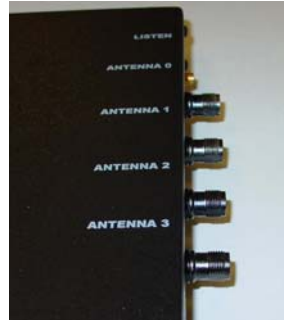

Figure 10 - Antenna Connections

- Connect additional antennas to their respective ports and tighten fittings clockwise until finger-tight.

7. Plug power cord into power supply.

- Use the female end of a standard 3-pronged power cord (a power cord is included with each reader)

8. Plug the power supply cable into the wall outlet and verify power.

- The green POWER LED will illuminate when power is on.

9. Observe the reader's bootup trace, and determine the network settings.

Toward the end of the trace, the reader displays a block of text similar to the following:

```

=====
-----
Network Settings:
  MAC Address : 00:80:66:10:2D:12
  DHCP       : 1
  IP Address  : 10.9.8.10
  Netmask    : 255.255.255.0
  Gateway    : 10.9.8.2
  DNS        : 10.9.8.1
  TimeServer : time-a.timefreq.bldrdoc.gov
  TimeZone   : -7
-----
=====
    
```

10. Ensure the PC has compatible network settings.

- In order for you to be able to connect to the reader over TCP/IP, the host PC must be on the same subnet as the reader. If you are unfamiliar with how to do this, consult your local IT service for assistance.
- Once the initial connection is made, you may configure your reader's network settings as you choose. Refer to the *Reader Interface Guide* for instructions on how to do this.

You are now ready to bench test or demonstrate the RFID Reader system.

Bench Test Procedure

- 1. Access an operational mode suitable for bench testing.**
 - Select a mode that will allow multiple consecutive reads of a single tag, such as Global Scroll if using the Alien Gateway software.
 - Refer to the applicable software application user guide for specific instructions.
- 2. Position the reader so you can see the diagnostic LEDs.**
 - You may also want to position the PC so you can view the monitor simultaneously for later tests.
- 3. Move a tag slowly away from the antenna's range.**
 - Begin with the tag well inside the expected read range (~2m or 6 ft) and move it toward the antenna while observing the LEDs.
- 4. Verify the SNIFF LED illuminates when the tag approaches the read window.**
 - SNIFF should be illuminated green.
- 5. Verify the READ LED illuminates when the tag is inside the read window.**
 - READ should be illuminated green.
- 6. Verify the host receives the tag data.**
 - Refer to indications specified in applicable user guide to verify the tag was read successfully.
- 7. If bench test conditions are verified, proceed to installation.**

NOTE: To perform a hard reboot of the system, simply cycle power on the reader.

Installation

This section provides guidance for configuring components in your RFID system. You should consider the overall design of your specific system before permanently mounting the equipment.

Installation involves all the same connection steps required for bench test. However, instead of placing equipment on a tabletop, the reader, antenna, and their accessories are mounted in your application environment.

Requirements

Before installing your RFID Reader system, you will need the following:

- A PC running Windows 98 or higher, with Ethernet connectivity and, optionally, one available RS-232 serial port.
- Standard 120 or 220 VAC power for the reader
- Host software (Gateway, for example)
- (Optional) extra antennas (if desired for additional coverage or configurations)
- Additional RS-232 cables or antenna coax cables needed to accommodate routing requirements
- Standard grounded, three-pronged power cord of desired length
- Mounting hardware suitable for the surface to which equipment is to be attached (e.g., wood screws, moly-bolts, brackets, etc.)



Figure 21 - View of the Reader showing mounting holes

Hardware Installation Procedure

1. Select mounting position for antenna(s).^[d9]

CAUTION: Reader antennas should be positioned so that personnel in the area for prolonged periods may safely remain at least 23 cm (9 in) in an uncontrolled environment from the antenna's surface. See FCC OET Bulletin 56 "Hazards of radio frequency and electromagnetic fields" and Bulletin 65 "Human exposure to radio frequency electromagnetic fields."

- Mount the antennas at the periphery of the desired read window (either overhead or at the side), so that the position of the most distant tag passing through the window is no farther from the antenna than the maximum range specified for your system design.
- Position the antennas at a height approximately midway between the highest and lowest expected tag position. (For example, a pallet tag may be the lowest tag position to be read, while the top-most case on a fully stacked pallet may represent your highest tag position.)

- Mount the second antenna approximately 18 inches from the first antenna, facing the read zone, unless otherwise indicated in your system design specification.
 - **NOTE:** To maintain compliance with FCC regulations, use only antennas supplied with the unit.
2. **Select mounting position for reader.**
 - Reader should be positioned close enough to the antenna to accommodate the cable length without putting strain on the connectors.
 - Be sure power is available at the selected reader location.
 3. **Install reader.**
 - Secure the reader through the two mounting holes on either flange to its mounting location (wall, post, mounting bracket) using appropriate hardware.
 - If desired, position the reader so that the LEDs are easily observed.
 4. **Install antennas.**
 - Secure each antenna through the mounting holes on either flange to its mounting location using appropriate hardware.
 5. **Connect antennas to reader.**
 - Route coax cables from the antennas to the reader according to your system design specifications and secure them properly.
 - Align the connector for each cable with the reader antenna port, push into the port, and finger-tighten the screw fitting.
 6. **Connect reader power.**
 - Push the power supply connector into the reader port and tighten the retaining ring finger tight.
 - Plug the female end of the power cord into the power supply.
 - Plug the male end of the power cord into the 120 VAC outlet.
 7. **Connect reader to the LAN or host PC.**
 - Align the RJ-45 connector with the corresponding TCP/IP port on the reader and push the connector in. Connect to the other end to a LAN drop or network switch. You may optionally connect the reader directly to a PC's network port, but you must use an Ethernet cross-over cable in this situation.
 - If you wish to observe the reader's bootup trace, align and connect a DB-9 serial cable to the reader's RS-232 port, and to the serial port on the PC. Configure your terminal software as described previously in the Bench Test Configuration topic.

9. You are now ready to use the reader. If using the Alien Gateway software, please refer to the *Demonstration Software Guide* included on your CD.

System Operation: Software Control

The ALR-9800 RFID Reader is controlled from software running on a host system that communicates with the reader using the ASCII-based Alien Reader Protocol. All applications use this protocol to communicate with the reader.

You may operate the reader from your own application code, using the example code provided on the Developer's Kit CD, or using the Alien RFID Gateway application which is a demonstration program also included on your CD.

For more details, refer to either the *Reader Interface Guide* or the *Demonstration Software Guide* described briefly below.

Reader Interface Guide

The Alien Reader Protocol, mentioned previously, is described in detail in the *Reader Interface Guide*. Using this interface, the reader can be configured to read tags when queried or after one of a variety of event triggers (e.g., a rising edge on one of the I/O pins, or a timer).

Tag data acquired in response to these triggers can be transmitted to the host in a number of formats (e.g., text, XML or custom) and under a number of conditions (e.g., on a new tag being observed, or a tag disappearing from view).

If you are a software developer, the *Reader Interface Guide* provides the information you will need to connect to the reader from a host computer, communicate with it, and customize its performance.

Demonstration Software Guide

The *Demo Software Guide* describes the installation and operation of the Alien RFID Gateway application.

The Alien RFID Gateway application is a useful demonstration program that allows users to explore the reader's functionality and build customizable demos with a user-friendly interface.

Using the Gateway, the various operating modes of the reader can be controlled and custom interactive demos can be constructed using sounds, images, and text.

Alien RFID Academy^[d10]

Need to absorb RFID systems fast? Enroll in the Alien RFID Academy. In three days we'll share our practical expertise in RFID Tags, Antennas, Readers, Frequencies, Systems, and Protocols.

The Alien RFID Academy is a hands-on immersion into the workings, uses, and challenges of RFID technology. Rather than a product pitch, we put products to the test in the classroom, provide students with hands-on exposure in our RFID Solutions Center, and short-cut the learning curve by sharing practical solutions

to real-world challenges. You'll learn best industry practice tag placement techniques for packaging and pallets alike.

Upon completion of the training, you will learn how to implement, avoid common costly mistakes, know how to make the correct decisions for your business, how to select the right RFID options for your requirements, and where to find RFID answers.

Alien RFID Intermediate / Advanced Academy Topics:

- RFID Physics, Protocols & Practical Applications
- Tag Placement & Packaging Considerations
- RFID Reader/System Configuration & Optimization
- Hands-on Implementation
- RFID System Architecture and Integration
- Conducting Site-surveys & Contending with Interference

Please visit <http://www.alientechnology.com/academy> for more information.