



SAR TEST REPORT

Report No.: SET2016-11240
Product: Connected Handheld RFID Reader
Brand Name: ALIEN
Model No.: ALR-H450
FCC ID: P65ALR-H450B
IC: 4370A-ALRH450B
Applicant: Alien Technology, LLC
Address: 845 Embedded Way, San Jose, CA 95138-1030, United States
Issued by: CCIC-SET
Lab Location: Electronic Testing Building, Shahe Road, Xili, Nanshan District, Shenzhen, 518055, P. R. China
Tel: 86 755 26627338 **Fax:** 86 755 26627238
Mail: manager@ccic-set.com **Website:** <http://www.ccic-set.com>

This test report consists of **150** pages in total. It may be duplicated completely for legal use with the approval of the applicant. It should not be reproduced except in full, without the written approval of our laboratory. The client should not use it to claim product endorsement by CCIC-SET. The test results in the report only apply to the tested sample. The test report shall be invalid without all the signatures of testing engineers, reviewer and approver. Any objections must be raised to CCIC-SET within 15 days since the date when the report is received. It will not be taken into consideration beyond this limit.



Test Report

Product: Connected Handheld RFID Reader
Model No.: ALR-H450
Brand Name.....: ALIEN
FCC ID.....: P65ALR-H450B
IC.....: 4370A-ALRH450B
Applicant.....: Alien Technology, LLC
Applicant Address.....: 845 Embedded Way, San Jose, CA 95138-1030, United States
Manufacturer.....: Alien Technology, LLC
Manufacturer Address: 845 Embedded Way, San Jose, CA 95138-1030, United States

Test Standards.....: **RSS-102:** Radio Frequency Exposure Compliance of Radio communication Apparatus (All Frequency Bands)(Issue 5 of March 2015)
47CFR § 2.1093- Radiofrequency Radiation Exposure Evaluation: Portable Devices;
IEEE 1528–2013: IEEE Recommended Practice for Determining the Peak Spatial-Average Specific Absorption Rate (SAR) in the Human Head from Wireless Communications Devices: Measurement Techniques
IEC 62209-2: 2010 - Human exposure to radio frequency fields from hand-held and body-mounted wireless communication devices Human models, instrumentation, and procedures Part 2: Procedure to determine the specific absorption rate(SAR) for wireless communication devices used

Test Result.....: Pass

Tested by: Mei Chun 2016-08-26
 Chun Mei, Test Engineer

Reviewed by.....: Shuangwen Zhang 2016-08-26
 Shuangwen Zhang, Senior Engineer

Approved by.....: Wu Lian 2016-08-26
 Wu Li'an , Manager



Contents

- 1. **GENERAL CONDITIONS**-----4
- 2. **ADMINISTRATIVE DATA**-----5
 - 2.1. Identification of the Responsible Testing Laboratory-----5
 - 2.2. Identification of the Responsible Testing Location(s)-----5
 - 2.3. Organization Item-----5
 - 2.4. Identification of Applicant-----5
 - 2.5. Identification of Manufacture-----5
- 3. **EQUIPMENT UNDER TEST (EUT)**-----6
- 4. **SAR SUMMAY**-----7
- 5. **Specific Absorption Rate(SAR)**-----8
 - 5.1. Introduction-----8
 - 5.2. SAR Definition-----8
 - 5.3. Phantoms-----9
 - 5.4. Device Holder-----9
 - 5.5. Probe Specification-----10
- 6. **OPERATIONAL CONDITIONS DURING TEST**-----11
 - 6.1. Schematic Test Configuration-----12
 - 6.2. SAR Measurement System-----12
 - 6.3. Equipments and results of validation testing-----13
 - 6.4. SAR measurement procedure-----16
 - 6.5. Antennas position and test position-----18
- 7. **CHARACTERISTICS OF THE TEST**-----18
 - 7.1. Applicable Limit Regulations-----18
 - 7.2. Applicable Measurement Standards-----18
- 8. **LABORATORY ENVIRONMENT**-----19
- 9. **CONDUCTED RF OUTPUT POWER**-----19
- 10. **TEST RESULTS**-----27
- 11. **MEASUREMENT UNCERTAINTY**-----31
- 12. **MAIN TEST INSTRUMENTS**-----34

This Test Report consists of the following Annexes:

Annex A: Test Layout -----	35
Annex B: Sample Photographs -----	42
Annex C: System Performance Check Data and Highest SAR Plots -----	44
Annex D: Calibration Certificate of Probe and Dipoles -----	75



1. GENERAL CONDITIONS

1.1 This report only refers to the item that has undergone the test.

1.2 This report standalone does not constitute or imply by its own an approval of the product by the certification Bodies or competent Authorities.

1.3 This document is only valid if complete; no partial reproduction can be made without written approval of CCIC-SET

1.4 This report cannot be used partially or in full for publicity and/or promotional purposes without previous written approval of CCIC-SET and the Accreditation Bodies, if it applies.



2. Administrative Date

2.1. Identification of the Responsible Testing Laboratory

Company Name: CCIC-SET

Department: EMC & RF Department

Address: Electronic Testing Building, Shahe Road, Nanshan District,
ShenZhen, P. R. China

Telephone: +86-755-26629676

Fax: +86-755-26627238

**Responsible Test Lab
Managers:** Mr. Wu Li'an

2.2. Identification of the Responsible Testing Location(s)

Company Name: CCIC-SET

Address: Electronic Testing Building, Shahe Road, Nanshan District,
Shenzhen, P. R. China

2.3. Organization Item

CCIC-SET Report No.: SET2016-11240

CCIC-SET Project Leader: Mr. Li Sixiong

**CCIC-SET Responsible
for accreditation scope:** Mr. Wu Li'an

Start of Testing: 2016-06-28

End of Testing: 2016-08-26

2.4. Identification of Applicant

Company Name: Alien Technology, LLC

Address: 845 Embedded Way, San Jose, CA 95138-1030, United
States

2.5. Identification of Manufacture

Company Name: Alien Technology, LLC

Address: 845 Embedded Way, San Jose, CA 95138-1030, United
States

Notes: This data is based on the information by the applicant.

3. Equipment Under Test (EUT)

3.1. Identification of the Equipment under Test

Sample Name: Connected Handheld RFID Reader

Type Name: ALR-H450

Brand Name: ALIEN

General description:	Support Band	GSM850MHz/1900MHz/900MHz/1800MHz WCDMA 850MHz/1900MHz, WIFI, BT,RFID
	Test Band	GSM 850MHz/ GSM 1900MHz, GPRS 850MHz/ GPRS 1900MHz, WCDMA 850MHz/ WCDMA 1900MHz, WIFI 802.11b,RFID
	Multislot Class	GPRS: Class 12 ; EDGE: Class 12
	GPRS Class	Class B
	Development Stage	Identical Prototype
	Accessories	Power Supply
	Battery type	3.7V 3200mAh
	Antenna type	Inner Antenna
	Operation mode	GSM / GPRS /WCDMA /WIFI/RFID
	Modulation mode	GSM(GMSK),UMTS(QPSK), WIFI(OFDM/DSSS),RFID(PR-ASK)
	Max. RF Power	32.47dBm
	Max. SAR Value	Head: 0.259 W/kg; Body: 1.099 W/kg; Hotspot: 1.099 W/kg

NOTE:

- a. The above EUT's information was declared by manufacturer. Please refer to the specifications or user's manual for more detailed description.
- b. This device supports GPRS operation up to class12 (max.uplin:4, max.downlink:4, total timeslots:5). This device supports EDGE operation up to class12(max.uplin:4, max.downlink:4, total timeslots:5)



4 SAR SUMMARY

Highest Standalone SAR Summary

Exposure Position	Frequency Band	Scaled 1g-SAR(W/kg)	Highest Scaled 1g-SAR(W/kg)
Head	GSM850	0.137	0.259
	GSM1900	0.069	
	WCDMA Band V	0.149	
	WCDMA Band II	0.139	
	WIFI	0.259	
Body-worn Accessory (10mm Gap)	GSM850	0.772	1.099
	GSM1900	0.737	
	WCDMA Band V	0.694	
	WCDMA Band II	1.099	
	WIFI	0.280	
	RFID	0.707	
Hotspot (10mm Gap)	GSM850	0.772	1.099
	GSM1900	0.737	
	WCDMA Band V	0.694	
	WCDMA Band II	1.099	
	WIFI	0.296	

Highest Simultaneous SAR Summary

Exposure Position	Frequency Band	Scaled 1g-SAR(W/kg)	Highest Scaled 1g-SAR(W/kg)
Head	GSM850&WIFI	0.137+0.259	0.408
	GSM1900&WIFI	0.069+0.259	
	WCDMA Band V &WIFI	0.149+0.259	
	WCDMA Band II &WIFI	0.139+0.259	
Body-worn Accessory (10mm Gap)	GSM850&WIFI	0.772+0.296	1.395
	GSM1900&WIFI	0.737+0.296	
	WCDMA Band V &WIFI	0.694+0.296	
	WCDMA Band II &WIFI	1.099+0.296	
Hotspot (10mm Gap)	GSM850&WIFI	0.772+0.296	1.395
	GSM1900&WIFI	0.737+0.296	
	WCDMA Band V &WIFI	0.694+0.296	
	WCDMA Band II &WIFI	1.099+0.296	

Note: RFID is “NOT” used in conjunction with other transmitters.

5 Specific Absorption Rate (SAR)

5.1 Introduction

SAR is related to the rate at which energy is absorbed per unit mass in an object exposed to a radio field. The SAR distribution in a biological body is complicated and is usually carried out by experimental techniques or numerical modeling. The standard recommends limits for two tiers of groups, occupational/controlled and general population/uncontrolled, based on a person's awareness and ability to exercise control over his or her exposure. In general, occupational/controlled exposure limits are higher than the limits for general population/uncontrolled.

5.2 SAR Definition

The SAR definition is the time derivative (rate) of the incremental energy (dW) absorbed by (dissipated in) an incremental mass (dm) contained in a volume element (dv) of a given density (ρ). The equation description is as below:

$$\text{SAR} = \frac{d}{dt} \left(\frac{dW}{dm} \right) = \frac{d}{dt} \left(\frac{dW}{\rho dv} \right)$$

SAR is expressed in units of Watts per kilogram (W/kg)

SAR measurement can be either related to the temperature elevation in tissue by

$$\text{SAR} = C \frac{\delta T}{\delta t}$$

where C is the specific heat capacity, δT is the temperature rise and δt the exposure duration, or related to the electrical field in the tissue by

$$\text{SAR} = \frac{\sigma |E|^2}{\rho}$$

where σ is the conductivity of the tissue, ρ is the mass density of the tissue and E is the rms electrical field strength.

However for evaluating SAR of low power transmitter, electrical field measurement is typically applied.

5.3 Phantoms

The phantom used for all tests i.e. for both system checks and device testing, was the twin-headed "SAM Phantom", manufactured by SATIMO. The SAM twin phantom is a fiberglass shell phantom with 2mm shell thickness (except the ear region, where shell thickness increases to 6mm).

System checking was performed using the flat section, whilst Head SAR tests used the left and right head profile sections. Body SAR testing also used the flat section between the head profiles.



SAM Twin Phantom

5.4 Device Holder

The device was placed in the device holder (illustrated below) that is supplied by SATIMO as an integral part of the COMOSAR test system.

The device holder is designed to cope with the different positions given in the standard. It has two scales for device rotation (with respect to the body axis) and device inclination (with respect to the line between the ear reference points). The rotation centers for both scales is the ear reference point (ERP). Thus the device needs no repositioning when changing the angles.

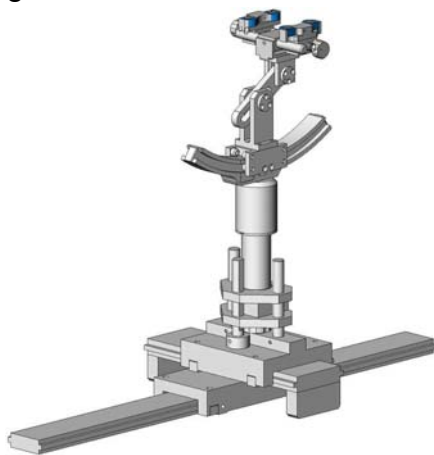

Device holder

5.5 Probe Specification



Construction	Symmetrical design with triangular core Interleaved sensors Built-in shielding against static charges PEEK enclosure material (resistant to organic solvents, e.g., DGBE)
Calibration	ISO/IEC 17025 calibration service available.
Frequency	700 MHz to 3 GHz; Linearity: ± 0.5 dB (700 MHz to 3 GHz)
Directivity	± 0.25 dB in HSL (rotation around probe axis) ± 0.5 dB in tissue material (rotation normal to probe axis)
Dynamic Range	1.5 μ W/g to 100 mW/g; Linearity: ± 0.5 dB
Dimensions	Overall length: 330 mm (Tip: 20 mm) Tip diameter: 5 mm Distance from probe tip to dipole centers: <2.7 mm
Application	General dosimetry up to 3 GHz Dosimetry in strong gradient fields Compliance tests of mobile phones
Compatibility	COMOSAR

Isotropic E-Field Probe

The isotropic E-Field probe has been fully calibrated and assessed for isotropicity, and boundary effect within a controlled environment. Depending on the frequency for which the probe is calibrated the method utilized for calibration will change.

The E-Field probe utilizes a triangular sensor arrangement as detailed in the diagram below:

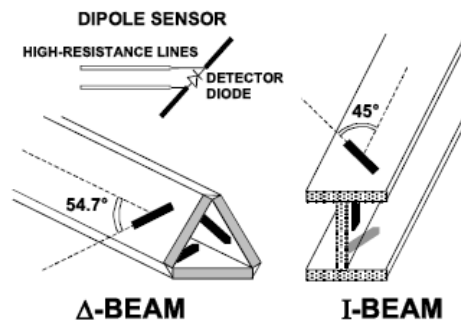

6 OPERATIONAL CONDITIONS DURING TEST

6.1 Schematic Test Configuration

During SAR test, EUT was operating in Traffic Mode (Channel Allocated) at Normal Voltage Condition. A communication link is set up with a System Simulator (SS) by air link, and a call is established. The EUT was commanded to operate at maximum transmitting power.

The EUT should use its internal transmitter. The antenna(s), battery and accessories shall be those specified by the manufacturer. The EUT battery must be fully charged and checked periodically during the test to ascertain uniform power output. If a wireless link was used, the antenna connected to the output of the base station simulator shall be placed at least 50 cm away from the handset.

The signal transmitted by the simulator to the antenna feeding point should be lower than the output power level of the handset by at least 35 dB

6.2 SAR Measurement System

The SAR measurement system being used is the SATIMO system, the system is controlled remotely from a PC, which contains the software to control the robot and data acquisition equipment. The software also displays the data obtained from test scans.

In operation, the system first does an area (2D) scan at a fixed depth within the liquid from the inside wall of the phantom. When the maximum SAR point has been found, the system will then carry out a 3D scan centred at that point to determine volume averaged SAR level.

6.2.1 Tissue Dielectric Parameters for Head and Body Phantoms

The head tissue dielectric parameters recommended by the IEEE SCC-34/SC-2 in P1528 have been incorporated in the following table. These head parameters are derived from planar layer models simulating the highest expected SAR for the dielectric properties and tissue thickness Power drifts in a human head. Other head and body tissue parameters that have not been specified in P1528 are derived from the tissue dielectric parameters computed from the 4-Cole-Cole equations described in Reference [12] and extrapolated according to the head parameters specified in P1528.

Table 1: Recommended Dielectric Performance of Tissue

Ingredients (% by weight)	Frequency (MHz)									
	450		835		915		1900		2450	
Tissue Type	Head	Body	Head	Body	Head	Body	Head	Body	Head	Body
Water	38.56	51.16	41.46	52.4	41.05	56.0	54.9	40.4	62.7	73.2
Salt (Nacl)	3.95	1.49	1.45	1.4	1.35	0.76	0.18	0.5	0.5	0.04

Sugar	56.32	46.78	56.0	45.0	56.5	41.76	0.0	58.0	0.0	0.0
HEC	0.98	0.52	1.0	1.0	1.0	1.21	0.0	1.0	0.0	0.0
Bactericide	0.19	0.05	0.1	0.1	0.1	0.27	0.0	0.1	0.0	0.0
Triton x-100	0.0	0.0	0.0	0.0	0.0	0.0	0.0	0.0	36.8	0.0
DGBE	0.0	0.0	0.0	0.0	0.0	0.0	44.92	0.0	0.0	26.7
Dielectric Constant	43.42	58.0	42.54	56.1	42.0	56.8	39.9	54.0	39.8	52.5
Conductivity (s/m)	0.85	0.83	0.91	0.95	1.0	1.07	1.42	1.45	1.88	1.78

Table 2 Recommended Tissue Dielectric Parameters

Frequency (MHz)	Head Tissue		Body Tissue	
	ϵ_r	σ (S/m)	ϵ_r	σ (S/m)
150	52.3	0.76	61.9	0.80
300	45.3	0.87	58.2	0.92
450	43.5	0.87	56.7	0.94
835	41.5	0.90	55.2	0.97
900	41.5	0.97	55.0	1.05
915	41.5	0.98	55.0	1.06
1450	40.5	1.20	54.0	1.30
1610	40.3	1.29	53.8	1.40
1800-2000	40.0	1.40	53.3	1.52
2450	39.2	1.80	52.7	1.95
3000	38.5	2.40	52.0	2.73
5800	35.3	5.27	48.2	6.00

6.2.2 Stimulant liquids

For measurements against the phantom head, the “cheek” and “tilt” position on both the left hand and the right hand sides of the phantom. For body-worn measurements, the EUT was tested against flat phantom representing the user body. The EUT was put on in the belt holder. Stimulant liquids that are used for testing at frequencies of GSM 850MHz/1900MHz, WCDMA850MHz/1900MHz, Wi-Fi 2.4GHz, which are made mainly of sugar, salt and water solutions may be left in the phantoms.



Table 3: Dielectric Performance of Head Tissue Simulating Liquid

Temperature: 22.0-22.6°C					
Tissue Type (Head Liquid)	Measured Frequency(MHz)	Target Tissue		Measured Tissue	
		Permittivity ϵ	Conductivity σ (S/m)	Permittivity ϵ	Conductivity σ (S/m)
835 (June.28th, 2016)	825	41.5 ± 5%	0.90 ± 5%	41.30	0.88
	835	41.5 ± 5%	0.90 ± 5%	41.32	0.88
	848	41.5 ± 5%	0.90 ± 5%	41.34	0.89
1900 (June.29th, 2016)	1850	40.0 ± 5%	1.40 ± 5%	39.81	1.39
	1880	40.0 ± 5%	1.40 ± 5%	39.82	1.39
	1900	40.0 ± 5%	1.40 ± 5%	39.84	1.39
	1910	40.0 ± 5%	1.40 ± 5%	39.85	1.39
2450 (June.29th, 2016)	2412	39.2 ± 5%	1.80 ± 5%	38.88	1.80
	2437	39.2 ± 5%	1.80 ± 5%	38.92	1.80
	2462	39.2 ± 5%	1.80 ± 5%	38.94	1.80
	2450	39.2 ± 5%	1.80 ± 5%	38.96	1.80

Table 4: Dielectric Performance of Body Tissue Simulating Liquid

Temperature: 22.0-22.6°C					
Tissue Type (Body Liquid)	Measured Frequency(MHz)	Target Tissue		Measured Tissue	
		Permittivity ϵ	Conductivity σ (S/m)	Permittivity ϵ	Conductivity σ (S/m)
835 (June.28th, 2016)	825	55.2 ± 5%	0.97 ± 5%	54.80	0.95
	835	55.2 ± 5%	0.97 ± 5%	54.82	0.95
	850	55.2 ± 5%	0.97 ± 5%	54.82	0.96
1900 (June.29th, 2016)	1850	53.3 ± 5%	1.52 ± 5%	52.84	1.50
	1880	53.3 ± 5%	1.52 ± 5%	52.85	1.50
	1900	53.3 ± 5%	1.52 ± 5%	52.87	1.50
	1910	53.3 ± 5%	1.52 ± 5%	52.88	1.50
2450 (June.29th, 2016)	2412	52.7 ± 5%	1.95 ± 5%	52.44	1.94
	2437	52.7 ± 5%	1.95 ± 5%	52.45	1.94
	2462	52.7 ± 5%	1.95 ± 5%	52.46	1.94
	2450	52.7 ± 5%	1.95 ± 5%	52.47	1.94
900 (Aug. 19th, 2016)	900	55.5 ± 5%	1.05 ± 5%	55.21	1.04
	910	55.5 ± 5%	1.05 ± 5%	55.23	1.04
	920	55.5 ± 5%	1.05 ± 5%	55.26	1.04
	930	55.5 ± 5%	1.05 ± 5%	55.27	1.04

6.3 Results of validation testing

Prior to the assessment, the system validation kit was used to test whether the system was operating within its specifications of $\pm 10\%$. The validation results are tabulated below. And also the corresponding SAR plot is attached as well in the SAR plots files.

The following procedure, recommended for performing validation tests using box phantoms is based on the procedures described in the IEEE standard P1528. Setup according to the setup diagram below :

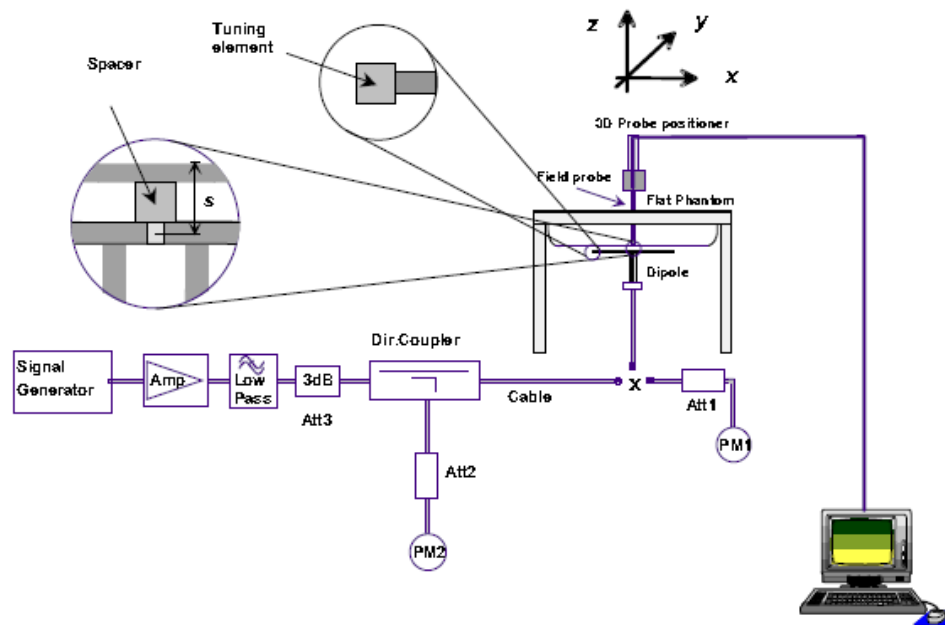

With the SG and Amp and with directional coupler in place, set up the source signal at the relevant frequency and use a power meter to measure the power at the end of the SMA cable that you intend to connect to the balanced dipole. Adjust the SG to make this, say, 0.25W (24 dBm). If this level is too high to read directly with the power meter sensor, insert a calibrated attenuator (e.g. 10 or 20 dB) and make a suitable correction to the power meter reading.

Note 1: In this method, the directional coupler is used for monitoring rather than setting the exact feed power level. If, however, the directional coupler is used for power measurement, you should check the frequency range and power rating of the coupler and measure the coupling factor (referred to output) at the test frequency using a VNA.

Note 2: Remember that the use of a 3dB attenuator (as shown in Figure 8.1 of P1528) means that you need an RF amplifier of 2 times greater power for the same feed power. The other issue is the cable length. You might get up to 1dB of loss per meter of cable, so the cable length after the coupler needs to be quite short.

Note 3: For the validation testing done using CW signals, most power meters are suitable. However, if you are measuring the output of a modulated signal from either a signal generator or a handset, you must ensure that the power meter correctly reads the modulated signals.

The measured 1-gram averaged SAR values of the device against the phantom are

provided in Tables 5 and Table 6. The humidity and ambient temperature of test facility were 64% and 23.2°C respectively. The body phantom were full of the body tissue simulating liquid. The EUT was supplied with full-charged battery for each measurement.

The distance between the back of the EUT and the bottom of the flat phantom is 10 mm (taking into account of the IEEE 1528 and the place of the antenna).

Table 5: Head SAR system validation (1g)

Frequency	Duty cycle	Target value (W/kg)	Test value (W/kg)	
			250 mW	1W
850MHz(June. 28th, 2016)	1:1	9.77 ± 10%	2.41	9.64
1900MHz(June. 29th, 2016)	1:1	40.37 ± 10%	9.87	39.48
2450MHz(June. 29th, 2016)	1:1	53.60 ± 10%	13.18	52.72

Table 6: Body SAR system validation (1g)

Frequency	Duty cycle	Target value (W/kg)	Test value (W/kg)	
			250 mW	1W
850MHz(June. 28th, 2016)	1:1	10.31 ± 10%	2.54	10.16
1900MHz(June. 29th, 2016)	1:1	40.81 ± 10%	10.13	40.52
2450MHz(June. 29th, 2016)	1:1	52.66 ± 10%	13.07	52.28
900MHz(Aug. 19th, 2016)	1:1	11.48 ± 10%	2.76	11.04

* Note: Target value was referring to the measured value in the calibration certificate of reference dipole.
Note: All SAR values are normalized to 1W forward power.

6.4 SAR measurement procedure

The SAR test against the head phantom was carried out as follow:

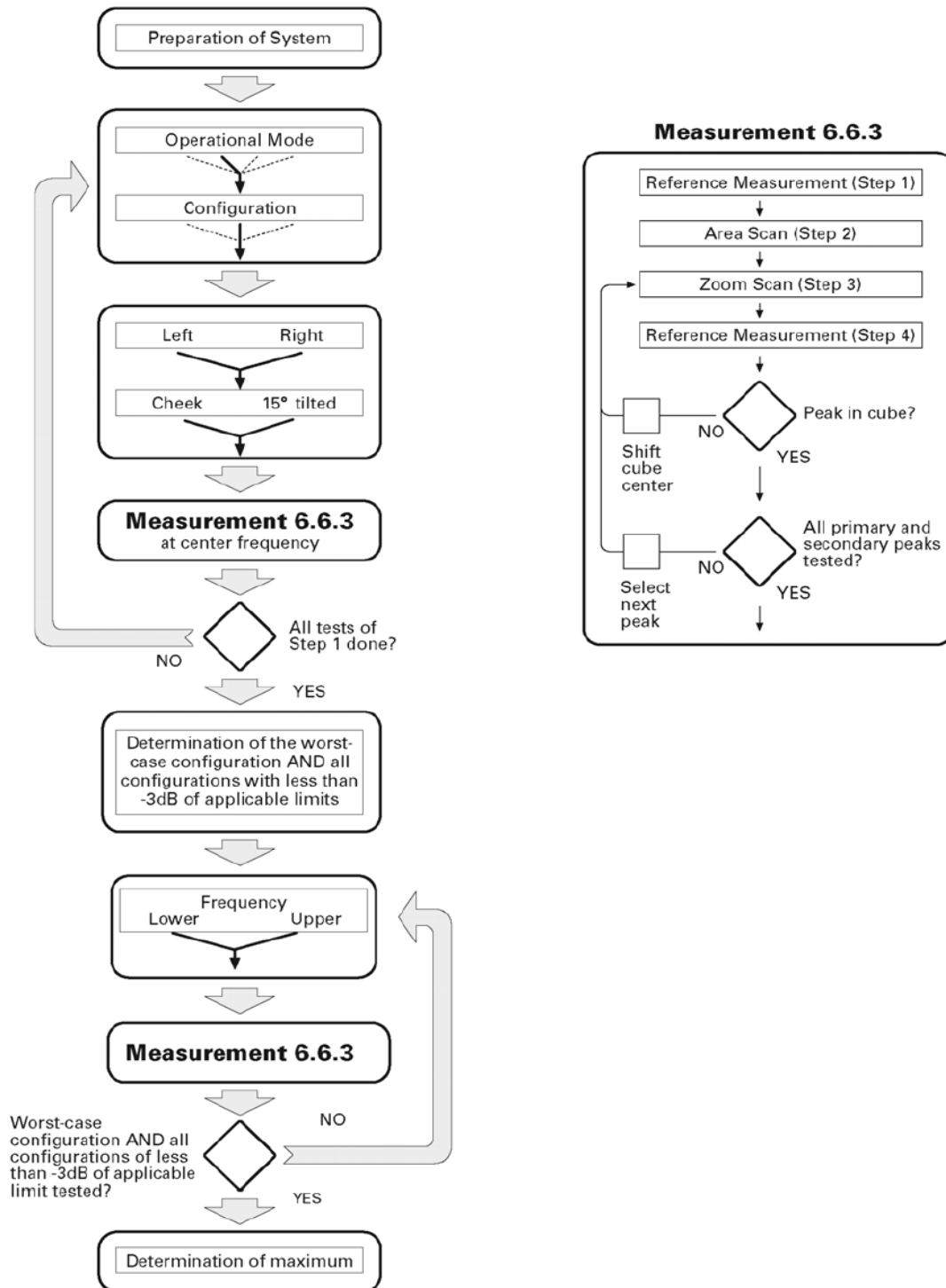

Establish a call with the maximum output power with a base station simulator, the connection between the EUT and the base station simulator is established via air interface.

After an area scan has been done at a fixed distance of 2mm from the surface of the phantom on the source side, a 3D scan is set up around the location of the maximum spot SAR. First, a point within the scan area is visited by the probe and a SAR reading taken at the start of testing. At the end of testing, the probe is returned to the same point and a

second reading is taken. Comparison between these start and end readings enables the power drift during measurement to be assessed.

Above is the scanning procedure flow chart and table from the IEEE p1528 standard. This is the procedure for which all compliant testing should be carried out to ensure that all variations of the device position and transmission behavior are tested.

For body-worn measurement, the EUT was tested under two positions: face upward and back upward.

6.5 Transmitting antenna information

The GSM&WCDMA&WIFI&BT&GPS antennas inside the EUT.



Fig. 3 Position of the antennas



The Body SAR measurement positions of each band are as below:

Antenna	Front	Back	Edge A	Edge B	Edge C	Edge D
2G /3G Antenna Body-worn	Yes	Yes	No	No	No	No
2G /3G Antenna hotspot	Yes	Yes	No	No	Yes	Yes
WIFI Antenna Body-worn	Yes	Yes	No	No	No	No
WIFI Antenna hotspot	Yes	Yes	Yes	No	No	Yes
RFID Antenna Body-support	Yes	Yes	Yes	No	Yes	Yes

Note: According to KDB941225 antenna-to-edge>2.5cm, SAR is not required.



7 CHARACTERISTICS OF THE TEST

7.1 Applicable Limit Regulations

47CFR § 2.1093- Radiofrequency Radiation Exposure Evaluation: Portable Devices;

RSS-102: Radio Frequency Exposure Compliance of Radio communication Apparatus (All Frequency Bands)(Issue 5 of March 2015)

IEEE 1528–2013: IEEE Recommended Practice for Determining the Peak Spatial-Average Specific Absorption Rate (SAR) in the Human Body Due to Wireless Communications Devices: Experimental Techniques;

It specifies the maximum exposure limit of **1.6 W/kg** as averaged over any 1 gram of tissue for portable devices being used within 20 cm of the user in the uncontrolled environment.

7.2 Applicable Measurement Standards

The Specific Absorption Rate (SAR) testing specification, method, and procedure for this is in accordance with the following standards:

IEC 62209-2:2010

IEEE 1528-2013

FCC KDB 248227 D01 802.11 Wi-Fi SAR v02r02

FCC KDB 447498 D01 v06 General RF Exposure Guidance

FCC KDB 648474 D04 v01r03 Handset SAR

FCC KDB 865664 D01 v01r04 SAR Measurement 100MHz to 6GHz

FCC KDB 865664 D02 v01r02 SAR Exposure Reporting

FCC KDB 941225 D01 v03r01 3G SAR Procedures

FCC KDB 941225 D06 v02r01 Hotspot Mode

8 LABORATORY ENVIRONMENT

The Ambient Conditions during SAR Test

Temperature	Min. = 22 ° C, Max. = 25 ° C
Atmospheric pressure	Min.=86 kPa, Max.=106 kPa
Relative humidity	Min. = 45%, Max. = 75%
Ground system resistance	< 0.5 Ω

Ambient noise is checked and found very low and in compliance with requirement of standards. Reflection of surrounding objects is minimized and in compliance with requirement of standards.

9. Conducted RF Output Power

9.1 GSM Conducted Power

Band	TX Channel	Burst Average Power (dBm)			Frame-Average Power (dBm)		
		128	190	251	128	190	251
GSM850	Frequency(MHz)	824.2	836.4	848.8	824.2	836.4	848.8
	GSM	32.38	32.46	32.47	23.35	23.43	23.44
	GPRS (Slot 1)	32.13	32.16	32.21	23.1	23.13	23.18
	GPRS (Slot 2)	29.96	29.87	29.93	23.94	23.85	23.91
	GPRS (Slot 3)	27.81	27.78	27.85	23.55	23.52	23.59
	GPRS (Slot 4)	25.95	25.91	25.97	22.94	22.9	22.96
	EDGE (Slot 1)	31.83	31.92	31.97	22.8	22.89	22.94
	EDGE (Slot 2)	29.24	29.17	29.22	23.22	23.15	23.2
	EDGE (Slot 3)	27.21	27.30	27.18	22.95	23.04	22.92
	EDGE (Slot 4)	24.86	24.91	24.85	21.85	21.9	21.84
	GSM1900	TX Channel	512	661	810	512	661
Frequency(MHz)		1850.2	1880	1909.8	1850.2	1880	1909.8
GSM		28.84	28.83	28.86	19.81	19.8	19.83
GPRS (Slot 1)		28.63	28.62	28.59	19.6	19.59	19.56
GPRS (Slot 2)		26.95	26.89	26.94	20.93	20.87	20.92
GPRS (Slot 3)		25.49	25.37	25.32	21.23	21.11	21.06
GPRS (Slot 4)		23.84	23.88	23.91	20.83	20.87	20.9
EDGE (Slot 1)		28.25	28.22	28.34	19.22	19.19	19.31



EDGE (Slot 2)	26.75	26.67	26.71	20.73	20.65	20.69
EDGE (Slot 3)	24.82	24.89	24.92	20.56	20.63	20.66
EDGE (Slot 4)	23.27	23.31	23.35	20.26	20.3	20.34

Note: Per KDB 447498 D01 v06, the maximum output power channel is used for SAR testing and for further SAR test reduction.

For Head SAR testing, GSM should be evaluated, therefore the EUT was set in GSM Voice for GSM850 and GSM1900 due to its highest frame-average power.

For Body worn SAR testing, GSM should be evaluated, therefore the EUT was set in GSM Voice for GSM850 and GSM 1900 due to its highest frame-average power.

For hotspot mode SAR testing, GPRS and EDGE should be evaluated, therefore the EUT was set in GPRS850 (2Tx slots) and GPRS1900 (3Tx slots) due to its highest frame-average power.

Timeslot consignations

No. Of Slots	Slot 1	Slot 2	Slot 3	Slot 4
Slot Consignation	1Up4Down	2Up3Down	3Up2Down	4Up1Down
Duty Cycle	1:8	1:4	1:2.67	1:2
Crest Factor	-9.03dB	-6.02dB	-4.26dB	-3.01dB

9.2 WCDMA Conducted peak output Power

WCDMA conducted peak output power

Item	band	WCDMA 850			WCDMA 1900		
	ARFCN	4132	4183	4233	9262	9400	9538
	subtest	dBm			dBm		
RMC 12.2kbps	non	22.72	22.68	22.56	22.58	22.48	22.63
HSDPA	1	22.37	22.42	22.39	22.28	22.27	22.31
	2	22.26	22.31	22.25	22.19	22.23	22.17
	3	22.21	22.17	22.23	22.04	22.05	22.12
	4	21.91	21.87	21.95	21.81	21.79	21.76
HSUPA	1	22.19	22.16	22.12	22.07	22.13	22.10
	2	22.51	22.47	22.54	22.24	22.31	22.18
	3	21.81	21.75	21.83	21.85	21.87	21.91
	4	22.46	22.55	22.50	22.22	22.18	22.25
	5	22.31	22.28	22.34	22.21	22.14	22.18

Note:

1. WCDMA SAR was tested under PMC 12.2kbps with HSPA Inactive per KDB Publication 941225 D01.HSPA SAR was not requires since the average output power of the HSPA subtests was not more than 0.25dB higher than the RMC level and SAR was less than 1.2W/kg.
2. It is expected by the manufacturer that MPR for some HSPA subtests may be up to 2dB more than specified by 3GPP, but also as low as 0dB according to the chipset implementation in this model.

RFID Output Power

Channel	Frequency (MHz)	Measured Output Peak Power (dBm)
1	902.75	29.243
26	915.25	29.154
50	927.25	28.896

WLAN 2.4GHz Band Conducted Power

For the 802.11b/g SAR tests, a communication link is set up with the test mode software for WiFi mode test. The Absolute Radio Frequency Channel Number(ARFCN) is allocated to 1 ,6 and 11 respectively in the case of 2450 MHz. During the test,at the each test frequency channel, the EUT is operated at the RF continuous emission mode. Each channel should be tested at the lowest data rate.

SAR is not required for 802.11g/n channels when the maximum average output power is less than 0.25dB higher than that measured on the corresponding 802.11b channels.

Channel/Freq (MHz)	Output Power (dBm) for Data Rates (Mbps)		
	802.11b	802.11g	802.11n(HT20)
1(2412)	18.08	17.14	17.13
6(2437)	18.19	17.49	17.41
11(2462)	18.29	17.52	17.58
Channel	802.11n(HT40)		
3(2422)	15.12		
6(2437)	16.10		
9(2452)	15.48		

Note: ANT Gain=-2.0dBi

Note:

1. Per KDB 248227 D01 v02r02, choose the highest output power channel to test SAR and determine further SAR exclusion
2. For each frequency band, testing at higher data rates and higher order modulations is not required when the maximum average output power for each of these configurations is less than 1/4dB higher than those measured at lowest data rate
3. Per KDB 248227 D01 v02r02, 802.11g /11n-HT20/11n-HT40 is not required. . When the highest reported SAR for DSSS is adjusted by the ratio of OFDM to DSSS specified maximum output power and the adjusted SAR is $\leq 1.2W/Kg$. Thus the SAR can be excluded.

Bluetooth Conducted Power

Channel	Frequency (MHz)	BT3.0 Output Power(dBm)		
		GFSK	π /4-DQPSK	8-DPSK
CH 0	2402	3.22	2.45	2.34
CH 39	2441	3.47	2.75	2.72
CH 78	2480	2.78	2.03	2.03

Channel	Frequency (MHz)	BT3.0 Output Power(dBm)
		GFSK
CH 0	2402	-4.63
CH 39	2441	-4.20
CH 78	2480	-4.94

Note: Antenna Gain=-2.0dBi, according to RSS102, Maximum output power of BT=3.47dBm=0.002mW, less than 4mW. No SAR required for BT

Estimated SAR for BT

- Per KDB 447498 D01v06, the 1-g and 10-g SAR test exclusion thresholds for 100MHz to 6GHz at test separation distances ≤ 50 mm are determined by: [(max. power of channel, including tune-up tolerance, mW)/(min. test separation distance, mm)] $\cdot [\sqrt{f}$ (GHz)] ≤ 3.0 for 1-g SAR and ≤ 7.5 for 10-g extremity SAR
 - f(GHz) is the RF channel transmit frequency in GHz
 - Power and distance are round to the nearest mW and mm before calculation
 - The result is rounded to one decimal place for comparison
 - If the test separation distance(antenna-user) is < 5mm, 5mm is used for excluded SAR calculation

Bluetooth Max Power (dBm)	mW	Test Distance (mm)	Frequency(Ghz)	Exclusion Thresholds
4.5	2.818	5	2.4	0.888

Per KDB 447498 D01v06 exclusion thresholds is 0.888<3, RF exposure evaluation is not required. BT estimated SAR value=Exclusion Thresholds/7.5=0.888/7.5=0.118W/Kg

Bluetooth Max Power (dBm)	mW	Test Distance (mm)	Frequency(Ghz)	Exclusion Thresholds
4.5	2.818	10	2.4	0.444

Per KDB 447498 D01v06 exclusion thresholds is 0.444<3, RF exposure evaluation is not required. BT estimated SAR value=Exclusion Thresholds/7.5=0.444/7.5=0.059W/Kg

The estimated SAR value is used for simultaneous transmission analysis.

General Note:

1. Per KDB 447498 D01v06, the reported SAR is the measured SAR value adjusted for maximum tune-up tolerance.
2. Per KDB447498 D01v06, testing of other required channels within the operating mode of a frequency band is not required when the reported 1-g or 10-g SAR for the mid-band or highest output power channel is: ≤ 0.8 W/kg or 2.0 W/kg, for 1-g or 10-g respectively, when the transmission band is ≤ 100 MHz. When the maximum output power variation across the required test channels is $> \frac{1}{2}$ dB, instead of the middle channel, the highest output power channel must be used.
3. Per KDB941225 D06v02r01, the DUT Dimension is bigger than 9 cm x 5 cm, so 10mm is chosen as the test separation distance for Hotspot mode. When the antenna-to-edge distance is greater than 2.5cm, such position does not need to be tested. As the manufacture required, the separation distance use 5mm for Hotspot mode.
4. Per KDB 865664 D01v01r04, for each frequency band, repeated SAR measurement is required only when the measured SAR is ≥ 0.8 W/Kg; if the deviation among the repeated measurement is $\leq 20\%$, and the measured SAR < 1.45 W/Kg, only one repeated measurement is required.
5. Per KDB865664 D02v01r02, SAR plot is only required for the highest measured SAR in each exposure configuration, wireless mode and frequency band combination; Plots are also required when the measured SAR is > 1.5 W/kg, or > 7.0 W/kg for occupational exposure. The published RF exposure KDB procedures may require additional plots; for example, to support SAR to peak location separation ratio test exclusion and/or volume scan post-processing(Refer to appendix D for details).
6. Per KDB941225 D01v03, when multiple slots can be used, the GPRS/EDGE slot configuration with the highest frame-averaged output power was selected for SAR testing.
7. Per KDB941225 D01v03, when the maximum output power and tune-up tolerance specified for production units in a secondary mode is $\leq \frac{1}{4}$ dB higher than the primary mode or when the highest reported SAR of the primary mode is scaled by the ratio of specified maximum output power and tune-up tolerance of secondary to primary mode and the adjusted SAR is ≤ 1.2 W/kg, SAR measurement is not required for the secondary mode.
8. Per KDB 248227 D01 v02r02, 802.11g /11n-HT20/11n-HT40 is not required. When the highest reported SAR for DSSS is adjusted by the ratio of OFDM to DSSS specified maximum output power and the adjusted SAR is ≤ 1.2 W/Kg. Thus the SAR can be excluded.

9.3. Scaling Factor calculation

Operation Mode	Channel	Output Power(dBm)	Tune up Power in tolerance(dBm)	Scaling Factor
GSM 850	128	32.38	32.50 ± 0.5	1.15
	190	32.46	32.50 ± 0.5	1.13
	251	32.47	32.50 ± 0.5	1.13
GPRS 850(2Tx)	128	29.96	29.60 ±0.5	1.03
	190	29.87	29.60 ±0.5	1.05
	251	29.93	29.60 ±0.5	1.04
GSM1900	512	28.84	28.50 ± 0.5	1.04
	661	28.83	28.50 ± 0.5	1.04
	810	28.86	28.50 ± 0.5	1.03
GPRS1900(3Tx)	512	25.49	25.00 ±0.5	1.00
	661	25.37	25.00 ±0.5	1.03
	810	25.32	25.00 ±0.5	1.04
WCDMA850	4132	22.72	23.00±0.5	1.20
	4183	22.68	23.00±0.5	1.21
	4233	22.56	23.00±0.5	1.24
WCDMA1900	9262	22.58	22.20±0.5	1.03
	9400	22.48	22.20±0.5	1.05
	9538	22.63	22.20±0.5	1.02
WIFI 802.11b	1	18.08	18.20±0.5	1.15
	6	18.19	18.20±0.5	1.12
	11	18.29	18.20±0.5	1.10
BT	39	3.47	3.5 ± 1.0	1.15
RFID	1	29.243	29 ± 0.5	1.06
	26	29.154	29 ± 0.5	1.08
	50	28.896	29 ± 0.5	1.15



Simultaneous SAR

No.	Transmitter Combinations	Scenario Supported or not	Supported for Mobile Hotspot or not
1	GSM(Voice)+GSM(Data)	No	No
2	WCDMA(Voice)+WCDMA(Data)	Yes	No
3	GSM(Voice)+ WCDMA(Data)	No	No
4	WCDMA(Voice)+GSM(Data)	No	No
5	GSM(Voice)+ WCDMA(Voice)	No	No
6	GSM(Voice)+Wifi	Yes	No
7	WCDMA(Voice) +Wifi	Yes	No
8	GSM(Voice)+ BT	Yes	No
9	WCDMA(Voice) + BT	Yes	No
10	GSM(Data)+wifi	Yes	Yes
11	WCDMA(Data) +wifi	Yes	Yes
12	RFID+GSM/WCDMA	No	No
13	RFID+WIFI	No	No

10 TEST RESULTS

10.1 Summary of SAR Measurement Results

Table 7: SAR Values of GSM 850MHz Band

Temperature: 23.0~23.5°C, humidity: 62~64%.						
Test Positions		Channel /Frequency (MHz)	SAR(W/Kg), 1.6 (1g average)		Plot No.	
			SAR(W/Kg),1g	Scaled SAR(W/Kg),1g		
Right Side of Head	Cheek	128/824.2	0.117	0.135	--	
		190/836.6	0.119	0.134	--	
		251/848.8	0.121	0.137	1	
	Tilt 15 degrees	251/848.8	0.076	0.086	--	
Left Side of Head	Cheek	251/848.8	0.108	0.122	--	
	Tilt 15 degrees	251/848.8	0.069	0.078	--	
Body-worn (10mm Separation)	GSM	Face Upward	251/848.8	0.124	0.140	--
		Back Upward	128/824.2	0.678	0.780	--
			190/836.6	0.681	0.770	--
			251/848.8	0.683	0.772	2
Hotspot (10mm Separation)	GPRS (2Tx)	Face Upward	128/824.2	0.101	0.104	--
		Back Upward	128/824.2	0.563	0.580	3
			190/836.6	0.551	0.579	--
			251/848.8	0.550	0.572	--
		Edge B	128/824.2	0.103	0.106	--
		Edge C	128/824.2	0.043	0.044	--
		Edge D	128/824.2	0.132	0.136	--



Table 8: SAR Values of GSM1900 MHz Band

Temperature: 23.0~23.5°C, humidity: 62~64%.						
Test Positions		Channel /Frequency (MHz)	SAR(W/Kg), 1.6 (1g average)		Plot No.	
			SAR(W/Kg),1g	Scaled SAR(W/Kg),1g		
Right Side of Head	Cheek	512/1850.2	0.062	0.064	--	
		661/1880.0	0.063	0.066	--	
		810/1909.8	0.067	0.069	4	
	Tilt 15 degrees	810/1909.8	0.043	0.044	--	
Left Side of Head	Cheek	810/1909.8	0.052	0.054	--	
	Tilt 15 degrees	810/1909.8	0.038	0.039	--	
Body-worn (10mm Separation)	GSM	Face Upward	810/1909.8	0.128	0.132	--
		Back Upward	810/1909.8	0.716	0.737	5
Hotspot (10mm Separation)	GPRS (3Tx)	Face Upward	512/1850.2	0.113	0.113	--
		Back Upward	512/1850.2	0.668	0.668	6
			661/1880.0	0.647	0.667	--
			810/1909.8	0.641	0.667	--
		Edge B	512/1850.2	0.098	0.098	--
		Edge C	512/1850.2	0.046	0.046	--
Edge D	512/1850.2	0.136	0.136	--		

Table 9: SAR Values of WCDMA850

Temperature: 23.0~23.5°C, humidity: 62~64%.					
Test Positions		Channel /Frequency (MHz)	SAR(W/Kg), 1.6 (1g average)		Plot No.
			SAR(W/Kg),1g	Scaled SAR(W/Kg),1g	
Right Side of Head	Cheek	4132/826.4	0.124	0.149	7
		4183/836.6	0.117	0.142	--
		4233/846.6	0.114	0.141	--
	Tilt 15 degrees	4132/826.4	0.080	0.096	--
Left Side of Head	Cheek	4132/826.4	0.117	0.140	--
	Tilt 15 degrees	4132/826.4	0.076	0.091	--
Body-worn (10mm Separation)	Face Upward	4132/826.4	0.104	0.125	--
	Back Upward	4132/826.4	0.578	0.694	8
		4183/836.6	0.564	0.682	--
		4233/846.6	0.531	0.658	--
Hotspot (10mm Separation)	Face Upward	4132/826.4	0.104	0.125	--
	Back Upward	4132/826.4	0.578	0.694	--
		4183/836.6	0.564	0.682	--
		4233/846.6	0.531	0.658	--
	Edge B	4132/826.4	0.105	0.126	--
	Edge C	4132/826.4	0.049	0.059	--
Edge D	4132/826.4	0.147	0.176	--	



Table 10: SAR Values of WCDMA1900

Temperature: 23.0~23.5°C, humidity: 62~64%.

Test Positions		Channel /Frequency (MHz)	SAR(W/Kg), 1.6 (1g average)		Plot No.
			SAR(W/Kg 1g Peak)	Scaled SAR(W/Kg),1g	
Right Side of Head	Cheek	9262/1852.4	0.127	0.131	--
		9400/1880.0	0.131	0.138	--
		9538/1907.6	0.136	0.139	9
	Tilt 15 degrees	9538/1907.6	0.091	0.093	--
Left Side of Head	Cheek	9538/1907.6	0.125	0.128	--
	Tilt 15 degrees	9538/1907.6	0.088	0.090	--
Body-worn (10mm Separation)	Face Upward	9538/1907.6	0.458	0.467	--
	Back Upward	9262/1852.4	1.032	1.063	--
		9400/1880.0	1.047	1.099	--
		9538/1907.6	1.053	1.074	10
	9538/1907.6 Repeat	1.052	1.073	--	
Hotspot (10mm Separation)	Face Upward	9262/1852.4	0.458	0.472	--
	Back Upward	9262/1852.4	1.032	1.063	--
		9400/1880.0	1.047	1.099	--
		9538/1907.6	1.053	1.074	--
		9538/1907.6 Repeat	1.052	1.073	--
	Edge B	9538/1907.6	0.378	0.386	--
	Edge C	9538/1907.6	0.253	0.258	--
Edge D	9538/1907.6	0.471	0.480	--	



Table 11: SAR Values of Wi-Fi 802.11b

Test Positions		Channel /Frequency (MHz)	SAR(W/Kg), 1.6 (1g average)		Plot No.
			SAR(W/Kg)1g Peak)	Scaled SAR(W/Kg),1g	
Right Side of Head	Cheek	1/2412	0.224	0.258	--
		6/2437	0.221	0.248	--
		11/2462	0.235	0.259	11
	Tilt 15 degrees	11/2462	0.184	0.202	--
Left Side of Head	Cheek	11/2462	0.193	0.212	--
	Tilt 15 degrees	11/2462	0.149	0.164	--
Body-worn (10mm Separation)	Face Upward	11/2462	0.078	0.086	--
	Back Upward	11/2462	0.269	0.296	--
Hotspot (10mm Separation)	Face Upward	11/2462	0.078	0.086	--
	Back Upward	11/2462	0.269	0.296	--
	Edge A	11/2462	0.034	0.037	--
	Edge D	1/2412	0.364	0.419	--
		6/2437	0.372	0.417	--
		11/2462	0.383	0.421	12

Table 12: SAR Values of RFID

Test Positions		Channel /Frequency (MHz)	SAR(W/Kg), 1.6 (1g average)		Plot No.
			SAR(W/Kg)1g Peak)	Scaled SAR(W/Kg),1g	
Body (10mm Separation)	Face Upward	26/915.25	0.458	0.495	--
	Back Upward	26/915.25	0.503	0.543	--
	Edge A	1/902.75	0.648	0.687	--
		26/915.25	0.655	0.707	13
		50/927.25	0.614	0.706	--
	Edge B	26/915.25	0.324	0.350	--
	Edge D	26/915.25	0.337	0.364	--

Note: When the 1-g SAR for the mid-band channel or the channel with the Highest output power satisfy the following conditions, testing of the other channels in the band is not required.(Per KDB 447498 D01 General RF Exposure Guidance v06)

- ≤ 0.8 W/kg, when the transmission band is ≤ 100 MHz
- ≤ 0.6 W/kg, when the transmission band is between 100 MHz and 200 MHz
- ≤ 0.4 W/kg, when the transmission band is ≥ 200 MHz

10.2 Conclusion

Localized Specific Absorption Rate (SAR) of this portable wireless device has been measured in all cases requested by the relevant standards cited in Clause 6 of this report. Maximum localized SAR is **below** exposure limits specified in the relevant standards.



SIMULTANEOUS TRANSMISSION ANALYSIS

Test Position		Right Cheek	Right Title	Left Cheek	Left Tilt
Head MAX 1-g SAR(W/Kg)	GSM850	0.137	0.086	0.122	0.078
	GSM1900	0.069	0.044	0.054	0.039
	WCDMA850	0.149	0.096	0.140	0.091
	WCDMA1900	0.139	0.093	0.128	0.090
	WIFI 802.11b	0.259	0.202	0.212	0.164
	BT	*0.118	*0.118	*0.118	*0.118
BT Simultaneous Σ 1-g SAR(W/Kg)		0.267	0.214	0.258	0.209
WiFi Simultaneous Σ 1-g SAR(W/Kg)		0.308	0.298	0.352	0.255

Test Position		Face	Back	Edge A	Edge B	Edge C	Edge D
Body-worn 10mm separation MAX 1-g SAR(W/Kg)	GSMS850	0.140	0.772	--	--	--	--
	GSM1900	0.132	0.737	--	--	--	--
	WCDMA850	0.125	0.694	--	--	--	--
	WCDMA1900	0.467	1.099	--	--	--	--
	WIFI 802.11b	0.086	0.296	--	--	--	--
	BT	*0.059	*0.059	--	--	--	--
BT Simultaneous Σ 1-g SAR(W/Kg)		0.526	1.158	--	--	--	--
WiFi Simultaneous Σ 1-g SAR(W/Kg)		0.553	1.395	--	--	--	--

Test Position		Face	Back	Edge A	Edge B	Edge C	Edge D
Hotspot 10mm separation MAX 1-g SAR(W/Kg)	GPRS850	0.104	0.580	--	0.106	0.044	0.136
	GPRS1900	0.113	0.668	--	0.098	0.046	0.136
	WCDMA 850	0.125	0.694	--	0.126	0.059	0.176
	WCDMA 1900	0.467	1.099	--	0.386	0.258	0.480
	WIFI 802.11b	0.086	0.296	0.037	--	--	0.421
	BT	*0.059	*0.059	*0.059	*0.059	*0.059	*0.059
BT Simultaneous Σ 1-g SAR(W/Kg)		0.526	1.158	0.059	0.445	0.059	0.059
WiFi Simultaneous Σ 1-g SAR(W/Kg)		0.553	1.395	0.037	0.386	0.258	0.901

The estimated SAR value with * Signal

SAR to Peak Location Separation Ratio (SPLSR)

As the Sum of the SAR is not greater than 1.6 W/kg SPLSR assessment is not required

11 Measurement Uncertainty

No.	Uncertainty Component	Type	Uncertainty Value (%)	Probability Distribution	k	ci	Standard Uncertainty (%) $u_i(\%)$	Degree of freedom ν_{eff} or ν_i
Measurement System								
1	–Probe Calibration	B	5.8	N	1	1	5.8	∞
2	–Axial isotropy	B	3.5	R	$\sqrt{3}$	0.5	1.43	∞
3	–Hemispherical Isotropy	B	5.9	R	$\sqrt{3}$	0.5	2.41	∞
4	–Boundary Effect	B	1	R	$\sqrt{3}$	1	0.58	∞
5	–Linearity	B	4.7	R	$\sqrt{3}$	1	2.71	∞
6	–System Detection Limits	B	1.0	R	$\sqrt{3}$	1	0.58	∞
7	Modulation response	B	3	N	1	1	3.00	
8	–Readout Electronics	B	0.5	N	1	1	0.50	∞
9	–Response Time	B	1.4	R	$\sqrt{3}$	1	0.81	∞
10	–Integration Time	B	3.0	R	$\sqrt{3}$	1	1.73	∞
11	–RF Ambient Conditions	B	3.0	R	$\sqrt{3}$	1	1.73	∞
12	–Probe Position Mechanical tolerance	B	1.4	R	$\sqrt{3}$	1	0.81	∞
13	–Probe Position with respect to Phantom Shell	B	1.4	R	$\sqrt{3}$	1	0.81	∞
14	–Extrapolation, Interpolation and Integration Algorithms for Max. SAR evaluation	B	2.3	R	$\sqrt{3}$	1	1.33	∞
Uncertainties of the DUT								
15	–Position of the DUT	A	2.6	N	$\sqrt{3}$	1	2.6	5
16	–Holder of the DUT	A	3	N	$\sqrt{3}$	1	3.0	5



17	–Output Power Variation –SAR drift measurement	B	5.0	R	$\sqrt{3}$	1	2.89	∞
Phantom and Tissue Parameters								
18	– Phantom Uncertainty(shape and thickness tolerances)	B	4	R	$\sqrt{3}$	1	2.31	∞
19	Uncertainty in SAR correction for deviation(in permittivity and conductivity)	B	2	N	1	1	2.00	
20	–Liquid Conductivity Target –tolerance	B	2.5	R	$\sqrt{3}$	0.6	1.95	∞
21	–Liquid Conductivity –measurement Uncertainty)	B	4	N	$\sqrt{3}$	1	0.92	9
22	–Liquid Permittivity Target tolerance	B	2.5	R	$\sqrt{3}$	0.6	1.95	∞
23	–Liquid Permittivity –measurement uncertainty	B	5	N	$\sqrt{3}$	1	1.15	∞
Combined Standard Uncertainty				RSS			10.63	
Expanded uncertainty (Confidence interval of 95 %)				K=2			21.26	

System Check Uncertainty

No.	Uncertainty Component	Type	Uncertainty Value (%)	Probability Distribution	k	ci	Standard Uncertainty (%) $u_i(\%)$	Degree of freedom v_{eff} or v_i
Measurement System								
1	–Probe Calibration	B	5.8	N	1	1	5.8	∞
2	–Axial isotropy	B	3.5	R	$\sqrt{3}$	0.5	1.43	∞
3	–Hemispherical Isotropy	B	5.9	R	$\sqrt{3}$	0.5	2.41	∞
4	–Boundary Effect	B	1	R	$\sqrt{3}$	1	0.58	∞
5	–Linearity	B	4.7	R	$\sqrt{3}$	1	2.71	∞
6	–System Detection Limits	B	1	R	$\sqrt{3}$	1	0.58	∞
7	Modulation response	B	0	N	1	1	0.00	



8	–Readout Electronics	B	0.5	N	1	1	0.50	∞
9	–Response Time	B	0.00	R	$\sqrt{3}$	1	0.00	∞
10	–Integration Time	B	1.4	R	$\sqrt{3}$	1	0.81	∞
11	–RF Ambient Conditions	B	3.0	R	$\sqrt{3}$	1	1.73	∞
12	–Probe Position Mechanical tolerance	B	1.4	R	$\sqrt{3}$	1	0.81	∞
13	–Probe Position with respect to Phantom Shell	B	1.4	R	$\sqrt{3}$	1	0.81	∞
14	–Extrapolation, Interpolation and Integration Algorithms for Max. SAR evaluation	B	2.3	R	$\sqrt{3}$	1	1.33	∞
Uncertainties of the DUT								
15	Deviation of experimental source from numerical source	A	4	N	1	1	4.00	5
16	Input Power and SAR drift measurement	A	5	R	$\sqrt{3}$	1	2.89	5
17	Dipole Axis to Liquid Distance	B	2	R	$\sqrt{3}$	1	1.2	∞
Phantom and Tissue Parameters								
18	–Phantom Uncertainty(shape and thickness tolerances)	B	4	R	$\sqrt{3}$	1	2.31	∞
19	Uncertainty in SAR correction for deviation(in permittivity and conductivity)	B	2	N	1	1	2.00	
20	–Liquid Conductivity Target –tolerance	B	2.5	R	$\sqrt{3}$	0.6	1.95	∞
21	–Liquid Conductivity –measurement Uncertainty)	B	4	N	$\sqrt{3}$	1	0.92	9
22	–Liquid Permittivity Target tolerance	B	2.5	R	$\sqrt{3}$	0.6	1.95	∞
23	–Liquid Permittivity –measurement uncertainty	B	5	N	$\sqrt{3}$	1	1.15	∞
Combined Standard Uncertainty				RSS			10.15	
Expanded uncertainty (Confidence interval of 95 %)				K=2			20.29	

**12 MAIN TEST INSTRUMENTS**

EQUIPMENT	TYPE	Series No.	Calibration Date	calibration period
System Simulator	E5515C	GB 47200710	2016/06/10	1 Year
System Simulator	CMW500	130805	2015/08/10	1 Year
SAR Probe	SATIMO	SN_0413_EP166	2015/08/10	1 Year
SAR Probe	SATIMO	SN43/15 EP276	2015/12/09	1 Year
Dipole	SID835	SN09/13 DIP0G835-217	2014/08/28	2 Year
Dipole	SID900	SN_09/13_DIP0G900-215	2014/08/28	2 Year
Dipole	SID1900	SN09/13 DIP1G900-218	2014/08/28	2 Year
Dipole	SID2450	SN09/13 DIP2G450-220	2014/08/28	2 Year
Vector Network Analyzer	ZVB8	A0802530	2016/06/08	1 Year
Signal Generator	SMR27	A0304219	2016/06/08	1 Year
Power Meter	ML2495A	1421017	2016/06.02	1 Year
Power Sensor	MA2411B	1417208	2016/06/02	1 Year
Amplifier	Nucletudes	143060	2016/03/09	1 Year
Directional Coupler	DC6180A	305827	2016/03/09	1 Year
Multimeter	Keithley-2000	4014020	2016/03/09	1 Year



ANNEX A

of

CCIC-SET

CONFORMANCE TEST REPORT FOR

HUMAN EXPOSURE TO ELECTROMAGNETIC FIELDS

SET2016-11240

Connected Handheld RFID Reader

Type Name: ALR-H450

Hardware Version: C4050_MB_V5.0

Software Version: V1.0.0_10040006582_20151221

TEST SETUP

This Annex consists of 8 pages

Date of Report: 2016-08-26



Fig.1 COMO SAR Test System

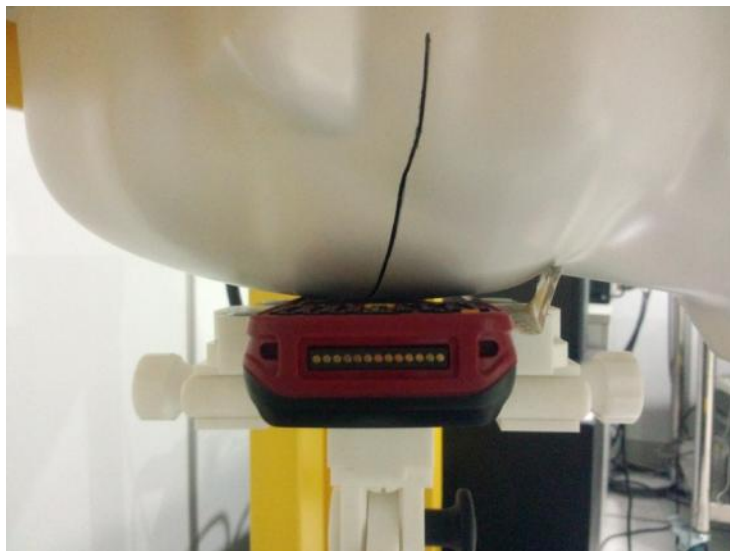

Fig.2 Right_Cheek

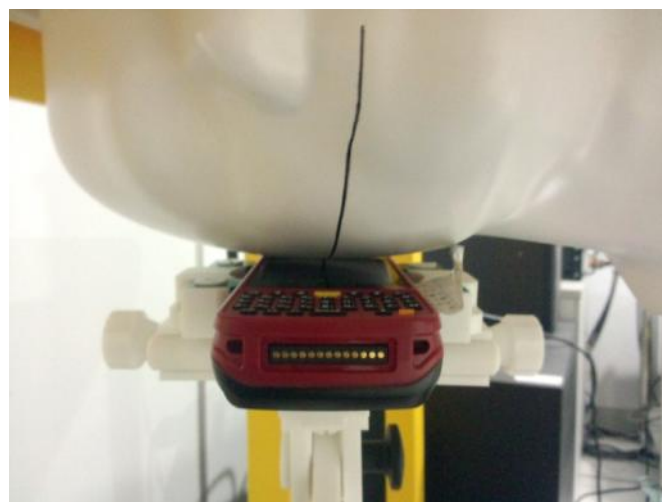

Fig.3 Right_Tilt

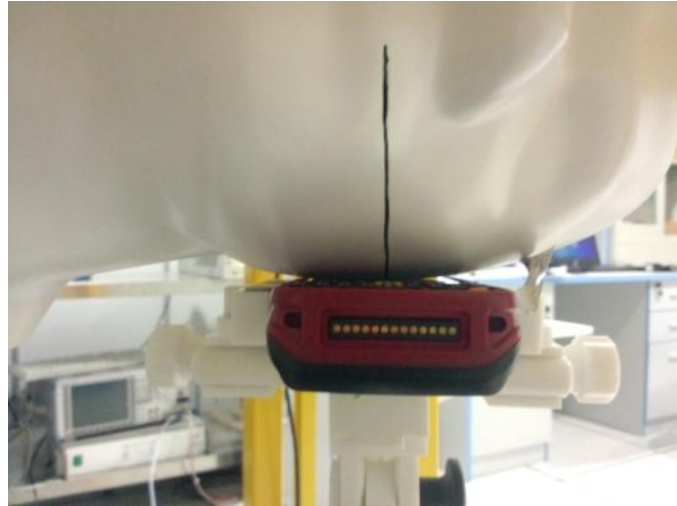

Fig.4 Left Cheek

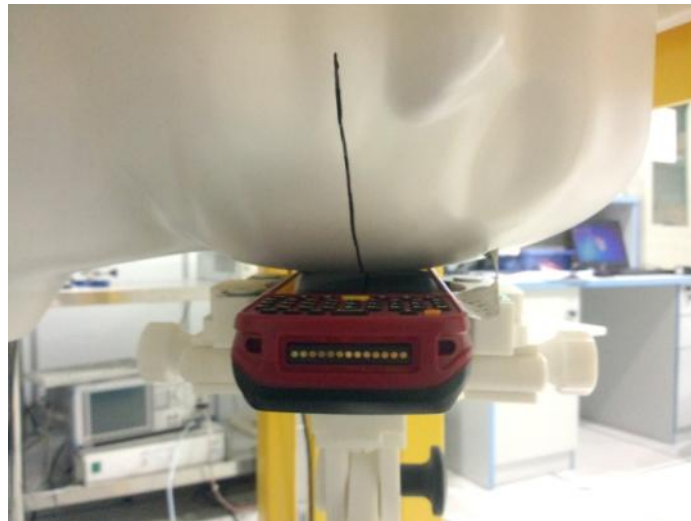

Fig.5 Left_Tilt



Fig.6 Body (Back upside,10mm separation)



Fig.7 Body (Face upside,10mm separation)



Fig.8 Body Edge A(UP,10mm separation)

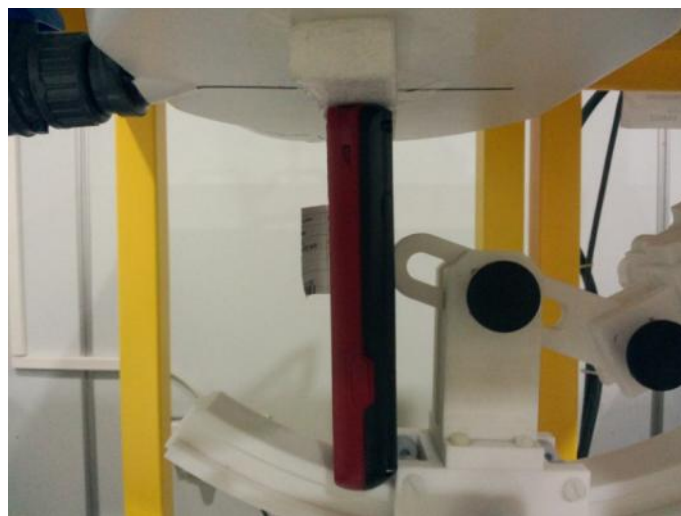

Fig.9 Body Edge C(UP,10mm separation)



Fig.10 Body Edge D(Right upside,10mm separation)



Fig.11 Body RFID(Face upside,10mm separation)

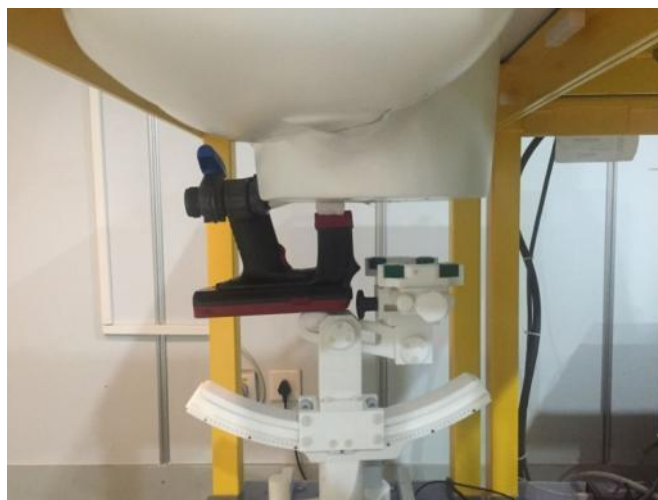

Fig.12 Body RFID(Back upside,10mm separation)



Fig.13 Body Edge A(UP,10mm separation)



Fig.14 Body Edge B(UP,10mm separation)



Fig.15 Body Edge D(Right upside,10mm separation)



Fig.16 Head Liquid of 850MHz(15cm)



Fig.17 Body Liquid of 850-900MHz (15cm)



Fig.18 Head Liquid of 1900MHz(15cm)



Fig.19 Body Liquid of 1900MHz(15cm)



Fig.20 Head Liquid of 2450 (15cm)



Fig.21 Body Liquid of 2450 (15cm)



ANNEX B

of

CCIC-SET

CONFORMANCE TEST REPORT FOR

HUMAN EXPOSURE TO ELECTROMAGNETIC FIELDS

SET2016-11240

Connected Handheld RFID Reader

Type Name: ALR-H450

Hardware Version: C4050_MB_V5.0

Software Version: V1.0.0_10040006582_20151221

Sample Photographs

This Annex consists of 2 pages

Date of Report: 2016-08-26

1. Appearance



Appearance and size (obverse)



Appearance and size (reverse)



ANNEX C

of

CCIC-SET

CONFORMANCE TEST REPORT FOR

HUMAN EXPOSURE TO ELECTROMAGNETIC FIELDS

SET2016-11240

Connected Handheld RFID Reader

Type Name: ALR-H450

Hardware Version: C4050_MB_V5.0

Software Version: V1.0.0_10040006582_20151221

System Performance Check Data and Highest SAR Plots

This Annex consists of 34 pages

Date of Report: 2016-08-26

System Performance Check (Head, 835MHz)

Type: Validation measurement

Area scan resolution: dx=8mm,dy=8mm

Zoom scan resolution: dx=8mm, dy=8mm, dz=5mm

Date of measurement:28/06/2016

Measurement duration: 21 minutes 24 seconds

A. Experimental conditions.

Phantom File	dx=8mm dy=8mm
Phantom	5x5x7,dx=8mm dy=8mm dz=5mm
Device Position	
Band	835MHz
Channels	
Signal	CW

B. SAR Measurement Results

Band SAR

E-Field Probe	SATIMO SN_04/13_EP166
Frequency (MHz)	835
Relative permittivity (real part)	41.32
Relative permittivity	18.97
Conductivity (S/m)	0.88
Power drift (%)	0.68
Ambient Temperature:	23.2°C
Liquid Temperature:	23.5°C
ConvF:	5.69
Duty factor:	1:1

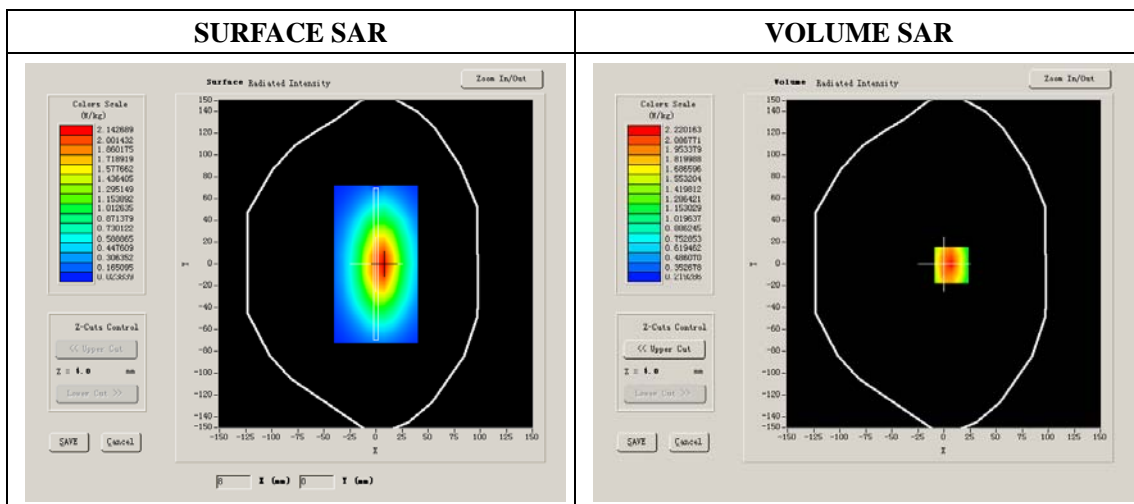

Maximum location: X=7.00, Y=-1.00

SAR 10g (W/Kg)	1.820542
SAR 1g (W/Kg)	2.413845

System Performance Check (Head, 1900MHz)

Type: Validation measurement

Area scan resolution: dx=8mm,dy=8mm

Zoom scan resolution: dx=8mm, dy=8mm, dz=5mm

Date of measurement: 29/06/2016

Measurement duration: 22 minutes 32 seconds

A. Experimental conditions.

Phantom File	dx=8mm dy=8mm
Phantom	5x5x7,dx=8mm dy=8mm dz=5mm
Device Position	
Band	1900MHz
Channels	
Signal	CW

B. SAR Measurement Results

Band SAR

E-Field Probe	SATIMO SN_04/13_EP166
Frequency (MHz)	1900.000000
Relative permittivity (real part)	39.84
Relative permittivity	13.17
Conductivity (S/m)	1.39
Power drift (%)	-0.51
Ambient Temperature:	22.2°C
Liquid Temperature:	22.5°C
ConvF:	5.25
Duty factor:	1:1

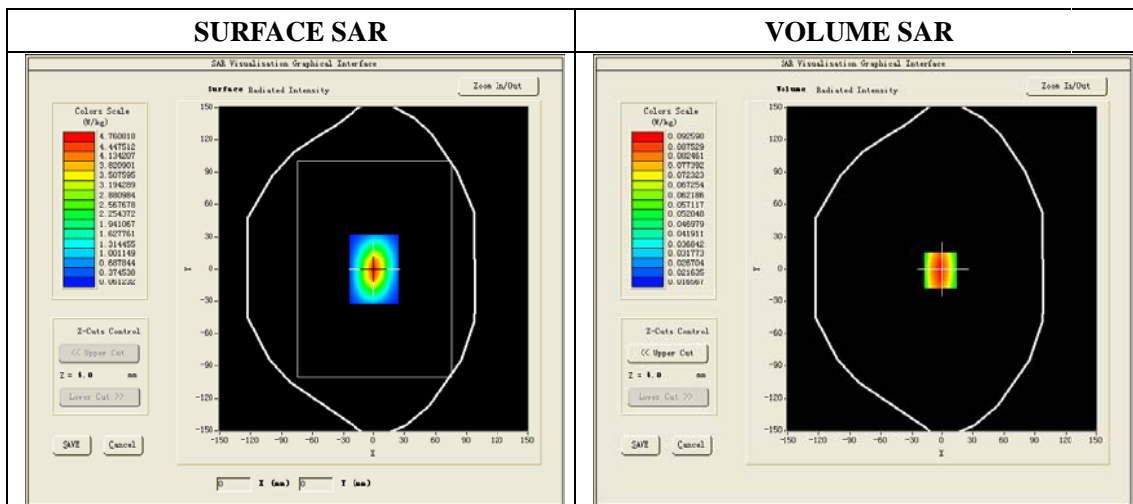

Maximum location: X=6.00, Y=0.00

SAR 10g (W/Kg)	5.153458
SAR 1g (W/Kg)	9.867282

System Performance Check (Head, 2450MHz)

Type: Phone measurement

Area scan resolution: dx=8mm,dy=8mm

Zoom scan resolution: dx=5mm dy=5mm dz=4mm

Date of measurement: 29/06/2016

Measurement duration: 21 minutes 24 seconds

A. Experimental conditions.

Phantom File	dx=8mm dy=8mm
Phantom	7x7x8,dx=5mm dy=5mm dz=4mm
Device Position	Dipole
Band	2450MHz
Channels	
Signal	CW

B. SAR Measurement Results

Band SAR

E-Field Probe	SATIMO SN_04/13_EP166
Frequency (MHz)	2450
Relative permittivity (real part)	38.96
Relative permittivity	13.22
Conductivity (S/m)	1.80
Power Drift (%)	-1.52
ConvF:	4.93
Duty factor:	1:1

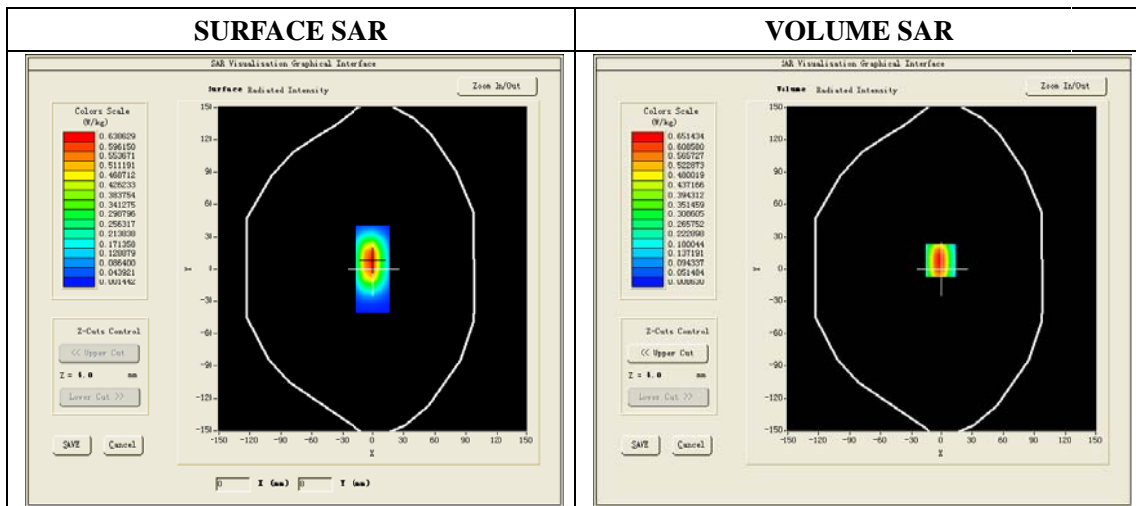

Maximum location: X=0.00, Y=8.00

SAR 10g (W/Kg)	5.916247
SAR 1g (W/Kg)	13.183472

System Performance Check (Body, 835MHz)

Type: Validation measurement

Area scan resolution: dx=8mm,dy=8mm

Zoom scan resolution: dx=8mm, dy=8mm, dz=5mm

Date of measurement: 28/06/2016

Measurement duration: 20 minutes 12 seconds

A. Experimental conditions.

Phantom File	dx=8mm dy=8mm
Phantom	5x5x7,dx=8mm dy=8mm dz=5mm
Device Position	Dipole
Band	835MHz
Channels	
Signal	CW

B. SAR Measurement Results

Band SAR

E-Field Probe	SATIMO SN_04/13_EP166
Frequency (MHz)	835
Relative permittivity (real part)	54.82
Relative permittivity	20.48
Conductivity (S/m)	0.95
Power drift (%)	2.30
Ambient Temperature:	22.2°C
Liquid Temperature:	22.5°C
ConvF:	5.82
Duty factor:	1:1

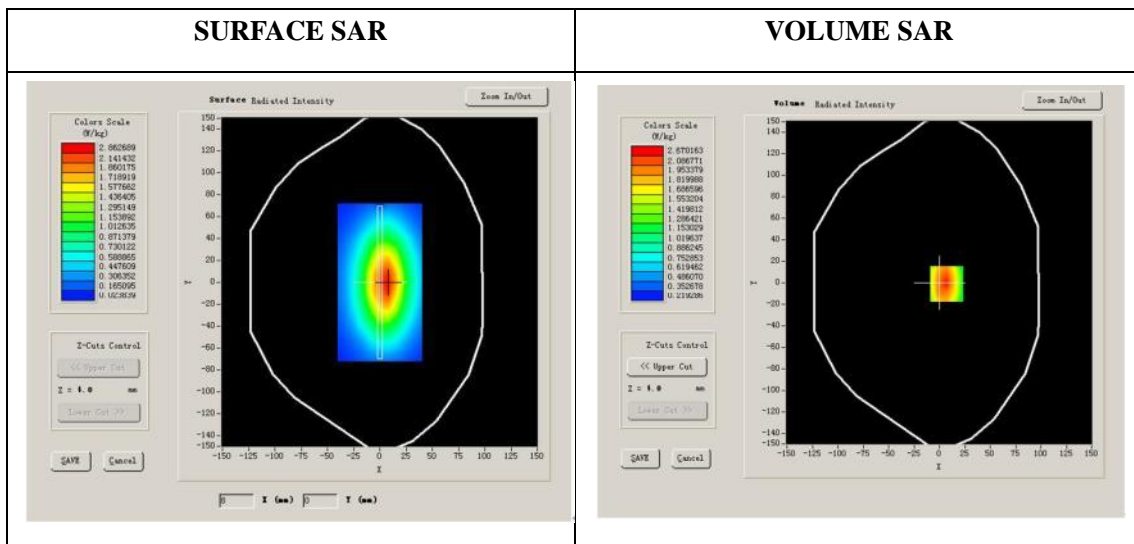

Maximum location: X=7.00, Y=-1.00

SAR 10g (W/Kg)	1.632514
SAR 1g (W/Kg)	2.542683

System Performance Check (Body, 1900MHz)

Type: Validation measurement

Area scan resolution: dx=8mm,dy=8mm

Zoom scan resolution: dx=8mm, dy=8mm, dz=5mm

Date of measurement: 29/06/2016

Measurement duration: 21 minutes 34 seconds

A. Experimental conditions.

Phantom File	dx=8mm dy=8mm
Phantom	5x5x7,dx=8mm dy=8mm dz=5mm
Device Position	Dipole
Band	1900MHz
Channels	
Signal	CW

B. SAR Measurement Results

Band SAR

E-Field Probe	SATIMO SN_04/13_EP166
Frequency (MHz)	1900
Relative permittivity (real part)	52.87
Relative permittivity	14.21
Conductivity (S/m)	1.50
Power Drift (%)	3.21
Ambient Temperature:	22.1°C
Liquid Temperature:	22.6°C
ConvF:	5.43
Duty factor:	1:1

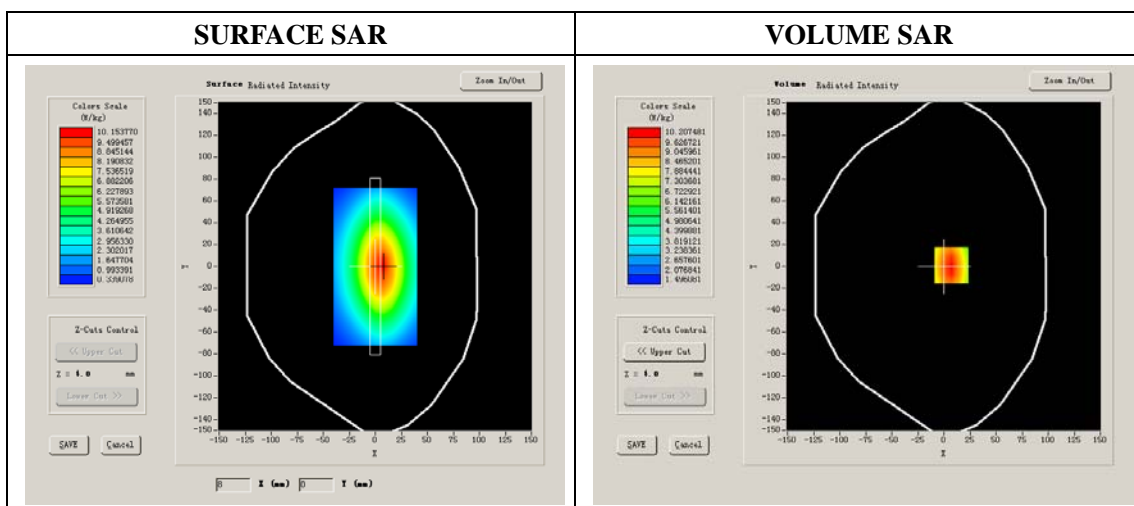

Maximum location: X=1.00, Y=6.00

SAR 10g (W/Kg)	5.284627
SAR 1g (W/Kg)	10.128426

System Performance Check (Body, 2450MHz)

Type: Phone measurement

Area scan resolution: dx=8mm,dy=8mm

Zoom scan resolution: dx=5mm, dy=5mm, dz=4mm

Date of measurement: 29/06/2016

Measurement duration: 22 minutes 21 seconds

A. Experimental conditions.

Phantom File	dx=8mm dy=8mm
Phantom	7x7x8,dx=5mm dy=5mm dz=4mm
Device Position	Dipole
Band	2450MHz
Channels	
Signal	CW

B. SAR Measurement Results

Band SAR

E-Field Probe	SATIMO SN_04/13_EP166
Frequency (MHz)	2450
Relative permittivity (real part)	52.47
Relative permittivity	14.25
Conductivity (S/m)	1.94
Power Drift (%)	-0.31
Duty factor:	1:1
ConvF:	5.09

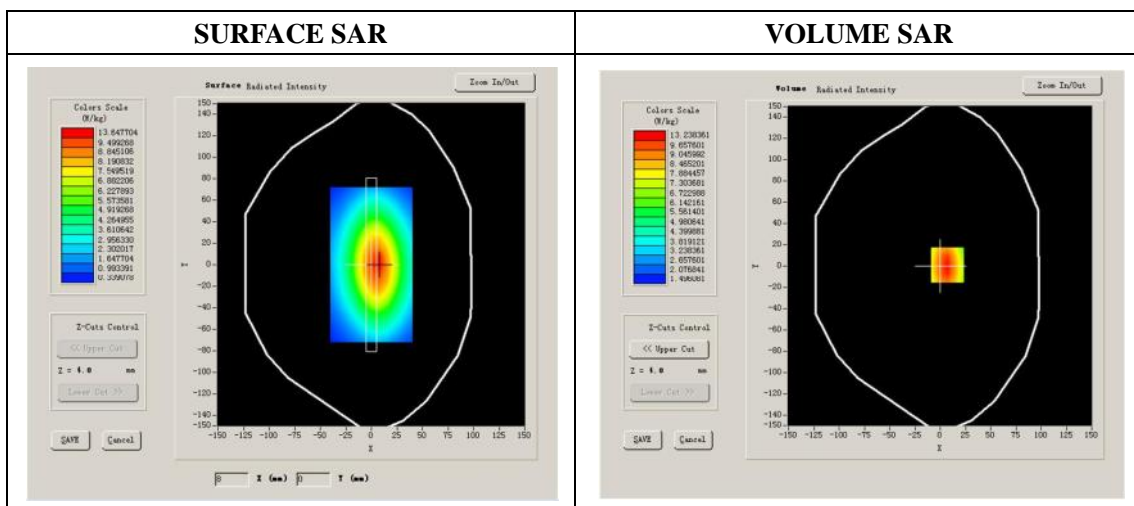

Maximum location: X=0.00, Y=8.00

SAR 10g (W/Kg)	6.046258
SAR 1g (W/Kg)	13.074232

System Performance Check (Body, 900MHz)

Type: Phone measurement (Complete)

Area scan resolution: dx=8mm,dy=8mm

Zoom scan resolution: dx=8mm, dy=8mm, dz=5mm

Date of measurement: 19/08/2016

Measurement duration: 21 minutes 12 seconds

A. Experimental conditions.

Phantom File	surf_sam_plan.txt
Phantom	Flat Plane
Device Position	
Band	900MHz
Channels	
Signal	CW

B. SAR Measurement Results

Band SAR

E-Field Probe	SN43/15 EP276
Frequency (MHz)	900
Relative permittivity (real part)	55.26
Relative permittivity	21.71
Conductivity (S/m)	1.04
Power drift (%)	-0.25
Crest factor:	1:1
ConvF:	6.28

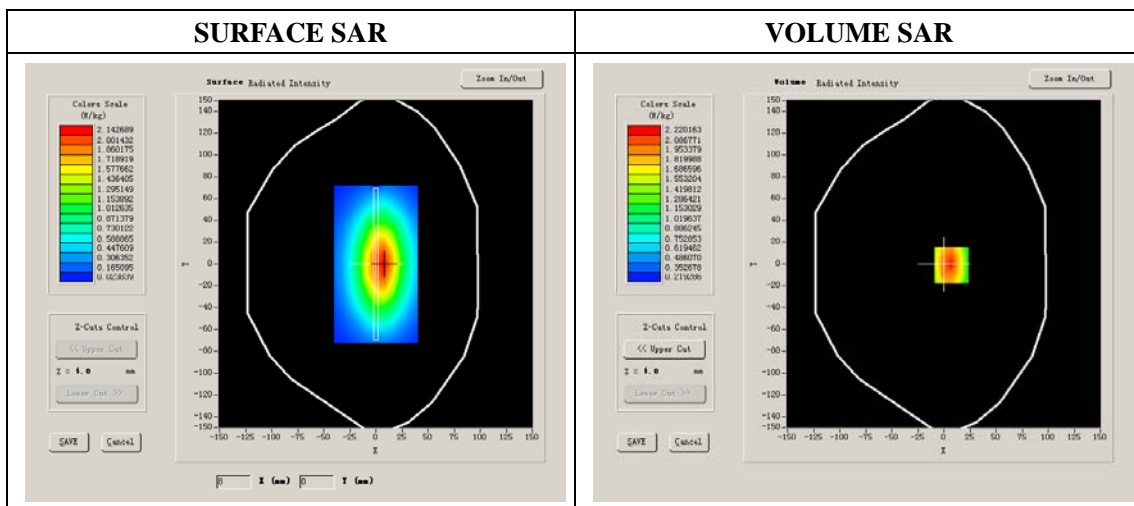

Maximum location: X=7.00, Y=-1.00

SAR 10g (W/Kg)	1.473547
SAR 1g (W/Kg)	2.763482

Plot 1:GSM850, Right Cheek, High

Type: Phone measurement
 Date of measurement: 28/06/2016
 Measurement duration: 7 minutes 17 seconds
 Mobile Phone IMEI number: --

A. Experimental conditions.

Area Scan	dx=8mm dy=8mm
ZoomScan	5x5x7,dx=8mm dy=8mm dz=5mm
Phantom	Right head
Device Position	Cheek
Band	GSM850
Channels	251
Signal	GSM (Duty cycle: 1:8)

B. SAR Measurement Results

E-Field Probe	SATIMO SN_04/13_EP166
Frequency (MHz)	848.8
Relative permittivity (real part)	41.34
Relative permittivity (imaginary part)	18.97
Conductivity (S/m)	0.88
Variation (%)	-4.29
ConvF:	5.69

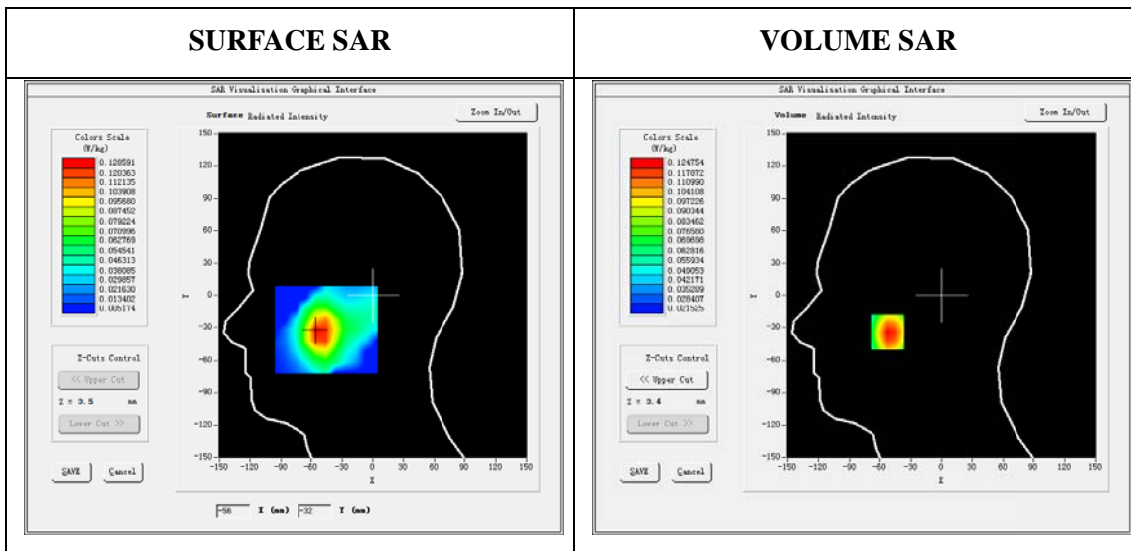

Maximum location: X=-53.00, Y=-34.00
 SAR Peak: 0.16 W/kg

SAR 10g (W/Kg)	0.087872
SAR 1g (W/Kg)	0.120623

Z (mm)	0.00	4.00	9.00	14.00	19.00
SAR (W/Kg)	0.1527	0.1248	0.0980	0.0788	0.0652

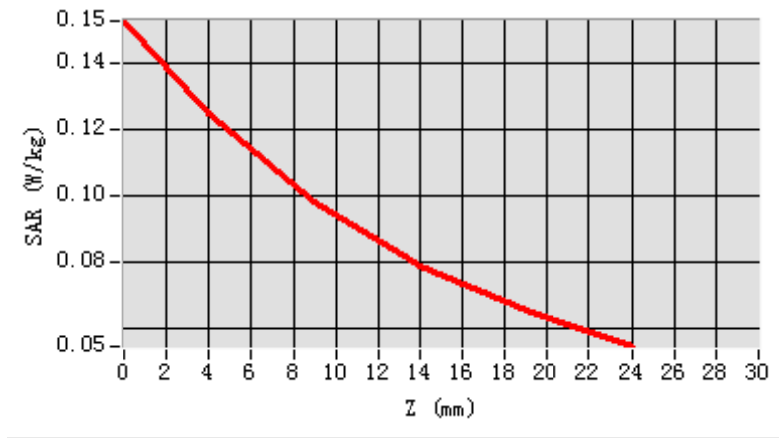

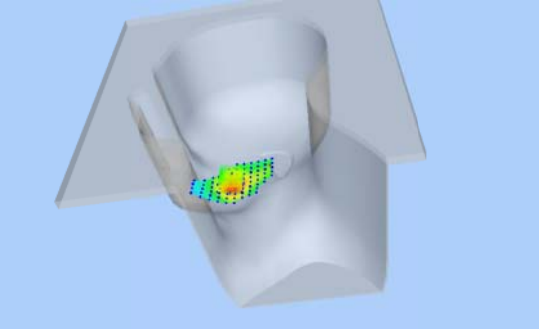
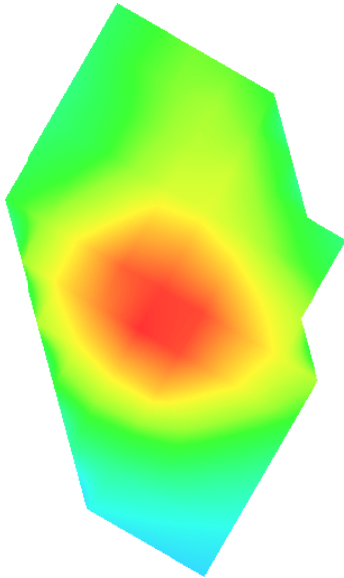
3D screen shot	Hot spot position
	

Plot 2: GSM850, Back, High

Type: Phone measurement

Date of measurement: 28/06/2016

Measurement duration: 6minutes 53 seconds

Mobile Phone IMEI number: --

A. Experimental conditions.

Area Scan	dx=8mm dy=8mm
ZoomScan	5x5x7,dx=8mm dy=8mm dz=5mm
Phantom	Validation plane
Device Position	Back
Band	GSM850
Channels	251
Signal	GSM(Duty cycle: 1:8)

B. SAR Measurement Results

E-Field Probe	SATIMO SN_04/13_EP166
Frequency (MHz)	848.8
Relative permittivity (real part)	54.82
Relative permittivity (imaginary part)	20.48
Conductivity (S/m)	0.95
Variation (%)	3.93
ConvF:	3.92

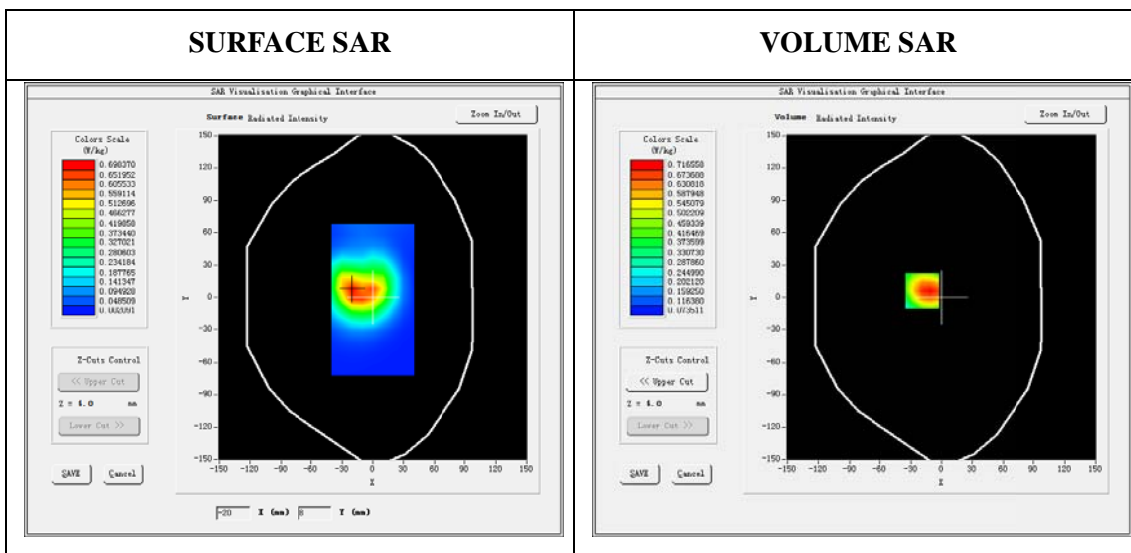

Maximum location: X=-19.00, Y=6.00

SAR Peak: 0.95 W/kg

SAR 10g (W/Kg)	0.462819
SAR 1g (W/Kg)	0.683342

Z (mm)	0.00	4.00	9.00	14.00	19.00
SAR (W/Kg)	0.9194	0.6969	0.4972	0.3652	0.2790

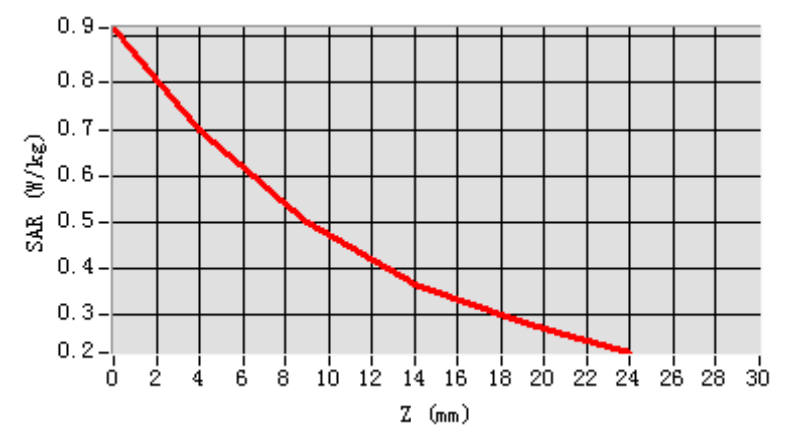

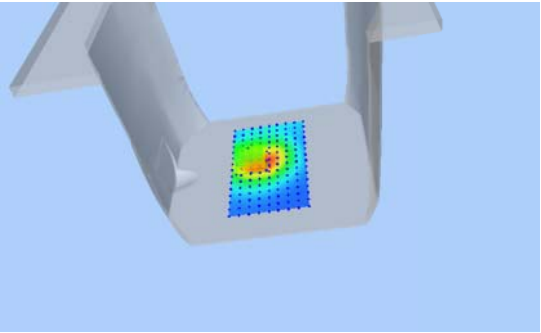
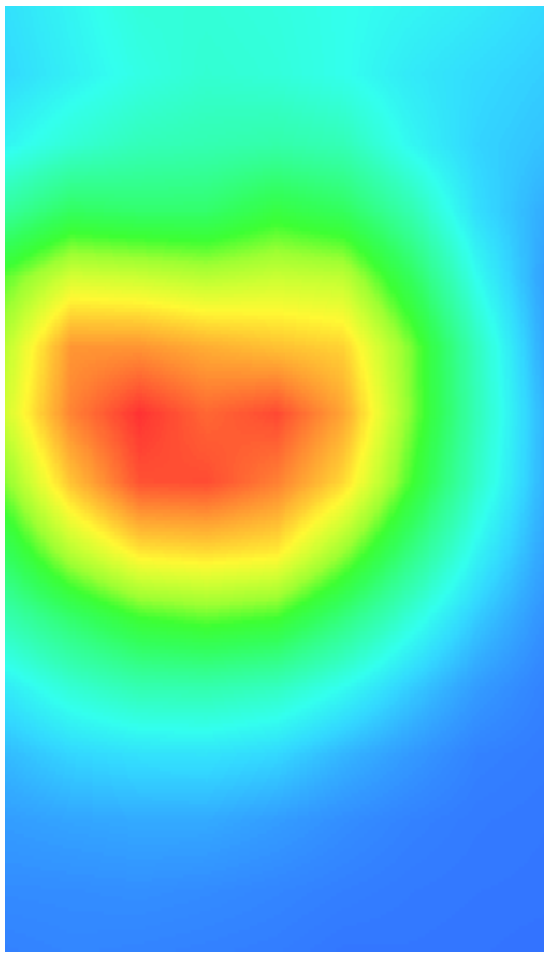
3D screen shot	Hot spot position
	

Plot 3:GPRS850, Back, Low

Type: Phone measurement
 Date of measurement: 28/06/2016
 Measurement duration: 7 minutes 09 seconds
 Mobile Phone IMEI number: --

A. Experimental conditions.

Area Scan	dx=8mm dy=8mm
ZoomScan	5x5x7,dx=8mm dy=8mm dz=5mm
Phantom	Validation plane
Device Position	Back
Band	GSPRS850_2Tx
Channels	128
Signal	GPRS(Duty cycle: 1:4)

B. SAR Measurement Results

E-Field Probe	SATIMO SN_04/13_EP166
Frequency (MHz)	824.2
Relative permittivity (real part)	54.80
Relative permittivity (imaginary part)	20.48
Conductivity (S/m)	0.95
Variation (%)	-3.56
ConvF:	5.82

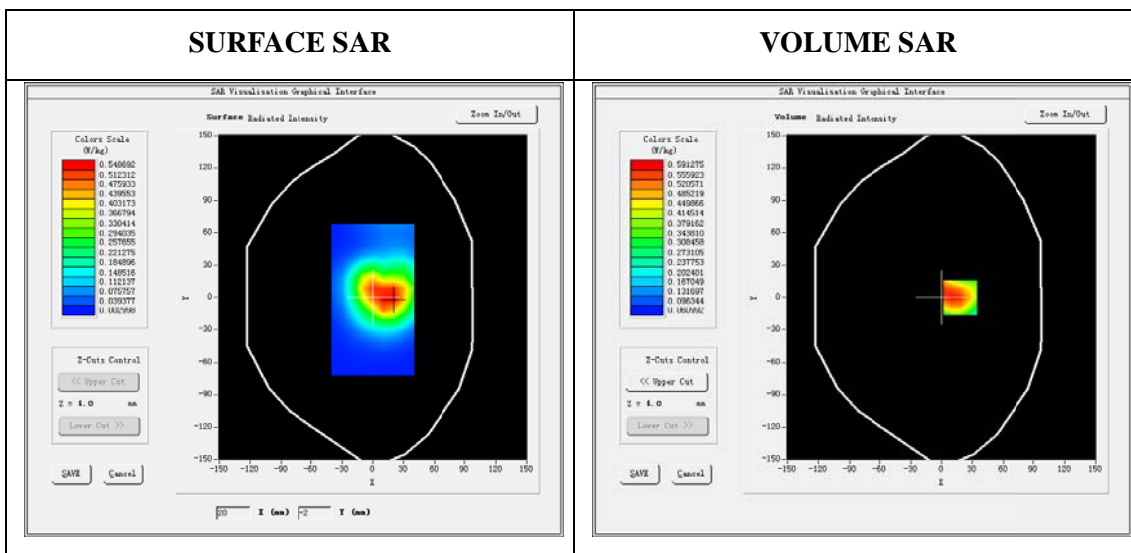

Maximum location: X=18.00, Y=0.00
 SAR Peak: 0.77 W/kg

SAR 10g (W/Kg)	0.383255
SAR 1g (W/Kg)	0.563206

Z (mm)	0.00	4.00	9.00	14.00	19.00
SAR (W/Kg)	0.7496	0.5780	0.4176	0.3050	0.2263

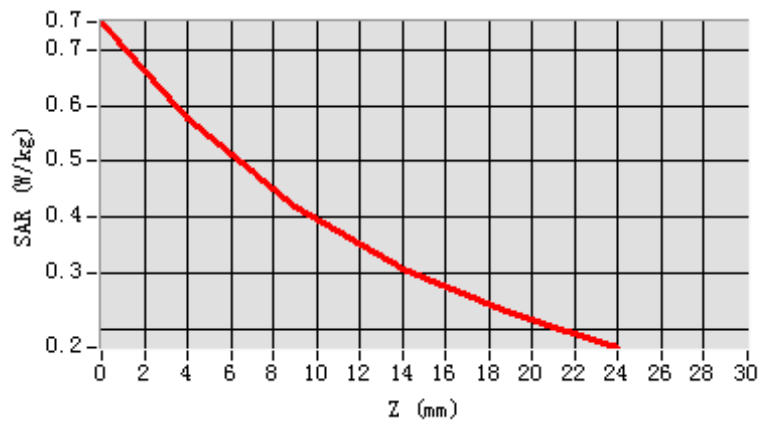

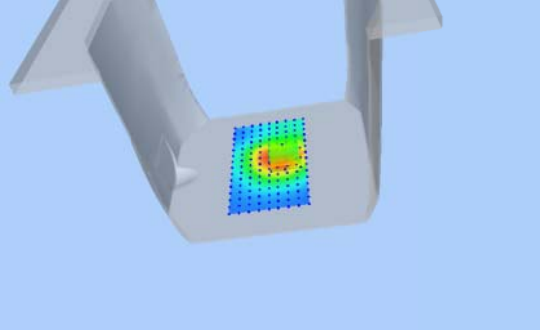
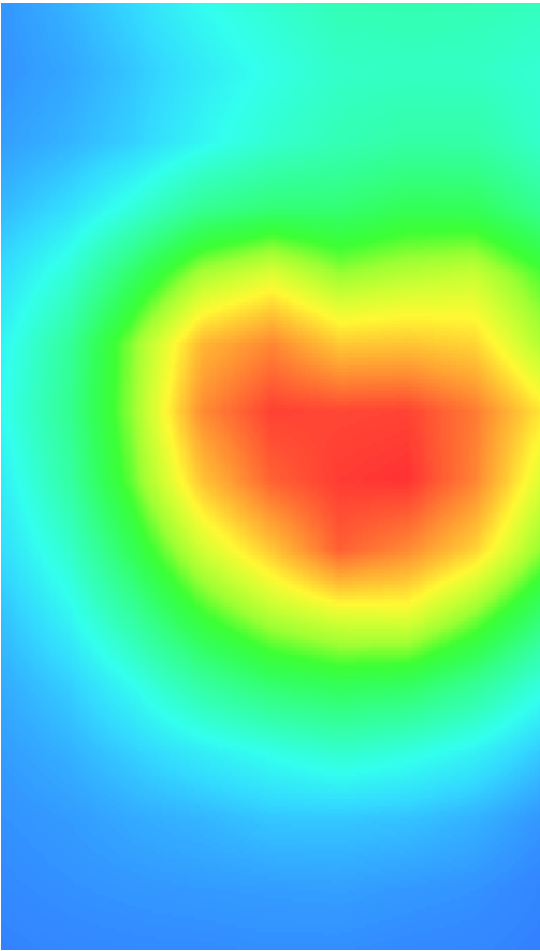
3D screen shot	Hot spot position
	

Plot 4:GSM1900, Right Cheek, High

Type: Phone measurement
 Date of measurement: 29/06/2016
 Measurement duration: 7 minutes 01 seconds
 Mobile Phone IMEI number: --

A. Experimental conditions.

Area Scan	dx=8mm dy=8mm
ZoomScan	5x5x7,dx=8mm dy=8mm dz=5mm
Phantom	Right head
Device Position	Cheek
Band	GSM1900
Channels	810
Signal	GSM (Duty cycle: 1:8)

B. SAR Measurement Results

E-Field Probe	SATIMO SN_04/13_EP166
Frequency (MHz)	1909.8
Relative permittivity (real part)	39.85
Relative permittivity (imaginary part)	13.17
Conductivity (S/m)	1.39
Variation (%)	1.77
ConvF:	5.25

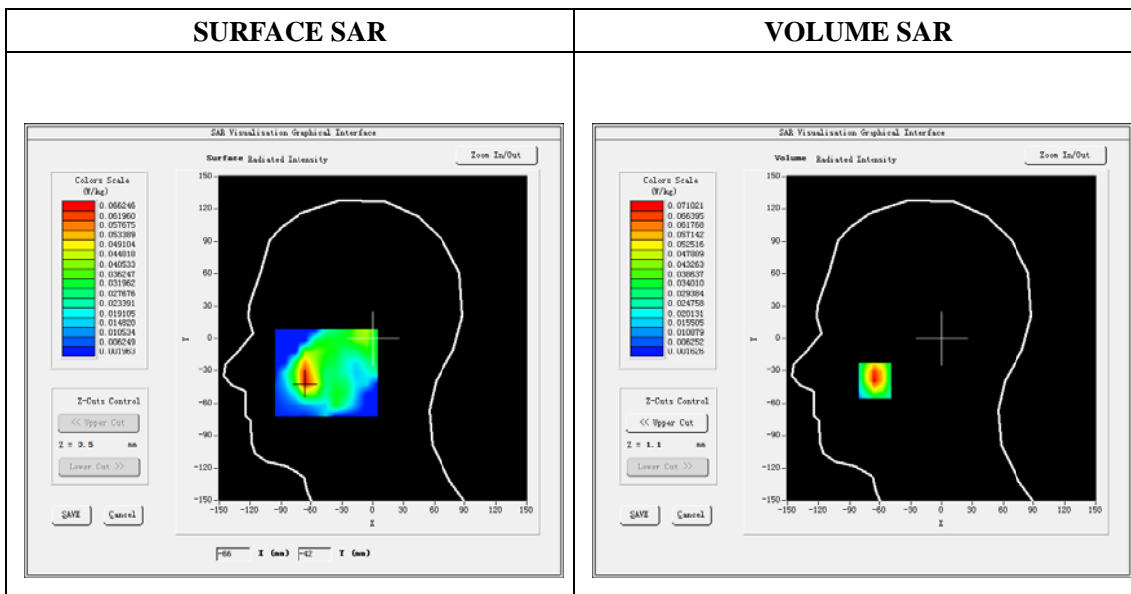

Maximum location: X=-65.00, Y=-39.00
 SAR Peak: 0.10 W/kg

SAR 10g (W/Kg)	0.037768
SAR 1g (W/Kg)	0.066836

Z (mm)	0.00	4.00	9.00	14.00	19.00
SAR (W/Kg)	0.1025	0.0710	0.0446	0.0286	0.0191

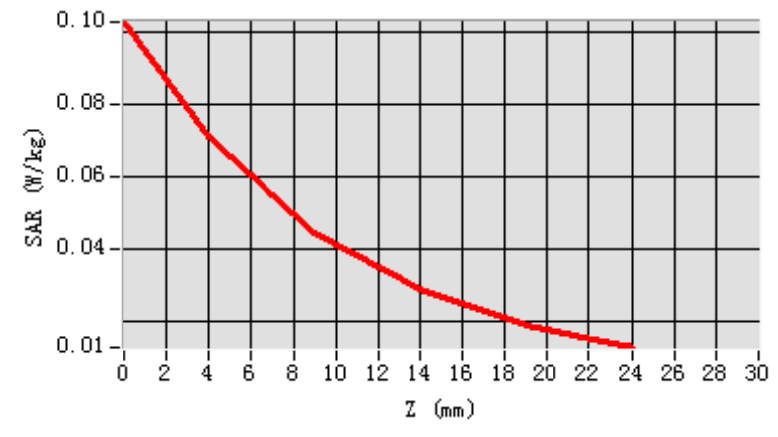

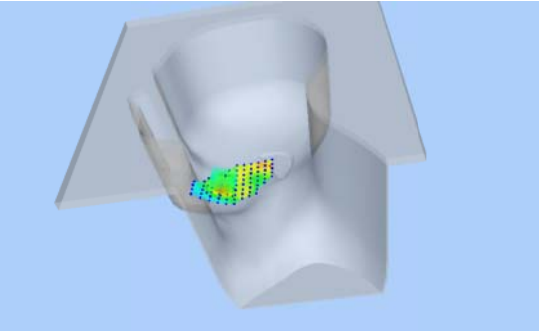
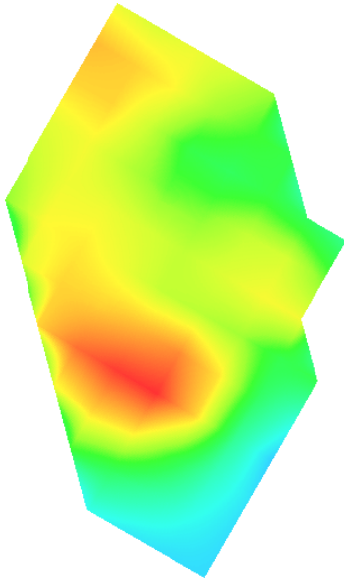
3D screen shot	Hot spot position
	

Plot 5:GSM1900, Back, High

Type: Phone measurement

Date of measurement: 29/06/2016

Measurement duration: 6 minutes 58 seconds

Mobile Phone IMEI number: --

A. Experimental conditions.

Area Scan	dx=8mm dy=8mm
ZoomScan	5x5x7,dx=8mm dy=8mm dz=5mm
Phantom	Validation plane
Device Position	Back
Band	GSM1900
Channels	810
Signal	GSM (Duty cycle: 1:8)

B. SAR Measurement Results

E-Field Probe	SATIMO SN_04/13_EP166
Frequency (MHz)	1909.8
Relative permittivity (real part)	52.88
Relative permittivity (imaginary part)	14.21
Conductivity (S/m)	1.50
Variation (%)	-4.65
ConvF:	5.43

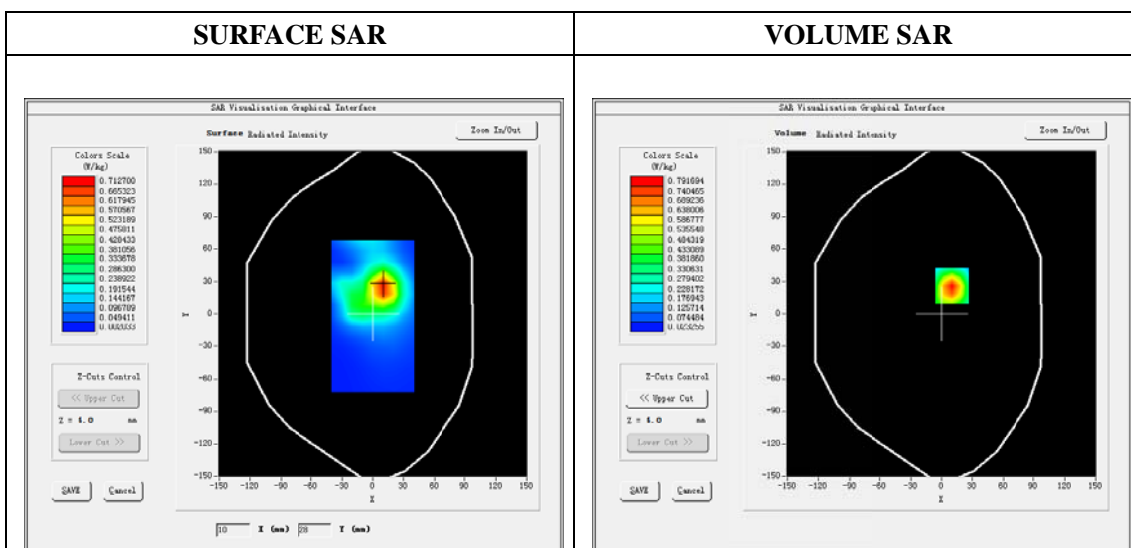

Maximum location: X=10.00, Y=26.00
SAR Peak: 1.12 W/kg

SAR 10g (W/Kg)	0.410661
SAR 1g (W/Kg)	0.716409

Z (mm)	0.00	4.00	9.00	14.00	19.00
SAR (W/Kg)	1.1049	0.7917	0.5120	0.3265	0.2052

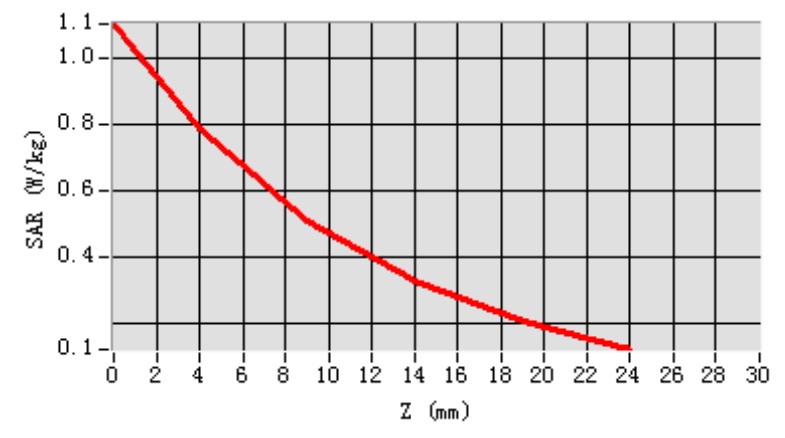

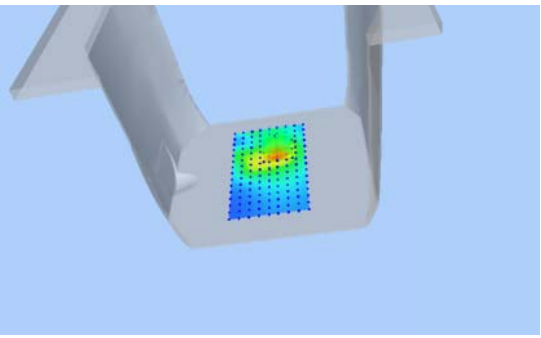
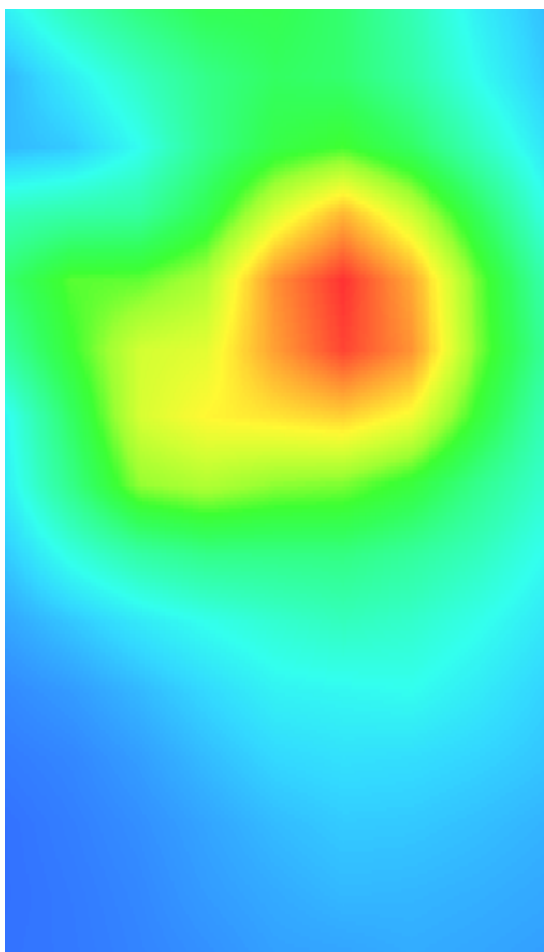
3D screen shot	Hot spot position
	

Plot 6:GPRS1900, Back, Low

Type: Phone measurement

Date of measurement: 29/06/2016

Measurement duration: 7 minutes 14 seconds

Mobile Phone IMEI number: --

A. Experimental conditions.

Area Scan	dx=8mm dy=8mm
ZoomScan	5x5x7,dx=8mm dy=8mm dz=5mm
Phantom	Validation plane
Device Position	Body
Band	GSPRS1900_3Tx
Channels	512
Signal	GPRS (Duty cycle: 1:2.67)

B. SAR Measurement Results

E-Field Probe	SATIMO SN_04/13_EP166
Frequency (MHz)	1850.2
Relative permittivity (real part)	52.84
Relative permittivity (imaginary part)	14.21
Conductivity (S/m)	1.50
Variation (%)	1.24
ConvF:	5.43

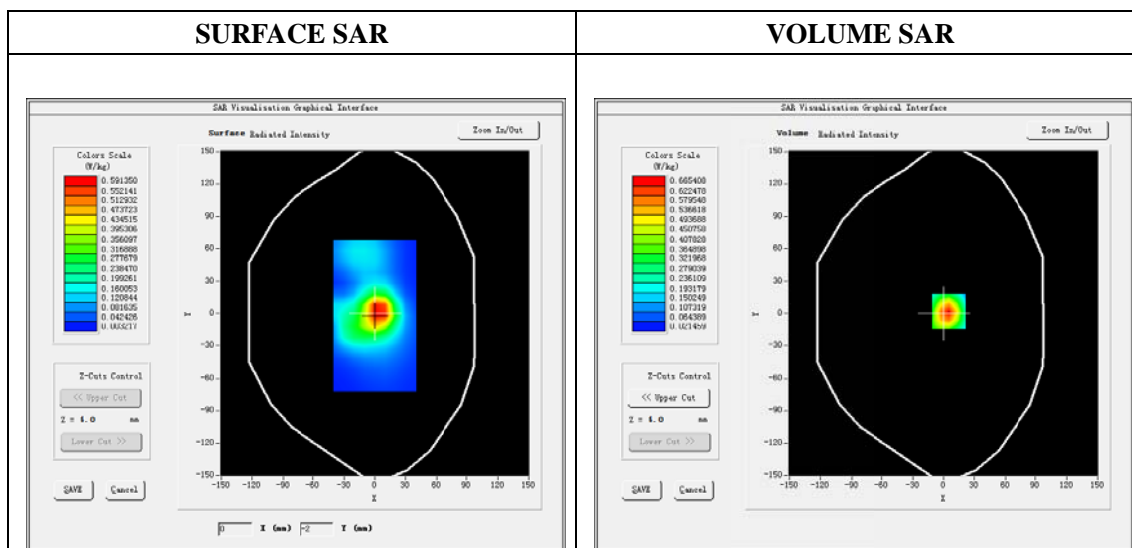

Maximum location: X=5.00, Y=2.00

SAR Peak: 0.94 W/kg

SAR 10g (W/Kg)	0.355032
SAR 1g (W/Kg)	0.668120

Z (mm)	0.00	4.00	9.00	14.00	19.00
SAR (W/Kg)	0.9290	0.6654	0.4353	0.2877	0.1943

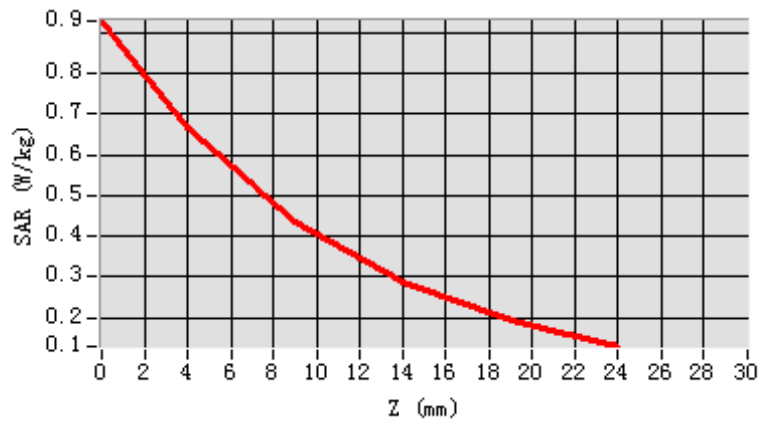

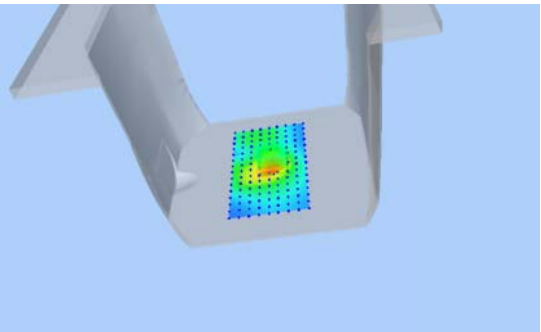
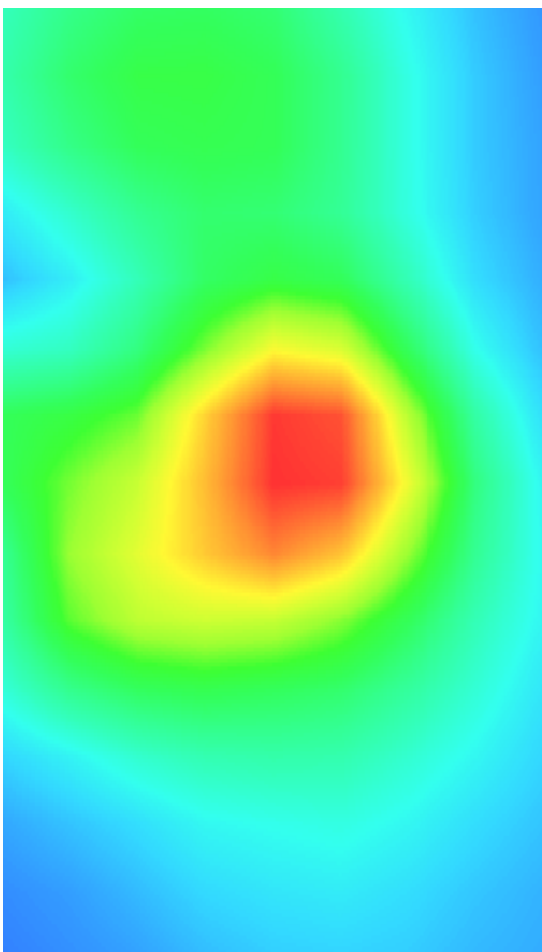
3D screen shot	Hot spot position
	

Plot 7: WCDMA850, Right Cheek, Middle

Type: Phone measurement

Date of measurement: 28/06/2016

Measurement duration: 6 minutes 31 seconds

Mobile Phone IMEI number: --

A. Experimental conditions.

Area Scan	dx=8mm dy=8mm
ZoomScan	5x5x7,dx=8mm dy=8mm dz=5mm
Phantom	Right head
Device Position	Cheek
Band	Band5_WCDMA850
Channels	4132
Signal	WCDMA (Duty cycle: 1:1)

B. SAR Measurement Results

E-Field Probe	SATIMO SN_04/13_EP166
Frequency (MHz)	826.4
Relative permittivity (real part)	41.32
Relative permittivity (imaginary part)	18.97
Conductivity (S/m)	0.88
Variation (%)	-0.09
ConvF:	5.69

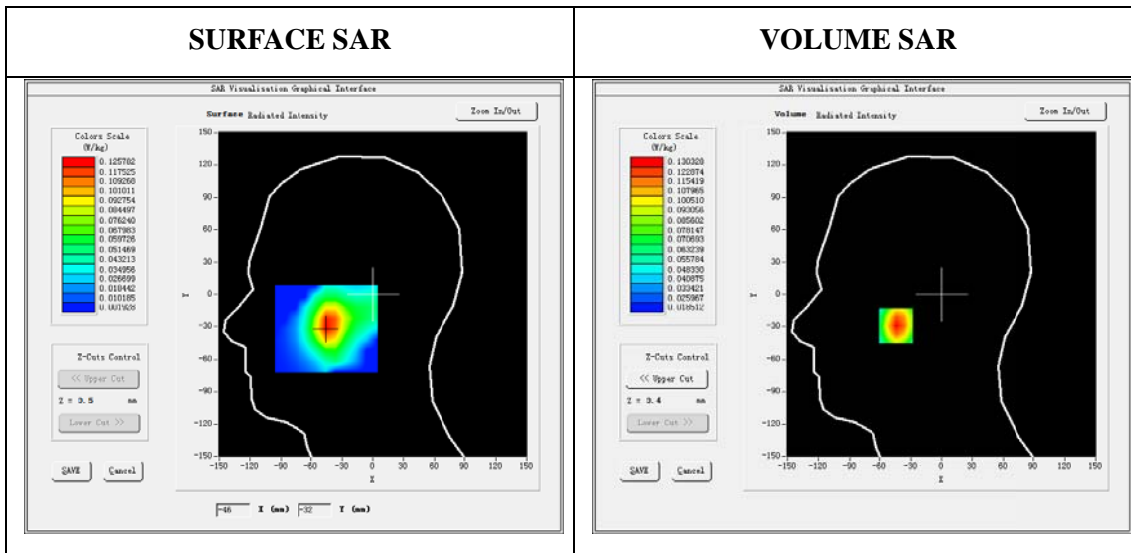

Maximum location: X=-44.00, Y=-29.00

SAR Peak: 0.16 W/kg

SAR 10g (W/Kg)	0.086643
SAR 1g (W/Kg)	0.124008

Z (mm)	0.00	4.00	9.00	14.00	19.00
SAR (W/Kg)	0.1614	0.1303	0.1005	0.0790	0.0635

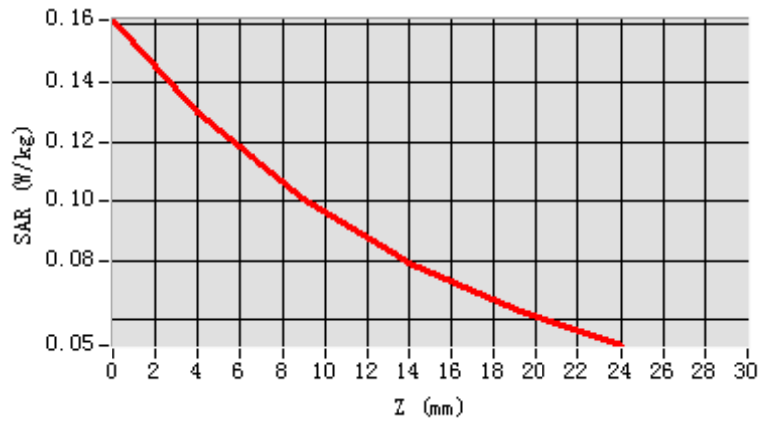

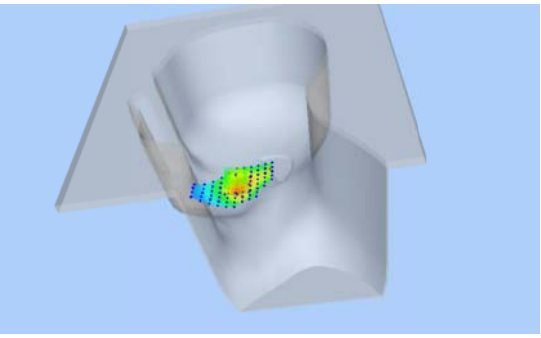
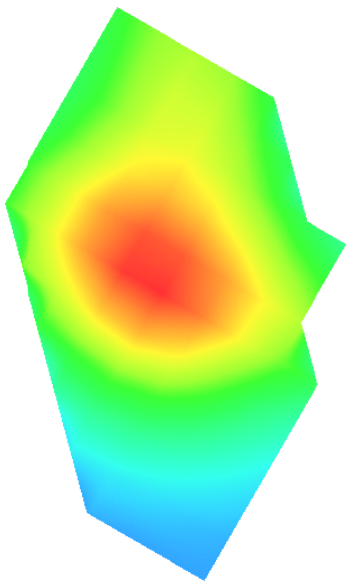
3D screen shot	Hot spot position
	

Plot 8: WCDMA850, Back, Middle

Type: Phone measurement
 Date of measurement: 28/06/2016
 Measurement duration: 7 minutes 17 seconds
 Mobile Phone IMEI number: --

A. Experimental conditions.

Area Scan	dx=8mm dy=8mm
ZoomScan	5x5x7,dx=8mm dy=8mm dz=5mm
Phantom	Validation plane
Device Position	Back
Band	Band5_WCDMA850
Channels	4132
Signal	WCDMA (Duty cycle: 1:1)

B. SAR Measurement Results

E-Field Probe	SATIMO SN_04/13_EP166
Frequency (MHz)	826.4
Relative permittivity (real part)	54.82
Relative permittivity (imaginary part)	20.48
Conductivity (S/m)	0.95
Variation (%)	-0.24
ConvF:	5.82

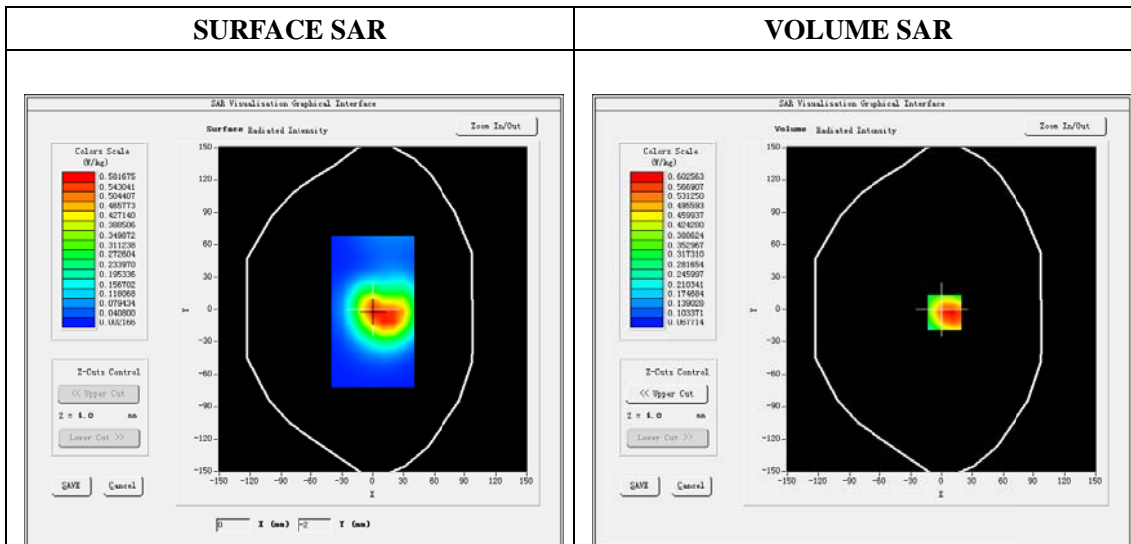

Maximum location: X=3.00, Y=-3.00
 SAR Peak: 0.78 W/kg

SAR 10g (W/Kg)	0.398587
SAR 1g (W/Kg)	0.577940

Z (mm)	0.00	4.00	9.00	14.00	19.00
SAR (W/Kg)	0.7526	0.5910	0.4372	0.3270	0.2480

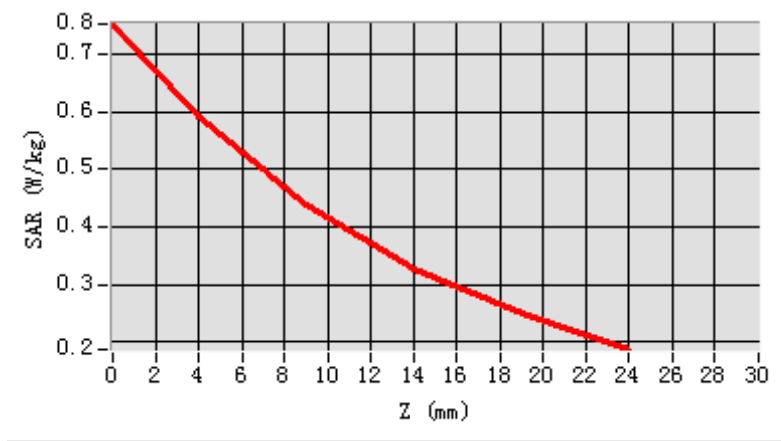

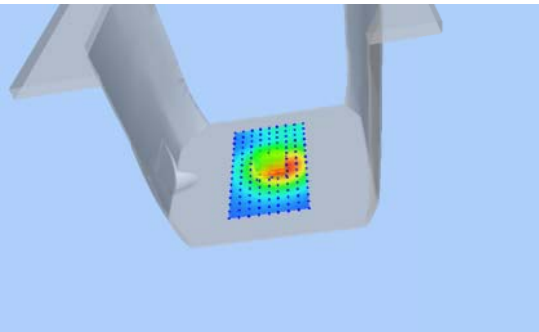
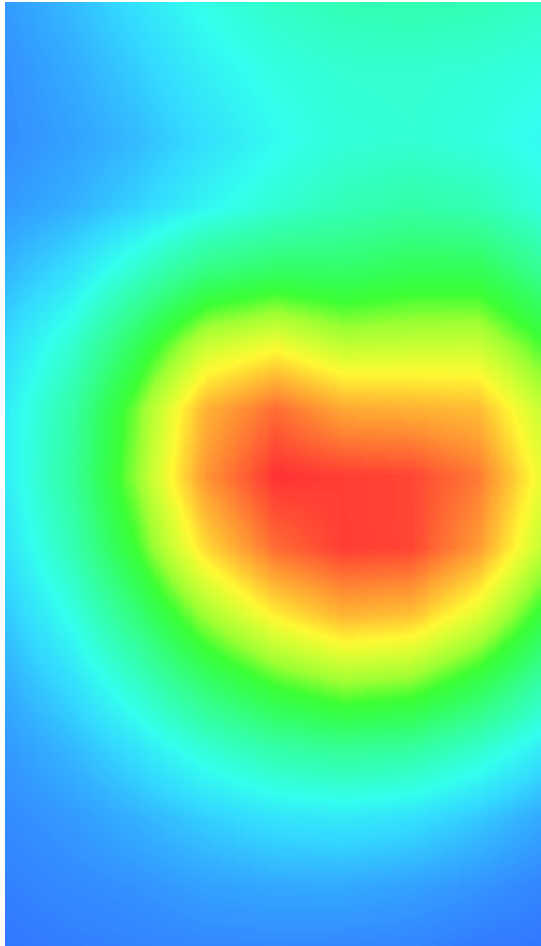
3D screen shot	Hot spot position
	

Plot 9: WCDMA1900, Right Cheek, High

Type: Phone measurement

Date of measurement: 29/06/2016

Measurement duration: 6 minutes 49 seconds

Mobile Phone IMEI number: --

A. Experimental conditions.

Area Scan	dx=8mm dy=8mm
ZoomScan	5x5x7,dx=8mm dy=8mm dz=5mm
Phantom	Validation plane
Device Position	Left head
Band	Cheek
Channels	9538
Signal	WCDMA (Duty cycle: 1:1)

B. SAR Measurement Results

E-Field Probe	SATIMO SN_04/13_EP166
Frequency (MHz)	1907.6
Relative permittivity (real part)	39.85
Relative permittivity (imaginary)	13.17
Conductivity (S/m)	1.39
Variation (%)	-1.88
ConvF:	5.25

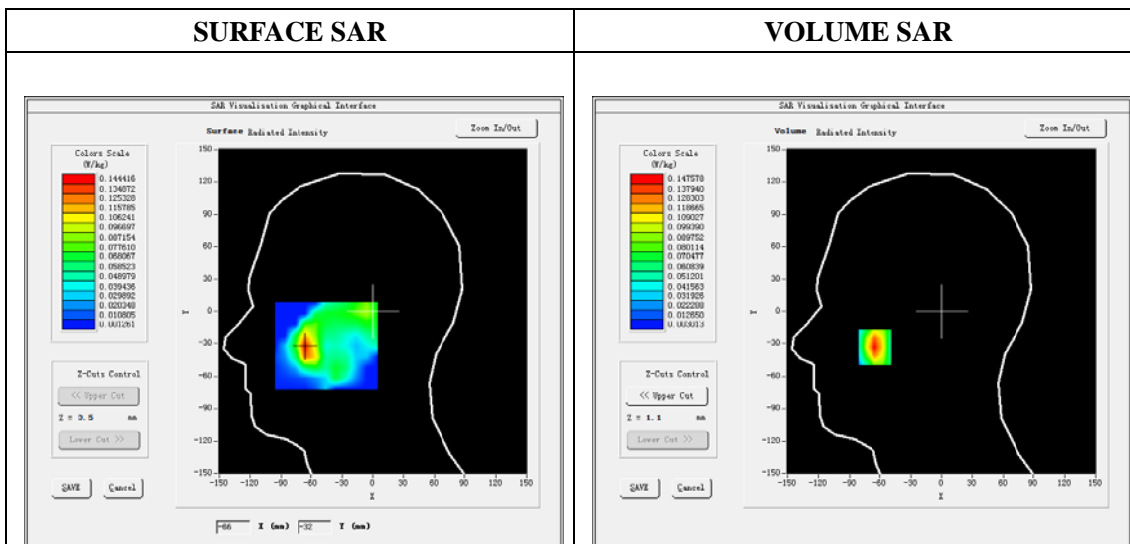

Maximum location: X=-65.00, Y=-33.00

SAR Peak: 0.21 W/kg

SAR 10g (W/Kg)	0.075953
SAR 1g (W/Kg)	0.136114

Z (mm)	0.00	4.00	9.00	14.00	19.00
SAR (W/Kg)	0.2107	0.1476	0.0929	0.0582	0.0365

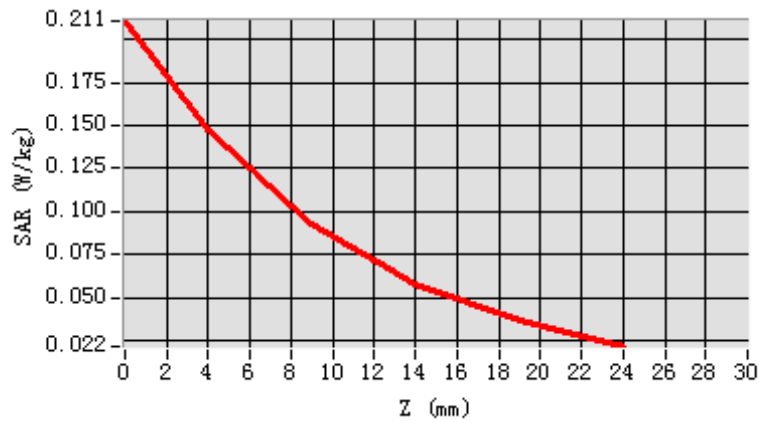

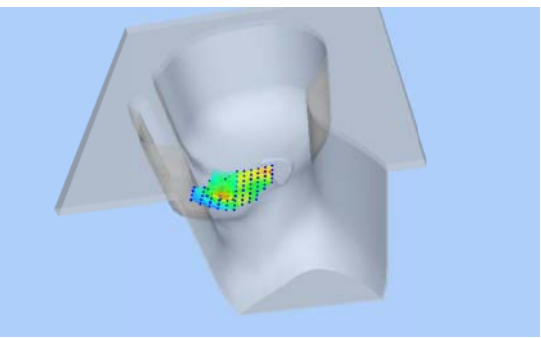
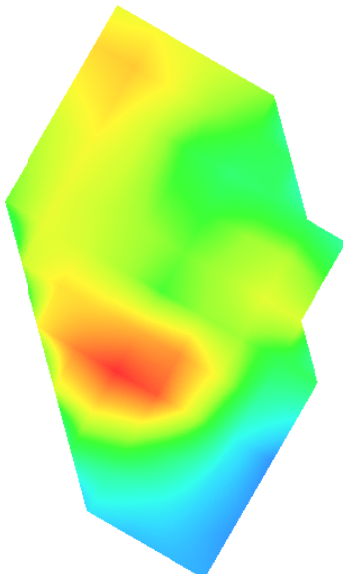
3D screen shot	Hot spot position
	

Plot 10:WCDMA1900, Back, High

Type: Phone measurement

Date of measurement: 29/06/2016

Measurement duration: 7 minutes 13 seconds

Mobile Phone IMEI number: --

A. Experimental conditions.

Area Scan	dx=8mm dy=8mm
ZoomScan	5x5x7,dx=8mm dy=8mm dz=5mm
Phantom	Validation plane
Device Position	Body
Band	Band2_WCDMA1900
Channels	9538
Signal	WCDMA (Duty cycle: 1:1)

B. SAR Measurement Results

E-Field Probe	SATIMO SN_04/13_EP166
Frequency (MHz)	1907.6
Relative permittivity (real part)	52.88
Relative permittivity (imaginary)	14.21
Conductivity (S/m)	1.50
Variation (%)	-0.08
ConvF:	5.43

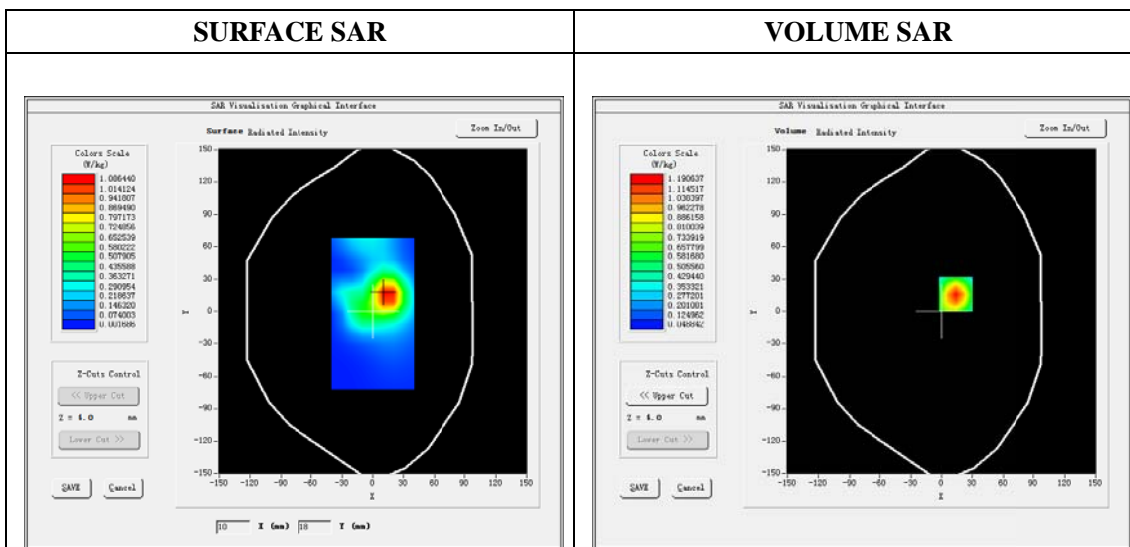

Maximum location: X=14.00, Y=16.00

SAR Peak: 1.69 W/kg

SAR 10g (W/Kg)	0.601878
SAR 1g (W/Kg)	1.053034

Z (mm)	0.00	4.00	9.00	14.00	19.00
SAR (W/Kg)	1.6855	1.1906	0.7621	0.4898	0.3195

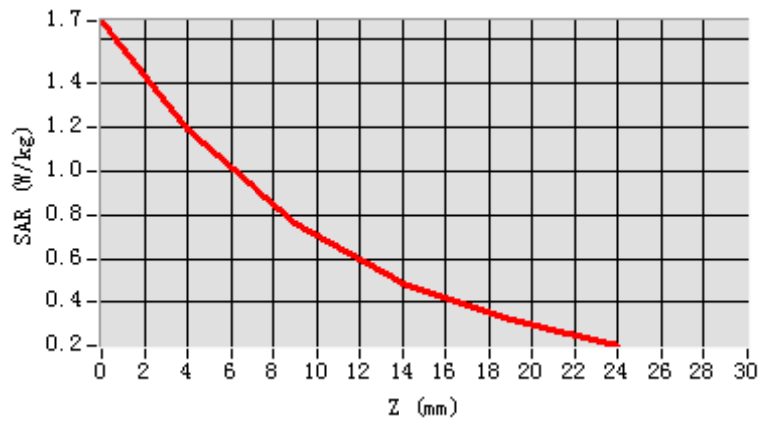

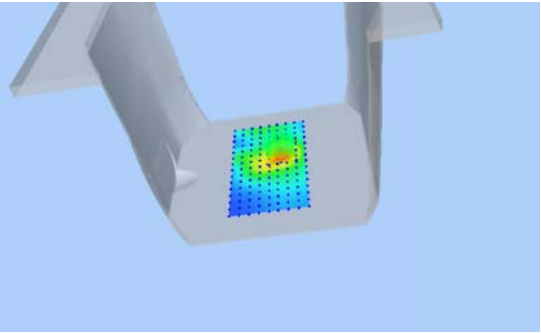
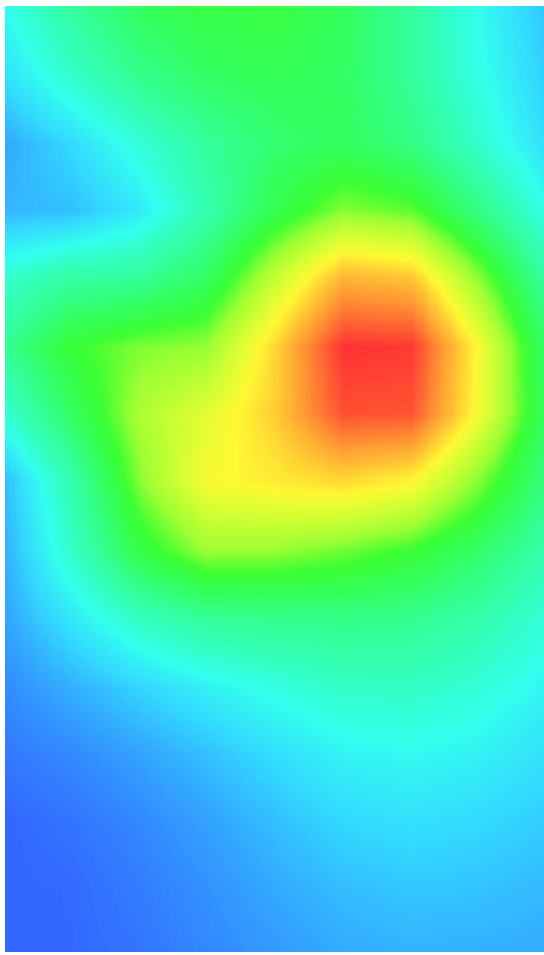
3D screen shot	Hot spot position
	

Plot 11: Wi-Fi 802.11b ,Right Cheek, High

Type: Phone measurement (11 points in the volume)

Date of measurement: 29/06/2016

Measurement duration: 7 minutes 00 seconds

Mobile Phone IMEI number: --

A. Experimental conditions.

Area Scan	dx=8mm dy=8mm
ZoomScan	7x7x8,dx=5mm dy=5mm dz=4mm
Phantom	Right head
Device Position	Cheek
Band	IEEE 802.11b ISM
Channels	11
Signal	DSSS (Crest factor: 1:1)

B. SAR Measurement Results

E-Field Probe	SATIMO SN_04/13_EP166
Frequency (MHz)	2462
Relative permittivity (real part)	38.96
Relative permittivity (imaginary part)	13.22
Conductivity (S/m)	1.80
Variation (%)	-1.19
ConvF:	4.93

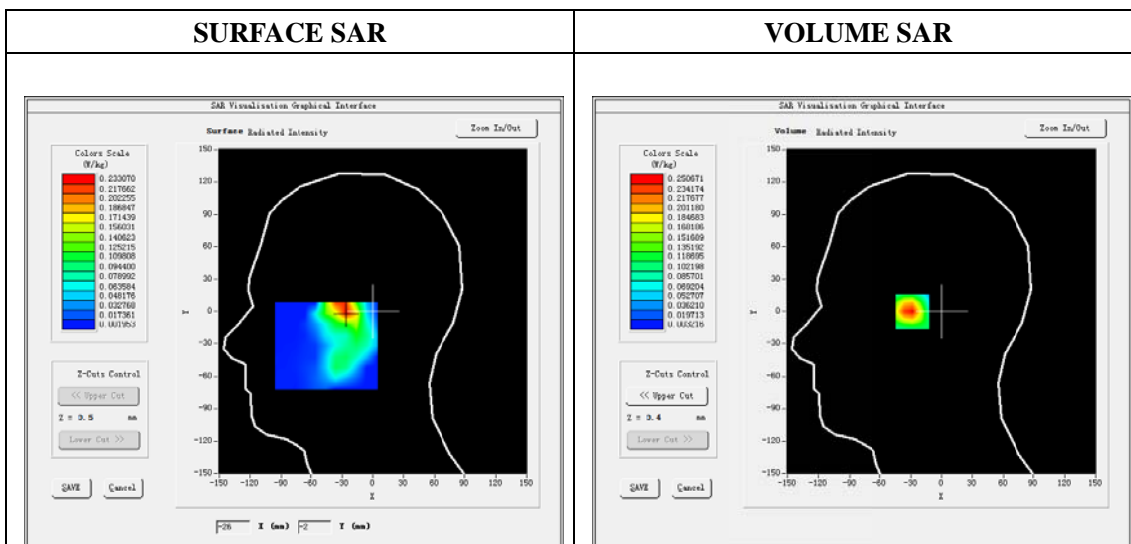

Maximum location: X=-26.00, Y=1.00
SAR Peak: 0.41 W/kg

SAR 10g (W/Kg)	0.117778
SAR 1g (W/Kg)	0.234961

Z (mm)	0.00	4.00	9.00	14.00	19.00
SAR (W/Kg)	0.4047	0.2507	0.1329	0.0703	0.0388

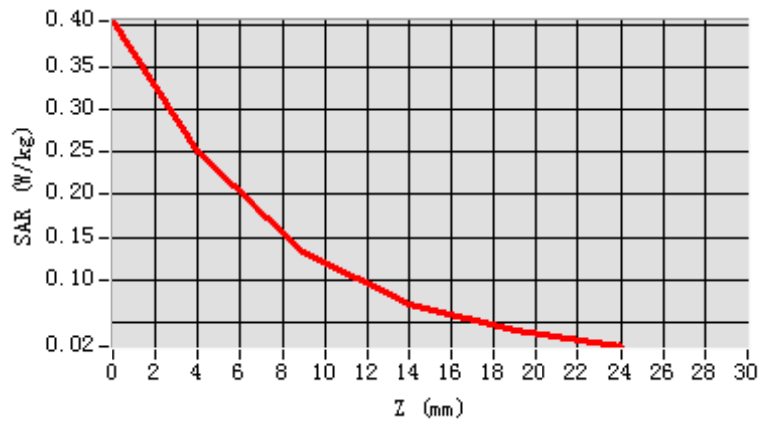

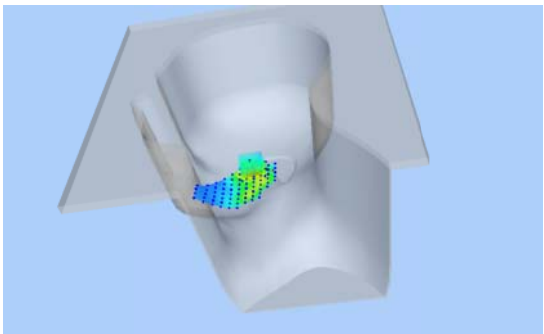
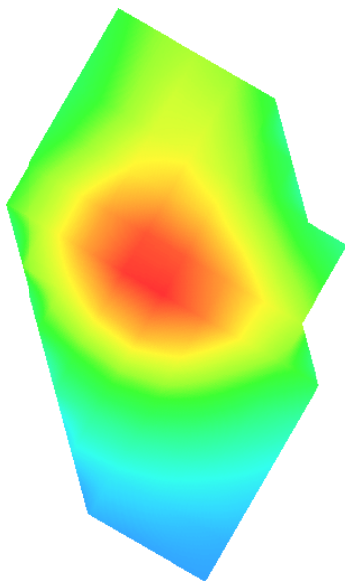
3D screen shot	Hot spot position
	

Plot 12: Wi-Fi 802.11b , Back, High

Type: Phone measurement
 Date of measurement: 29/06/2016
 Measurement duration: 7 minutes 11 seconds
 Mobile Phone IMEI number: --

A. Experimental conditions.

Area Scan	dx=8mm dy=8mm
ZoomScan	7x7x8,dx=5mm dy=5mm dz=4mm
Phantom	Validation plane
Device Position	Body
Band	IEEE 802.11b
Channels	11
Signal	DSSS (Crest factor: 1:1)

B. SAR Measurement Results

E-Field Probe	SATIMO SN_04/13_EP166
Frequency (MHz)	2462
Relative permittivity (real part)	52.47
Relative permittivity (imaginary part)	14.25
Conductivity (S/m)	1.94
Variation (%)	-0.22
ConvF:	5.09

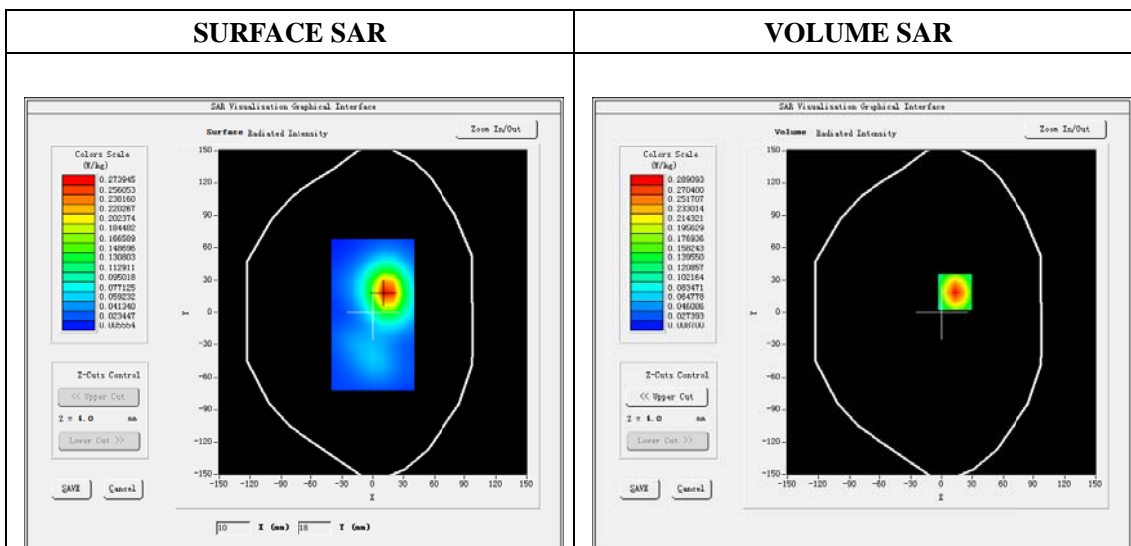

Maximum location: X=13.00, Y=19.00
 SAR Peak: 0.45 W/kg

SAR 10g (W/Kg)	0.142969
SAR 1g (W/Kg)	0.268568

Z (mm)	0.00	4.00	9.00	14.00	19.00
SAR (W/Kg)	0.4483	0.2891	0.1624	0.0909	0.0522

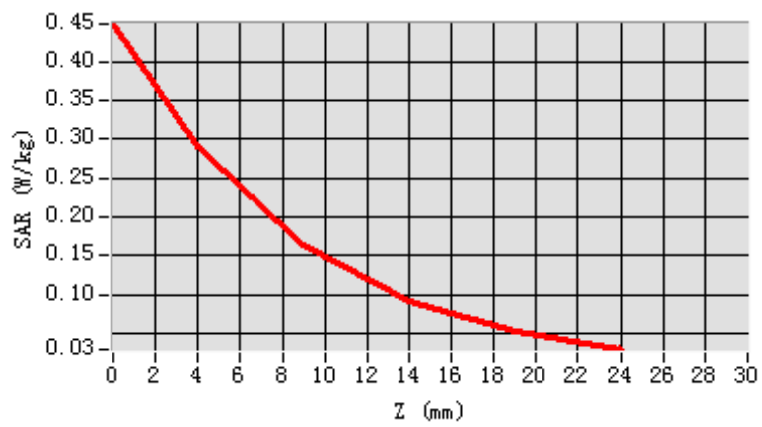

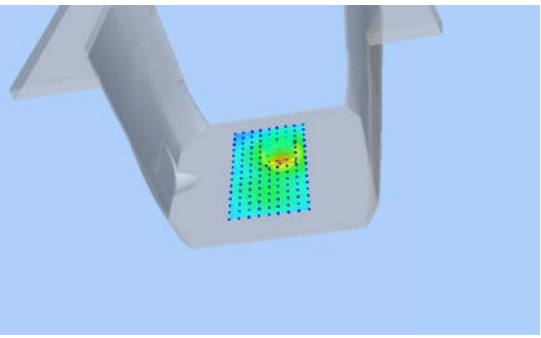
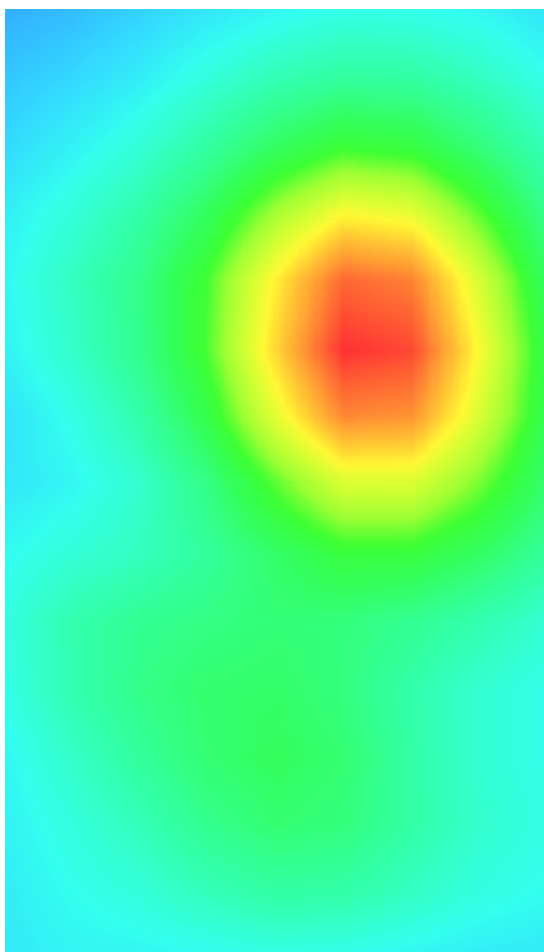
3D screen shot	Hot spot position
	

Plot 13:RFID, Edge A, Middle

Type: Phone measurement

Date of measurement: 19/08/2016

Measurement duration: 6minutes 53 seconds

Mobile Phone IMEI number: --

A. Experimental conditions.

Area Scan	dx=8mm dy=8mm
ZoomScan	5x5x7,dx=8mm dy=8mm dz=5mm
Phantom	Validation plane
Device Position	Body
Band	RFID
Channels	Middle
Signal	RFID

B. SAR Measurement Results

E-Field Probe	SN43/15 EP276
Frequency (MHz)	915.25
Relative permittivity (real part)	55.26
Relative permittivity (imaginary part)	21.71
Conductivity (S/m)	1.04
Variation (%)	1.53
ConvF:	6.28

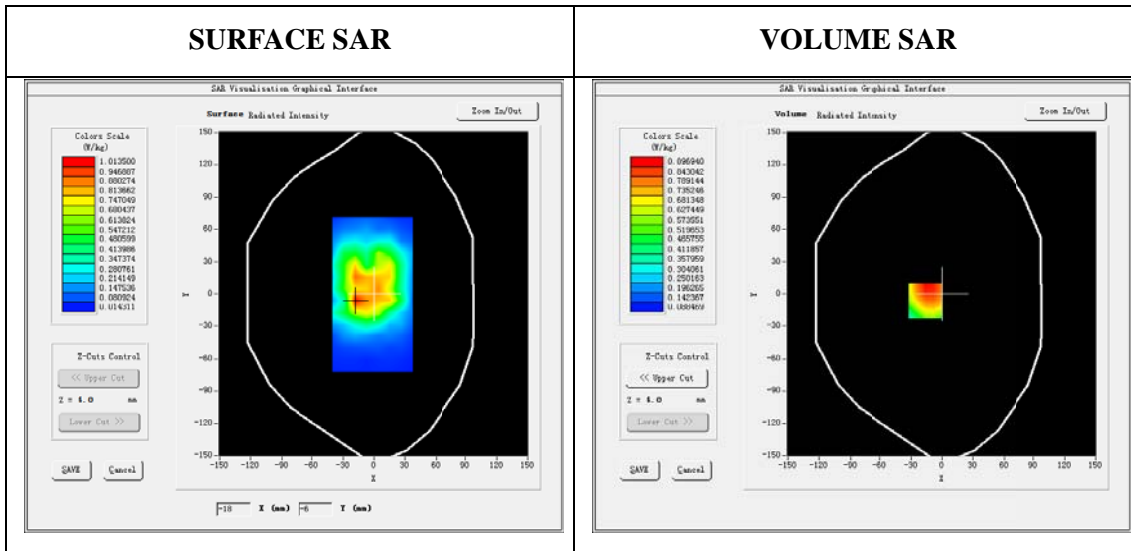

Maximum location: X=-16.00, Y=-6.00
SAR Peak: 1.16 W/kg

SAR 10g (W/Kg)	0.408637
SAR 1g (W/Kg)	0.655328

Z (mm)	0.00	4.00	9.00	14.00	19.00
SAR (W/Kg)	3.2554	0.8969	0.4114	0.4838	0.2236

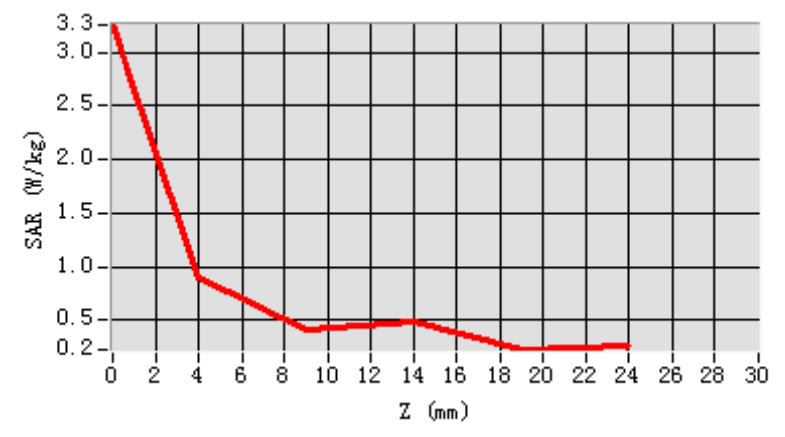

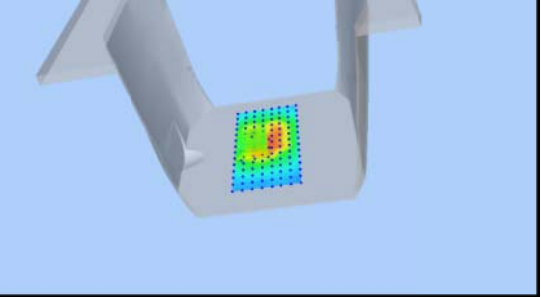
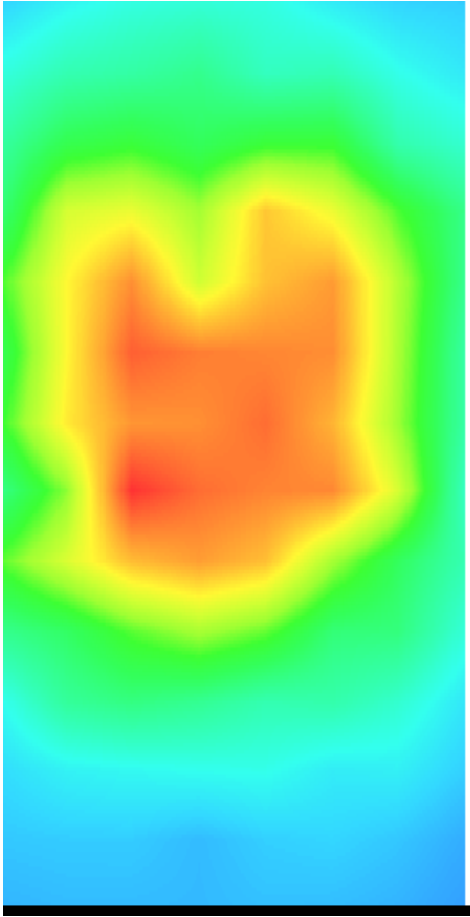
3D screen shot	Hot spot position
	



ANNEX D

of

CCIC-SET

CONFORMANCE TEST REPORT FOR

HUMAN EXPOSURE TO ELECTROMAGNETIC FIELDS

SET2016-11240

Connected Handheld RFID Reader

Type Name: ALR-H450

Hardware Version: C4050_MB_V5.0

Software Version: V1.0.0_10040006582_20151221

Calibration Certificate of Probe and Dipoles

This Annex consists of 70 pages

Date of Report: 2016-08-26

Probe Calibration Certificate

**COMOSAR E-Field Probe Calibration Report**

Ref.: ACR.227.15.14.SATU.A

**CCIC SOUTHERN ELECTRONIC PRODUCT
TESTING (SHENZHEN) CO., LTD
ELECTRONIC TESTING BUILDING, SHAHE ROAD, XILI
TOWN
SHENZHEN, P.R. CHINA (POST CODE:518055)
SATIMO COMOSAR DOSIMETRIC E-FIELD PROBE
SERIAL NO.: SN 04/13 EP166**

Calibrated at SATIMO US
2105 Barrett Park Dr. - Kennesaw, GA 30144



08/10/2015

Summary:

This document presents the method and results from an accredited COMOSAR Dosimetric E-Field Probe calibration performed in SATIMO USA using the CALISAR / CALIBAIR test bench, for use with a SATIMO COMOSAR system only. All calibration results are traceable to national metrology institutions.



	<i>Name</i>	<i>Function</i>	<i>Date</i>	<i>Signature</i>
<i>Prepared by :</i>	Jérôme LUC	Product Manager	8/11/2015	<i>JS</i>
<i>Checked by :</i>	Jérôme LUC	Product Manager	8/11/2015	<i>JS</i>
<i>Approved by :</i>	Kim RUTKOWSKI	Quality Manager	8/11/2015	<i>Kim Rutkowski</i>

	<i>Customer Name</i>
<i>Distribution :</i>	CCIC SOUTHERN ELECTRONIC PRODUCT TESTING (SHENZHEN) Co., Ltd

<i>Issue</i>	<i>Date</i>	<i>Modifications</i>
A	8/11/2015	Initial release

Page: 2/9

*This document shall not be reproduced, except in full or in part, without the written approval of SATIMO.
The information contained herein is to be used only for the purpose for which it is submitted and is not to
be released in whole or part without written approval of SATIMO.*



TABLE OF CONTENTS

1 Device Under Test 4

2 Product Description 4

 2.1 General Information 4

3 Measurement Method 4

 3.1 Linearity 4

 3.2 Sensitivity 5

 3.3 Lower Detection Limit 5

 3.4 Isotropy 5

 3.5 Boundary Effect 5

4 Measurement Uncertainty 5

5 Calibration Measurement Results 6

 5.1 Sensitivity in air 6

 5.2 Linearity 7

 5.3 Sensitivity in liquid 7

 5.4 Isotropy 8

6 List of Equipment 9

This document shall not be reproduced, except in full or in part, without the written approval of SATIMO. The information contained herein is to be used only for the purpose for which it is submitted and is not to be released in whole or part without written approval of SATIMO.

1 DEVICE UNDER TEST

Device Under Test	
Device Type	COMOSAR DOSIMETRIC E FIELD PROBE
Manufacturer	Satimo
Model	SSE5
Serial Number	SN 04/13 EP166
Product Condition (new / used)	Used
Frequency Range of Probe	0.7 GHz-3 GHz
Resistance of Three Dipoles at Connector	Dipole 1: R1=0.231 MΩ Dipole 2: R2=0.225 MΩ Dipole 3: R3=0.228 MΩ

A yearly calibration interval is recommended.

2 PRODUCT DESCRIPTION

2.1 GENERAL INFORMATION

Satimo's COMOSAR E field Probes are built in accordance to the IEEE 1528, OET 65 Bulletin C and CEI/IEC 62209 standards.



Figure 1 – Satimo COMOSAR Dosimetric E field Dipole

Probe Length	330 mm
Length of Individual Dipoles	4.5 mm
Maximum external diameter	8 mm
Probe Tip External Diameter	5 mm
Distance between dipoles / probe extremity	2.7 mm

3 MEASUREMENT METHOD

The IEEE 1528, OET 65 Bulletin C, CENELEC EN50361 and CEI/IEC 62209 standards provide recommended practices for the probe calibrations, including the performance characteristics of interest and methods by which to assess their affect. All calibrations / measurements performed meet the fore mentioned standards.

3.1 LINEARITY

The evaluation of the linearity was done in free space using the waveguide, performing a power sweep to cover the SAR range 0.01W/kg to 100W/kg.

Page: 4/9

*This document shall not be reproduced, except in full or in part, without the written approval of SATIMO.
The information contained herein is to be used only for the purpose for which it is submitted and is not to be released in whole or part without written approval of SATIMO.*

3.2 SENSITIVITY

The sensitivity factors of the three dipoles were determined using a two step calibration method (air and tissue simulating liquid) using waveguides as outlined in the standards.

3.3 LOWER DETECTION LIMIT

The lower detection limit was assessed using the same measurement set up as used for the linearity measurement. The required lower detection limit is 10 mW/kg.

3.4 ISOTROPY

The axial isotropy was evaluated by exposing the probe to a reference wave from a standard dipole with the dipole mounted under the flat phantom in the test configuration suggested for system validations and checks. The probe was rotated along its main axis from 0 - 360 degrees in 15 degree steps. The hemispherical isotropy is determined by inserting the probe in a thin plastic box filled with tissue-equivalent liquid, with the plastic box illuminated with the fields from a half wave dipole. The dipole is rotated about its axis (0°-180°) in 15° increments. At each step the probe is rotated about its axis (0°-360°).

3.5 BOUNDARY EFFECT

The boundary effect is defined as the deviation between the SAR measured data and the expected exponential decay in the liquid when the probe is oriented normal to the interface. To evaluate this effect, the liquid filled flat phantom is exposed to fields from either a reference dipole or waveguide. With the probe normal to the phantom surface, the peak spatial average SAR is measured and compared to the analytical value at the surface.

4 MEASUREMENT UNCERTAINTY

The guidelines outlined in the IEEE 1528, OET 65 Bulletin C, CENELEC EN50361 and CEI/IEC 62209 standards were followed to generate the measurement uncertainty associated with an E-field probe calibration using the waveguide technique. All uncertainties listed below represent an expanded uncertainty expressed at approximately the 95% confidence level using a coverage factor of $k=2$, traceable to the Internationally Accepted Guides to Measurement Uncertainty.

Uncertainty analysis of the probe calibration in waveguide					
ERROR SOURCES	Uncertainty value (%)	Probability Distribution	Divisor	ci	Standard Uncertainty (%)
Incident or forward power	3.00%	Rectangular	$\sqrt{3}$	1	1.732%
Reflected power	3.00%	Rectangular	$\sqrt{3}$	1	1.732%
Liquid conductivity	5.00%	Rectangular	$\sqrt{3}$	1	2.887%
Liquid permittivity	4.00%	Rectangular	$\sqrt{3}$	1	2.309%
Field homogeneity	3.00%	Rectangular	$\sqrt{3}$	1	1.732%
Field probe positioning	5.00%	Rectangular	$\sqrt{3}$	1	2.887%
Field probe linearity	3.00%	Rectangular	$\sqrt{3}$	1	1.732%

Page: 5/9

*This document shall not be reproduced, except in full or in part, without the written approval of SATIMO.
The information contained herein is to be used only for the purpose for which it is submitted and is not to be released in whole or part without written approval of SATIMO.*

Combined standard uncertainty					5.831%
Expanded uncertainty 95 % confidence level k = 2					12.0%

5 CALIBRATION MEASUREMENT RESULTS

Calibration Parameters	
Liquid Temperature	21 °C
Lab Temperature	21 °C
Lab Humidity	45 %

5.1 SENSITIVITY IN AIR

Normx dipole 1 ($\mu\text{V}/(\text{V}/\text{m})^2$)	Normy dipole 2 ($\mu\text{V}/(\text{V}/\text{m})^2$)	Normz dipole 3 ($\mu\text{V}/(\text{V}/\text{m})^2$)
8.57	4.83	7.15

DCP dipole 1 (mV)	DCP dipole 2 (mV)	DCP dipole 3 (mV)
92	90	95

Calibration curves $e_i=f(V)$ ($i=1,2,3$) allow to obtain H-field value using the formula:

$$E = \sqrt{E_1^2 + E_2^2 + E_3^2}$$

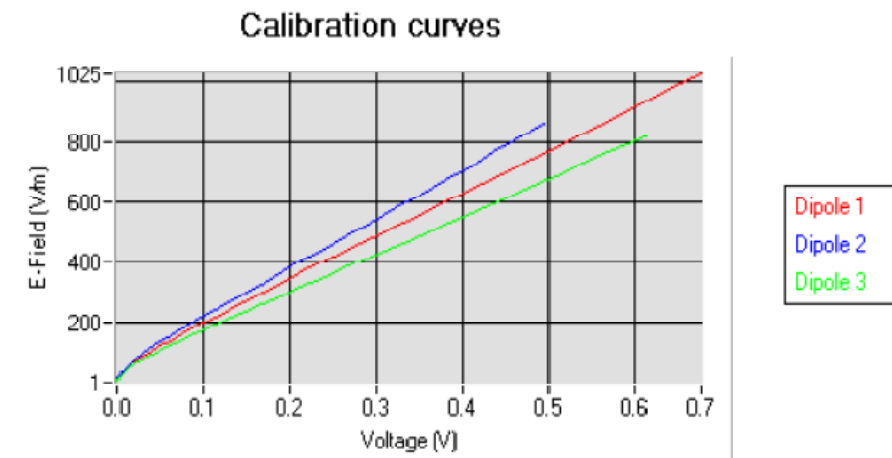

Page: 6/9

This document shall not be reproduced, except in full or in part, without the written approval of SATIMO. The information contained herein is to be used only for the purpose for which it is submitted and is not to be released in whole or part without written approval of SATIMO.

5.2 LINEARITY

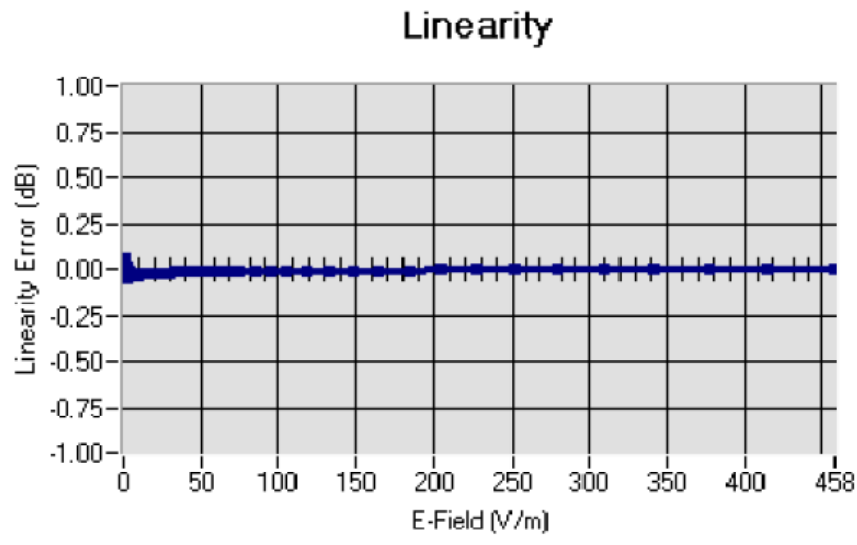

Linearity: $\pm 1.55\%$ ($\pm 0.07\text{dB}$)

5.3 SENSITIVITY IN LIQUID

Liquid	Frequency (MHz +/- 100MHz)	Permittivity	Epsilon (S/m)	ConvF
HL850	835	42.80	0.89	5.69
BL850	835	53.45	0.96	5.82
HL900	900	42.47	0.96	5.34
BL900	900	56.68	1.08	5.55
HL1800	1800	41.30	1.38	4.75
BL1800	1800	53.27	1.51	4.96
HL1900	1900	41.09	1.42	5.25
BL1900	1900	54.20	1.54	5.43
HL2000	2000	39.72	1.43	4.81
BL2000	2000	53.90	1.53	4.95
HL2450	2450	39.05	1.77	4.93
BL2450	2450	52.98	1.93	5.09
HL2600	2600	38.35	1.92	5.08
BL2600	2600	51.82	2.19	5.22

LOWER DETECTION LIMIT: 7mW/kg

Page: 7/9

This document shall not be reproduced, except in full or in part, without the written approval of SATIMO. The information contained herein is to be used only for the purpose for which it is submitted and is not to be released in whole or part without written approval of SATIMO.

5.4 ISOTROPY

HL900 MHz

- Axial isotropy: 0.04 dB
- Hemispherical isotropy: 0.07 dB

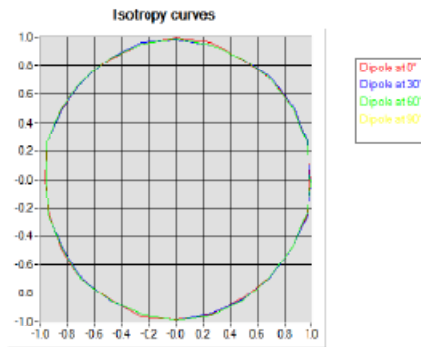

HL1300 MHz

- Axial isotropy: 0.05 dB
- Hemispherical isotropy: 0.07 dB

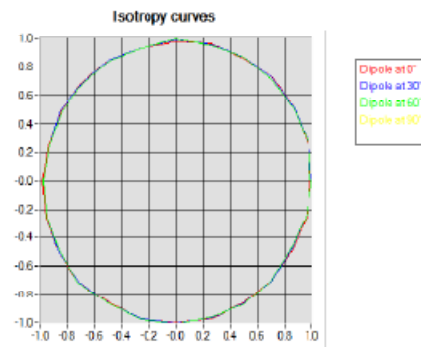

**6 LIST OF EQUIPMENT**

Equipment Summary Sheet				
Equipment Description	Manufacturer / Model	Identification No.	Current Calibration Date	Next Calibration Date
Flat Phantom	Satimo	SN-20/09-SAM71	Validated. No cal required.	Validated. No cal required.
COMOSAR Test Bench	Version 3	NA	Validated. No cal required.	Validated. No cal required.
Network Analyzer	Rhode & Schwarz ZVA	SN100132	02/2013	02/2016
Reference Probe	Satimo	EP 94 SN 37/08	10/2014	10/2015
Multimeter	Keithley 2000	1188656	12/2013	12/2016
Signal Generator	Agilent E4438C	MY49070581	12/2013	12/2016
Amplifier	Aethercomm	SN 046	Characterized prior to test. No cal required.	Characterized prior to test. No cal required.
Power Meter	HP E4418A	US38261498	12/2013	12/2016
Power Sensor	HP ECP-E26A	US37181460	12/2013	12/2016
Directional Coupler	Narda 4216-20	01386	Characterized prior to test. No cal required.	Characterized prior to test. No cal required.
Waveguide	Mega Industries	069Y7-158-13-712	Validated. No cal required.	Validated. No cal required.
Waveguide Transition	Mega Industries	069Y7-158-13-701	Validated. No cal required.	Validated. No cal required.
Waveguide Termination	Mega Industries	069Y7-158-13-701	Validated. No cal required.	Validated. No cal required.
Temperature / Humidity Sensor	Control Company	11-661-9	8/2013	8/2016

Page: 9/9

This document shall not be reproduced, except in full or in part, without the written approval of SATIMO. The information contained herein is to be used only for the purpose for which it is submitted and is not to be released in whole or part without written approval of SATIMO.



COMOSAR E-Field Probe Calibration Report

Ref : ACR.344.2.15.SATU.A

**CCIC SOUTHERN ELECTRONIC PRODUCT
TESTING (SHENZHEN) CO., LTD**
ELECTRONIC TESTING BUILDING, SHAHE ROAD, XILI
TOWN
SHENZHEN, P.R. CHINA (POST CODE:518055)
MVG COMOSAR DOSIMETRIC E-FIELD PROBE
SERIAL NO.: SN 43/15 EP276

Calibrated at MVG US
2105 Barrett Park Dr. - Kennesaw, GA 30144



Calibration Date: 12/09/15

Summary:

This document presents the method and results from an accredited COMOSAR Dosimetric E-Field Probe calibration performed in MVG USA using the CALISAR / CALIBAIR test bench, for use with a COMOSAR system only. All calibration results are traceable to national metrology institutions.



COMOSAR E-FIELD PROBE CALIBRATION REPORT

Ref: ACR.344.0.15.SATU.A

	<i>Name</i>	<i>Function</i>	<i>Date</i>	<i>Signature</i>
<i>Prepared by :</i>	Jérôme LUC	Product Manager	12/10/2015	<i>JS</i>
<i>Checked by :</i>	Jérôme LUC	Product Manager	12/10/2015	<i>JS</i>
<i>Approved by :</i>	Kim RUTKOWSKI	Quality Manager	12/10/2015	<i>Kim Rutkowski</i>

Customer Name

 CCIC SOUTHERN
 ELECTRONIC
 PRODUCT
Distribution : TESTING
 (SHENZHEN) Co.,
 Ltd

<i>Issue</i>	<i>Date</i>	<i>Modifications</i>
A	12/10/2015	Initial release

Page: 2/9

*This document shall not be reproduced, except in full or in part, without the written approval of MVG.
 The information contained herein is to be used only for the purpose for which it is submitted and is not to
 be released in whole or part without written approval of MVG.*



TABLE OF CONTENTS

1 Device Under Test 4

2 Product Description 4

 2.1 General Information 4

3 Measurement Method 4

 3.1 Linearity 4

 3.2 Sensitivity 5

 3.3 Lower Detection Limit 5

 3.4 Isotropy 5

 3.5 Boundary Effect 5

4 Measurement Uncertainty 5

5 Calibration Measurement Results 6

 5.1 Sensitivity in air 6

 5.2 Linearity 7

 5.3 Sensitivity in liquid 7

 5.4 Isotropy 8

6 List of Equipment 9

This document shall not be reproduced, except in full or in part, without the written approval of MVG. The information contained herein is to be used only for the purpose for which it is submitted and is not to be released in whole or part without written approval of MVG.



1 DEVICE UNDER TEST

Device Under Test	
Device Type	COMOSAR DOSIMETRIC E FIELD PROBE
Manufacturer	MVG
Model	SSE5
Serial Number	SN 43/15 EP276
Product Condition (new / used)	New
Frequency Range of Probe	0.7 GHz-3GHz
Resistance of Three Dipoles at Connector	Dipole 1: R1=0.211 MΩ Dipole 2: R2=0.206 MΩ Dipole 3: R3=0.211 MΩ

A yearly calibration interval is recommended.

2 PRODUCT DESCRIPTION

2.1 GENERAL INFORMATION

MVG's COMOSAR E field Probes are built in accordance to the IEEE 1528, OET 65 Bulletin C and CEI/IEC 62209 standards.



Figure 1 – MVG COMOSAR Dosimetric E field Dipole

Probe Length	330 mm
Length of Individual Dipoles	4.5 mm
Maximum external diameter	8 mm
Probe Tip External Diameter	5 mm
Distance between dipoles / probe extremity	2.7 mm

3 MEASUREMENT METHOD

The IEEE 1528, OET 65 Bulletin C, CENELEC EN50361 and CEI/IEC 62209 standards provide recommended practices for the probe calibrations, including the performance characteristics of interest and methods by which to assess their affect. All calibrations / measurements performed meet the fore mentioned standards.

3.1 LINEARITY

The evaluation of the linearity was done in free space using the waveguide, performing a power sweep to cover the SAR range 0.01W/kg to 100W/kg.

Page: 4/9

*This document shall not be reproduced, except in full or in part, without the written approval of MVG.
The information contained herein is to be used only for the purpose for which it is submitted and is not to be released in whole or part without written approval of MVG.*



3.2 SENSITIVITY

The sensitivity factors of the three dipoles were determined using a two step calibration method (air and tissue simulating liquid) using waveguides as outlined in the standards.

3.3 LOWER DETECTION LIMIT

The lower detection limit was assessed using the same measurement set up as used for the linearity measurement. The required lower detection limit is 10 mW/kg.

3.4 ISOTROPY

The axial isotropy was evaluated by exposing the probe to a reference wave from a standard dipole with the dipole mounted under the flat phantom in the test configuration suggested for system validations and checks. The probe was rotated along its main axis from 0 - 360 degrees in 15 degree steps. The hemispherical isotropy is determined by inserting the probe in a thin plastic box filled with tissue-equivalent liquid, with the plastic box illuminated with the fields from a half wave dipole. The dipole is rotated about its axis (0°–180°) in 15° increments. At each step the probe is rotated about its axis (0°–360°).

3.5 BOUNDARY EFFECT

The boundary effect is defined as the deviation between the SAR measured data and the expected exponential decay in the liquid when the probe is oriented normal to the interface. To evaluate this effect, the liquid filled flat phantom is exposed to fields from either a reference dipole or waveguide. With the probe normal to the phantom surface, the peak spatial average SAR is measured and compared to the analytical value at the surface.

4 MEASUREMENT UNCERTAINTY

The guidelines outlined in the IEEE 1528, OET 65 Bulletin C, CENELEC EN50361 and CEI/IEC 62209 standards were followed to generate the measurement uncertainty associated with an E-field probe calibration using the waveguide technique. All uncertainties listed below represent an expanded uncertainty expressed at approximately the 95% confidence level using a coverage factor of $k=2$, traceable to the Internationally Accepted Guides to Measurement Uncertainty.

Uncertainty analysis of the probe calibration in waveguide					
ERROR SOURCES	Uncertainty value (%)	Probability Distribution	Divisor	ci	Standard Uncertainty (%)
Incident or forward power	3.00%	Rectangular	$\sqrt{3}$	1	1.732%
Reflected power	3.00%	Rectangular	$\sqrt{3}$	1	1.732%
Liquid conductivity	5.00%	Rectangular	$\sqrt{3}$	1	2.887%
Liquid permittivity	4.00%	Rectangular	$\sqrt{3}$	1	2.309%
Field homogeneity	3.00%	Rectangular	$\sqrt{3}$	1	1.732%
Field probe positioning	5.00%	Rectangular	$\sqrt{3}$	1	2.887%

Page: 5/9

This document shall not be reproduced, except in full or in part, without the written approval of MVG. The information contained herein is to be used only for the purpose for which it is submitted and is not to be released in whole or part without written approval of MVG.



Field probe linearity	3.00%	Rectangular	$\sqrt{3}$	1	1.732%
Combined standard uncertainty					5.831%
Expanded uncertainty 95 % confidence level k = 2					12.0%

5 CALIBRATION MEASUREMENT RESULTS

Calibration Parameters	
Liquid Temperature	21 °C
Lab Temperature	21 °C
Lab Humidity	45 %

5.1 SENSITIVITY IN AIR

Normx dipole 1 ($\mu\text{V}/(\text{V}/\text{m})^2$)	Normy dipole 2 ($\mu\text{V}/(\text{V}/\text{m})^2$)	Normz dipole 3 ($\mu\text{V}/(\text{V}/\text{m})^2$)
4.37	4.52	5.21

DCP dipole 1 (mV)	DCP dipole 2 (mV)	DCP dipole 3 (mV)
100	96	97

Calibration curves $e_i=f(V)$ ($i=1,2,3$) allow to obtain H-field value using the formula:

$$E = \sqrt{E_1^2 + E_2^2 + E_3^2}$$

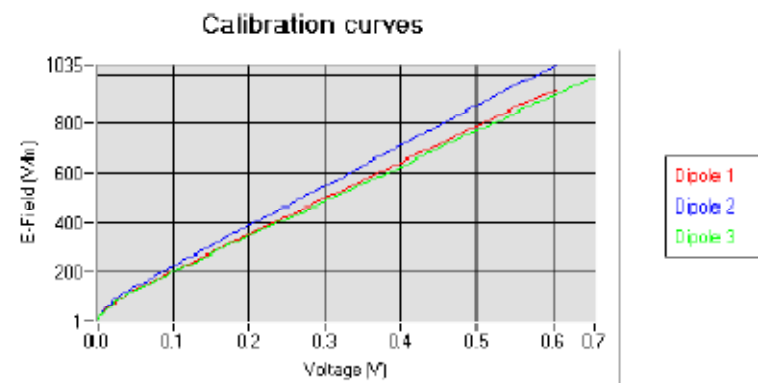

Page: 6/9

This document shall not be reproduced, except in full or in part, without the written approval of MVG. The information contained herein is to be used only for the purpose for which it is submitted and is not to be released in whole or part without written approval of MVG.



5.2 LINEARITY

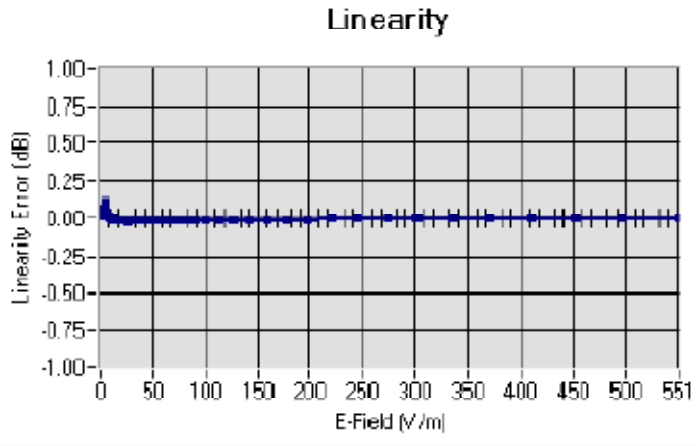

Linearity: \pm 2.48% (\pm 0.11 dB)

5.3 SENSITIVITY IN LIQUID

Liquid	Frequency (MHz +/- 100MHz)	Permittivity	Epsilon (S/m)	ConvF
HL750	750	42.24	0.90	5.96
BL750	750	56.85	0.99	6.13
HL850	835	43.02	0.90	6.81
BL850	835	53.72	0.98	7.07
HL900	900	42.47	0.99	6.05
BL900	900	56.97	1.09	6.28
HL1800	1750	42.24	1.40	5.44
BL1800	1750	53.53	1.53	5.62
HL1900	1880	40.79	1.42	6.05
BL1900	1880	54.47	1.57	6.18
HL2000	1950	40.52	1.44	5.63
BL2000	1950	54.18	1.56	5.79
HL2300	2300	39.14	1.66	5.76
BL2300	2300	52.17	1.79	5.99
HL2450	2450	38.73	1.81	5.52
BL2450	2450	53.23	1.96	5.70
HL2600	2600	38.54	1.95	5.57
BL2600	2600	52.07	2.23	5.73

LOWER DETECTION LIMIT: 8mW/kg

Page: 7/9

This document shall not be reproduced, except in full or in part, without the written approval of MVG. The information contained herein is to be used only for the purpose for which it is submitted and is not to be released in whole or part without written approval of MVG.



5.4 ISOTROPY

HL900 MHz

- Axial isotropy: 0.04 dB
- Hemispherical isotropy: 0.06 dB

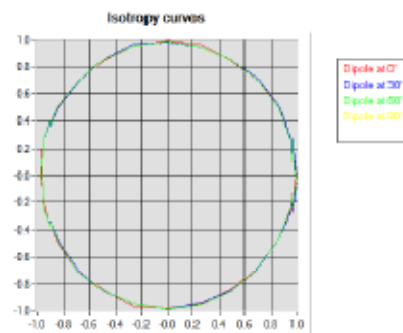

HL1800 MHz

- Axial isotropy: 0.04 dB
- Hemispherical isotropy: 0.07 dB

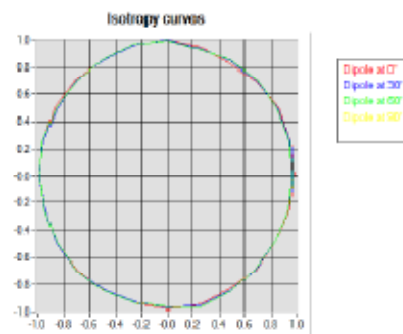



6 LIST OF EQUIPMENT

Equipment Summary Sheet				
Equipment Description	Manufacturer / Model	Identification No.	Current Calibration Date	Next Calibration Date
Flat Phantom	MVG	SN-20/09-SAM71	Validated. No cal required.	Validated. No cal required.
COMOSAR Test Bench	Version 3	NA	Validated. No cal required.	Validated. No cal required.
Network Analyzer	Rhode & Schwarz ZVA	SN100132	02/2013	02/2016
Reference Probe	MVG	EP 94 SN 37/08	10/2015	10/2016
Multimeter	Keithley 2000	1188656	12/2013	12/2016
Signal Generator	Agilent E4438C	MY49070581	12/2013	12/2016
Amplifier	Aethercomm	SN 046	Characterized prior to test. No cal required.	Characterized prior to test. No cal required.
Power Meter	HP E4418A	US38261498	12/2013	12/2016
Power Sensor	HP ECP-E26A	US37181460	12/2013	12/2016
Directional Coupler	Narda 4216-20	01386	Characterized prior to test. No cal required.	Characterized prior to test. No cal required.
Waveguide	Mega Industries	069Y7-158-13-712	Validated. No cal required.	Validated. No cal required.
Waveguide Transition	Mega Industries	069Y7-158-13-701	Validated. No cal required.	Validated. No cal required.
Waveguide Termination	Mega Industries	069Y7-158-13-701	Validated. No cal required.	Validated. No cal required.

Page: 9/9

This document shall not be reproduced, except in full or in part, without the written approval of MVG. The information contained herein is to be used only for the purpose for which it is submitted and is not to be released in whole or part without written approval of MVG.

SID835 Dipole Calibration Certificate**SAR Reference Dipole Calibration Report**

Ref : ACR.240.1.14.SATU.A

**CCIC SOUTHERN ELECTRONIC PRODUCT
TESTING (SHENZHEN) CO., LTD**
ELECTRONIC TESTING BUILDING, SHAHE ROAD, XILI
TOWN
SHENZHEN, P.R. CHINA (POST CODE:518055)
SATIMO COMOSAR REFERENCE DIPOLE
FREQUENCY: 835 MHZ
SERIAL NO.: SN 09/13 DIP0G835-217

Calibrated at SATIMO US
2105 Barrett Park Dr. - Kennesaw, GA 30144



08/28/14

Summary:

This document presents the method and results from an accredited SAR reference dipole calibration performed in SATIMO USA using the COMOSAR test bench. All calibration results are traceable to national metrology institutions.



SAR REFERENCE DIPOLE CALIBRATION REPORT

Ref: ACR.240.1.14.SATU.A

	<i>Name</i>	<i>Function</i>	<i>Date</i>	<i>Signature</i>
<i>Prepared by :</i>	Jérôme LUC	Product Manager	8/29/2014	<i>JS</i>
<i>Checked by :</i>	Jérôme LUC	Product Manager	8/29/2014	<i>JS</i>
<i>Approved by :</i>	Kim RUTKOWSKI	Quality Manager	8/29/2014	<i>Kim Rutkowski</i>

	<i>Customer Name</i>
<i>Distribution :</i>	CCIC SOUTHERN ELECTRONIC PRODUCT TESTING (SHENZHEN) Co., Ltd

<i>Issue</i>	<i>Date</i>	<i>Modifications</i>
A	8/29/2014	Initial release



TABLE OF CONTENTS

1 Introduction.....4

2 Device Under Test4

3 Product Description4

 3.1 General Information 4

4 Measurement Method5

 4.1 Return Loss Requirements 5

 4.2 Mechanical Requirements 5

5 Measurement Uncertainty5

 5.1 Return Loss 5

 5.2 Dimension Measurement 5

 5.3 Validation Measurement 5

6 Calibration Measurement Results6

 6.1 Return Loss and Impedance In Head Liquid 6

 6.2 Return Loss and Impedance In Body Liquid 6

 6.3 Mechanical Dimensions 6

7 Validation measurement7

 7.1 Head Liquid Measurement 7

 7.2 SAR Measurement Result With Head Liquid 8

 7.3 Body Liquid Measurement 9

 7.4 SAR Measurement Result With Body Liquid 10

8 List of Equipment 11

1 INTRODUCTION

This document contains a summary of the requirements set forth by the IEEE 1528, OET 65 Bulletin C and CEI/IEC 62209 standards for reference dipoles used for SAR measurement system validations and the measurements that were performed to verify that the product complies with the fore mentioned standards.

2 DEVICE UNDER TEST

Device Under Test	
Device Type	COMOSAR 835 MHz REFERENCE DIPOLE
Manufacturer	Satimo
Model	SID835
Serial Number	SN 09/13 DIP0G835-217
Product Condition (new / used)	used

A yearly calibration interval is recommended.

3 PRODUCT DESCRIPTION

3.1 GENERAL INFORMATION

Satimo's COMOSAR Validation Dipoles are built in accordance to the IEEE 1528, OET 65 Bulletin C and CEI/IEC 62209 standards. The product is designed for use with the COMOSAR test bench only.



Figure 1 – Satimo COMOSAR Validation Dipole

4 MEASUREMENT METHOD

The IEEE 1528, OET 65 Bulletin C and CEI/IEC 62209 standards provide requirements for reference dipoles used for system validation measurements. The following measurements were performed to verify that the product complies with the fore mentioned standards.

4.1 RETURN LOSS REQUIREMENTS

The dipole used for SAR system validation measurements and checks must have a return loss of -20 dB or better. The return loss measurement shall be performed against a liquid filled flat phantom, with the phantom constructed as outlined in the fore mentioned standards.

4.2 MECHANICAL REQUIREMENTS

The IEEE Std. 1528 and CEI/IEC 62209 standards specify the mechanical components and dimensions of the validation dipoles, with the dimensions frequency and phantom shell thickness dependent. The COMOSAR test bench employs a 2 mm phantom shell thickness therefore the dipoles sold for use with the COMOSAR test bench comply with the requirements set forth for a 2 mm phantom shell thickness.

5 MEASUREMENT UNCERTAINTY

All uncertainties listed below represent an expanded uncertainty expressed at approximately the 95% confidence level using a coverage factor of $k=2$, traceable to the Internationally Accepted Guides to Measurement Uncertainty.

5.1 RETURN LOSS

The following uncertainties apply to the return loss measurement:

Frequency band	Expanded Uncertainty on Return Loss
400-6000MHz	0.1 dB

5.2 DIMENSION MEASUREMENT

The following uncertainties apply to the dimension measurements:

Length (mm)	Expanded Uncertainty on Length
3 - 300	0.05 mm

5.3 VALIDATION MEASUREMENT

The guidelines outlined in the IEEE 1528, OET 65 Bulletin C, CENELEC EN50361 and CEI/IEC 62209 standards were followed to generate the measurement uncertainty for validation measurements.

Scan Volume	Expanded Uncertainty
1 g	20.3 %
10 g	20.1 %

Page: 5/11

This document shall not be reproduced, except in full or in part, without the written approval of SATIMO.

6 CALIBRATION MEASUREMENT RESULTS

6.1 RETURN LOSS AND IMPEDANCE IN HEAD LIQUID

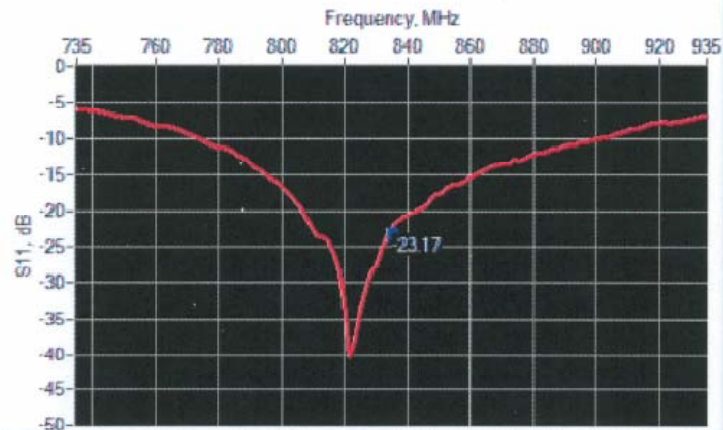

Frequency (MHz)	Return Loss (dB)	Requirement (dB)	Impedance
835	-23.17	-20	$57.4 \Omega - 0.2 j\Omega$

6.2 RETURN LOSS AND IMPEDANCE IN BODY LIQUID

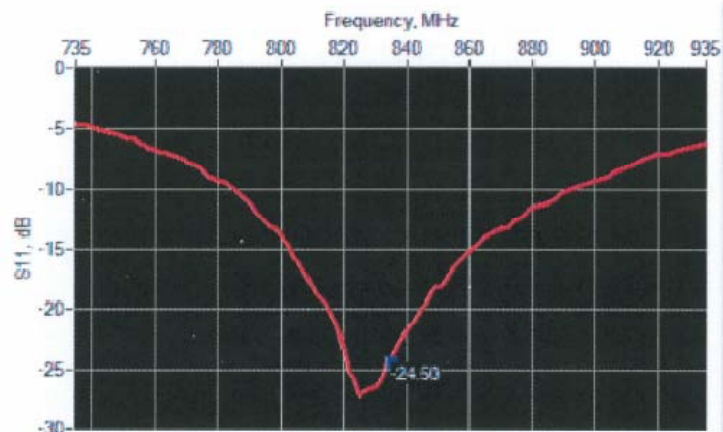

Frequency (MHz)	Return Loss (dB)	Requirement (dB)	Impedance
835	-24.50	-20	$55.0 \Omega + 3.9 j\Omega$

6.3 MECHANICAL DIMENSIONS

Frequency MHz	L mm		h mm		d mm	
	required	measured	required	measured	required	measured
300	420.0 ±1 %.		250.0 ±1 %.		6.35 ±1 %.	
450	290.0 ±1 %.		166.7 ±1 %.		6.35 ±1 %.	
750	176.0 ±1 %.		100.0 ±1 %.		6.35 ±1 %.	
835	161.0 ±1 %.	PASS	89.8 ±1 %.	PASS	3.6 ±1 %.	PASS



SAR REFERENCE DIPOLE CALIBRATION REPORT

Ref: ACR.240.1.14.SATU.A

900	149.0 ±1 %.		83.3 ±1 %.		3.6 ±1 %.	
1450	89.1 ±1 %.		51.7 ±1 %.		3.6 ±1 %.	
1500	80.5 ±1 %.		50.0 ±1 %.		3.6 ±1 %.	
1640	79.0 ±1 %.		45.7 ±1 %.		3.6 ±1 %.	
1750	75.2 ±1 %.		42.9 ±1 %.		3.6 ±1 %.	
1800	72.0 ±1 %.		41.7 ±1 %.		3.6 ±1 %.	
1900	68.0 ±1 %.		39.5 ±1 %.		3.6 ±1 %.	
1950	66.3 ±1 %.		38.5 ±1 %.		3.6 ±1 %.	
2000	64.5 ±1 %.		37.5 ±1 %.		3.6 ±1 %.	
2100	61.0 ±1 %.		35.7 ±1 %.		3.6 ±1 %.	
2300	55.5 ±1 %.		32.6 ±1 %.		3.6 ±1 %.	
2450	51.5 ±1 %.		30.4 ±1 %.		3.6 ±1 %.	
2600	48.5 ±1 %.		28.8 ±1 %.		3.6 ±1 %.	
3000	41.5 ±1 %.		25.0 ±1 %.		3.6 ±1 %.	
3500	37.0 ±1 %.		26.4 ±1 %.		3.6 ±1 %.	
3700	34.7 ±1 %.		26.4 ±1 %.		3.6 ±1 %.	

7 VALIDATION MEASUREMENT

The IEEE Std. 1528, OET 65 Bulletin C and CEI/IEC 62209 standards state that the system validation measurements must be performed using a reference dipole meeting the fore mentioned return loss and mechanical dimension requirements. The validation measurement must be performed against a liquid filled flat phantom, with the phantom constructed as outlined in the fore mentioned standards. Per the standards, the dipole shall be positioned below the bottom of the phantom, with the dipole length centered and parallel to the longest dimension of the flat phantom, with the top surface of the dipole at the described distance from the bottom surface of the phantom.

7.1 HEAD LIQUID MEASUREMENT

Frequency MHz	Relative permittivity (ϵ_r')		Conductivity (σ) S/m	
	required	measured	required	measured
300	45.3 ±5 %		0.87 ±5 %	
450	43.5 ±5 %		0.87 ±5 %	
750	41.9 ±5 %		0.89 ±5 %	
835	41.5 ±5 %	PASS	0.90 ±5 %	PASS
900	41.5 ±5 %		0.97 ±5 %	
1450	40.5 ±5 %		1.20 ±5 %	
1500	40.4 ±5 %		1.23 ±5 %	
1640	40.2 ±5 %		1.31 ±5 %	
1750	40.1 ±5 %		1.37 ±5 %	
1800	40.0 ±5 %		1.40 ±5 %	
1900	40.0 ±5 %		1.40 ±5 %	
1950	40.0 ±5 %		1.40 ±5 %	
2000	40.0 ±5 %		1.40 ±5 %	

Page: 7/11

This document shall not be reproduced, except in full or in part, without the written approval of SATIMO.



SAR REFERENCE DIPOLE CALIBRATION REPORT

Ref: ACR.240.1.14.SATU.A

2100	39.8 ±5 %		1.49 ±5 %	
2300	39.5 ±5 %		1.67 ±5 %	
2450	39.2 ±5 %		1.80 ±5 %	
2600	39.0 ±5 %		1.96 ±5 %	
3000	38.5 ±5 %		2.40 ±5 %	
3500	37.9 ±5 %		2.91 ±5 %	

7.2 SAR MEASUREMENT RESULT WITH HEAD LIQUID

The IEEE Std. 1528 and CEI/IEC 62209 standards state that the system validation measurements should produce the SAR values shown below (for phantom thickness of 2 mm), within the uncertainty for the system validation. All SAR values are normalized to 1 W forward power. In bracket, the measured SAR is given with the used input power.

Software	OPENSAR V4
Phantom	SN 20/09 SAM71
Probe	SN 18/11 EPG122
Liquid	Head Liquid Values: eps' : 42.3 sigma : 0.92
Distance between dipole center and liquid	15.0 mm
Area scan resolution	dx=8mm/dy=8mm
Zoon Scan Resolution	dx=8mm/dy=8m/dz=5mm
Frequency	835 MHz
Input power	20 dBm
Liquid Temperature	21 °C
Lab Temperature	21 °C
Lab Humidity	45 %

Frequency MHz	1 g SAR (W/kg/W)		10 g SAR (W/kg/W)	
	required	measured	required	measured
300	2.85		1.94	
450	4.58		3.06	
750	8.49		5.55	
835	9.56	9.77 (0.98)	6.22	6.30 (0.63)
900	10.9		6.99	
1450	29		16	
1500	30.5		16.8	
1640	34.2		18.4	
1750	36.4		19.3	
1800	38.4		20.1	
1900	39.7		20.5	
1950	40.5		20.9	
2000	41.1		21.1	
2100	43.6		21.9	
2300	48.7		23.3	

Page: 8/11

This document shall not be reproduced, except in full or in part, without the written approval of SATIMO.

2450	52.4		24
2600	55.3		24.6
3000	63.8		25.7
3500	67.1		25

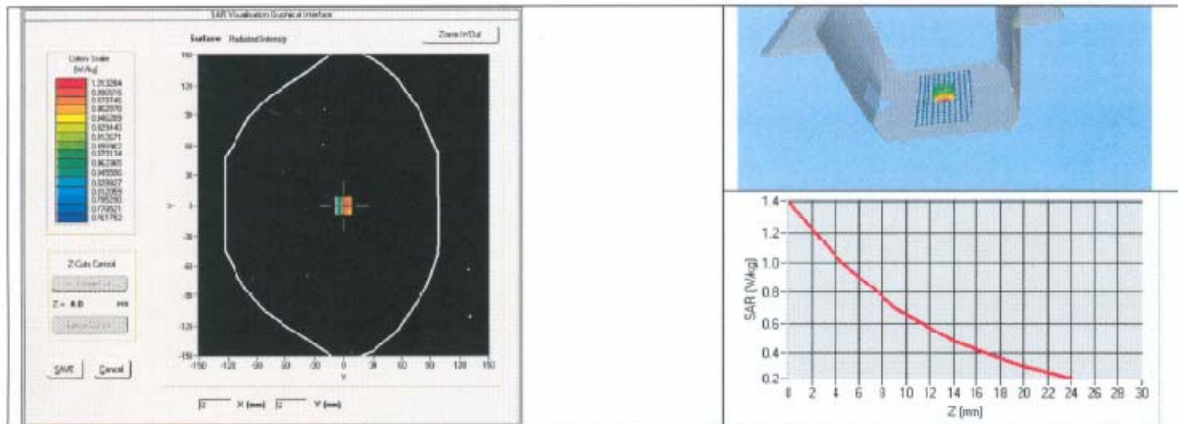

7.3 BODY LIQUID MEASUREMENT

Frequency MHz	Relative permittivity (ϵ_r)		Conductivity (σ) S/m	
	required	measured	required	measured
150	61.9 ±5 %		0.80 ±5 %	
300	58.2 ±5 %		0.92 ±5 %	
450	56.7 ±5 %		0.94 ±5 %	
750	55.5 ±5 %		0.96 ±5 %	
835	55.2 ±5 %	PASS	0.97 ±5 %	PASS
900	55.0 ±5 %		1.05 ±5 %	
915	55.0 ±5 %		1.06 ±5 %	
1450	54.0 ±5 %		1.30 ±5 %	
1610	53.8 ±5 %		1.40 ±5 %	
1800	53.3 ±5 %		1.52 ±5 %	
1900	53.3 ±5 %		1.52 ±5 %	
2000	53.3 ±5 %		1.52 ±5 %	
2100	53.2 ±5 %		1.62 ±5 %	
2450	52.7 ±5 %		1.95 ±5 %	
2600	52.5 ±5 %		2.16 ±5 %	
3000	52.0 ±5 %		2.73 ±5 %	
3500	51.3 ±5 %		3.31 ±5 %	
5200	49.0 ±10 %		5.30 ±10 %	
5300	48.9 ±10 %		5.42 ±10 %	
5400	48.7 ±10 %		5.53 ±10 %	



SAR REFERENCE DIPOLE CALIBRATION REPORT

Ref: ACR.240.1.14.SATU.A

5500	48.6 ±10 %		5.65 ±10 %	
5600	48.5 ±10 %		5.77 ±10 %	
5800	48.2 ±10 %		6.00 ±10 %	

7.4 SAR MEASUREMENT RESULT WITH BODY LIQUID

Software	OPENSAR V4
Phantom	SN 20/09 SAM71
Probe	SN 18/11 EPG122
Liquid	Body Liquid Values: eps' : 54.1 sigma : 0.97
Distance between dipole center and liquid	15.0 mm
Area scan resolution	dx=8mm/dy=8mm
Zoon Scan Resolution	dx=8mm/dy=8m/dz=5mm
Frequency	835 MHz
Input power	20 dBm
Liquid Temperature	21 °C
Lab Temperature	21 °C
Lab Humidity	45 %

Frequency MHz	1 g SAR (W/kg/W)	10 g SAR (W/kg/W)
	measured	measured
835	10.31 (1.03)	6.74 (0.67)

