



FCC TEST REPORT (15.247)

REPORT NO.: RF951124L01

MODEL NO.: DCMA-82, DCMA-82 High Power,
DCMA-IHP, DCMA-HP, CM11, CM10-HI,
CM10-H, DCMA-SPI

RECEIVED: Nov. 24, 2006

TESTED: Jan. 09 to 18, 2007

ISSUED: Jan. 19, 2007

APPLICANT: Wistron NeWeb Corp.

ADDRESS: No. 10-1, Li-hsin Road I, Hsinchu Science Park,
Hsinchu 300, Taiwan, R.O.C.

ISSUED BY: Advance Data Technology Corporation

TEST LOCATION: No. 81-1, Lu Liao Keng, 9 Ling, Wu Lung
Tsuen, Chiung Lin Hsiang, Hsin Chu Hsien,
Taiwan, R.O.C.

This test report consists of 134 pages in total. It may be duplicated completely for legal use with the approval of the applicant. It should not be reproduced except in full, without the written approval of our laboratory. The client should not use it to claim product endorsement by CNLA, A2LA or any government agencies. The test results in the report only apply to the tested sample.



No. 2177-01



Table of Contents

1.	CERTIFICATION	6
2.	SUMMARY OF TEST RESULTS	7
2.1	MEASUREMENT UNCERTAINTY	9
3.	GENERAL INFORMATION	10
3.1	GENERAL DESCRIPTION OF EUT	10
3.2	DESCRIPTION OF TEST MODES	13
3.2.1	TEST MODE APPLICABILITY AND TESTED CHANNEL DETAIL:	14
3.3	GENERAL DESCRIPTION OF APPLIED STANDARDS.....	16
3.4	DESCRIPTION OF SUPPORT UNITS	17
3.5	CONFIGURATION OF SYSTEM UNDER TEST	17
4.	TEST TYPES AND RESULTS (802.11b & g, 2400 ~ 2483.5MHz Band).....	18
4.1	CONDUCTED EMISSION MEASUREMENT	18
4.1.1	LIMITS OF CONDUCTED EMISSION MEASUREMENT	18
4.1.2	TEST INSTRUMENTS	18
4.1.3	TEST PROCEDURES.....	19
4.1.4	DEVIATION FROM TEST STANDARD	19
4.1.5	TEST SETUP	20
4.1.6	EUT OPERATING CONDITIONS	20
4.1.7	TEST RESULTS	21
4.2	RADIATED EMISSION MEASUREMENT	23
4.2.1	LIMITS OF RADIATED EMISSION MEASUREMENT	23
4.2.2	TEST INSTRUMENTS	24
4.2.3	TEST PROCEDURES.....	25
4.2.4	DEVIATION FROM TEST STANDARD	25
4.2.5	TEST SETUP	26
4.2.6	EUT OPERATING CONDITIONS	26
4.2.7	TEST RESULTS	27
4.3	6dB BANDWIDTH MEASUREMENT.....	47
4.3.1	LIMITS OF 6dB BANDWIDTH MEASUREMENT.....	47
4.3.2	TEST INSTRUMENTS	47
4.3.3	TEST PROCEDURE	48
4.3.4	DEVIATION FROM TEST STANDARD	48
4.3.5	TEST SETUP	48
4.3.6	EUT OPERATING CONDITIONS	48
4.3.7	TEST RESULTS	49
4.4	MAXIMUM PEAK OUTPUT POWER.....	54
4.4.1	LIMITS OF MAXIMUM PEAK OUTPUT POWER MEASUREMENT	54
4.4.2	INSTRUMENTS	54



4.4.3	TEST PROCEDURES.....	55
4.4.4	DEVIATION FROM TEST STANDARD	55
4.4.5	TEST SETUP	55
4.4.6	EUT OPERATING CONDITIONS	55
4.4.7	TEST RESULTS	56
4.5	POWER SPECTRAL DENSITY MEASUREMENT	58
4.5.1	LIMITS OF POWER SPECTRAL DENSITY MEASUREMENT	58
4.5.2	TEST INSTRUMENTS	58
4.5.3	TEST PROCEDURE	59
4.5.4	DEVIATION FROM TEST STANDARD	59
4.5.5	TEST SETUP	59
4.5.6	EUT OPERATING CONDITION.....	59
4.5.7	TEST RESULTS	60
4.6	CONDUCTED EMISSION AND BAND EDGES MEASUREMENT	65
4.6.1	LIMITS OF CONDUCTED EMISSION AND BAND EDGES MEASUREMENT.....	65
4.6.2	TEST INSTRUMENTS	65
4.6.3	TEST PROCEDURE	65
4.6.4	EUT OPERATING CONDITION.....	65
4.6.5	TEST RESULTS	66
4.7	ANTENNA REQUIREMENT.....	73
4.7.1	STANDARD APPLICABLE.....	73
4.7.2	ANTENNA CONNECTED CONSTRUCTION.....	73
5.	TEST TYPES AND RESULTS (802.11a, 5725~5850MHz Band)	74
5.1	CONDUCTED EMISSION MEASUREMENT	74
5.1.1	LIMITS OF CONDUCTED EMISSION MEASUREMENT	74
5.1.2	TEST INSTRUMENTS	74
5.1.3	TEST PROCEDURES.....	75
5.1.4	DEVIATION FROM TEST STANDARD	75
5.1.5	TEST SETUP	76
5.1.6	EUT OPERATING CONDITIONS	76
5.1.7	TEST RESULTS	77
5.2	RADIATED EMISSION MEASUREMENT	79
5.2.1	LIMITS OF RADIATED EMISSION MEASUREMENT	79
5.2.2	TEST INSTRUMENTS	80
5.2.3	TEST PROCEDURES.....	81
5.2.4	DEVIATION FROM TEST STANDARD	81
5.2.5	TEST SETUP	82
5.2.6	EUT OPERATING CONDITIONS	82
5.2.7	TEST RESULTS	83



5.2.8	TEST RESULTS – ANTENNA A.....	84
5.2.9	TEST RESULTS – ANTENNA C.....	89
5.3	6dB BANDWIDTH MEASUREMENT.....	94
5.3.1	LIMITS OF 6dB BANDWIDTH MEASUREMENT.....	94
5.3.2	TEST INSTRUMENTS.....	94
5.3.3	TEST PROCEDURE.....	95
5.3.4	DEVIATION FROM TEST STANDARD.....	95
5.3.5	TEST SETUP.....	95
5.3.6	EUT OPERATING CONDITIONS.....	95
5.3.7	TEST RESULTS - ANTENNA A.....	96
5.3.8	TEST RESULTS - ANTENNA C.....	100
5.4	MAXIMUM PEAK OUTPUT POWER.....	104
5.4.1	LIMITS OF MAXIMUM PEAK OUTPUT POWER MEASUREMENT.....	104
5.4.2	INSTRUMENTS.....	104
5.4.3	TEST PROCEDURES.....	105
5.4.4	DEVIATION FROM TEST STANDARD.....	105
5.4.5	TEST SETUP.....	105
5.4.6	EUT OPERATING CONDITIONS.....	105
5.4.7	TEST RESULTS - ANTENNA A.....	106
5.4.8	TEST RESULTS - ANTENNA C.....	108
5.5	POWER SPECTRAL DENSITY MEASUREMENT.....	110
5.5.1	LIMITS OF POWER SPECTRAL DENSITY MEASUREMENT.....	110
5.5.2	TEST INSTRUMENTS.....	110
5.5.3	TEST PROCEDURE.....	111
5.5.4	DEVIATION FROM TEST STANDARD.....	111
5.5.5	TEST SETUP.....	111
5.5.6	EUT OPERATING CONDITION.....	111
5.5.7	TEST RESULTS - ANTENNA A.....	112
5.5.8	TEST RESULTS - ANTENNA C.....	116
5.6	BAND EDGES MEASUREMENT.....	120
5.6.1	LIMITS OF BAND EDGES MEASUREMENT.....	120
5.6.2	TEST INSTRUMENTS.....	120
5.6.3	TEST PROCEDURE.....	121
5.6.4	DEVIATION FROM TEST STANDARD.....	121
5.6.5	EUT OPERATING CONDITION.....	121
5.6.6	TEST RESULTS -ANTENNA A.....	122
5.6.7	TEST RESULTS -ANTENNA C.....	127
5.7	ANTENNA REQUIREMENT.....	132
5.7.1	STANDARD APPLICABLE.....	132



5.7.2	ANTENNA CONNECTED CONSTRUCTION.....	132
6.	INFORMATION ON THE TESTING LABORATORIES.....	133
	APPENDIX-A.....	A-1



1. CERTIFICATION

PRODUCT: High Powered 802.11a/g WLAN Mini-PCI 3A,
Industry High Powered 802.11a/g WLAN Mini-PCI 3A
Commercial High Powered 802.11a/g WLAN Mini-PCI 3A
High Powered 802.11a/b/g WLAN Mini-PCI Module
(Industrial Grade)
High Powered 802.11a/b/g WLAN Mini-PCI Module
Industry High-Power Safety-802.11p WLAN

BRAND NAME: WNC

MODEL NO.: DCMA-82, DCMA-82 High Power, DCMA-IHP, DCMA-HP,
CM11, CM10-HI, CM10-H, DCMA-SPI

TEST SAMPLE: ENGINEERING SAMPLE

TESTED: Jan. 09 to 18, 2007

APPLICANT: Wistron NeWeb Corp.

STANDARDS: FCC Part 15, Subpart C (Section 15.247),
ANSI C63.4-2003

The above equipment (Model: DCMA-82) has been tested by **Advance Data Technology Corporation**, and found compliance with the requirement of the above standards. The test record, data evaluation & Equipment Under Test (EUT) configurations represented herein are true and accurate accounts of the measurements of the sample's EMC characteristics under the conditions specified in this report.

PREPARED BY : Carol Liao , **DATE:** Jan. 19, 2007
(Carol Liao)

TECHNICAL ACCEPTANCE : Hank Chung , **DATE:** Jan. 19, 2007
Responsible for RF (Hank Chung)

APPROVED BY : May Chen , **DATE:** Jan. 19, 2007
(May Chen, Deputy Manager)

2. SUMMARY OF TEST RESULTS

The EUT has been tested according to the following specifications:

For 802.11b & g, 2412~2462MHz Band

APPLIED STANDARD: FCC Part 15, Subpart C (Section 15.247)			
Standard Section	Test Type and Limit	Result	Remark
15.207	AC Power Conducted Emission	PASS	Meet the requirement of limit. Minimum passing margin is -0.45dB at 2.410MHz
15.247(a)(2)	Spectrum Bandwidth of a Direct Sequence Spread Spectrum System Limit: min. 500kHz	PASS	Meet the requirement of limit.
15.247(b)	Maximum Peak Output Power Limit: max. 30dBm	PASS	Meet the requirement of limit.
15.247(d)	Radiated Emissions Limit: Table 15.209	PASS	Meet the requirement of limit. Minimum passing margin is -0.2dB at 4874.00MHz
15.247(e)	Power Spectral Density Limit: max. 8dBm	PASS	Meet the requirement of limit.
15.247(d)	Band Edge Measurement Limit: 20dB less than the peak value of fundamental frequency	PASS	Meet the requirement of limit.

For 802.11a, 5725~5850MHz Band

APPLIED STANDARD: FCC Part 15, Subpart C (Section 15.247)			
Standard Section	Test Type and Limit	Result	Remark
15.207	AC Power Conducted Emission	PASS	Meet the requirement of limit. Minimum passing margin is -0.38dB at 2.410MHz
15.247(a)(2)	Spectrum Bandwidth of a Direct Sequence Spread Spectrum System Limit: min. 500kHz	PASS	Meet the requirement of limit.
15.247(b)	Maximum Peak Output Power Limit: max. 30dBm	PASS	Meet the requirement of limit.
15.247(d)	Radiated Emissions Limit: Table 15.209	PASS	Meet the requirement of limit. Minimum passing margin is -0.40dB at 11490.00MHz
15.247(e)	Power Spectral Density Limit: max. 8dBm	PASS	Meet the requirement of limit.
15.247(d)	Band Edge Measurement Limit: 20dB less than the peak value of fundamental frequency	PASS	Meet the requirement of limit.

NOTE:

1. The EUT was operating in 2.412 ~ 2.462GHz, 5.150 ~ 5.250GHz and 5.725 ~ 5.850GHz frequencies band. This report was recorded the RF parameters including 2.412 ~ 2.462GHz and 5.725 ~ 5.850GHz. For the 5.150 ~ 5.250GHz RF parameters was recorded in another test report.

2.1 MEASUREMENT UNCERTAINTY

Where relevant, the following measurement uncertainty levels have been estimated for tests performed on the EUT as specified in CISPR 16-4:

This uncertainty represents an expanded uncertainty expressed at approximately the 95% confidence level using a coverage factor of $k=2$.

Measurement	Value
Radiated emissions (30MHz-1GHz)	2.98 dB
Radiated emissions (1GHz ~18GHz)	2.21 dB
Radiated emissions (18GHz ~40GHz)	1.88 dB

3. GENERAL INFORMATION

3.1 GENERAL DESCRIPTION OF EUT

EUT	High Powered 802.11a/g WLAN Mini-PCI 3A, Industry High Powered 802.11a/g WLAN Mini-PCI 3A Commercial High Powered 802.11a/g WLAN Mini-PCI 3A High Powered 802.11a/b/g WLAN Mini-PCI Module (Industrial Grade) High Powered 802.11a/b/g WLAN Mini-PCI Module Industry High-Power Safety-802.11p WLAN
MODEL NO.	DCMA-82, DCMA-82 High Power, DCMA-IHP, DCMA-HP, CM11, CM10-HI, CM10-H, DCMA-SPI
FCC ID	NKRDCMA82
POWER SUPPLY	DC 3.3V from host equipment
MODULATION TYPE	CCK, DQPSK, DBPSK for DSSS 64QAM, 16QAM, QPSK, BPSK for OFDM
MODULATION TECHNOLOGY	DSSS, OFDM
TRANSFER RATE	802.11b: 11/5.5/2/1Mbps 802.11g: 54/48/36/24/18/12/9/6Mbps 802.11a: 54/48/36/24/18/12/9/6Mbps 802.11j: 54/48/36/24/18/12/9/6Mbps (Turbo mode: up to 108Mbps *see Note 2)
FREQUENCY RANGE	802.11b & 802.11g: 2412 ~ 2462MHz 802.11a: 5.15 ~ 5.25GHz and 5.725 ~ 5.850GHz 802.11j: 4940 ~ 4990MHz
NUMBER OF CHANNEL	802.11b & 802.11g: 11 (1 for 802.11g Turbo mode) 802.11a: 9 (3 for 802.11a Turbo mode) 802.11j: 8(3 for 10MHz System;5 for 20MHz System)
CHANNEL SPACING	802.11b & 802.11g: 5MHz 802.11a: 20MHz for Normal mode 802.11j: 5MHz and 10MHz
OUTPUT POWER	Please see note 5 (on next page)
ANTENNA TYPE	Please see note 3 (on next page)

NOTE:

1. The EUT operates in 4.9GHz and both the 5GHz and 2.4GHz Bands and compatibility with 802.11a and 802.11b, 802.11g technology.

2. This EUT is capable of providing data rates of up to 108 Mbps in 802.11a and 802.11g Turbo mode depending upon reception quality.

3. There are four antennas provided to this EUT, please refer to the following table:

For 2.4GHz							
No.	Brand Name	Model No.	Gain (dBi)	Cable Loss (dB)	Net Gain (dB)	Antenna Type	Connector
1	* Wistron Neweb Corp.	DBA-SSMA-01	1.29	0.5	0.79	dipole	RSMA
2	CUSHCRUFT	SRSM2400MRA	2	0.5	1.5	dipole	RSMA
Note: For 2.4GHz antennas, antenna 2 was selected as representative antenna for the test.							
For 5GHz							
No.	Brand Name	Model No.	Gain (dBi)	Cable Loss (dB)	Net Gain (dB)	Antenna Type	Connector
A	* Wistron Neweb Corp.	DBA-SSMA-01	2.06	0.9	1.16	dipole	RSMA
B	CUSHCRUFT	SRSM5150MRA	2	0.9	1.1	dipole	RSMA
C	** HUBER+SUHNER	SPA 5500/40/14/O/V_C	13.5	0.9	12.6	panel	SMA
Note: 1. For 5GHz antennas, antenna A and C were selected as representative antennas for the test.							
2. “*” is a Dual Band antenna can be used in both 2.4GHz and 5GHz.							
3. “**” is an Outdoor Antenna it can only be used in point-to-point applications.							

4. Frequency Range of each Antennas are as followings:

For 2.4GHz	
Antenna No.	Frequency Range
No. 1 & 2	2400MHz ~ 2483.5MHz
For 5GHz	
Antenna No.	Frequency Range
No. A & B	5.15GHz~5.25GHz and 5.725GHz ~ 5.850GHz
No. C	5.725GHz ~ 5.850GHz

5. Peak output power (Unit : mW) :

No.	Model No.	Operating Frequency (MHz)	
		2412MHz ~ 2462MHz	
1	DBA-SSMA-01	363.078	
2	SRSM2400MRA	363.078	
No.	Model No.	Operating Frequency (MHz)	
		5150~5250	5725~5850
A	DBA-SSMA-01	29.923	380.189
B	SRSM5150MRA	29.923	380.189
C	SPA 5500/40/14/O/V_C	NA	380.189

6. The EUT has eight product names and model names, which are identical to each other in all aspects except for the followings:

Product name	Model name	Description
High Powered 802.11a/g WLAN Mini-PCI 3A	DCMA-82	for market
High Powered 802.11a/g WLAN Mini-PCI 3A	DCMA-82 High Power	
Industry High Powered 802.11a/g WLAN Mini-PCI 3A	DCMA-IHP	
Commercial High Powered 802.11a/g WLAN Mini-PCI 3A	DCMA-HP	
High Powered 802.11a/g WLAN Mini-PCI 3A	CM11	
High Powered 802.11a/b/g WLAN Mini-PCI Module (Industrial Grade)	CM10-HI	
High Powered 802.11a/b/g WLAN Mini-PCI Module	CM10-H	
Industry High-Power Safety-802.11p WLAN	DCMA-SPI	

From the above models, model: **DCMA-82** was selected as representative model for the test and its data was recorded in this report.

7. The EUT has two samples, one is for MMCX connector the other is for U.FL. connector.
8. The two samples were pre-tested in chamber, EUT with MMCX connector, the worse case one, was chosen for final test.
9. The above EUT information was declared by the manufacturer and for more detailed features description, please refer to the manufacturer's specifications or User's Manual.

3.2 DESCRIPTION OF TEST MODES

Operated in 2400 ~ 2483.5MHz band:

For 802.11b/g: Eleven channels are provided to this EUT.

Channel	Frequency	Channel	Frequency
1	2412 MHz	7	2442 MHz
2	2417 MHz	8	2447 MHz
3	2422 MHz	9	2452 MHz
4	2427 MHz	10	2457 MHz
5	2432 MHz	11	2462 MHz
6	2437 MHz		

For 802.11g turbo mode: One channel is provided to this EUT

Channel	Frequency
6	2437 MHz

Operated in 5725 ~ 5850MHz band:

Five channels are provided to this EUT.

Channel	Frequency
1	5745 MHz
2	5765 MHz
3	5785 MHz
4	5805 MHz
5	5825 MHz

Two channels are provided to this EUT for turbo mode.

Channel	Frequency
1	5760 MHz
2	5800 MHz

3.2.1 TEST MODE APPLICABILITY AND TESTED CHANNEL DETAIL:

EUT configure mode	Applicable to				Description
	PLC	RE<1G	RE≥1G	APCM	
-	√	√	√	√	NA

Where PLC: Power Line Conducted Emission RE<1G RE: Radiated Emission below 1GHz
 RE≥1G: Radiated Emission above 1GHz APCM: Antenna Port Conducted Measurement

Power Line Conducted Emission Test:

- Pre-Scan has been conducted to determine the worst-case mode from all possible combinations between available modulations, data rates and antenna ports (if EUT with antenna diversity architecture).
- Following channel(s) was (were) selected for the final test as listed below.

Mode	Available Channel	Tested Channel	Modulation Technology	Modulation Type	Data Rate (Mbps)
802.11g	1 to 11	11	OFDM	BPSK	6
802.11a	1 to 5	5	OFDM	BPSK	6

Radiated Emission Test (Below 1 GHz):

- Pre-Scan has been conducted to determine the worst-case mode from all possible combinations between available modulations, data rates and antenna ports (if EUT with antenna diversity architecture).
- Following channel(s) was (were) selected for the final test as listed below.

Mode	Available Channel	Tested Channel	Modulation Technology	Modulation Type	Data Rate (Mbps)
802.11g	1 to 11	11	OFDM	BPSK	6
802.11a	1 to 5	5	OFDM	BPSK	6

Radiated Emission Test (Above 1 GHz):

- Pre-Scan has been conducted to determine the worst-case mode from all possible combinations between available modulations, data rates and antenna ports (if EUT with antenna diversity architecture).
- Following channel(s) was (were) selected for the final test as listed below.

Mode	Available Channel	Tested Channel	Modulation Technology	Modulation Type	Data Rate (Mbps)
802.11b	1 to 11	1, 6, 11	DSSS	CCK	1
802.11g	1 to 11	1, 6, 11	OFDM	BPSK	6
802.11g turbo	6	6	OFDM	BPSK	12
802.11a	1 to 5	1, 3, 5	OFDM	BPSK	6
802.11a turbo	1, 2	1, 2	OFDM	BPSK	12



Bandedge Measurement:

- Pre-Scan has been conducted to determine the worst-case mode from all possible combinations between available modulations, data rates and antenna ports (if EUT with antenna diversity architecture).
- Following channel(s) was (were) selected for the final test as listed below.

Mode	Available Channel	Tested Channel	Modulation Technology	Modulation Type	Data Rate (Mbps)
802.11b	1 to 11	1, 11	DSSS	CCK	1
802.11g	1 to 11	1, 11	OFDM	BPSK	6
802.11g turbo	6	6	OFDM	BPSK	12
802.11a	1 to 5	1, 5	OFDM	BPSK	6
802.11a turbo	1, 2	1, 2	OFDM	BPSK	12

Antenna Port Conducted Measurement:

- Pre-Scan has been conducted to determine the worst-case mode from all possible combinations between available modulations, data rates and antenna ports (if EUT with antenna diversity architecture).
- Following channel(s) was (were) selected for the final test as listed below.

Mode	Available Channel	Tested Channel	Modulation Technology	Modulation Type	Data Rate (Mbps)
802.11b	1 to 11	1, 6, 11	DSSS	CCK	1
802.11g	1 to 11	1, 6, 11	OFDM	BPSK	6
802.11g turbo	6	6	OFDM	BPSK	12
802.11a	1 to 5	1, 3, 5	OFDM	BPSK	6
802.11a turbo	1, 2	1, 2	OFDM	BPSK	12



3.3 GENERAL DESCRIPTION OF APPLIED STANDARDS

The EUT is a High Powered 802.11a/g WLAN Mini-PCI 3A. According to the specifications of the manufacturer, it must comply with the requirements of the following standards:

FCC Part 15, Subpart C. (15.247)

ANSI C63.4-2003

All test items have been performed and recorded as per the above standards.

NOTE: The EUT is also considered as a kind of computer peripheral, because the connection to computer is necessary for typical use. It has been verified to comply with the requirements of FCC Part 15, Subpart B, Class B (DoC). The test report has been issued separately.

3.4 DESCRIPTION OF SUPPORT UNITS

The EUT has been tested as an independent unit together with other necessary accessories or support units. The following support units or accessories were used to form a representative test configuration during the tests.

No.	Product	Brand	Model No.	Serial No.	FCC ID
1	NOTEBOOK COMPUTER	DELL	C600	6DRV601	FCC DoC
2	DC POWER SUPPLY	GOOD WILL INSTRUMENT CO., LTD.	GPC-3030D	7700087	B94C2642X
3	PRINTER	EPSON	LQ-300+	DCGY047261	B94C2642X
4	Extend Card	ADT	NA	NA	NA

No.	Signal cable description
1	NA
2	NA
3	1.8m braid shielded wire, terminated with DB25 and Centronics connector via metallic frame, w/o core
4	NA

Note: 1. All power cords of the above support units are unshielded (1.8m).

3.5 CONFIGURATION OF SYSTEM UNDER TEST

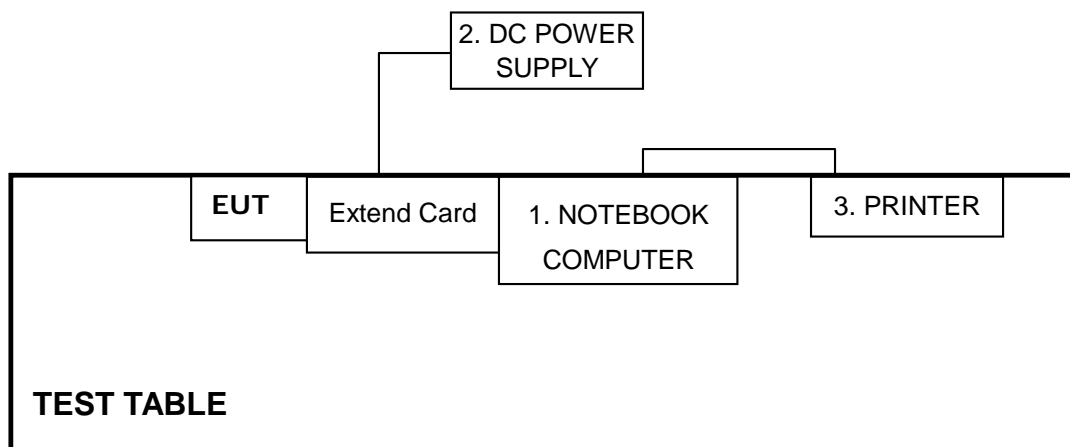

NOTE: 1. Please refer to the photos of test configuration.



4. TEST TYPES AND RESULTS (802.11b & g, 2400 ~ 2483.5MHz Band)

4.1 CONDUCTED EMISSION MEASUREMENT

4.1.1 LIMITS OF CONDUCTED EMISSION MEASUREMENT

FREQUENCY OF EMISSION (MHz)	CONDUCTED LIMIT (dB μ V)	
	Quasi-peak	Average
0.15-0.5	66 to 56	56 to 46
0.5-5	56	46
5-30	60	50

- NOTE:**
1. The lower limit shall apply at the transition frequencies.
 2. The limit decreases in line with the logarithm of the frequency in the range of 0.15 to 0.50 MHz.
 3. All emanations from a class A/B digital device or system, including any network of conductors and apparatus connected thereto, shall not exceed the level of field strengths specified above.

4.1.2 TEST INSTRUMENTS

DESCRIPTION & MANUFACTURER	MODEL NO.	SERIAL NO.	CALIBRATED UNTIL
Test Receiver	ESCS 30	847124/029	Dec. 14, 2007
Line-Impedance Stabilization Network(for EUT)	ENV-216	100071	Nov. 26, 2007
Line-Impedance Stabilization Network(for Peripheral)	KNW-407	8/1395/12	Aug. 15, 2007
RF Cable (JETBAO)	RG233/U	Cable_CB_01	Dec. 09, 2007
Terminator	50	2	Oct. 30, 2007
Software	ADT_Cond_V7.3.2	NA	NA

- NOTE:**
1. The calibration interval of the above test instruments is 12 months and the calibrations are traceable to NML/ROC and NIST/USA.
 2. The test was performed in ADT Shielded Room No. B.
 3. The VCCI Con B Registration No. is C-2193.

4.1.3 TEST PROCEDURES

- a. The EUT was placed 0.4 meters from the conducting wall of the shielded room with EUT being connected to the power mains through a line impedance stabilization network (LISN). Other support units were connected to the power mains through another LISN. The two LISNs provide 50 ohm/ 50uH of coupling impedance for the measuring instrument.
- b. Both lines of the power mains connected to the EUT were checked for maximum conducted interference.
- c. The frequency range from 150kHz to 30MHz was searched. Emission level under (Limit - 20dB) was not recorded.

4.1.4 DEVIATION FROM TEST STANDARD

No deviation

4.1.5 TEST SETUP

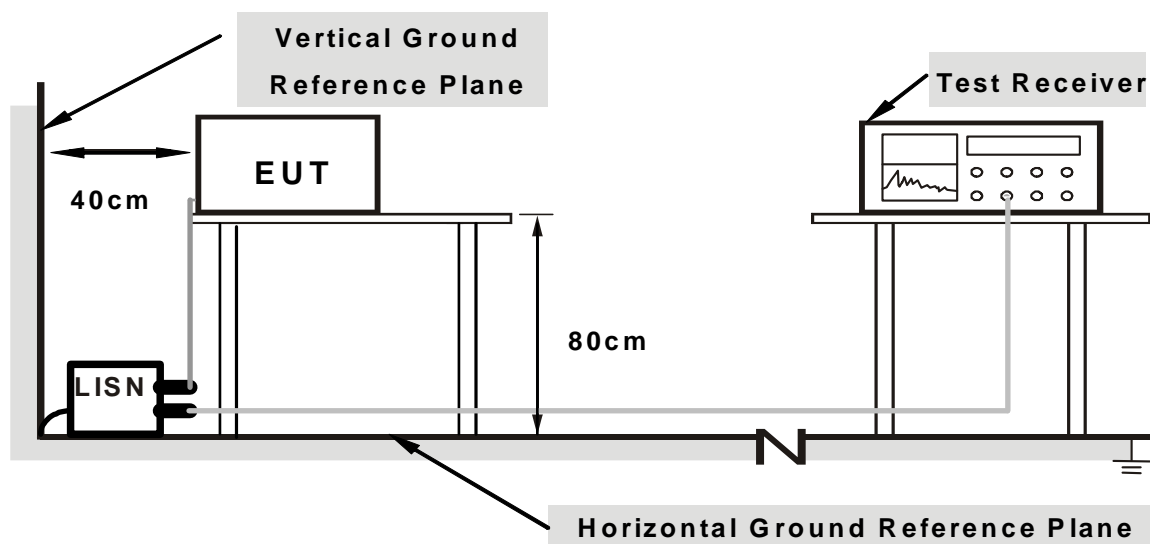

Note: 1. Support units were connected to second LISN.

2. Both of LISNs (AMN) are 80 cm from EUT and at least 80 from other units and other metal planes

For the actual test configuration, please refer to the related item – Photographs of the Test Configuration.

4.1.6 EUT OPERATING CONDITIONS

- Connect the EUT with the support unit 1 (Notebook computer) which placed on a testing table.
- The support unit 1 (Notebook computer) ran a test program “Art 53 b 5” to enable EUT under transmission condition continuously.
- Notebook computer sends "H" messages to printer, and the printer prints them on paper.

4.1.7 TEST RESULTS Conducted Worst-Case Data

MODULATION TYPE	BPSK	6dB BANDWIDTH	9 kHz
INPUT POWER	DC 3.3V	TRANSFER RATE	6Mbps
ENVIRONMENTAL CONDITIONS	22deg. C, 50%RH, 965hPa	PHASE	Positive
TESTED BY	Sky Liao		

No	Freq. [MHz]	Corr. Factor (dB)	Reading Value [dB (uV)]		Emission Level [dB (uV)]		Limit [dB (uV)]		Margin (dB)	
			Q.P.	AV.	Q.P.	AV.	Q.P.	AV.	Q.P.	AV.
			1	0.201	9.60	32.96	-	42.56	-	63.58
2	0.404	9.60	31.22	-	40.82	-	57.77	47.77	-16.95	-
3	2.273	9.70	36.16	-	45.86	-	56.00	46.00	-10.14	-
4	2.406	9.70	36.07	-	45.77	-	56.00	46.00	-10.23	-
5	2.678	9.70	38.02	35.82	47.72	45.52	56.00	46.00	-8.28	-0.48
6	3.148	9.70	35.37	-	45.07	-	56.00	46.00	-10.93	-

- REMARKS:**
1. Q.P. and AV. are abbreviations of quasi-peak and average individually.
 2. "-": The Quasi-peak reading value also meets average limit and measurement with the average detector is unnecessary.
 3. The emission levels of other frequencies were very low against the limit.
 4. Margin value = Emission level - Limit value
 5. Correction factor = Insertion loss + Cable loss
 6. Emission Level = Correction Factor + Reading Value.

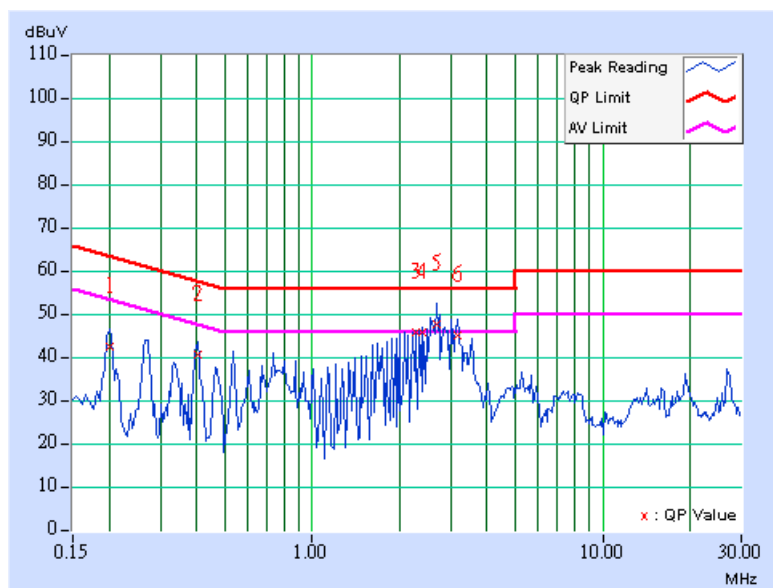

MODULATION TYPE	BPSK	6dB BANDWIDTH	9 kHz
INPUT POWER	DC 3.3V	TRANSFER RATE	6Mbps
ENVIRONMENTAL CONDITIONS	22deg. C, 50%RH, 965hPa	PHASE	Negative
TESTED BY	Sky Liao		

No	Freq. [MHz]	Corr. Factor (dB)	Reading Value		Emission Level		Limit		Margin	
			[dB (uV)]		[dB (uV)]		[dB (uV)]		(dB)	
			Q.P.	AV.	Q.P.	AV.	Q.P.	AV.	Q.P.	AV.
1	0.201	9.60	32.52	-	42.12	-	63.58	53.58	-21.46	-
2	0.400	9.60	31.47	-	41.07	-	57.85	47.85	-16.78	-
3	2.145	9.70	35.68	-	45.38	-	56.00	46.00	-10.62	-
4	2.410	9.70	37.26	35.85	46.96	45.55	56.00	46.00	-9.04	-0.45
5	2.477	9.70	36.84	35.78	46.54	45.48	56.00	46.00	-9.46	-0.52
6	2.813	9.70	37.77	35.79	47.47	45.49	56.00	46.00	-8.53	-0.51

- REMARKS:**
1. Q.P. and AV. are abbreviations of quasi-peak and average individually.
 2. "-": The Quasi-peak reading value also meets average limit and measurement with the average detector is unnecessary.
 3. The emission levels of other frequencies were very low against the limit.
 4. Margin value = Emission level - Limit value
 5. Correction factor = Insertion loss + Cable loss
 6. Emission Level = Correction Factor + Reading Value.

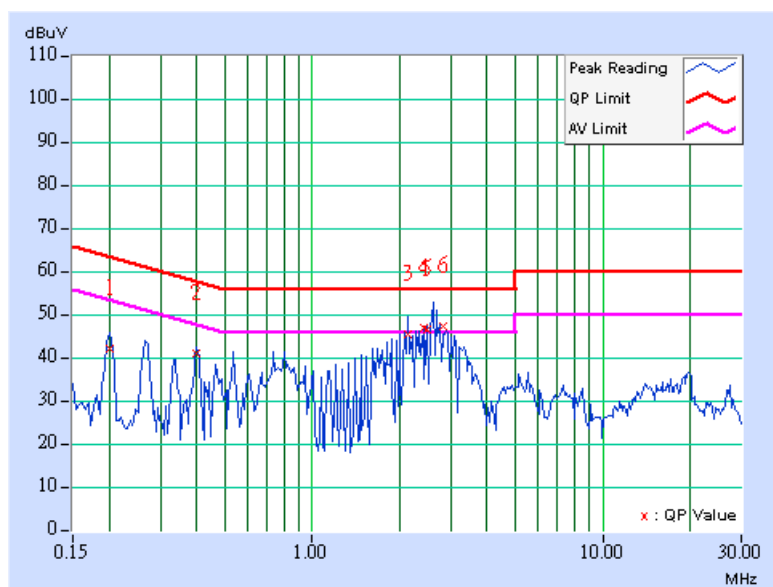

4.2 RADIATED EMISSION MEASUREMENT

4.2.1 LIMITS OF RADIATED EMISSION MEASUREMENT

Emissions radiated outside of the specified bands, shall be according to the general radiated limits in 15.209 as following:

Frequencies (MHz)	Field strength (microvolts/meter)	Measurement distance (meters)
0.009-0.490	2400/F(kHz)	300
0.490-1.705	24000/F(kHz)	30
1.705-30.0	30	30
30-88	100	3
88-216	150	3
216-960	200	3
Above 960	500	3

NOTE:

1. The lower limit shall apply at the transition frequencies.
2. Emission level (dBuV/m) = 20 log Emission level (uV/m).
3. As shown in 15.35(b), for frequencies above 1000MHz, the field strength limits are based on average detector, however, the peak field strength of any emission shall not exceed the maximum permitted average limits, specified above by more than 20dB under any condition of modulation.



4.2.2 TEST INSTRUMENTS

DESCRIPTION & MANUFACTURER	MODEL NO.	SERIAL NO.	CALIBRATED UNTIL
ADVANTEST Spectrum Analyzer	R3271A	85060311	July 03, 2007
HP Pre_Amplifier	8449B	3008A01922	Sep. 18, 2007
ROHDE & SCHWARZ Test Receiver	ESCS30	100375	Sep. 20, 2007
CHASE Broadband Antenna	VULB9168	138	Dec. 10, 2007
Schwarzbeck Horn_Antenna	BBHA9120	D124	Jan. 01, 2008
Schwarzbeck Horn_Antenna	BBHA 9170	BBHA9170153	Jan. 04, 2008
SCHWARZBECK Biconical Antenna	VHBA9123	459	Jun. 08, 2009
SCHWARZBECK Periodic Antenna	UPA6108	1148	Jun. 08, 2009
R&S Loop Antenna	HFH2-Z2	881058/15	Nov. 29, 2007
RF Switches (ARNITSU)	CS-201	1565157	NA
RF CABLE (Chaintek)	SF102	22054-2	Nov. 14. 2007
RF Cable(RICHTEC)	9913-30M N-N Cable	STCCAB-30M-1 GHz	Jul. 15, 2007
Software	ADT_Radiated_V 5.14	NA	NA
CHANCE MOST Antenna Tower	AT-100	0203	NA
CHANCE MOST Turn Table	TT-100	0203	NA

- Note: 1. The calibration interval of the above test instruments is 12 months (36 months for Biconical and Periodic Antenna) and the calibrations are traceable to NML/ROC and NIST/USA.
2. The horn antenna, HP preamplifier (model: 8449B) and Spectrum Analyzer (model: R3271A) are used only for the measurement of emission frequency above 1GHz if tested.
3. The test was performed in ADT Open Site No. C.
4. The FCC Site Registration No. is 656396.
5. The VCCI Site Registration No. is R-1626.
6. The CANADA Site Registration No. is IC 4824A-3.
7. Loop antenna was used for all emissions below 30 MHz.

4.2.3 TEST PROCEDURES

- a. The EUT was placed on the top of a rotating table 0.8 meters above the ground at a 3 meter semi- anechoic. The table was rotated 360 degrees to determine the position of the highest radiation.
- b. The EUT was set 3 meters away from the interference-receiving antenna, which was mounted on the top of a variable-height antenna tower.
- c. The antenna is a broadband antenna, and its height is varied from one meter to four meters above the ground to determine the maximum value of the field strength. Both horizontal and vertical polarizations of the antenna are set to make the measurement.
- d. For each suspected emission, the EUT was arranged to its worst case and then the antenna was tuned to heights from 1 meter to 4 meters and the rotatable table was turned from 0 degrees to 360 degrees to find the maximum reading.
- e. The test-receiver system was set to Peak Detect Function and Specified Bandwidth with Maximum Hold Mode.
- f. If the emission level of the EUT in peak mode was 10 dB lower than the limit specified, then testing could be stopped and the peak values of the EUT would be reported. Otherwise the emissions that did not have 10 dB margin would be re-tested one by one using the quasi-peak method or average method as specified and then reported in Data sheet peak mode and QP mode.

NOTE:

1. The resolution bandwidth and video bandwidth of test receiver/spectrum analyzer is 120kHz for Quasi-peak detection at frequency below 1GHz.
2. The resolution bandwidth is 1MHz and video bandwidth of test receiver/spectrum analyzer is 3MHz for Peak detection at frequency above 1GHz. The resolution bandwidth of test receiver/spectrum analyzer is 1 MHz for Average detection (AV) at frequency above 1GHz.
3. The resolution bandwidth of test receiver/spectrum analyzer is 1 MHz and the video bandwidth is 10 Hz for Average detection (AV) at frequency above 1GHz.

4.2.4 DEVIATION FROM TEST STANDARD

No deviation

4.2.5 TEST SETUP

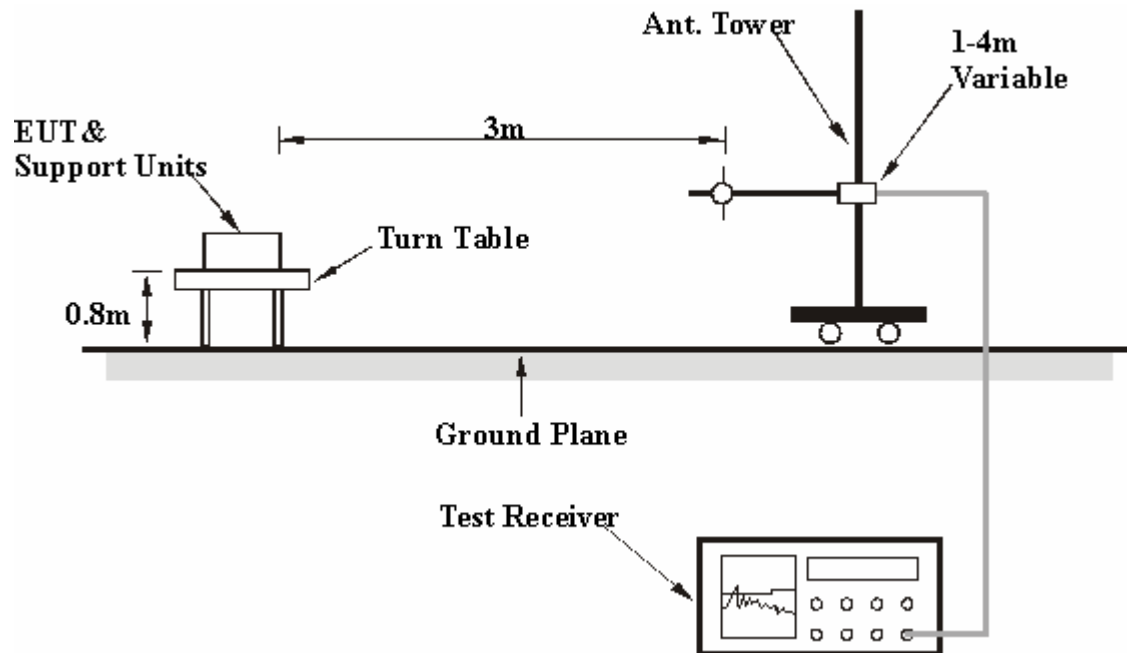

For the actual test configuration, please refer to the related item – Photographs of the Test Configuration.

4.2.6 EUT OPERATING CONDITIONS

- a. Connect the EUT with the support unit 1 (Notebook computer) which placed on a testing table.
- b. The support unit 1 (Notebook computer) ran a test program “Art 53 b 5” to enable EUT under transmission condition continuously.
- c. Notebook computer sends "H" messages to printer, and the printer prints them on paper.

4.2.7 TEST RESULTS

Below 1GHz Worst-Case Data

MODULATION TYPE	BPSK	FREQUENCY RANGE	Below 1000MHz
INPUT POWER (SYSTEM)	120Vac, 60 Hz	TRANSFER RATE	6Mbps
ENVIRONMENTAL CONDITIONS	25deg. C, 55%RH, 965hPa	DETECTOR FUNCTION	Quasi-Peak
TESTED BY	Sky Liao		

ANTENNA POLARITY & TEST DISTANCE: HORIZONTAL AT 3 M

No.	Freq. (MHz)	Emission Level (dBuV/m)	Limit (dBuV/m)	Margin (dB)	Antenna Height (m)	Table Angle (Degree)	Raw Value (dBuV)	Correction Factor (dB/m)
1	66.59	33.40 QP	40.00	-6.60	2.95 H	128	20.40	13.00
2	133.33	37.70 QP	43.50	-5.80	2.05 H	75	24.80	12.90
3	166.62	40.40 QP	43.50	-3.10	1.52 H	314	26.60	13.80
4	199.88	37.10 QP	43.50	-6.40	1.28 H	68	25.50	11.60
5	233.18	42.00 QP	46.00	-4.00	1.26 H	28	29.00	13.00
6	299.75	44.60 QP	46.00	-1.40	1.00 H	42	27.80	16.80
7	332.60	44.00 QP	46.00	-2.00	1.02 H	334	26.80	17.20
8	366.48	38.90 QP	46.00	-7.10	1.86 H	116	21.00	17.90
9	433.11	43.20 QP	46.00	-2.80	1.74 H	132	23.20	20.00
10	566.37	32.80 QP	46.00	-13.20	1.05 H	125	9.20	23.60
11	799.99	37.20 QP	46.00	-8.80	1.04 H	123	9.60	27.60
12	988.98	37.50 QP	54.00	-16.50	1.03 H	72	7.60	29.90

ANTENNA POLARITY & TEST DISTANCE: VERTICAL AT 3 M

No.	Freq. (MHz)	Emission Level (dBuV/m)	Limit (dBuV/m)	Margin (dB)	Antenna Height (m)	Table Angle (Degree)	Raw Value (dBuV)	Correction Factor (dB/m)
1	66.62	34.80 QP	40.00	-5.20	1.00 V	158	21.80	13.00
2	72.66	34.60 QP	40.00	-5.40	1.00 V	86	22.70	11.90
3	133.35	36.00 QP	43.50	-7.50	1.00 V	234	23.10	12.90
4	166.58	36.20 QP	43.50	-7.30	1.00 V	106	22.40	13.80
5	168.02	39.40 QP	43.50	-4.10	1.00 V	18	25.70	13.70
6	199.96	36.10 QP	43.50	-7.40	1.00 V	42	24.50	11.60
7	233.15	42.20 QP	46.00	-3.80	1.00 V	48	29.20	13.00
8	366.42	42.20 QP	46.00	-3.80	1.00 V	102	24.30	17.90
9	399.99	41.80 QP	46.00	-4.20	1.00 V	128	22.80	19.00
10	433.08	41.80 QP	46.00	-4.20	1.00 V	168	21.80	20.00
11	998.99	42.60 QP	54.00	-11.40	1.00 V	75	12.70	29.90

- REMARKS:**
1. Emission level(dBuV/m)=Raw Value(dBuV) + Correction Factor(dB/m)
 2. Correction Factor(dB/m) = Antenna Factor (dB/m) + Cable Factor (dB)
 3. The other emission levels were very low against the limit.
 4. Margin value = Emission level – Limit value

802.11b DSSS modulation

CHANNEL	Channel 1	FREQUENCY RANGE	1 ~ 25GHz
MODULATION TYPE	CCK	TRANSFER RATE	1Mbps
INPUT POWER (SYSTEM)	120Vac, 60 Hz	DETECTOR FUNCTION	Peak(PK) Average (AV)
ENVIRONMENTAL CONDITIONS	17deg. C, 68%RH, 965hPa	TESTED BY	Rex Huang

ANTENNA POLARITY & TEST DISTANCE: HORIZONTAL AT 3 M

No.	Freq. (MHz)	Emission Level (dBuV/m)	Limit (dBuV/m)	Margin (dB)	Antenna Height (m)	Table Angle (Degree)	Raw Value (dBuV)	Correction Factor (dB/m)
1	2386.00	59.30 PK	74.00	-14.70	1.17 H	313	27.40	31.90
1	2386.00	48.40 AV	54.00	-5.60	1.17 H	313	16.50	31.90
2	*2412.00	105.40 PK			1.17 H	313	73.40	32.00
2	*2412.00	100.70 AV			1.17 H	313	68.70	32.00
3	4824.00	47.10 PK	74.00	-26.90	1.08 H	96	11.10	36.00
3	4824.00	36.30 AV	54.00	-17.70	1.08 H	96	0.30	36.00
4	7236.00	52.90 PK	74.00	-21.10	1.05 H	307	10.60	42.20
4	7236.00	39.50 AV	54.00	-14.50	1.05 H	307	-2.80	42.20

ANTENNA POLARITY & TEST DISTANCE: VERTICAL AT 3 M

No.	Freq. (MHz)	Emission Level (dBuV/m)	Limit (dBuV/m)	Margin (dB)	Antenna Height (m)	Table Angle (Degree)	Raw Value (dBuV)	Correction Factor (dB/m)
1	2386.00	62.50 PK	74.00	-11.50	1.27 V	304	30.60	31.90
1	2386.00	53.30 AV	54.00	-0.70	1.27 V	304	21.40	31.90
2	*2412.00	111.60 PK			1.26 V	308	79.60	32.00
2	*2412.00	107.00 AV			1.26 V	308	75.00	32.00
3	4824.00	48.80 PK	74.00	-25.20	1.17 V	270	12.80	36.00
3	4824.00	39.70 AV	54.00	-14.30	1.17 V	270	3.70	36.00
4	7236.00	54.70 PK	74.00	-19.30	1.34 V	28	12.40	42.20
4	7236.00	40.10 AV	54.00	-13.90	1.34 V	28	-2.20	42.20

- REMARKS:**
1. Emission level(dBuV/m)=Raw Value(dBuV) + Correction Factor(dB/m)
 2. Correction Factor(dB/m) = Antenna Factor (dB/m) + Cable Factor (dB)
 3. The other emission levels were very low against the limit.
 4. Margin value = Emission level – Limit value.
 5. The limit value is defined as per 15.247
 6. “ * “ : Fundamental frequency

CHANNEL	Channel 6	FREQUENCY RANGE	1 ~ 25GHz
MODULATION TYPE	CCK	TRANSFER RATE	1Mbps
INPUT POWER (SYSTEM)	120Vac, 60 Hz	DETECTOR FUNCTION	Peak(PK) Average (AV)
ENVIRONMENTAL CONDITIONS	17deg. C, 68%RH, 965hPa	TESTED BY	Rex Huang

ANTENNA POLARITY & TEST DISTANCE: HORIZONTAL AT 3 M								
No.	Freq. (MHz)	Emission Level (dBuV/m)	Limit (dBuV/m)	Margin (dB)	Antenna Height (m)	Table Angle (Degree)	Raw Value (dBuV)	Correction Factor (dB/m)
1	2390.00	59.60 PK	74.00	-14.40	1.12 H	311	27.70	31.90
1	2390.00	47.30 AV	54.00	-6.70	1.12 H	311	15.40	31.90
2	*2437.00	111.90 PK			1.12 H	311	79.80	32.10
2	*2437.00	107.50 AV			1.12 H	311	75.40	32.10
3	2483.50	60.00 PK	74.00	-14.00	1.12 H	311	27.70	32.30
3	2483.50	46.50 AV	54.00	-7.50	1.12 H	311	14.20	32.30
4	4874.00	55.00 PK	74.00	-19.00	1.12 H	100	18.90	36.10
4	4874.00	51.20 AV	54.00	-2.80	1.12 H	100	15.10	36.10
5	7311.00	58.80 PK	74.00	-15.20	1.01 H	284	16.20	42.50
5	7311.00	44.70 AV	54.00	-9.30	1.01 H	284	2.10	42.50

ANTENNA POLARITY & TEST DISTANCE: VERTICAL AT 3 M								
No.	Freq. (MHz)	Emission Level (dBuV/m)	Limit (dBuV/m)	Margin (dB)	Antenna Height (m)	Table Angle (Degree)	Raw Value (dBuV)	Correction Factor (dB/m)
1	2390.00	63.00 PK	74.00	-11.00	1.21 V	308	31.10	31.90
1	2390.00	50.10 AV	54.00	-3.90	1.21 V	308	18.20	31.90
2	*2437.00	120.20 PK			1.21 V	308	88.10	32.10
2	*2437.00	115.50 AV			1.21 V	308	83.40	32.10
3	2483.50	64.10 PK	74.00	-9.90	1.21 V	308	31.80	32.30
3	2483.50	51.80 AV	54.00	-2.20	1.21 V	308	19.50	32.30
4	4874.00	56.70 PK	74.00	-17.30	1.15 V	265	20.60	36.10
4	4874.00	53.80 AV	54.00	-0.20	1.15 V	265	17.70	36.10
5	7311.00	65.60 PK	74.00	-8.40	1.23 V	95	23.00	42.50
5	7311.00	50.80 AV	54.00	-3.20	1.23 V	95	8.20	42.50

- REMARKS:**
1. Emission level(dBuV/m)=Raw Value(dBuV) + Correction Factor(dB/m)
 2. Correction Factor(dB/m) = Antenna Factor (dB/m) + Cable Factor (dB)
 3. The other emission levels were very low against the limit.
 4. Margin value = Emission level – Limit value.
 5. The limit value is defined as per 15.247
 6. " * " : Fundamental frequency

CHANNEL	Channel 11	FREQUENCY RANGE	1 ~ 25GHz
MODULATION TYPE	CCK	TRANSFER RATE	1Mbps
INPUT POWER (SYSTEM)	120Vac, 60 Hz	DETECTOR FUNCTION	Peak(PK) Average (AV)
ENVIRONMENTAL CONDITIONS	17deg. C, 68%RH, 965hPa	TESTED BY	Rex Huang

ANTENNA POLARITY & TEST DISTANCE: HORIZONTAL AT 3 M								
No.	Freq. (MHz)	Emission Level (dBuV/m)	Limit (dBuV/m)	Margin (dB)	Antenna Height (m)	Table Angle (Degree)	Raw Value (dBuV)	Correction Factor (dB/m)
1	*2462.00	110.70 PK			1.14 H	307	78.50	32.20
1	*2462.00	107.00 AV			1.14 H	307	74.80	32.20
2	2488.00	61.40 PK	74.00	-12.60	1.14 H	307	29.10	32.30
2	2488.00	49.20 AV	54.00	-4.80	1.14 H	307	16.90	32.30
3	4924.00	53.80 PK	74.00	-20.20	1.12 H	9	17.60	36.20
3	4924.00	49.20 AV	54.00	-4.80	1.12 H	9	13.00	36.20
4	7386.00	57.40 PK	74.00	-16.60	1.03 H	297	14.70	42.80
4	7386.00	43.80 AV	54.00	-10.20	1.03 H	297	1.10	42.80

ANTENNA POLARITY & TEST DISTANCE: VERTICAL AT 3 M								
No.	Freq. (MHz)	Emission Level (dBuV/m)	Limit (dBuV/m)	Margin (dB)	Antenna Height (m)	Table Angle (Degree)	Raw Value (dBuV)	Correction Factor (dB/m)
1	*2462.00	119.20 PK			1.21 V	309	87.00	32.20
1	*2462.00	114.40 AV			1.21 V	309	82.20	32.20
2	2488.00	64.20 PK	74.00	-9.80	1.21 V	309	31.90	32.30
2	2488.00	53.70 AV	54.00	-0.30	1.21 V	309	21.40	32.30
3	4924.00	56.70 PK	74.00	-17.30	1.22 V	265	20.50	36.20
3	4924.00	53.50 AV	54.00	-0.50	1.22 V	265	17.30	36.20
4	7386.00	62.10 PK	74.00	-11.90	1.23 V	95	19.40	42.80
4	7386.00	47.70 AV	54.00	-6.30	1.23 V	95	5.00	42.80

- REMARKS:**
1. Emission level(dBuV/m)=Raw Value(dBuV) + Correction Factor(dB/m)
 2. Correction Factor(dB/m) = Antenna Factor (dB/m) + Cable Factor (dB)
 3. The other emission levels were very low against the limit.
 4. Margin value = Emission level – Limit value.
 5. The limit value is defined as per 15.247
 6. “ * “ : Fundamental frequency

RESTRICTED BANDEDGE (802.11b MODE, CH1, HORIZONTAL)

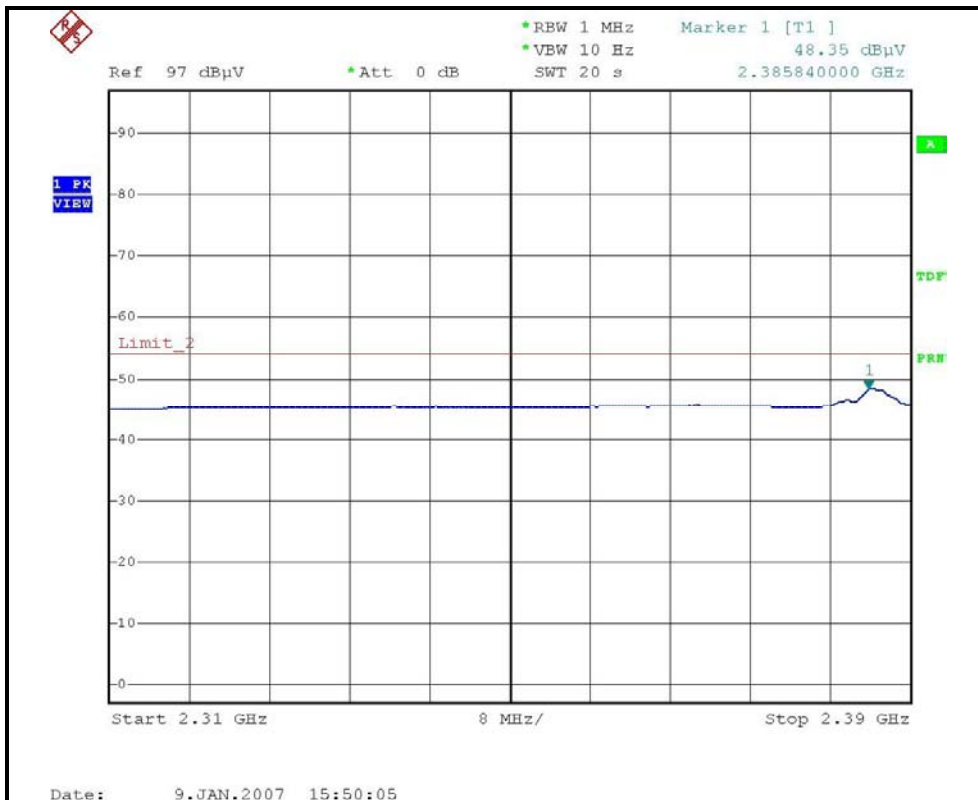
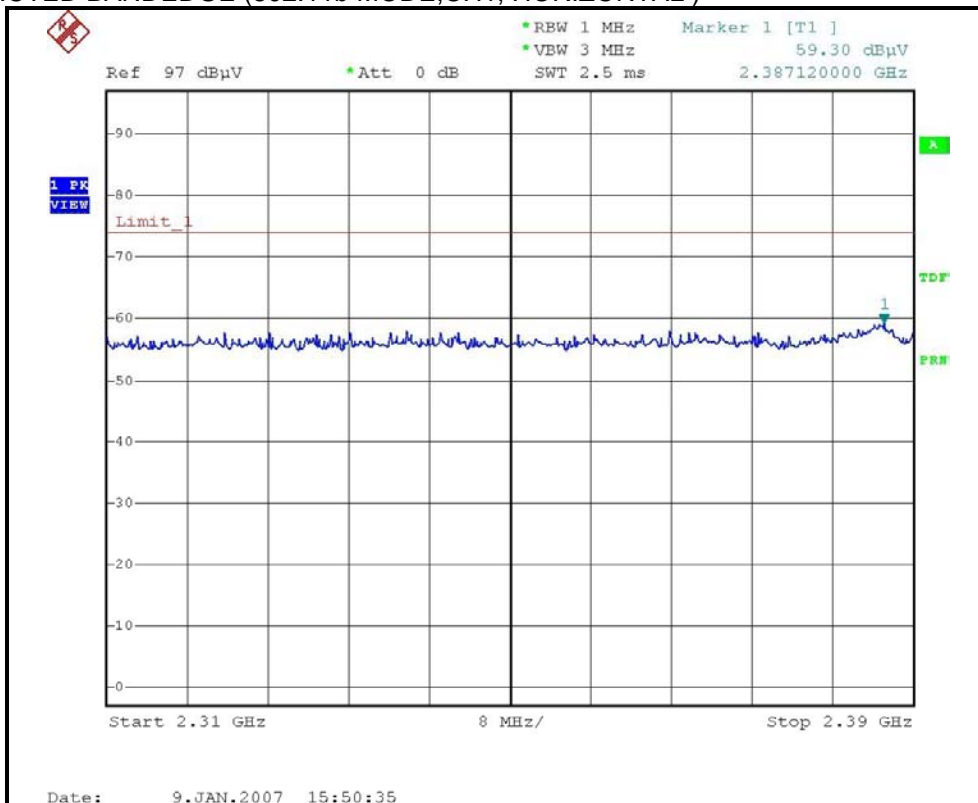

RESTRICTED BANDEDGE (802.11b MODE, CH1, VERTICAL)

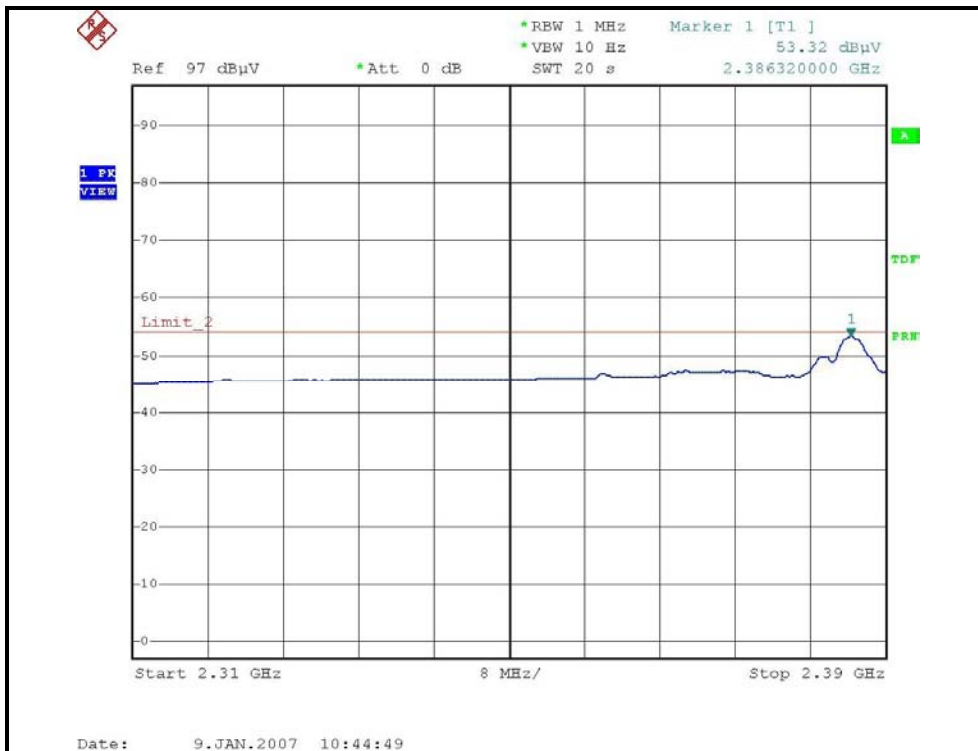
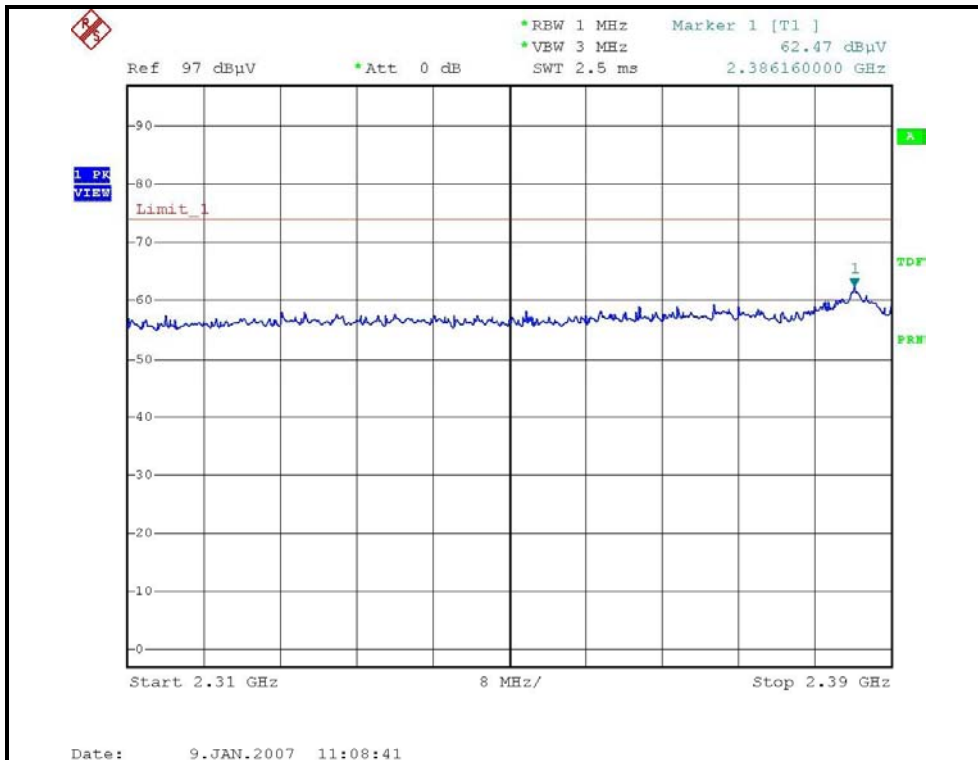

RESTRICTED BANDEDGE (802.11b MODE,CH11, HORIZONTAL)

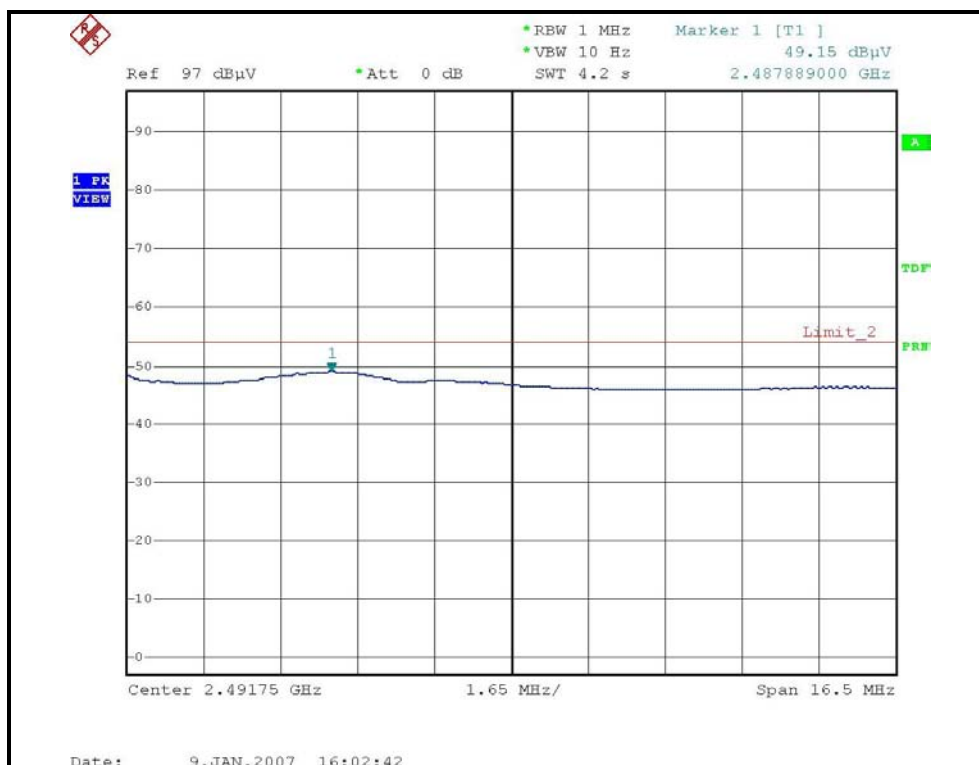
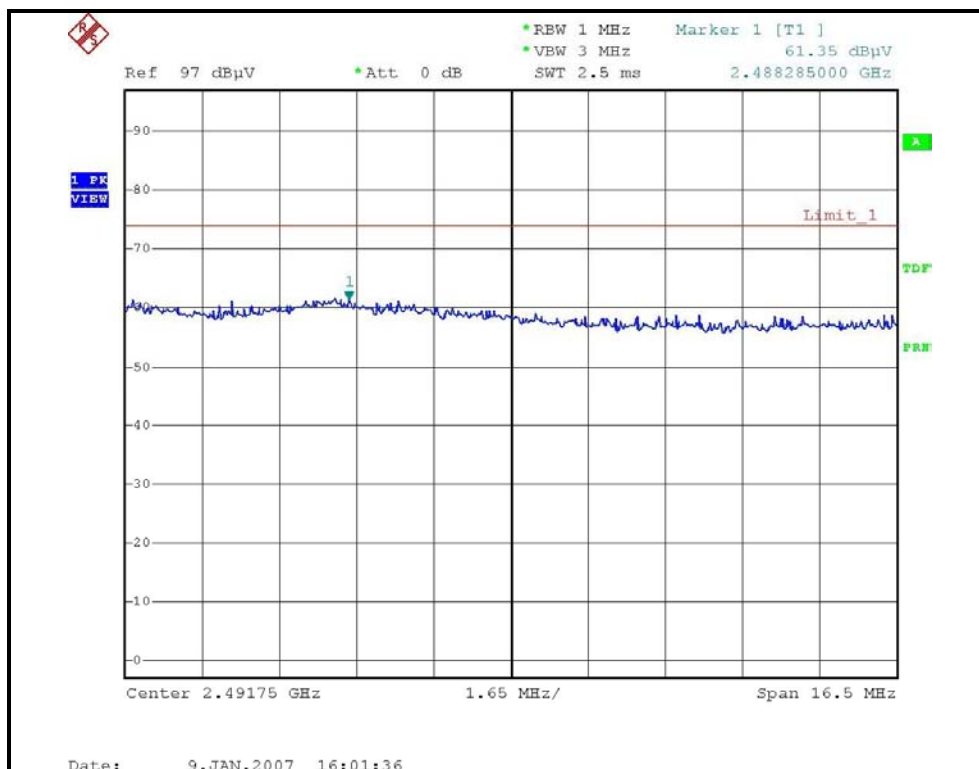



802.11g OFDM modulation

CHANNEL	Channel 1	FREQUENCY RANGE	1 ~ 25GHz
MODULATION TYPE	BPSK	TRANSFER RATE	6Mbps
INPUT POWER (SYSTEM)	120Vac, 60 Hz	DETECTOR FUNCTION	Peak(PK) Average (AV)
ENVIRONMENTAL CONDITIONS	17deg. C, 68%RH, 965hPa	TESTED BY	Rex Huang

ANTENNA POLARITY & TEST DISTANCE: HORIZONTAL AT 3 M

No.	Freq. (MHz)	Emission Level (dBuV/m)	Limit (dBuV/m)	Margin (dB)	Antenna Height (m)	Table Angle (Degree)	Raw Value (dBuV)	Correction Factor (dB/m)
1	2390.00	63.10 PK	74.00	-10.90	1.16 H	312	31.20	31.90
1	2390.00	48.10 AV	54.00	-5.90	1.16 H	312	16.20	31.90
2	*2412.00	105.70 PK			1.16 H	312	73.70	32.00
2	*2412.00	94.60 AV			1.16 H	312	62.60	32.00
3	4824.00	47.00 PK	74.00	-27.00	1.09 H	98	11.00	36.00
3	4824.00	33.20 AV	54.00	-20.80	1.09 H	98	-2.80	36.00
4	7236.00	52.80 PK	74.00	-21.20	1.01 H	312	10.50	42.20
4	7236.00	39.20 AV	54.00	-14.80	1.01 H	312	-3.10	42.20

ANTENNA POLARITY & TEST DISTANCE: VERTICAL AT 3 M

No.	Freq. (MHz)	Emission Level (dBuV/m)	Limit (dBuV/m)	Margin (dB)	Antenna Height (m)	Table Angle (Degree)	Raw Value (dBuV)	Correction Factor (dB/m)
1	2390.00	69.80 PK	74.00	-4.20	1.29 V	252	37.90	31.90
1	2390.00	53.50 AV	54.00	-0.50	1.29 V	252	21.60	31.90
2	*2412.00	112.30 PK			1.21 V	307	80.30	32.00
2	*2412.00	101.40 AV			1.21 V	307	69.40	32.00
3	4824.00	47.10 PK	74.00	-26.90	1.17 V	274	11.10	36.00
3	4824.00	33.10 AV	54.00	-20.90	1.17 V	274	-2.90	36.00
4	7236.00	53.10 PK	74.00	-20.90	1.32 V	31	10.80	42.20
4	7236.00	39.60 AV	54.00	-14.40	1.32 V	31	-2.70	42.20

- REMARKS:**
1. Emission level(dBuV/m)=Raw Value(dBuV) + Correction Factor(dB/m)
 2. Correction Factor(dB/m) = Antenna Factor (dB/m) + Cable Factor (dB)
 3. The other emission levels were very low against the limit.
 4. Margin value = Emission level – Limit value.
 5. The limit value is defined as per 15.247
 6. “ * “ : Fundamental frequency

CHANNEL	Channel 6	FREQUENCY RANGE	1 ~ 25GHz
MODULATION TYPE	BPSK	TRANSFER RATE	6Mbps
INPUT POWER (SYSTEM)	120Vac, 60 Hz	DETECTOR FUNCTION	Peak(PK) Average (AV)
ENVIRONMENTAL CONDITIONS	17deg. C, 68%RH, 965hPa	TESTED BY	Rex Huang

ANTENNA POLARITY & TEST DISTANCE: HORIZONTAL AT 3 M

No.	Freq. (MHz)	Emission Level (dBuV/m)	Limit (dBuV/m)	Margin (dB)	Antenna Height (m)	Table Angle (Degree)	Raw Value (dBuV)	Correction Factor (dB/m)
1	2390.00	62.70 PK	74.00	-11.30	1.13 H	308	30.80	31.90
1	2390.00	48.50 AV	54.00	-5.50	1.13 H	308	16.60	31.90
2	*2437.00	115.20 PK			1.13 H	308	83.10	32.10
2	*2437.00	104.40 AV			1.13 H	308	72.30	32.10
3	2483.50	60.20 PK	74.00	-13.80	1.13 H	308	27.90	32.30
3	2483.50	46.50 AV	54.00	-7.50	1.13 H	308	14.20	32.30
4	4874.00	53.40 PK	74.00	-20.60	1.11 H	96	17.30	36.10
4	4874.00	39.20 AV	54.00	-14.80	1.11 H	96	3.10	36.10
5	7311.00	57.00 PK	74.00	-17.00	1.04 H	292	14.40	42.50
5	7311.00	43.10 AV	54.00	-10.90	1.04 H	292	0.50	42.50

ANTENNA POLARITY & TEST DISTANCE: VERTICAL AT 3 M

No.	Freq. (MHz)	Emission Level (dBuV/m)	Limit (dBuV/m)	Margin (dB)	Antenna Height (m)	Table Angle (Degree)	Raw Value (dBuV)	Correction Factor (dB/m)
1	2390.00	66.50 PK	74.00	-7.50	1.21 V	309	34.60	31.90
1	2390.00	52.30 AV	54.00	-1.70	1.21 V	309	20.40	31.90
2	*2437.00	122.60 PK			1.21 V	309	90.50	32.10
2	*2437.00	112.00 AV			1.21 V	309	79.90	32.10
3	2483.50	71.40 PK	74.00	-2.60	1.21 V	309	39.10	32.30
3	2483.50	52.60 AV	54.00	-1.40	1.21 V	309	20.30	32.30
4	4874.00	56.80 PK	74.00	-17.20	1.15 V	265	20.70	36.10
4	4874.00	42.00 AV	54.00	-12.00	1.15 V	265	5.90	36.10
5	7311.00	66.20 PK	74.00	-7.80	1.24 V	97	23.60	42.50
5	7311.00	49.60 AV	54.00	-4.40	1.24 V	97	7.00	42.50

- REMARKS:**
1. Emission level(dBuV/m)=Raw Value(dBuV) + Correction Factor(dB/m)
 2. Correction Factor(dB/m) = Antenna Factor (dB/m) + Cable Factor (dB)
 3. The other emission levels were very low against the limit.
 4. Margin value = Emission level – Limit value.
 5. The limit value is defined as per 15.247
 6. “ * “ : Fundamental frequency

CHANNEL	Channel 11	FREQUENCY RANGE	1 ~ 25GHz
MODULATION TYPE	BPSK	TRANSFER RATE	6Mbps
INPUT POWER (SYSTEM)	120Vac, 60 Hz	DETECTOR FUNCTION	Peak(PK) Average (AV)
ENVIRONMENTAL CONDITIONS	17deg. C, 68%RH, 965hPa	TESTED BY	Rex Huang

ANTENNA POLARITY & TEST DISTANCE: HORIZONTAL AT 3 M								
No.	Freq. (MHz)	Emission Level (dBuV/m)	Limit (dBuV/m)	Margin (dB)	Antenna Height (m)	Table Angle (Degree)	Raw Value (dBuV)	Correction Factor (dB/m)
1	*2462.00	110.30 PK			1.15 H	306	78.10	32.20
1	*2462.00	99.90 AV			1.15 H	306	67.70	32.20
2	2483.50	68.60 PK	74.00	-5.40	1.15 H	306	36.30	32.30
2	2483.50	48.90 AV	54.00	-5.10	1.15 H	306	16.60	32.30
3	4924.00	47.30 PK	74.00	-26.70	1.13 H	105	11.10	36.20
3	4924.00	34.10 AV	54.00	-19.90	1.13 H	105	-2.10	36.20
4	7386.00	53.30 PK	74.00	-20.70	1.03 H	89	10.60	42.80
4	7386.00	40.00 AV	54.00	-14.00	1.03 H	89	-2.70	42.80

ANTENNA POLARITY & TEST DISTANCE: VERTICAL AT 3 M								
No.	Freq. (MHz)	Emission Level (dBuV/m)	Limit (dBuV/m)	Margin (dB)	Antenna Height (m)	Table Angle (Degree)	Raw Value (dBuV)	Correction Factor (dB/m)
1	*2462.00	118.00 PK			1.21 V	308	85.80	32.20
1	*2462.00	107.20 AV			1.21 V	308	75.00	32.20
2	2483.50	73.30 PK	74.00	-0.70	1.21 V	308	41.00	32.30
2	2483.50	53.40 AV	54.00	-0.60	1.21 V	308	21.10	32.30
3	4924.00	52.30 PK	74.00	-21.70	1.22 V	265	16.10	36.20
3	4924.00	37.40 AV	54.00	-16.60	1.22 V	265	1.20	36.20
4	7386.00	54.40 PK	74.00	-19.60	1.25 V	92	11.70	42.80
4	7386.00	40.50 AV	54.00	-13.50	1.25 V	92	-2.20	42.80

- REMARKS:**
1. Emission level(dBuV/m)=Raw Value(dBuV) + Correction Factor(dB/m)
 2. Correction Factor(dB/m) = Antenna Factor (dB/m) + Cable Factor (dB)
 3. The other emission levels were very low against the limit.
 4. Margin value = Emission level – Limit value.
 5. The limit value is defined as per 15.247
 6. “ * “ : Fundamental frequency

RESTRICTED BANDEDGE (802.11g MODE, CH1, VERTICAL)

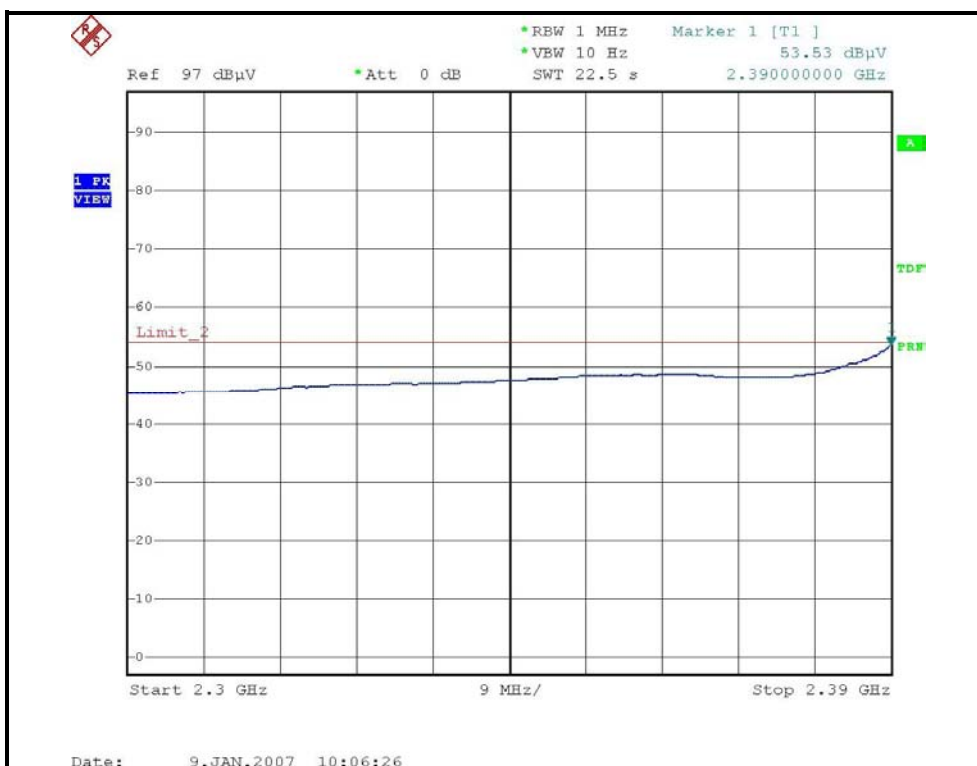
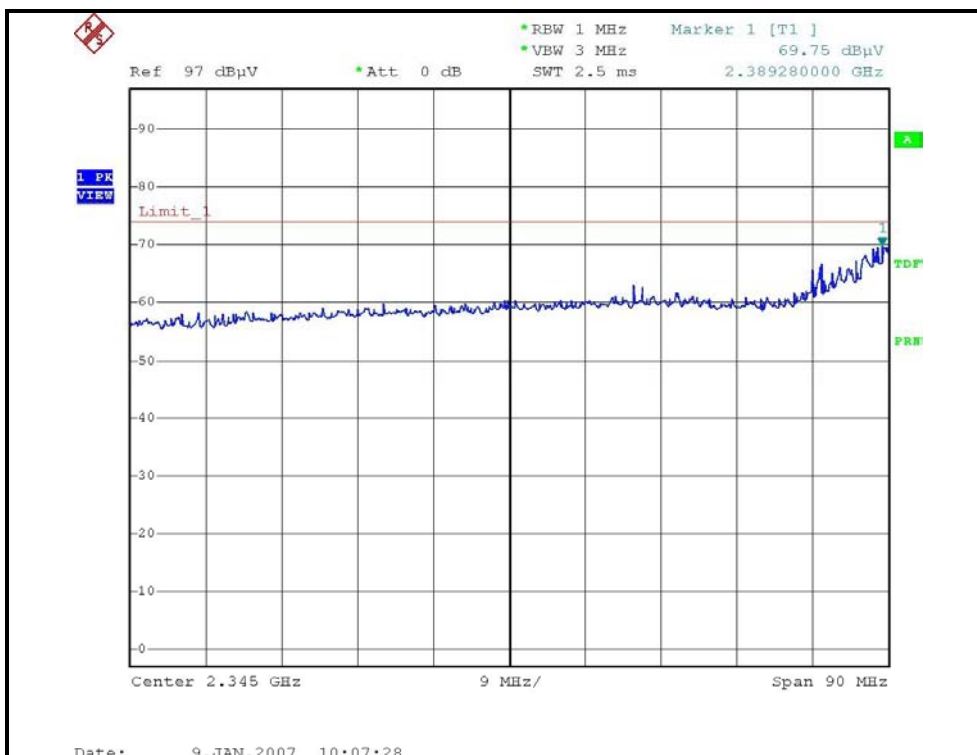

RESTRICTED BANDEDGE (802.11g MODE,CH11, HORIZONTAL)

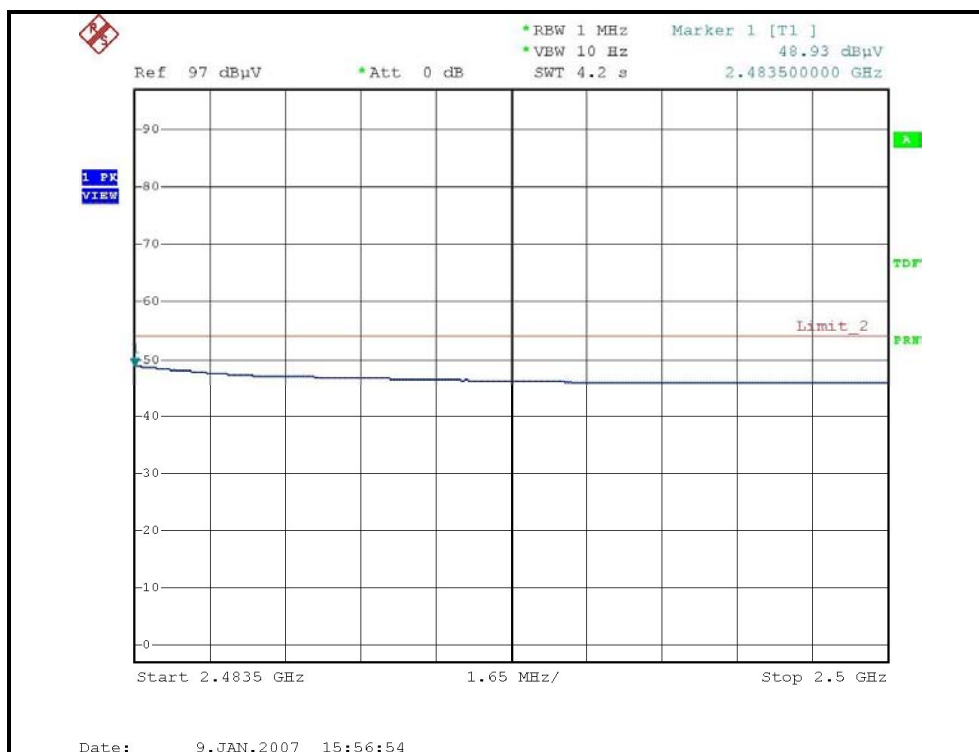
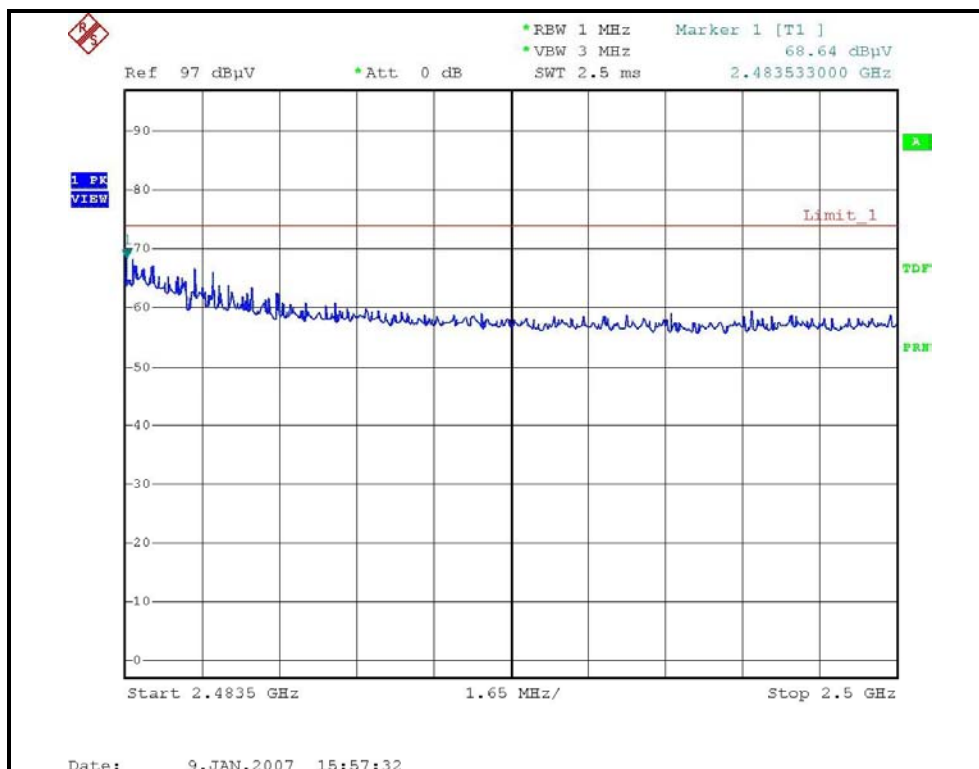

802.11g Turbo OFDM modulation

CHANNEL	Channel 6	FREQUENCY RANGE	1 ~ 25GHz
MODULATION TYPE	BPSK	TRANSFER RATE	12Mbps
INPUT POWER (SYSTEM)	120Vac, 60 Hz	DETECTOR FUNCTION	Peak(PK) Average (AV)
ENVIRONMENTAL CONDITIONS	17deg. C, 68%RH, 965hPa	TESTED BY	Rex Huang

ANTENNA POLARITY & TEST DISTANCE: HORIZONTAL AT 3 M

No.	Freq. (MHz)	Emission Level (dBuV/m)	Limit (dBuV/m)	Margin (dB)	Antenna Height (m)	Table Angle (Degree)	Raw Value (dBuV)	Correction Factor (dB/m)
1	2390.00	60.40 PK	74.00	-13.60	1.12 H	310	28.50	31.90
1	2390.00	48.40 AV	54.00	-5.60	1.12 H	310	16.50	31.90
2	*2437.00	106.00 PK			1.12 H	310	73.90	32.10
2	*2437.00	96.50 AV			1.12 H	310	64.40	32.10
3	2483.50	59.10 PK	74.00	-14.90	1.12 H	310	26.80	32.30
3	2483.50	46.10 AV	54.00	-7.90	1.12 H	310	13.80	32.30
4	4874.00	46.60 PK	74.00	-27.40	1.14 H	97	10.50	36.10
4	4874.00	33.20 AV	54.00	-20.80	1.14 H	97	-2.90	36.10
5	7311.00	53.00 PK	74.00	-21.00	1.07 H	263	10.40	42.50
5	7311.00	39.60 AV	54.00	-14.40	1.07 H	263	-3.00	42.50

ANTENNA POLARITY & TEST DISTANCE: VERTICAL AT 3 M

No.	Freq. (MHz)	Emission Level (dBuV/m)	Limit (dBuV/m)	Margin (dB)	Antenna Height (m)	Table Angle (Degree)	Raw Value (dBuV)	Correction Factor (dB/m)
1	2390.00	69.80 PK	74.00	-4.20	1.21 V	309	37.90	31.90
1	2390.00	53.00 AV	54.00	-1.00	1.21 V	309	21.10	31.90
2	*2437.00	114.50 PK			1.21 V	309	82.40	32.10
2	*2437.00	103.60 AV			1.21 V	309	71.50	32.10
3	2483.50	70.80 PK	74.00	-3.20	1.21 V	309	38.50	32.30
3	2483.50	53.50 AV	54.00	-0.50	1.21 V	309	21.20	32.30
4	4874.00	46.80 PK	74.00	-27.20	1.16 V	262	10.70	36.10
4	4874.00	33.30 AV	54.00	-20.70	1.16 V	262	-2.80	36.10
5	7311.00	53.30 PK	74.00	-20.70	1.23 V	93	10.70	42.50
5	7311.00	39.80 AV	54.00	-14.20	1.23 V	93	-2.80	42.50

- REMARKS:**
1. Emission level(dBuV/m)=Raw Value(dBuV) + Correction Factor(dB/m)
 2. Correction Factor(dB/m) = Antenna Factor (dB/m) + Cable Factor (dB)
 3. The other emission levels were very low against the limit.
 4. Margin value = Emission level – Limit value.
 5. The limit value is defined as per 15.247
 6. “ * “ : Fundamental frequency

RESTRICTED BANDEDGE (802.11g TURBO MODE, CH06, HORIZONTAL)

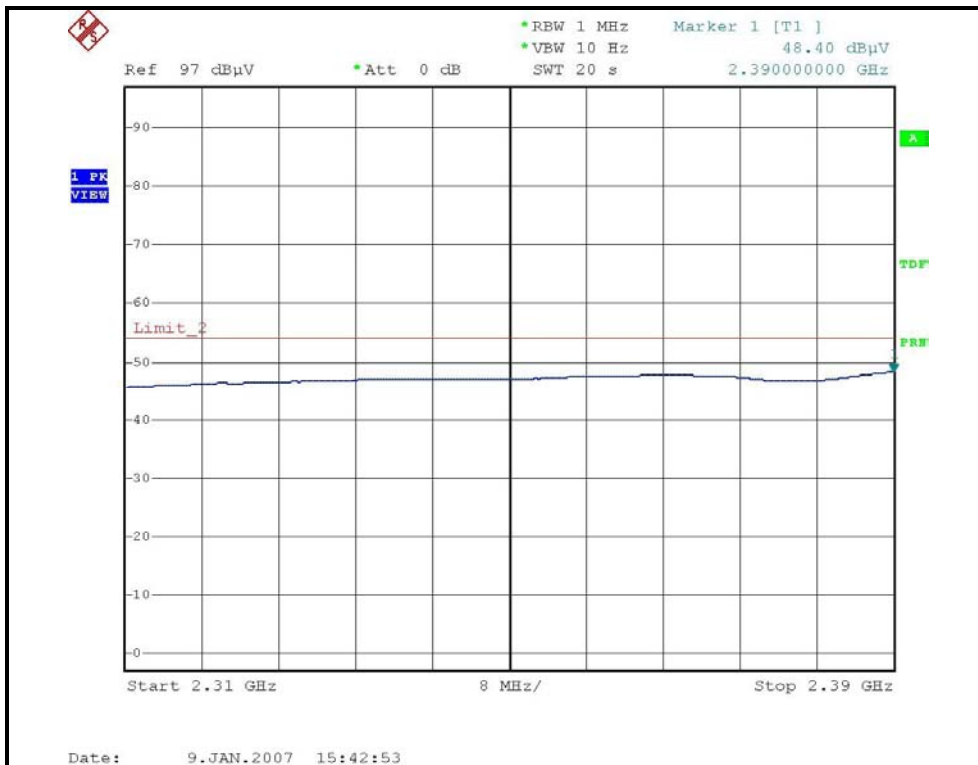
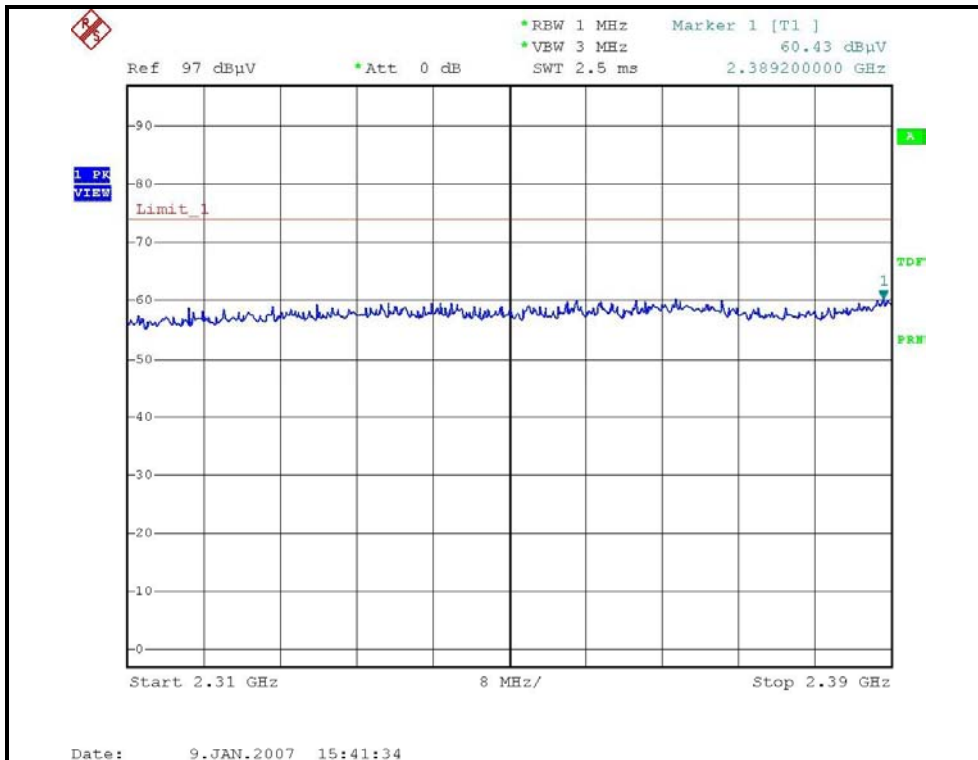

RESTRICTED BANDEDGE (802.11g TURBO MODE, CH06, VERTICAL)

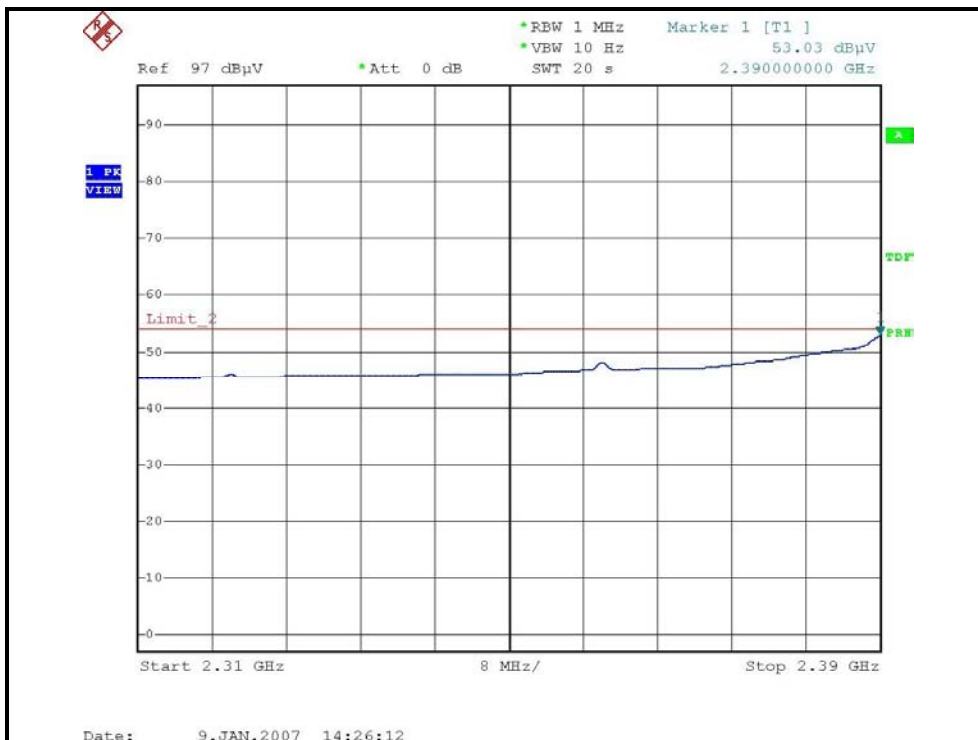
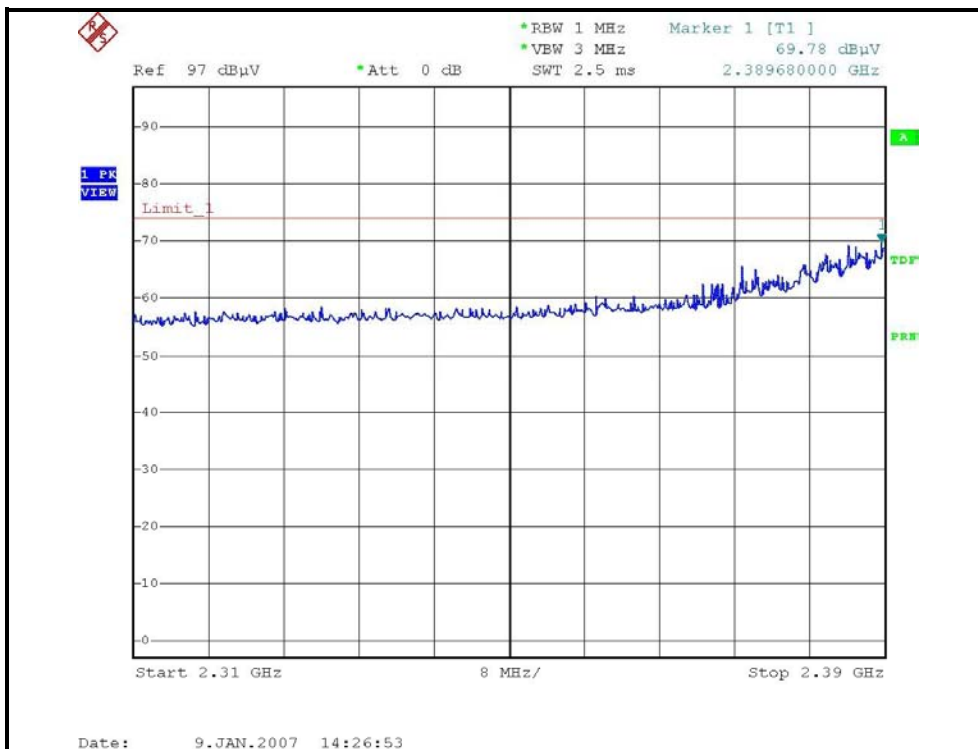

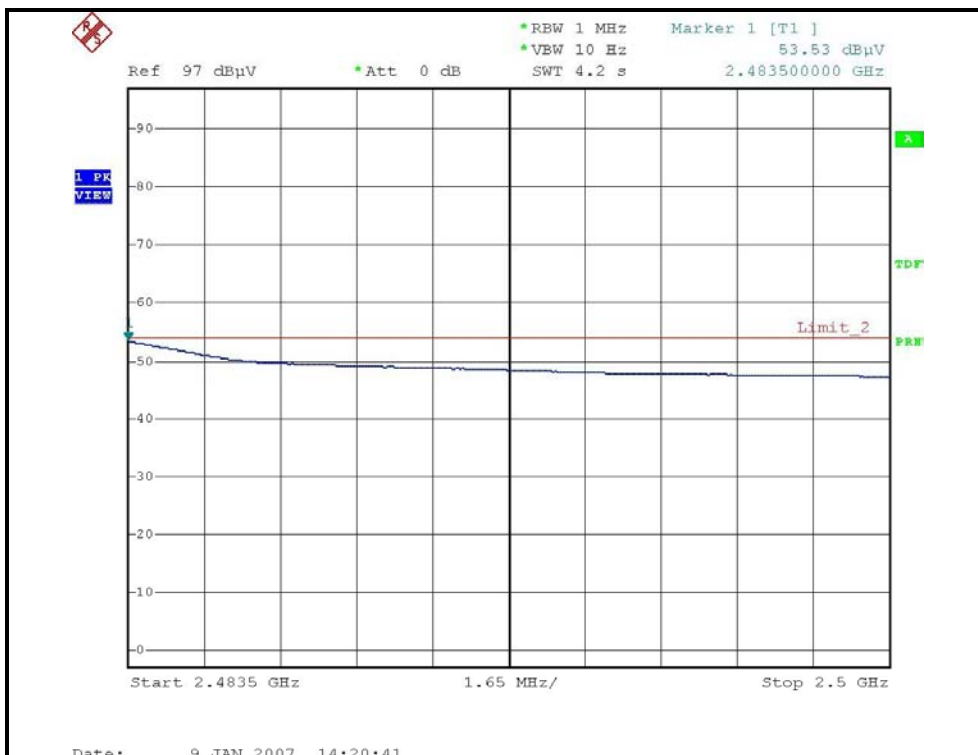
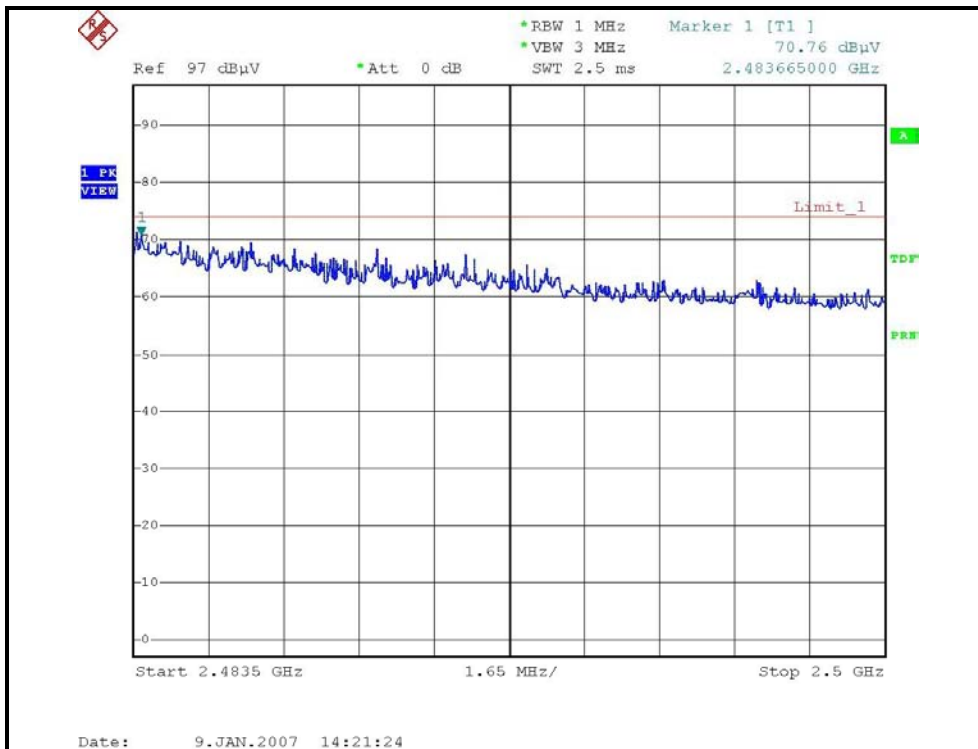



4.3 6dB BANDWIDTH MEASUREMENT

4.3.1 LIMITS OF 6dB BANDWIDTH MEASUREMENT

The minimum of 6dB Bandwidth Measurement is 0.5 MHz.

4.3.2 TEST INSTRUMENTS

Description & Manufacturer	Model No.	Serial No.	Calibrated Until
R&S SPECTRUM ANALYZER	FSP40	100037	Aug. 15, 2007

NOTE:

- 1.The measurement uncertainty is less than +/- 2.6dB, which is calculated as per the NAMAS document NIS81. This uncertainty represents an expanded uncertainty expressed at approximately the 95% confidence level using a coverage factor of k=2.
- 2.The calibration interval of the above test instruments is 12 months and the calibrations are traceable to NML/ROC and NIST/USA.

4.3.3 TEST PROCEDURE

The transmitter output was connected to the spectrum analyzer through an attenuator. The bandwidth of the fundamental frequency was measured by spectrum analyzer with 100kHz RBW and 100kHz VBW. The 6dB bandwidth is defined as the total spectrum the power of which is higher than peak power minus 6dB.

4.3.4 DEVIATION FROM TEST STANDARD

No deviation

4.3.5 TEST SETUP

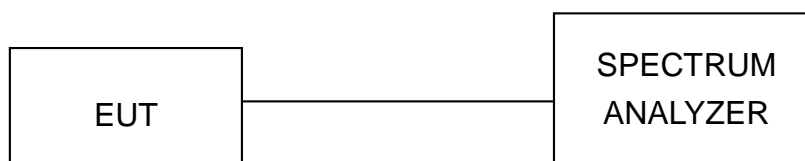

4.3.6 EUT OPERATING CONDITIONS

The software provided by client to enable the EUT under transmission condition continuously at lowest, middle and highest channel frequencies individually.

4.3.7 TEST RESULTS

802.11b DSSS modulation

MODULATION TYPE	CCK	TRANSFER RATE	1Mbps
INPUT POWER (SYSTEM)	120Vac, 60 Hz	ENVIRONMENTAL CONDITIONS	20deg. C, 60%RH, 965hPa
TESTED BY	Sky Liao		

CHANNEL	CHANNEL FREQUENCY (MHz)	6dB BANDWIDTH (MHz)	MINIMUM LIMIT (MHz)	PASS/FAIL
1	2412	13.98	0.5	PASS
6	2437	11.34	0.5	PASS
11	2462	11.34	0.5	PASS

CH1

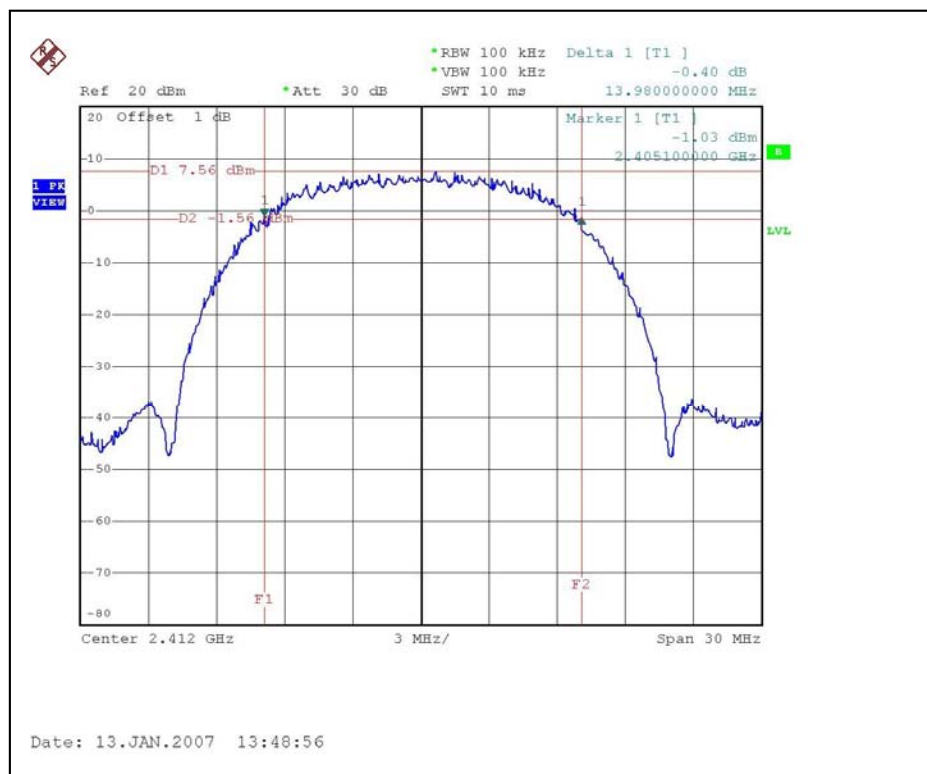

CH6

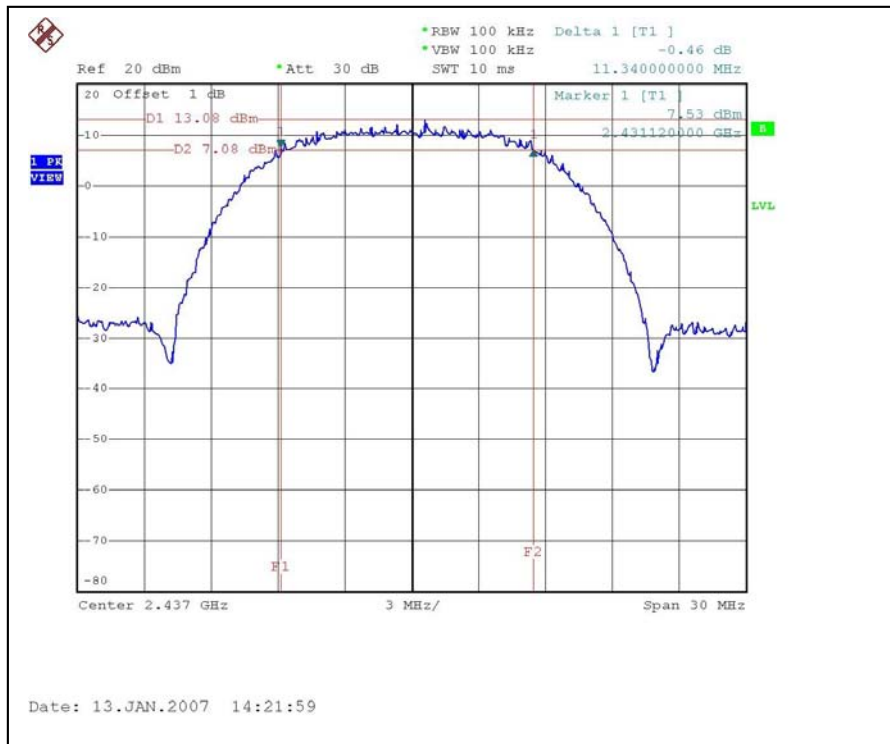

CH11



802.11g OFDM modulation

MODULATION TYPE	BPSK	TRANSFER RATE	6Mbps
INPUT POWER (SYSTEM)	120Vac, 60 Hz	ENVIRONMENTAL CONDITIONS	20deg. C, 60%RH, 965hPa
TESTED BY	Sky Liao		

CHANNEL	CHANNEL FREQUENCY (MHz)	6dB BANDWIDTH (MHz)	MINIMUM LIMIT (MHz)	PASS/FAIL
1	2412	16.44	0.5	PASS
6	2437	16.38	0.5	PASS
11	2462	16.38	0.5	PASS

CH1

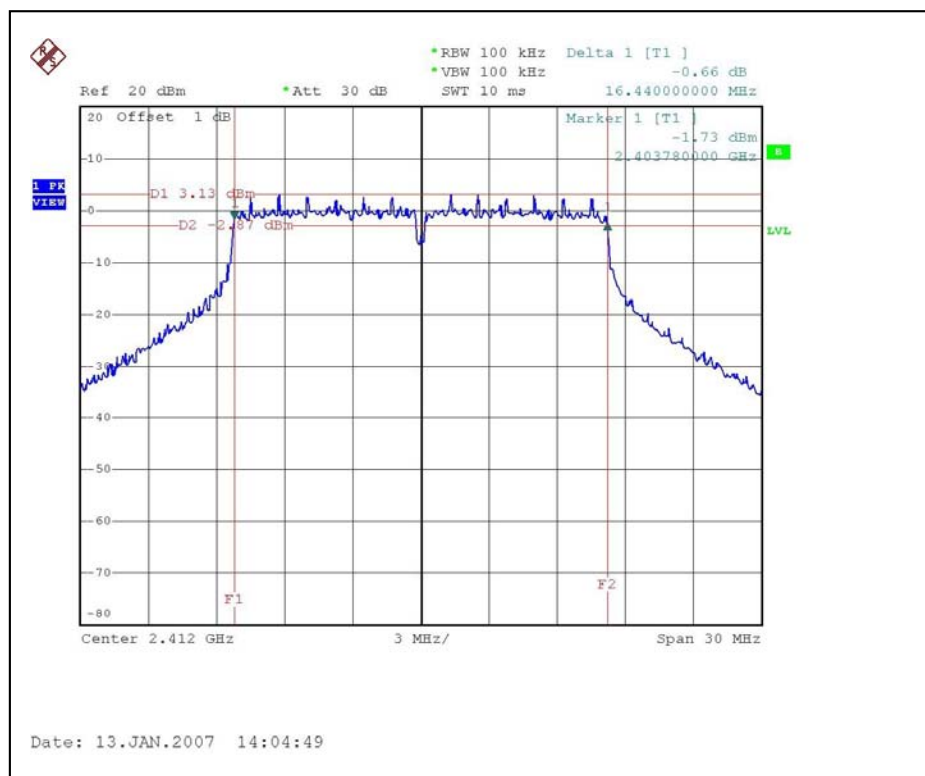

CH6

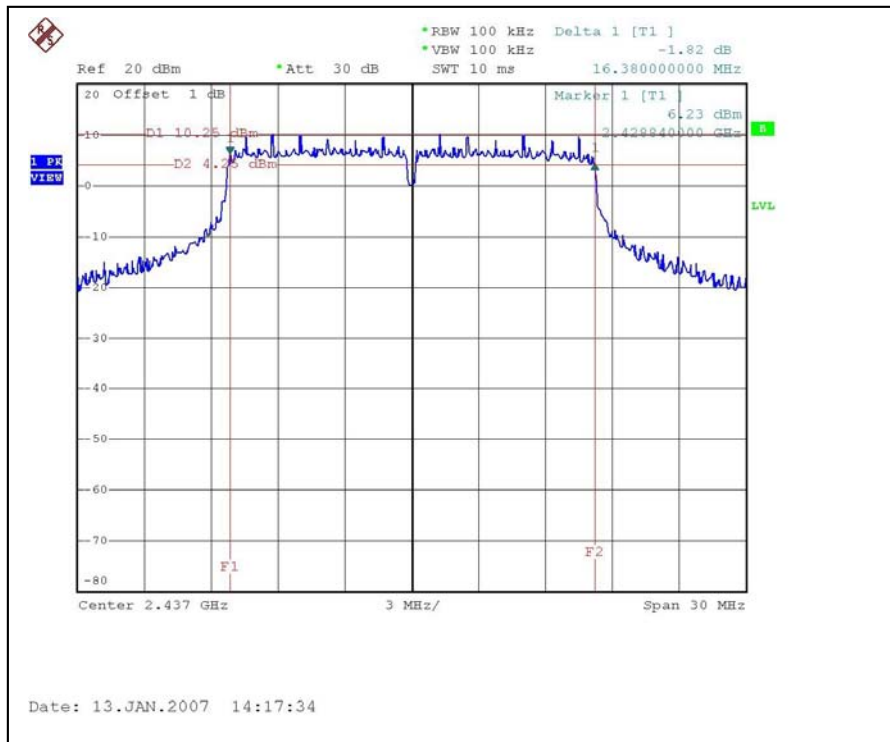

CH11

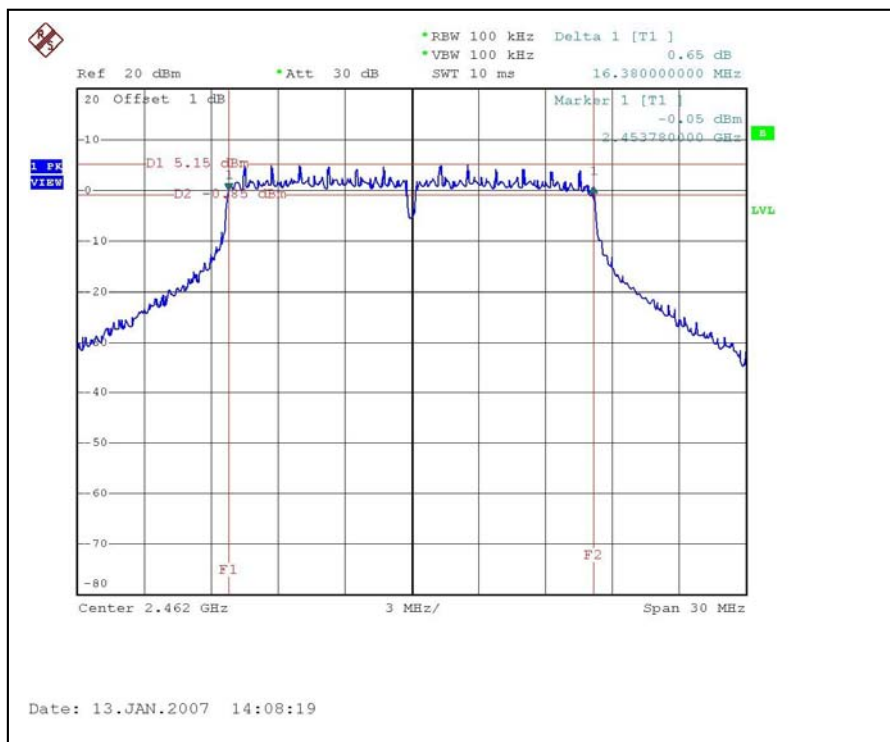



4.4 MAXIMUM PEAK OUTPUT POWER

4.4.1 LIMITS OF MAXIMUM PEAK OUTPUT POWER MEASUREMENT

The Maximum Peak Output Power Measurement is 30dBm.

4.4.2 INSTRUMENTS

Description & Manufacturer	Model No.	Serial No.	Calibrated Until
R&S SPECTRUM ANALYZER	FSP40	100037	Aug. 15, 2007
Agilent SIGNAL GENERATOR	E8257C	MY43321031	July 26, 2007
TEKTRONIX OSCILLOSCOPE	TDS380	B016335	Jun. 21, 2007
NARDA DETECTOR	4503A	FSCM99899	NA

NOTE:

The calibration interval of the above test instruments is 12 months and the calibrations are traceable to NML/ROC and NIST/USA.

4.4.3 TEST PROCEDURES

1. A detector was used on the output port of the EUT. An oscilloscope was used to read the response of the detector.
2. Replaced the EUT by the signal generator. The center frequency of the S.G was adjusted to the center frequency of the measured channel.
3. Adjusted the power to have the same reading on oscilloscope. Record the power level.

4.4.4 DEVIATION FROM TEST STANDARD

No deviation

4.4.5 TEST SETUP



4.4.6 EUT OPERATING CONDITIONS

Same as Item 4.3.6



4.4.7 TEST RESULTS

802.11b DSSS modulation

MODULATION TYPE	CCK	TRANSFER RATE	1Mbps
INPUT POWER (SYSTEM)	120Vac, 60Hz	ENVIRONMENTAL CONDITIONS	20deg. C, 60%RH, 965hPa
TESTED BY	Sky Liao		

CHANNEL	CHANNEL FREQUENCY (MHz)	PEAK POWER OUTPUT (mW)	PEAK POWER OUTPUT (dBm)	PEAK POWER LIMIT (dBm)	PASS/FAIL
1	2412	70.795	18.5	30	PASS
6	2437	234.423	23.7	30	PASS
11	2462	223.872	23.5	30	PASS



802.11g OFDM modulation

MODULATION TYPE	BPSK	TRANSFER RATE	6Mbps
INPUT POWER (SYSTEM)	120Vac, 60Hz	ENVIRONMENTAL CONDITIONS	20deg. C, 60%RH, 965hPa
TESTED BY	Sky Liao		

CHANNEL	CHANNEL FREQUENCY (MHz)	PEAK POWER OUTPUT (mW)	PEAK POWER OUTPUT (dBm)	PEAK POWER LIMIT (dBm)	PASS/FAIL
1	2412	95.499	19.8	30	PASS
6	2437	363.078	25.6	30	PASS
11	2462	141.254	21.5	30	PASS

802.11g Turbo OFDM modulation

MODULATION TYPE	BPSK	TRANSFER RATE	12Mbps
INPUT POWER (SYSTEM)	120Vac, 60 Hz	ENVIRONMENTAL CONDITIONS	20deg. C, 60%RH, 965hPa
TESTED BY	Sky Liao		

CHANNEL	CHANNEL FREQUENCY (MHz)	PEAK POWER OUTPUT (mW)	PEAK POWER OUTPUT (dBm)	PEAK POWER LIMIT (dBm)	PASS/FAIL
6	2437	79.433	19.0	30	PASS