



Prüfbericht-Nr.: <i>Test Report No.:</i>	50093269 002	Auftrags-Nr.: <i>Order No.:</i>	114066652	Seite 1 von 36 <i>Page 1 of 36</i>
Kunden-Referenz-Nr.: <i>Client Reference No.:</i>	N/A	Auftragsdatum: <i>Order date:</i>	28-Jun-2017	
Auftraggeber: <i>Client:</i>	ARESON Technology Corp., 11F., No. 646, Sec.5, Chongxin Rd., SanChong Dist., New Taipei City 24158, Taiwan, R.O.C.			
Prüfgegenstand: <i>Test item:</i>	Bluetooth Mouse(BT 3.0)			
Bezeichnung / Typ-Nr.: <i>Identification / Type No.:</i>	L087SB,MUS-TBLF134			
Auftrags-Inhalt: <i>Order content:</i>	FCC Part 15C Test report (BDR)			
Prüfgrundlage: <i>Test specification:</i>	FCC 47CFR Part 15: Subpart C Section 15.247			
Wareneingangsdatum: <i>Date of receipt:</i>	7-Jul-2017			
Prüfmuster-Nr.: <i>Test sample No.:</i>	A000575330-001 A000575330-002			
Prüfzeitraum: <i>Testing period:</i>	17-Jul-2017 - 28-Jul-2017			
Ort der Prüfung: <i>Place of testing:</i>	EMC Laboratory Taipei			
Prüflaboratorium: <i>Testing laboratory:</i>	TUV Rheinland Taiwan Ltd.			
Prüfergebnis*: <i>Test result*:</i>	Pass			
geprüft von / tested by:		kontrolliert von / reviewed by:		
2017-08-08	Ryan W. T. Chen / Project Manager	2017-08-08	Rene Charton/Senior Project Manager	
<i>Datum</i> <i>Date</i>	<i>Name / Stellung</i> <i>Name / Position</i>	<i>Unterschrift</i> <i>Signature</i>	<i>Datum</i> <i>Date</i>	<i>Name / Stellung</i> <i>Name / Position</i>
Sonstiges / Other: FCC ID : P5A-DL0006				
Zustand des Prüfgegenstandes bei Anlieferung: <i>Condition of the test item at delivery:</i>		Prüfmuster vollständig und unbeschädigt <i>Test item complete and undamaged</i>		
* Legende: 1 = sehr gut 2 = gut 3 = befriedigend 4 = ausreichend 5 = mangelhaft P(ass) = entspricht o.g. Prüfgrundlage(n) F(ail) = entspricht nicht o.g. Prüfgrundlage(n) N/A = nicht anwendbar N/T = nicht getestet Legend: 1 = very good 2 = good 3 = satisfactory 4 = sufficient 5 = poor P(ass) = passed a.m. test specification(s) F(ail) = failed a.m. test specification(s) N/A = not applicable N/T = not tested				
Dieser Prüfbericht bezieht sich nur auf das o.g. Prüfmuster und darf ohne Genehmigung der Prüfstelle nicht auszugsweise vervielfältigt werden. Dieser Bericht berechtigt nicht zur Verwendung eines Prüfzeichens. <i>This test report only relates to the a. m. test sample. Without permission of the test center this test report is not permitted to be duplicated in extracts. This test report does not entitle to carry any test mark.</i>				

TEST SUMMARY

5.1.1 ANTENNA REQUIREMENT*RESULT: Passed***5.1.2 PEAK OUTPUT POWER***RESULT: Passed***5.1.3 20dB BANDWIDTH***RESULT: Passed***5.1.4 99% BANDWIDTH***RESULT: Passed***5.1.5 CONDUCTED SPURIOUS EMISSIONS AND FREQUENCY BAND EDGE MEASURED IN 100KHz BANDWIDTH***RESULT: Passed***5.1.6 SPURIOUS EMISSION***RESULT: Passed***5.1.7 FREQUENCY SEPARATION***RESULT: Passed***5.1.8 NUMBER OF HOPPING FREQUENCY***RESULT: Passed***5.1.9 TIME OF OCCUPANCY***RESULT: Passed***6.1.1 ELECTROMAGNETIC FIELDS***RESULT: Passed*

Contents

1.	GENERAL REMARKS	5
1.1	COMPLEMENTARY MATERIALS.....	5
2.	TEST SITES	6
2.1	TEST LABORATORY	6
2.2	TEST FACILITY.....	6
2.3	LIST OF TEST AND MEASUREMENT INSTRUMENTS.....	7
2.4	TRACEABILITY	8
2.5	CALIBRATION	8
2.6	MEASUREMENT UNCERTAINTY	8
3.	GENERAL PRODUCT INFORMATION.....	9
3.1	PRODUCT FUNCTION AND INTENDED USE	9
3.2	SYSTEM DETAILS AND RATINGS.....	9
3.3	INDEPENDENT OPERATION MODES.....	10
3.4	NOISE GENERATING AND NOISE SUPPRESSING PARTS	11
3.5	SUBMITTED DOCUMENTS.....	11
4.	TEST SET-UP AND OPERATION MODES.....	12
4.1	PRINCIPLE OF CONFIGURATION SELECTION	12
4.2	TEST OPERATION AND TEST SOFTWARE.....	12
4.3	SPECIAL ACCESSORIES AND AUXILIARY EQUIPMENT	12
4.4	COUNTERMEASURES TO ACHIEVE EMC COMPLIANCE.....	13
4.5	TEST SETUP DIAGRAM	13
5.	TEST RESULTS	15
5.1	TRANSMITTER REQUIREMENT & TEST SUITES	15
5.1.1	<i>Antenna Requirement</i>	<i>15</i>
5.1.2	<i>Peak Output Power.....</i>	<i>16</i>
5.1.3	<i>20dB Bandwidth</i>	<i>17</i>
5.1.4	<i>99% Bandwidth</i>	<i>20</i>
5.1.5	<i>Conducted spurious emissions and Frequency Band Edge measured in 100kHz Bandwidth.....</i>	<i>21</i>
5.1.6	<i>Spurious Emission</i>	<i>25</i>
5.1.7	<i>Frequency Separation.....</i>	<i>26</i>
5.1.8	<i>Number of hopping frequency.....</i>	<i>28</i>
5.1.9	<i>Time of Occupancy.....</i>	<i>30</i>
6.	SAFETY HUMAN EXPOSURE	32

6.1	RADIO FREQUENCY EXPOSURE COMPLIANCE	32
6.1.1	<i>Electromagnetic Fields.....</i>	<i>32</i>
7.	PHOTOGRAPHS OF THE TEST SET-UP.....	33
8.	LIST OF TABLES	36
9.	LIST OF PHOTOGRAPHS.....	36

1. General Remarks

1.1 Complementary Materials

The following attachments are integral parts of this test report:

Appendix P: Photo Documentation
(File Name: 50093269APPENDIX P)

Appendix D: Test Result of Radiated Emissions
(File Name: 50093269APPENDIX D)

Test Specifications

The following standards were applied

Table 1: Applied Standard and Test Levels

Radio
FCC CFR47 Part 15: Subpart C Section 15.247 RSS-247 Issue 2 Feb 2017 RSS-Gen, Issue 4, November 2014 ANSI C63.10:2013

2. Test Sites

2.1 Test Laboratory

TUV Rheinland Taiwan Ltd.
Taichung Branch Office

No.9, Lane 36, Minsheng Rd., Sec. 3, Daya District,
Taichung City 428
Taiwan (R.O.C.)

2.2 Test Facility

TUV Rheinland Taiwan Ltd.
Taipei Office

11F. No.758, Sec. 4, Bade Rd., Songshan Dist.
Taipei City 105
Taiwan (R.O.C.)

FCC RegistrationNo.: 340738
IC Canada Registration No.: 9465A-1
TAF Accredited NCC Test Lab. No.:0759
TAF ISO17025 Certification effective periods: 2016-Jul-1st to 2019-Jun-30th



Testing Laboratory
0759

2.3 List of Test and Measurement Instruments

Table 2: List of Test and Measurement Equipment

Kind of Equipment	Manu-facturer	Type	S/N	Last Calibration	Next Calibration
Test Software	Farad	EZ_EMG	Ver. TUV3A1	N/A	N/A
EMI Test Receiver	R&S	ESR7	101062	2016/09/12	2017/09/12
Spectrum Analyzer	R&S	FSV 40	100921	2017/05/02	2018/05/01
Spectrum Analyzer	Agilent	N9010A	MY53470241	2017/05/23	2018/05/22
Preamplifier (30MHz -1GHz)	HP	8447F	2805A03335	2016/07/29	2017/07/29
Preamplifier (18 GHz -40 GHz)	COM-POWER	PAM-840	461257	2016/12/01	2017/12/01
Pre-Amplifier (1GHz~18GHz)	EM Electronics	EM01G18G	060558	2016/11/17	2017/11/17
Bilog Antenna	TESEQ	CBL6111D	29802	2016/08/10	2017/08/10
Horn Antenna	ETS-Lindgren	3117	138160	2017/05/25	2018/05/25
Horn Antenna (18GHz~40GHz)	COM-POWER	AH-840	101031	2016/11/22	2017/11/22
Loop Antenna	Schwarzbeck	FMZB 1513	1513-076	2017/06/14	2018/06/14
EMI Test Receiver	R&S	ESCI7	100797	2016/12/30	2017/12/30
Spectrum Analyzer	R&S	FSL3	101943	2015/09/07	2017/09/07
Temp. & Humid. Chamber	Giant Force	GCT-099-40-S	MAF0103-007	2015/07/13	2017/07/12
LISN (1 phase)	R&S	ENV216	101243	2017/06/18	2018/06/18
LISN	R&S	ENV216	101262	2017/06/22	2018/06/21

2.4 Traceability

All measurement equipment calibrations are traceable to NML(Taiwan)/NIST(USA) or where calibration is performed outside Taiwan, to equivalent nationally recognized standards organizations.

2.5 Calibration

requiring calibration is calibrated periodically in a suitably accredited Calibration Lab. Additionally all equipment is verified for proper performance on a regular basis using in house standards or comparisons.

2.6 Measurement Uncertainty

The estimated combined standard uncertainty for radiated emissions and conducted emissions measurements:.

Table 3: Emission Measurement Uncertainty

Parameter	Uncertainty
RF power, conducted	± 1.5 dB
Adjacent channel power	± 3 dB
Radiated emission of transmitter, valid up to 26 GHz	± 6 dB
Radiated emission of receiver, valid up to 26 GHz	± 6 dB
Temperature	± 2 °C
Humidity	± 10 %

3. General Product Information

3.1 Product Function and Intended Use

The EUT is a 2.4GHz Wireless mouse. It contains a 2.4GHz compatible module enabling the user to communicate data through a Wireless interface.
For details refer to the User Guide, Data Sheet and Circuit Diagram.

3.2 System Details and Ratings

Table 4: Basic Information of EUT

Item	EUT information
Kind of Equipment/Test Item	Bluetooth Mouse(BT 3.0)
Type Identification	L087SB,MUS-TBLF134
FCC ID	P5A-DL0006

Table 5: Technical Specification of EUT

Technical Specification	Value
Operating Frequency	2402 MHz ~ 2480 MHz
Channel Spacing	1 MHz
Channel number	79
Operation Voltage	3 Vdc
Modulation	GFSK
Antenna gain	-0.16 dBi

Table 6: Frequency hopping information

Technical Specification	Description
Hopping Range	Hereby we declare that the maximum frequency of this device is: 2402-2480MHz. This is according the Bluetooth Core Specification V2.1+EDR for devices which will be operated in the USA. This was checked during the Bluetooth Qualification tests (Test Case: TRM/CA/04).
Hopping Sequence	Example of a 79 hopping sequence in data mode: 33,04,21,44,23,42,53,46,55,48,40,59,72,29,76,31,08,73,07,75,09,45,60,39,58,13,47,11,77,52,35,50,65,54,67,56,69,62,71,64, 7,25,27,66,57,70,74,61,78,63,10,41,05,43,15,44,64,68,02,70,06,01,51,03,55,05,03,66,53,49,36,47,
Receiver input bandwidth	<p>The input bandwidth of the receiver is 1MHz. In every connection one Bluetooth device is the master and the other one is the slave. The master determines the hopping sequence. The slave follows this sequence. Both devices shift between RX and TX time slot according to the clock of the master.</p> <p>Additionally the type of connection is set up at the beginning of the connection. The master adapts its hopping frequency and its TX/RX timing according to the packet type of the connection. Also the slave of the connection will use these settings.</p> <p>Repeating of a packer has no influence on the hopping sequence. The hopping sequence generated by the master of the connection will be followed in any case.</p> <p>That means a repeated packet will not be send on the same frequency, it is send on the next frequency of the hopping sequence.</p>

3.3 Independent Operation Modes

The basic operation modes are:

- A. Transmitting
 - 1. Low channel
 - 2. Middle channel
 - 3. High channel

3.4 Noise Generating and Noise Suppressing Parts

Refer to the Circuit Diagram.

3.5 Submitted Documents

- Circuit Diagram
- Instruction Manual
- Rating Label
- Technical Description

4. Test Set-up and Operation Modes

4.1 Principle of Configuration Selection

The equipment under test (EUT) was configured to measure its maximum power level. The test modes were adapted accordingly in reference to the instructions for use.

4.2 Test Operation and Test Software

Test operation refers to test setup in chapter 4. All testing were performed according to the procedures in ANSI C63.10: 2013

The samples were used as follows:

Conducted: **A000575330-002**

Radiation: **A000575330-001**

Full test was applied on all test modes, but only worst case was shown.

4.3 Special Accessories and Auxiliary Equipment

The product has been tested together with the following additional accessories:

None.

4.4 Countermeasures to achieve EMC Compliance

The test sample which has been tested containing the noise suppression parts as in the Photo Appendix and the Test Setup Photos. No additional measures were employed to achieve compliance.

4.5 Test Setup Diagram

Diagram of Measurement Configuration for Radiation Test

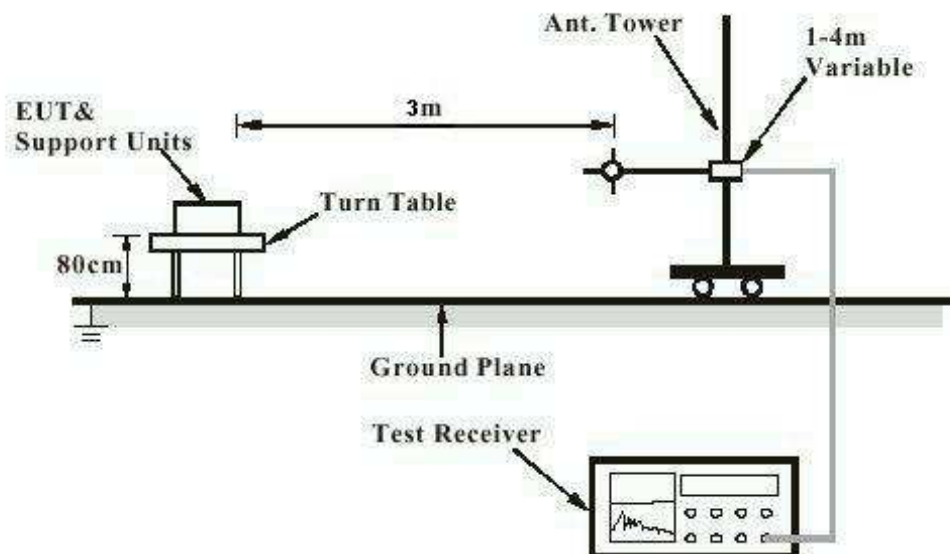

Note: Measurements above 1 GHz are done with a table height of 1.5m

Diagram of Measurement Equipment Configuration for Mains Conduction Measurement

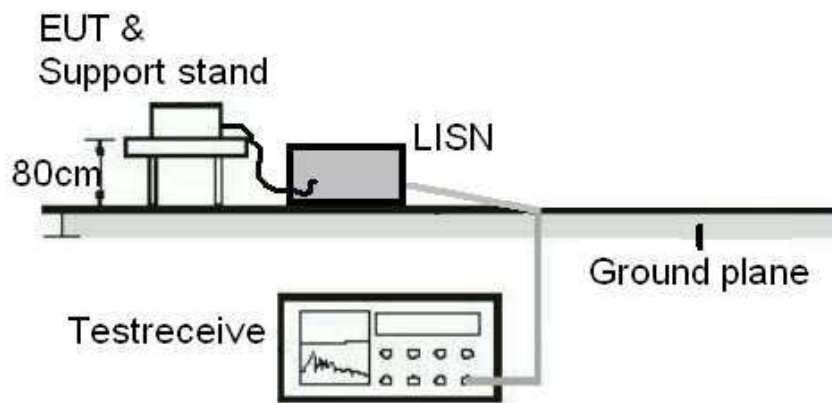
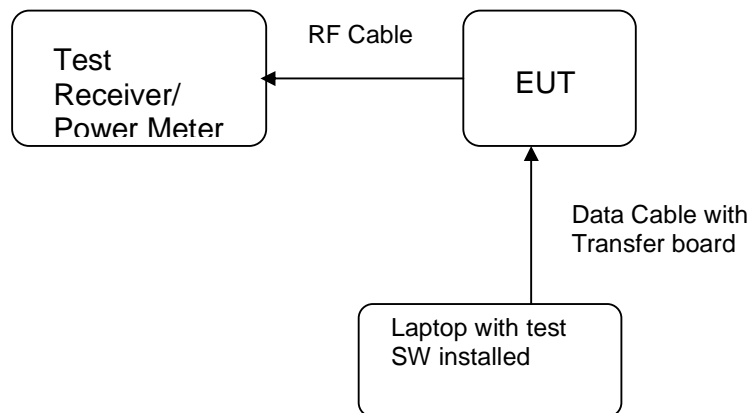

Diagram of Measurement Equipment Configuration for Conducted Transmitter Measurement



5. Test Results

5.1 Transmitter Requirement & Test Suites

5.1.1 Antenna Requirement

RESULT: **Passed**

Test standard	:	LP0002(2016): 2.2, 3.10.1, (3) FCC Part 15.247(b)(4), Part 15.203 and RSS- Gen 8.3
Requirement	:	use of approved antennas only with directional gains that do not exceed 6 dBi

According to the manufacturer declaration, the EUT has an antenna with a directional gain of -0.16 dBi. The antenna is a printed PCB trace with no possibility of replacement with a non-approved antenna by the end-user. Therefore, the EUT is considered to comply with this provision.

Refer to EUT photo for details.

5.1.2 Output Power

RESULT:
Passed

Test standard : FCC Part 15.247(b)(1),
 RSS-247 5.4(2)
 LP0002(2016): 3.10.1, (2)
 Basic standard : ANSI C63.10:2013
 LP0002(2016) Appendix II
 Kind of test site : Shielded room

Test setup

Test Channel : Low/ Middle/ High
 Operation Mode : A

Ambient temperature : 22-26 °C
 Relative humidity : 50-65 %
 Atmospheric pressure : 100-103 kPa

Table 7: Test result of Output Power, GFSK modulation

Channel	Channel Frequency	Output Power		Limit
	(MHz)	(dBm)	(W)	(W)
Low Channel	2402	-12.70	0.00005	0.125
Middle Channel	2441	-14.02	0.00004	0.125
High Channel	2480	-14.23	0.00004	0.125

Pmax: 0.0537 mW

5.1.3 20dB Bandwidth

RESULT:
Passed

Test standard : FCC Part 15.247(a)(1),
 RSS-247 5.1(1)
 LP0002(2016): 3.10.1, (6.1.1)

Basic standard : ANSI C63.10:2013
 LP0002(2016) Appendix II

Test setup

Test Channel : Low/ Middle/ High
 Operation Mode : A

Ambient temperature : 22-26°C
 Relative humidity : 50-65%
 Atmospheric pressure : 100-103kPa

Table 8: Test result of 20dB Bandwidth, GFSK modulation

Channel	Channel Frequency (MHz)	20dB Bandwidth (kHz)	Limit (MHz)	Result
Low Channel	2402	1.037	1.5	Pass
Mid Channel	2441	1.029	1.5	Pass
High Channel	2480	1.035	1.5	Pass

Note: Limit is for Channel Separation of 1 MHz and a power limit of 125 mW.

If the carrier separation frequency of a Bluetooth Device is set at 1 MHz due to the firmware setting and the Bluetooth Standard, then for power <125 mW the limit for the 20 dB Bandwidth, becomes $1 \text{ MHz} / 0.66666 = 1.5 \text{ MHz}$.

Test Plot of 20dB Bandwidth, GFSK modulation

Low Channel

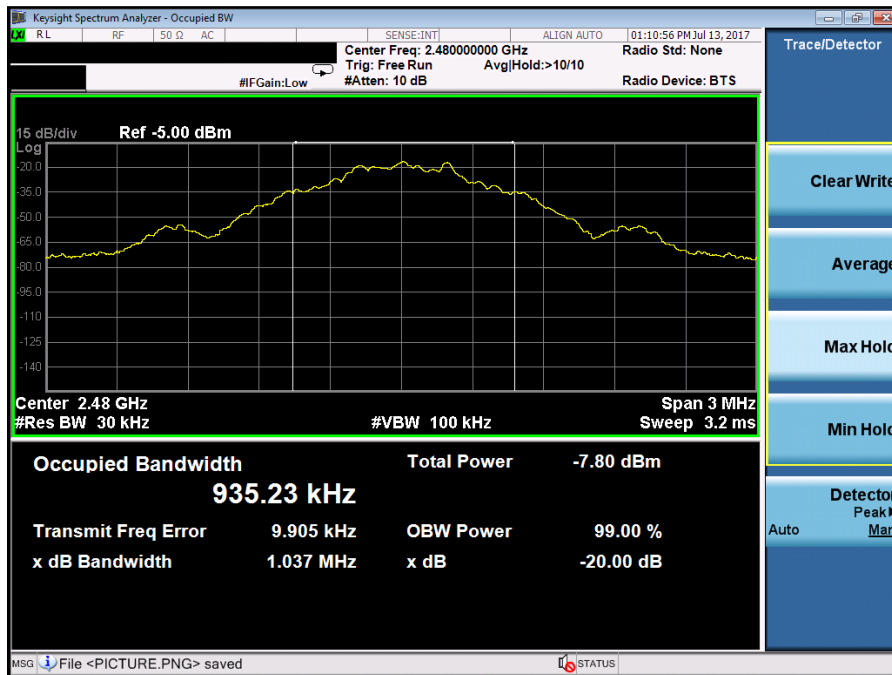

Middle Channel

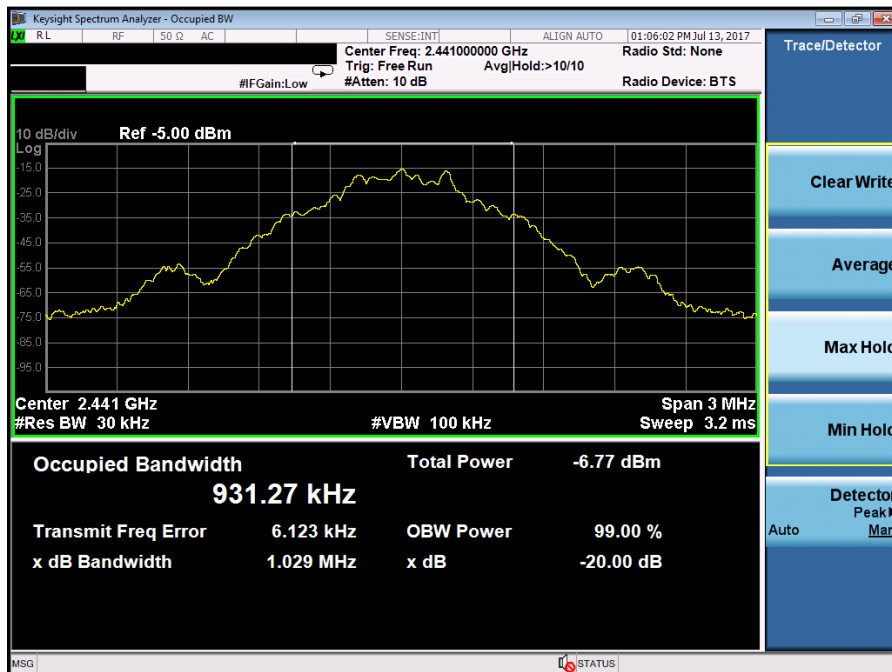

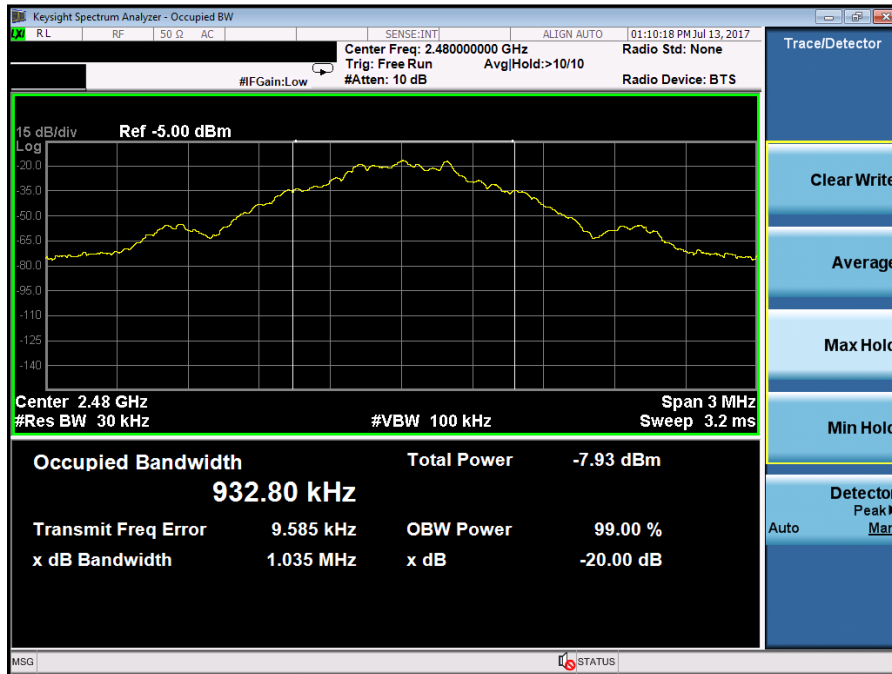
High Channel

5.1.4 99% Bandwidth

RESULT:**Passed**

Test standard : RSS-Gen (Issue 4)
Basic standard : RSS-Gen (Issue 4)
Kind of test site : Shielded room

Test setup

Test Channel : Low/ Middle/ High
Operation Mode : A

Ambient temperature : 22-26°C
Relative humidity : 50-65%
Atmospheric pressure : 100-103kPa

Table 9: Test result of 99% Bandwidth, GFSK modulation

Channel	Channel Frequency (MHz)	99% Bandwidth (kHz)
Mid Channel	2441	931.27

5.1.5 Conducted spurious emissions and Frequency Band Edge measured in 100kHz Bandwidth

RESULT: **Passed**

Test standard	:	FCC part 15.247(d), RSS-247 5.5 LP0002(2016): 3.10.1, (5)
Basic standard	:	ANSI C63.10:2013 LP0002(2016) Appendix II
Limit	:	20dB (below that in the 100kHz bandwidth within the band that contains the highest level of the desired power)
Kind of test site	:	Shielded room

Test setup

Test Channel	:	Low/ Middle/ High
Operation Mode	:	A
Ambient temperature	:	22-26°C
Relative humidity	:	50-65%
Atmospheric pressure	:	100-103 kPa

All emissions are more than 20dB below fundamental, details refer to following test plot, and compliance is achieved as well.

Due to the small size of the product and that there are no inductive components of significant size, 9kHz to 30MHz frequency range is not tested based on technical judgment.

Test Plot of 100kHz Conducted Emissions, GFSK modulation

Low Channel

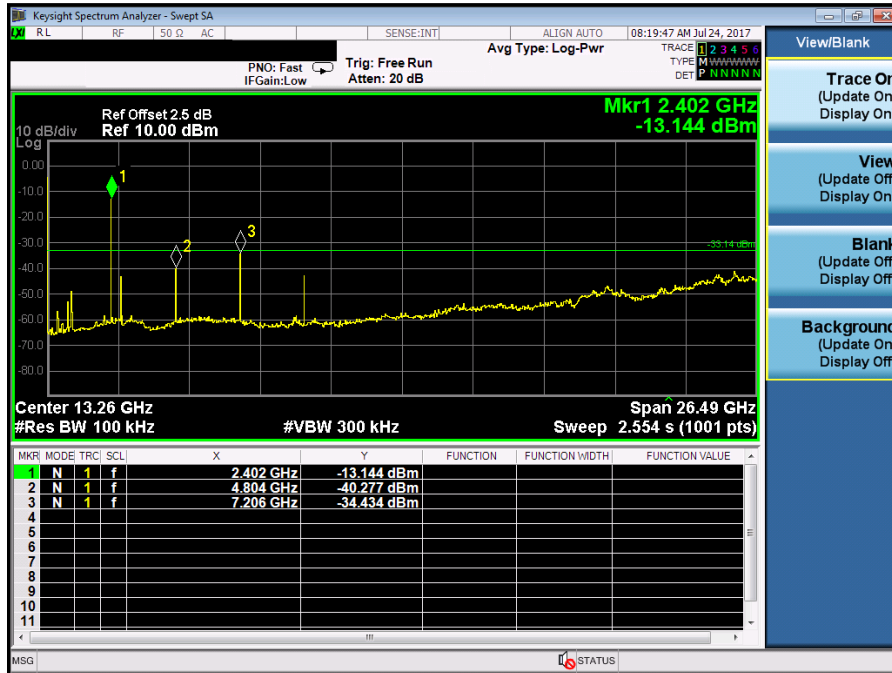

Middle Channel

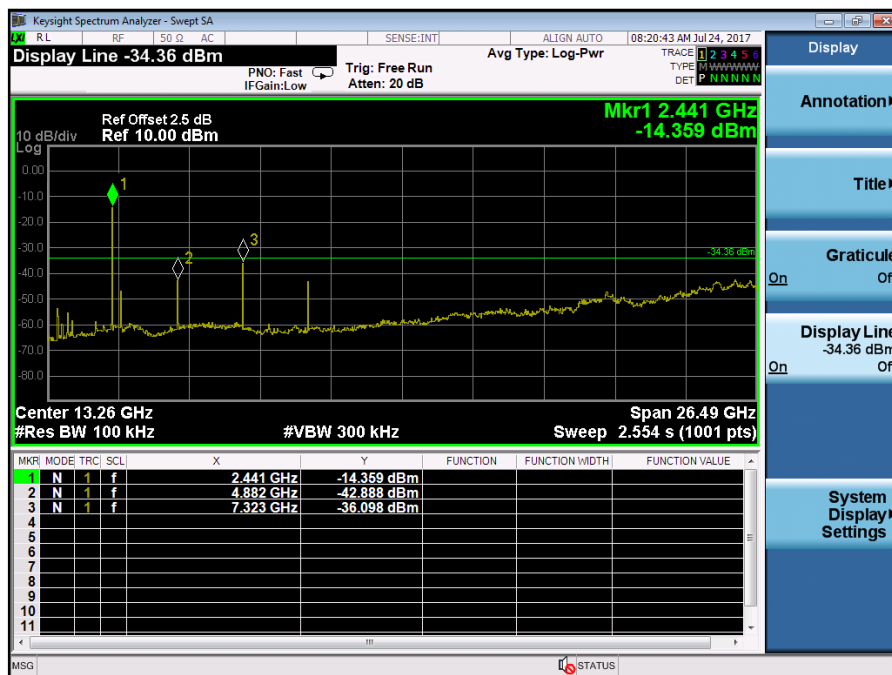

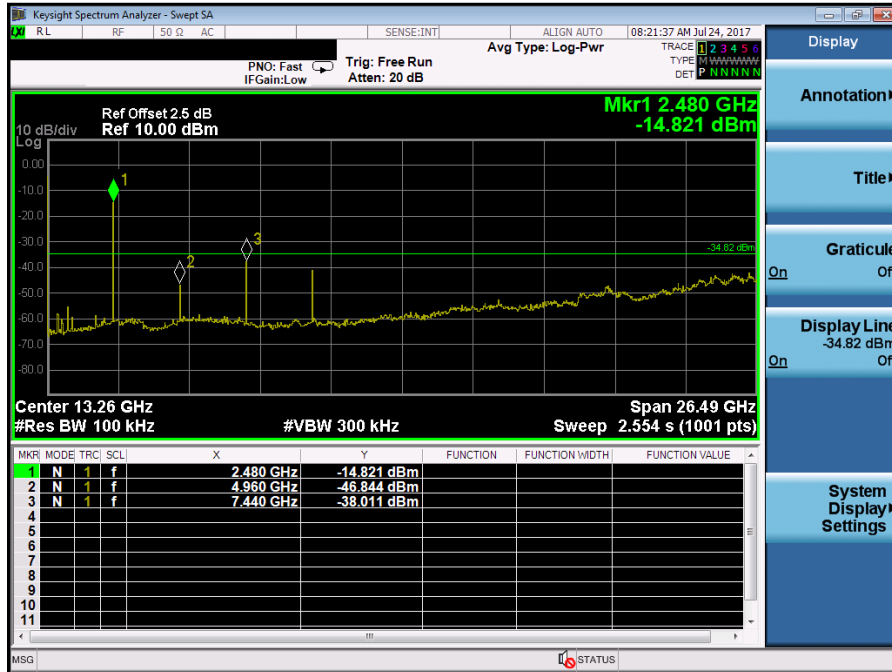
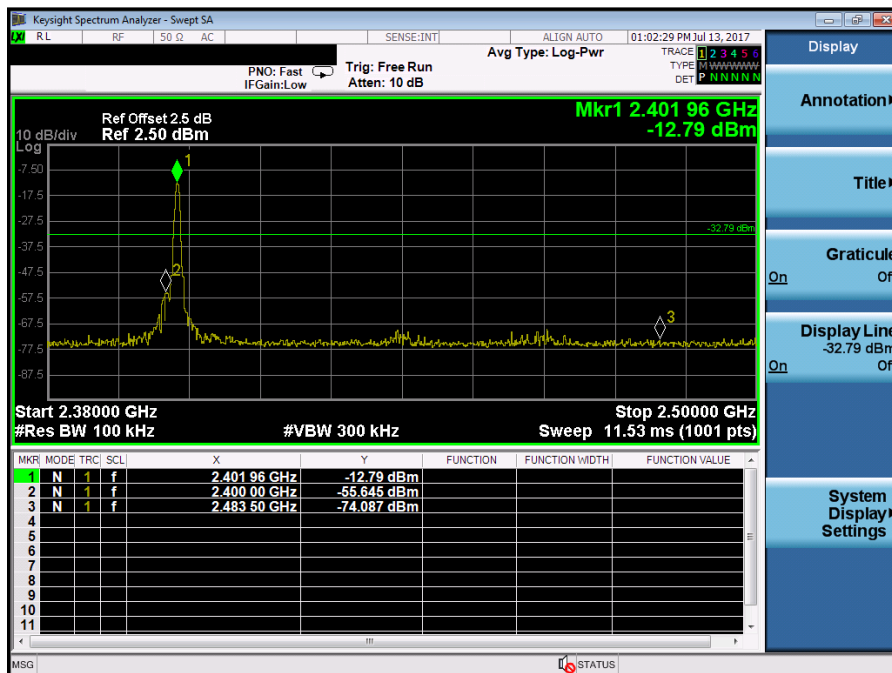
High Channel

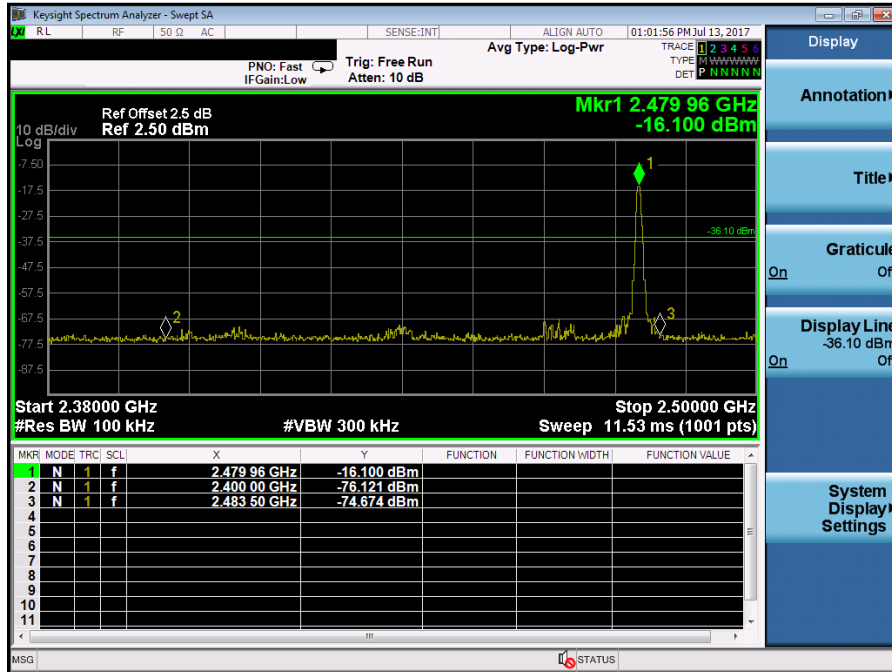
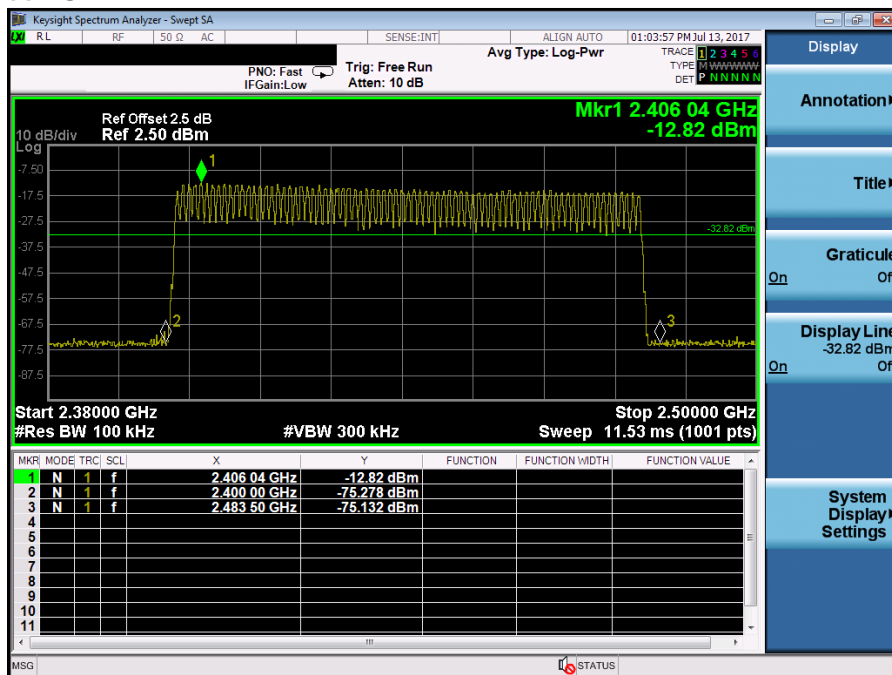
Test Plot of 100kHz Bandwidth of Frequency Band Edge, GFSK modulation
Low Channel

High Channel

Hopping ON

5.1.6 Spurious Emission

RESULT:**Passed**

Test standard	:	FCC part 15.247(d), FCC 15.205, FCC 15.209, RSS-210 2.2, RSS-247 5.5 and RSS-Gen 8.9 LP0002(2016): 3.10.1, (5)
Basic standard	:	ANSI C63.10
Limits	:	Radiated emissions which fall in the restricted bands, as defined in FCC 15.205(a) and RSS-Gen i4, 8.9 (Table 6), must comply with the radiated emission limits specified in FCC 15.209(a) and RSS-Gen i4, 8.9 (Table 4 and 5). Radiated emissions which fall in the restricted bands, as defined in LP0002(2016): 2.7 , must comply with the radiated emission limits specified in LP0002(2016): 2.8 Emission radiated outside the specified frequency bands must comply with the radiated emission limits specified in FCC 15.209(a) and FCC 15.249(a), RSS-Gen i4, 8.9 (Table 4 and 5) and RSS-210 A2.9(a). Emission radiated outside the specified frequency bands must comply with the radiated emission limits specified in LP0002(2016): 2.8
Kind of test site	:	3m Semi-Anechoic Chamber

Test setup

Test Channel	:	Low/ Middle/ High
Operation Mode	:	A, B

Remark: Testing was carried out within frequency range 30MHz to the tenth harmonic. For details refer to Appendix D. The Radiated Emissions testing was performed in the X, Y and Z axis orientation. The worst-case Axis orientation is recorded in this test report. Due to the small size of the product and that there are no inductive components of significant size, 9kHz to 30MHz frequency range is not tested based on technical judgment.

Based on the BT hopping rate 1600/s ,the transmission time would be $6/1600=3.75\text{ms}$
 $3.75\text{ms} \times 15 = 56.25\text{ms} > 100\text{ms}$,thus,2 time appear on 100ms.
Duty Cycle Factor on DH5 : $20 \log(3.75 \times 5 / 6 \times 2 / 100) = -24 \text{ dB}$.

5.1.7 Frequency Separation

RESULT: **Passed**

Test standard : FCC part 15.247(a)(1)
 RSS-247 5.1
 LP0002(2016): 3.10.1, (6.1.1)

Basic standard : ANSI C63.10:2013
 LP0002(2016) Appendix II

Limit : $\geq 25\text{kHz}$ or $2/3$ of 20dB bandwidth, whichever is greater

Test setup

Test Channel : Low/ Middle/ High
 Operation Mode : A
 Ambient temperature : 24°C
 Relative humidity : 53%

Table 10: Test result of Frequency Separation

Channel	Channel Frequency (MHz)	Measured Channel Separation (MHz)	Limit (kHz)	Result
Record Channel	2441	1	$\geq 25\text{kHz}$ or $2/3$ of 20dB bandwidth	Pass
Record Channel adj 1	2440			
Record Channel adj 2	2442			

5.1.8 Number of hopping frequency

RESULT: **Passed**

Test standard : FCC part 15.247(a)(1)(iii)
RSS-247 5.1(5)
LP0002(2016): 3.10.1, (6.1.2)
Basic standard : ANSI C63.10:2013
LP0002(2016) Appendix II

Test setup

Test Channel : Hopping On

Ambient temperature : 22-26°C
Relative humidity : 50-65%
Atmospheric pressure : 100-103 kPa

Table 11: Test result of Number of hopping frequency

Frequency Range	Measured Quantity of Hopping Channel	Limit	Result
<u>2400</u> to <u>2483.5</u> MHz	79	≥15	Pass

Test Plot of Number of hopping frequencies

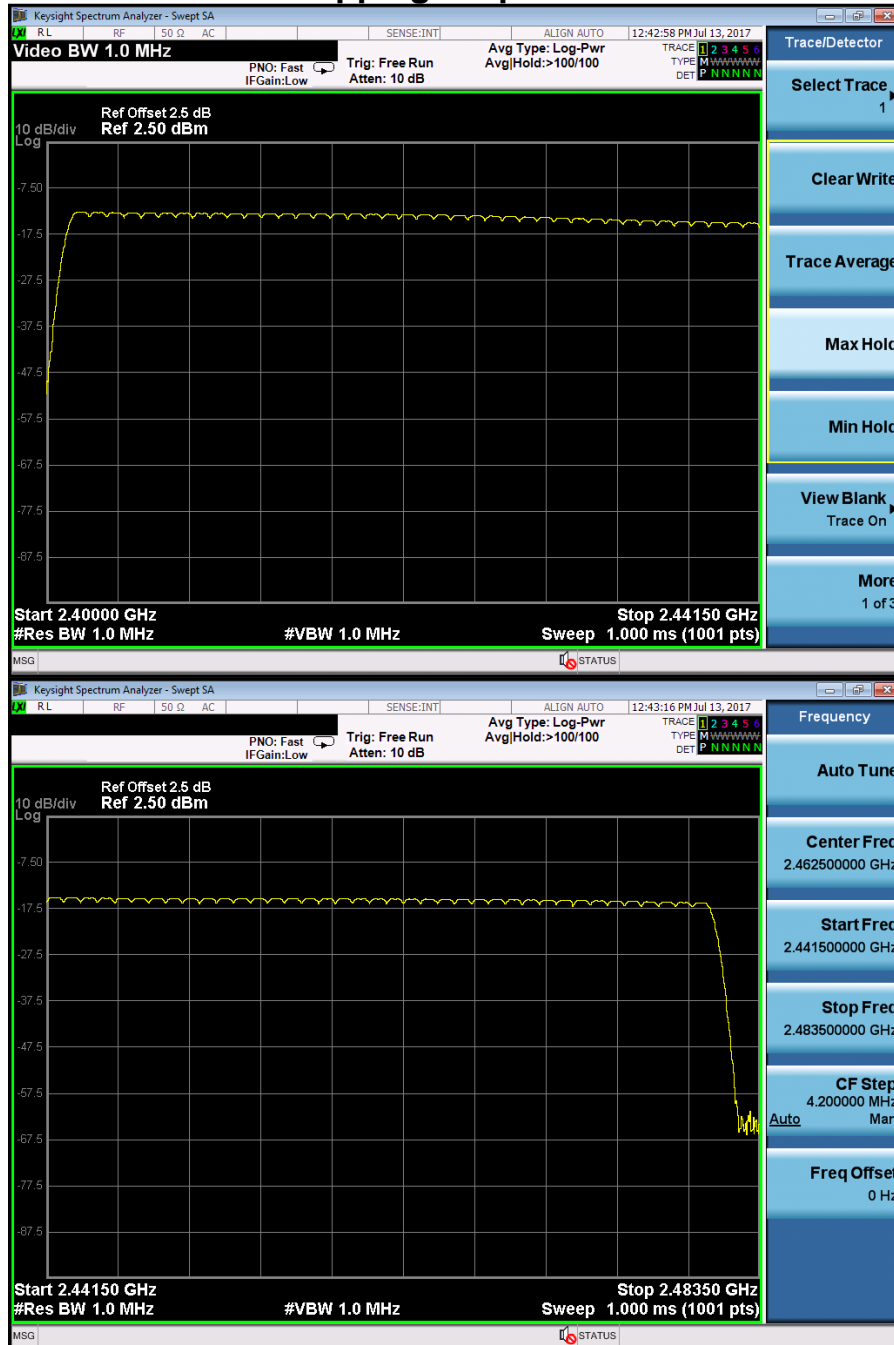

5.1.9 Time of Occupancy

RESULT: **Passed**

Test standard : FCC part 15.247(a)(1)(iii)
 RSS-247 5.1(5)
 LP0002(2016): 3.10.1, (6.1.2)

Basic standard : ANSI C63.10:2013
 LP0002(2016) Appendix II

Limits : 0.4s

Kind of test site : Shield room

Test setup

Test Channel : Low/ Middle/ High

Operation Mode : A

Ambient temperature : 22-26°C

Relative humidity : 50-65%

Atmospheric pressure : 100-103 kPa

Table 12: Test result of Time of Occupancy

Data Mode	Captured Burst (s)	Dwell time (s)	On+Off time (s)	Limit (s)	Result
DH5	0.00302	0.3204	0.00377	0.4	Pass

Note:

Dwell time = Pulse width x (Hopping rate / Number of channels) x Period

Period = 0.4 (seconds/ channel) x 79 (channel) = 31.6 seconds.

Hopping rate = 1 / (On+Off time) = 266 Hz

Test Plot of Time of Occupancy, GFSK modulation



6. Safety Human exposure

6.1 Radio Frequency Exposure Compliance

6.1.1 Electromagnetic Fields

RESULT:**Passed**

Test standard : FCC KDB Publication 447498 D01
RSS-102 issue 5, Table 1

FCC:

Since maximum peak output power of the transmitter is $0.0537 \text{ mW} < 10 \text{ mW}$, hence the EUT is excluded from SAR evaluation according to FCC KDB publication 447498: Mobile Portable RF Exposure

7. Photographs of the Test Set-Up

Photograph 1: Set-up for Spurious Emissions (Front View)

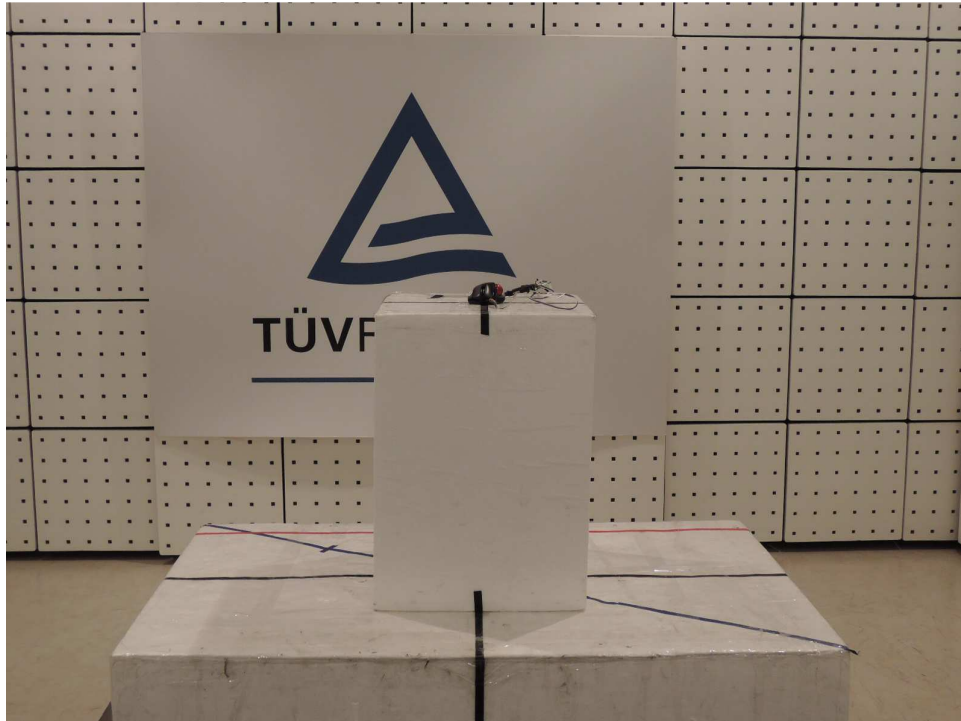

Photograph 2: Set-up for Spurious Emissions (Back View 1)

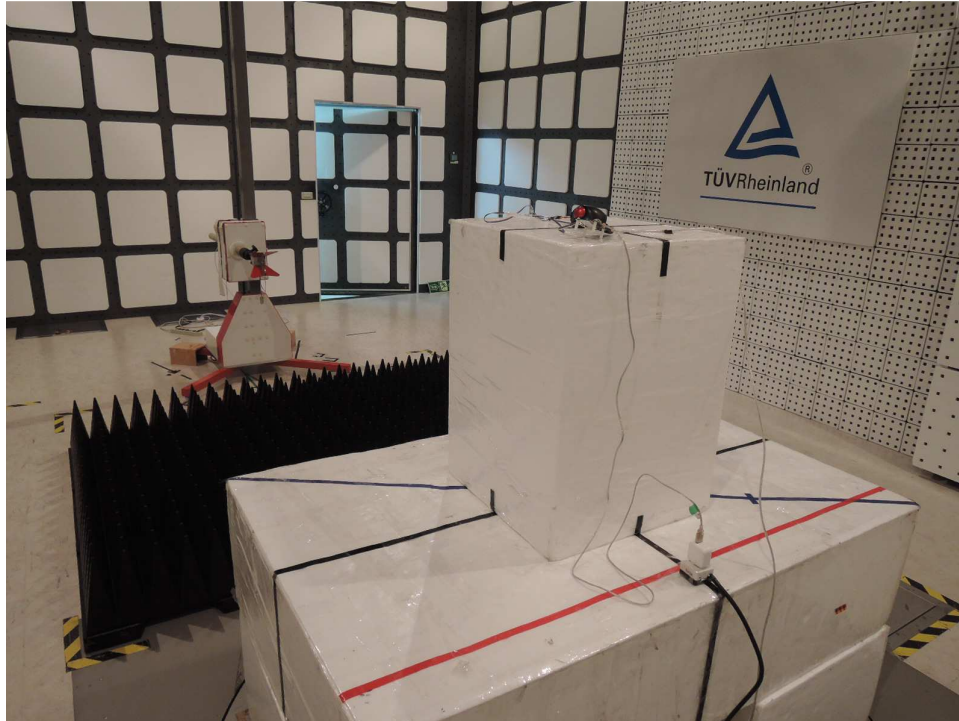

Photograph 3: Set-up for Spurious Emissions (Back View 2)

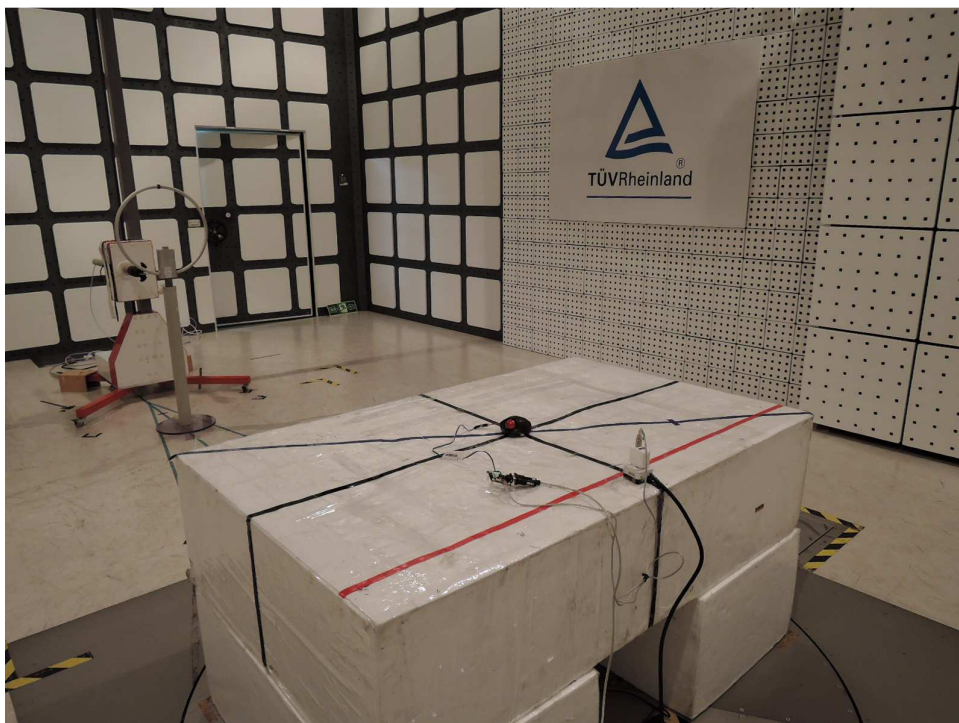

Photograph 4: Set-up for Conducted testing

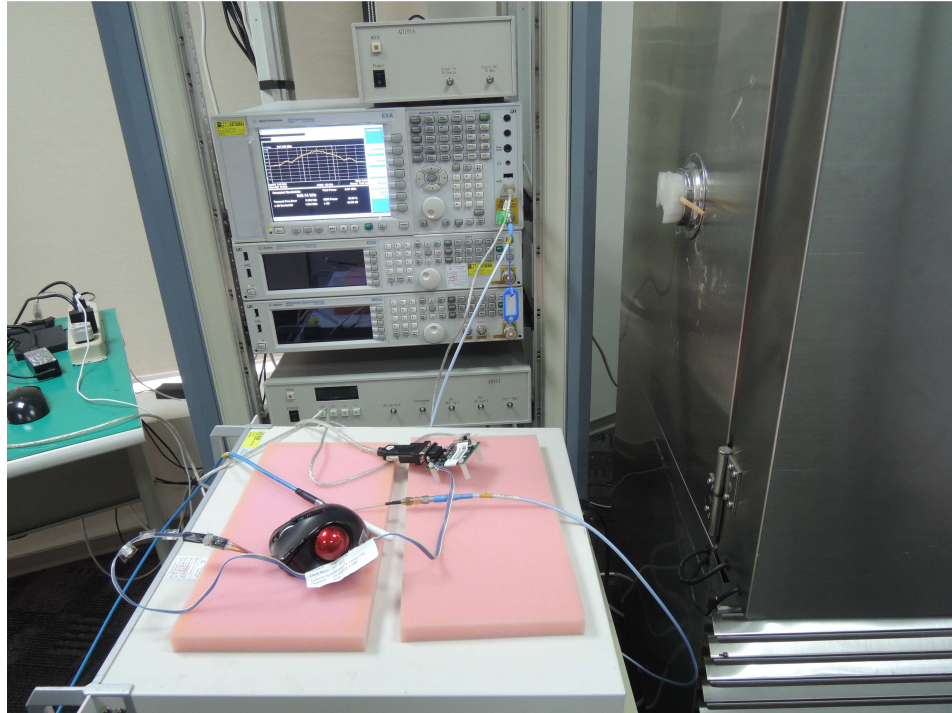

8. List of Tables

Table 1: Applied Standard and Test Levels	5
Table 2: List of Test and Measurement Equipment	7
Table 3: Emission Measurement Uncertainty.....	8
Table 4: Basic Information of EUT	9
Table 5: Technical Specification of EUT	9
Table 6: Frequency hopping information.....	10
Table 7: Test result of Peak Output Power, GFSK modulation.....	16
Table 9: Test result of 20dB Bandwidth, GFSK modulation.....	17
Table 11: Test result of 99% Bandwidth, GFSK modulation.....	20
Table 13: Test result of Frequency Separation	26
Table 14: Test result of Number of hopping frequency	28
Table 15: Test result of Time of Occupancy.....	30

9. List of Photographs

Photograph 1: Set-up for Spurious Emissions (Front View).....	33
Photograph 2: Set-up for Spurious Emissions (Back View 1)	34
Photograph 3: Set-up for Spurious Emissions (Back View 2)	34
Photograph 4: Set-up for Conducted testing	35