



# FCC Radio TEST Report

**FCC ID: P5A-CL0022**

This report concerns (check one):  Original Grant  Class II Change

**Issued Date** : Mar. 29, 2011  
**Project No.** : 1102C083  
**Equipment** : Mini Receiver  
**Model Name** : C55; C56; C57  
**Applicant** : Areson Technology Corporation  
**Address** : 11F, NO.646, SEC.5, CHONGSIN RD., SAN CHONG  
241, TAIPEI COUNTY, TAIWAN (R.O.C.)

**Tested by:**  
Neutron Engineering Inc. EMC Laboratory  
**Date of Receipt:** Feb. 22, 2010  
**Date of Test:**  
Feb. 22, 2010 ~ Mar. 28, 2011

Testing Engineer : Ivan Cao  
(Ivan Cao)  
Technical Manager : Leo Hung  
(Leo Hung)  
Authorized Signatory : Steven Lu  
(Steven Lu)

**Neutron Engineering Inc.**

No.3, Jinshagang 1st Road, ShiXia, Dalang  
Town, Dong Guan, China.  
TEL : (0769) 8318-3000 FAX : (0769) 8319-6000



### **Declaration**

**Neutron** represents to the client that testing is done in accordance with standard procedures as applicable and that test instruments used has been calibrated with the standards traceable to National Measurement Laboratory (**NML**) of **R.O.C.**, or National Institute of Standards and Technology (**NIST**) of **U.S.A.**

**Neutron's** reports apply only to the specific samples tested under conditions. It is manufacture's responsibility to ensure that additional production units of this model are manufactured with the identical electrical and mechanical components. **Neutron** shall have no liability for any declarations, inferences or generalizations drawn by the client or others from **Neutron** issued reports.

**Neutron's** reports must not be used by the client to claim product endorsement by the authorities or any agency of the Government.

This report is the confidential property of the client. As a mutual protection to the clients, the public and **Neutron-self**, extracts from the test report shall not be reproduced except in full with **Neutron's** authorized written approval.

**Neutron's** laboratory quality assurance procedures are in compliance with the **ISO Guide 17025** requirements, and accredited by the conformity assessment authorities listed in this test report.

### **Limitation**

For the use of the authority's logo is limited unless the Test Standard(s)/Scope(s)/Item(s) mentioned in this test report is (are) included in the conformity assessment authorities acceptance respective.



<b>Table of Contents</b>	<b>Page</b>
1 . CERTIFICATION	5
2 . SUMMARY OF TEST RESULTS	6
2.1 TEST FACILITY	7
2.2 MEASUREMENT UNCERTAINTY	7
3 . GENERAL INFORMATION	8
3.1 GENERAL DESCRIPTION OF EUT	8
3.2 DESCRIPTION OF TEST MODES	10
3.3 BLOCK DIGRAM SHOWING THE CONFIGURATION OF SYSTEM TESTED	11
3.4 DESCRIPTION OF SUPPORT UNITS	12
4 . EMC EMISSION TEST	13
4.1 CONDUCTED EMISSION MEASUREMENT	13
4.1.1 POWER LINE CONDUCTED EMISSION LIMITS	13
4.1.2 MEASUREMENT INSTRUMENTS LIST	13
4.1.3 TEST PROCEDURE	14
4.1.4 DEVIATION FROM TEST STANDARD	14
4.1.5 TEST SETUP	14
4.1.6 EUT OPERATING CONDITIONS	14
4.1.7 TEST RESULTS	15
4.2 RADIATED EMISSION MEASUREMENT	17
4.2.1 RADIATED EMISSION LIMITS	17
4.2.2 MEASUREMENT INSTRUMENTS LIST	18
4.2.3 TEST PROCEDURE	21
4.2.4 DEVIATION FROM TEST STANDARD	21
4.2.5 TEST SETUP	22
4.2.6 EUT OPERATING CONDITIONS	23
4.2.7 TEST RESULTS (BELOW 30MHz)	24
4.2.8 TEST RESULTS (BETWEEN 30 – 1000 MHz)	25
4.2.9 TEST RESULTS (ABOVE 1000 MHz)	27
4.2.10 TEST RESULTS (2400 – 2483.5 MHz)	39
5 . BANDWIDTH TEST	40
5.1 MEASUREMENT INSTRUMENTS LIST	40
5.2 TEST PROCEDURE	40
5.3 DEVIATION FROM STANDARD	40
5.4 TEST SETUP	40
5.5 EUT OPERATION CONDITIONS	40
5.6 TEST RESULTS	41



<b>Table of Contents</b>	<b>Page</b>
6 . ANTENNA CONDUCTED SPURIOUS EMISSION	43
6.1 APPLIED PROCEDURES / LIMIT	43
6.1.1 MEASUREMENT INSTRUMENTS LIST	43
6.1.2 TEST PROCEDURE	43
6.1.3 DEVIATION FROM STANDARD	43
6.1.4 TEST SETUP	43
6.1.5 EUT OPERATION CONDITIONS	43
6.1.6 TEST RESULTS	44
7 . EUT TEST PHOTO	49



## 1. CERTIFICATION

Equipment : Mini Receiver  
Brand Name : ARESON  
Model Name. : C55; C56; C57  
Applicant : Areson Technology Corporation  
Date of Test : Feb. 22, 2010 ~ Mar. 28, 2011  
Test Item : ENGINEERING SAMPLE  
Standards : FCC Part15, Subpart C(15.249)/ ANSI C63.4 : 2003

The above equipment has been tested and found compliance with the requirement of the relative standards by Neutron Engineering Inc. EMC Laboratory.

The test data, data evaluation, and equipment configuration contained in our test report (Ref No. NEI-FCCP-1-1102C083) were obtained utilizing the test procedures, test instruments, test sites that has been accredited by the Authority of NVLAP and TAF according to the ISO-17025 quality assessment standard and technical standard(s).



## 2. SUMMARY OF TEST RESULTS

Test procedures according to the technical standards:

FCC Part15, Subpart C (15.249)			
Standard Section	Test Item	Judgment	Remark
15.207	Conducted Emission	PASS	
15.209	Radiated Emission	PASS	
15.249	Radiated Spurious Emission	PASS	

**NOTE:**

(1) "N/A" denotes test is not applicable in this Test Report



**2.1 TEST FACILITY**

The test facilities used to collect the test data in this report is **DG-C02/DG-CB03** at the location of No.3, Jinshagang 1st Road, ShiXia, Dalang Town, Dong Guan, China.523792  
 Neutron's test firm number is 319330

**2.2 MEASUREMENT UNCERTAINTY**

Where relevant, the following measurement uncertainty levels have been estimated for tests performed on the EUT as specified in CISPR 16-4-2:

The reported uncertainty of measurement  $y \pm U$ , where expanded uncertainty **U** is based on a standard uncertainty multiplied by a coverage factor of **k=2**, providing a level of confidence of approximately **95 %**.

**A. Conducted Measurement :**

Test Site	Method	Measurement Frequency Range	U , (dB)	NOTE
DG-C02	CISPR	150 KHz ~ 30MHz	1.94	

**B. Radiated Measurement :**

Test Site	Method	Measurement Frequency Range	Ant. H / V	U , (dB)	NOTE
DG-CB03	CISPR	30MHz ~ 200MHz	V	2.48	
		30MHz ~ 200MHz	H	2.16	
		200MHz ~ 1,000MHz	V	2.50	
		200MHz ~ 1,000MHz	H	2.66	



### 3. GENERAL INFORMATION

#### 3.1 GENERAL DESCRIPTION OF EUT

Equipment	Mini Receiver	
Brand Name	ARESON	
Model Name.	C55; C56; C57	
OEM Brand/Model Name	N/A	
Model Difference	The models are designed based on similar electrical circuit but different aspect of enclosure.	
Product Description	The EUT is a Mini Receiver.	
	Product Type	Low Power Communication Device
	Operation Frequency:	2402~2472 MHz
	Modulation Type:	GFSK
	Date rate:	1Mbps
	Number of Channel	16CH .Please see note 2.
	Antenna Designation:	Printed antenna
	Antenna Gain(Peak)	2.07 dBi
	Output Power:	65.51dBuV/m (AV Max.)
Based on the application, features, or specification exhibited in User's Manual, the EUT is considered as an ITE/Computing Device. More details of EUT technical specification. Please refer to the User's Manual.		
Channel List	Please refer to the Note 2.	
Power Source	DC Voltage supplied from Host System	
Power Rating	I/P AC 120V/60Hz O/P DC 5V	
Connecting I/O Port(s)	Please refer to the User's Manual	

**Note:**

1. For a more detailed features description, please refer to the manufacturer's specifications or the User's Manual.





2.

Frequency Band	Channel No.	Frequency
2400~2483.5MHz	01	2402 MHz
	02	2405 MHz
	03	2408 MHz
	04	2411 MHz
	05	2425 MHz
	06	2432 MHz
	07	2435 MHz
	08	2439 MHz
	09	2447 MHz
	10	2450 MHz
	11	2462 MHz
	12	2465 MHz
	13	2468 MHz
	14	2470 MHz
	15	2471 MHz
	16	2472 MHz

3. Table for Filed Antenna

Ant.	Brand	Model Name	Antenna Type	Connector	Gain (dBi)
1	N/A	N/A	Printed Antenna	N/A	2.07



### 3.2 DESCRIPTION OF TEST MODES

To investigate the maximum EMI emission characteristics generated from EUT, the test system was pre-scanning tested based on the consideration of following EUT operation mode or test configuration mode which possible have effect on EMI emission level. Each of these EUT operation mode(s) or test configuration mode(s) mentioned above was evaluated respectively.

Pretest Mode	Description
Mode 1	CH Lower – 2402MHz
Mode 2	CH Middle – 2432MHz
Mode 3	CH Highest -2472MHz
Mode 4	Normal Link

For Conducted Test	
Final Test Mode	Description
Mode 4	Normal Link

For Radiated Test	
Final Test Mode	Description
Mode 1	CH Lower - 2402MHz
Mode 2	CH Middle - 2432MHz
Mode 3	CH Highest -2472MHz



3.3 BLOCK DIGRAM SHOWING THE CONFIGURATION OF SYSTEM TESTED

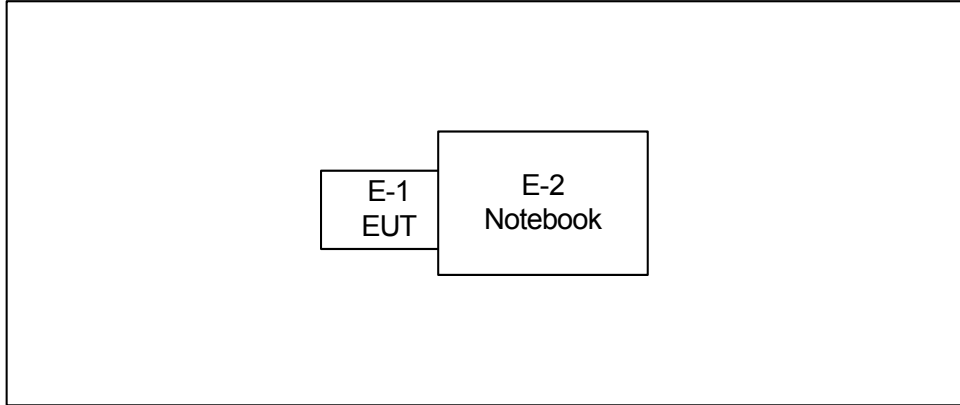



**3.4 DESCRIPTION OF SUPPORT UNITS**

The EUT has been tested as an independent unit together with other necessary accessories or support units. The following support units or accessories were used to form a representative test configuration during the tests.

Item	Equipment	Mfr/Brand	Model/Type No.	FCC ID	Series No.	Note
E-1	Wireless Laser Mouse	ARESON	C55	P5A-CL0022	N/A	EUT
E-2	Notebook	Dell	INSPIRON.1420	DOC	N/A	

Item	Shielded Type	Ferrite Core	Length	Note

**Note:**

- (1) The support equipment was authorized by Declaration of Confirmation.
- (2) For detachable type I/O cable should be specified the length in m in 『Length』 column.



**4. EMC EMISSION TEST**

**4.1 CONDUCTED EMISSION MEASUREMENT**

**4.1.1 POWER LINE CONDUCTED EMISSION LIMITS (Frequency Range 150KHz-30MHz)**

FREQUENCY (MHz)	Class A (dBuV)		Class B (dBuV)		Standard
	Quasi-peak	Average	Quasi-peak	Average	
0.15 -0.5	79.00	66.00	66 - 56 *	56 - 46 *	CISPR
0.50 -5.0	73.00	60.00	56.00	46.00	CISPR
5.0 -30.0	73.00	60.00	60.00	50.00	CISPR

0.15 -0.5	79.00	66.00	66 - 56 *	56 - 46 *	FCC
0.50 -5.0	73.00	60.00	56.00	46.00	FCC
5.0 -30.0	73.00	60.00	60.00	50.00	FCC

Note:

- (1) The tighter limit applies at the band edges.
- (2) The limit of " \* " marked band means the limitation decreases linearly with the logarithm of the frequency in the range.

**4.1.2 MEASUREMENT INSTRUMENTS LIST**

Item	Kind of Equipment	Manufacturer	Type No.	Serial No.	Calibrated until
1	LISN	EMCO	3816/2	00052765	May.26.2011
2	LISN	R&S	ENV216	100087	May.26.2011
3	Test Cable	N/A	C_17	N/A	Mar.31.2011
4	EMI TEST RECEIVER	R&S	ESCS30	8333641017	May.27.2011
5	50Ω Terminator	SHX	TF2-3G-A	08122902	May.26.2011

Remark: " N/A" denotes No Model Name. , Serial No. or No Calibration specified.

The following table is the setting of the receiver

Receiver Parameters	Setting
Attenuation	10 dB
Start Frequency	0.15 MHz
Stop Frequency	30 MHz
IF Bandwidth	9 kHz

#### 4.1.3 TEST PROCEDURE

- The EUT was placed 0.8 meters from the horizontal ground plane with EUT being connected to the power mains through a line impedance stabilization network (LISN). All other support equipments powered from additional LISN(s). The LISN provide 50 Ohm/ 50uH of coupling impedance for the measuring instrument.
- Interconnecting cables that hang closer than 40 cm to the ground plane shall be folded back and forth in the center forming a bundle 30 to 40 cm long.
- I/O cables that are not connected to a peripheral shall be bundled in the center. The end of the cable may be terminated, if required, using the correct terminating impedance. The overall length shall not exceed 1 m.
- LISN at least 80 cm from nearest part of EUT chassis.
- For the actual test configuration, please refer to the related Item –EUT Test Photos.

#### 4.1.4 DEVIATION FROM TEST STANDARD

No deviation

#### 4.1.5 TEST SETUP

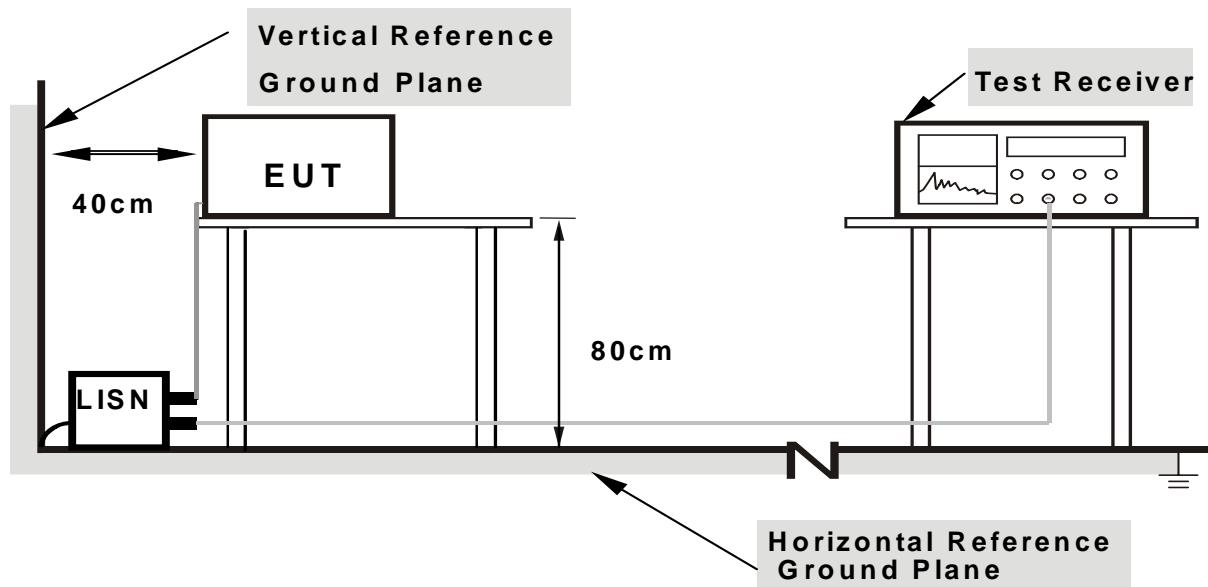

**Note: 1.Support units were connected to second LISN.**

**2.Both of LISNs (AMN) are 80 cm from EUT and at least 80 from other units and other metal planes**

#### 4.1.6 EUT OPERATING CONDITIONS

The EUT was configured for testing in a typical fashion (as a customer would normally use it). The EUT has been programmed to continuously transmit during test. This operating condition was tested and used to collect the included data.

The EUT was programmed to be in continuously transmitting mode.



**4.1.7 TEST RESULTS**

EUT :	Mini Receiver	Model Name. :	C55
Temperature :	21°C	Relative Humidity :	50 %
Pressure :	1001 hPa	Test Power :	AC 120V/60Hz
Test Mode :	Normal Link		

Freq. (MHz)	Terminal L/N	Measured(dBuV)		Limits(dBuV)		Margin (dB)	Note
		QP-Mode	AV-Mode	QP-Mode	AV-Mode		
0.34	Line	45.26	*	59.18	49.18	-13.92	(QP)
0.47	Line	43.54	*	56.54	46.54	-13.00	(QP)
0.84	Line	41.95	*	56.00	46.00	-14.05	(QP)
1.86	Line	42.03	*	56.00	46.00	-13.97	(QP)
2.93	Line	41.73	*	56.00	46.00	-14.27	(QP)
5.71	Line	42.88	*	60.00	50.00	-17.12	(QP)

**Remark**

- (1) All readings are QP Mode value unless otherwise stated AVG in column of 'Note'. If the QP Mode Measured value compliance with the QP Limits and lower than AVG Limits, the EUT shall be deemed to meet both QP & AVG Limits and then only QP Mode was measured, but AVG Mode didn't perform. In this case, a "\*" marked in AVG Mode column of Interference Voltage Measured.
- (2) Measuring frequency range from 150KHz to 30MHz.
- (3) "N/A" denotes test is not applicable in this Test Report.

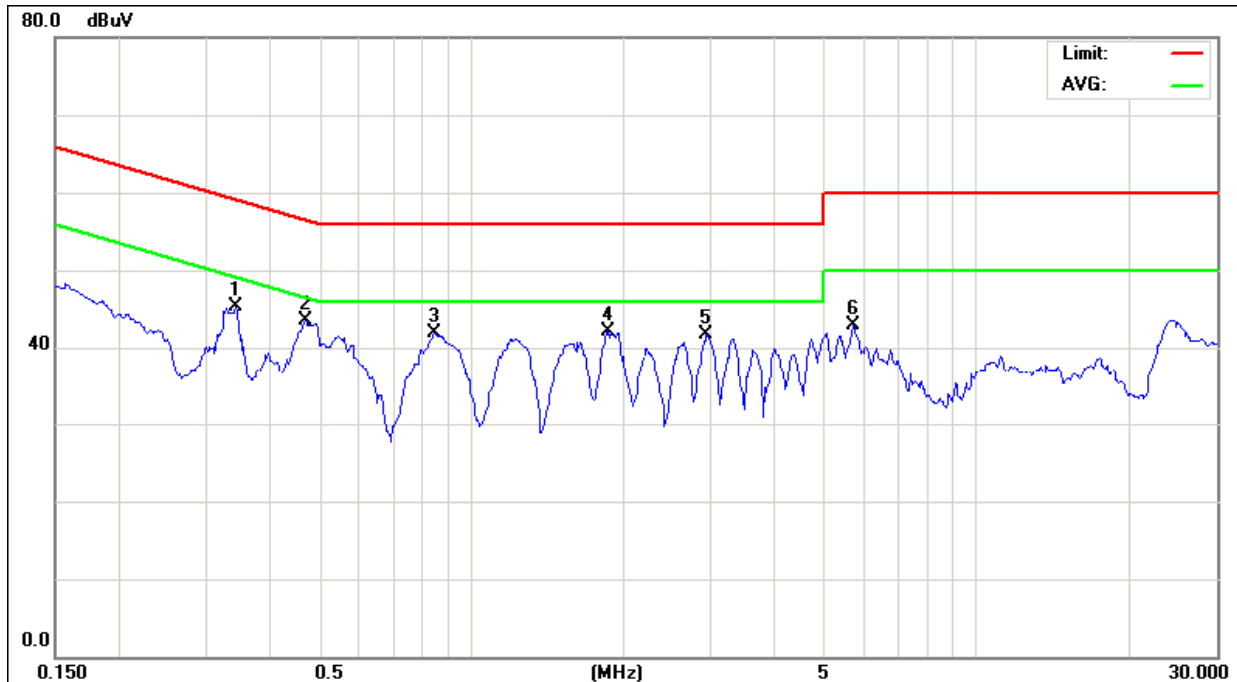



EUT :	Mini Receiver	Model Name. :	C55
Temperature :	21°C	Relative Humidity :	50 %
Pressure :	1001 hPa	Test Power :	AC 120V/60Hz
Test Mode :	Normal Link		

Freq. (MHz)	Terminal L/N	Measured(dBuV)		Limits(dBuV)		Margin (dB)	Note
		QP-Mode	AV-Mode	QP-Mode	AV-Mode		
0.33	Neutral	46.08	*	59.49	49.49	-13.41	(QP)
0.47	Neutral	43.31	*	56.54	46.54	-13.23	(QP)
0.92	Neutral	40.84	*	56.00	46.00	-15.16	(QP)
1.58	Neutral	39.96	*	56.00	46.00	-16.04	(QP)
2.99	Neutral	41.47	*	56.00	46.00	-14.53	(QP)
5.11	Neutral	44.61	*	60.00	50.00	-15.39	(QP)

**Remark**

- (1) All readings are QP Mode value unless otherwise stated AVG in column of 'Note'. If the QP Mode Measured value compliance with the QP Limits and lower than AVG Limits, the EUT shall be deemed to meet both QP & AVG Limits and then only QP Mode was measured, but AVG Mode didn't perform. In this case, a " \* " marked in AVG Mode column of Interference Voltage Measured.
- (2) Measuring frequency range from 150KHz to 30MHz.
- (3) " N/A " denotes test is not applicable in this Test Report.

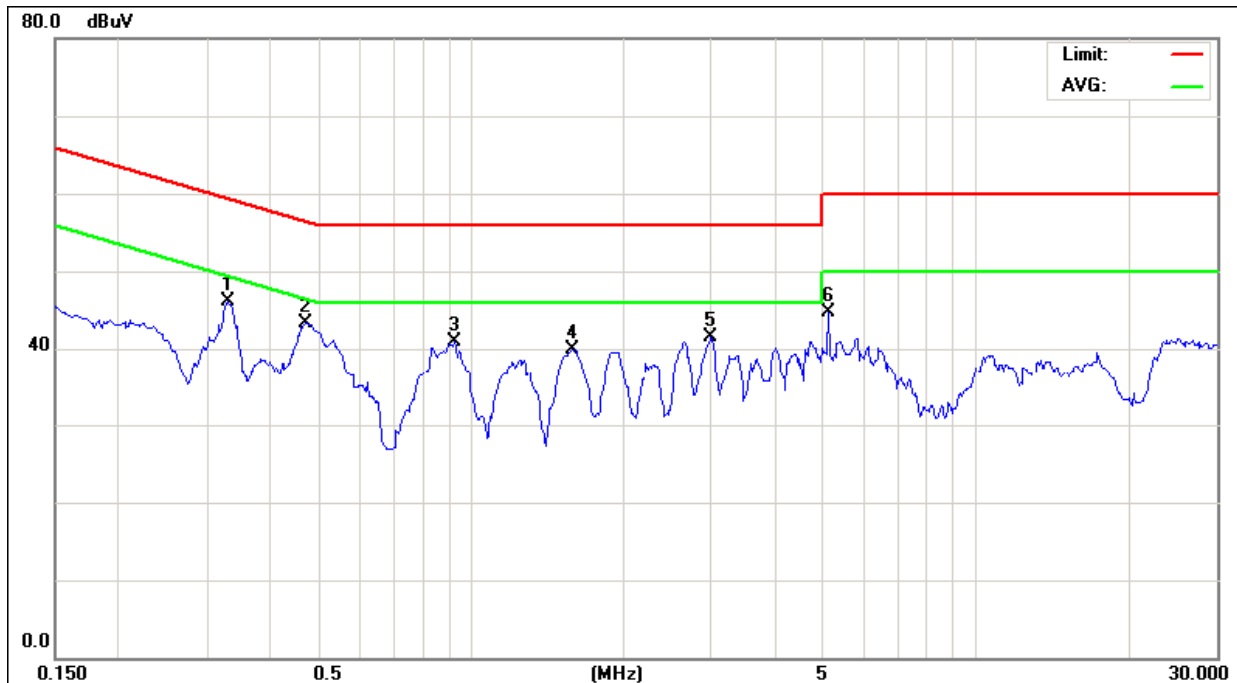





**4.2 RADIATED EMISSION MEASUREMENT**

**4.2.1 RADIATED EMISSION LIMITS ( FCC 15.209 )**

<b>Frequencies (MHz)</b>	<b>Field Strength (micorvolts/meter)</b>	<b>Measurement Distance (meters)</b>
0.009~0.490	2400/F(KHz)	300
0.490~1.705	24000/F(KHz)	30
1.705~30.0	30	30
30~88	100	3
88~216	150	3
216~960	200	3
Above 960	500	3

Harmonic emissions limits comply with below 54 dBuV/m at 3m. Other emissions radiated outside of the specified frequency bands, except for harmonics, shall be attenuated by at least 50 dB below the level of the fundamental or comply with the radiated emissions limits specified in section 15.209(a) limit in the table below has to be followed.

Note:

- (1) The tighter limit applies at the band edges.
- (2) Emission level (dBuV/m)=20log Emission level (uV/m).

**LIMITS OF RADIATED EMISSION MEASUREMENT ( FCC 15.209 )**

FREQUENCY (MHz)	(dBuV/m) (at 3m)	
	PEAK	AVERAGE
Above 1000	74	54

Notes:

- (1) The limit for radiated test was performed according to FCC PART 15C.
- (2) The tighter limit applies at the band edges.
- (3) Emission level (dBuV/m)=20log Emission level (uV/m).

**LIMITS OF RADIATED EMISSION MEASUREMENT (FCC Part 15.249)**

FCC Part15 (15.249) , Subpart C	
Limit	Frequency Range (MHz)
Field strength of fundamental 50000 μV/m (94 dBμV/m) @ 3 m	2400-2483.5
Field strength of harmonics 500 μV/m (54 dBμV/m) @ 3 m	Above 2483.5



4.2.2 MEASUREMENT INSTRUMENTS LIST

Item	Kind of Equipment	Manufacturer	Type No.	Serial No.	Calibrated until
1	Triple Loop Antenna	R&S	HFH2-Z2	830749/020	May.27.2011
2	Bi-log Antenna	Schwarbeck	VULB9160	9160-3232	May.26.2011
3	Horn Antenna	ETS	3115	00075789	May.12.2011
4	Broad-Band Horn Antenna	Schwarzbeck	BBHA 9170	9170340	Dec.15.2011
5	Amplifier	HP	8447D	2944A09673	May.26.2011
6	Amplifier	Agilent	8449B	3008A02274	May.26.2011
7	Amplifier	EMC	EMC2654045	980039	Aug.12.2011
8	Test Receiver	R&S	ESCI	100895	May.26.2011
9	Spectrum Analyzer	R&S	FSP 40	100185	Nov.26.2011
10	Test Cable	N/A	C-01_CB03	N/A	Jul.05.2011
11	Test Cable	HUBER+SUHNER	SUCOFLEX_8m	313794/4	Apr.12.2011
12	Controller	CT	SC100	N/A	N/A

Remark: " N/A" denotes No Model Name. / Serial No. and No Calibration specified.

Spectrum Parameter	Setting
Attenuation	Auto
Start Frequency	1000 MHz
Stop Frequency	10th carrier harmonic
RB / VB (emission in restricted band)	1 MHz / 1 MHz for Peak, Average=PK-duty cycle

Receiver Parameter	Setting
Attenuation	Auto
Start ~ Stop Frequency	9kHz~150kHz / RB 200Hz for QP
Start ~ Stop Frequency	150kHz~30MHz / RB 9kHz for QP
Start ~ Stop Frequency	30MHz~1000MHz / RB 120kHz for QP



## **Neutron Engineering Inc.**

DUTY CYCLE: TX 2432MHz (1Mbps)

Dwell time=ON/ON+OFF

ON: 0.44msec

ON+OFF: (total time):2.84msec

Dwell time: 15.49%

AV=PK+20 log(Dwell time)

AV=PK-16.20

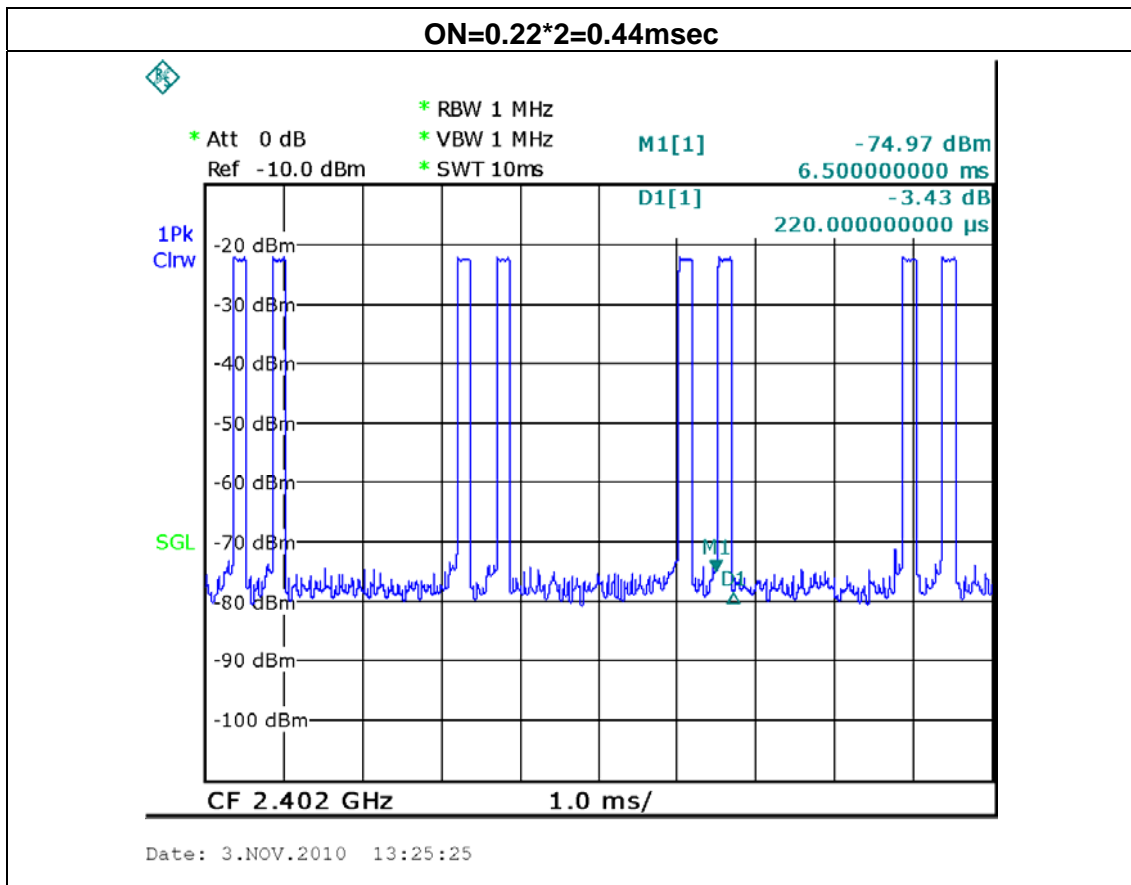
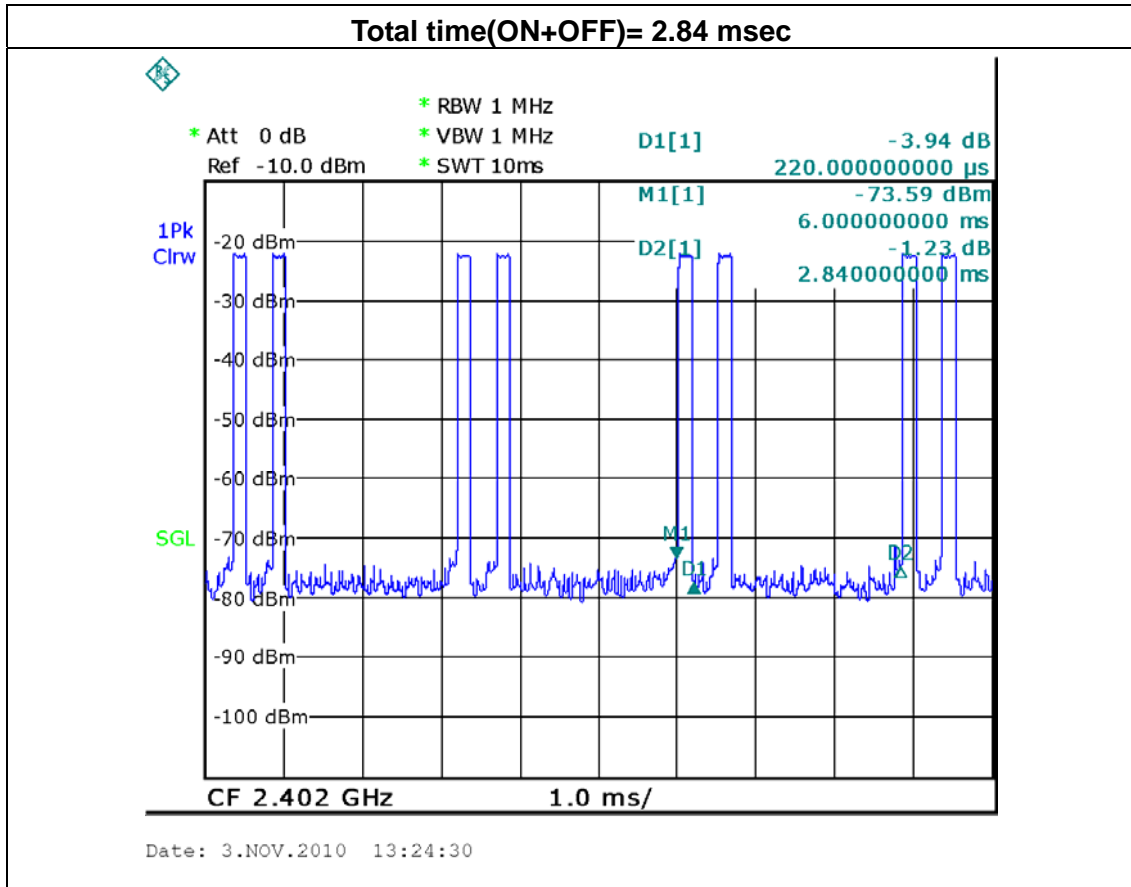



#### 4.2.3 TEST PROCEDURE

- a. The measuring distance of at 3 m shall be used for measurements at frequency up to 1GHz. For frequencies above 1GHz, any suitable measuring distance may be used.
- b. The EUT was placed on the top of a rotating table 0.8 meters above the ground at a 3m meter semi-anechoic chamber. The table was rotated 360 degrees to determine the position of the highest radiation.
- c. The height of the equipment or of the substitution antenna shall be 0.8 m; the height of the test antenna shall vary between 1 m to 4 m. Both horizontal and vertical polarizations of the antenna are set to make the measurement.
- d. The initial step in collecting conducted emission data is a spectrum analyzer peak detector mode pre-scanning the measurement frequency range. Significant peaks are then marked and then Quasi Peak detector mode re-measured.
- e. If the Peak Mode measured value compliance with and lower than Quasi Peak Mode Limit, the EUT shall be deemed to meet QP Limits and then no additional QP Mode measurement performed.
- f. For the actual test configuration, please refer to the related Item –EUT Test Photos.

#### 4.2.4 DEVIATION FROM TEST STANDARD

No deviation

4.2.5 TEST SETUP

(A) Radiated Emission Test Set-Up Frequency Below 1 GHz

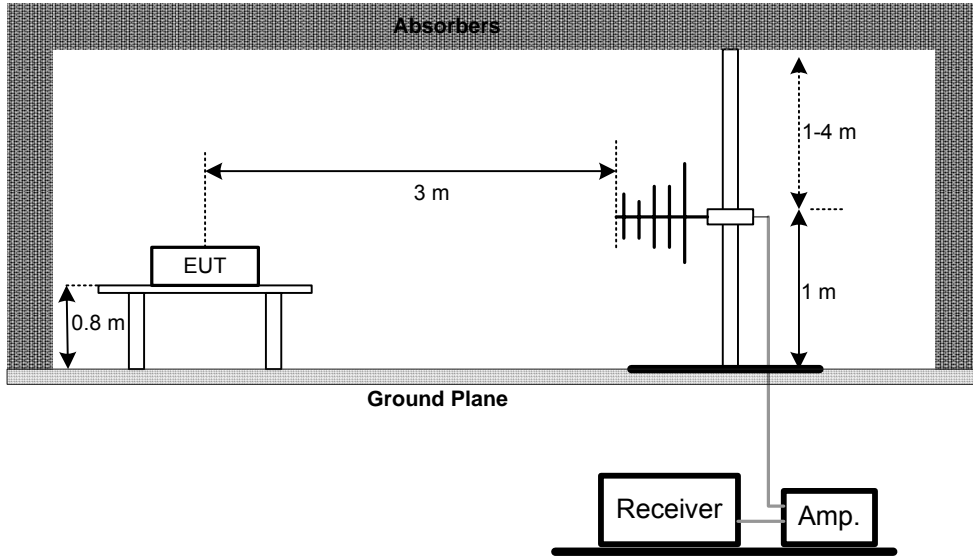

(B) Radiated Emission Test Set-Up Frequency Above 1 GHz

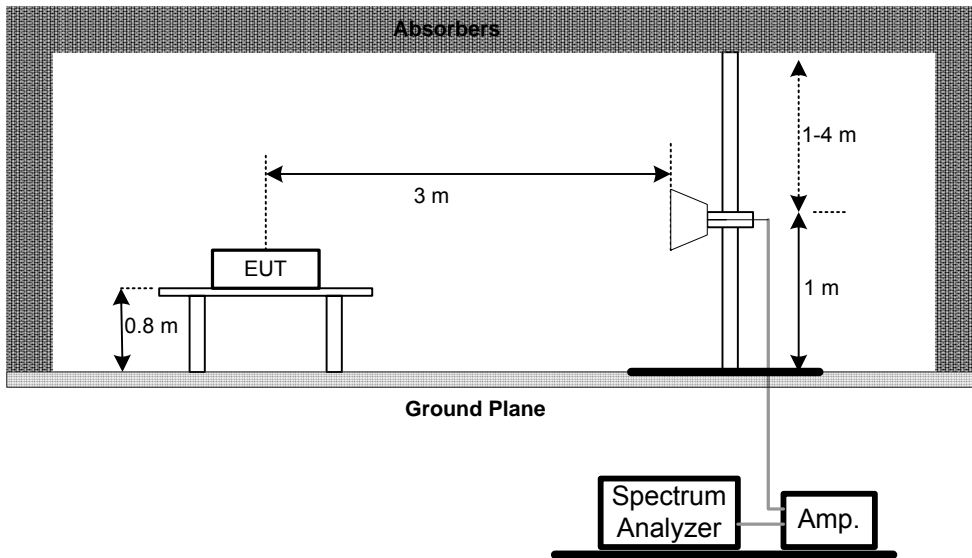

(C) For radiated emissions below 30MHz

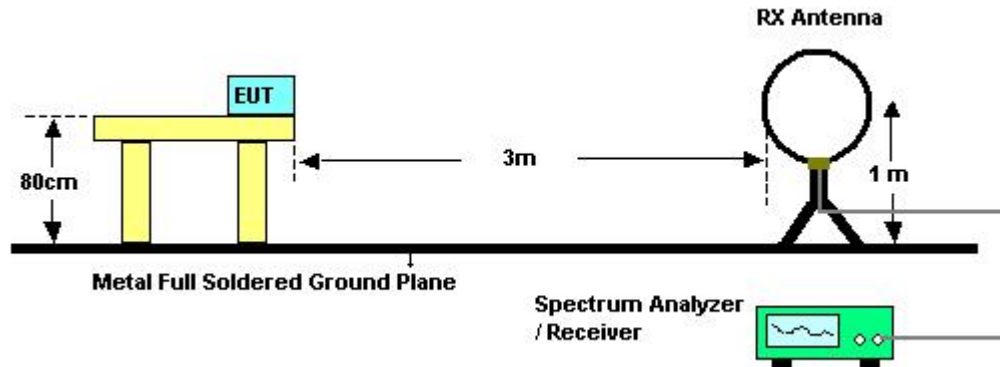

#### 4.2.6 EUT OPERATING CONDITIONS

The EUT tested system was configured as the statements of 4.1.6 Unless otherwise a special operating condition is specified in the follows during the testing.



4.2.7 TEST RESULTS (BELOW 30MHz)

EUT :	Mini Receiver	Model Name. :	C55
Temperature :	20°C	Relative Humidity :	50 %
Pressure :	1001 hPa	Test Power :	AC 120V/60Hz
Test Mode :	TX Mode		

Freq. (MHz)	Ant. 0°/90°	Reading(RA) (dBuV)	Corr.Factor(CF) (dB)	Measured(FS) (dBuV/m)	Limits(QP) (dBuV/m)	Margin (dB)	Note
0.13	0°	78.76	20.86	57.90	105.06	-47.16	PK
0.19	0°	72.11	20.53	51.58	102.17	-50.58	PK
1.34	0°	64.33	19.57	44.76	65.06	-20.30	PK
4.54	0°	50.56	18.57	32.00	69.54	-37.54	PK
10.45	0°	53.43	17.83	35.60	69.54	-33.94	PK
24.34	0°	46.76	16.36	40.40	69.54	-29.14	PK

Freq. (MHz)	Ant. 0°/90°	Reading(RA) (dBuV)	Corr.Factor(CF) (dB)	Measured(FS) (dBuV/m)	Limits(QP) (dBuV/m)	Margin (dB)	Note
0.13	90°	76.00	20.86	55.14	105.06	-49.92	PK
0.19	90°	69.65	20.53	49.12	102.17	-53.04	PK
1.34	90°	54.56	19.57	34.99	65.06	-30.07	PK
4.54	90°	48.88	18.57	30.31	69.54	-39.23	PK
10.45	90°	49.86	17.83	32.03	69.54	-37.51	PK
24.34	90°	54.56	16.36	38.20	69.54	-31.34	PK

Remark :

- (1) The amplitude of spurious emissions which are attenuated by more than 20 dB below the permissible value has no need to be reported ◦
- (2) Distance extrapolation factor = 40 log (specific distance / test distance) (dB); ◦
- (3) Limit line = specific limits (dBuV) + distance extrapolation factor. ◦





**4.2.8 TEST RESULTS (BETWEEN 30 – 1000 MHz)**

EUT :	Mini Receiver	Model Name. :	C55
Temperature :	23°C	Relative Humidity :	58 %
Pressure :	1001 hPa	Test Power :	AC 120V/60Hz
Test Mode :	TX Mode		

Freq. (MHz)	Ant. H/V	Reading(RA) (dBuV)	Corr.Factor(CF) (dB)	Measured(FS) (dBuV/m)	Limits(QP) (dBuV/m)	Margin (dB)	Note
79.56	V	46.46	-19.04	27.42	40.00	- 12.58	
120.33	V	46.58	-18.28	28.30	43.50	- 15.20	
172.09	V	48.30	-17.21	31.09	43.50	- 12.41	
226.84	V	45.28	-15.68	29.60	46.00	- 16.40	
274.89	V	43.91	-12.97	30.94	46.00	- 15.06	
346.12	V	41.15	-10.94	30.21	46.00	- 15.79	

**Remark :**

- (1) All readings are Peak unless otherwise stated QP in column of 『Note』 . Peak denotes that the Peak reading compliance with the QP Limits and then QP Mode measurement didn't perform ◦
- (2) Measuring frequency range from 30MHz to 1000MHz or the 10th harmonic of highest fundamental frequency ◦ “F” denotes fundamental frequency; “ H” denotes spurious frequency. “E” denotes band edge frequency.
- (3) Radiated emissions measured in frequency range from 30 MHz to 1000 MHz were made with an instrument using Peak detector mode or QP detector mode of the emission ◦
- (4) Data of measurement within this frequency range shown “ - ” in the table above means the reading of emissions are attenuated more than 20dB below the permissible limits or the field strength is too small to be measured.

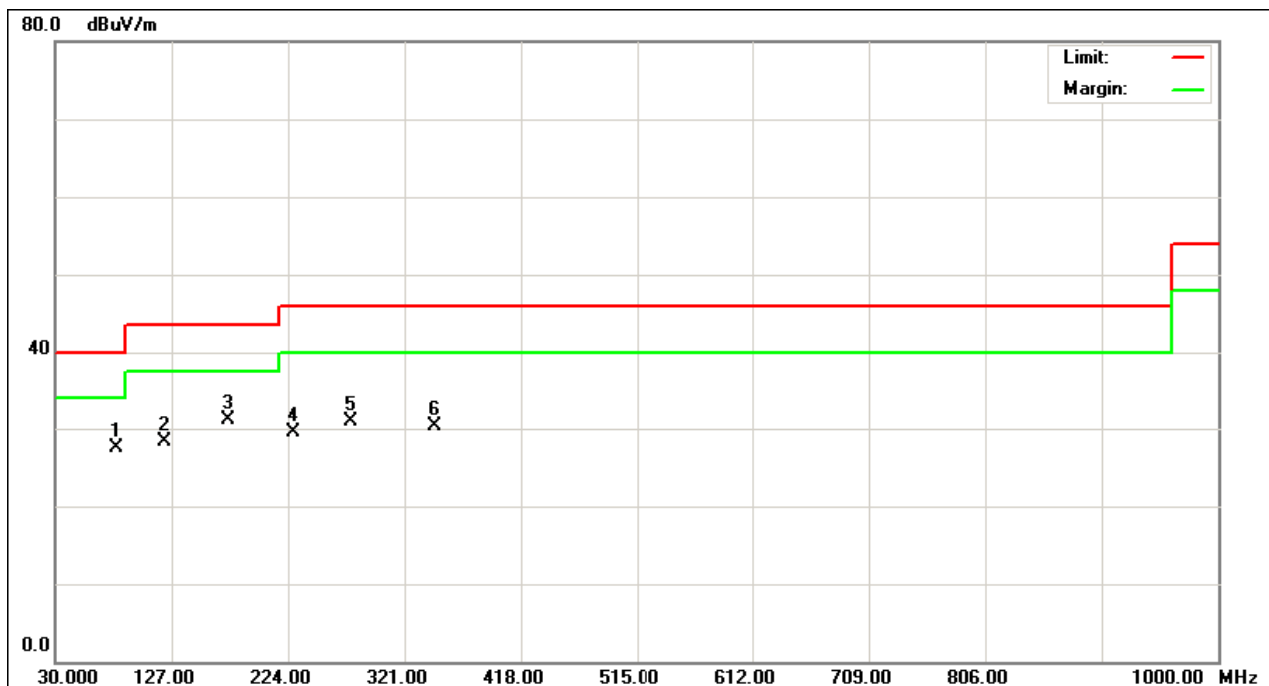



EUT :	Mini Receiver	Model Name. :	C55
Temperature :	23°C	Relative Humidity :	58 %
Pressure :	1001 hPa	Test Power :	AC 120V/60Hz
Test Mode :	TX Mode		

Freq. (MHz)	Ant. H/V	Reading(RA) (dBuV)	Corr.Factor(CF) (dB)	Measured(FS) (dBuV/m)	Limits(QP) (dBuV/m)	Margin (dB)	Note
82.31	H	45.69	-19.10	26.59	40.00	- 13.41	
129.62	H	45.74	-18.11	27.63	43.50	- 15.87	
195.46	H	43.46	-16.64	26.82	43.50	- 16.68	
238.29	H	46.38	-15.24	31.14	46.00	- 14.86	
315.64	H	42.57	-11.69	30.88	46.00	- 15.12	
356.22	H	43.91	-10.61	33.30	46.00	- 12.70	

**Remark :**

- (1) All readings are Peak unless otherwise stated QP in column of 『Note』 . Peak denotes that the Peak reading compliance with the QP Limits and then QP Mode measurement didn't perform ◦
- (2) Measuring frequency range from 30MHz to 1000MHz or the 10th harmonic of highest fundamental frequency ◦ “F” denotes fundamental frequency; “ H” denotes spurious frequency. “E” denotes band edge frequency.
- (3) Radiated emissions measured in frequency range from 30 MHz to 1000 MHz were made with an instrument using Peak detector mode or QP detector mode of the emission ◦
- (4) Data of measurement within this frequency range shown “ - ” in the table above means the reading of emissions are attenuated more than 20dB below the permissible limits or the field strength is too small to be measured.

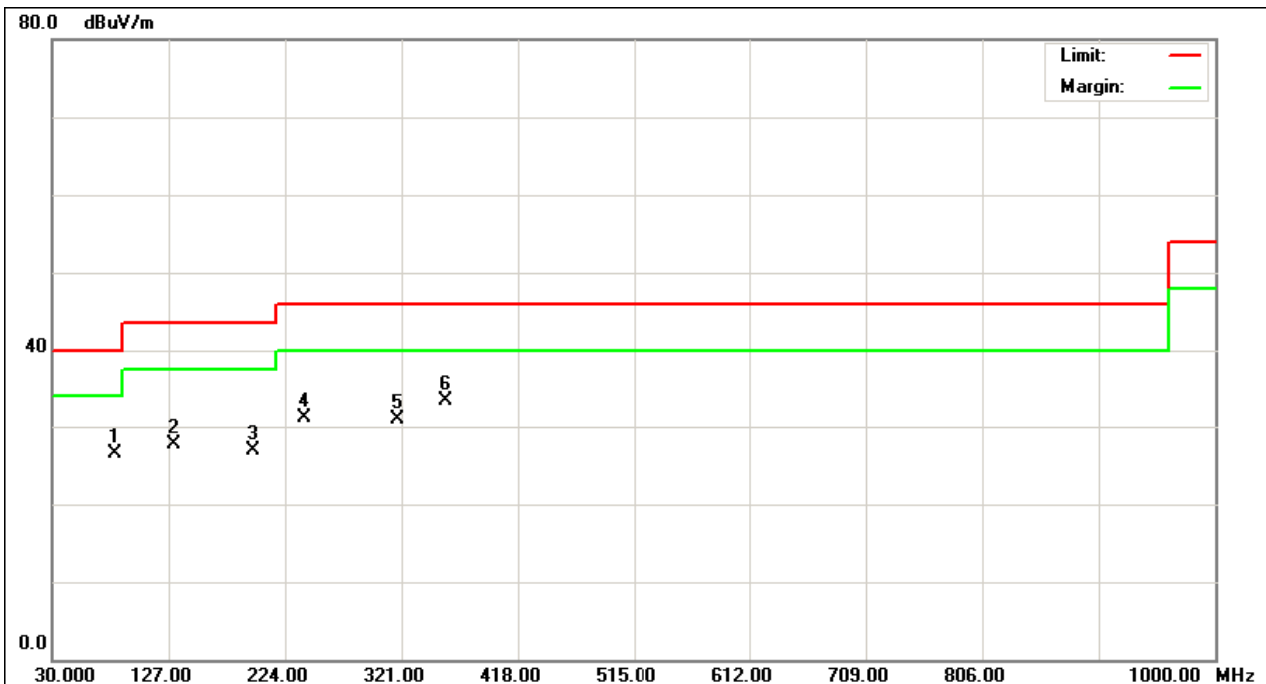



4.2.9 TEST RESULTS (ABOVE 1000 MHz)

EUT :	Mini Receiver	Model Name. :	C55
Temperature :	20°C	Relative Humidity :	55 %
Pressure :	1001 hPa	Test Power :	AC 120V/60Hz
Test Mode :	TX 2402MHz		

Freq. (MHz)	Ant.Pol. H/V	Reading		Ant./CF CF(dB)	Act.		Limit		Note
		Peak (dBuV)	AV (dBuV)		Peak (dBuV/m)	AV (dBuV/m)	Peak (dBuV/m)	AV (dBuV/m)	
2390.00	V	23.05	6.85	31.61	54.66	38.46	74.00	54.00	X/E
<b>2402.50</b>	<b>V</b>	<b>49.09</b>	<b>32.89</b>	<b>31.60</b>	<b>80.69</b>	<b>64.49</b>	<b>114.00</b>	<b>94.00</b>	<b>X/F</b>
4803.73	V	39.89	24.00	6.13	46.02	30.13	74.00	54.00	X/H

Remark :

- (1) All readings are Peak unless otherwise stated QP in column of 『Note』 . Peak denotes that the Peak reading compliance with the QP Limits and then QP Mode measurement didn't perform ◦
- (2) Measuring frequency range from 30MHz to 1000MHz or the 10th harmonic of highest fundamental frequency ◦ "F" denotes fundamental frequency; "H" denotes spurious frequency. "E" denotes band edge frequency. (This judgment method includes the Band Edge Requirement.)
- (3) Radiated emissions measured in frequency range above 1000MHz were made with an instrument using Peak detector mode and AV detector mode of the emission ◦
- (4) Data of measurement within this frequency range shown " \* " in the table above means the reading of emissions are attenuated more than 20dB below the permissible limits or the field strength is too small to be measured.
- (5) A preamp and high pass filter were used for this test in order to provide sufficient measurement sensitivity.
- (6) EUT Orthogonal Axis :  
"X" - denotes Laid on Table ; "Y" - denotes Vertical Stand ; "Z" - denotes Side Stand
- (7) During the measurements above 1 GHz it is taken care of that the EUT is always within the 3 dB cone of radiation BW of the used antenna
- (8) The average value of fundamental frequency is:  
Average = Peak value + 20log(Duty cycle) ◦ Final AV=PK-16.20



Orthogonal Axis : X  
TX 2402MHz (Above 1000 MHz, Vertical)

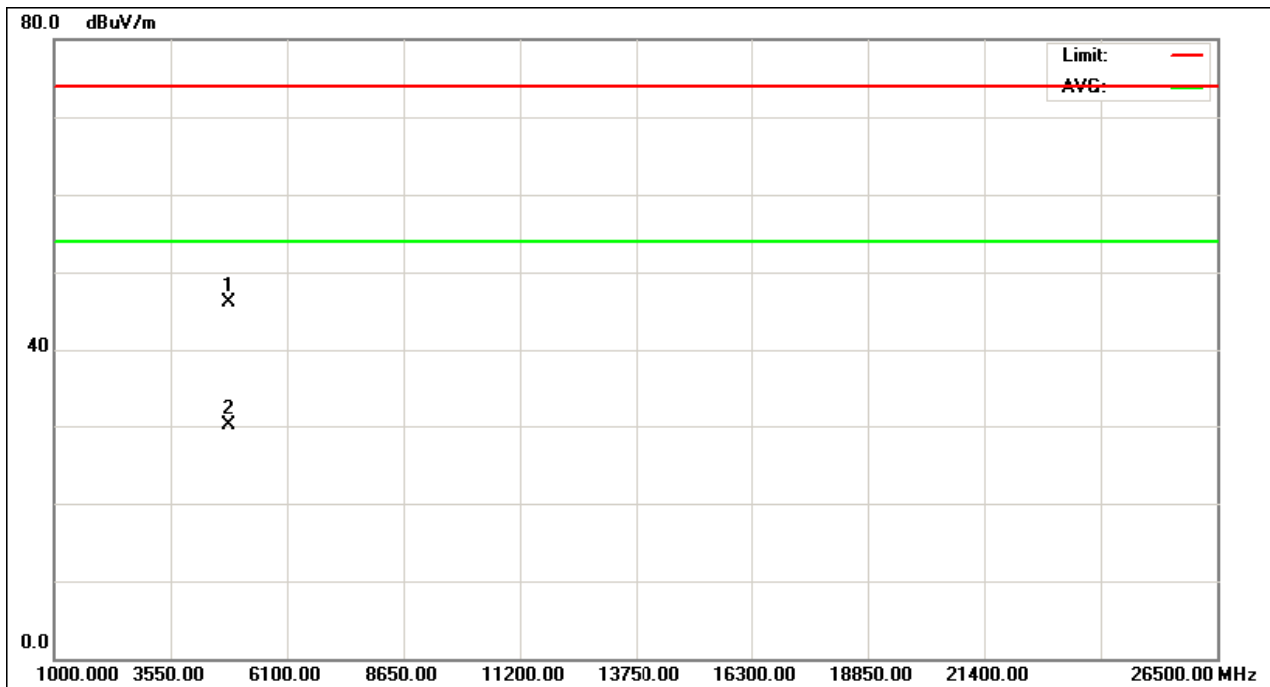
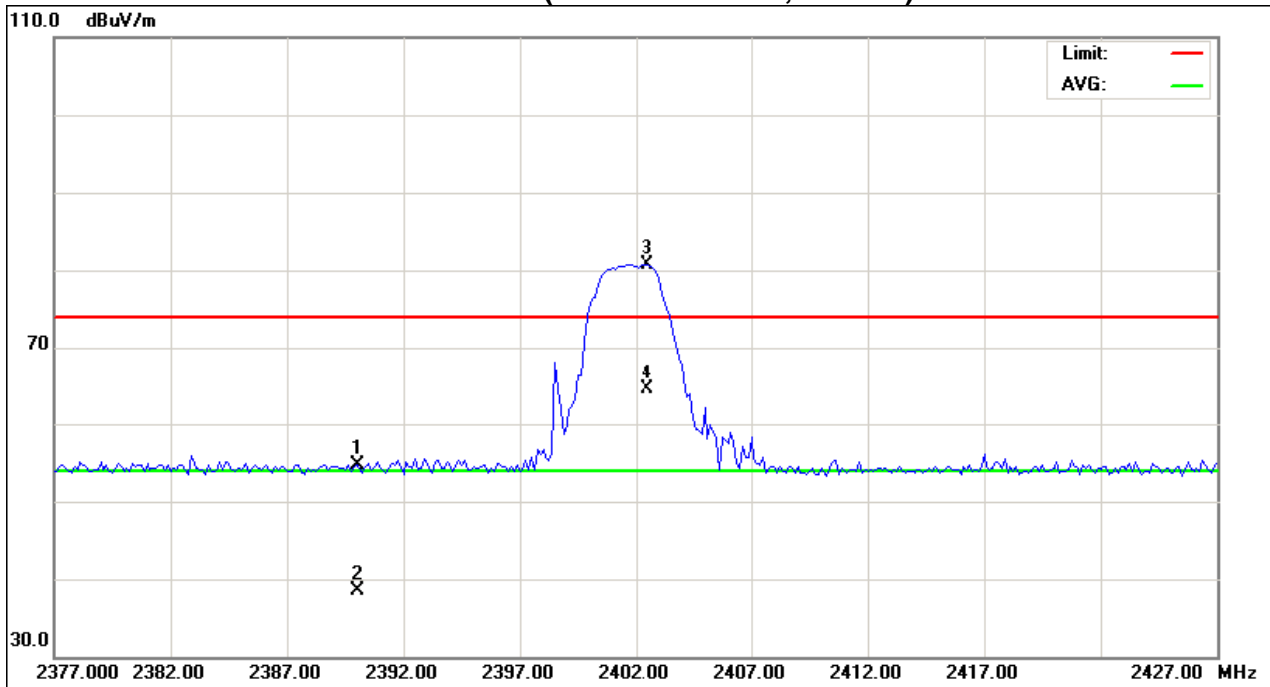



EUT :	Mini Receiver	Model Name. :	C55
Temperature :	20°C	Relative Humidity :	55 %
Pressure :	1001 hPa	Test Power :	AC 120V/60Hz
Test Mode :	TX 2402MHz		

Freq. (MHz)	Ant.Pol. H/V	Reading		Ant./CF CF(dB)	Act.		Limit		Note
		Peak (dBuV)	AV (dBuV)		Peak (dBuV/m)	AV (dBuV/m)	Peak (dBuV/m)	AV (dBuV/m)	
2390.00	H	22.60	6.40	31.61	54.21	38.01	74.00	54.00	X/E
<b>2402.38</b>	<b>H</b>	<b>49.25</b>	<b>33.05</b>	<b>31.60</b>	<b>80.85</b>	<b>64.65</b>	<b>114.00</b>	<b>94.00</b>	<b>X/F</b>
4804.65	H	40.78	24.58	6.14	46.92	30.72	74.00	54.00	X/H

Remark :

- (1) All readings are Peak unless otherwise stated QP in column of 『Note』 . Peak denotes that the Peak reading compliance with the QP Limits and then QP Mode measurement didn't perform ◦
- (2) Measuring frequency range from 30MHz to 1000MHz or the 10th harmonic of highest fundamental frequency ◦ "F" denotes fundamental frequency; "H" denotes spurious frequency. "E" denotes band edge frequency. (This judgment method includes the Band Edge Requirement.)
- (3) Radiated emissions measured in frequency range above 1000MHz were made with an instrument using Peak detector mode and AV detector mode of the emission ◦
- (4) Data of measurement within this frequency range shown " \* " in the table above means the reading of emissions are attenuated more than 20dB below the permissible limits or the field strength is too small to be measured.
- (5) A preamp and high pass filter were used for this test in order to provide sufficient measurement sensitivity.
- (6) EUT Orthogonal Axis :  
"X" - denotes Laid on Table ; "Y" - denotes Vertical Stand ; "Z" - denotes Side Stand
- (7) During the measurements above 1 GHz it is taken care of that the EUT is always within the 3 dB cone of radiation BW of the used antenna
- (8) The average value of fundamental frequency is:  
Average = Peak value + 20log(Duty cycle) ◦ Final AV=PK-16.20



Orthogonal Axis : X  
TX 2402MHz (Above 1000 MHz, Horizontal)

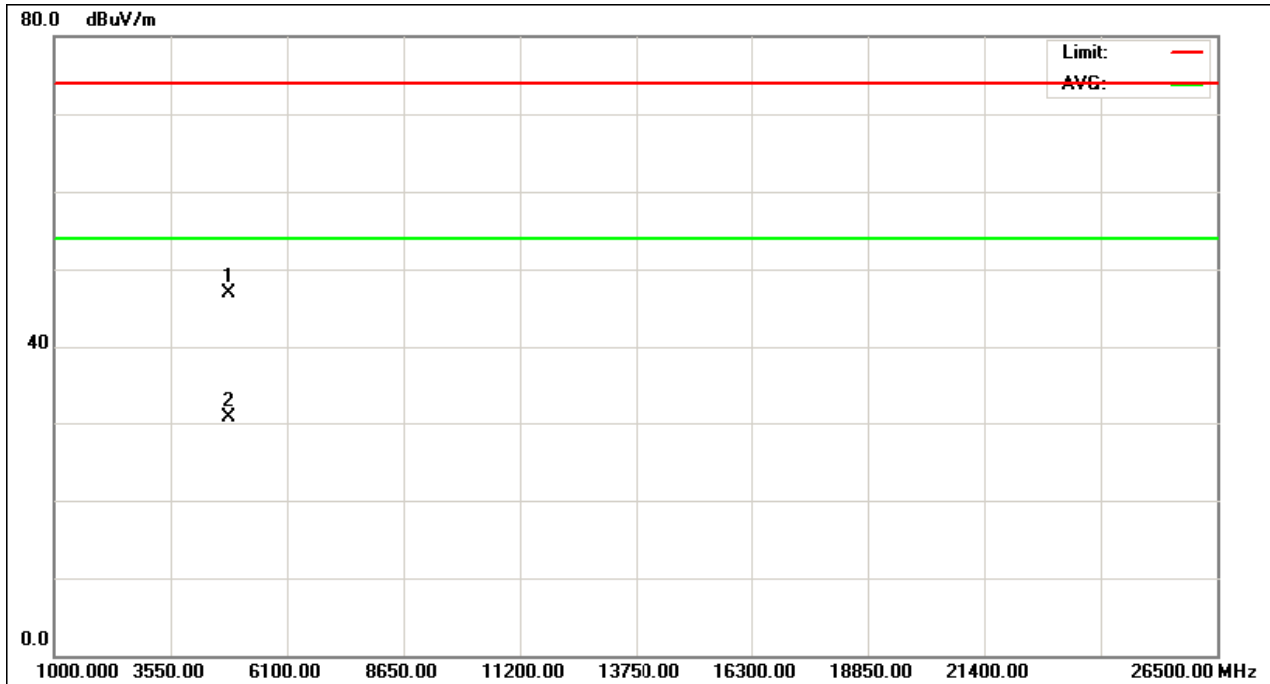
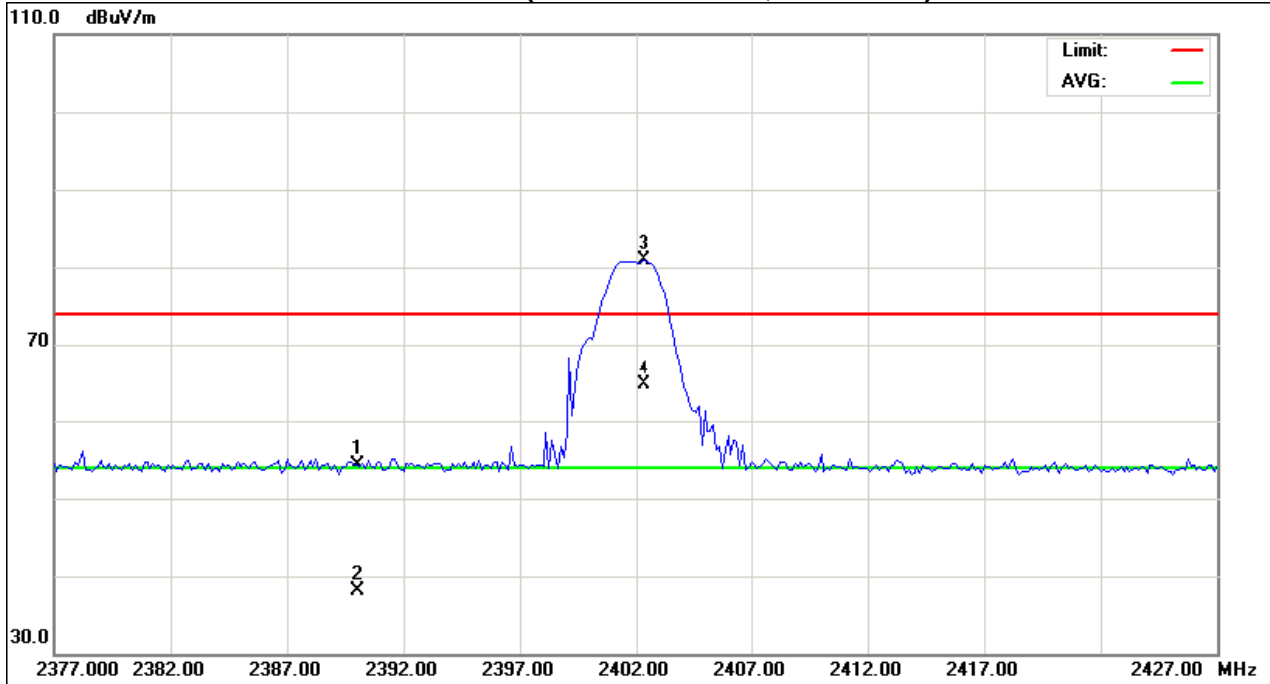



EUT :	Mini Receiver	Model Name. :	C55
Temperature :	20°C	Relative Humidity :	55 %
Pressure :	1001 hPa	Test Power :	AC 120V/60Hz
Test Mode :	TX 2432MHz		

Freq. (MHz)	Ant. Pol. H/V	Reading		Ant./CF CF(dB)	Act.		Limit		Note
		Peak (dBuV)	AV (dBuV)		Peak (dBuV/m)	AV (dBuV/m)	Peak (dBuV/m)	AV (dBuV/m)	
<b>2431.50</b>	<b>V</b>	<b>48.88</b>	<b>32.68</b>	<b>31.57</b>	<b>80.45</b>	<b>64.25</b>	<b>114.00</b>	<b>94.00</b>	<b>X/F</b>
4864.75	V	38.72	22.52	6.44	45.16	28.96	74.00	54.00	X/H

Remark :

- (1) All readings are Peak unless otherwise stated QP in column of 『Note』 . Peak denotes that the Peak reading compliance with the QP Limits and then QP Mode measurement didn't perform ◦
- (2) Measuring frequency range from 30MHz to 1000MHz or the 10th harmonic of highest fundamental frequency ◦ "F" denotes fundamental frequency; "H" denotes spurious frequency. "E" denotes band edge frequency. (This judgment method includes the Band Edge Requirement.)
- (3) Radiated emissions measured in frequency range above 1000MHz were made with an instrument using Peak detector mode and AV detector mode of the emission ◦
- (4) Data of measurement within this frequency range shown " \* " in the table above means the reading of emissions are attenuated more than 20dB below the permissible limits or the field strength is too small to be measured.
- (5) A preamp and high pass filter were used for this test in order to provide sufficient measurement sensitivity.
- (6) EUT Orthogonal Axis :  
"X" - denotes Laid on Table ; "Y" - denotes Vertical Stand ; "Z" - denotes Side Stand
- (7) During the measurements above 1 GHz it is taken care of that the EUT is always within the 3 dB cone of radiation BW of the used antenna
- (8) The average value of fundamental frequency is:  
Average = Peak value + 20log(Duty cycle) ◦ Final AV=PK-16.20



Orthogonal Axis : X  
TX 2432 MHz (Above 1000 MHz, Vertical)

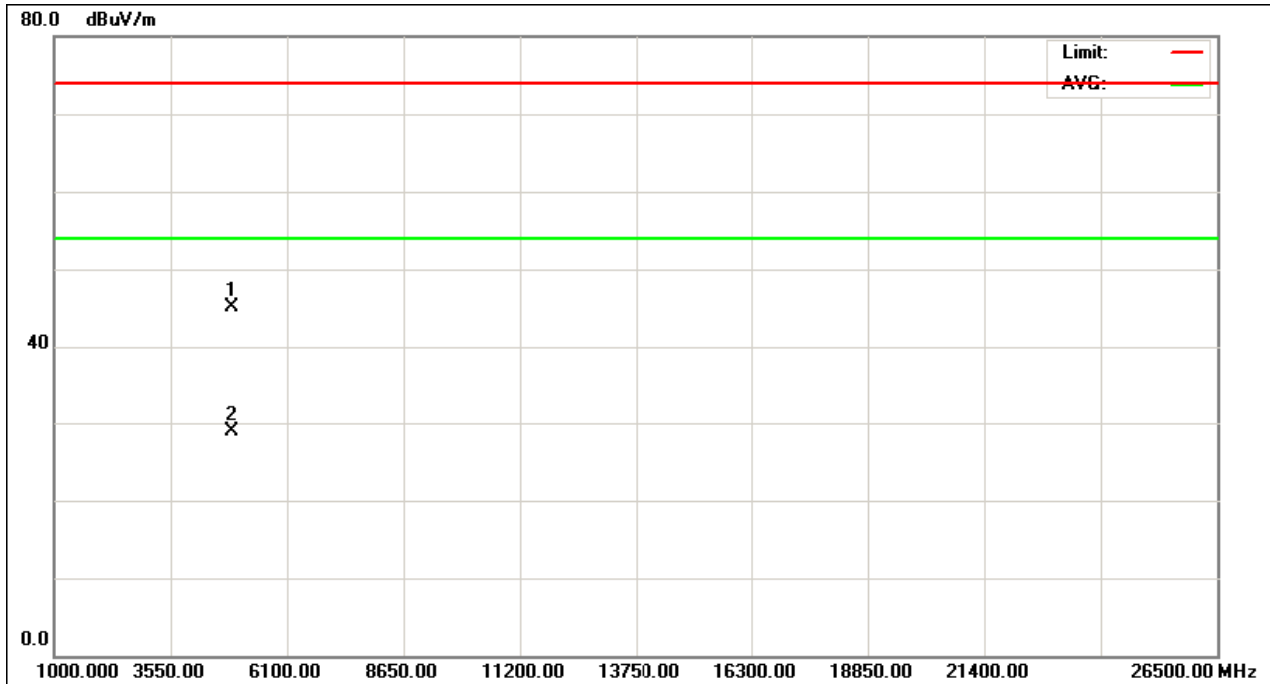
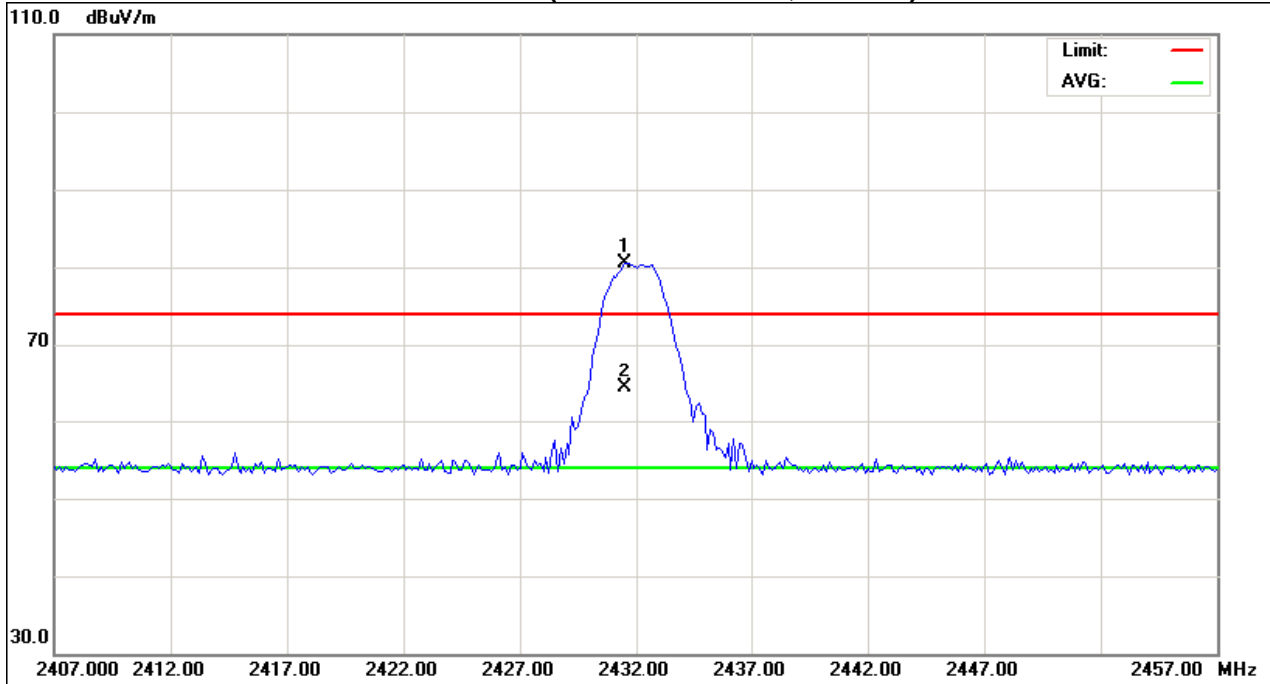





EUT :	Mini Receiver	Model Name. :	C55
Temperature :	20°C	Relative Humidity :	55 %
Pressure :	1001 hPa	Test Power :	AC 120V/60Hz
Test Mode :	TX 2432MHz		

Freq. (MHz)	Ant.Pol. H/V	Reading		Ant./CF CF(dB)	Act.		Limit		Note
		Peak (dBuV)	AV (dBuV)		Peak (dBuV/m)	AV (dBuV/m)	Peak (dBuV/m)	AV (dBuV/m)	
<b>2432.38</b>	<b>H</b>	<b>49.11</b>	<b>32.91</b>	<b>31.57</b>	<b>80.68</b>	<b>64.48</b>	<b>114.00</b>	<b>94.00</b>	<b>X/F</b>
4864.00	H	41.29	25.09	6.42	47.71	31.51	74.00	54.00	X/H

Remark :

- (1) All readings are Peak unless otherwise stated QP in column of 『Note』 . Peak denotes that the Peak reading compliance with the QP Limits and then QP Mode measurement didn't perform ◦
- (2) Measuring frequency range from 30MHz to 1000MHz or the 10th harmonic of highest fundamental frequency ◦ "F" denotes fundamental frequency; "H" denotes spurious frequency. "E" denotes band edge frequency. (This judgment method includes the Band Edge Requirement.)
- (3) Radiated emissions measured in frequency range above 1000MHz were made with an instrument using Peak detector mode and AV detector mode of the emission ◦
- (4) Data of measurement within this frequency range shown " \* " in the table above means the reading of emissions are attenuated more than 20dB below the permissible limits or the field strength is too small to be measured.
- (5) A preamp and high pass filter were used for this test in order to provide sufficient measurement sensitivity.
- (6) EUT Orthogonal Axis :  
"X" - denotes Laid on Table ; "Y" - denotes Vertical Stand ; "Z" - denotes Side Stand
- (7) During the measurements above 1 GHz it is taken care of that the EUT is always within the 3 dB cone of radiation BW of the used antenna
- (8) The average value of fundamental frequency is:  
Average = Peak value + 20log(Duty cycle) ◦ Final AV=PK-16.20



Orthogonal Axis : X  
TX 2432MHz (Above 1000 MHz, Horizontal)

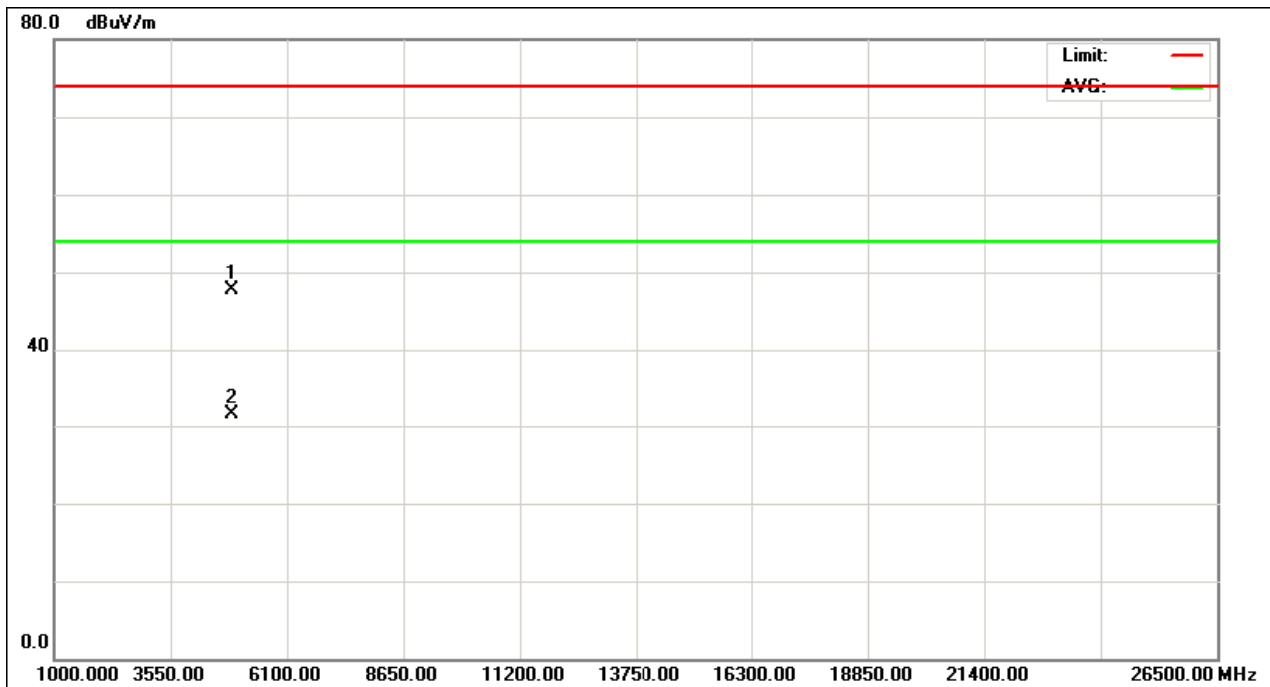
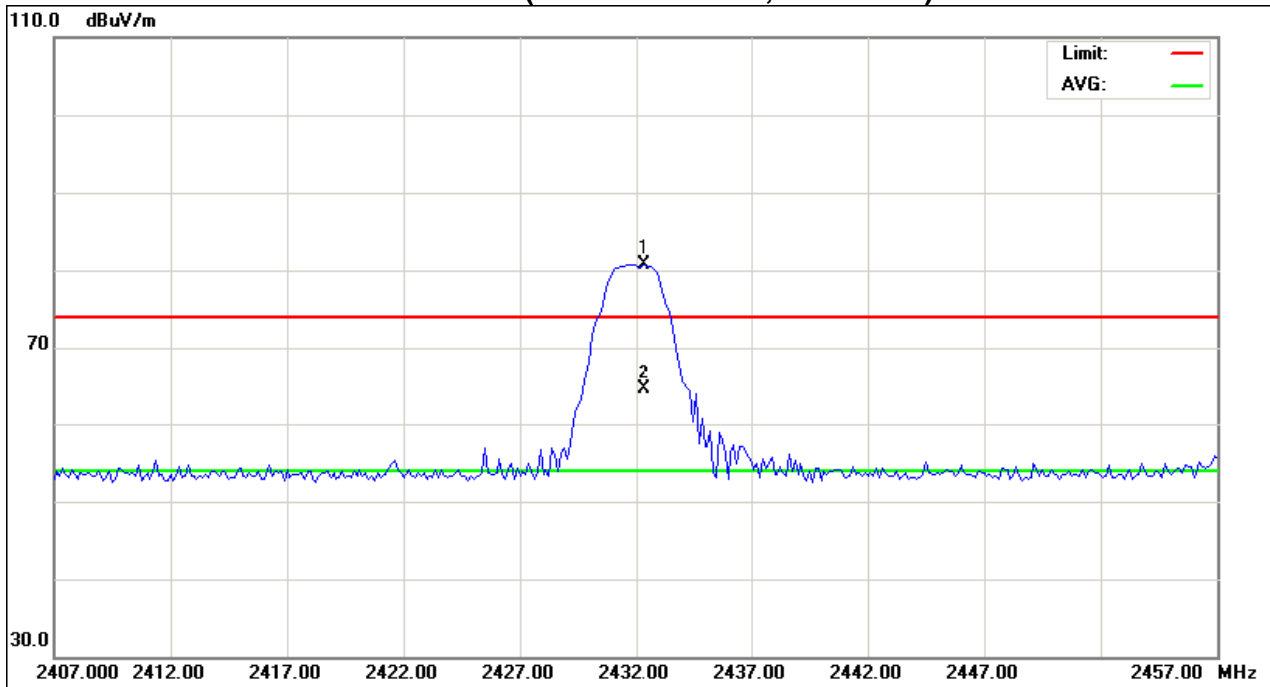



EUT :	Mini Receiver	Model Name. :	C55
Temperature :	20°C	Relative Humidity :	55 %
Pressure :	1001 hPa	Test Power :	AC 120V/60Hz
Test Mode :	TX 2472MHz		

Freq. (MHz)	Ant.Pol. H/V	Reading		Ant./CF CF(dB)	Act.		Limit		Note
		Peak (dBuV)	AV (dBuV)		Peak (dBuV/m)	AV (dBuV/m)	Peak (dBuV/m)	AV (dBuV/m)	
<b>2471.63</b>	<b>V</b>	<b>49.81</b>	<b>33.61</b>	<b>31.52</b>	<b>81.33</b>	<b>65.13</b>	<b>114.00</b>	<b>94.00</b>	<b>X/F</b>
2483.50	V	22.16	5.96	31.50	53.66	37.46	74.00	54.00	X/E
4964.55	V	39.72	23.52	6.91	46.63	30.43	74.00	54.00	X/H

Remark :

- (1) All readings are Peak unless otherwise stated QP in column of 『Note』 . Peak denotes that the Peak reading compliance with the QP Limits and then QP Mode measurement didn't perform ◦
- (2) Measuring frequency range from 30MHz to 1000MHz or the 10th harmonic of highest fundamental frequency ◦ "F" denotes fundamental frequency; "H" denotes spurious frequency. "E" denotes band edge frequency. (This judgment method includes the Band Edge Requirement.)
- (3) Radiated emissions measured in frequency range above 1000MHz were made with an instrument using Peak detector mode and AV detector mode of the emission ◦
- (4) Data of measurement within this frequency range shown " \* " in the table above means the reading of emissions are attenuated more than 20dB below the permissible limits or the field strength is too small to be measured.
- (5) A preamp and high pass filter were used for this test in order to provide sufficient measurement sensitivity.
- (6) EUT Orthogonal Axis :  
"X" - denotes Laid on Table ; "Y" - denotes Vertical Stand ; "Z" - denotes Side Stand
- (7) During the measurements above 1 GHz it is taken care of that the EUT is always within the 3 dB cone of radiation BW of the used antenna
- (8) The average value of fundamental frequency is:  
Average = Peak value + 20log(Duty cycle) ◦ Final AV=PK-16.20



Orthogonal Axis : X  
TX 2472MHz (Above 1000 MHz, Vertical)

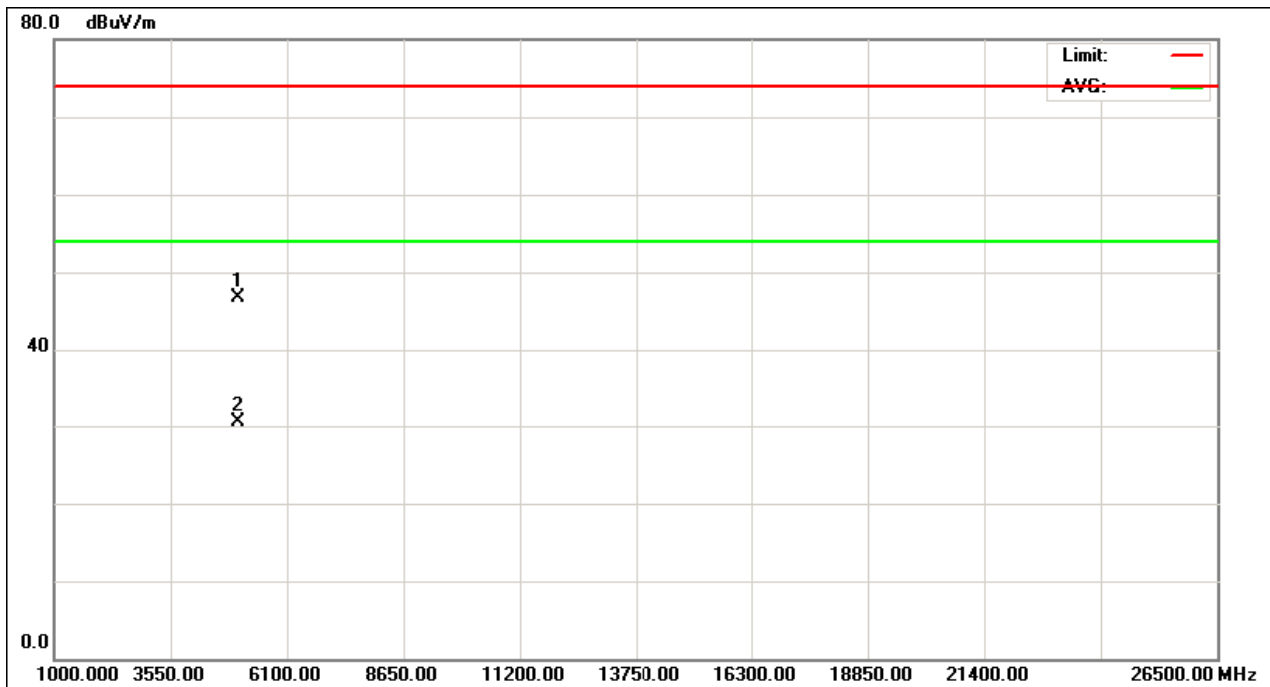
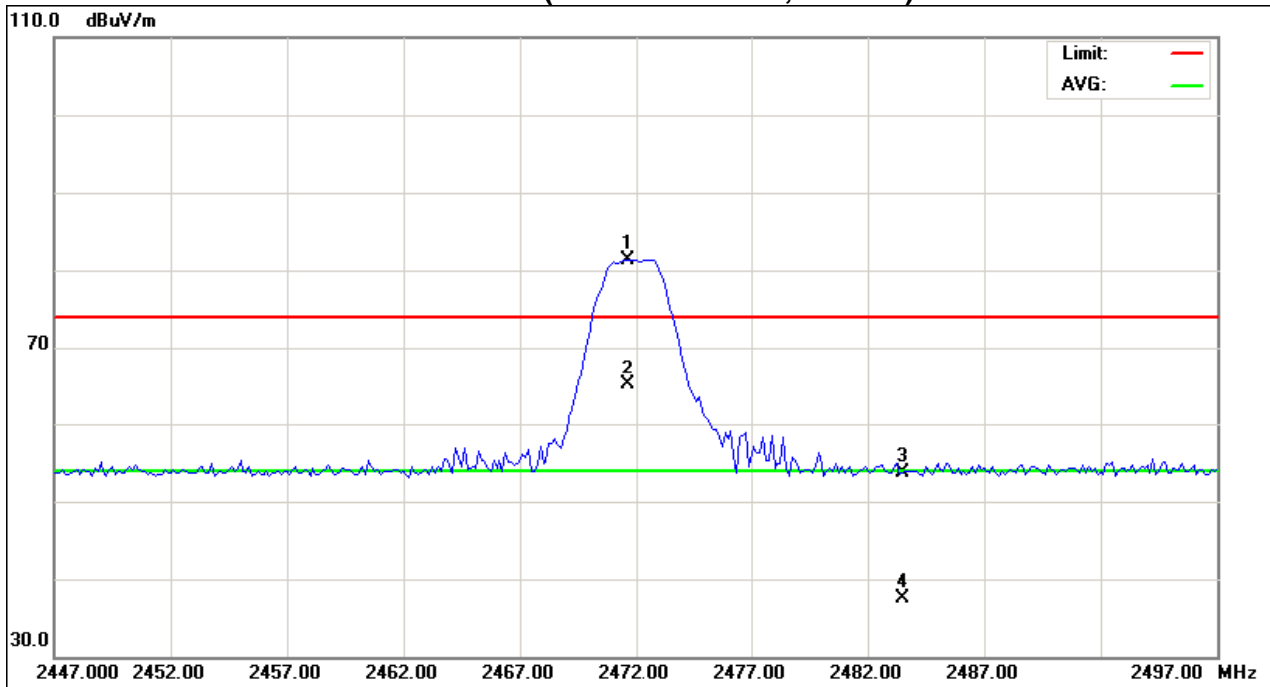



EUT :	Mini Receiver	Model Name. :	C55
Temperature :	20°C	Relative Humidity :	55 %
Pressure :	1001 hPa	Test Power :	AC 120V/60Hz
Test Mode :	TX 2472MHz		

Freq. (MHz)	Ant.Pol. H/V	Reading		Ant./CF CF(dB)	Act.		Limit		Note
		Peak (dBuV)	AV (dBuV)		Peak (dBuV/m)	AV (dBuV/m)	Peak (dBuV/m)	AV (dBuV/m)	
<b>2471.88</b>	<b>H</b>	<b>50.19</b>	<b>33.99</b>	<b>31.52</b>	<b>81.71</b>	<b>65.51</b>	<b>114.00</b>	<b>94.00</b>	<b>X/F</b>
2483.50	H	22.26	6.06	31.50	53.76	37.56	74.00	54.00	X/E
4964.65	H	40.49	24.29	6.91	47.40	31.20	74.00	54.00	X/H

Remark :

- (1) All readings are Peak unless otherwise stated QP in column of 『Note』 . Peak denotes that the Peak reading compliance with the QP Limits and then QP Mode measurement didn't perform ◦
- (2) Measuring frequency range from 30MHz to 1000MHz or the 10th harmonic of highest fundamental frequency ◦ "F" denotes fundamental frequency; "H" denotes spurious frequency. "E" denotes band edge frequency. (This judgment method includes the Band Edge Requirement.)
- (3) Radiated emissions measured in frequency range above 1000MHz were made with an instrument using Peak detector mode and AV detector mode of the emission ◦
- (4) Data of measurement within this frequency range shown " \* " in the table above means the reading of emissions are attenuated more than 20dB below the permissible limits or the field strength is too small to be measured.
- (5) A preamp and high pass filter were used for this test in order to provide sufficient measurement sensitivity.
- (6) EUT Orthogonal Axis :  
"X" - denotes Laid on Table ; "Y" - denotes Vertical Stand ; "Z" - denotes Side Stand
- (7) During the measurements above 1 GHz it is taken care of that the EUT is always within the 3 dB cone of radiation BW of the used antenna
- (8) The average value of fundamental frequency is:  
Average = Peak value + 20log(Duty cycle) ◦ Final AV=PK-16.20



Orthogonal Axis : X  
TX 2472MHz (Above 1000 MHz, Horizontal)

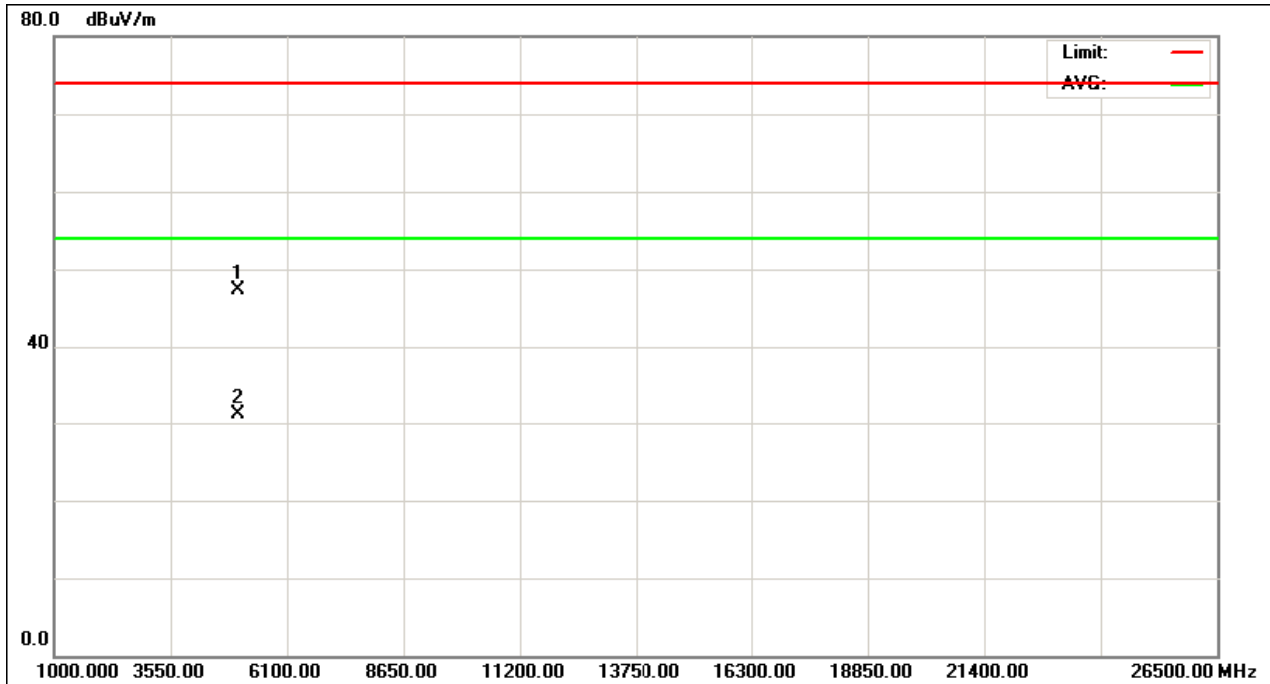
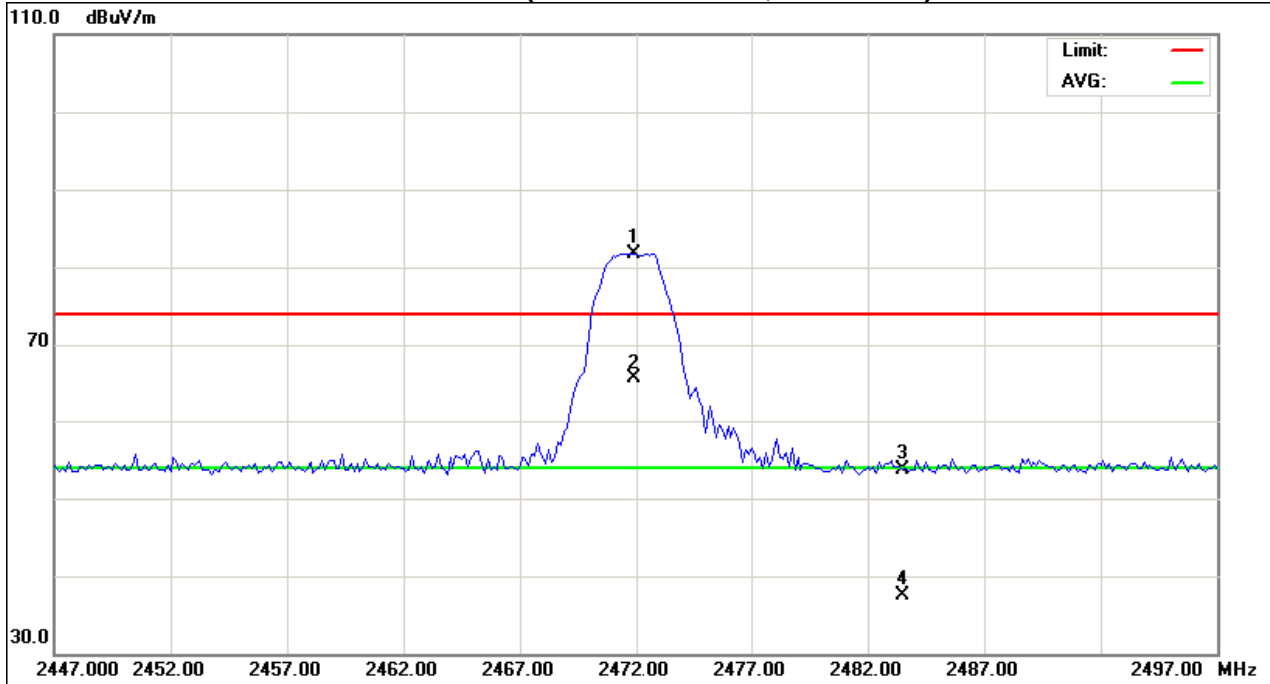



4.2.10 TEST RESULTS (2400 – 2483.5 MHz)

EUT :	Mini Receiver	Model Name. :	C55
Temperature :	20°C	Relative Humidity :	55 %
Pressure :	1001 hPa	Test Power :	AC 120V/60Hz
Test Mode :	TX CH 2402MHz/2432MHz/2472MHz		

Freq. (MHz)	Ant.Pol. (H/V)	Reading		Ant./CL/ CF(dB)	Actual FS		Limit3m		NOTE
		Peak (dBuV)	AV (dBuV)		Peak (dBuV/m)	AV (dBuV/m)	Peak (dBuV/m)	AV (dBuV/m)	
2402.50	V	49.09	32.89	31.60	80.69	64.49	114.00	94.00	CH01
2402.38	H	49.25	33.05	31.60	80.85	64.65	114.00	94.00	CH01
2431.50	V	48.88	32.68	31.57	80.45	64.25	114.00	94.00	CH06
2432.38	H	49.11	32.91	31.57	80.68	64.48	114.00	94.00	CH06
2471.63	V	49.81	33.61	31.52	81.33	65.13	114.00	94.00	CH16
2471.88	H	50.19	33.99	31.52	81.71	65.51	114.00	94.00	CH16

Remark :

- (1) All readings are Peak unless otherwise stated QP in column of 『Note』 . Peak denotes that the Peak reading compliance with the QP Limits and then QP Mode measurement didn't perform ◦
- (2) Radiated emissions measured in frequency range above 1000MHz were made with an instrument using Peak detector mode and AV detector mode of the emission ◦
- (3) Data of measurement within this frequency range shown “ \* ” in the table above means the reading of emissions are attenuated more than 20dB below the permissible limits or the field strength is too small to be measured.
- (4) EUT Orthogonal Axis :  
 “X” - denotes Laid on Table ; “Y” - denotes Vertical Stand ; “Z” - denotes Side Stand



## 5. BANDWIDTH TEST

### 5.1 MEASUREMENT INSTRUMENTS LIST

Item	Kind of Equipment	Manufacturer	Type No.	Serial No.	Calibrated until
1	Spectrum Analyzer	R&S	FSP 40	100185	Nov.26.2011

Remark: " N/A" denotes No Model Name. , Serial No. or No Calibration specified.

### 5.2 TEST PROCEDURE

- a. The EUT was directly connected to the spectrum analyzer and antenna output port as show in the block diagram below,
- b. Spectrum Setting : RBW= 100KHz, VBW=100KHz, Sweep time = 2.5 ms.

### 5.3 DEVIATION FROM STANDARD

No deviation.

### 5.4 TEST SETUP



### 5.5 EUT OPERATION CONDITIONS

The EUT tested system was configured as the statements of 4.1.6 Unless otherwise a special operating condition is specified in the follows during the testing.





**5.6 TEST RESULTS**

EUT :	Mini Receiver	Model Name. :	C55
Temperature :	20°C	Relative Humidity :	55 %
Pressure :	1001 hPa	Test Power :	AC 120V/60Hz
Test Mode :	TX CH 01/09/16		

Test Channel	Frequency (MHz)	20 dBc Bandwidth (MHz)	99% occupied Bandwidth(MHz)
CH01	2402	2.635	2.355
CH06	2432	2.500	2.260
CH16	2472	2.640	2.340

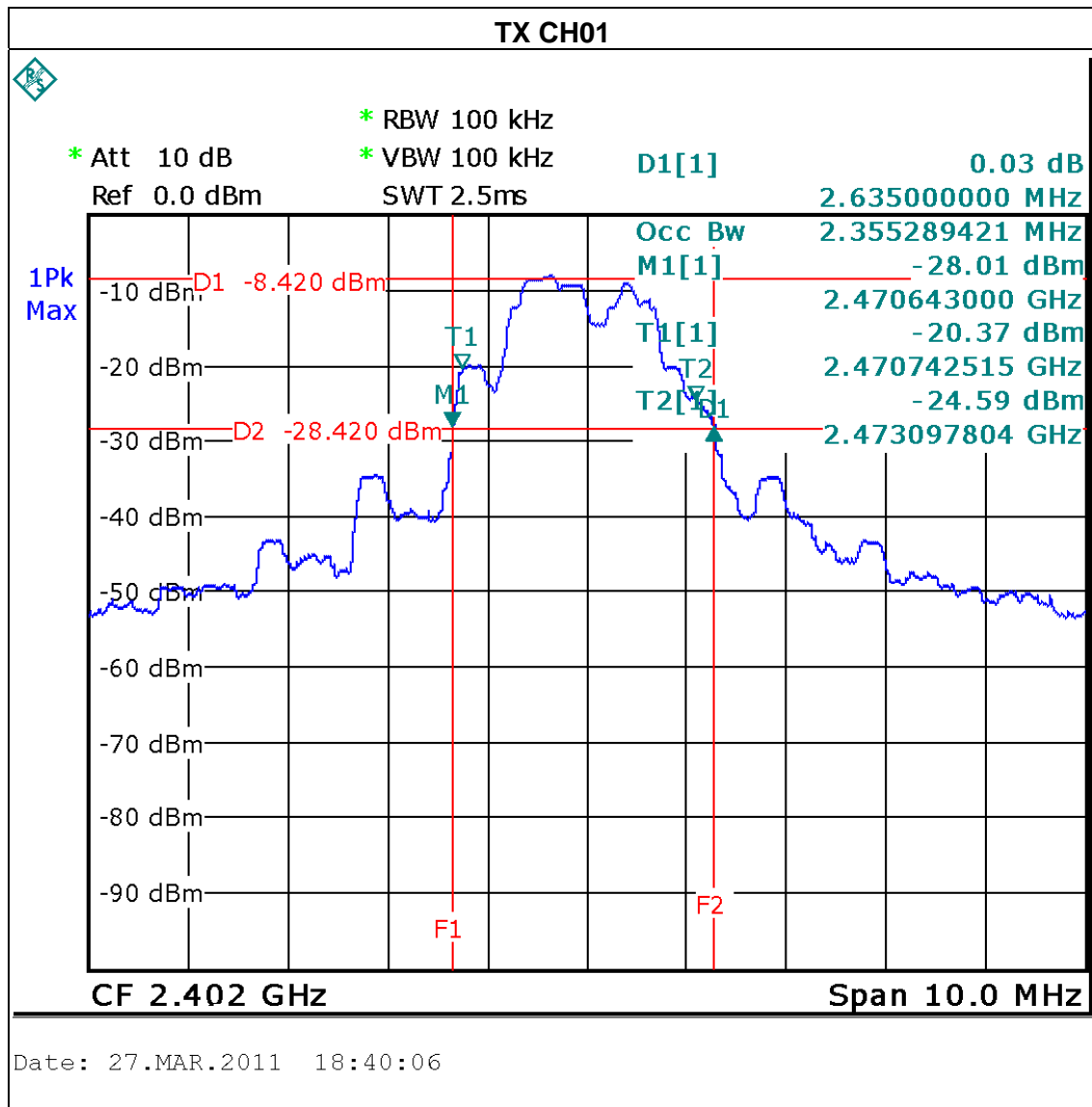

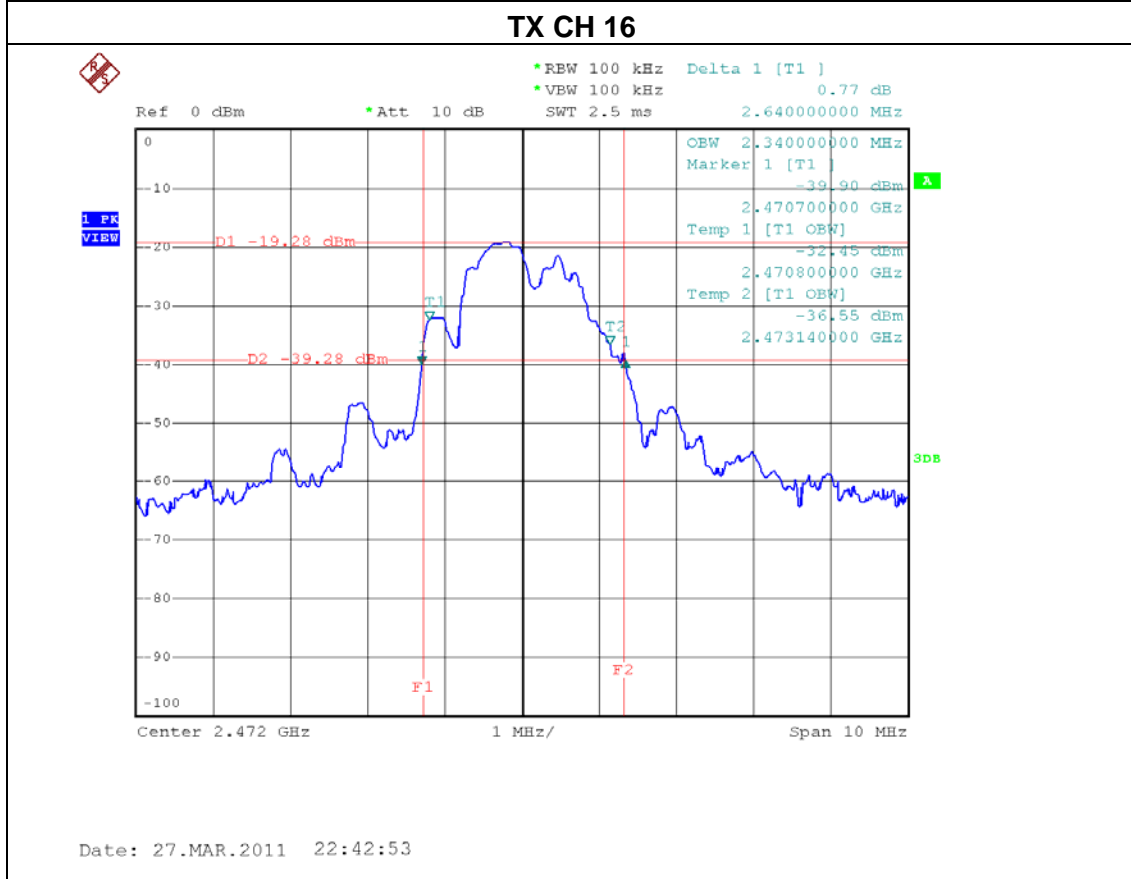
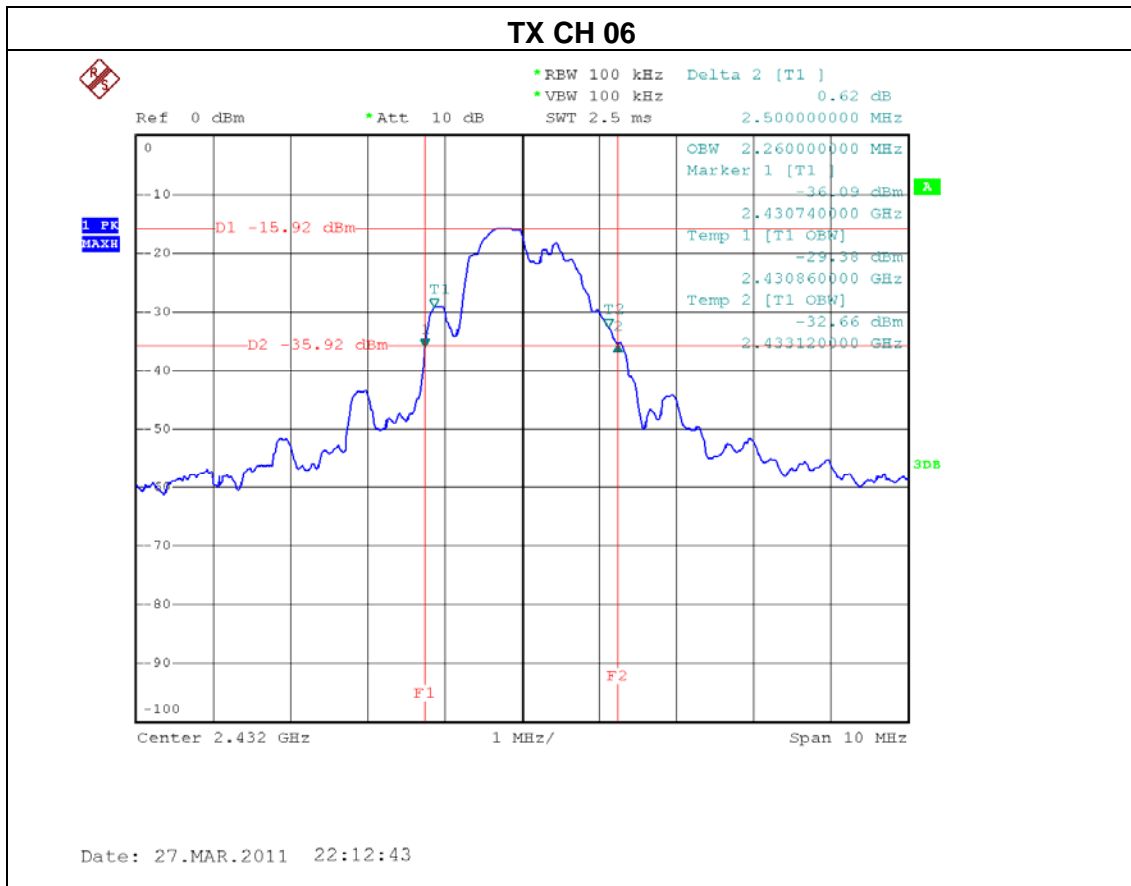



## 6. ANTENNA CONDUCTED SPURIOUS EMISSION

### 6.1 APPLIED PROCEDURES / LIMIT

20dBc in any 100 kHz bandwidth outside the operating frequency band. In case the emission fall within the restricted band specified on 15.205(a), then the 15.209(a) limit in the table below has to be followed.

Frequencies (MHz)	Field Strength (micorvolts/meter)	Measurement Distance (meters)
0.009~0.490	2400/F(KHz)	300
0.490~1.705	24000/F(KHz)	30
1.705~30.0	30	30
30~88	100	3
88~216	150	3
216~960	200	3
Above 960	500	3

#### 6.1.1 MEASUREMENT INSTRUMENTS LIST

Item	Kind of Equipment	Manufacturer	Type No.	Serial No.	Calibrated until
1	Spectrum Analyzer	R&S	FSP 40	100185	Nov.26.2011

Remark: " N/A" denotes No Model Name. , Serial No. or No Calibration specified.

#### 6.1.2 TEST PROCEDURE

- a. The EUT was directly connected to the spectrum analyzer and antenna output port as show in the block diagram below,
- b. Spectrum Setting : RBW= 100KHz, VBW=100KHz, Sweep time = 200 ms.

#### 6.1.3 DEVIATION FROM STANDARD

No deviation.

#### 6.1.4 TEST SETUP

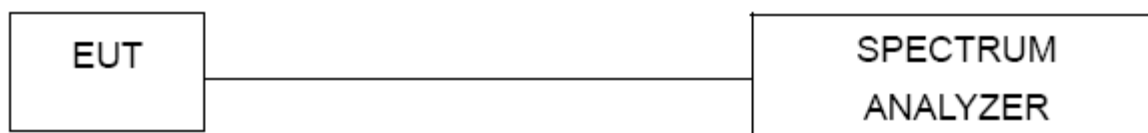

#### 6.1.5 EUT OPERATION CONDITIONS

The EUT tested system was configured as the statements of 4.1.6 Unless otherwise a special operating condition is specified in the follows during the testing.



6.1.6 TEST RESULTS

EUT :	Mini Receiver	Model Name. :	C55
Temperature :	20°C	Relative Humidity :	55 %
Pressure :	1001 hPa	Test Power :	AC 120V/60Hz
Test Mode :	TX CH01, CH06, CH16		

Channel of Worst Data: CH01			
The max. radio frequency power in any 100kHz bandwidth outside the frequency band		The max. radio frequency power in any 100 kHz bandwidth within the frequency band.	
FREQUENCY(MHz)	POWER(dBm)	FREQUENCY(MHz)	POWER(dBm)
2390.00	-63.93	2484.00	-73.32
Result			
In any 100kHz bandwidth outside the frequency band, the radio frequency power is at least 50dB below that in the 100kHz bandwidth within the band that contains the highest level of the desired power.			

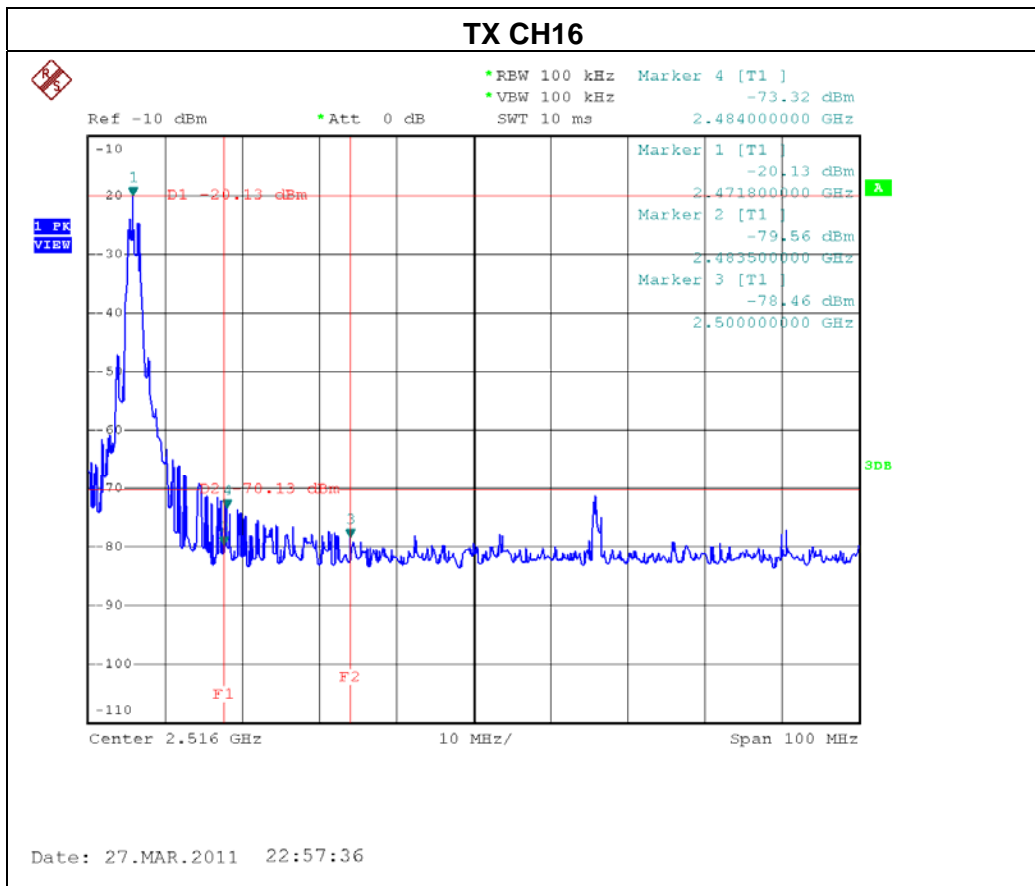
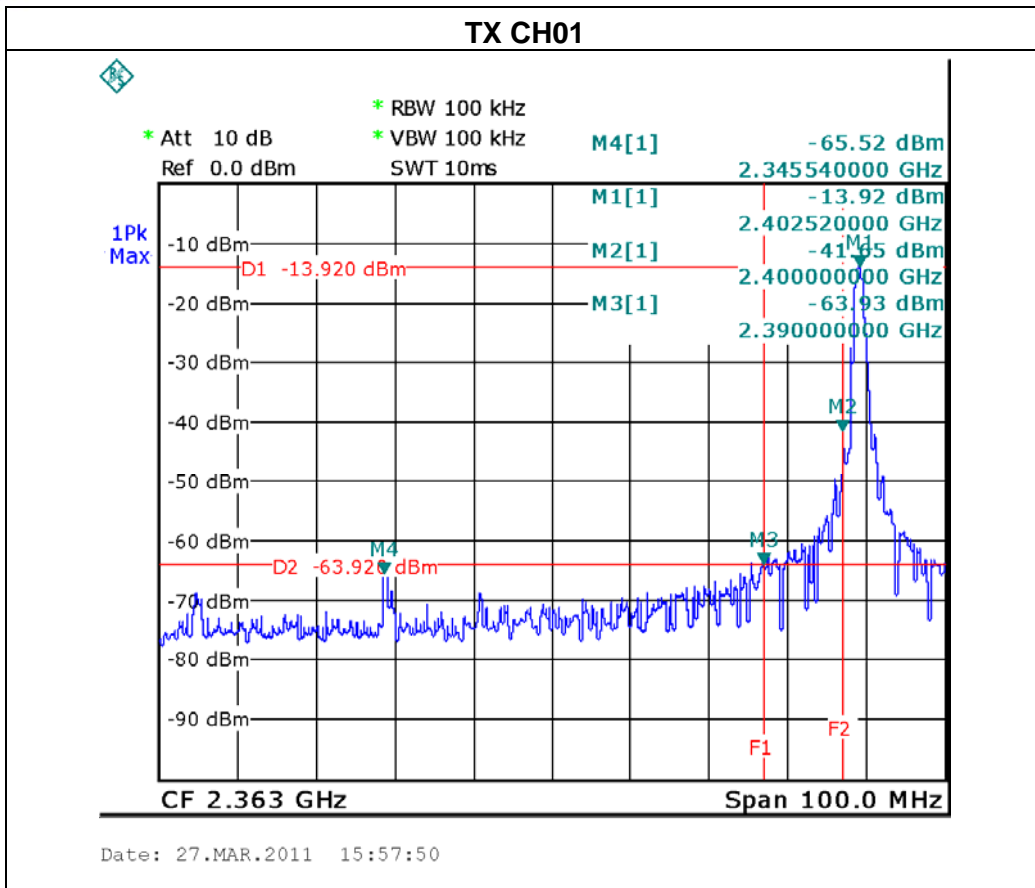

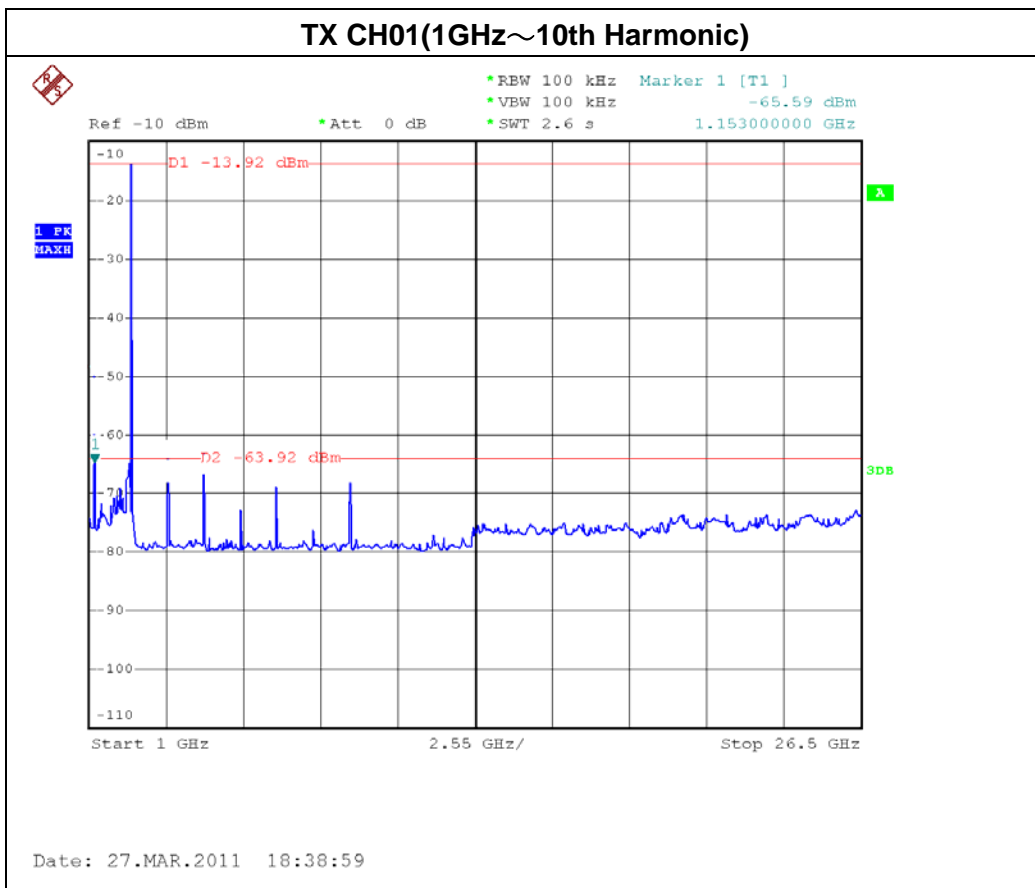
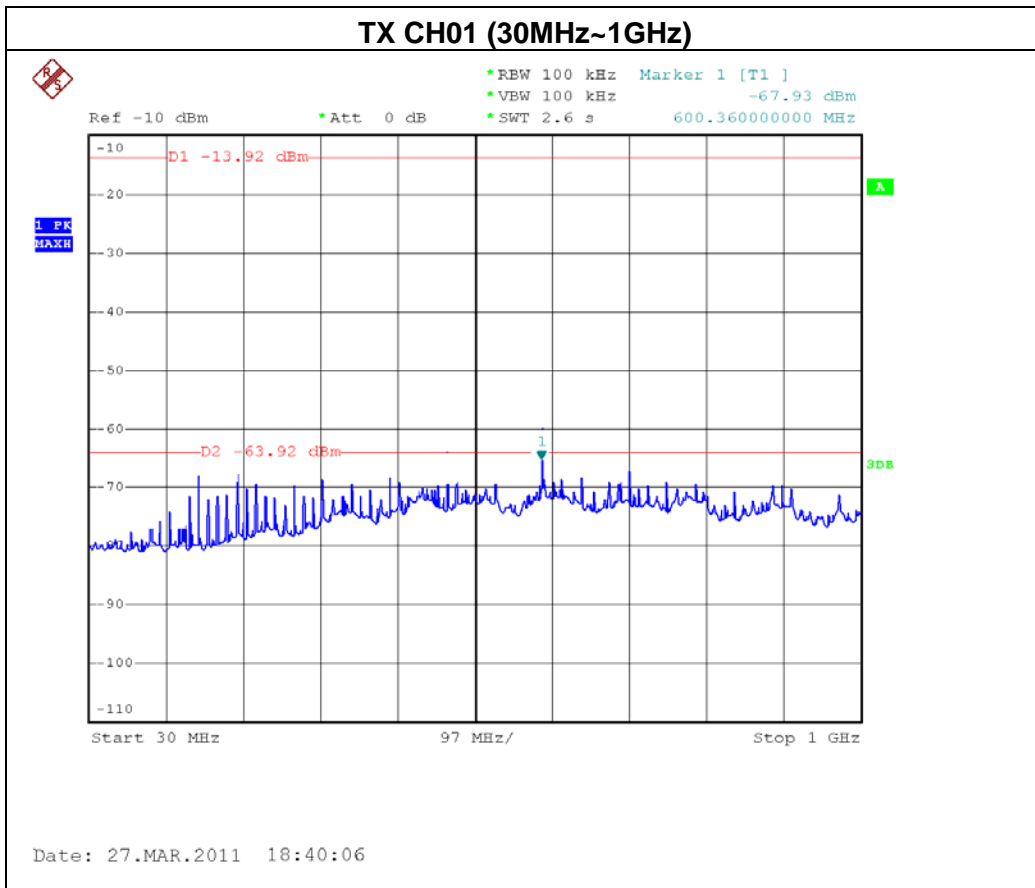

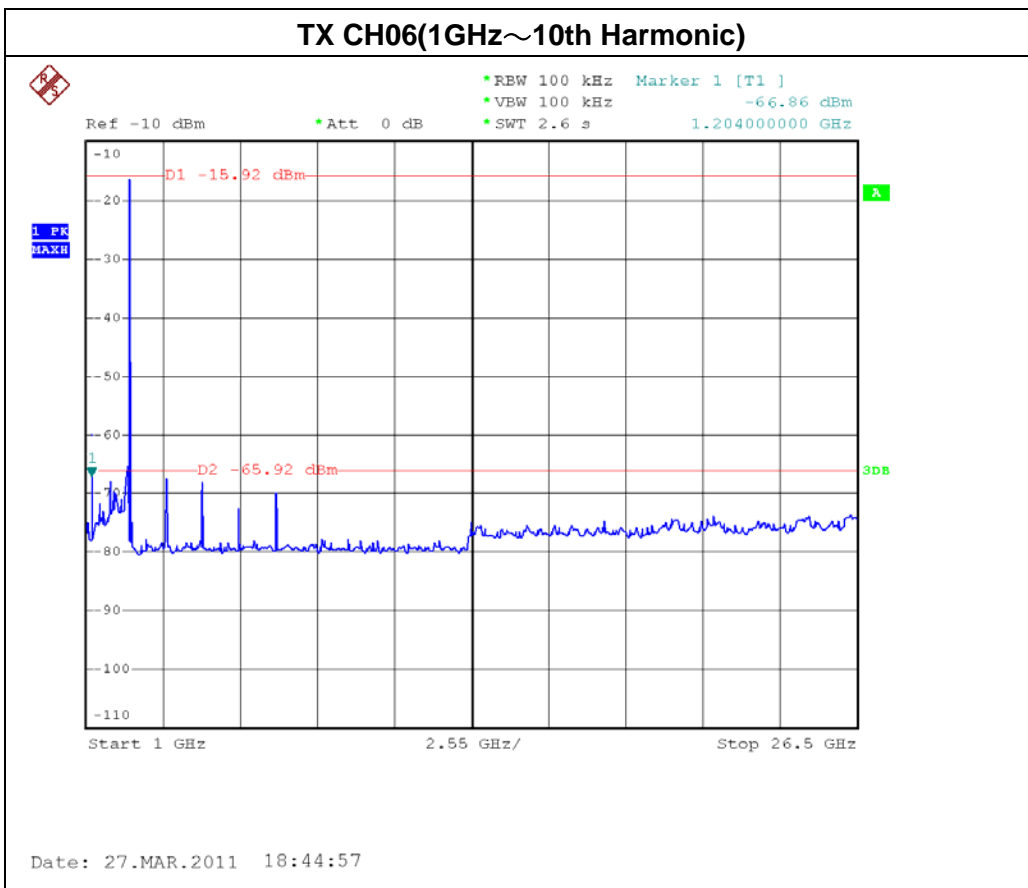
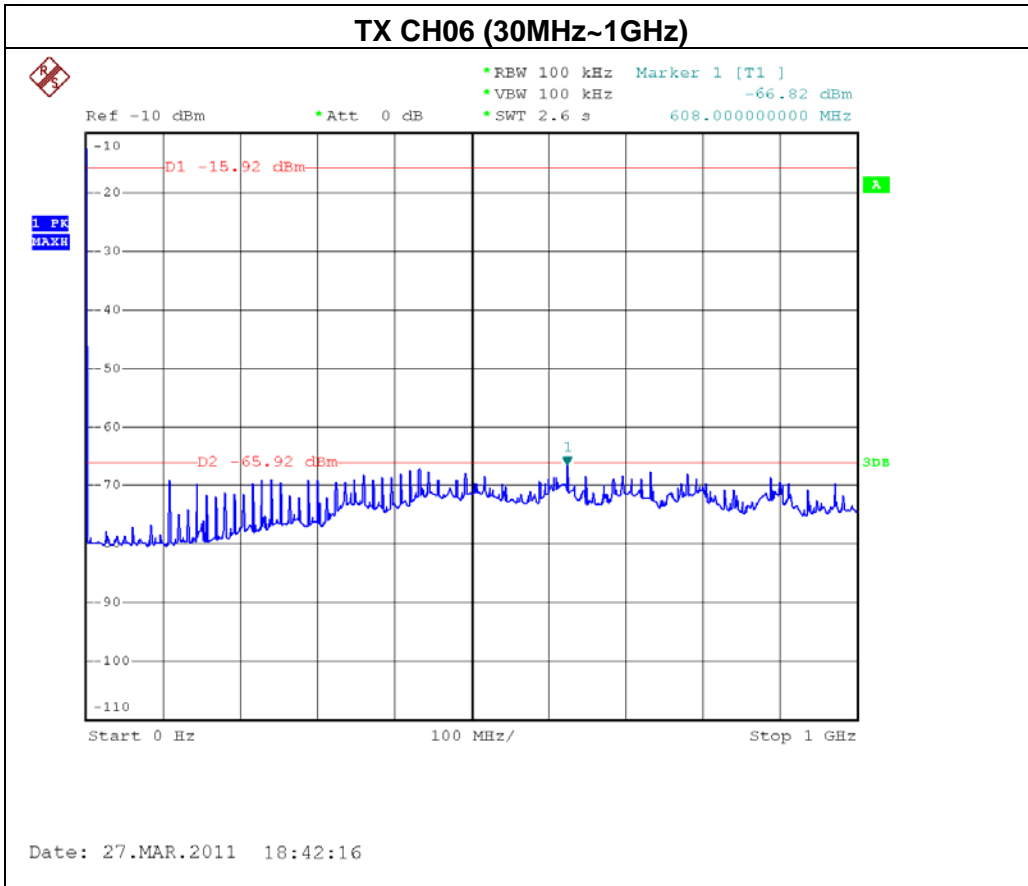

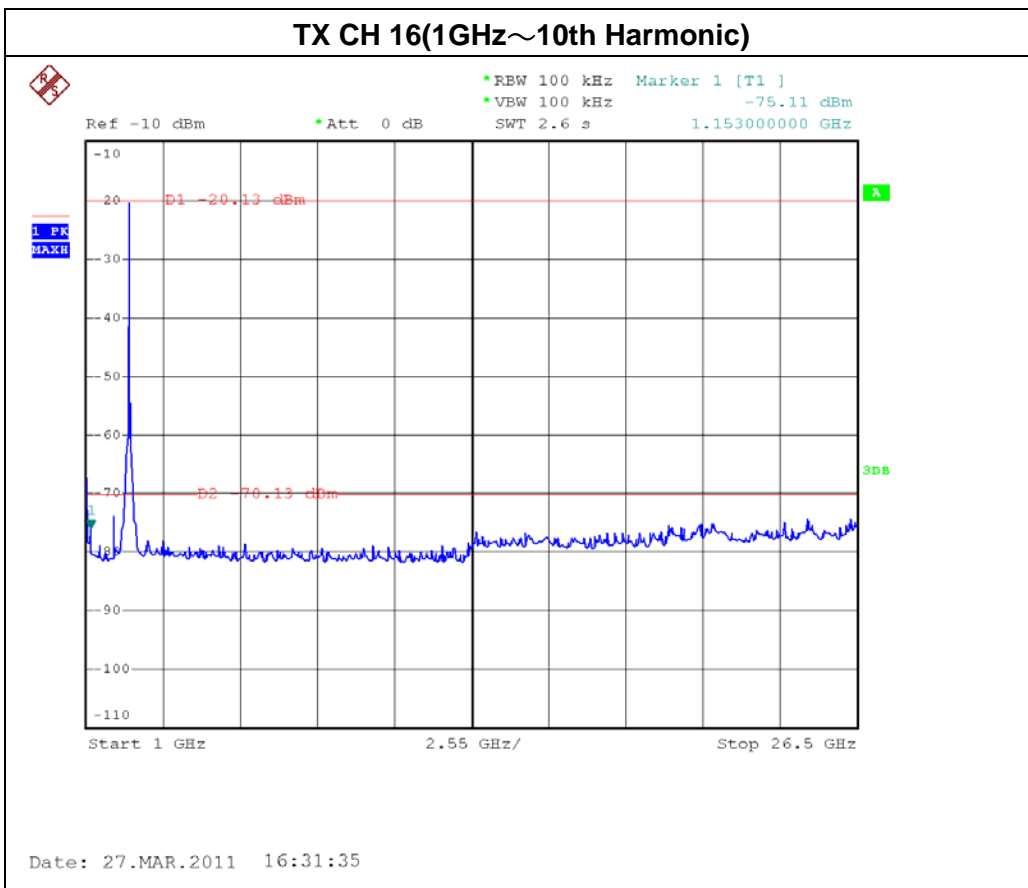
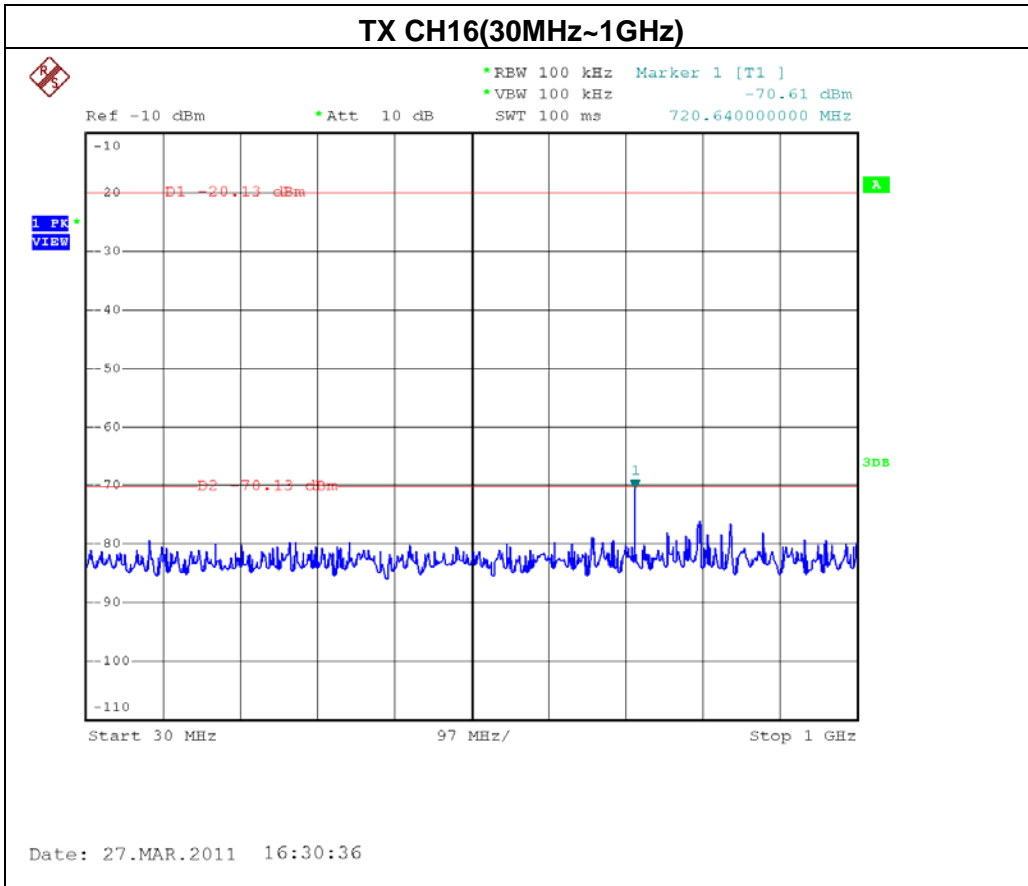





**7. EUT TEST PHOTO**

**Conducted Measurement Photos**

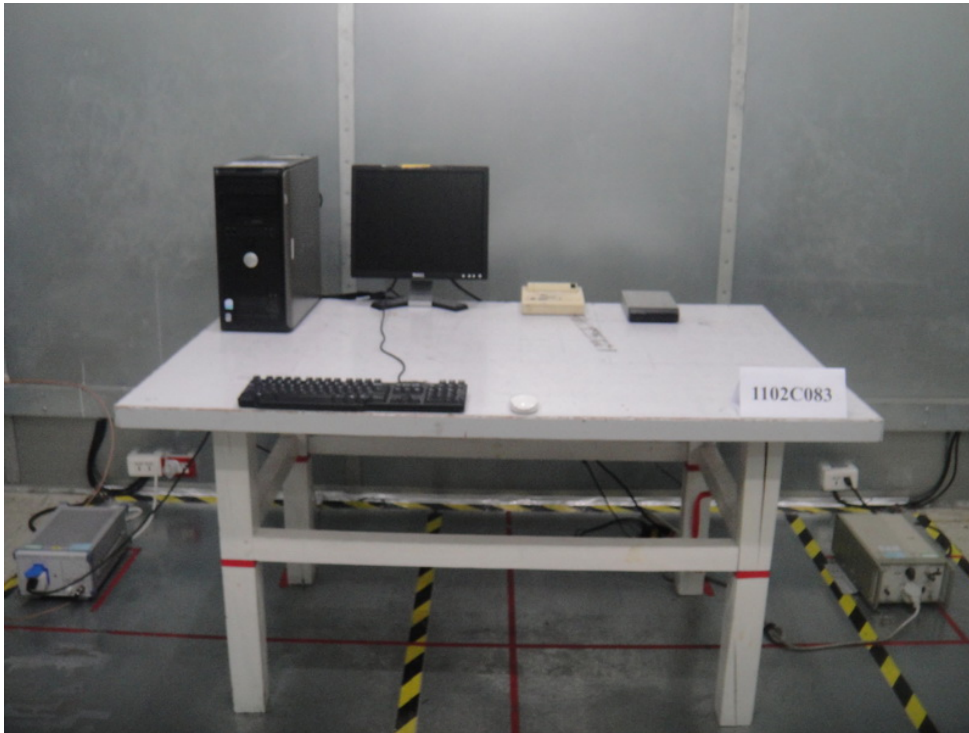

**Radiated Measurement Photos  
9K~30MHz**

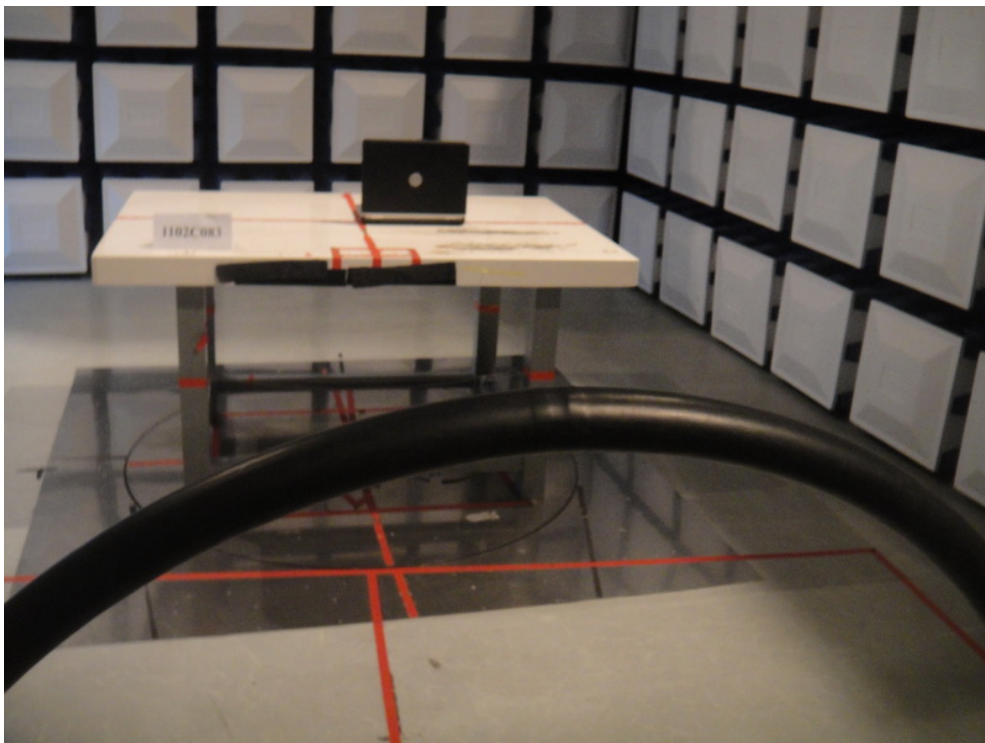
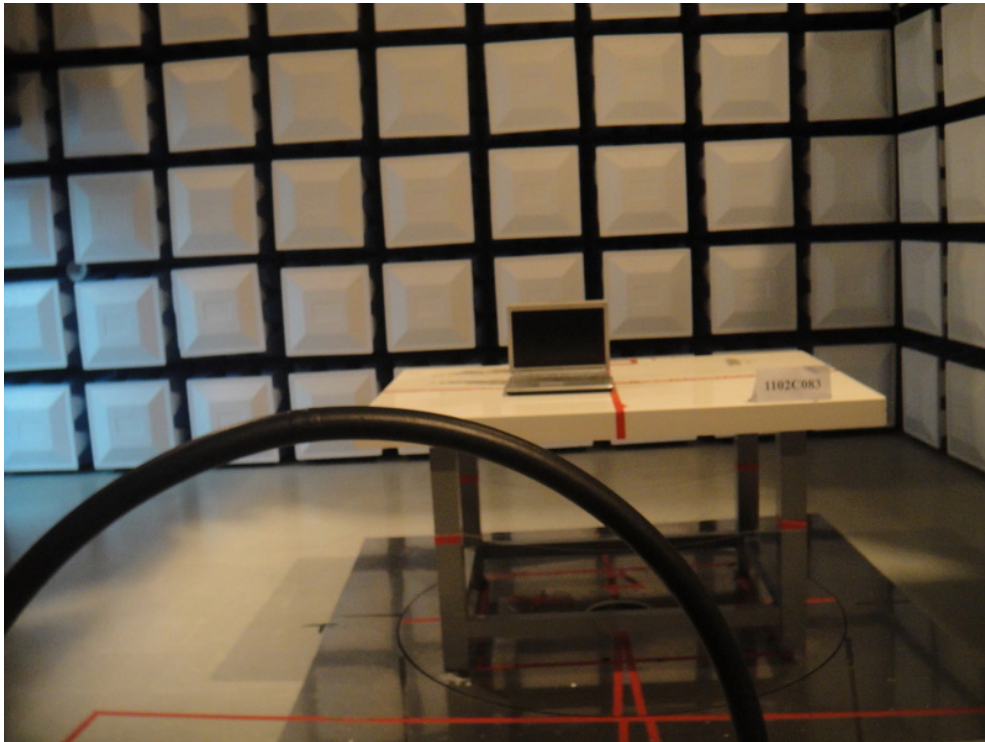



**Radiated Measurement Photos  
30M~1000MHz**

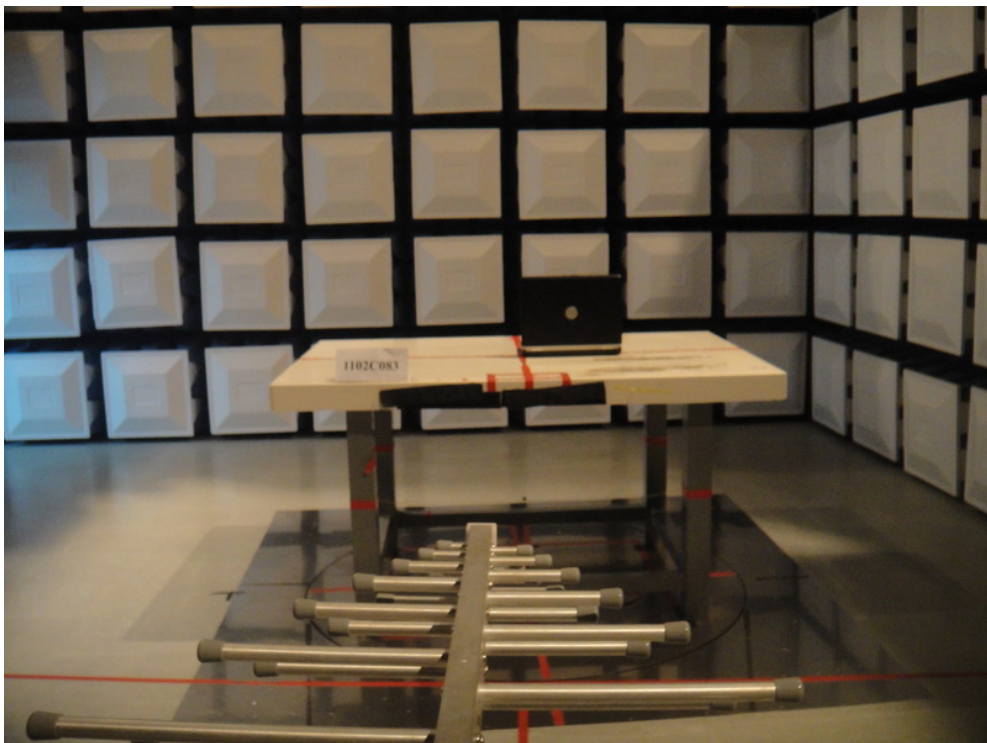
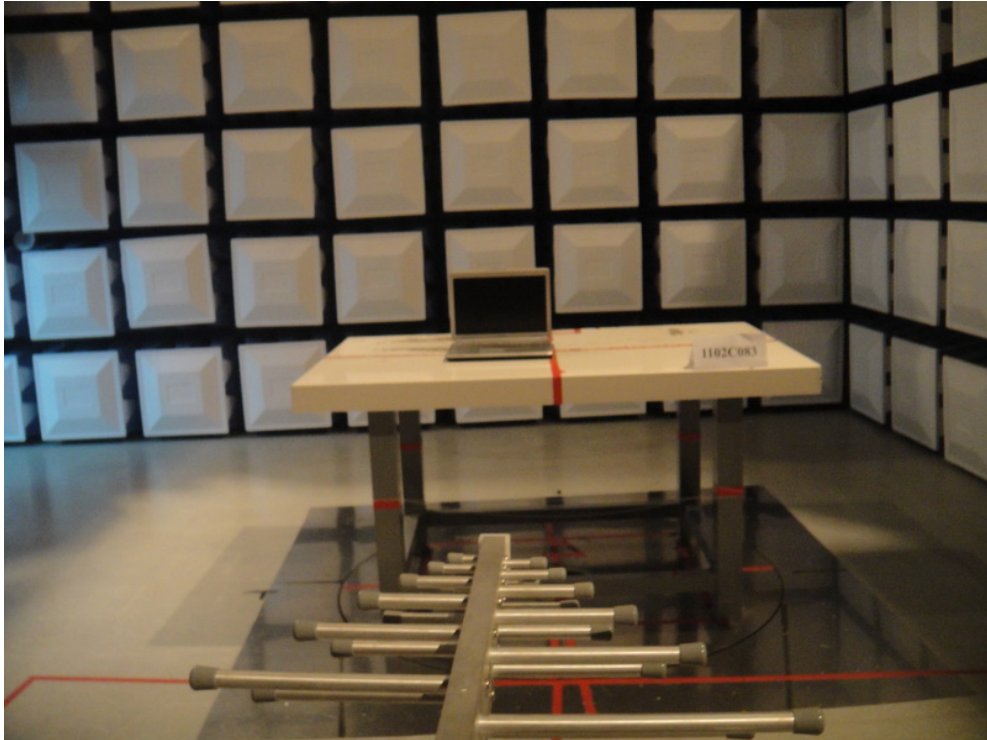



**Radiated Measurement Photos  
Above 1000MHz**

