



Neutron Engineering Inc.

FCC Radio TEST Report

FCC ID: P5A-CL0015

This report concerns (check one) : Original Grant Class II Change

Issued Date : Jul. 29, 2009
Project No. : 0907C131
Equipment : Wireless Laser Mouse
Model Name : L213 3D3+1B; L213 3D5+1B
Applicant : Areson Technology Corporation
Address : 11F, NO.646, SEC.5, CHONGSIN RD., SAN
CHONG 241, TAIPEI COUNTY, TAIWAN (R.O.C.)

Tested by:

Neutron Engineering Inc. EMC Laboratory

Date of Test:

Jul. 22, 2009 ~ Jul. 28, 2009

Testing Engineer :

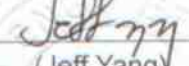
(Jeff Yang)

Technical Manager :

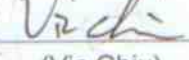
(Vic Chiu)

Authorized Signatory :

(Steven Lu)

NEUTRON ENGINEERING INC.

No. 132-1, Lane 329, Sec. 2, Palain Rd.,
Shijr City, Taipei, Taiwan
TEL : (02) 2646-5426 FAX : (02) 2646-6815





Declaration

Neutron represents to the client that testing is done in accordance with standard procedures as applicable and that test instruments used has been calibrated with the standards traceable to National Measurement Laboratory (**NML**) of **R.O.C.**, or National Institute of Standards and Technology (**NIST**) of **U.S.A.**

Neutron's reports apply only to the specific samples tested under conditions. It is manufacture's responsibility to ensure that additional production units of this model are manufactured with the identical electrical and mechanical components. **Neutron** shall have no liability for any declarations, inferences or generalizations drawn by the client or others from **Neutron** issued reports.

Neutron's reports must not be used by the client to claim product endorsement by the authorities or any agency of the Government.

This report is the confidential property of the client. As a mutual protection to the clients, the public and **Neutron-self**, extracts from the test report shall not be reproduced except in full with **Neutron's** authorized written approval.

Neutron's laboratory quality assurance procedures are in compliance with the **ISO Guide 17025** requirements, and accredited by the conformity assessment authorities listed in this test report.

Limitation

For the use of the authority's logo is limited unless the Test Standard(s)/Scope(s)/Item(s) mentioned in this test report is (are) included in the conformity assessment authorities acceptance respective.



| Table of Contents | Page |
|---|-------------|
| 1 . CERTIFICATION | 5 |
| 2 . SUMMARY OF TEST RESULTS | 6 |
| 2.1 TEST FACILITY | 7 |
| 2.2 MEASUREMENT UNCERTAINTY | 7 |
| 3 . GENERAL INFORMATION | 8 |
| 3.1 GENERAL DESCRIPTION OF EUT | 8 |
| 3.2 DESCRIPTION OF TEST MODES | 10 |
| 3.3 BLOCK DIGRAM SHOWING THE CONFIGURATION OF SYSTEM TESTED | 11 |
| 3.4 DESCRIPTION OF SUPPORT UNITS | 12 |
| 4 . EMC EMISSION TEST | 13 |
| 4.1 CONDUCTED EMISSION MEASUREMENT | 13 |
| 4.1.1 POWER LINE CONDUCTED EMISSION LIMITS | 13 |
| 4.1.2 MEASUREMENT INSTRUMENTS LIST | 13 |
| 4.1.3 TEST PROCEDURE | 14 |
| 4.1.4 DEVIATION FROM TEST STANDARD | 14 |
| 4.1.5 TEST SETUP | 14 |
| 4.1.6 EUT OPERATING CONDITIONS | 14 |
| 4.1.7 TEST RESULTS | 15 |
| 4.2 RADIATED EMISSION MEASUREMENT | 16 |
| 4.2.1 RADIATED EMISSION LIMITS | 16 |
| 4.2.2 MEASUREMENT INSTRUMENTS LIST | 17 |
| 4.2.3 TEST PROCEDURE | 18 |
| 4.2.4 DEVIATION FROM TEST STANDARD | 18 |
| 4.2.5 TEST SETUP | 19 |
| 4.2.6 EUT OPERATING CONDITIONS | 19 |
| 4.2.7 TEST RESULTS (BETWEEN 30 – 1000 MHz) | 20 |
| 4.2.8 TEST RESULTS (ABOVE 1000 MHz) | 22 |
| 4.2.9 TEST RESULTS (2400 – 2483.5 MHz) | 34 |
| 4.2.10 TEST RESULTS (Restricted Bands Requirements) | 35 |
| 5 . BANDWIDTH TEST | 39 |
| 5.1 MEASUREMENT INSTRUMENTS LIST | 39 |
| 5.2 TEST PROCEDURE | 39 |
| 5.3 DEVIATION FROM STANDARD | 39 |
| 5.4 TEST SETUP | 39 |
| 5.5 EUT OPERATION CONDITIONS | 39 |
| 5.6 TEST RESULTS | 40 |



| Table of Contents | Page |
|---|-------------|
| 6 . ANTENNA CONDUCTED SPURIOUS EMISSION | 42 |
| 6.1 APPLIED PROCEDURES / LIMIT | 42 |
| 6.1.1 MEASUREMENT INSTRUMENTS LIST | 42 |
| 6.1.2 TEST PROCEDURE | 42 |
| 6.1.3 DEVIATION FROM STANDARD | 42 |
| 6.1.4 TEST SETUP | 42 |
| 6.1.5 EUT OPERATION CONDITIONS | 43 |
| 6.1.6 TEST RESULTS | 44 |
| 7 . EUT TEST PHOTO | 46 |



1. CERTIFICATION

Equipment: Wireless Laser Mouse

Trade Name : N/A

Model Name. : L213 3D3+1B; L213 3D5+1B

Applicant: Areson Technology Corporation

Date of Test: Jul. 22, 2009 ~ Jul. 28, 2009

Test Item: ENGINEERING SAMPLE

Standards: FCC Part15, Subpart C(15.249)/ ANSI C63.4 : 2003

The above equipment has been tested and found compliance with the requirement of the relative standards by Neutron Engineering Inc. EMC Laboratory.

The test data, data evaluation, and equipment configuration contained in our test report (Ref No. NEI-FCCP-1-0907C131) were obtained utilizing the test procedures, test instruments, test sites that has been accredited by the Authority of NVLAP and TAF according to the ISO-17025 quality assessment standard and technical standard(s).



2. SUMMARY OF TEST RESULTS

Test procedures according to the technical standards:

| FCC Part15, Subpart C (15.249) | | | |
|--------------------------------|----------------------------|----------|--------|
| Standard Section | Test Item | Judgment | Remark |
| 15.207 | Conducted Emission | - | N/A |
| 15.249 | Radiated Spurious Emission | PASS | |

NOTE:

(1) "N/A" denotes test is not applicable in this Test Report



2.1 TEST FACILITY

The test facilities used to collect the test data in this report is **C01/OS02** at the location of No.132-1, Lane 329, Sec. 2, Palian Road, Shijr City, Taipei, Taiwan.

Neutron's test firm number is 95335

2.2 MEASUREMENT UNCERTAINTY

The reported uncertainty of measurement $y \pm U$, where expanded uncertainty **U** is based on a standard uncertainty multiplied by a coverage factor of **k=2**, providing a level of confidence of approximately **95 %**.

A. Conducted Measurement :

| Test Site | Method | Measurement Frequency Range | U , (dB) | NOTE |
|-----------|--------|-----------------------------|----------|------|
| C01 | ANSI | 150 KHz ~ 30MHz | 1.94 | |

B. Radiated Measurement :

| Test Site | Method | Measurement Frequency Range | Ant. H / V | U , (dB) | NOTE |
|-----------|--------|-----------------------------|------------|----------|------|
| OS-01 | ANSI | 30MHz ~ 200MHz | V | 3.82 | |
| | | 30MHz ~ 200MHz | H | 3.60 | |
| | | 200MHz ~ 1,000MHz | V | 3.86 | |
| | | 200MHz ~ 1,000MHz | H | 3.94 | |
| OS-02 | ANSI | 30MHz ~ 200MHz | V | 2.48 | |
| | | 30MHz ~ 200MHz | H | 2.16 | |
| | | 200MHz ~ 1,000MHz | V | 2.50 | |
| | | 200MHz ~ 1,000MHz | H | 2.66 | |



3. GENERAL INFORMATION

3.1 GENERAL DESCRIPTION OF EUT

| | | |
|------------------------|--|--------------------------------|
| Equipment | Wireless Laser Mouse | |
| Trade Name | N/A | |
| Model Name. | L213 3D3+1B; L213 3D5+1B | |
| OEM Brand/Model Name | N/A | |
| Model Difference | Only different is L213 3D5+1B Vice-board increase of two keys, the Main Board of the same. | |
| Product Description | The EUT is a Wireless Laser Mouse. | |
| | Product Type | Low Power Communication Device |
| | Operation Frequency: | 2402~2479 MHz |
| | Modulation Type: | GFSK |
| | Number Of Channel | 16CH |
| | Antenna Designation: | Printed antenna |
| | Antenna Gain(Peak) | 1.41 dBi (Mouse) |
| | Output Power: | 91.42 dBuV/m (AV Max.) |
| | Based on the application, features, or specification exhibited in User's Manual, the EUT is considered as an ITE/Computing Device. More details of EUT technical specification, please refer to the User's Manual. | |
| Channel List | Please refer to the Note 2. | |
| Power Source | DC Voltage supplied from 2*AAA size Battery | |
| Power Rating | DC 3.0V | |
| Connecting I/O Port(s) | Please refer to the User's Manual | |

Note:

1. For a more detailed features description, please refer to the manufacturer's specifications or the User's Manual.



2.

| Frequency Band | Channel No. | Frequency |
|----------------|-------------|-----------|
| 2400~2483.5MHz | 1 | 2402 MHz |
| | 2 | 2405 MHz |
| | 3 | 2408 MHz |
| | 4 | 2411 MHz |
| | 5 | 2425 MHz |
| | 6 | 2432 MHz |
| | 7 | 2435 MHz |
| | 8 | 2439 MHz |
| | 9 | 2447 MHz |
| | 10 | 2450 MHz |
| | 11 | 2462 MHz |
| | 12 | 2465 MHz |
| | 13 | 2468 MHz |
| | 14 | 2471 MHz |
| | 15 | 2476 MHz |
| | 16 | 2479 MHz |

3. Table for Filed Antenna

| Ant. | Brand | Model Name | Antenna Type | Connector | Gain (dBi) |
|------|-------|------------|-----------------|-----------|------------|
| 1 | N/A | N/A | Printed Antenna | N/A | 1.41 |



3.2 DESCRIPTION OF TEST MODES

To investigate the maximum EMI emission characteristics generated from EUT, the test system was pre-scanning tested based on the consideration of following EUT operation mode or test configuration mode which possible have effect on EMI emission level. Each of these EUT operation mode(s) or test configuration mode(s) mentioned above was evaluated respectively.

| Pretest Mode | Description |
|--------------|---------------------|
| Mode 1 | CH Lower - 2402MHz |
| Mode 2 | CH Middle - 2439MHz |
| Mode 3 | CH Highest -2479MHz |

| For Conducted Test | |
|---------------------------|---|
| Final Test Mode | Description |
| | " N/A" denotes test is not applicable in this Test Report |

| For Radiated Test | |
|--------------------------|---------------------|
| Final Test Mode | Description |
| Mode 1 | CH Lower - 2402MHz |
| Mode 2 | CH Middle - 2439MHz |
| Mode 3 | CH Highest -2479MHz |

Note:

- (1) The Mouse used the new battery



3.3 BLOCK DIGRAM SHOWING THE CONFIGURATION OF SYSTEM TESTED

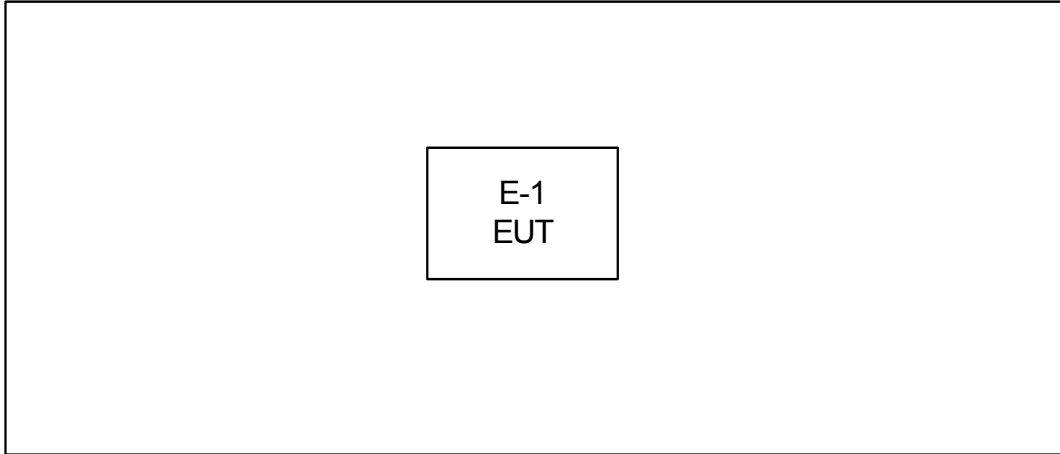



3.4 DESCRIPTION OF SUPPORT UNITS

The EUT has been tested as an independent unit together with other necessary accessories or support units. The following support units or accessories were used to form a representative test configuration during the tests.

| Item | Equipment | Mfr/Brand | Model/Type No. | FCC ID | Series No. | Note |
|------|----------------------|-----------|----------------|------------|------------|------|
| E-1 | Wireless Laser Mouse | N/A | L213 3D3+1B | P5A-CL0015 | N/A | EUT |
| | | | | | | |
| | | | | | | |
| | | | | | | |
| | | | | | | |

| Item | Shielded Type | Ferrite Core | Length | Note |
|------|---------------|--------------|--------|------|
| | | | | |
| | | | | |
| | | | | |
| | | | | |

Note:

- (1) The support equipment was authorized by Declaration of Confirmation.
- (2) For detachable type I/O cable should be specified the length in cm in 『Length』 column.



4. EMC EMISSION TEST

4.1 CONDUCTED EMISSION MEASUREMENT

4.1.1 POWER LINE CONDUCTED EMISSION LIMITS (Frequency Range 150KHz-30MHz)

| FREQUENCY (MHz) | Class A (dBuV) | | Class B (dBuV) | | Standard |
|-----------------|----------------|---------|----------------|-----------|----------|
| | Quasi-peak | Average | Quasi-peak | Average | |
| 0.15 -0.5 | 79.00 | 66.00 | 66 - 56 * | 56 - 46 * | CISPR |
| 0.50 -5.0 | 73.00 | 60.00 | 56.00 | 46.00 | CISPR |
| 5.0 -30.0 | 73.00 | 60.00 | 60.00 | 50.00 | CISPR |

| | | | | | |
|-----------|-------|-------|-----------|-----------|-----|
| 0.15 -0.5 | 79.00 | 66.00 | 66 - 56 * | 56 - 46 * | FCC |
| 0.50 -5.0 | 73.00 | 60.00 | 56.00 | 46.00 | FCC |
| 5.0 -30.0 | 73.00 | 60.00 | 60.00 | 50.00 | FCC |

Note:

- (1) The tighter limit applies at the band edges.
- (2) The limit of " * " marked band means the limitation decreases linearly with the logarithm of the frequency in the range.

4.1.2 MEASUREMENT INSTRUMENTS LIST

| Item | Kind of Equipment | Manufacturer | Type No. | Serial No. | Calibrated until |
|------|-------------------|-----------------|----------|------------|------------------|
| 1 | LISN | EMCO | 3816/2 | 00042991 | Jan. 23, 2010 |
| 2 | LISN | EMCO | 3816/2 | 00042990 | Jan. 23, 2010 |
| 3 | Pulse Limiter | Electro-Metrics | EM-7600 | 112644 | Nov. 26, 2009 |
| 4 | 50Ω Terminator | N/A | N/A | N/A | May.12, 2010 |
| 5 | Test Cable | N/A | C01 | N/A | Nov. 26, 2009 |
| 6 | EMI Test Receiver | R&S | ESCI | 100082 | Mar. 06, 2010 |

Remark: " N/A" denotes No Model Name. , Serial No. or No Calibration specified.

The following table is the setting of the receiver

| Receiver Parameters | Setting |
|---------------------|----------|
| Attenuation | 10 dB |
| Start Frequency | 0.15 MHz |
| Stop Frequency | 30 MHz |
| IF Bandwidth | 9 kHz |

4.1.3 TEST PROCEDURE

- a. The EUT was placed 0.4 meters from the horizontal ground plane with EUT being connected to the power mains through a line impedance stabilization network (LISN). All other support equipments powered from additional LISN(s). The LISN provide 50 Ohm/ 50uH of coupling impedance for the measuring instrument.
- b. Interconnecting cables that hang closer than 40 cm to the ground plane shall be folded back and forth in the center forming a bundle 30 to 40 cm long.
- c. I/O cables that are not connected to a peripheral shall be bundled in the center. The end of the cable may be terminated, if required, using the correct terminating impedance. The overall length shall not exceed 1 m.
- d. LISN at least 80 cm from nearest part of EUT chassis.
- e. For the actual test configuration, please refer to the related Item –EUT Test Photos.

4.1.4 DEVIATION FROM TEST STANDARD

No deviation

4.1.5 TEST SETUP

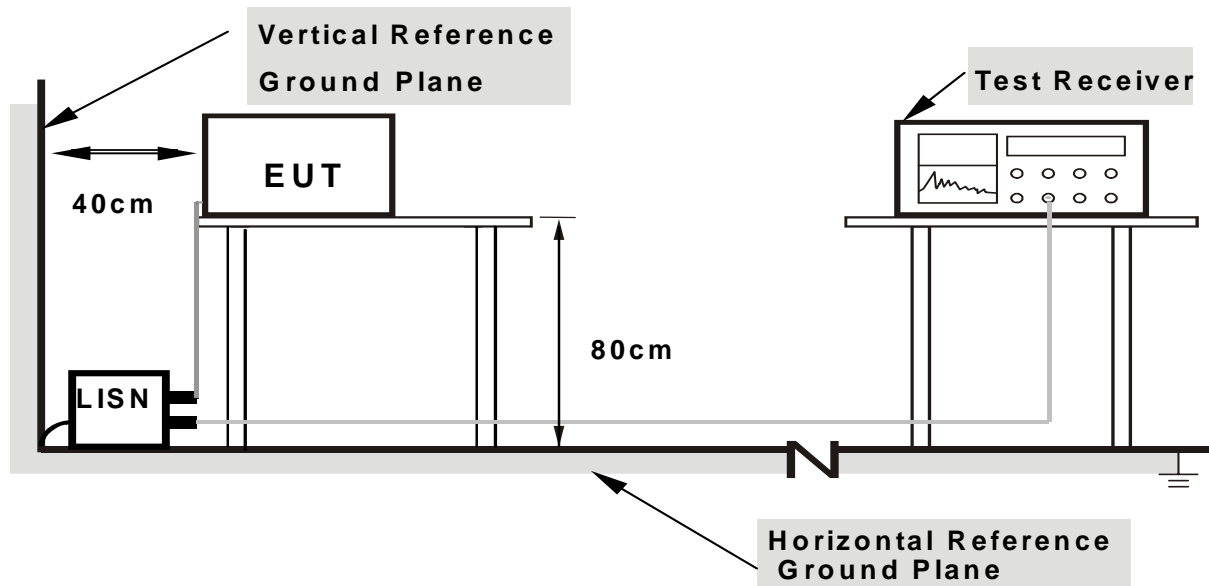

Note: 1. Support units were connected to second LISN.

2. Both of LISNs (AMN) are 80 cm from EUT and at least 80 cm from other units and other metal planes

4.1.6 EUT OPERATING CONDITIONS

The EUT was configured for testing in a typical fashion (as a customer would normally use it). The EUT has been programmed to continuously transmit during test. This operating condition was tested and used to collect the included data.



4.1.7 TEST RESULTS

| | | | |
|---------------|---|---------------------|-------------|
| EUT : | Wireless Laser Mouse | Model Name. : | L213 3D3+1B |
| Temperature : | 29 °C | Relative Humidity : | 50 % |
| Pressure : | 1008 hPa | Test Power : | DC 3.0V |
| Test Mode : | " N/A" denotes test is not applicable in this Test Report | | |

Remark

- (1) All readings are QP Mode value unless otherwise stated AVG in column of 'Note'. If the QP Mode Measured value compliance with the QP Limits and lower than AVG Limits, the EUT shall be deemed to meet both QP & AVG Limits and then only QP Mode was measured, but AVG Mode didn't perform. In this case, a " * " marked in AVG Mode column of Interference Voltage Measured.
- (2) Measuring frequency range from 150KHz to 30MHz.
- (3) " N/A" denotes test is not applicable in this Test Report



4.2 RADIATED EMISSION MEASUREMENT

4.2.1 RADIATED EMISSION LIMITS (FCC 15.209)

| Frequencies (MHz) | Field Strength (micorvolts/meter) | Measurement Distance (meters) |
|--------------------------|--|--------------------------------------|
| 0.009~0.490 | 2400/F(KHz) | 300 |
| 0.490~1.705 | 24000/F(KHz) | 30 |
| 1.705~30.0 | 30 | 30 |
| 30~88 | 100 | 3 |
| 88~216 | 150 | 3 |
| 216~960 | 200 | 3 |
| Above 960 | 500 | 3 |

Harmonic emissions limits comply with below 54 dBuV/m at 3m. Other emissions radiated outside of the specified frequency bands, except for harmonics, shall be attenuated by at least 50 dB below the level of the fundamental or comply with the radiated emissions limits specified in section 15.209(a) limit in the table below has to be followed.

Note:

- (1) The tighter limit applies at the band edges.
- (2) Emission level (dBuV/m)=20log Emission level (uV/m).

LIMITS OF RADIATED EMISSION MEASUREMENT (FCC 15.209)

| FREQUENCY (MHz) | Class A (dBuV/m) (at 3m) | | Class B (dBuV/m) (at 3m) | |
|------------------------|---------------------------------|----------------|---------------------------------|----------------|
| | PEAK | AVERAGE | PEAK | AVERAGE |
| Above 1000 | 80 | 60 | 74 | 54 |

Notes:

- (1) The limit for radiated test was performed according to FCC PART 15C.
- (2) The tighter limit applies at the band edges.
- (3) Emission level (dBuV/m)=20log Emission level (uV/m).

LIMITS OF RADIATED EMISSION MEASUREMENT (FCC Part 15.249)

| FCC Part15 (15.249) , Subpart C | |
|---|------------------------------|
| Limit | Frequency Range (MHz) |
| Field strength of fundamental 50000 μV/m (94 dBμV/m) @ 3 m | 2400-2483.5 |
| Field strength of harmonics 500 μV/m (54 dBμV/m) @ 3 m | Above 2483.5 |



4.2.2 MEASUREMENT INSTRUMENTS LIST

| Item | Kind of Equipment | Manufacturer | Type No. | Serial No. | Calibrated until |
|------|-------------------------|------------------|--------------|------------|------------------|
| 1 | Log-Bicon Antenna | Schwarzbeck | VULB 9160 | 3058 | Nov. 26, 2009 |
| 2 | Test Cable | N/A | 10M_OS02 | N/A | Nov. 26, 2009 |
| 3 | Test Cable | N/A | OS02-1/-2/-3 | N/A | Nov. 26, 2009 |
| 4 | Pre-Amplifier | Anritsu | MH648A | M09961 | Nov. 26, 2009 |
| 5 | EMI Test Receiver | R&S | ESCI | 100082 | Jan. 29, 2010 |
| 6 | Antenna Mast | Chance Most | CMTB-1.5 | N/A | N/A |
| 7 | Turn Table | Chance Most | CMTB-1.5 | N/A | N/A |
| 8 | Spectrum Analyzer | R&S | FSP_40 | 100129 | Jan. 06, 2010 |
| 9 | Horn Antenna | Schwarzbeck | BBHA9120D | 9120D-325 | Oct. 23, 2009 |
| 10 | Horn Antenna | Schwarzbeck | BBHA9170 | 9170187 | Oct. 23, 2009 |
| 11 | Microwave Pre_amplifier | Agilent | 8449B | 3008A01714 | Mar. 08, 2010 |
| 12 | Microflex Cable | United Microwave | 57793 | 1m | Mar. 08, 2010 |
| 13 | Microflex Cable | United Microwave | A30A30-5006 | 10M | Jul. 05, 2010 |

Remark: " N/A" denotes No Model Name. / Serial No. and No Calibration specified.

| Spectrum Parameter | Setting |
|---------------------------------------|--|
| Attenuation | Auto |
| Start Frequency | 1000 MHz |
| Stop Frequency | 10th carrier harmonic |
| RB / VB (emission in restricted band) | 1MHz / 3MHz for Peak, 1 MHz / 10Hz for Average |

| Receiver Parameter | Setting |
|------------------------|----------------------------------|
| Attenuation | Auto |
| Start ~ Stop Frequency | 9kHz~150kHz / RB 200Hz for QP |
| Start ~ Stop Frequency | 150kHz~30MHz / RB 9kHz for QP |
| Start ~ Stop Frequency | 30MHz~1000MHz / RB 120kHz for QP |



4.2.3 TEST PROCEDURE

- a. The measuring distance of at 3 m shall be used for measurements at frequency up to 1GHz. For frequencies above 1GHz, any suitable measuring distance may be used.
- b. The EUT was placed on the top of a rotating table 0.8 meters above the ground at a 3m meter open area test site. The table was rotated 360 degrees to determine the position of the highest radiation.
- c. The height of the equipment or of the substitution antenna shall be 0.8 m; the height of the test antenna shall vary between 1 m to 4 m. Both horizontal and vertical polarizations of the antenna are set to make the measurement.
- d. The initial step in collecting conducted emission data is a spectrum analyzer peak detector mode pre-scanning the measurement frequency range. Significant peaks are then marked and then Quasi Peak detector mode re-measured.
- e. If the Peak Mode measured value compliance with and lower than Quasi Peak Mode Limit, the EUT shall be deemed to meet QP Limits and then no additional QP Mode measurement performed.
- f. For the actual test configuration, please refer to the related Item –EUT Test Photos.

4.2.4 DEVIATION FROM TEST STANDARD

No deviation

4.2.5 TEST SETUP

(A) Radiated Emission Test Set-Up, Frequency Below 1000MHz

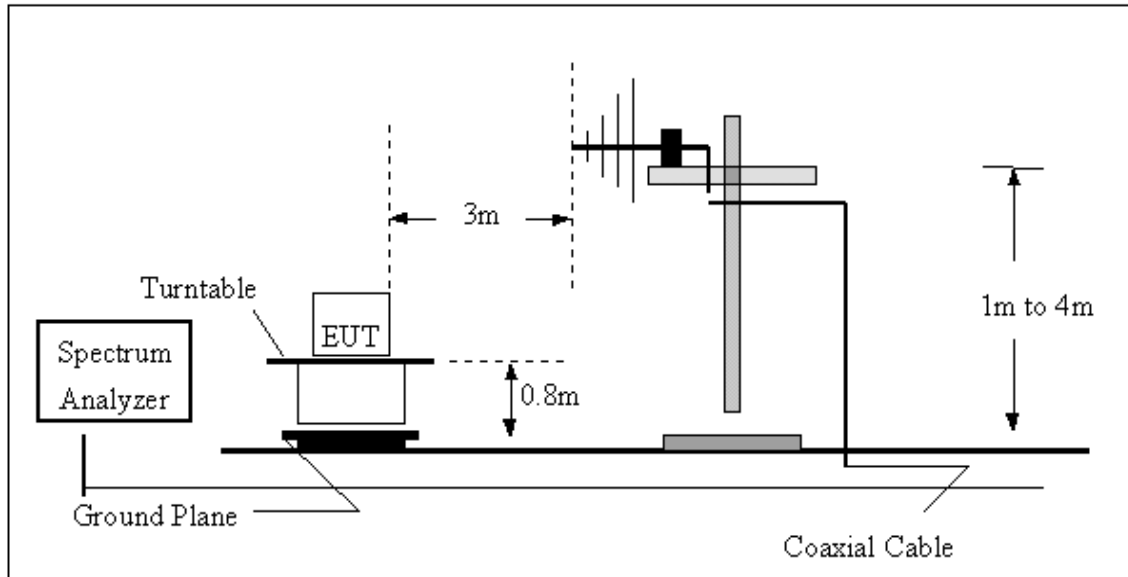

(B) Radiated Emission Test Set-Up Frequency Above 1 GHz

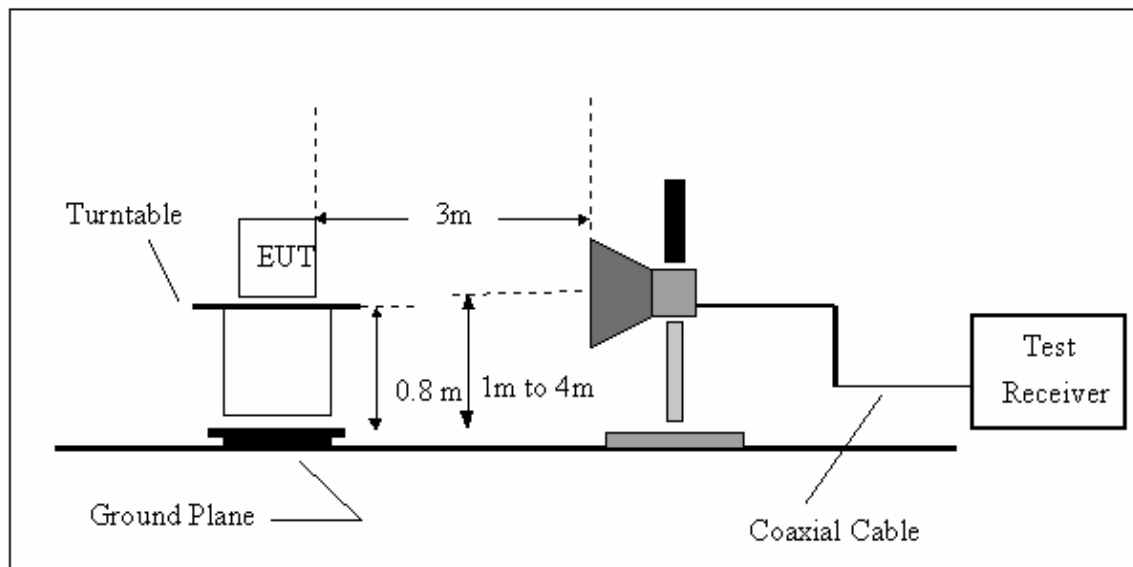

4.2.6 EUT OPERATING CONDITIONS

The EUT tested system was configured as the statements of 4.1.6 Unless otherwise a special operating condition is specified in the follows during the testing.



4.2.7 TEST RESULTS (BETWEEN 30 – 1000 MHz)

| | | | |
|---------------|----------------------|---------------------|-------------|
| EUT : | Wireless Laser Mouse | Model Name. : | L213 3D3+1B |
| Temperature : | 29 °C | Relative Humidity : | 50 % |
| Pressure : | 1008 hPa | Test Power : | DC 3.0V |
| Test Mode : | TX CH 2439MHz | | |

| Freq. (MHz) | Ant. H/V | Reading(RA) (dBuV) | Corr.Factor(CF) (dB) | Measured(FS) (dBuV/m) | Limits(QP) (dBuV/m) | Margin (dB) | Note |
|-------------|----------|--------------------|----------------------|-----------------------|---------------------|-------------|------|
| 37.84 | V | 37.37 | -15.88 | 21.49 | 40.00 | - 18.51 | |
| 63.64 | V | 35.51 | -16.01 | 19.50 | 40.00 | - 20.50 | |
| 257.48 | V | 37.98 | -14.00 | 23.98 | 46.00 | - 22.02 | |
| 369.45 | V | 38.58 | -10.94 | 27.64 | 46.00 | - 18.36 | |
| 539.56 | V | 37.38 | -7.84 | 29.54 | 46.00 | - 16.46 | |
| 584.80 | V | 37.49 | -6.56 | 30.93 | 46.00 | - 15.07 | |

Remark :

- (1) All readings are Peak unless otherwise stated QP in column of 『Note』 . Peak denotes that the Peak reading compliance with the QP Limits and then QP Mode measurement didn't perform ◦
- (2) Measuring frequency range from 30MHz to 1000MHz or the 10th harmonic of highest fundamental frequency ◦ “F” denotes fundamental frequency; “ H” denotes spurious frequency. “E” denotes band edge frequency.
- (3) Radiated emissions measured in frequency range from 30 MHz to 1000 MHz were made with an instrument using Peak detector mode or QP detector mode of the emission ◦
- (4) Data of measurement within this frequency range shown “ - ” in the table above means the reading of emissions are attenuated more than 20dB below the permissible limits or the field strength is too small to be measured.

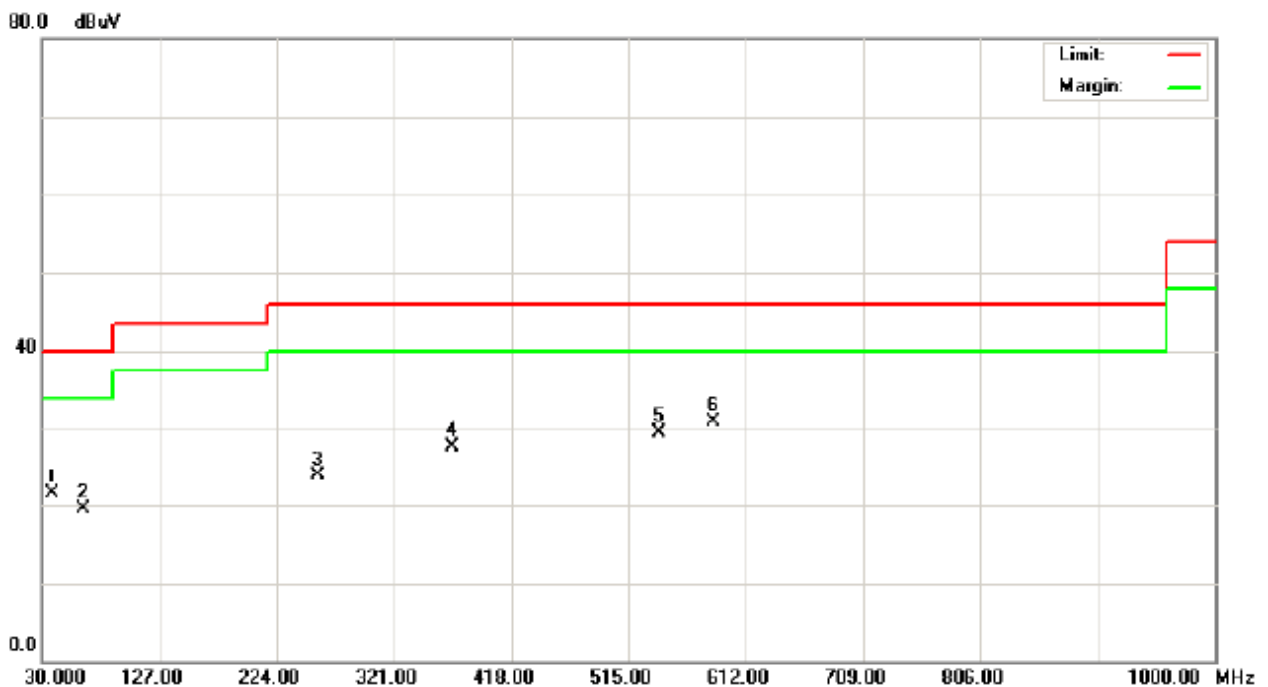



| | | | |
|---------------|----------------------|---------------------|-------------|
| EUT : | Wireless Laser Mouse | Model Name. : | L213 3D3+1B |
| Temperature : | 29 °C | Relative Humidity : | 50 % |
| Pressure : | 1008 hPa | Test Power : | DC 3.0V |
| Test Mode : | TX CH 2439MHz | | |

| Freq. (MHz) | Ant. H/V | Reading(RA) (dBuV) | Corr.Factor(CF) (dB) | Measured(FS) (dBuV/m) | Limits(QP) (dBuV/m) | Margin (dB) | Note |
|-------------|----------|--------------------|----------------------|-----------------------|---------------------|-------------|------|
| 39.65 | H | 35.36 | -15.75 | 19.61 | 40.00 | - 20.39 | |
| 153.70 | H | 33.86 | -13.64 | 20.22 | 43.50 | - 23.28 | |
| 279.53 | H | 34.69 | -13.01 | 21.68 | 46.00 | - 24.32 | |
| 269.40 | H | 35.78 | -10.94 | 24.84 | 46.00 | - 21.16 | |
| 452.87 | H | 36.94 | -9.27 | 27.67 | 46.00 | - 18.33 | |
| 658.34 | H | 37.37 | -5.26 | 32.11 | 46.00 | - 13.89 | |

Remark :

- (1) All readings are Peak unless otherwise stated QP in column of 『Note』 . Peak denotes that the Peak reading compliance with the QP Limits and then QP Mode measurement didn't perform ◦
- (2) Measuring frequency range from 30MHz to 1000MHz or the 10th harmonic of highest fundamental frequency ◦ “F” denotes fundamental frequency; “ H” denotes spurious frequency. “E” denotes band edge frequency.
- (3) Radiated emissions measured in frequency range from 30 MHz to 1000 MHz were made with an instrument using Peak detector mode or QP detector mode of the emission ◦
- (4) Data of measurement within this frequency range shown “ - ” in the table above means the reading of emissions are attenuated more than 20dB below the permissible limits or the field strength is too small to be measured.

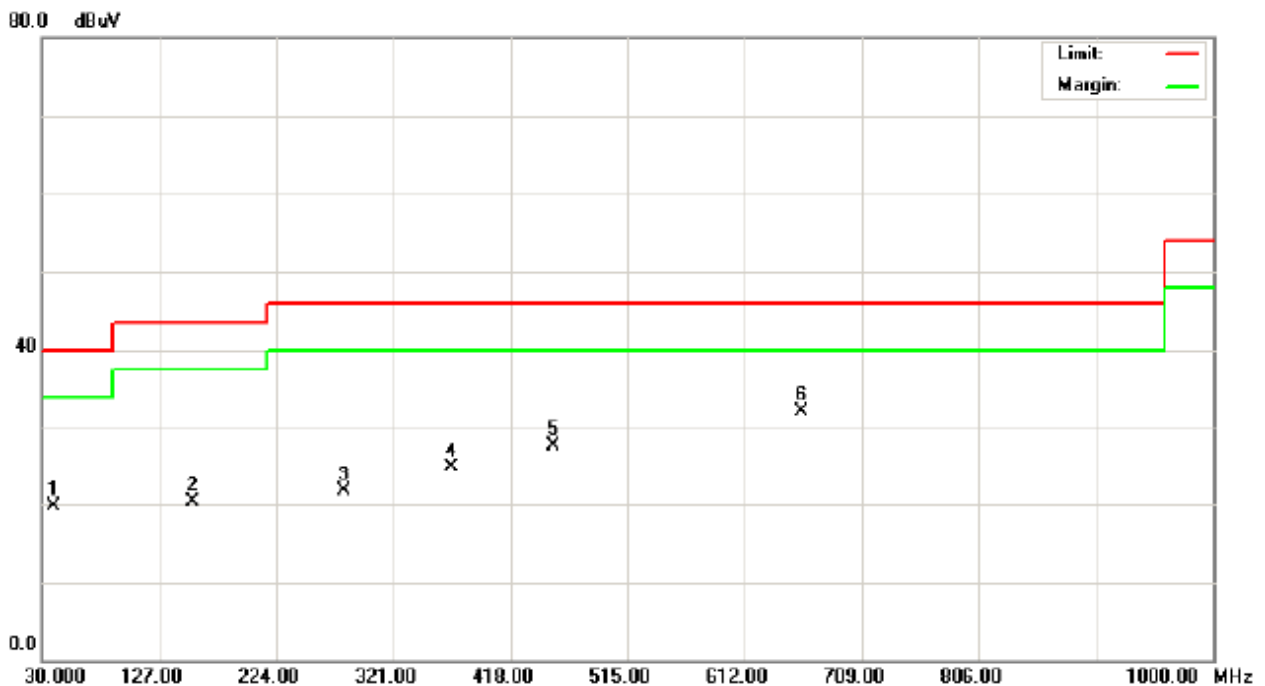



4.2.8 TEST RESULTS (ABOVE 1000 MHz)

| | | | |
|---------------|----------------------|---------------------|-------------|
| EUT : | Wireless Laser Mouse | Model Name. : | L213 3D3+1B |
| Temperature : | 29 °C | Relative Humidity : | 50 % |
| Pressure : | 1008 hPa | Test Power : | DC 3.0V |
| Test Mode : | TX 2402MHz | | |

| Freq. (MHz) | Ant.Pol. H/V | Reading | | Ant./CF CF(dB) | Act. | | Limit | | Note |
|----------------|-----------------|----------------|--------------|-------------------|------------------|----------------|------------------|----------------|------------|
| | | Peak (dBuV) | AV (dBuV) | | Peak (dBuV/m) | AV (dBuV/m) | Peak (dBuV/m) | AV (dBuV/m) | |
| 2390.00 | V | 28.85 | 18.64 | 31.75 | 60.60 | 50.39 | 74.00 | 54.00 | X/E |
| 2401.80 | V | 53.20 | 52.11 | 31.78 | 84.98 | 83.89 | 114.00 | 94.00 | X/F |
| 4804.10 | V | 52.65 | 45.26 | 4.57 | 57.22 | 49.83 | 74.00 | 54.00 | X/H |

Remark :

- (1) All readings are Peak unless otherwise stated QP in column of 『Note』 . Peak denotes that the Peak reading compliance with the QP Limits and then QP Mode measurement didn't perform ◦
- (2) Measuring frequency range from 30MHz to 1000MHz or the 10th harmonic of highest fundamental frequency ◦ "F" denotes fundamental frequency; "H" denotes spurious frequency. "E" denotes band edge frequency. (This judgment method includes the Band Edge Requirement.)
- (3) Radiated emissions measured in frequency range above 1000MHz were made with an instrument using Peak detector mode and AV detector mode of the emission ◦
- (4) Data of measurement within this frequency range shown " * " in the table above means the reading of emissions are attenuated more than 20dB below the permissible limits or the field strength is too small to be measured.
- (5) A preamp and high pass filter were used for this test in order to provide sufficient measurement sensitivity.
- (6) EUT Orthogonal Axis :
"X" - denotes Laid on Table ; "Y" - denotes Vertical Stand ; "Z" - denotes Side Stand
- (7) During the measurements above 1 GHz it is taken care of that the EUT is always within the 3 dB cone of radiation BW of the used antenna



Orthogonal Axis : X
TX 2402MHz (Above 1000 MHz, Vertical)

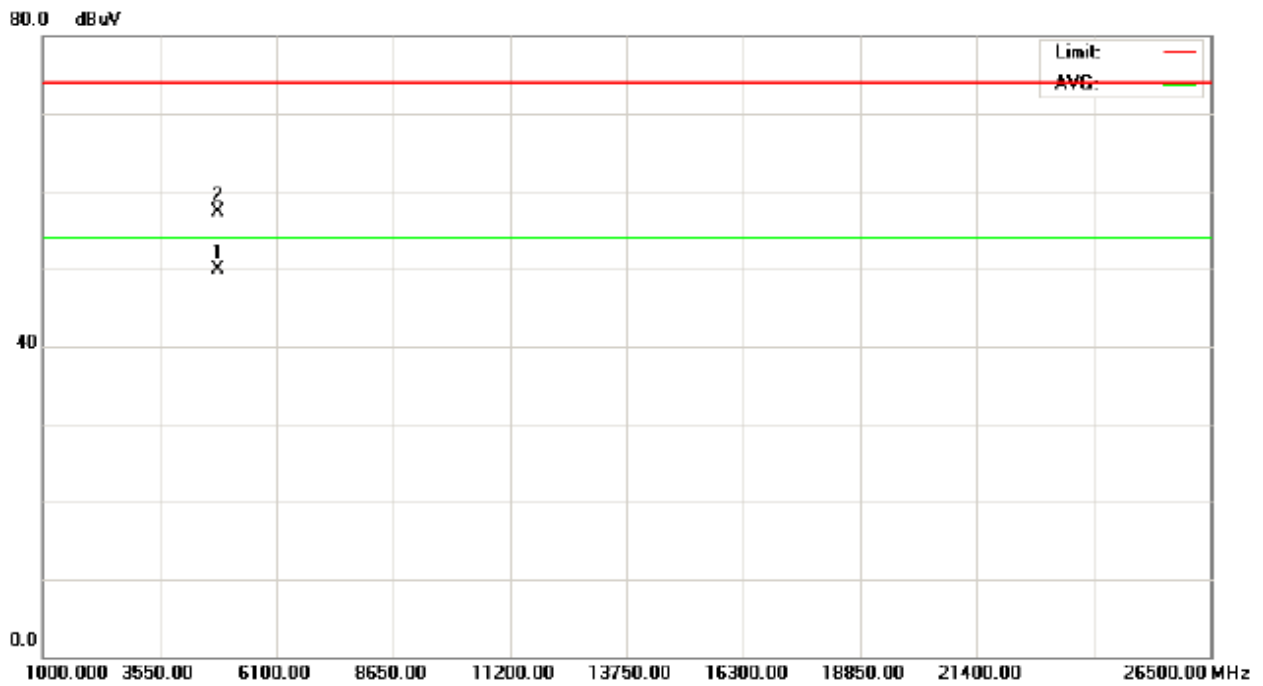
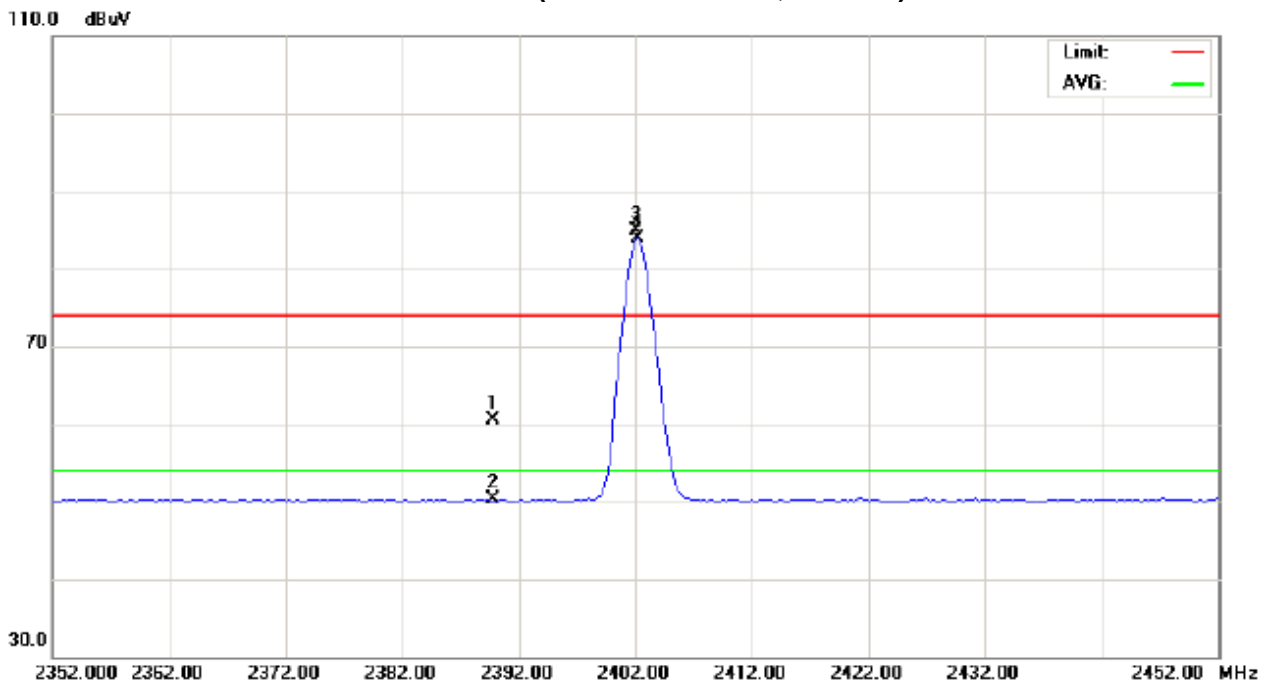



| | | | |
|---------------|----------------------|---------------------|-------------|
| EUT : | Wireless Laser Mouse | Model Name. : | L213 3D3+1B |
| Temperature : | 29 °C | Relative Humidity : | 50 % |
| Pressure : | 1008 hPa | Test Power : | DC 3.0V |
| Test Mode : | TX 2402MHz | | |

| Freq. (MHz) | Ant.Pol. H/V | Reading | | Ant./CF CF(dB) | Act. | | Limit | | Note |
|----------------|-----------------|----------------|--------------|-------------------|------------------|----------------|------------------|----------------|------------|
| | | Peak (dBuV) | AV (dBuV) | | Peak (dBuV/m) | AV (dBuV/m) | Peak (dBuV/m) | AV (dBuV/m) | |
| 2390.00 | H | 27.34 | 18.16 | 31.75 | 59.09 | 49.91 | 74.00 | 54.00 | X/E |
| 2402.50 | H | 60.42 | 59.64 | 31.78 | 92.21 | 91.42 | 114.00 | 94.00 | X/F |
| 4804.20 | H | 51.82 | 45.23 | 4.57 | 56.39 | 49.80 | 74.00 | 54.00 | X/H |

Remark :

- (1) All readings are Peak unless otherwise stated QP in column of 『Note』 . Peak denotes that the Peak reading compliance with the QP Limits and then QP Mode measurement didn't perform ◦
- (2) Measuring frequency range from 30MHz to 1000MHz or the 10th harmonic of highest fundamental frequency ◦ "F" denotes fundamental frequency; "H" denotes spurious frequency. "E" denotes band edge frequency. (This judgment method includes the Band Edge Requirement.)
- (3) Radiated emissions measured in frequency range above 1000MHz were made with an instrument using Peak detector mode and AV detector mode of the emission ◦
- (4) Data of measurement within this frequency range shown " * " in the table above means the reading of emissions are attenuated more than 20dB below the permissible limits or the field strength is too small to be measured.
- (5) A preamp and high pass filter were used for this test in order to provide sufficient measurement sensitivity.
- (6) EUT Orthogonal Axis :
"X" - denotes Laid on Table ; "Y" - denotes Vertical Stand ; "Z" - denotes Side Stand
- (7) During the measurements above 1 GHz it is taken care of that the EUT is always within the 3 dB cone of radiation BW of the used antenna



Orthogonal Axis : X
TX 2402MHz (Above 1000 MHz, Horizontal)

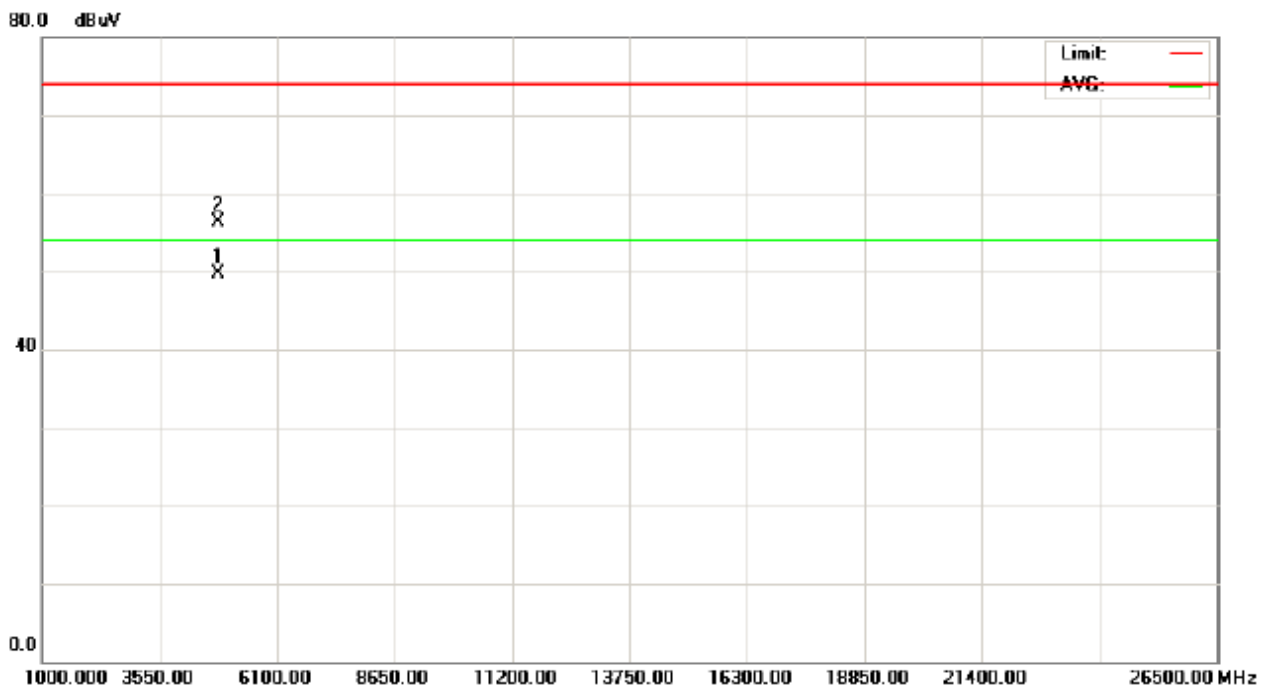
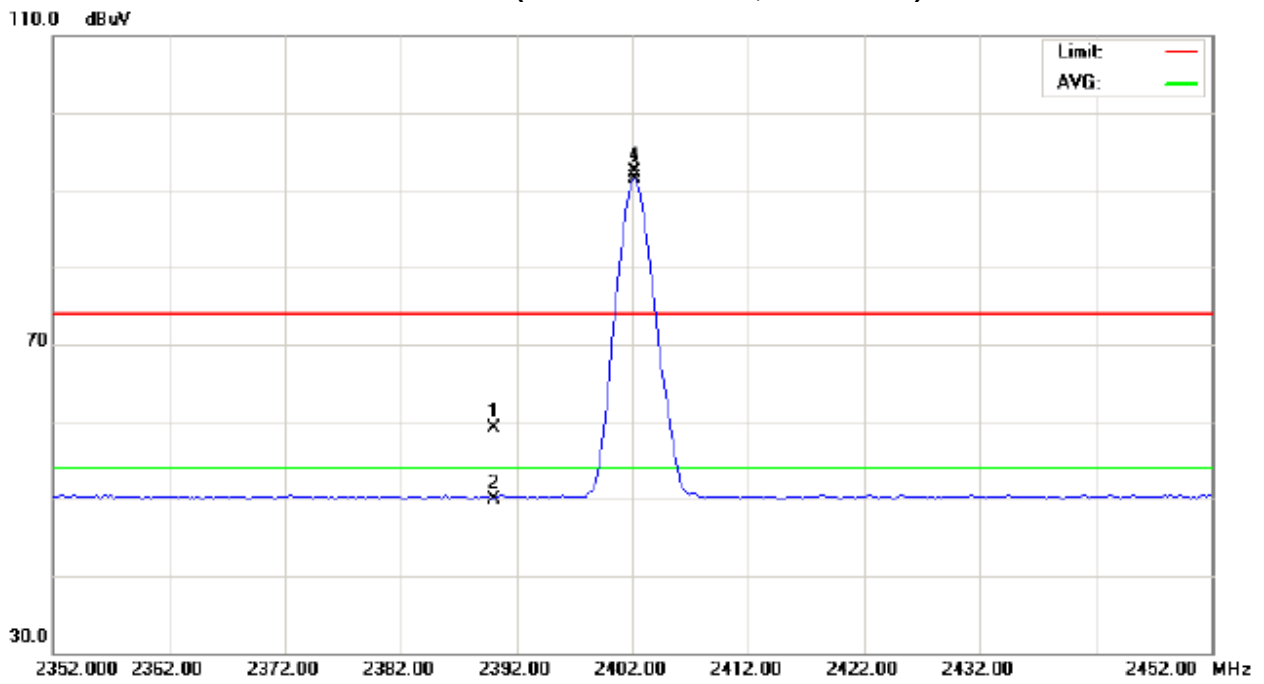



| | | | |
|---------------|----------------------|---------------------|-------------|
| EUT : | Wireless Laser Mouse | Model Name. : | L213 3D3+1B |
| Temperature : | 29 °C | Relative Humidity : | 50 % |
| Pressure : | 1008 hPa | Test Power : | DC 3.0V |
| Test Mode : | TX 2439MHz | | |

| Freq. (MHz) | Ant.Pol. H/V | Reading | | Ant./CF CF(dB) | Act. | | Limit | | Note |
|----------------|-----------------|----------------|--------------|-------------------|------------------|----------------|------------------|----------------|------------|
| | | Peak (dBuV) | AV (dBuV) | | Peak (dBuV/m) | AV (dBuV/m) | Peak (dBuV/m) | AV (dBuV/m) | |
| 2438.80 | V | 54.44 | 53.60 | 31.90 | 86.34 | 85.50 | 114.00 | 94.00 | X/F |
| 4878.10 | V | 52.96 | 45.64 | 4.76 | 57.72 | 50.40 | 74.00 | 54.00 | X/H |

Remark :

- (1) All readings are Peak unless otherwise stated QP in column of 『Note』 . Peak denotes that the Peak reading compliance with the QP Limits and then QP Mode measurement didn't perform ◦
- (2) Measuring frequency range from 30MHz to 1000MHz or the 10th harmonic of highest fundamental frequency ◦“F” denotes fundamental frequency; “H” denotes spurious frequency. “E” denotes band edge frequency. (This judgment method includes the Band Edge Requirement.)
- (3) Radiated emissions measured in frequency range above 1000MHz were made with an instrument using Peak detector mode and AV detector mode of the emission ◦
- (4) Data of measurement within this frequency range shown “ * ” in the table above means the reading of emissions are attenuated more than 20dB below the permissible limits or the field strength is too small to be measured.
- (5) A preamp and high pass filter were used for this test in order to provide sufficient measurement sensitivity.
- (6) EUT Orthogonal Axis :
“X” - denotes Laid on Table ; “Y” - denotes Vertical Stand ; “Z” - denotes Side Stand
- (7) During the measurements above 1 GHz it is taken care of that the EUT is always within the 3 dB cone of radiation BW of the used antenna



Orthogonal Axis : X
TX 2439 MHz (Above 1000 MHz, Vertical)

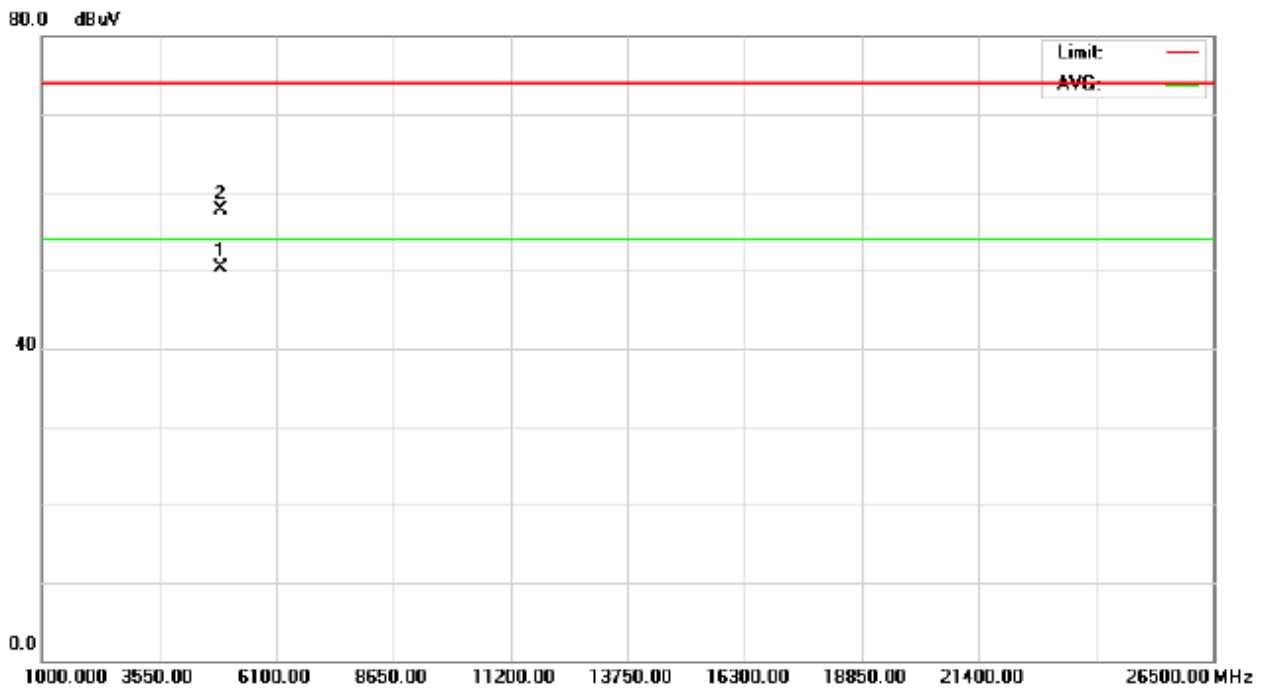
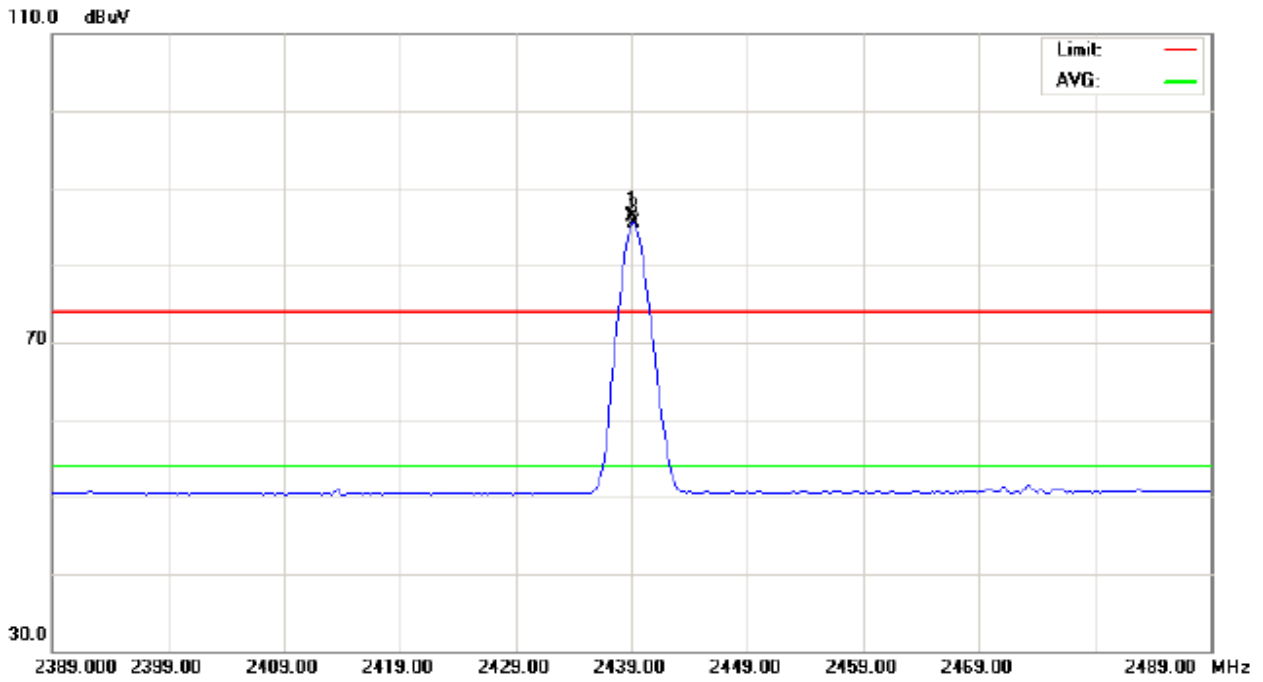



| | | | |
|---------------|----------------------|---------------------|-------------|
| EUT : | Wireless Laser Mouse | Model Name. : | L213 3D3+1B |
| Temperature : | 29 °C | Relative Humidity : | 50 % |
| Pressure : | 1008 hPa | Test Power : | DC 3.0V |
| Test Mode : | TX 2439MHz | | |

| Freq. (MHz) | Ant.Pol. H/V | Reading | | Ant./CF CF(dB) | Act. | | Limit | | Note |
|----------------|-----------------|----------------|--------------|-------------------|------------------|----------------|------------------|----------------|------------|
| | | Peak (dBuV) | AV (dBuV) | | Peak (dBuV/m) | AV (dBuV/m) | Peak (dBuV/m) | AV (dBuV/m) | |
| 2438.80 | H | 59.93 | 57.95 | 31.90 | 91.83 | 89.85 | 114.00 | 94.00 | X/F |
| 4878.10 | H | 51.83 | 45.24 | 4.76 | 56.59 | 50.00 | 74.00 | 54.00 | X/H |

Remark :

- (1) All readings are Peak unless otherwise stated QP in column of 『Note』 . Peak denotes that the Peak reading compliance with the QP Limits and then QP Mode measurement didn't perform ◦
- (2) Measuring frequency range from 30MHz to 1000MHz or the 10th harmonic of highest fundamental frequency ◦ "F" denotes fundamental frequency; "H" denotes spurious frequency. "E" denotes band edge frequency. (This judgment method includes the Band Edge Requirement.)
- (3) Radiated emissions measured in frequency range above 1000MHz were made with an instrument using Peak detector mode and AV detector mode of the emission ◦
- (4) Data of measurement within this frequency range shown " * " in the table above means the reading of emissions are attenuated more than 20dB below the permissible limits or the field strength is too small to be measured.
- (5) A preamp and high pass filter were used for this test in order to provide sufficient measurement sensitivity.
- (6) EUT Orthogonal Axis :
"X" - denotes Laid on Table ; "Y" - denotes Vertical Stand ; "Z" - denotes Side Stand
- (7) During the measurements above 1 GHz it is taken care of that the EUT is always within the 3 dB cone of radiation BW of the used antenna



Orthogonal Axis : X
TX 2439MHz (Above 1000 MHz, Horizontal)

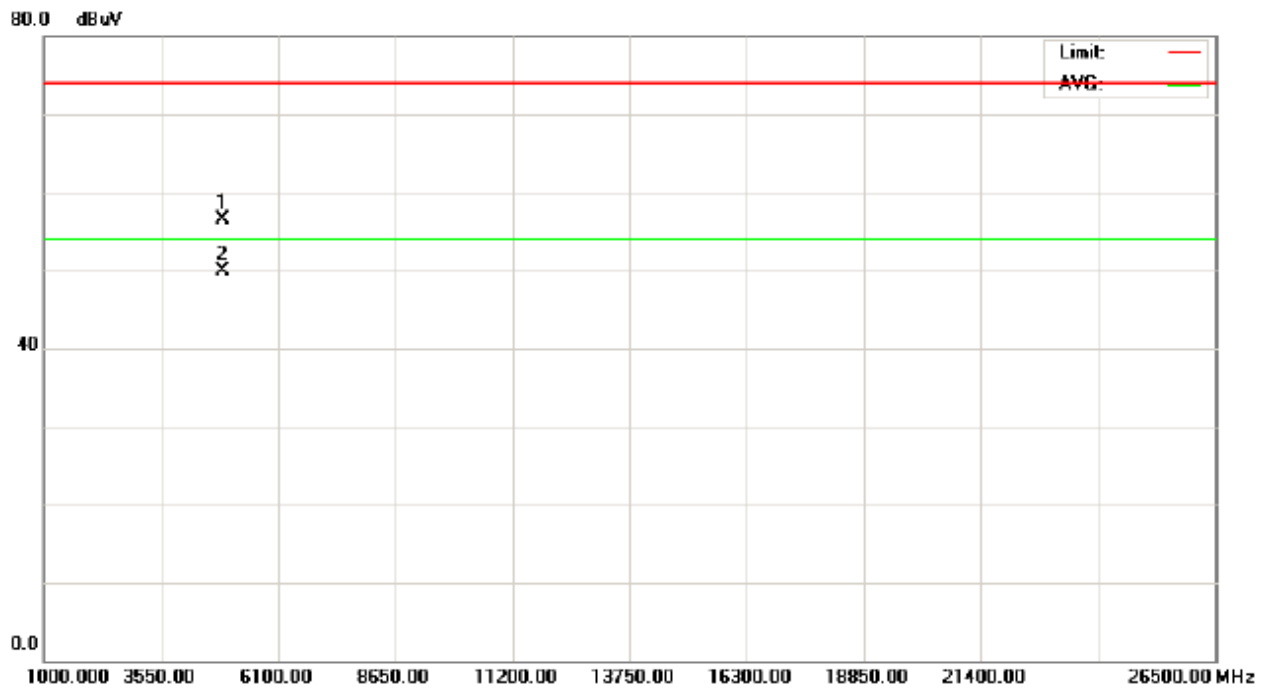
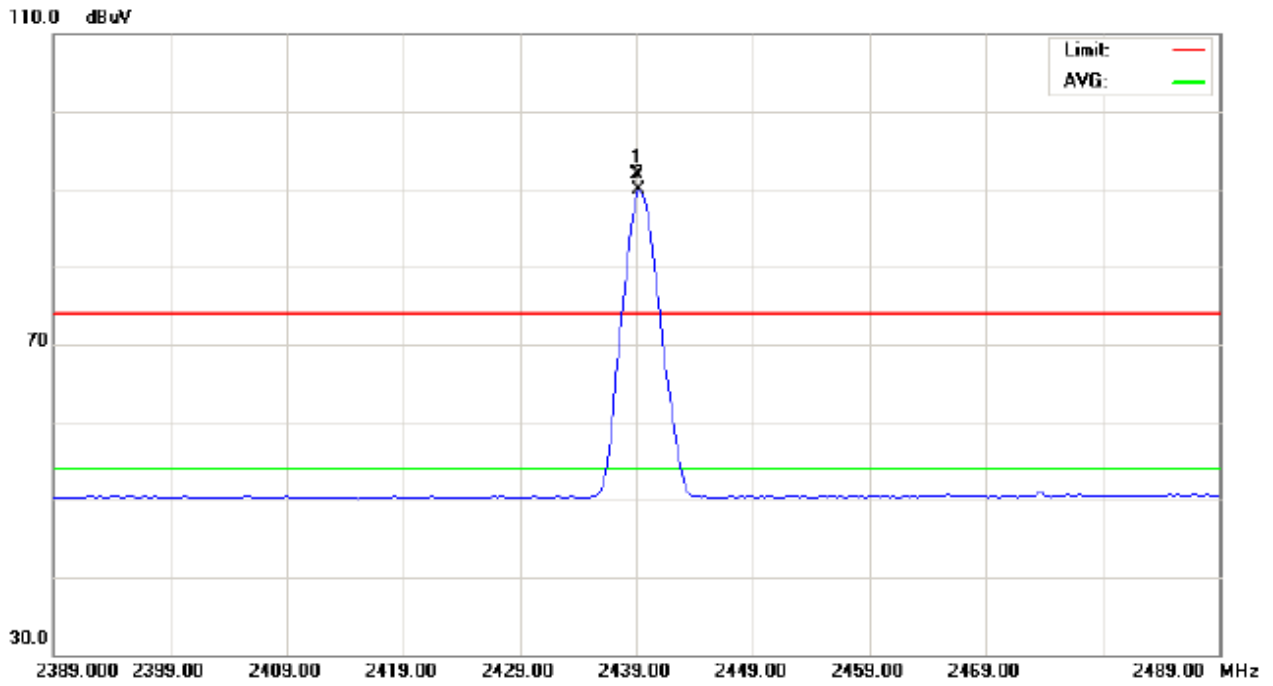



| | | | |
|---------------|----------------------|---------------------|-------------|
| EUT : | Wireless Laser Mouse | Model Name. : | L213 3D3+1B |
| Temperature : | 29 °C | Relative Humidity : | 50 % |
| Pressure : | 1008 hPa | Test Power : | DC 3.0V |
| Test Mode : | TX 2479MHz | | |

| Freq. (MHz) | Ant.Pol. H/V | Reading | | Ant./CF CF(dB) | Act. | | Limit | | Note |
|----------------|-----------------|----------------|--------------|-------------------|------------------|----------------|------------------|----------------|------------|
| | | Peak (dBuV) | AV (dBuV) | | Peak (dBuV/m) | AV (dBuV/m) | Peak (dBuV/m) | AV (dBuV/m) | |
| 2479.30 | V | 54.26 | 53.25 | 32.01 | 86.27 | 85.26 | 114.00 | 94.00 | X/F |
| 2483.50 | V | 28.78 | 18.74 | 32.03 | 60.81 | 50.77 | 74.00 | 54.00 | X/E |
| 4958.05 | V | 51.22 | 44.67 | 4.97 | 56.19 | 49.64 | 74.00 | 54.00 | X/H |

Remark :

- (1) All readings are Peak unless otherwise stated QP in column of 『Note』 . Peak denotes that the Peak reading compliance with the QP Limits and then QP Mode measurement didn't perform ◦
- (2) Measuring frequency range from 30MHz to 1000MHz or the 10th harmonic of highest fundamental frequency ◦ “F” denotes fundamental frequency; “H” denotes spurious frequency. “E” denotes band edge frequency. (This judgment method includes the Band Edge Requirement.)
- (3) Radiated emissions measured in frequency range above 1000MHz were made with an instrument using Peak detector mode and AV detector mode of the emission ◦
- (4) Data of measurement within this frequency range shown “ * ” in the table above means the reading of emissions are attenuated more than 20dB below the permissible limits or the field strength is too small to be measured.
- (5) A preamp and high pass filter were used for this test in order to provide sufficient measurement sensitivity.
- (6) EUT Orthogonal Axis :
“X” - denotes Laid on Table ; “Y” - denotes Vertical Stand ; “Z” - denotes Side Stand
- (7) During the measurements above 1 GHz it is taken care of that the EUT is always within the 3 dB cone of radiation BW of the used antenna



Orthogonal Axis : X
TX 2479MHz (Above 1000 MHz, Vertical)

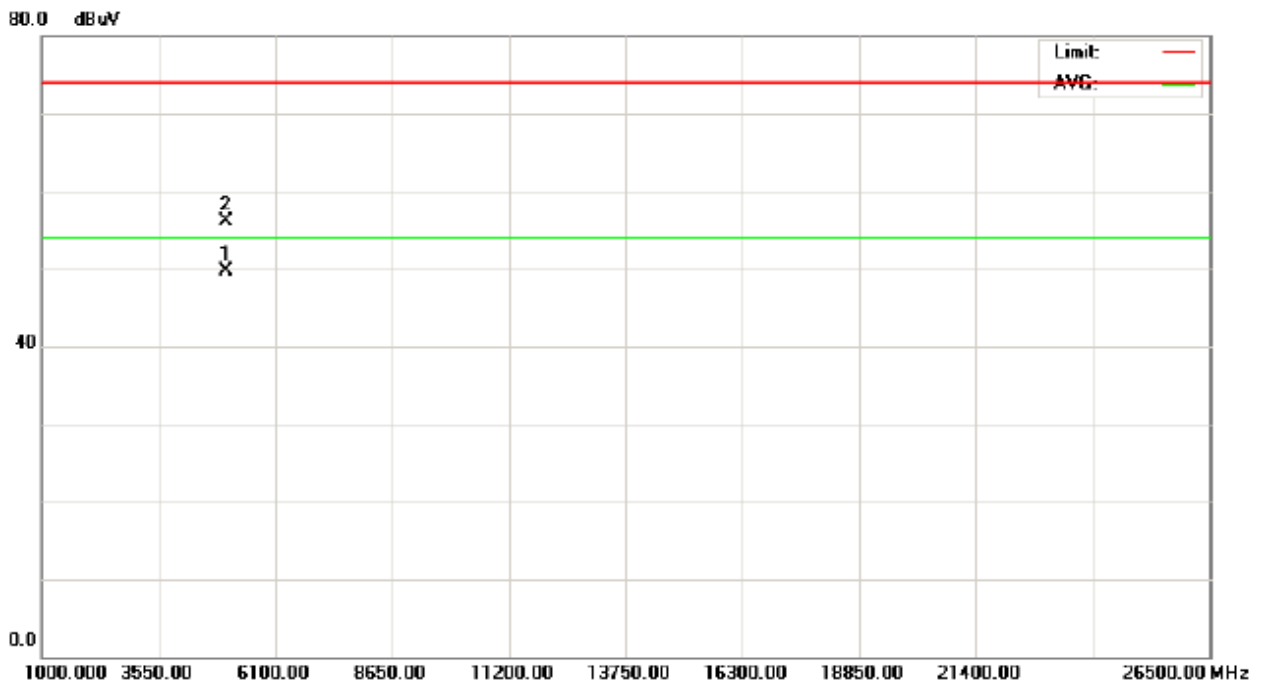
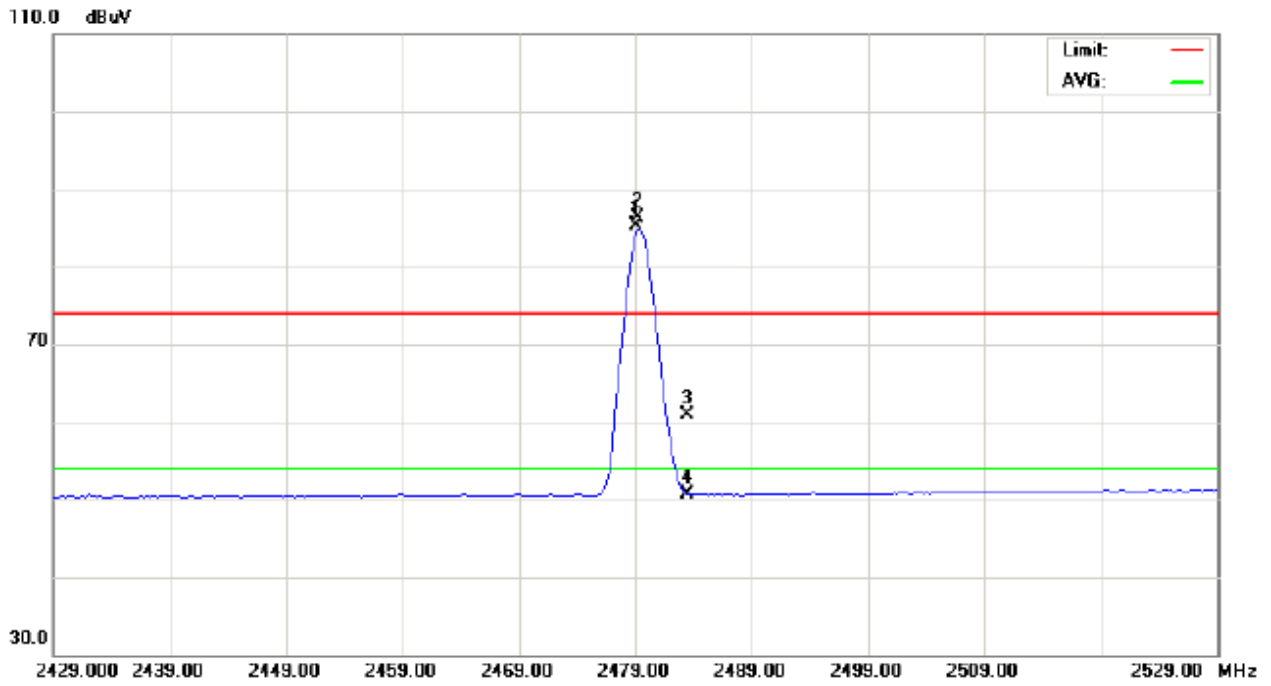



| | | | |
|---------------|----------------------|---------------------|-------------|
| EUT : | Wireless Laser Mouse | Model Name. : | L213 3D3+1B |
| Temperature : | 29 °C | Relative Humidity : | 50 % |
| Pressure : | 1008 hPa | Test Power : | DC 3.0V |
| Test Mode : | TX 2479MHz | | |

| Freq. (MHz) | Ant.Pol. H/V | Reading | | Ant./CF CF(dB) | Act. | | Limit | | Note |
|----------------|-----------------|----------------|--------------|-------------------|------------------|----------------|------------------|----------------|------------|
| | | Peak (dBuV) | AV (dBuV) | | Peak (dBuV/m) | AV (dBuV/m) | Peak (dBuV/m) | AV (dBuV/m) | |
| 2478.80 | H | 59.03 | 57.68 | 32.01 | 91.04 | 89.69 | 114.00 | 94.00 | X/F |
| 2483.50 | H | 28.94 | 12.26 | 32.03 | 60.67 | 51.29 | 74.00 | 54.00 | X/E |
| 4958.03 | H | 49.67 | 43.84 | 4.97 | 54.64 | 48.81 | 74.00 | 54.00 | X/H |

Remark :

- (1) All readings are Peak unless otherwise stated QP in column of 『Note』 . Peak denotes that the Peak reading compliance with the QP Limits and then QP Mode measurement didn't perform ◦
- (2) Measuring frequency range from 30MHz to 1000MHz or the 10th harmonic of highest fundamental frequency ◦ "F" denotes fundamental frequency; "H" denotes spurious frequency. "E" denotes band edge frequency. (This judgment method includes the Band Edge Requirement.)
- (3) Radiated emissions measured in frequency range above 1000MHz were made with an instrument using Peak detector mode and AV detector mode of the emission ◦
- (4) Data of measurement within this frequency range shown " * " in the table above means the reading of emissions are attenuated more than 20dB below the permissible limits or the field strength is too small to be measured.
- (5) A preamp and high pass filter were used for this test in order to provide sufficient measurement sensitivity.
- (6) EUT Orthogonal Axis :
"X" - denotes Laid on Table ; "Y" - denotes Vertical Stand ; "Z" - denotes Side Stand
- (7) During the measurements above 1 GHz it is taken care of that the EUT is always within the 3 dB cone of radiation BW of the used antenna



Orthogonal Axis : X
TX 2479MHz (Above 1000 MHz, Horizontal)

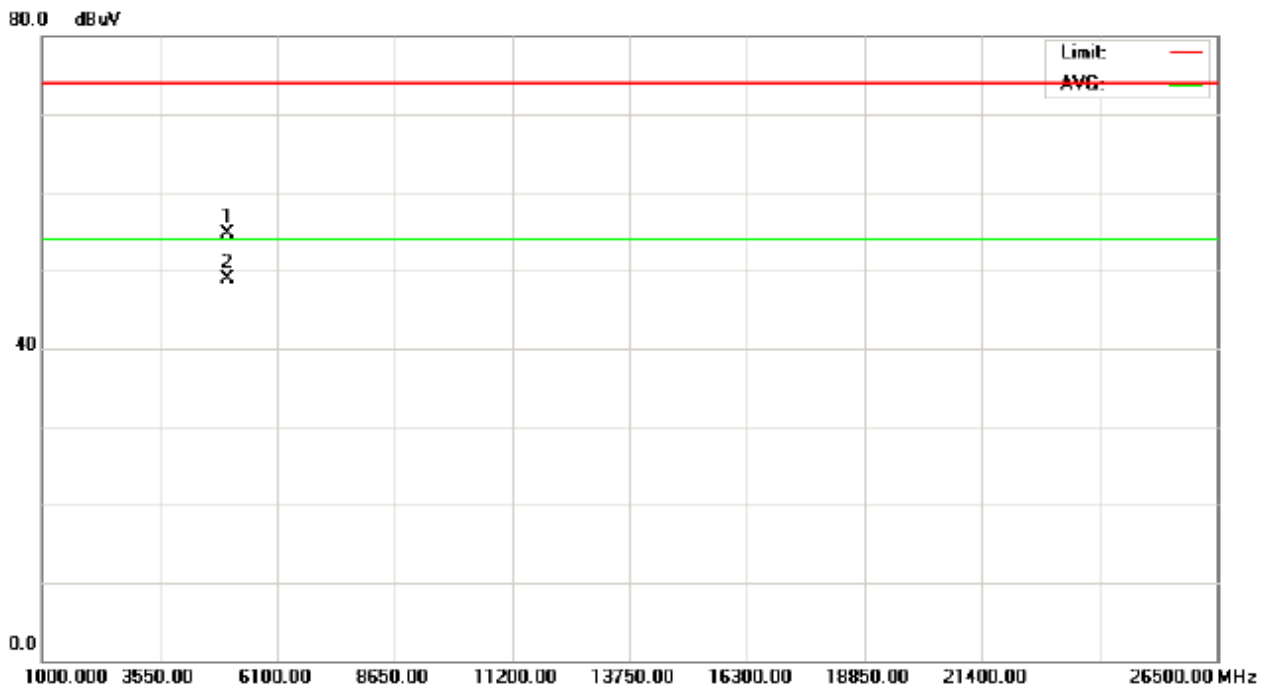
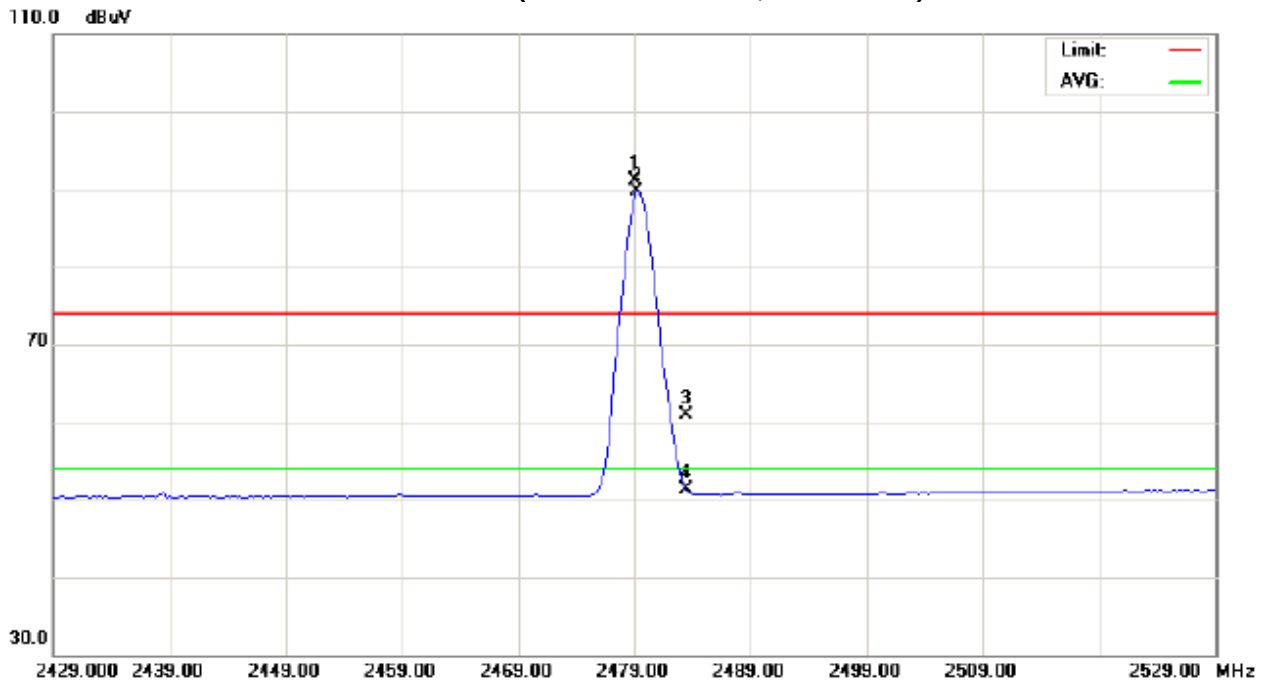



4.2.9 TEST RESULTS (2400 – 2483.5 MHz)

| | | | |
|---------------|-------------------------------|---------------------|-------------|
| EUT : | Wireless Laser Mouse | Model Name. : | L213 3D3+1B |
| Temperature : | 29 °C | Relative Humidity : | 50 % |
| Pressure : | 1008 hPa | Test Power : | DC 3.0V |
| Test Mode : | TX CH 2402MHz/2439MHz/2479MHz | | |

| | | Peak | AV | | Peak | AV | Peak | AV | |
|---------|----------|---------|--------|----------|-----------|----------|----------|----------|------|
| Freq. | Ant.Pol. | Reading | | Ant./CL/ | Actual FS | | Limit3m | | |
| (MHz) | (H/V) | (dBuV) | (dBuV) | CF(dB) | (dBuV/m) | (dBuV/m) | (dBuV/m) | (dBuV/m) | NOTE |
| 2401.80 | V | 53.20 | 52.11 | 31.78 | 84.98 | 83.89 | 114.00 | 94.00 | CH01 |
| 2402.50 | H | 60.42 | 59.64 | 31.78 | 92.21 | 91.42 | 114.00 | 94.00 | CH01 |
| 2438.80 | V | 54.44 | 53.60 | 31.90 | 86.34 | 85.50 | 114.00 | 94.00 | CH08 |
| 2438.80 | H | 59.93 | 58.95 | 31.90 | 91.83 | 89.85 | 114.00 | 94.00 | CH08 |
| 2479.30 | V | 54.26 | 53.25 | 32.01 | 86.27 | 85.26 | 114.00 | 94.00 | CH16 |
| 2478.80 | H | 59.03 | 57.68 | 32.01 | 91.04 | 89.69 | 114.00 | 94.00 | CH16 |

Remark :

- (1) All readings are Peak unless otherwise stated QP in column of 『Note』 . Peak denotes that the Peak reading compliance with the QP Limits and then QP Mode measurement didn't perform ◦
- (2) Radiated emissions measured in frequency range above 1000MHz were made with an instrument using Peak detector mode and AV detector mode of the emission ◦
- (3) Data of measurement within this frequency range shown “ * ” in the table above means the reading of emissions are attenuated more than 20dB below the permissible limits or the field strength is too small to be measured.
- (4) EUT Orthogonal Axis :
 “X” - denotes Laid on Table ; “Y” - denotes Vertical Stand ; “Z” - denotes Side Stand
- (5) During the measurements above 1 GHz it is taken care of that the EUT is always within the 3 dB cone of radiation BW of the used antenna



4.2.10 TEST RESULTS (Restricted Bands Requirements)

| | | | |
|---------------|---|---------------------|-------------|
| EUT : | Wireless Laser Mouse | Model Name. : | L213 3D3+1B |
| Temperature : | 29 °C | Relative Humidity : | 50 % |
| Pressure : | 1008 hPa | Test Power : | DC 3.0V |
| Test Mode : | TX CH 2402MHz/2479MHz(Vertical) | | |
| Note : | <p>The emission of the carrier radiated field strength is measured for (Peak and AV) as following:</p> <ol style="list-style-type: none"> 1. The transmitter was then configured with the worst case antenna and setup to transmit at the lowest channel (CH01). Then the field strength was measured at 2310-2390 MHz. 2. The transmitter was configured with the worst case antenna and setup to transmit at the highest channel (CH16). Then the field strength was measured at 2483.5-2500 MHz. | | |

| Freq. (MHz) | Ant.Pol. H/V | Reading | | Ant./CF CF(dB) | Act. | | Limit | | Note |
|----------------|-----------------|----------------|--------------|-------------------|------------------|----------------|------------------|----------------|------|
| | | Peak (dBuV) | AV (dBuV) | | Peak (dBuV/m) | AV (dBuV/m) | Peak (dBuV/m) | AV (dBuV/m) | |
| 2390.00 | V | 28.85 | 18.64 | 31.75 | 60.60 | 50.39 | 74.00 | 54.00 | CH01 |
| 2483.50 | V | 28.78 | 18.74 | 32.03 | 60.81 | 50.77 | 74.00 | 54.00 | CH16 |

Remark :

- (1) Radiated emissions measured in frequency range above 1000MHz were made with an instrument using Peak detector mode and AV detector mode of the emission ◦
- (2) EUT Orthogonal Axis :
"X" - denotes Laid on Table ; "Y" - denotes Vertical Stand ; "Z" - denotes Side Stand
- (3) During the measurements above 1 GHz it is taken care of that the EUT is always within the 3 dB cone of radiation BW of the used antenna



TX CH 01 (Restricted Bands Requirements, Vertical)

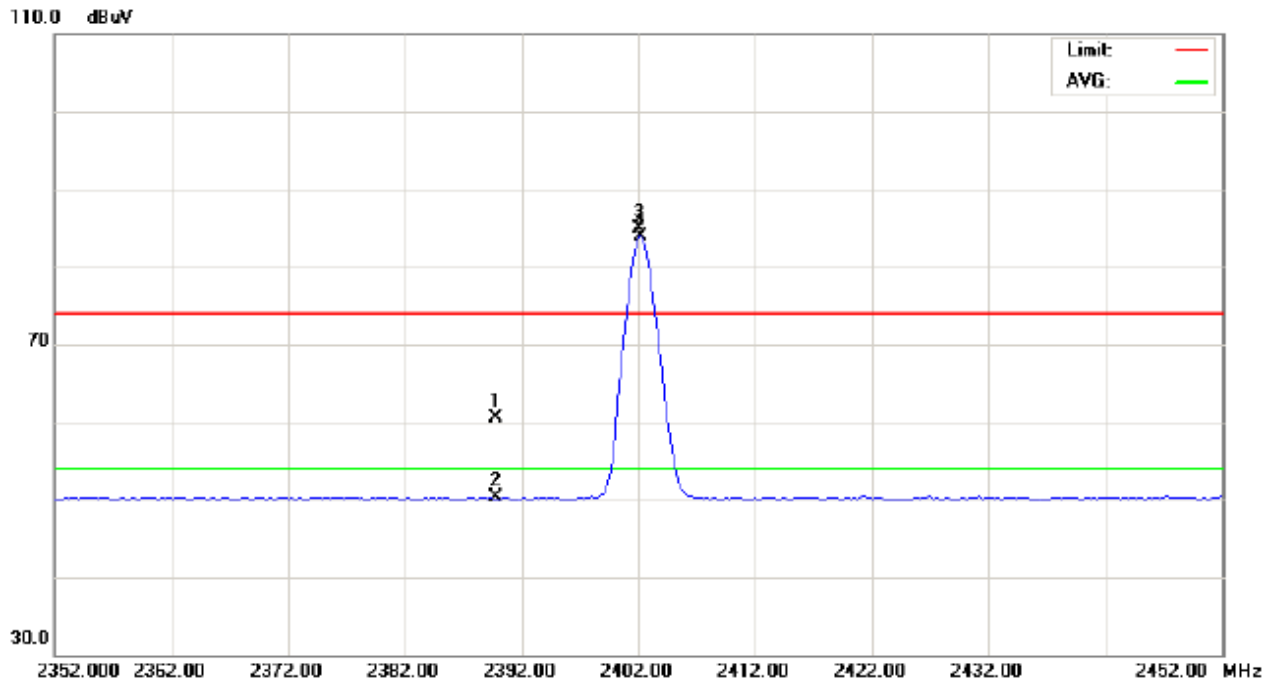

TX CH 16 (Restricted Bands Requirements, Vertical)

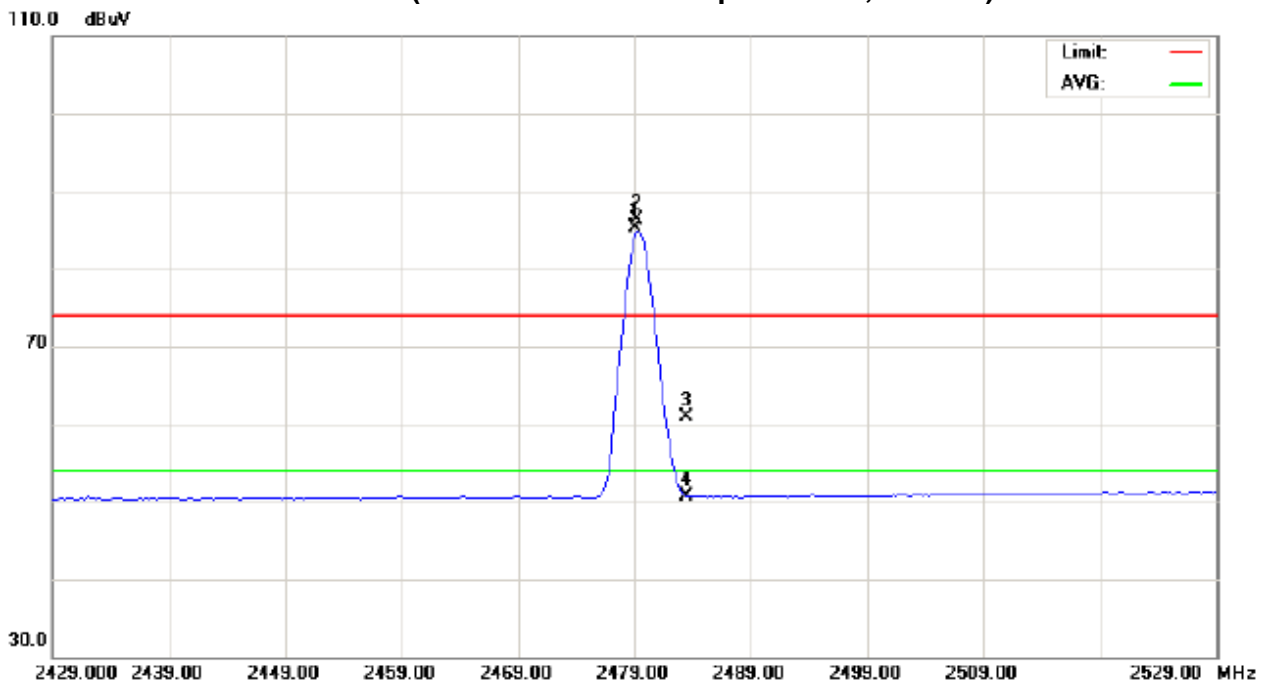



| | | | |
|---------------|---|---------------------|-------------|
| EUT : | Wireless Laser Mouse | Model Name. : | L213 3D3+1B |
| Temperature : | 29 °C | Relative Humidity : | 50 % |
| Pressure : | 1008 hPa | Test Power : | DC 3.0V |
| Test Mode : | TX CH 2402MHz/2479MHz (Horizontal) | | |
| Note : | <p>The emission of the carrier radiated field strength is measured for (Peak and AV) as following:</p> <ol style="list-style-type: none"> 1. The transmitter was then configured with the worst case antenna and setup to transmit at the lowest channel (CH01). Then the field strength was measured at 2310-2390 MHz. 2. The transmitter was configured with the worst case antenna and setup to transmit at the highest channel (CH16). Then the field strength was measured at 2483.5-2500 MHz. | | |

| Freq. (MHz) | Ant.Pol. H/V | Reading | | Ant./CF CF(dB) | Act. | | Limit | | Note |
|----------------|-----------------|----------------|--------------|-------------------|------------------|----------------|------------------|----------------|------|
| | | Peak (dBuV) | AV (dBuV) | | Peak (dBuV/m) | AV (dBuV/m) | Peak (dBuV/m) | AV (dBuV/m) | |
| 2390.00 | H | 27.34 | 18.16 | 31.75 | 59.09 | 49.91 | 74.00 | 54.00 | CH01 |
| 2483.50 | H | 28.94 | 19.26 | 32.03 | 60.97 | 51.29 | 74.00 | 54.00 | CH16 |

Remark :

- (1) Radiated emissions measured in frequency range above 1000MHz were made with an instrument using Peak detector mode and AV detector mode of the emission ◦
- (2) EUT Orthogonal Axis :
"X" - denotes Laid on Table ; "Y" - denotes Vertical Stand ; "Z" - denotes Side Stand
- (3) During the measurements above 1 GHz it is taken care of that the EUT is always within the 3 dB cone of radiation BW of the used antenna



TX CH01 (Restricted Bands Requirements, Horizontal)

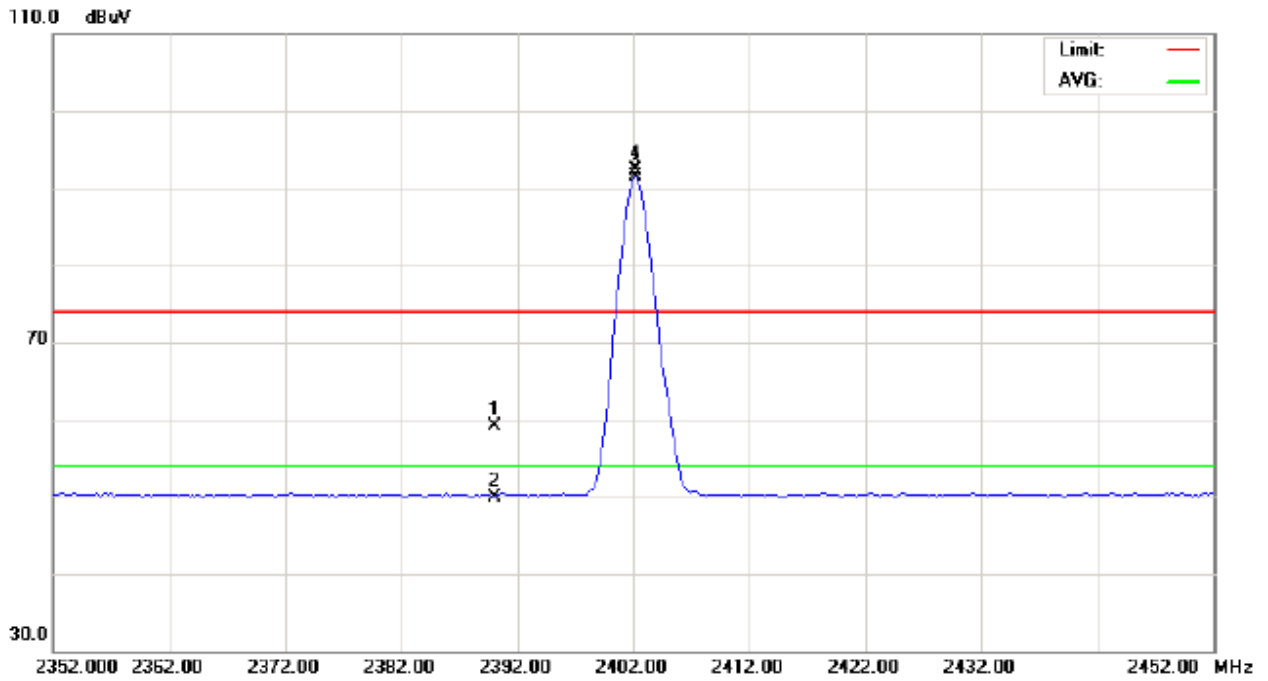

TX CH16 (Restricted Bands Requirements, Horizontal)

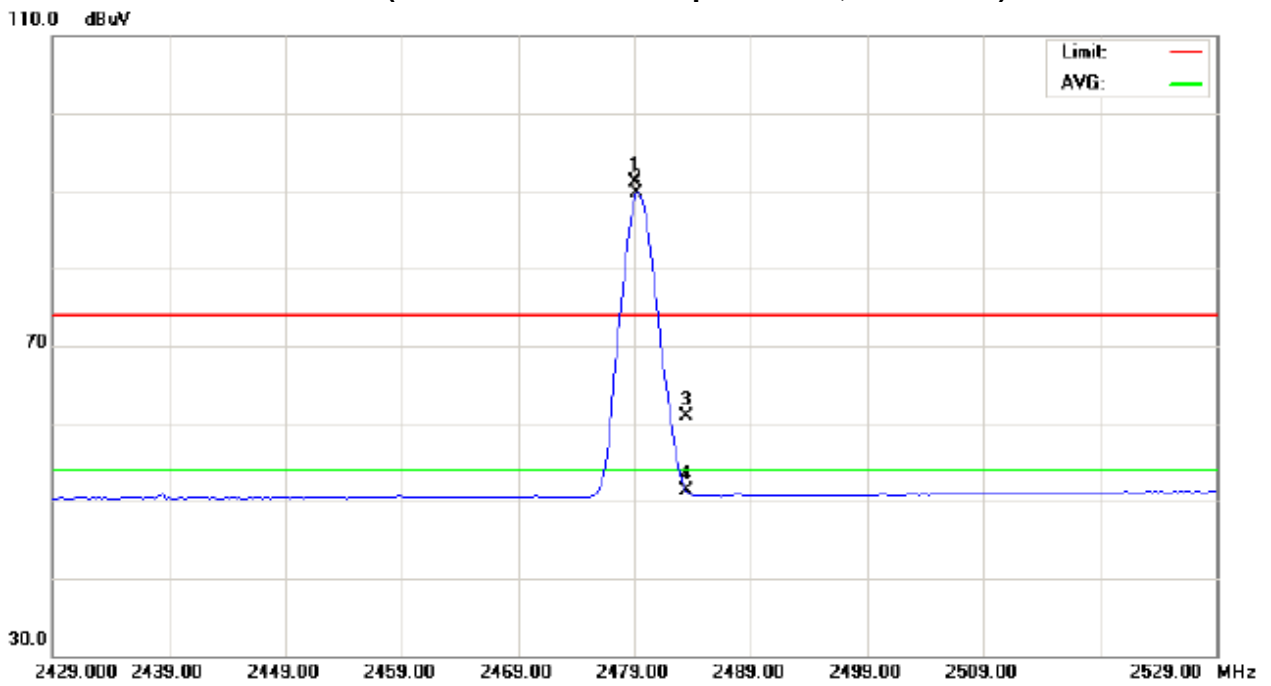



5. BANDWIDTH TEST

5.1 MEASUREMENT INSTRUMENTS LIST

| Item | Kind of Equipment | Manufacturer | Type No. | Serial No. | Calibrated until |
|------|-------------------|--------------|----------|------------|------------------|
| 1 | Spectrum Analyzer | R&S | FSP_40 | 100129 | Jan. 06, 2010 |

Remark: " N/A" denotes No Model Name. , Serial No. or No Calibration specified.

5.2 TEST PROCEDURE

- a. The EUT was directly connected to the spectrum analyzer and antenna output port as show in the block diagram below,
- b. Spectrum Setting : RBW= 100KHz, VBW=100KHz, Sweep time = 2.5 ms.

5.3 DEVIATION FROM STANDARD

No deviation.

5.4 TEST SETUP



5.5 EUT OPERATION CONDITIONS

The EUT tested system was configured as the statements of 4.1.6 Unless otherwise a special operating condition is specified in the follows during the testing.



5.6 TEST RESULTS

| | | | |
|---------------|----------------------|---------------------|-------------|
| EUT : | Wireless Laser Mouse | Model Name. : | L213 3D3+1B |
| Temperature : | 29 °C | Relative Humidity : | 50 % |
| Pressure : | 1008 hPa | Test Power : | DC 3.0V |
| Test Mode : | TX CH 01/08/16 | | |

| Test Channel | Frequency (MHz) | 20 dBc Bandwidth (MHz) | 99% occupied Bandwidth(MHz) |
|--------------|-----------------|------------------------|-----------------------------|
| CH01 | 2402 | 1.260 | 1.080 |
| CH08 | 2439 | 1.240 | 1.080 |
| CH16 | 2479 | 1.270 | 1.110 |

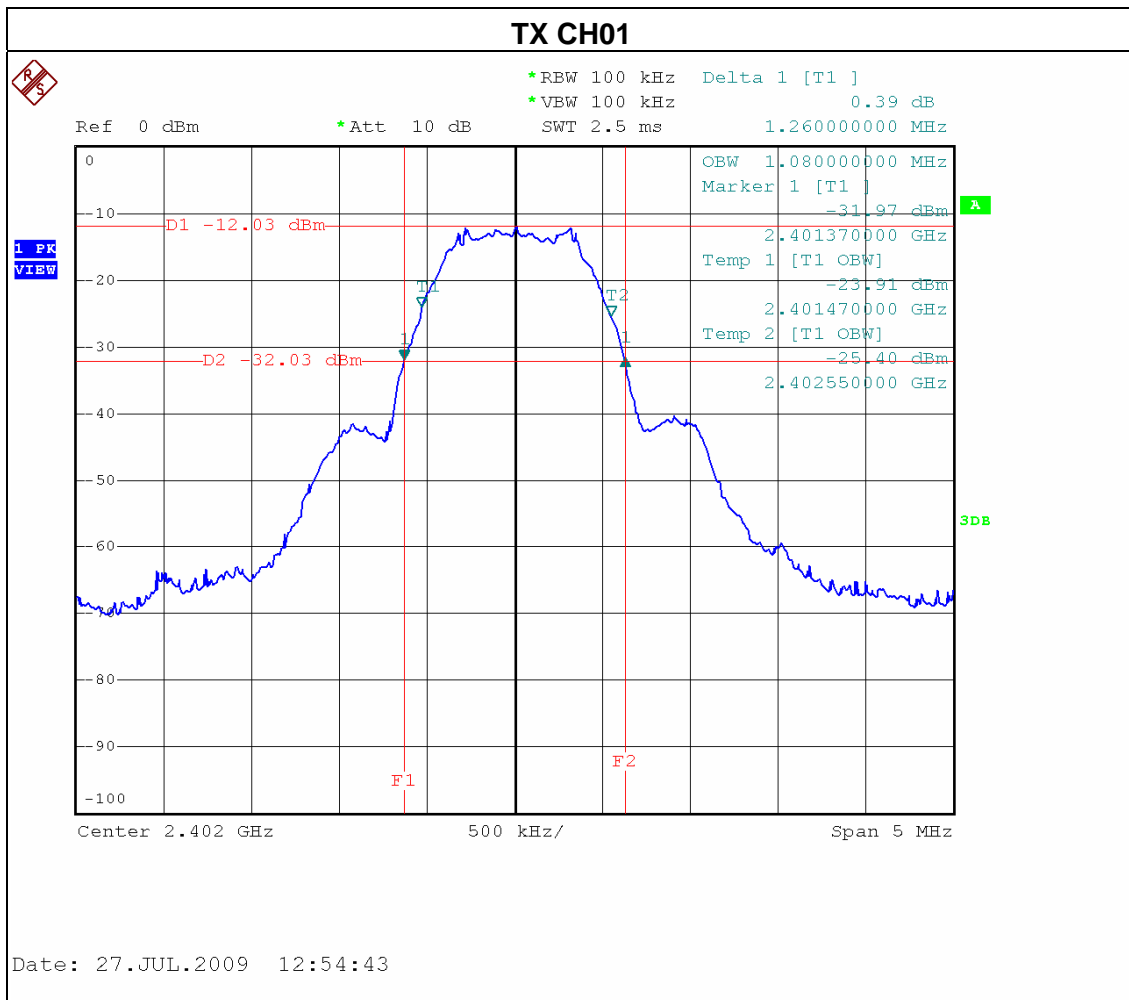



TX CH 08

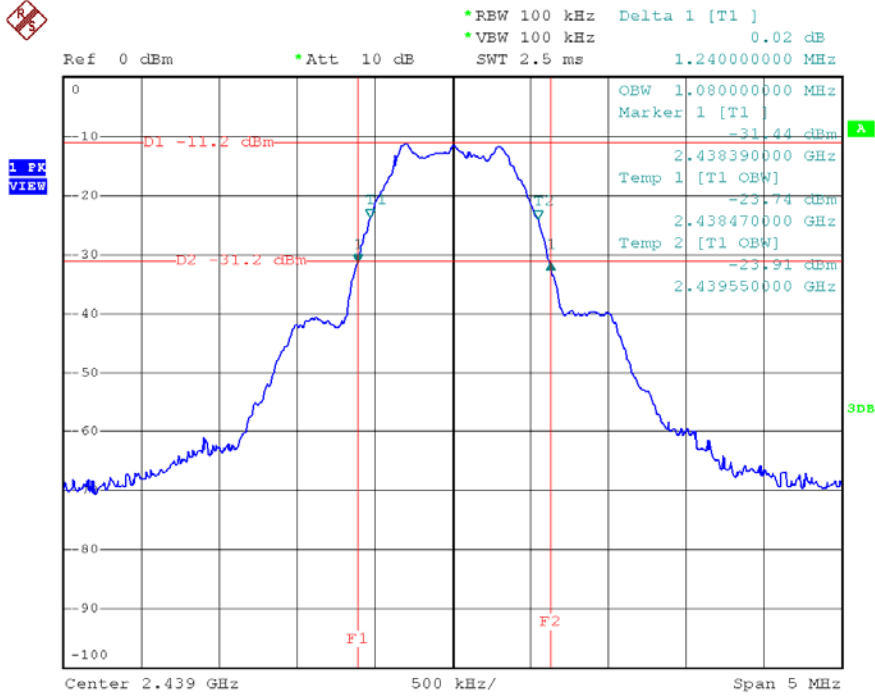

Date: 27.JUL.2009 12:55:44

TX CH 16

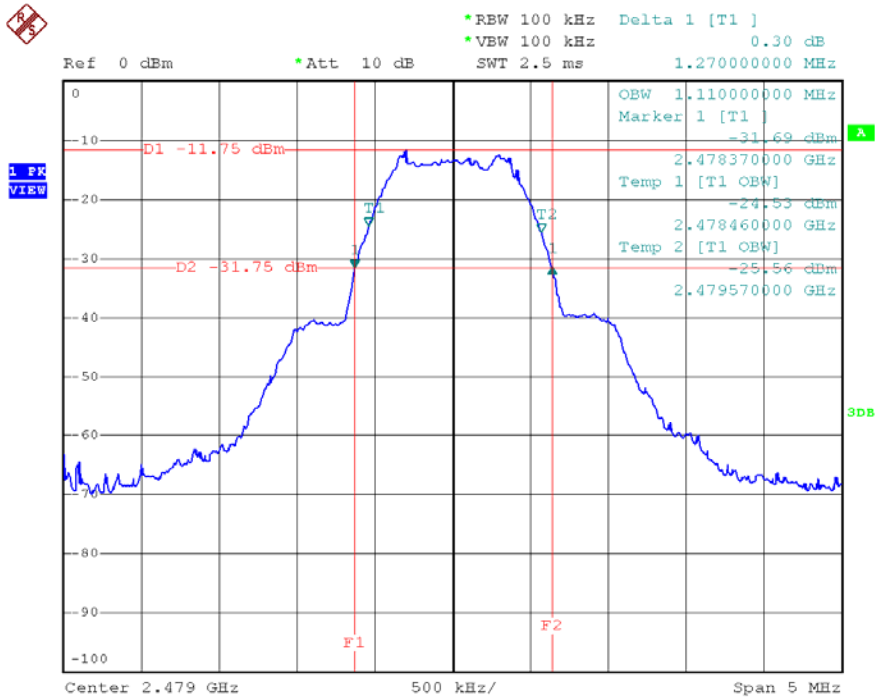

Date: 27.JUL.2009 12:52:47



6. ANTENNA CONDUCTED SPURIOUS EMISSION

6.1 APPLIED PROCEDURES / LIMIT

20dBc in any 100 kHz bandwidth outside the operating frequency band. In case the emission fall within the restricted band specified on 15.205(a), then the 15.209(a) limit in the table below has to be followed.

| Frequencies (MHz) | Field Strength (micorvolts/meter) | Measurement Distance (meters) |
|-------------------|-----------------------------------|-------------------------------|
| 0.009~0.490 | 2400/F(KHz) | 300 |
| 0.490~1.705 | 24000/F(KHz) | 30 |
| 1.705~30.0 | 30 | 30 |
| 30~88 | 100 | 3 |
| 88~216 | 150 | 3 |
| 216~960 | 200 | 3 |
| Above 960 | 500 | 3 |

6.1.1 MEASUREMENT INSTRUMENTS LIST

| Item | Kind of Equipment | Manufacturer | Type No. | Serial No. | Calibrated until |
|------|-------------------|--------------|----------|------------|------------------|
| 8 | Spectrum Analyzer | R&S | FSP_40 | 100129 | Jan. 06, 2010 |

Remark: " N/A" denotes No Model Name. , Serial No. or No Calibration specified.

The following table is the setting of the spectrum analyzer.

| Spectrum Parameter | Setting |
|---------------------------------------|--|
| Attenuation | Auto |
| Span Frequency | 100 MHz |
| RB / VB (emission in restricted band) | 1MHz / 1MHz for Peak, 1 MHz / 10Hz for Average |
| RB / VB (other emission) | 100 KHz /100 KHz for Peak |

6.1.2 TEST PROCEDURE

- a. The EUT was directly connected to the spectrum analyzer and antenna output port as show in the block diagram below,
- b. Spectrum Setting : RBW= 100KHz, VBW=100KHz, Sweep time = 10 ms.

6.1.3 DEVIATION FROM STANDARD

No deviation.

6.1.4 TEST SETUP

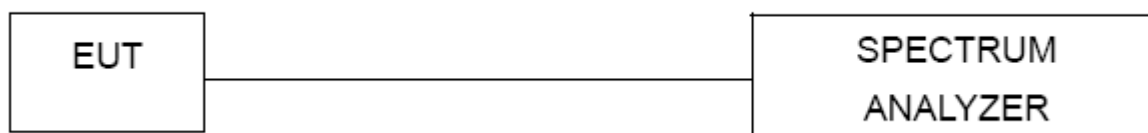



6.1.5 EUT OPERATION CONDITIONS

The EUT tested system was configured as the statements of 4.1.6 Unless otherwise a special operating condition is specified in the follows during the testing.



6.1.6 TEST RESULTS

| | | | |
|---------------|----------------------|---------------------|-------------|
| EUT : | Wireless Laser Mouse | Model Name. : | L213 3D3+1B |
| Temperature : | 27°C | Relative Humidity : | 50 % |
| Pressure : | 1008 hPa | Test Power : | DC 3.0V |
| Test Mode : | TX CH01, CH16 | | |

| Channel of Worst Data: CH01 | | | |
|---|------------|--|------------|
| The max. radio frequency power in any 100kHz bandwidth outside the frequency band | | The max. radio frequency power in any 100 kHz bandwidth within the frequency band. | |
| FREQUENCY(MHz) | POWER(dBm) | FREQUENCY(MHz) | POWER(dBm) |
| 2354.80 | -72.44 | 2491.20 | -72.13 |
| Result | | | |
| In any 100kHz bandwidth outside the frequency band, the radio frequency power is at least 50dB below that in the 100kHz bandwidth within the band that contains the highest level of the desired power. | | | |

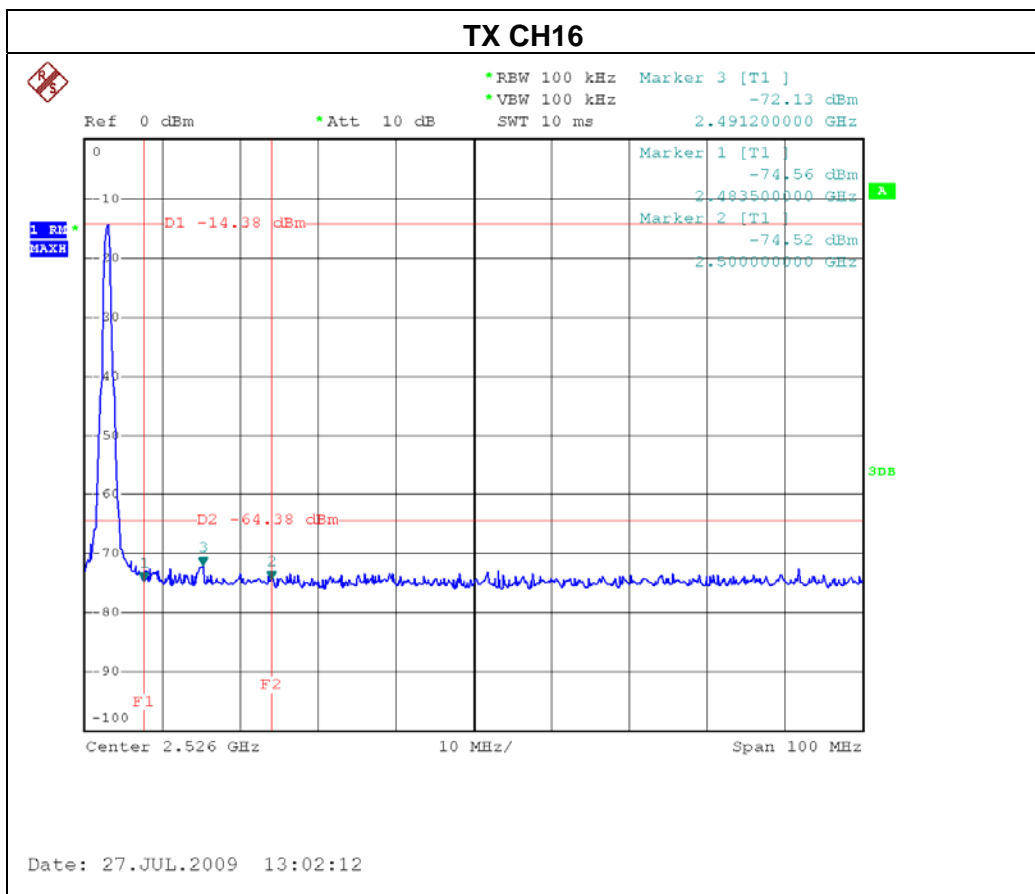
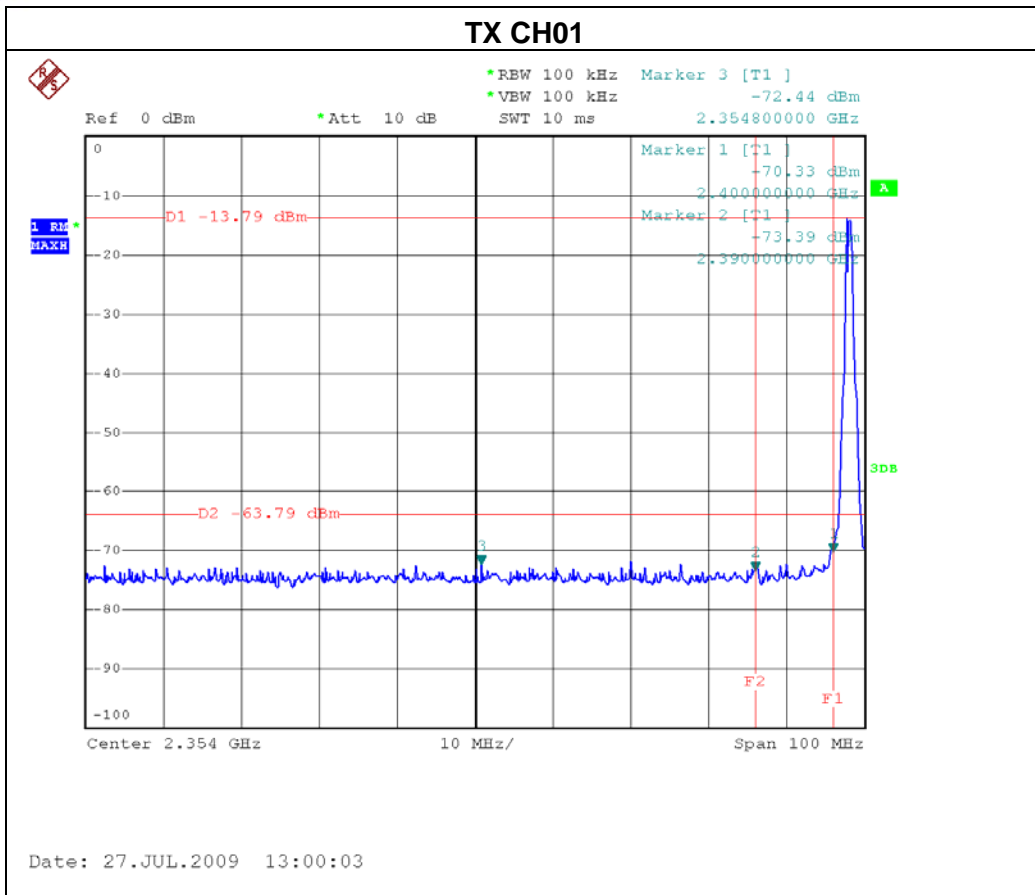



7. EUT TEST PHOTO

Radiated Measurement Photos

