

# FCC Radio TEST Report

## FCC ID: P5A-CL0007

This report concerns (check one) :  Original Grant  Class I Change

Issued Date : Feb. 27, 2008

Project No. : 0802C019

Equipment : Wireless Mouse

Model Name : L180

Applicant : Areson Technology Corporation

Address : 12F, No.111-6, Hsing-De Rd., San Chung,  
Taipei Hsien, Taiwan, R.O.C

**Tested by:**

Neutron Engineering Inc. EMC Laboratory

**Date of Test:**

Feb. 19, 2008 ~ Feb. 26, 2008

Testing Engineer :

  
\_\_\_\_\_  
(Tandy Hung)

Technical Manager :

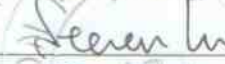
  
\_\_\_\_\_  
(Steven Lu)

Authorized Signatory :

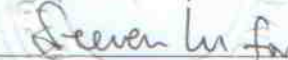
  
\_\_\_\_\_  
(Vrc Chiu)

### NEUTRON ENGINEERING INC.

No. 132-1, Lane 329, Sec. 2, Palain Rd.,  
Shijr City, Taipei, Taiwan

TEL : (02) 2646-5426 FAX : (02) 2646-6815



**Declaration**

**Neutron** represents to the client that testing is done in accordance with standard procedures as applicable and that test instruments used has been calibrated with the standards traceable to National Measurement Laboratory (**NML**) of **R.O.C.**, or National Institute of Standards and Technology (**NIST**) of **U.S.A.**

**Neutron's** reports apply only to the specific samples tested under conditions. It is manufacture's responsibility to ensure that additional production units of this model are manufactured with the identical electrical and mechanical components. **Neutron** shall have no liability for any declarations, inferences or generalizations drawn by the client or others from **Neutron** issued reports.

**Neutron's** reports must not be used by the client to claim product endorsement by the authorities or any agency of the Government.

This report is the confidential property of the client. As a mutual protection to the clients, the public and **Neutron-self**, extracts from the test report shall not be reproduced except in full with **Neutron's** authorized written approval.

**Neutron's** laboratory quality assurance procedures are in compliance with the **ISO Guide 17025** requirements, and accredited by the conformity assessment authorities listed in this test report.

**Limitation**

For the use of the authority's logo is limited unless the Test Standard(s)/Scope(s)/Item(s) mentioned in this test report is (are) included in the conformity assessment authorities acceptance respective.

<b>Table of Contents</b>	<b>Page</b>
1 . CERTIFICATION	5
2 . SUMMARY OF TEST RESULTS	6
2.1 TEST FACILITY	7
2.2 MEASUREMENT UNCERTAINTY	7
3 . GENERAL INFORMATION	8
3.1 GENERAL DESCRIPTION OF EUT	8
3.2 DESCRIPTION OF TEST MODES	10
3.3 BLOCK DIGRAM SHOWING THE CONFIGURATION OF SYSTEM TESTED	11
3.4 DESCRIPTION OF SUPPORT UNITS	12
4 . EMC EMISSION TEST	13
4.1 CONDUCTED EMISSION MEASUREMENT	13
4.1.1 POWER LINE CONDUCTED EMISSION LIMITS	13
4.1.2 MEASUREMENT INSTRUMENTS LIST	13
4.1.3 TEST PROCEDURE	14
4.1.4 DEVIATION FROM TEST STANDARD	14
4.1.5 TEST SETUP	14
4.1.6 EUT OPERATING CONDITIONS	15
4.1.7 TEST RESULTS	16
4.2 RADIATED EMISSION MEASUREMENT	17
4.2.1 RADIATED EMISSION LIMITS	17
4.2.2 MEASUREMENT INSTRUMENTS LIST	18
4.2.3 TEST PROCEDURE	19
4.2.4 DEVIATION FROM TEST STANDARD	19
4.2.5 TEST SETUP	20
4.2.6 EUT OPERATING CONDITIONS	20
4.2.7 TEST RESULTS (BETWEEN 30 – 1000 MHz)	21
4.2.8 TEST RESULTS (ABOVE 1000 MHz)	23
4.2.9 TEST RESULTS (2400 – 2483.5 MHz)	35
4.2.10 TEST RESULTS (Restricted Bands Requirements)	36
5 . BANDWIDTH TEST	40
5.1 MEASUREMENT INSTRUMENTS LIST	40
5.2 TEST PROCEDURE	40
5.3 DEVIATION FROM STANDARD	40
5.4 TEST SETUP	40
5.5 EUT OPERATION CONDITIONS	40
5.6 TEST RESULTS	41

<b>Table of Contents</b>	<b>Page</b>
6 . ANTENNA CONDUCTED SPURIOUS EMISSION	43
6.1 APPLIED PROCEDURES / LIMIT	43
6.1.1 MEASUREMENT INSTRUMENTS LIST	43
6.1.2 TEST PROCEDURE	43
6.1.3 DEVIATION FROM STANDARD	43
6.1.4 TEST SETUP	43
6.1.5 EUT OPERATION CONDITIONS	44
6.1.6 TEST RESULTS	45
7 . EUT TEST PHOTO	47
Radiated Measurement Photos	47

## 1. CERTIFICATION

Equipment: Wireless Mouse

Trade Name : N/A

Model Name. : L180

Applicant: Areson Technology Corporation

Date of Test: Feb. 19, 2008 ~ Feb. 26, 2008

Test Item: ENGINEERING SAMPLE

Standards: FCC Part15, Subpart C(15.249)/ ANCI C63.4 : 2003

The above equipment has been tested and found compliance with the requirement of the relative standards by Neutron Engineering Inc. EMC Laboratory.

The test data, data evaluation, and equipment configuration contained in our test report (Ref No. NEI-FCCP-1-0802C019) were obtained utilizing the test procedures, test instruments, test sites that has been accredited by the Authority of NVLAP and TAF according to the ISO-17025 quality assessment standard and technical standard(s).

**Test result included in this report is only for the Mouse part of the product.**

## 2. SUMMARY OF TEST RESULTS

Test procedures according to the technical standards:

FCC Part15, Subpart C (15.249)			
Standard Section	Test Item	Judgment	Remark
15.207	Conducted Emission	-	N/A
15.249	Radiated Spurious Emission	PASS	

**NOTE:**

(1) "N/A" denotes test is not applicable in this Test Report

2.1 TEST FACILITY

The test facilities used to collect the test data in this report is **C01/OS02** at the location of No.132-1, Lane 329, Sec. 2, Palain Road, Shijr City, Taipei, Taiwan.

Neutron's test firm number is 95335

2.2 MEASUREMENT UNCERTAINTY

The reported uncertainty of measurement  $y \pm U$ , where expended uncertainty **U** is based on a standard uncertainty multiplied by a coverage factor of **k=2**, providing a level of confidence of approximately **95 %**.

A. Conducted Measurement :

Test Site	Method	Measurement Frequency Range	U , (dB)	NOTE
C01	ANSI	150 KHz ~ 30MHz	1.94	

B. Radiated Measurement :

Test Site	Method	Measurement Frequency Range	Ant. H / V	U , (dB)	NOTE
OS-01	ANSI	30MHz ~ 200MHz	V	3.82	
		30MHz ~ 200MHz	H	3.60	
		200MHz ~ 1,000MHz	V	3.86	
		200MHz ~ 1,000MHz	H	3.94	
OS-02	ANSI	30MHz ~ 200MHz	V	2.48	
		30MHz ~ 200MHz	H	2.16	
		200MHz ~ 1,000MHz	V	2.50	
		200MHz ~ 1,000MHz	H	2.66	

### 3. GENERAL INFORMATION

#### 3.1 GENERAL DESCRIPTION OF EUT

Equipment	Wireless Mouse	
Trade Name	N/A	
Model Name.	L180	
OEM Brand/Model Name	N/A	
Model Difference	N/A	
Product Description	The EUT is a Wireless Mouse.	
	Product Type	Low Power Communication Device
	Operation Frequency:	2402~2479 MHz
	Modulation Type:	GFSK
	Number Of Channel	16CH
	Antenna Designation:	Printed antenna
	Antenna Gain(Peak)	6.61 dBi (Mouse)
	Output Power:	91.19 dBuV/m (AV Max.)
Based on the application, features, or specification exhibited in User's Manual, the EUT is considered as an ITE/Computing Device. More details of EUT technical specification, please refer to the User's Manual.		
Channel List	Please refer to the Note 2.	
Power Source	DC Voltage supplied from 2*AAA size Battery	
Power Rating	DC 3V	
Connecting I/O Port(s)	Please refer to the User's Manual	

Note:

1. For a more detailed features description, please refer to the manufacturer's specifications or the User's Manual.



2.

Frequency Band	Channel No.	Frequency
2400~2483.5MHz	1	2402 MHz
	2	2405 MHz
	3	2408 MHz
	4	2411 MHz
	5	2425 MHz
	6	2433 MHz
	7	2435 MHz
	8	2439 MHz
	9	2447 MHz
	10	2450 MHz
	11	2462 MHz
	12	2465 MHz
	13	2468 MHz
	14	2471 MHz
	15	2476 MHz
	16	2479 MHz

3. Table for Filed Antenna

Ant.	Brand	Model Name	Antenna Type	Connector	Gain (dBi)
1	-	-	Printed Antenna	N/A	6.61

### 3.2 DESCRIPTION OF TEST MODES

To investigate the maximum EMI emission characteristics generated from EUT, the test system was pre-scanning tested based on the consideration of following EUT operation mode or test configuration mode which possible have effect on EMI emission level. Each of these EUT operation mode(s) or test configuration mode(s) mentioned above was evaluated respectively.

Pretest Mode	Description
Mode 1	CH Lower - 2402MHz
Mode 2	CH Middle - 2439MHz
Mode 3	CH Highest -2479MHz

For Conducted Test	
Final Test Mode	Description
	" N/A" denotes test is not applicable in this Test Report

For Radiated Test	
Final Test Mode	Description
Mode 1	CH Lower - 2402MHz
Mode 2	CH Middle - 2439MHz
Mode 3	CH Highest -2479MHz

Note:

- (1) The Mouse used the new battery

3.3 BLOCK DIGRAM SHOWING THE CONFIGURATION OF SYSTEM TESTED

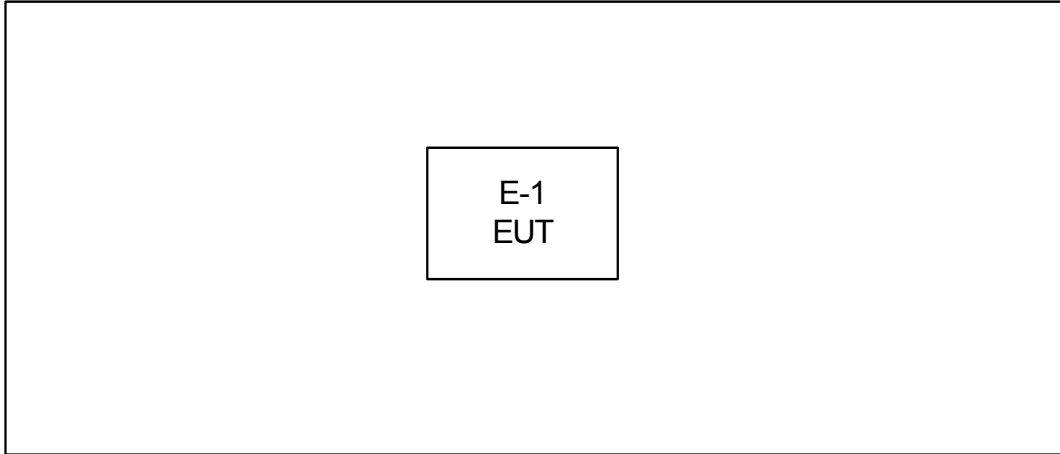

**3.4 DESCRIPTION OF SUPPORT UNITS**

The EUT has been tested as an independent unit together with other necessary accessories or support units. The following support units or accessories were used to form a representative test configuration during the tests.

Item	Equipment	Mfr/Brand	Model/Type No.	FCC ID	Series No.	Note
E-1	Wireless Mouse	N/A	L180	P5A-CL0007	N/A	EUT

Item	Shielded Type	Ferrite Core	Length	Note

**Note:**

- (1) The support equipment was authorized by Declaration of Confirmation.
- (2) For detachable type I/O cable should be specified the length in cm in 『Length』 column.

**4. EMC EMISSION TEST**

**4.1 CONDUCTED EMISSION MEASUREMENT**

**4.1.1 POWER LINE CONDUCTED EMISSION LIMITS (Frequency Range 150KHz-30MHz)**

FREQUENCY (MHz)	Class A (dBuV)		Class B (dBuV)		Standard
	Quasi-peak	Average	Quasi-peak	Average	
0.15 -0.5	79.00	66.00	66 - 56 *	56 - 46 *	CISPR
0.50 -5.0	73.00	60.00	56.00	46.00	CISPR
5.0 -30.0	73.00	60.00	60.00	50.00	CISPR

0.15 -0.5	79.00	66.00	66 - 56 *	56 - 46 *	FCC
0.50 -5.0	73.00	60.00	56.00	46.00	FCC
5.0 -30.0	73.00	60.00	60.00	50.00	FCC

Note:

- (1) The tighter limit applies at the band edges.
- (2) The limit of " \* " marked band means the limitation decreases linearly with the logarithm of the frequency in the range.

**4.1.2 MEASUREMENT INSTRUMENTS LIST**

Item	Kind of Equipment	Manufacturer	Type No.	Serial No.	Calibrated until
1	LISN	EMCO	3816/2	00042991	Jan. 24, 2009
2	LISN	EMCO	3816/2	00042990	Jan. 24, 2009
3	Pulse Limiter	Electro-Metrics	EM-7600	112644	Nov. 27, 2008
4	50Ω Terminator	N/A	N/A	N/A	May.13, 2009
5	Test Cable	N/A	C01	N/A	Nov. 27, 2008
6	EMI Test Receiver	R&S	ESCI	100082	Mar. 08, 2008

Remark: " N/A" denotes No Model Name. , Serial No. or No Calibration specified.

The following table is the setting of the receiver

Receiver Parameters	Setting
Attenuation	10 dB
Start Frequency	0.15 MHz
Stop Frequency	30 MHz
IF Bandwidth	9 kHz

4.1.3 TEST PROCEDURE

- a. The EUT was placed 0.4 meters from the horizontal ground plane with EUT being connected to the power mains through a line impedance stabilization network (LISN). All other support equipments powered from additional LISN(s). The LISN provide 50 Ohm/ 50uH of coupling impedance for the measuring instrument.
- b. Interconnecting cables that hang closer than 40 cm to the ground plane shall be folded back and forth in the center forming a bundle 30 to 40 cm long.
- c. I/O cables that are not connected to a peripheral shall be bundled in the center. The end of the cable may be terminated, if required, using the correct terminating impedance. The overall length shall not exceed 1 m.
- d. LISN at least 80 cm from nearest part of EUT chassis.
- e. For the actual test configuration, please refer to the related Item –EUT Test Photos.

4.1.4 DEVIATION FROM TEST STANDARD

No deviation

4.1.5 TEST SETUP

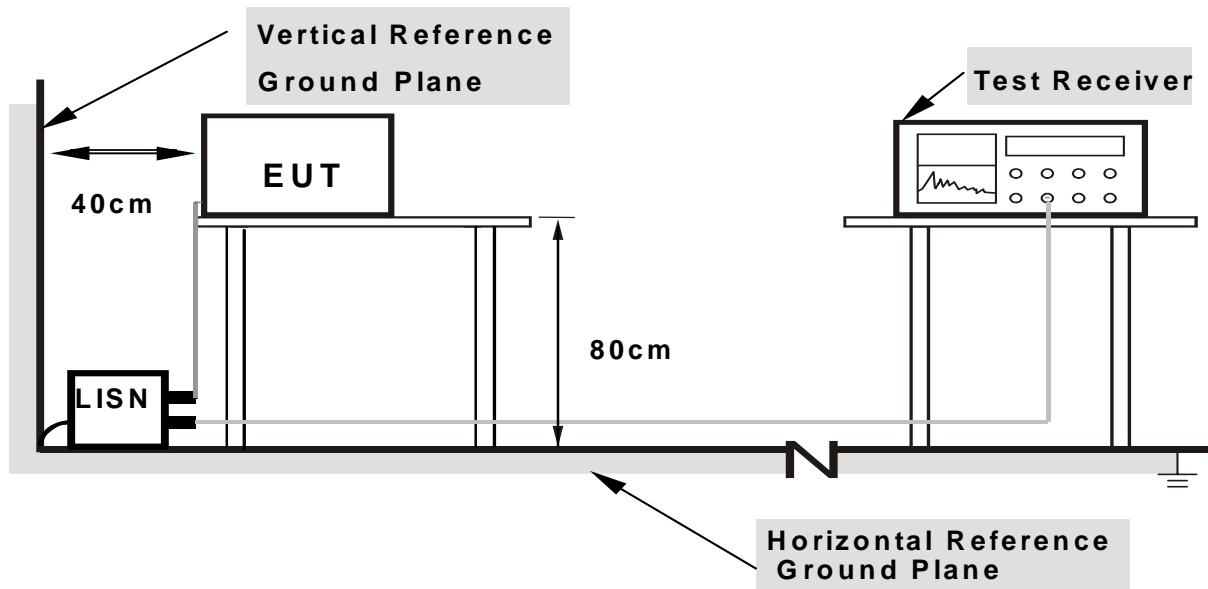

- Note: 1. Support units were connected to second LISN.**  
**2. Both of LISNs (AMN) are 80 cm from EUT and at least 80 cm from other units and other metal planes**

#### 4.1.6 EUT OPERATING CONDITIONS

The EUT was configured for testing in a typical fashion (as a customer would normally use it). The EUT has been programmed to continuously transmit during test. This operating condition was tested and used to collect the included data.

4.1.7 TEST RESULTS

EUT :	Wireless Mouse	Model Name. :	L180
Temperature :	20 °C	Relative Humidity :	60 %
Pressure :	1010 hPa	Test Power :	DC 3V
Test Mode :	(3) "N/A" denotes test is not applicable in this Test Report		

Remark

- (1) All readings are QP Mode value unless otherwise stated AVG in column of Note. If the QP Mode Measured value compliance with the QP Limits and lower than AVG Limits, the EUT shall be deemed to meet both QP & AVG Limits and then only QP Mode was measured, but AVG Mode didn't perform. In this case, a "\*" marked in AVG Mode column of Interference Voltage Measured.
- (2) Measuring frequency range from 150KHz to 30MHz.
- (3) "N/A" denotes test is not applicable in this Test Report



**4.2 RADIATED EMISSION MEASUREMENT**

**4.2.1 RADIATED EMISSION LIMITS ( FCC 15.209 )**

<b>requecies (MHz)</b>	<b>Field Strength (microvolts/meter)</b>	<b>Measurement Distance (meters)</b>
0.009~0.490	2400/F(KHz)	300
0.490~1.705	24000/F(KHz)	30
1.705~30.0	30	30
30~88	100	3
88~216	150	3
216~960	200	3
Above 960	500	3

Harmonic emissions limits comply with below 54 dBuV/m at 3m. Other emissions radiated outside of the specified frequency bands, except for harmonics, shall be attenuated by at least 50 dB below the level of the fundamental or comply with the radiated emissions limits specified in section 15.209(a) limit in the table below has to be followed.

Note:

- (1) The tighter limit applies at the band edges.
- (2) Emission level (dBuV/m)=20log Emission level (uV/m).

**LIMITS OF RADIATED EMISSION MEASUREMENT ( FCC 15.209 )**

<b>FREQUENCY (MHz)</b>	<b>Class A (dBuV/m) (at 3m)</b>		<b>Class B (dBuV/m) (at 3m)</b>	
	<b>PEAK</b>	<b>AVERAGE</b>	<b>PEAK</b>	<b>AVERAGE</b>
Above 1000	80	60	74	54

Notes:

- (1) The limit for radiated test was performed according to FCC PART 15B.
- (2) The tighter limit applies at the band edges.
- (3) Emission level (dBuV/m)=20log Emission level (uV/m).

**LIMITS OF RADIATED EMISSION MEASUREMENT (FCC Part 15.249)**

<b>FCC Part15 (15.249) , Subpart C</b>	
<b>Limit</b>	<b>Frequency Range (MHz)</b>
Field strength of fundamental 50000 μV/m (94 dBμV/m) @ 3 m	2400-2483.5
Field strength of harmonics 500 μV/m (54 dBμV/m) @ 3 m	Above 2483.5

4.2.2 MEASUREMENT INSTRUMENTS LIST

Item	Kind of Equipment	Manufacturer	Type No.	Serial No.	Calibrated until
1	Log-Bicon Antenna	Schwarzbeck	VULB 9160	3058	Nov. 27, 2008
2	Test Cable	N/A	10M_OS02	N/A	Nov. 27, 2008
3	Test Cable	N/A	OS02-1/-2/-3	N/A	Nov. 27, 2008
4	Pre-Amplifier	Anritsu	MH648A	M09961	Nov. 27, 2008
5	EMI Test Receiver	R&S	ESCI	100082	Jan. 30, 2009
6	Antenna Mast	Chance Most	CMTB-1.5	N/A	N/A
7	Turn Table	Chance Most	CMTB-1.5	N/A	N/A
8	Spectrum Analyzer	R&S	FSP_40	100129	Jan. 07, 2009
9	Horn Antenna	Schwarzbeck	BBHA9120D	9120D-325	Oct. 24, 2008
10	Horn Antenna	Schwarzbeck	BBHA9170	9170187	Oct. 24, 2008
11	Microwave Pre_amplifier	Agilent	8449B	3008A01714	Mar. 10, 2008
12	Microflex Cable	United Microwave	57793	1m	Mar. 10, 2008
13	Microflex Cable	United Microwave	A30A30-5006	10M	Jul. 07, 2008

Remark: " N/A" denotes No Model Name. / Serial No. and No Calibration specified.

Spectrum Parameter	Setting
Attenuation	Auto
Start Frequency	1000 MHz
Stop Frequency	10th carrier harmonic
RB / VB (emission in restricted band)	1MHz / 1MHz for Peak, 1 MHz / 10Hz for Average
RB / VB (other emission)	100KHz / 100KHz for peak

Receiver Parameter	Setting
Attenuation	Auto
Start ~ Stop Frequency	9kHz~150kHz / RB 200Hz for QP
Start ~ Stop Frequency	150kHz~30MHz / RB 9kHz for QP
Start ~ Stop Frequency	30MHz~1000MHz / RB 120kHz for QP

#### 4.2.3 TEST PROCEDURE

- a. The measuring distance of at 3 m shall be used for measurements at frequency up to 1GHz. For frequencies above 1GHz, any suitable measuring distance may be used.
- b. The EUT was placed on the top of a rotating table 0.8 meters above the ground at a 3m meter open area test site. The table was rotated 360 degrees to determine the position of the highest radiation.
- c. The height of the equipment or of the substitution antenna shall be 0.8 m; the height of the test antenna shall vary between 1 m to 4 m. Both horizontal and vertical polarizations of the antenna are set to make the measurement.
- d. The initial step in collecting conducted emission data is a spectrum analyzer peak detector mode pre-scanning the measurement frequency range. Significant peaks are then marked and then Quasi Peak detector mode re-measured.
- e. If the Peak Mode measured value compliance with and lower than Quasi Peak Mode Limit, the EUT shall be deemed to meet QP Limits and then no additional QP Mode measurement performed.
- f. For the actual test configuration, please refer to the related Item –EUT Test Photos.

#### 4.2.4 DEVIATION FROM TEST STANDARD

No deviation

#### 4.2.5 TEST SETUP

(A) Radiated Emission Test Set-Up, Frequency Below 1000MHz

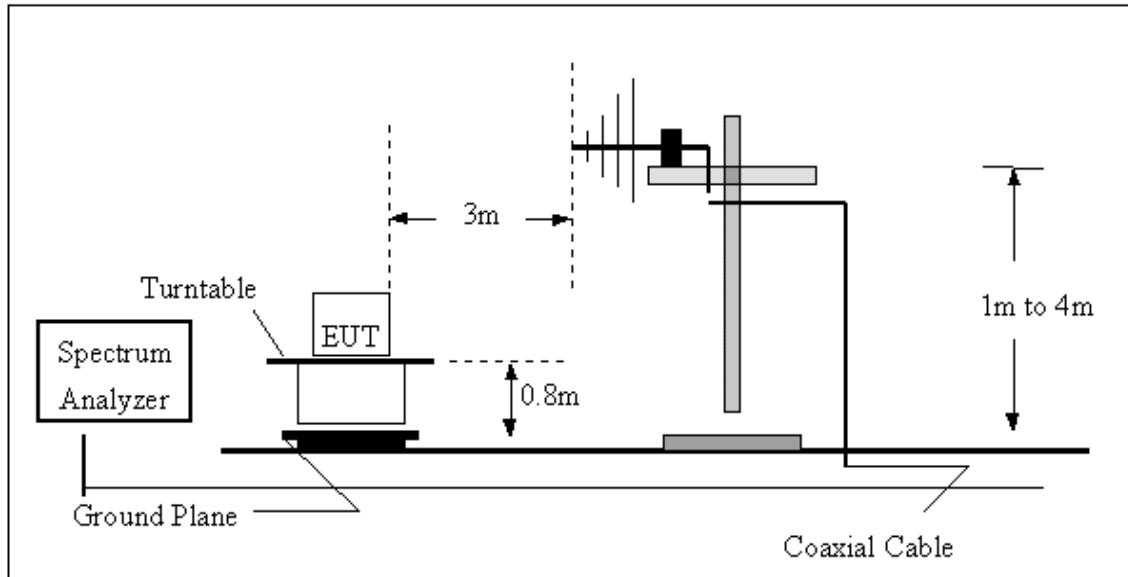

(B) Radiated Emission Test Set-Up Frequency Above 1 GHz

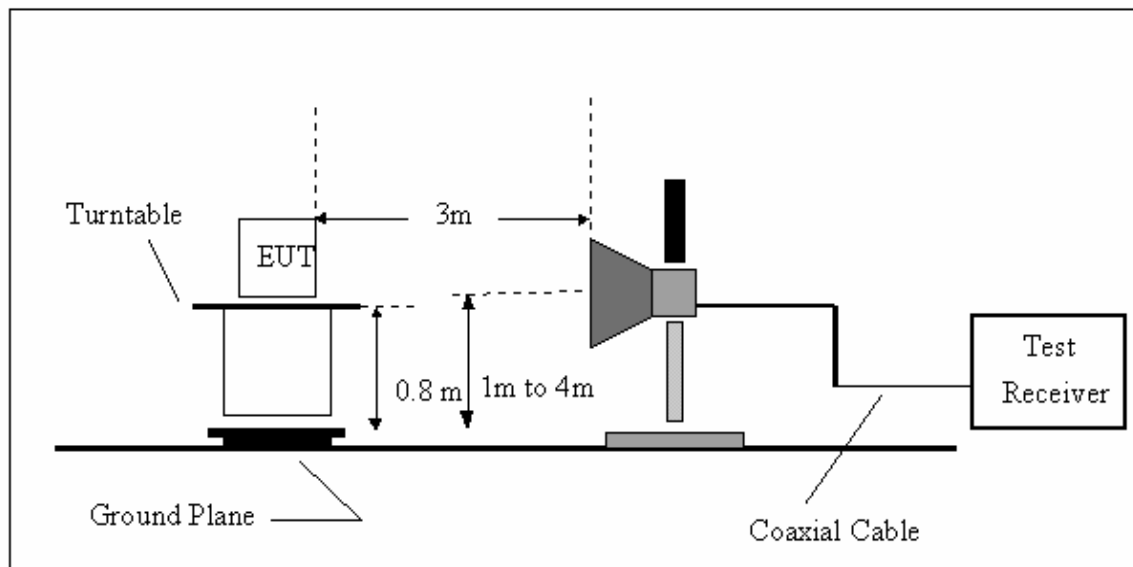

#### 4.2.6 EUT OPERATING CONDITIONS

The EUT tested system was configured as the statements of 4.1.6 Unless otherwise a special operating condition is specified in the follows during the testing.

4.2.7 TEST RESULTS (BETWEEN 30 – 1000 MHz)

EUT :	Wireless Mouse	Model Name. :	L180
Temperature :	20 °C	Relative Humidity :	60 %
Pressure :	1020hPa	Test Power :	DC 3V
Test Mode :	TX 2479MHz		

Freq. (MHz)	Ant. H/V	Reading(RA) (dBuV)	Corr.Factor(CF) (dB)	Measured(FS) (dBuV/m)	Limits(QP) (dBuV/m)	Margin (dB)	Note
42.10	V	42.31	-17.70	24.61	40.00	- 15.39	
61.03	V	44.28	-22.51	21.77	40.00	- 18.23	
95.29	V	39.06	-20.59	18.47	43.50	- 25.03	
119.36	V	42.98	-21.43	21.55	43.50	- 21.95	
154.26	V	35.29	-19.99	15.30	43.50	- 28.20	
180.23	V	40.26	-19.37	20.89	43.50	- 22.61	

Remark :

- (1) All readings are Peak unless otherwise stated QP in column of 『Note』 . Peak denotes that the Peak reading compliance with the QP Limits and then QP Mode measurement didn't perform .
- (2) Measuring frequency range from 30MHz to 1000MHz or the 10th harmonic of highest fundamental frequency . "F" denotes fundamental frequency; " H" denotes spurious frequency. "E" denotes band edge frequency.
- (3) Radiated emissions measured in frequency range from 30 MHz to 1000 MHz were made with an instrument using Peak detector mode or QP detector mode of the emission .
- (4) Data of measurement within this frequency range shown " - " in the table above means the reading of emissions are attenuated more than 20dB below the permissible limits or the field strength is too small to be measured.

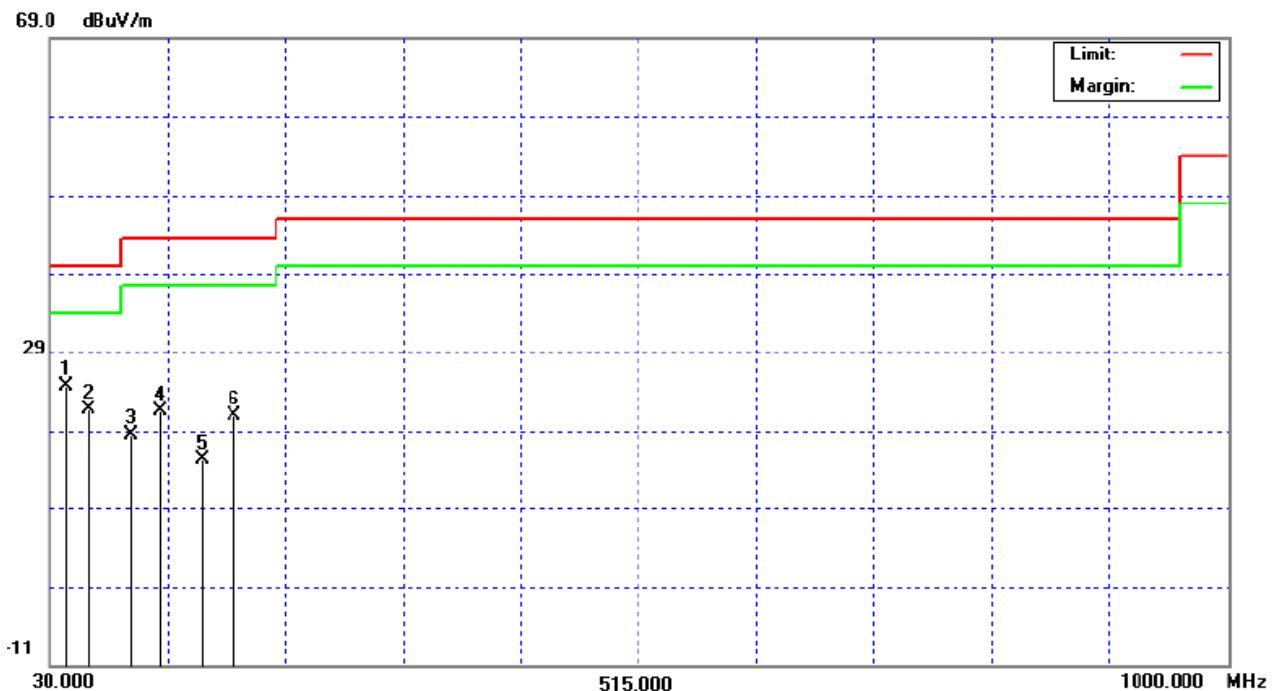

EUT :	Wireless Mouse	Model Name. :	L180
Temperature :	20 °C	Relative Humidity :	60 %
Pressure :	1020 hPa	Test Power :	DC 3V
Test Mode :	TX 2479MHz		

Freq. (MHz)	Ant. H/V	Reading(RA) (dBuV)	Corr.Factor(CF) (dB)	Measured(FS) (dBuV/m)	Limits(QP) (dBuV/m)	Margin (dB)	Note
49.20	H	35.12	-20.45	14.67	40.00	- 25.33	
62.01	H	42.29	-22.52	19.77	40.00	- 20.23	
96.20	H	33.36	-20.55	12.81	43.50	- 30.69	
108.97	H	35.41	-20.78	14.63	43.50	- 28.87	
142.52	H	31.25	-20.91	10.34	43.50	- 33.16	
154.21	H	33.12	-20.00	13.12	43.50	- 30.38	

Remark :

- (1) All readings are Peak unless otherwise stated QP in column of 『Note』 . Peak denotes that the Peak reading compliance with the QP Limits and then QP Mode measurement didn't perform .
- (2) Measuring frequency range from 30MHz to 1000MHz or the 10th harmonic of highest fundamental frequency . "F" denotes fundamental frequency; " H" denotes spurious frequency. "E" denotes band edge frequency.
- (3) Radiated emissions measured in frequency range from 30 MHz to 1000 MHz were made with an instrument using Peak detector mode or QP detector mode of the emission .
- (4) Data of measurement within this frequency range shown " - " in the table above means the reading of emissions are attenuated more than 20dB below the permissible limits or the field strength is too small to be measured.

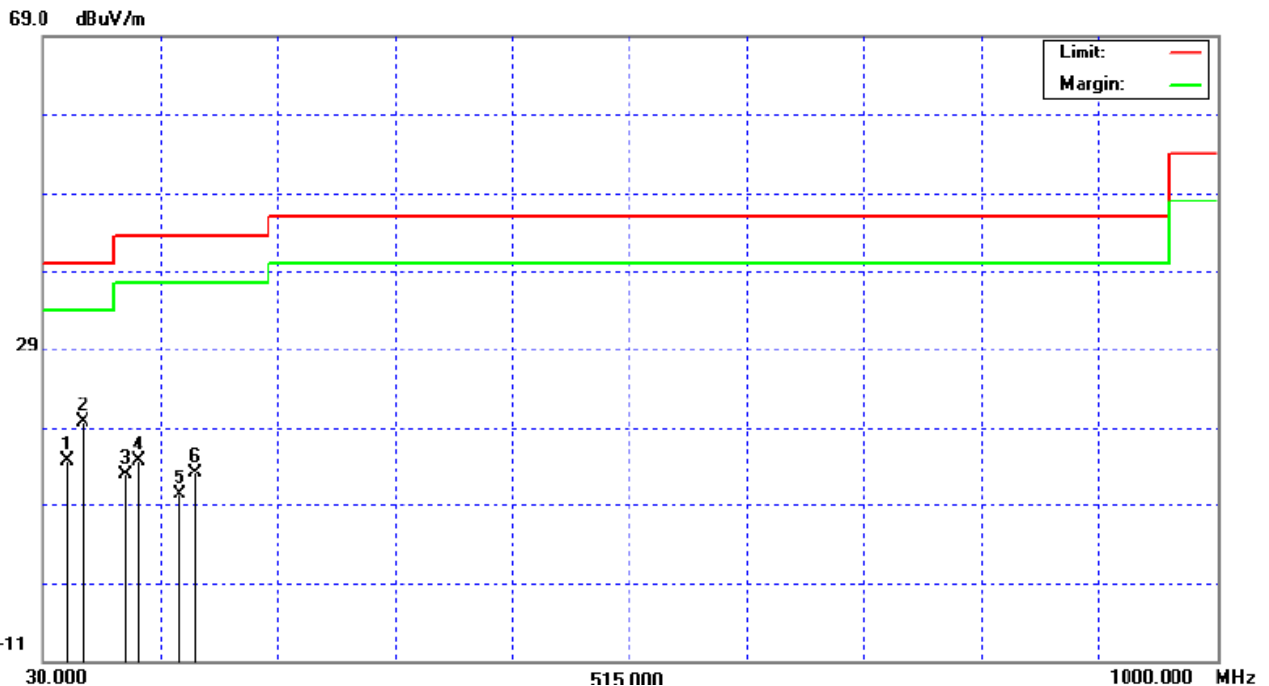

4.2.8 TEST RESULTS (ABOVE 1000 MHz)

EUT :	Wireless Mouse	Model Name. :	L180
Temperature :	20 °C	Relative Humidity :	60 %
Pressure :	1020 hPa	Test Power :	DC 3V
Test Mode :	TX 2402MHz		

Freq. (MHz)	Ant.Pol. H/V	Reading		Ant./CF CF(dB)	Act.		Limit		Note
		Peak (dBuV)	AV (dBuV)		Peak (dBuV/m)	AV (dBuV/m)	Peak (dBuV/m)	AV (dBuV/m)	
2390.00	V	19.30	9.31	32.05	51.35	41.36	74.00	54.00	X/E
<b>2402.08</b>	<b>V</b>	<b>52.76</b>	<b>52.46</b>	<b>32.09</b>	<b>84.85</b>	<b>84.55</b>	<b>114.00</b>	<b>94.00</b>	<b>X/F</b>
4803.56	V	50.26	44.91	3.51	53.77	48.42	74.00	54.00	X/H
7206.03	V	48.29	38.95	8.22	56.51	47.17	74.00	54.00	X/H

Remark :

- (1) All readings are Peak unless otherwise stated QP in column of 『Note』 . Peak denotes that the Peak reading compliance with the QP Limits and then QP Mode measurement didn't perform .
- (2) Measuring frequency range from 30MHz to 1000MHz or the 10th harmonic of highest fundamental frequency . "F" denotes fundamental frequency; "H" denotes spurious frequency. "E" denotes band edge frequency. (This judgment method includes the Band Edge Requirement.)
- (3) Radiated emissions measured in frequency range above 1000MHz were made with an instrument using Peak detector mode and AV detector mode of the emission .
- (4) Data of measurement within this frequency range shown " \* " in the table above means the reading of emissions are attenuated more than 20dB below the permissible limits or the field strength is too small to be measured.
- (5) A preamp and high pass filter were used for this test in order to provide sufficient measurement sensitivity.
- (6) EUT Orthogonal Axes :  
 "X" - denotes Laid on Table ; "Y" - denotes Vertical Stand ; "Z" - denotes Side Stand

Orthogonal Axes : X  
TX 2402MHz (Above 1000 MHz, Vertical)

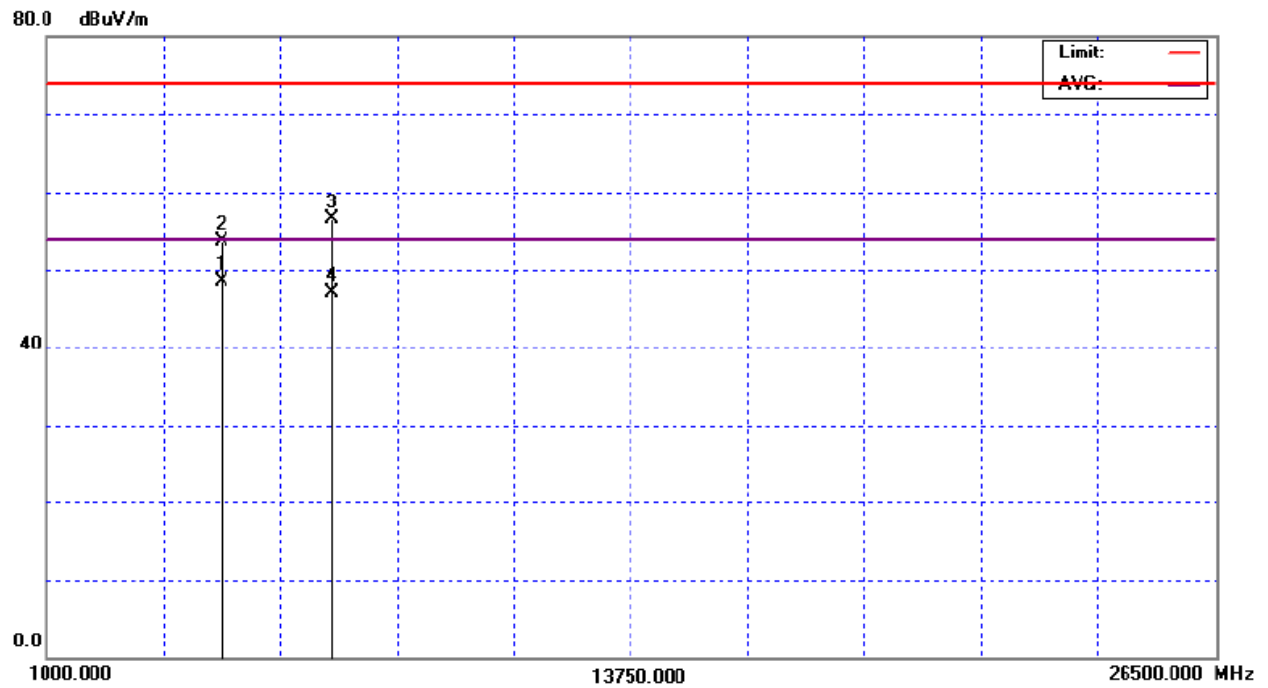
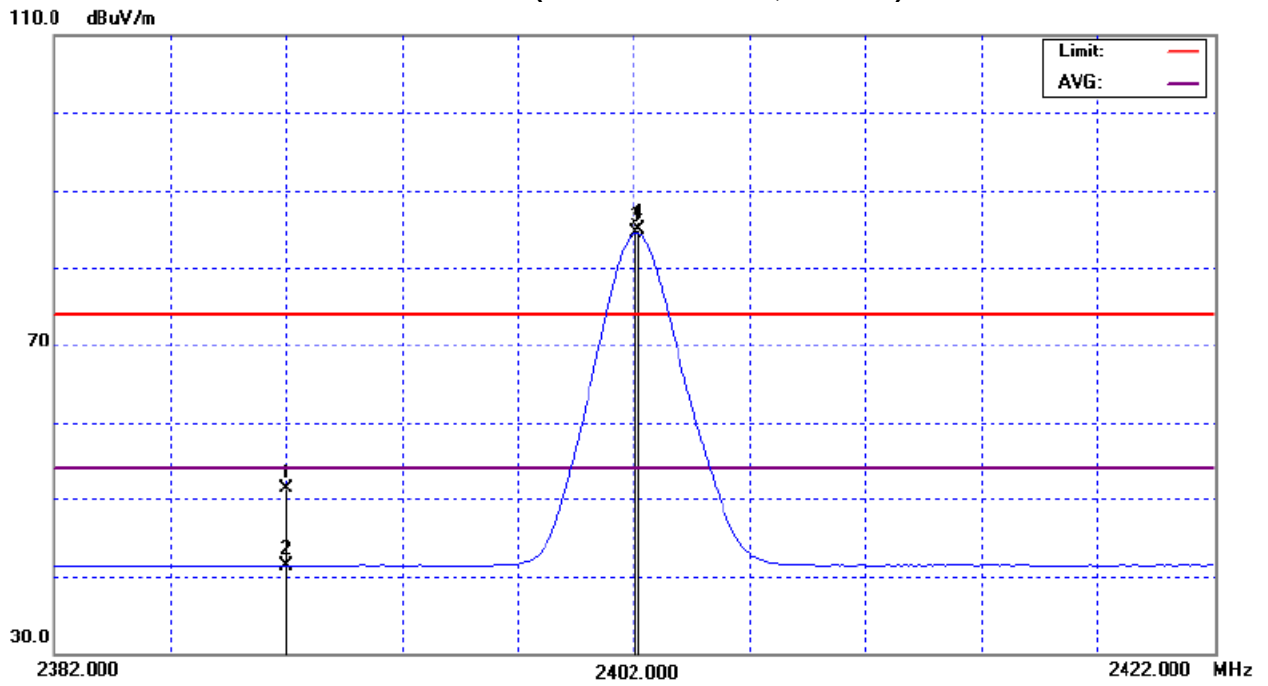



EUT :	Wireless Mouse	Model Name. :	L180
Temperature :	20 °C	Relative Humidity :	60 %
Pressure :	1020 hPa	Test Power :	DC 3V
Test Mode :	TX 2402MHz		

Freq. (MHz)	Ant.Pol. H/V	Reading		Ant./CF CF(dB)	Act.		Limit		Note
		Peak (dBuV)	AV (dBuV)		Peak (dBuV/m)	AV (dBuV/m)	Peak (dBuV/m)	AV (dBuV/m)	
2390.00	H	20.06	9.30	32.05	52.11	41.35	74.00	54.00	X/E
<b>2402.08</b>	<b>H</b>	<b>59.02</b>	<b>58.78</b>	<b>32.09</b>	<b>91.11</b>	<b>90.87</b>	<b>114.00</b>	<b>94.00</b>	<b>X/F</b>
4803.97	H	49.87	41.25	3.51	53.38	44.76	74.00	54.00	X/H
7206.03	H	51.06	41.06	8.22	59.28	49.28	74.00	54.00	X/H

Remark :

- (1) All readings are Peak unless otherwise stated QP in column of 『 Note 』 . Peak denotes that the Peak reading compliance with the QP Limits and then QP Mode measurement didn't perform .
- (2) Measuring frequency range from 30MHz to 1000MHz or the 10th harmonic of highest fundamental frequency . "F" denotes fundamental frequency; "H" denotes spurious frequency. "E" denotes band edge frequency. (This judgment method includes the Band Edge Requirement.)
- (3) Radiated emissions measured in frequency range above 1000MHz were made with an instrument using Peak detector mode and AV detector mode of the emission .
- (4) Data of measurement within this frequency range shown " \* " in the table above means the reading of emissions are attenuated more than 20dB below the permissible limits or the field strength is too small to be measured.
- (5) A preamp and high pass filter were used for this test in order to provide sufficient measurement sensitivity.
- (6) EUT Orthogonal Axes :  
 "X" - denotes Laid on Table ; "Y" - denotes Vertical Stand ; "Z" - denotes Side Stand

Orthogonal Axes : X  
TX 2402MHz (Above 1000 MHz, Horizontal)

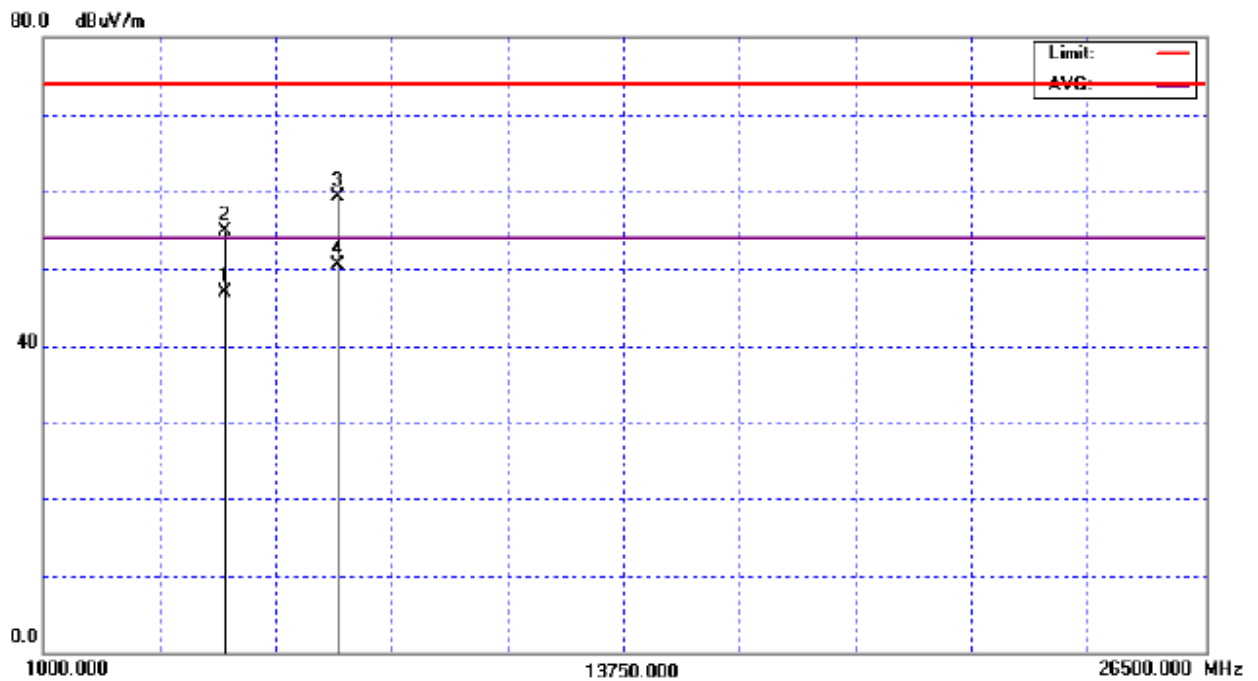
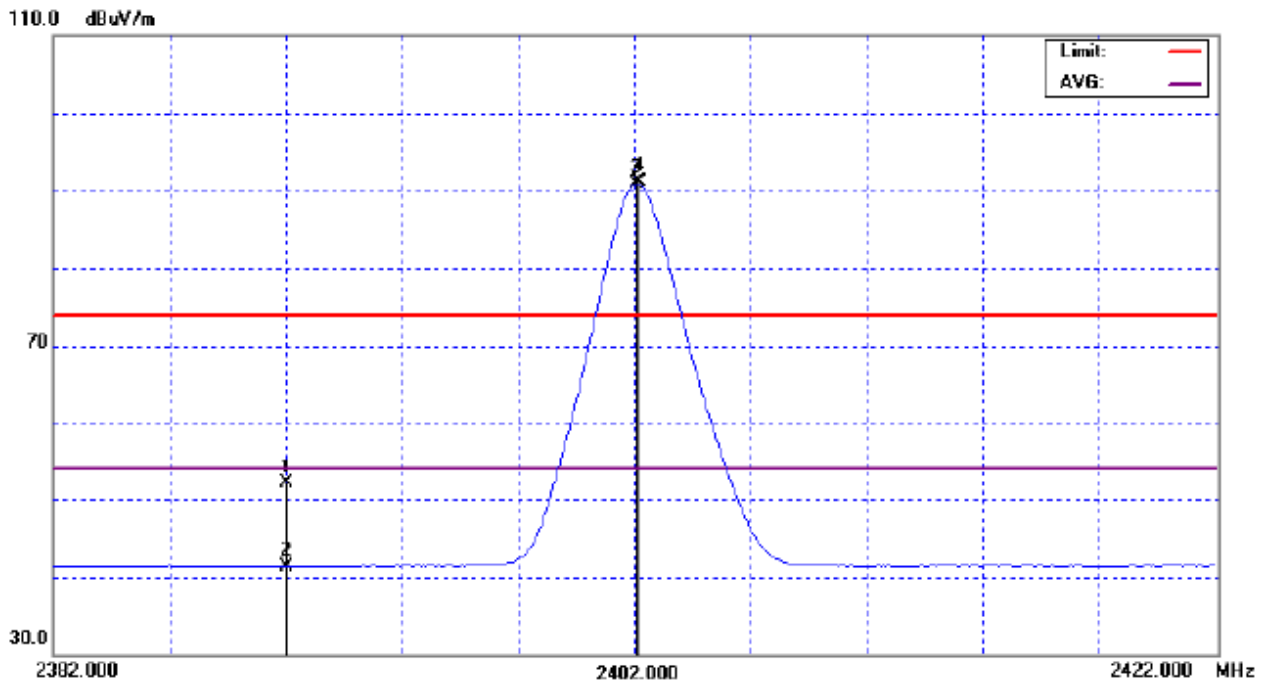

EUT :	Wireless Mouse	Model Name. :	L180
Temperature :	20 °C	Relative Humidity :	60 %
Pressure :	1020 hPa	Test Power :	DC 3V
Test Mode :	TX 2439MHz		

Freq. (MHz)	Ant.Pol. H/V	Reading		Ant./CF CF(dB)	Act.		Limit		Note
		Peak (dBuV)	AV (dBuV)		Peak (dBuV/m)	AV (dBuV/m)	Peak (dBuV/m)	AV (dBuV/m)	
<b>2439.08</b>	<b>V</b>	<b>56.03</b>	<b>55.76</b>	<b>32.21</b>	<b>88.24</b>	<b>87.97</b>	<b>114.00</b>	<b>94.00</b>	<b>X/F</b>
4878.12	V	49.45	45.42	3.74	53.19	49.16	74.00	54.00	X/E
7317.22	V	46.01	38.95	8.67	54.68	47.62	74.00	54.00	X/H

Remark :

- (1) All readings are Peak unless otherwise stated QP in column of 『Note』 . Peak denotes that the Peak reading compliance with the QP Limits and then QP Mode measurement didn't perform .
- (2) Measuring frequency range from 30MHz to 1000MHz or the 10th harmonic of highest fundamental frequency . "F" denotes fundamental frequency; "H" denotes spurious frequency. "E" denotes band edge frequency. (This judgment method includes the Band Edge Requirement.)
- (3) Radiated emissions measured in frequency range above 1000MHz were made with an instrument using Peak detector mode and AV detector mode of the emission .
- (4) Data of measurement within this frequency range shown " \* " in the table above means the reading of emissions are attenuated more than 20dB below the permissible limits or the field strength is too small to be measured.
- (5) A preamp and high pass filter were used for this test in order to provide sufficient measurement sensitivity.
- (6) EUT Orthogonal Axes :  
 "X" - denotes Laid on Table ; "Y" - denotes Vertical Stand ; "Z" - denotes Side Stand

Orthogonal Axes : X  
TX 2439 MHz (Above 1000 MHz, Vertical)

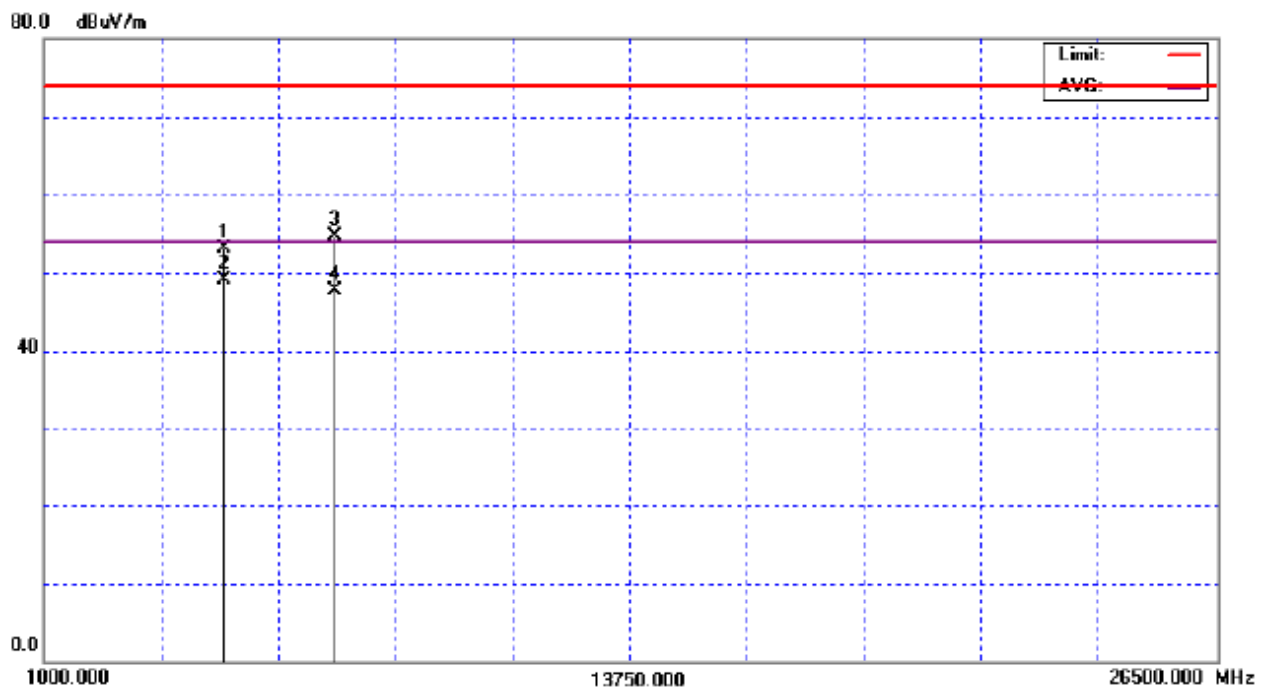
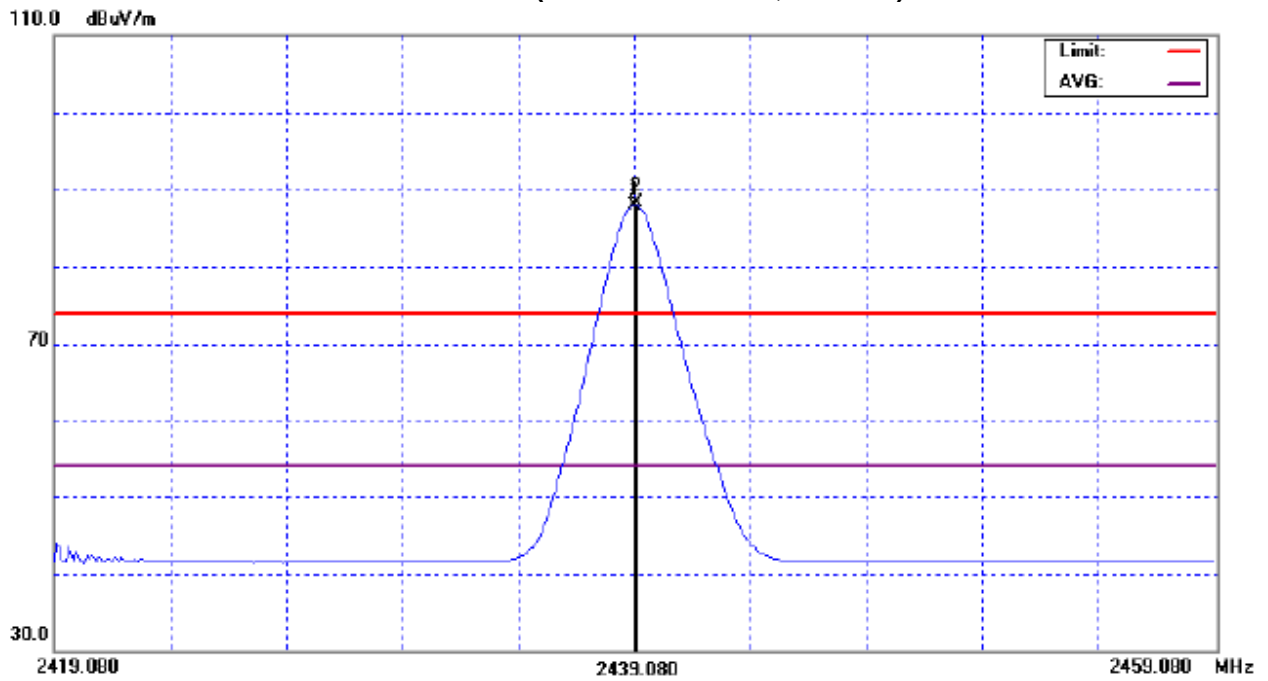

EUT :	Wireless Mouse	Model Name. :	L180
Temperature :	20 °C	Relative Humidity :	60 %
Pressure :	1020 hPa	Test Power :	DC 3V
Test Mode :	TX 2439MHz		

Freq. (MHz)	Ant.Pol. H/V	Reading		Ant./CF CF(dB)	Act.		Limit		Note
		Peak (dBuV)	AV (dBuV)		Peak (dBuV/m)	AV (dBuV/m)	Peak (dBuV/m)	AV (dBuV/m)	
<b>2439.00</b>	<b>H</b>	<b>58.37</b>	<b>58.60</b>	<b>32.20</b>	<b>90.80</b>	<b>90.58</b>	<b>114.00</b>	<b>94.00</b>	<b>X/F</b>
4878.16	H	48.62	42.35	3.74	52.36	46.09	74.00	54.00	X/E
7317.12	H	48.83	71.94	8.67	57.50	50.61	74.00	54.00	X/H

Remark :

- (1) All readings are Peak unless otherwise stated QP in column of 『Note』 . Peak denotes that the Peak reading compliance with the QP Limits and then QP Mode measurement didn't perform .
- (2) Measuring frequency range from 30MHz to 1000MHz or the 10th harmonic of highest fundamental frequency . "F" denotes fundamental frequency; "H" denotes spurious frequency. "E" denotes band edge frequency. (This judgment method includes the Band Edge Requirement.)
- (3) Radiated emissions measured in frequency range above 1000MHz were made with an instrument using Peak detector mode and AV detector mode of the emission .
- (4) Data of measurement within this frequency range shown " \* " in the table above means the reading of emissions are attenuated more than 20dB below the permissible limits or the field strength is too small to be measured.
- (5) A preamp and high pass filter were used for this test in order to provide sufficient measurement sensitivity.
- (6) EUT Orthogonal Axes :  
 "X" - denotes Laid on Table ; "Y" - denotes Vertical Stand ; "Z" - denotes Side Stand

Orthogonal Axes : X  
TX 2439MHz (Above 1000 MHz, Horizontal)

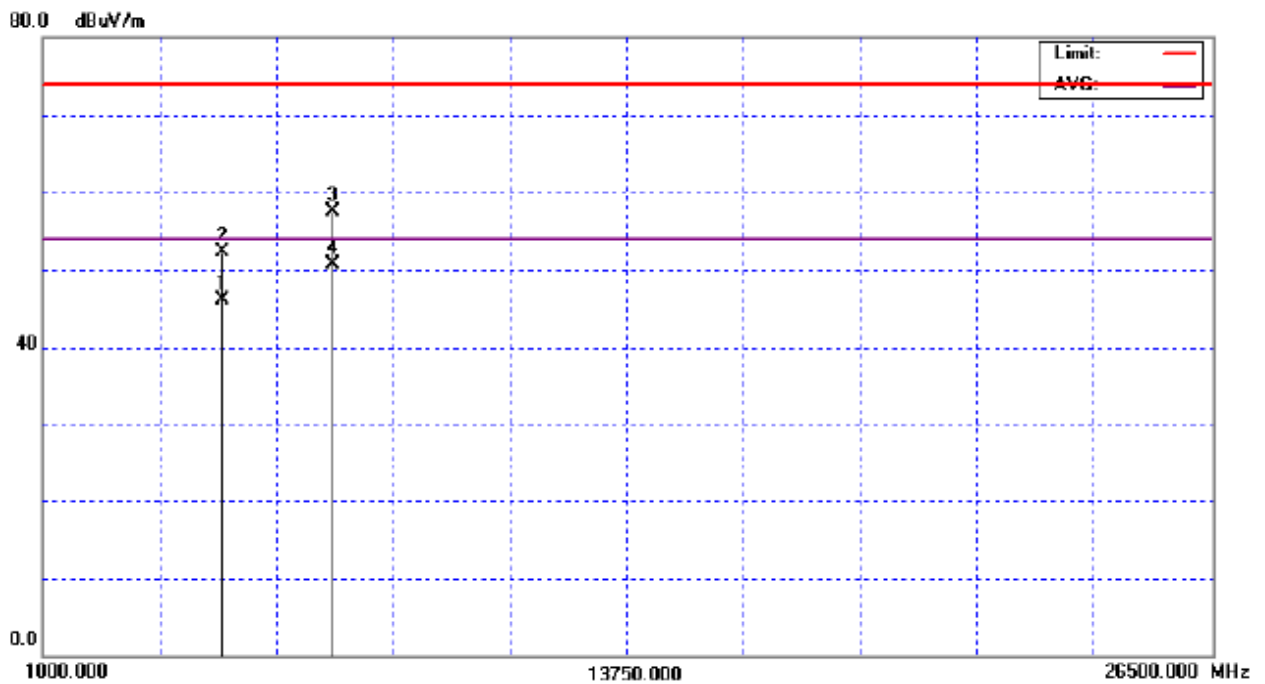
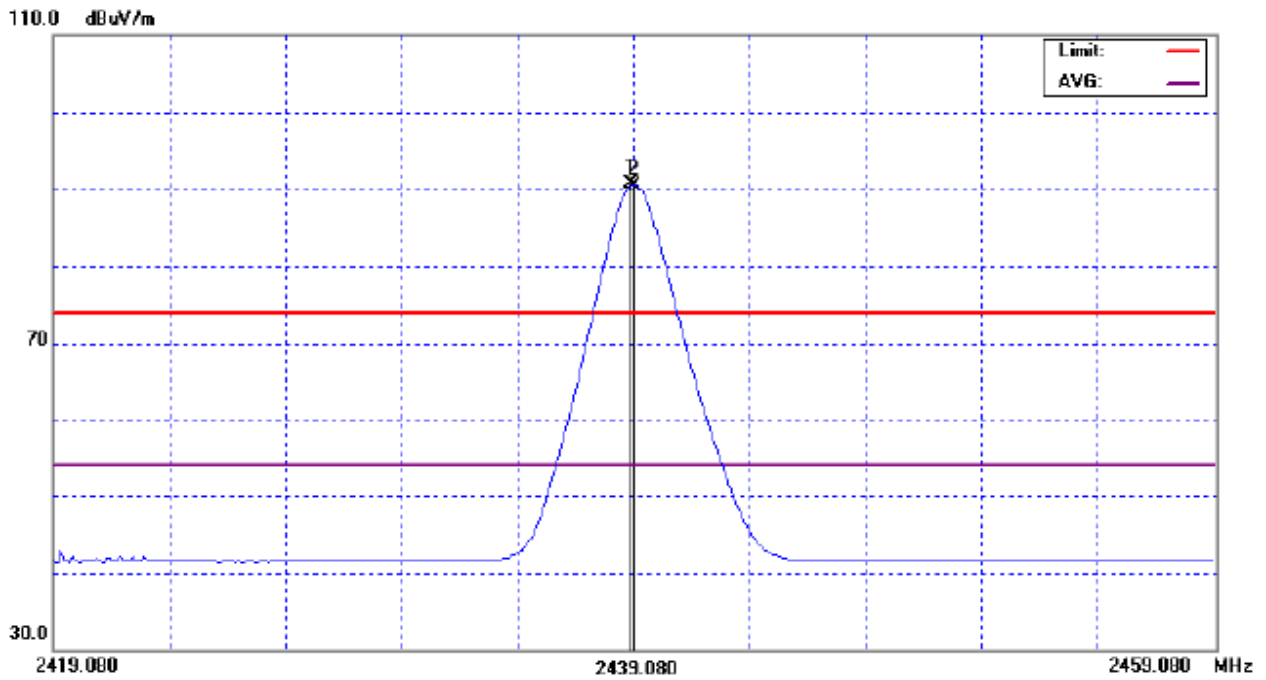

EUT :	Wireless Mouse	Model Name. :	L180
Temperature :	20 °C	Relative Humidity :	60 %
Pressure :	1020 hPa	Test Power :	DC 3V
Test Mode :	TX 2479MHz		

Freq. (MHz)	Ant.Pol. H/V	Reading		Ant./CF CF(dB)	Act.		Limit		Note
		Peak (dBuV)	AV (dBuV)		Peak (dBuV/m)	AV (dBuV/m)	Peak (dBuV/m)	AV (dBuV/m)	
<b>2479.08</b>	<b>V</b>	<b>57.20</b>	<b>56.98</b>	<b>32.33</b>	<b>89.53</b>	<b>89.31</b>	<b>114.00</b>	<b>94.00</b>	<b>X/F</b>
2483.50	V	20.23	10.88	32.35	52.58	43.23	74.00	54.00	X/E
4958.16	V	49.58	41.03	3.97	53.55	45.00	74.00	54.00	X/H
7437.16	V	49.87	40.29	9.15	59.02	49.44	74.00	54.00	X/H

Remark :

- (1) All readings are Peak unless otherwise stated QP in column of 『Note』 . Peak denotes that the Peak reading compliance with the QP Limits and then QP Mode measurement didn't perform .
- (2) Measuring frequency range from 30MHz to 1000MHz or the 10th harmonic of highest fundamental frequency . "F" denotes fundamental frequency; "H" denotes spurious frequency. "E" denotes band edge frequency. (This judgment method includes the Band Edge Requirement.)
- (3) Radiated emissions measured in frequency range above 1000MHz were made with an instrument using Peak detector mode and AV detector mode of the emission .
- (4) Data of measurement within this frequency range shown " \* " in the table above means the reading of emissions are attenuated more than 20dB below the permissible limits or the field strength is too small to be measured.
- (5) A preamp and high pass filter were used for this test in order to provide sufficient measurement sensitivity.
- (6) EUT Orthogonal Axes :  
 "X" - denotes Laid on Table ; "Y" - denotes Vertical Stand ; "Z" - denotes Side Stand

Orthogonal Axes : X  
TX 2479MHz (Above 1000 MHz, Vertical)

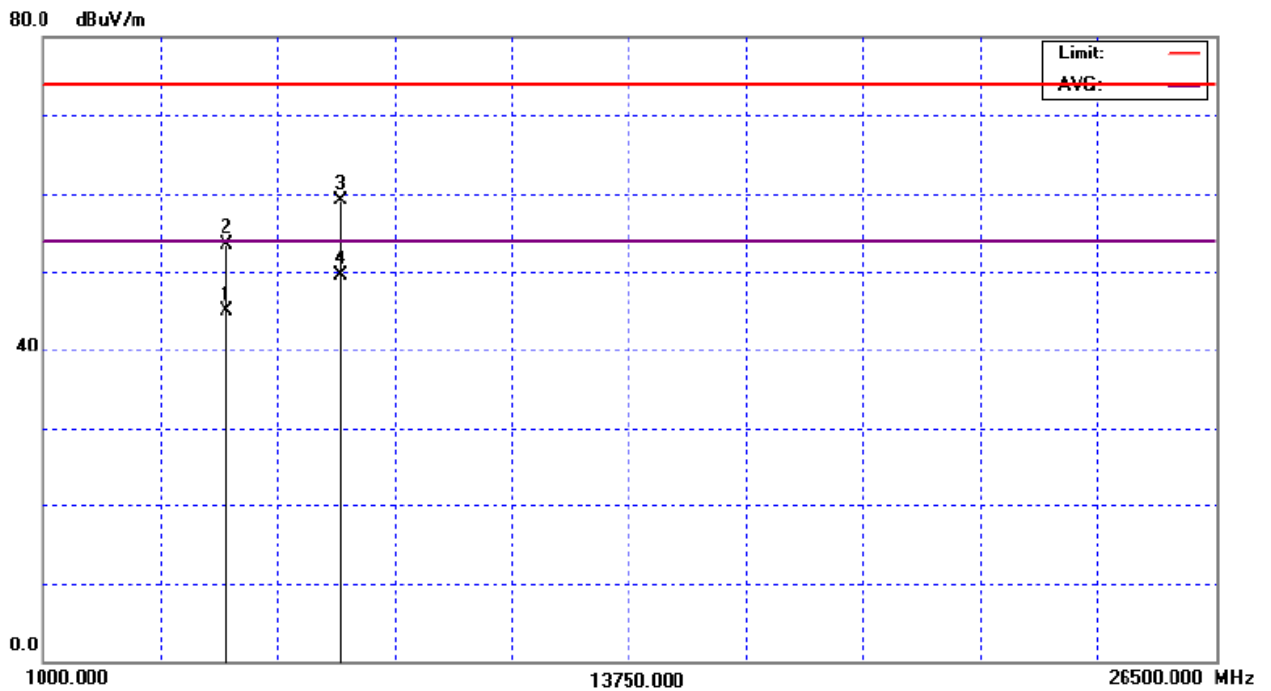
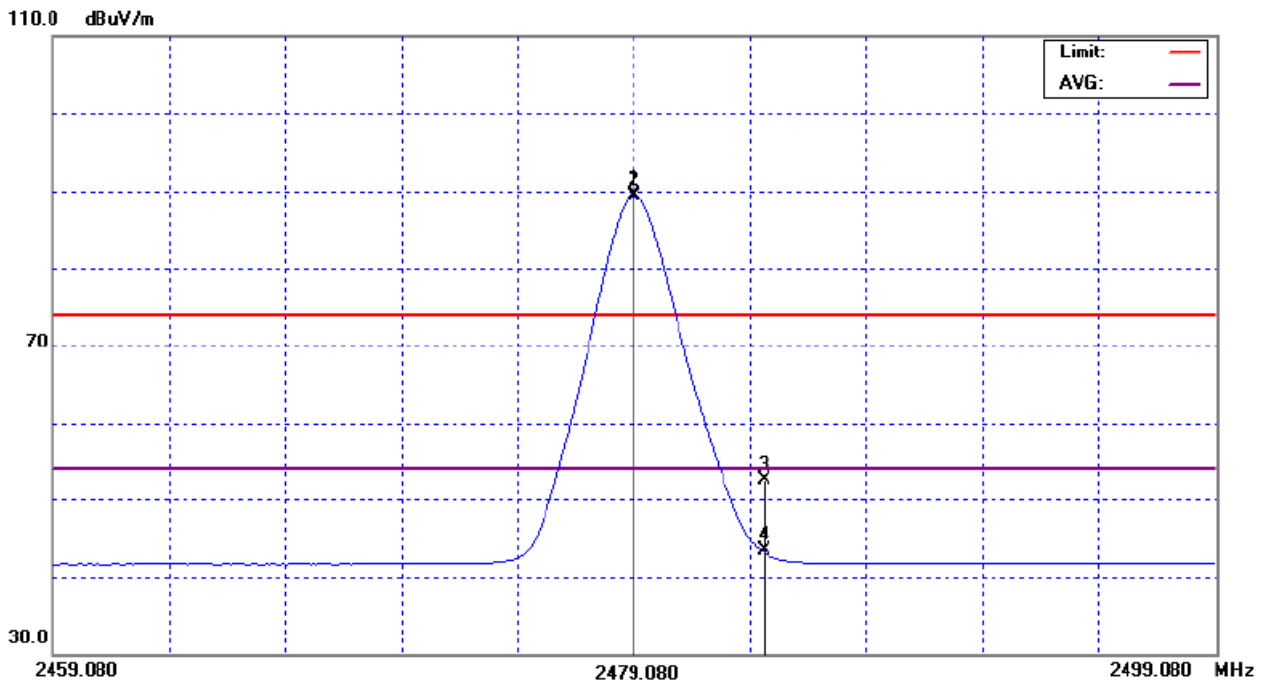



EUT :	Wireless Mouse	Model Name. :	L180
Temperature :	20 °C	Relative Humidity :	60 %
Pressure :	1020 hPa	Test Power :	DC 3V
Test Mode :	TX 2479MHz		

Freq. (MHz)	Ant.Pol. H/V	Reading		Ant./CF CF(dB)	Act.		Limit		Note
		Peak (dBuV)	AV (dBuV)		Peak (dBuV/m)	AV (dBuV/m)	Peak (dBuV/m)	AV (dBuV/m)	
<b>2479.08</b>	<b>H</b>	<b>59.07</b>	<b>58.86</b>	<b>32.33</b>	<b>91.40</b>	<b>91.19</b>	<b>114.00</b>	<b>94.00</b>	<b>X/F</b>
2483.50	H	20.68	11.57	32.35	53.03	43.92	74.00	54.00	X/E
4958.16	H	51.00	42.98	3.97	54.97	46.95	74.00	54.00	X/H
7437.16	H	50.14	41.28	9.15	59.29	50.43	74.00	54.00	X/H

Remark :

- (1) All readings are Peak unless otherwise stated QP in column of 『 Note 』 . Peak denotes that the Peak reading compliance with the QP Limits and then QP Mode measurement didn't perform ◦
- (2) Measuring frequency range from 30MHz to 1000MHz or the 10th harmonic of highest fundamental frequency ◦ "F" denotes fundamental frequency; "H" denotes spurious frequency. "E" denotes band edge frequency. (This judgment method includes the Band Edge Requirement.)
- (3) Radiated emissions measured in frequency range above 1000MHz were made with an instrument using Peak detector mode and AV detector mode of the emission ◦
- (4) Data of measurement within this frequency range shown " \* " in the table above means the reading of emissions are attenuated more than 20dB below the permissible limits or the field strength is too small to be measured.
- (5) A preamp and high pass filter were used for this test in order to provide sufficient measurement sensitivity.
- (6) EUT Orthogonal Axes :  
 "X" - denotes Laid on Table ; "Y" - denotes Vertical Stand ; "Z" - denotes Side Stand

Orthogonal Axes : X  
TX 2479MHz (Above 1000 MHz, Horizontal)

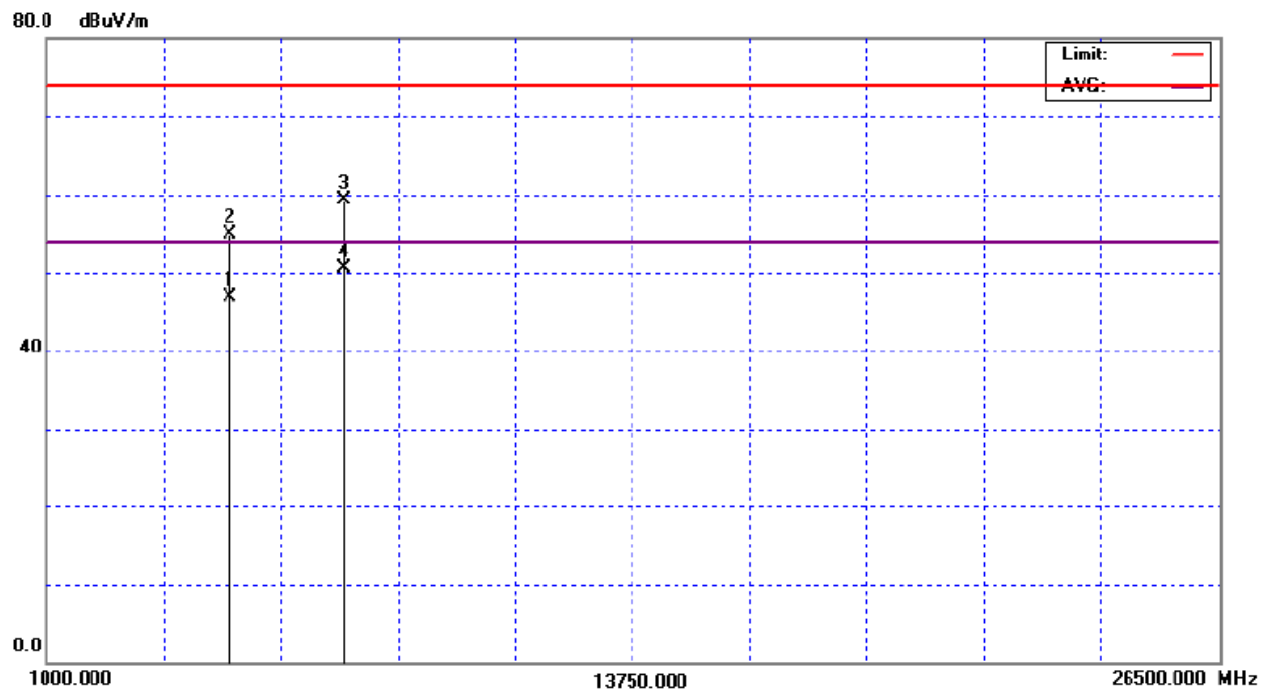
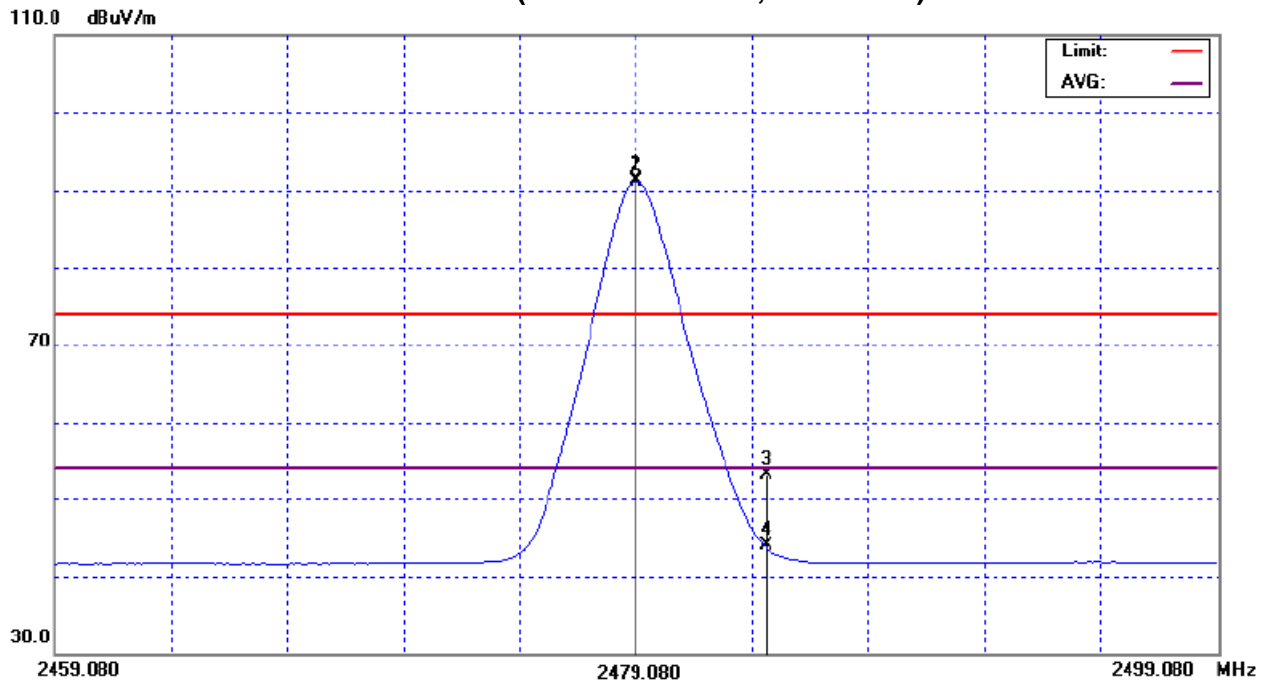

4.2.9 TEST RESULTS (2400 – 2483.5 MHz)

EUT :	Wireless Mouse	Model Name. :	L180
Temperature :	20°C	Relative Humidity :	60 %
Pressure :	1020 hPa	Test Power :	DC 3V
Test Mode :	TX CH 2402MHz/2439MHz/2479MHz		

Freq. (MHz)	Ant.Pol. (H/V)	Reading		Ant./CL/ CF(dB)	Actual FS		Limit3m		NOTE
		Peak (dBuV)	AV (dBuV)		Peak (dBuV/m)	AV (dBuV/m)	Peak (dBuV/m)	AV (dBuV/m)	
2402.08	V	52.76	52.46	32.09	84.85	84.55	114.00	94.00	CH01
2402.08	H	59.02	58.78	32.09	91.11	90.87	114.00	94.00	CH01
2439.08	V	56.03	55.76	32.21	88.24	87.97	114.00	94.00	CH08
2439.00	H	58.37	58.60	32.20	90.80	90.58	114.00	94.00	CH08
2479.08	V	57.20	56.98	32.33	89.53	89.31	114.00	94.00	CH16
2479.08	H	59.07	58.86	32.33	91.40	91.19	114.00	94.00	CH16

Remark :

- (1) All readings are Peak unless otherwise stated QP in column of 『Note』 . Peak denotes that the Peak reading compliance with the QP Limits and then QP Mode measurement didn't perform .
- (2) Radiated emissions measured in frequency range above 1000MHz were made with an instrument using Peak detector mode and AV detector mode of the emission .
- (3) Data of measurement within this frequency range shown “ \* ” in the table above means the reading of emissions are attenuated more than 20dB below the permissible limits or the field strength is too small to be measured.
- (4) EUT Orthogonal Axes :  
 “X” - denotes Laid on Table ; “Y” - denotes Vertical Stand ; “Z” - denotes Side Stand

4.2.10 TEST RESULTS (Restricted Bands Requirements)

EUT :	Wireless Mouse	Model Name. :	L180
Temperature :	20°C	Relative Humidity :	60 %
Pressure :	1020 hPa	Test Power :	DC 3V
Test Mode :	TX CH 2402MHz/2479MHz(Vertical)		
Note :	<p>The emission of the carrier radiated field strength is measured for (Peak and AV) as following:</p> <ol style="list-style-type: none"> <li>1. The transmitter was then configured with the worst case antenna and setup to transmit at the lowest channel (CH01). Then the field strength was measured at 2310-2390 MHz.</li> <li>2. The transmitter was configured with the worst case antenna and setup to transmit at the highest channel (CH16). Then the field strength was measured at 2483.5-2500 MHz.</li> </ol>		

Freq. (MHz)	Ant.Pol. H/V	Reading		Ant./CF CF(dB)	Act.		Limit		Note
		Peak (dBuV)	AV (dBuV)		Peak (dBuV/m)	AV (dBuV/m)	Peak (dBuV/m)	AV (dBuV/m)	
2390.00	V	19.30	9.31	32.05	51.35	41.36	74.00	54.00	CH01
2483.50	V	20.23	10.88	32.35	52.58	43.23	74.00	54.00	CH16

Remark :

- (1) Radiated emissions measured in frequency range above 1000MHz were made with an instrument using Peak detector mode and AV detector mode of the emission .
- (2) EUT Orthogonal Axes :  
 "X" - denotes Laid on Table ; "Y" - denotes Vertical Stand ; "Z" - denotes Side Stand

**TX CH 01 (Restricted Bands Requirements, Vertical)**

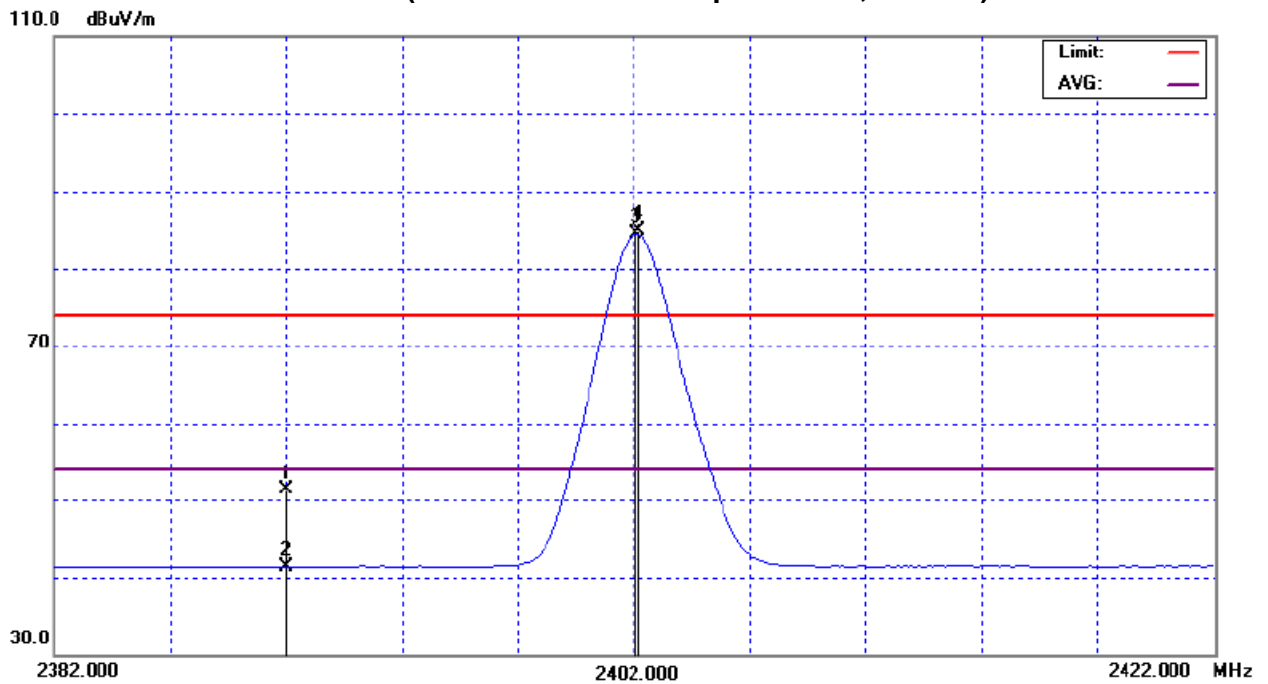

**TX CH 16 (Restricted Bands Requirements, Vertical)**

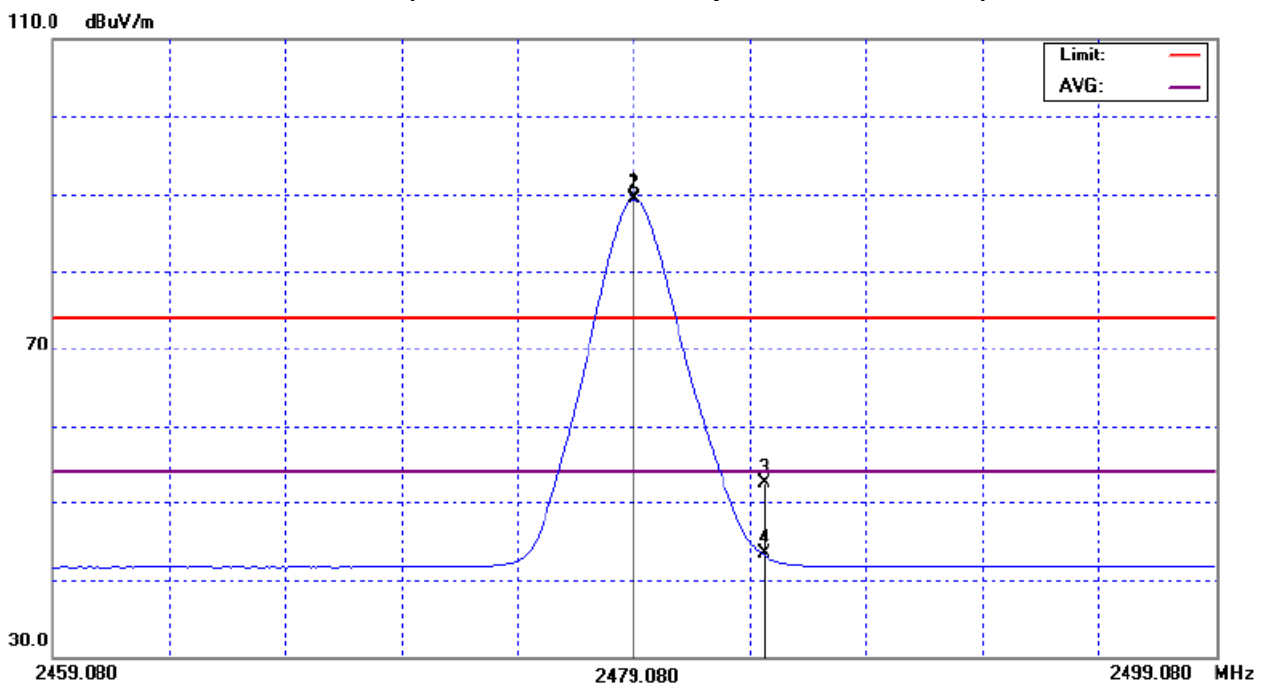

EUT :	Wireless Mouse	Model Name. :	L180
Temperature :	20°C	Relative Humidity :	60 %
Pressure :	1020 hPa	Test Power :	DC 3V
Test Mode :	TX CH 2402MHz/2479MHz (Horizontal)		
Note :	<p>The emission of the carrier radiated field strength is measured for (Peak and AV) as following:</p> <ol style="list-style-type: none"> <li>1. The transmitter was then configured with the worst case antenna and setup to transmit at the lowest channel (CH01). Then the field strength was measured at 2310-2390 MHz.</li> <li>2. The transmitter was configured with the worst case antenna and setup to transmit at the highest channel (CH16). Then the field strength was measured at 2483.5-2500 MHz.</li> </ol>		

Freq. (MHz)	Ant.Pol. H/V	Reading		Ant./CF CF(dB)	Act.		Limit		Note
		Peak (dBuV)	AV (dBuV)		Peak (dBuV/m)	AV (dBuV/m)	Peak (dBuV/m)	AV (dBuV/m)	
2390.00	H	20.06	9.30	32.05	52.11	41.35	74.00	54.00	CH01
2483.50	V	20.68	11.57	32.35	53.03	43.92	74.00	54.00	CH16

Remark :

- (1) Radiated emissions measured in frequency range above 1000MHz were made with an instrument using Peak detector mode and AV detector mode of the emission .
- (2) EUT Orthogonal Axes :  
 "X" - denotes Laid on Table ; "Y" - denotes Vertical Stand ; "Z" - denotes Side Stand

TX CH01 (Restricted Bands Requirements, Horizontal)

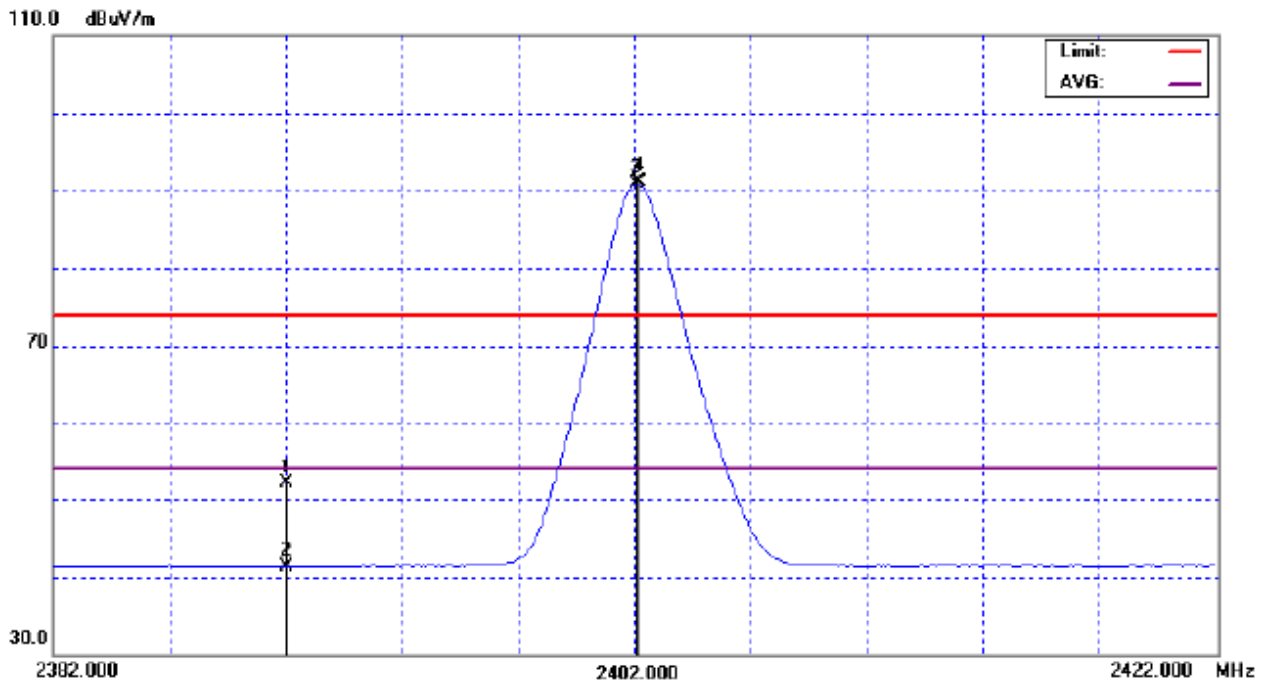

TX CH16 (Restricted Bands Requirements, Horizontal)

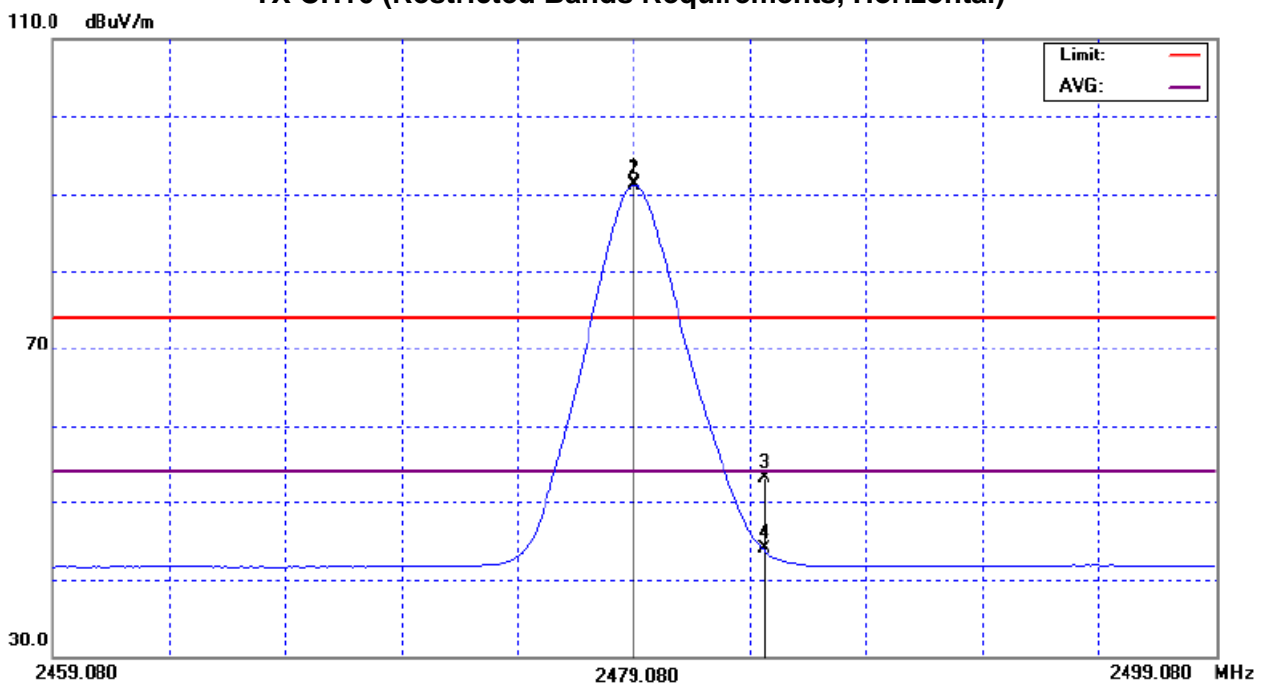

### 5. BANDWIDTH TEST

#### 5.1 MEASUREMENT INSTRUMENTS LIST

Item	Kind of Equipment	Manufacturer	Type No.	Serial No.	Calibrated until
1	Spectrum Analyzer	R&S	FSP_40	100129	Jan. 07, 2009

Remark: " N/A" denotes No Model Name. , Serial No. or No Calibration specified.

#### 5.2 TEST PROCEDURE

- a. The EUT was directly connected to the spectrum analyzer and antenna output port as show in the block diagram below,
- b. Spectrum Setting : RBW= 100KHz, VBW=100KHz, Sweep time = 20 ms.

#### 5.3 DEVIATION FROM STANDARD

No deviation.

#### 5.4 TEST SETUP

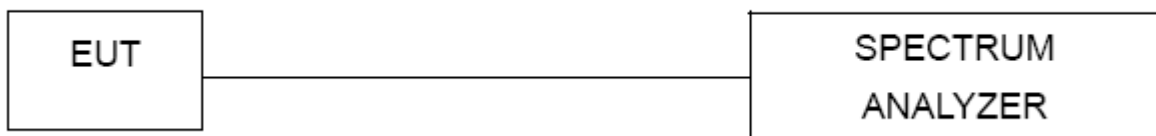

#### 5.5 EUT OPERATION CONDITIONS

The EUT tested system was configured as the statements of 4.1.6 Unless otherwise a special operating condition is specified in the follows during the testing.



5.6 TEST RESULTS

EUT :	Wireless Mouse	Model Name. :	L180
Temperature :	20°C	Relative Humidity :	60 %
Pressure :	1020 hPa	Test Power :	DC 3V
Test Mode :	TX CH 01/08/16		

Test Channel	Frequency (MHz)	20 dBc Bandwidth (MHz)	99% occupied Bandwidth(MHz)
CH01	2402	1.188	1.044
CH08	2439	1.196	1.056
CH16	2479	1.216	1.076

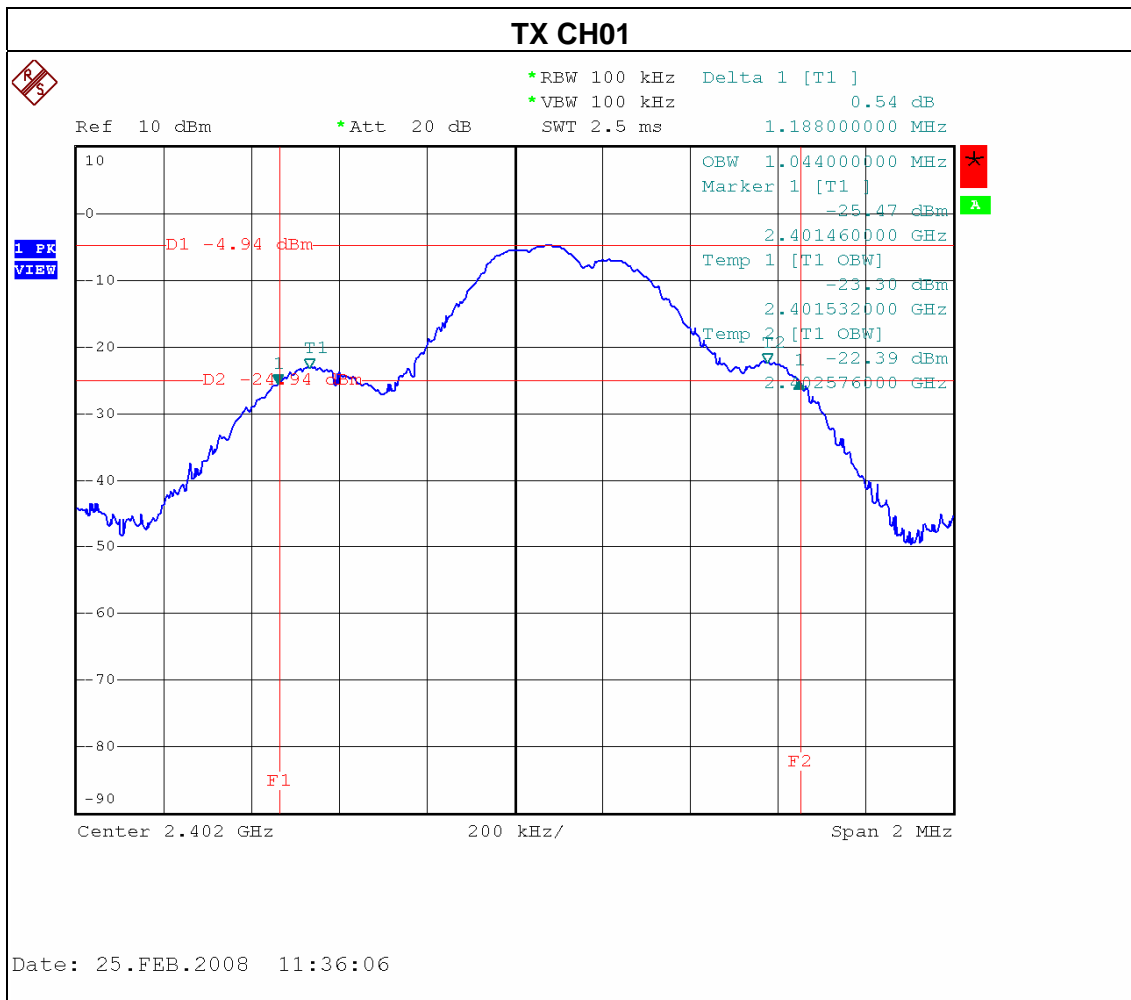

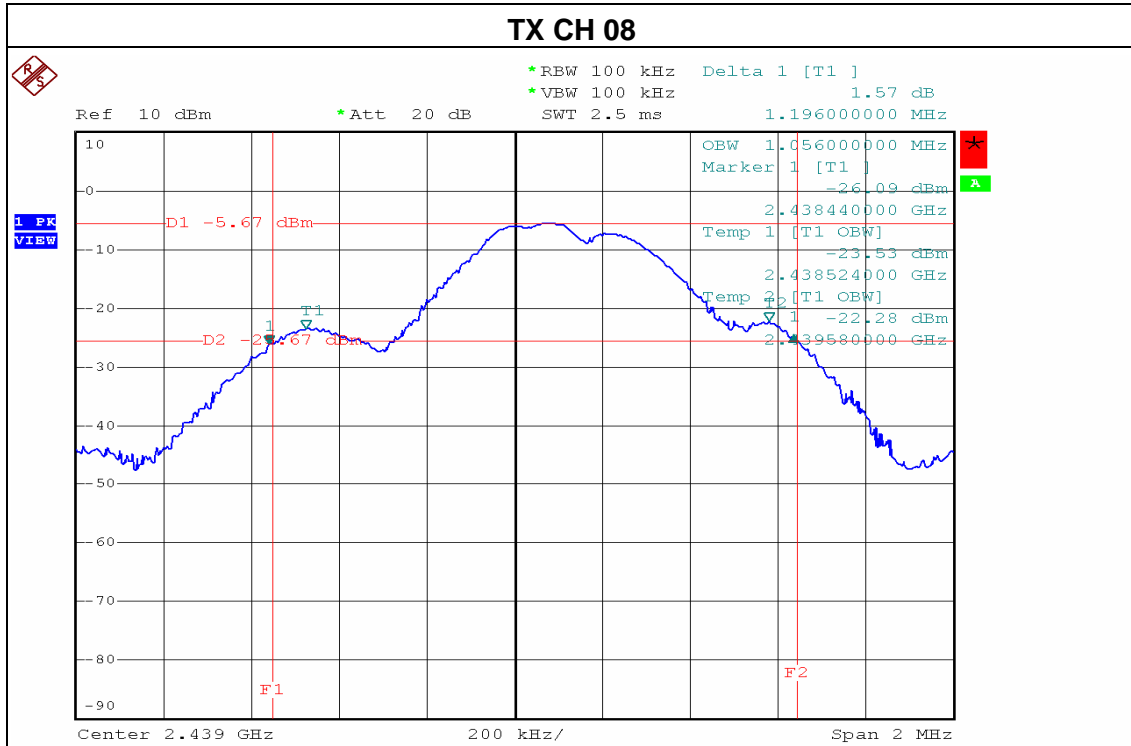

Date: 25.FEB.2008 11:38:04

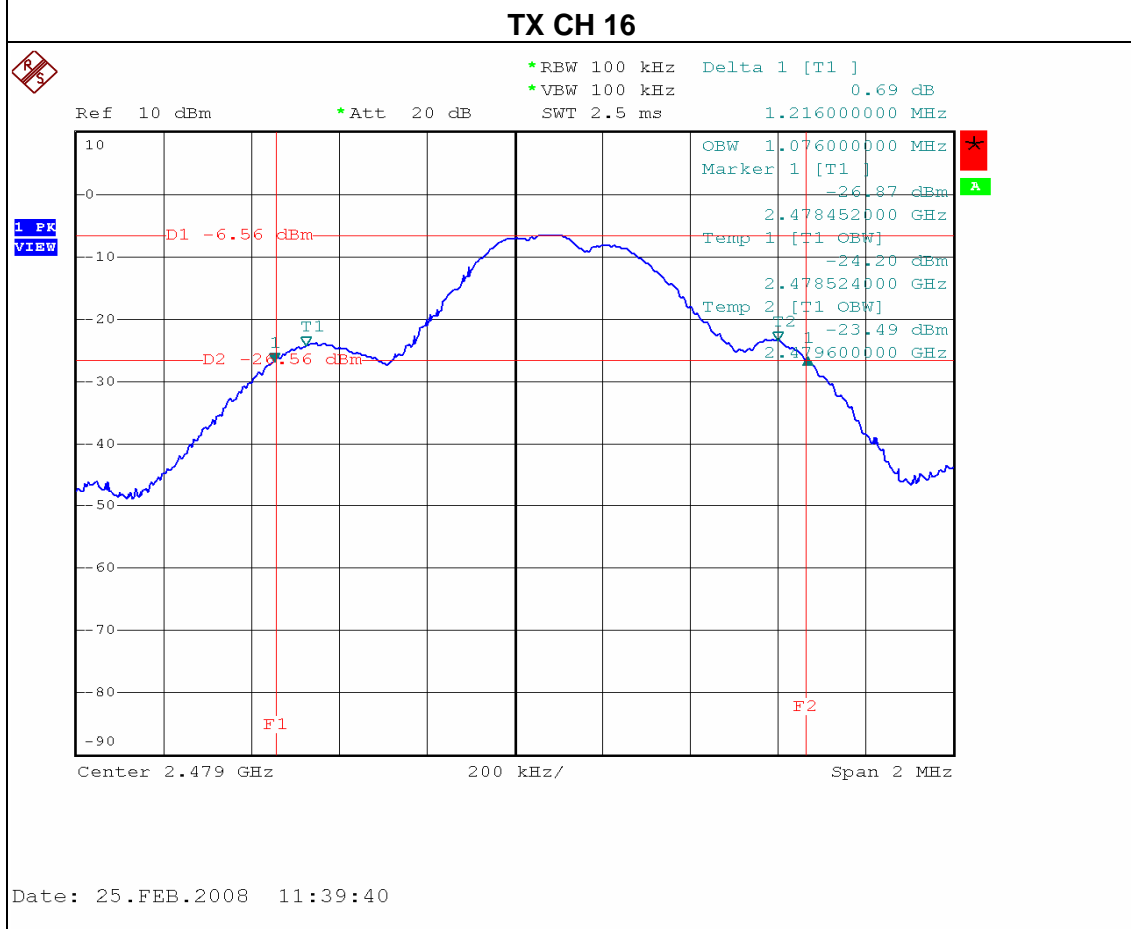

Date: 25.FEB.2008 11:39:40

**6. ANTENNA CONDUCTED SPURIOUS EMISSION**

**6.1 APPLIED PROCEDURES / LIMIT**

20dBc in any 100 kHz bandwidth outside the operating frequency band. In case the emission fall within the restricted band specified on 15.205(a), then the 15.209(a) limit in the table below has to be followed.

Frequencies (MHz)	Field Strength (micorvolts/meter)	Measurement Distance (meters)
0.009~0.490	2400/F(KHz)	300
0.490~1.705	24000/F(KHz)	30
1.705~30.0	30	30
30~88	100	3
88~216	150	3
216~960	200	3
Above 960	500	3

**6.1.1 MEASUREMENT INSTRUMENTS LIST**

Item	Kind of Equipment	Manufacturer	Type No.	Serial No.	Calibrated until
8	Spectrum Analyzer	R&S	FSP_40	100129	Jan. 07, 2009

Remark: " N/A" denotes No Model Name. , Serial No. or No Calibration specified.

The following table is the setting of the spectrum analyzer.

Spectrum Parameter	Setting
Attenuation	Auto
Span Frequency	100 MHz
RB / VB (emission in restricted band)	1MHz / 1MHz for Peak, 1 MHz / 10Hz for Average
RB / VB (other emission)	100 KHz /100 KHz for Peak

**6.1.2 TEST PROCEDURE**

- a. The EUT was directly connected to the spectrum analyzer and antenna output port as show in the block diagram below,
- b. Spectrum Setting : RBW= 100KHz, VBW=100KHz, Sweep time = 200 ms.

**6.1.3 DEVIATION FROM STANDARD**

No deviation.

**6.1.4 TEST SETUP**



#### 6.1.5 EUT OPERATION CONDITIONS

The EUT tested system was configured as the statements of 4.1.6 Unless otherwise a special operating condition is specified in the follows during the testing.

**6.1.6 TEST RESULTS**

EUT :	Wireless Mouse	Model Name. :	L180
Temperature :	20°C	Relative Humidity :	60 %
Pressure :	1020 hPa	Test Power :	DC 3V
Test Mode :	TX CH01, CH16		

Channel of Worst Data: CH16			
The max. radio frequency power in any 100kHz bandwidth outside the frequency band		The max. radio frequency power in any 100 kHz bandwidth within the frequency band.	
FREQUENCY(MHz)	POWER(dBm)	FREQUENCY(MHz)	POWER(dBm)
2381.80	-59.39	2491.40	-59.27
Result			
In any 100kHz bandwidth outside the frequency band, the radio frequency power is at least 50dB below that in the 100kHz bandwidth within the band that contains the highest level of the desired power.			

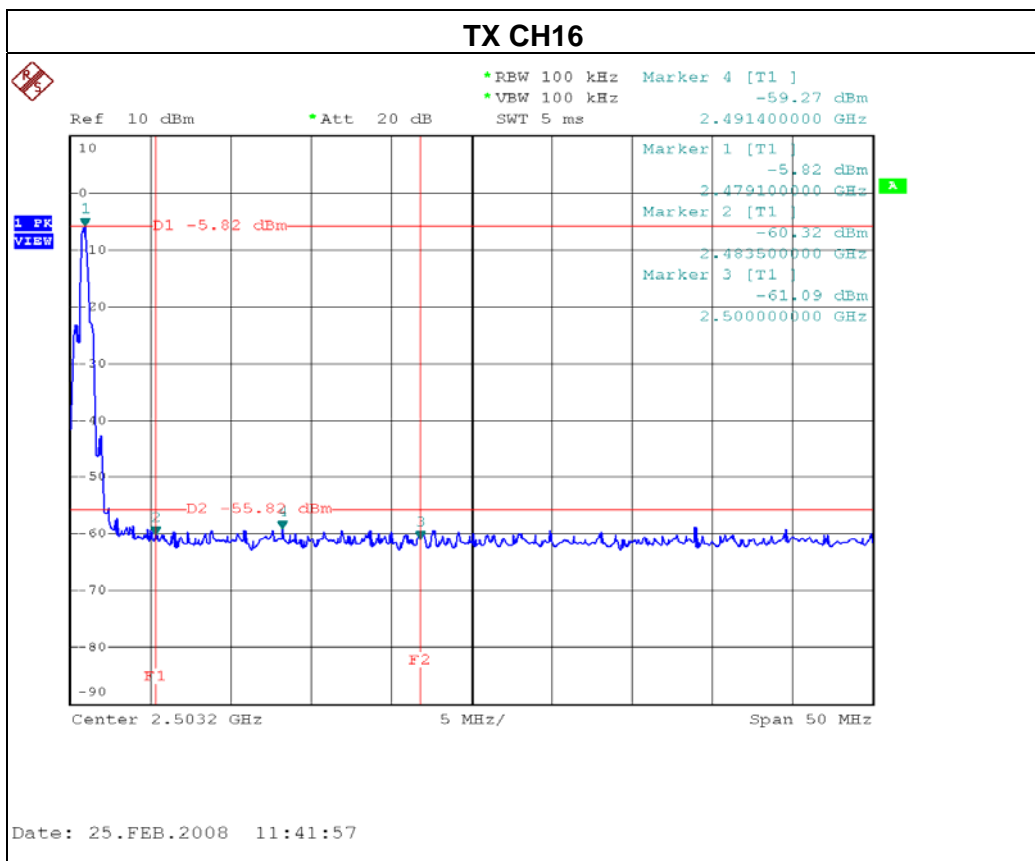
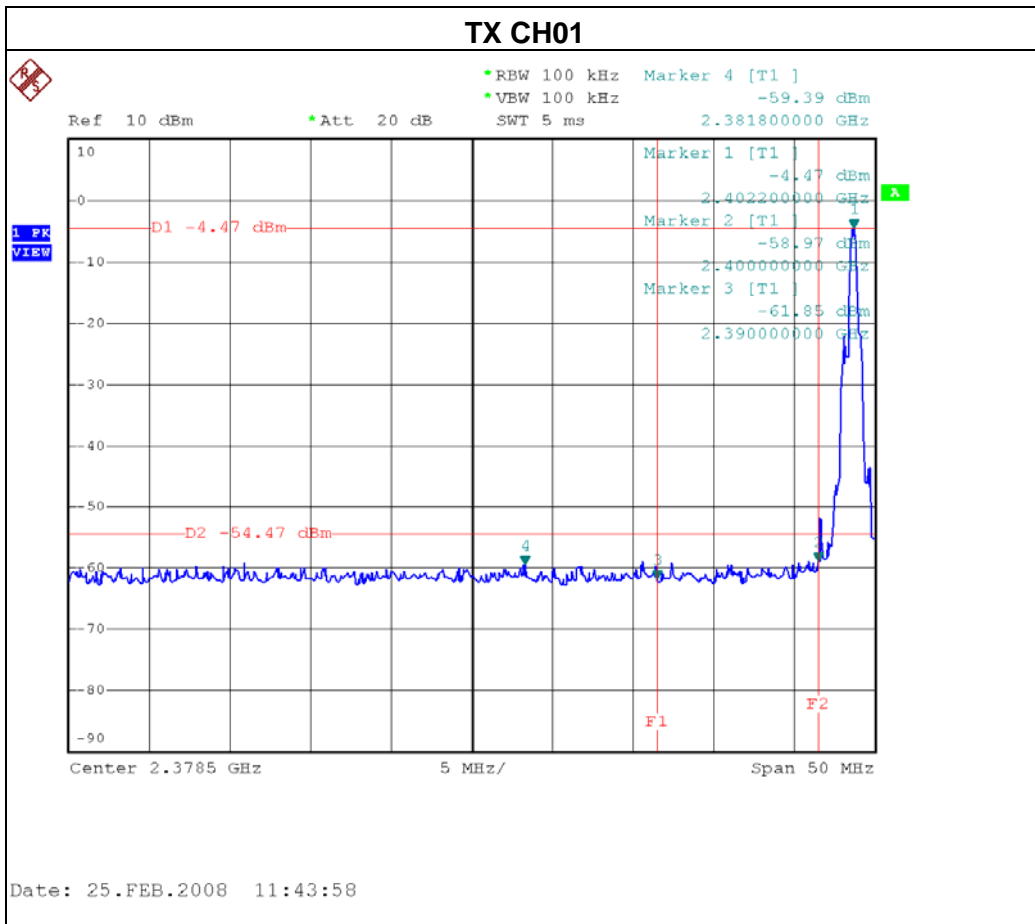

**7. EUT TEST PHOTO**

**Radiated Measurement Photos  
TX Mode**

