

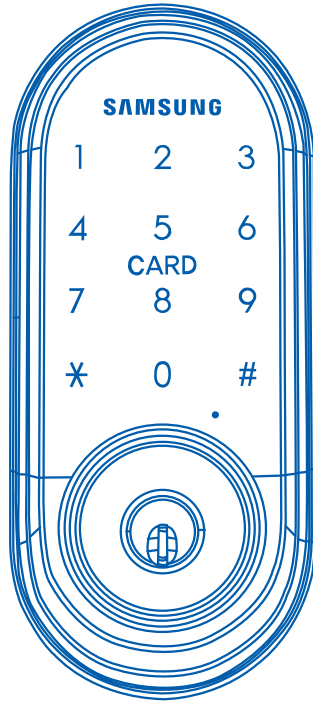

**SAMSUNG SDS**

Samsung  
**SMART** Doorlock



Samsung Smart Door Lock

# User Guide SHN-WDD510

Please review all included documentation and use the product as intended. Safety precautions must be followed to avoid personal injury or property damage.

## Table of Contents

<b>Introduction &amp; Helpful Tips</b> .....	2
<b>Installation</b> .....	3
Components & Tools .....	3
Door Preparation .....	4-5
Preparing the parts .....	6
Installing Lock .....	7
Setting of Right-Handed / Left Handed .....	10
<b>Programming</b> .....	11
Programming Features & Definitions .....	11-14
Changing the Master PIN Code .....	14
Managing User Pin Code/ Card .....	15-16
Register Network Module .....	17
Basic Lock Operation Overview .....	18
Privacy Mode Functions .....	18
Programming Through Menu Mode Using Master Code .....	19
<b>Miscellaneous</b> .....	20
Miscellaneous Information .....	20
Troubleshooting .....	21-22
User Registration Table .....	23
Product Specifications .....	24
Warranty .....	25-26
Drilling Template .....	27-29
Tailpiece Setting .....	31

## Introduction

Congratulations on the purchase of your Samsung Smart Door Lock! Your lock has a touch sensitive number display pad and optionally a 13.56MHz Card reader. Up to 100 users can be registered to gain access with unique Codes or Access Cards (supports ISO14443A type). The touchscreen makes it convenient to enter the code and the Randomizer function helps prevent lockpicking using fingerprint traces on the touchscreen. Other convenient functions such as Automatic Locking / Sound Setting, etc. provide advanced security and peace of mind. You can unlock the door using video intercom's monitor after connecting a Samsung video intercom. (Refer to page 9 for connection diagram to a video intercom).

## Helpful Tips

- Do not attempt to repair the product yourself.
- Change your codes regularly to ensure the security of your codes.
- Minimize the lock's exposure to moisture including wet hands and direct contact with liquids.
- Do not exert excessive force or use sharp instrument on the touchscreen.
- Insert the batteries according to correct polarity.
- When the low-battery warning sounds, replace all batteries immediately.
- Do not mix old batteries with new batteries.
- Use soft, dry cloth to clean the lock and avoid cleaning with water, alcohol or other chemicals.

# INSTALLATION

## Components & Tools

### Components and Drawing

**A** Exterior Unit

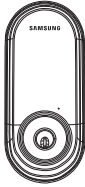

**B** Interior Unit



**C** Interior Mounting Plate



**D** Adjustable Deadbolt

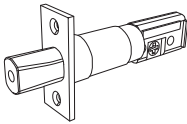

**E** Strike Parts



Strike

Dust Box

Reinforcement plate

**F** Magnetic Sensor

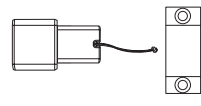

Door Side

Doorframe Side

**G1** Screw for Strike and Dead bolt

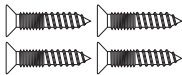

Spec: FH+T4x19

**G2** Screw for mounting plate



Spec: PH+M4x40

**G3** Screw for Interior unit

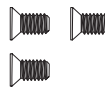

Spec: FH+M4x8

**G4** Screw for Reinforcement plate



Spec: FH+T5x76

**H** RF Tag

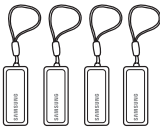

**I** Mechanical Keys



**J** Batteries

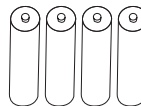

**K** User Manual



### Tools

#### Door Preparation

- 2-1/8"(54mm) hole saw: Main Hole
- 1"(25mm) hole saw: Dead bolt hole
- 1/8"(2.5mm) drill bit: Dead bolt screw hole
- Chisel and hammer
- Drill

#### Lock Installation

- #2 Phillips screwdriver
- Pincers: Cut the tailpiece

## Door Preparation

### Step 1. Check the Door Status

- 1) This lock supports door thickness of 1-3/8" to 2-5/32" (35 to 55mm).
- 2) Using the provided lock template, ensure that there are no obstructions that would prevent installing the lock properly.
- 3) Take note of which orientation the deadbolt will need to be installed, left hand or right hand.

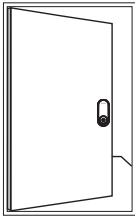

**Left-handed Door**  
When viewed from the Outside, the hinge is on the left.

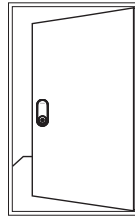

**Right-handed Door**  
When viewed from the Outside, the hinge is on the right.

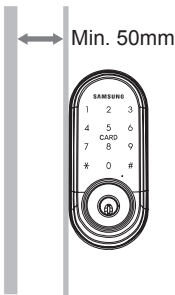

Please, be aware of that there has be more than 50mm gap between the door frame.

### Step 2. Mark on the Door

Check the location and direction of the deadbolt, attach the drilling template (page 27) on the side of the door, and mark on it with a pen.

- 1) Align the horizontal line across the door.
- 2) Align the vertical line over the door.
- 3) Mark the centers of the holes with the drilling template.
- 4) Mark the centerline of the deadbolt by aligning it with the vertical line.

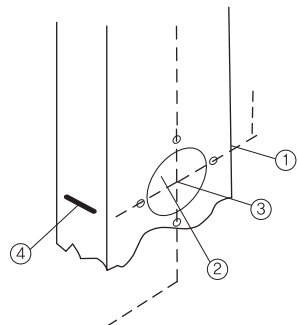

### Step 3. Drilling

- 1) Drill a 2-1/8" (54 mm) diameter hole through the door, as indicated on the template, using a hole saw.
- 2) Drill a 1" (25 mm) mortise hole using a hole saw.
- 3) Drill strike plate holes using a drill bit (1/8", 2.5 mm).

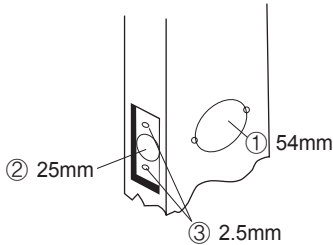

### Step 4. Strike Plate Installation

- 1) Using the template, locate the center horizontal line for the deadbolt hole, which lines up with the center of the 2-1/8" hole, and draw a horizontal line on the door frame to mark where you will make the deadbolt mortise hole.
- 2) Measure half the thickness of the door. Now, measure that distance from where the door stops at the frame when the door is closed toward the door jamb and mark a straight, vertical line the length of the door strike plate. Draw a horizontal line from the mark you made in Step 1 toward the vertical line. Where both lines cross, make a 1" (25 mm) diameter hole, 1/2" (13 mm) in depth.
- 3) Align the holes of the strike plate with the vertical line. Trace the outline of the strike plate and mortise with a 1/16" (1.6 mm) indentation. Attach the strike plate with the 2 screws provided.

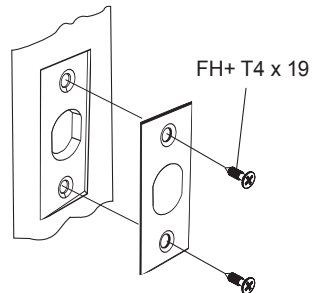

## Preparing the parts

### 1. Adjusting the length of the dead bolt

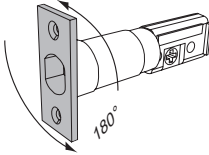

Turn the body of the dead bolt to adjust the length of the dead bolt.

It can be 60mm (2-3/8") or 70mm (2-3/4")

### 2. Changing the faceplate of the dead bolt

Change the faceplate of the dead bolt following the size of a strike hole.

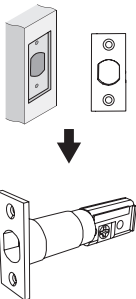

**Rectangle Strike hole**  
: No need to change.

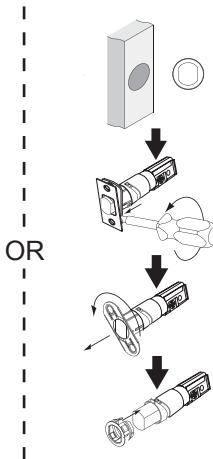

**Round Strike hole**

1. Remove the strike faceplate with a screw driver.
2. Turn the inner faceplate to take out it.
3. Insert the round faceplate.

### 3. Adjusting the length of the tailpiece

#### How to cut

1. Press the V-cut line with pincers to make more cut line.
2. Hold the end of the tailpiece with pincers.(Cut the tailpiece 5mm longer than the door thickness.)
3. Bend it up and down until it is separated.

- For more information, refer to page 31.

# Installing lock

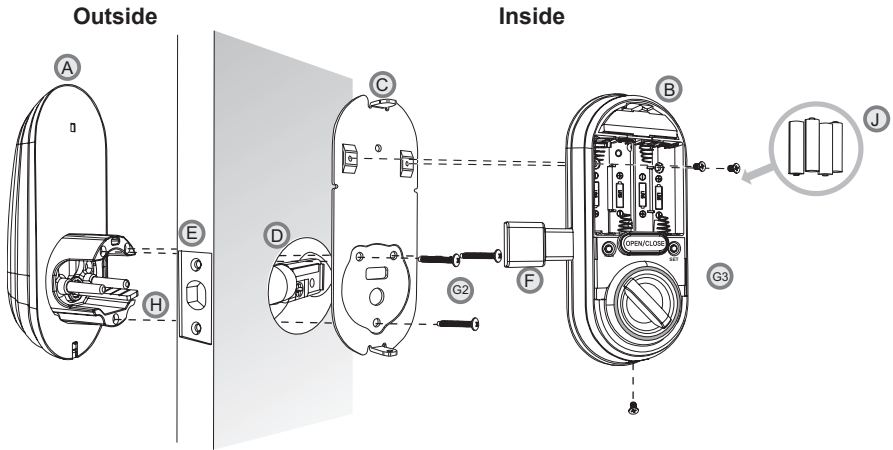

## 1. Installing the Dead Bolt(E)

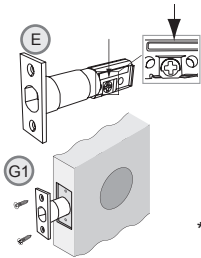

### 1. Before installation

- 1) Check the faceplate type of your door.
  - 2) Make sure the deadbolt direction as shown before inserting it into a door side.
2. Insert the deadbolt from the side of the door.
  3. Fix the deadbolt using two FH+T4X19 screws.

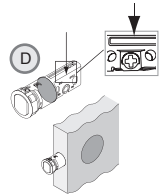

\*If there is round strike hole, change the faceplate, and insert the deadbolt following right side drawing.

## 2. Installing the Exterior Unit

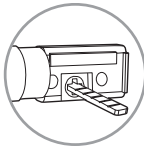
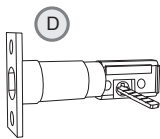

Left-handed

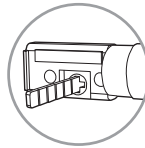

Right-handed

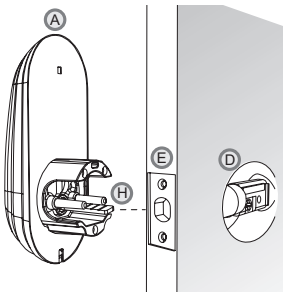

1. Ensure the Exterior Unit is aligned with the center hole of the deadbolt and Cut the tailpiece 5mm longer than the door thickness(refer to the page 31).
2. Attach the exterior unit.

**CAUTION:** The dead bolt must be in a retracted position. In case of right-handed door, insert the tailpiece vertically. In case of left-handed door, insert the tailpiece horizontally.

### 3. Installing the Mounting Plate

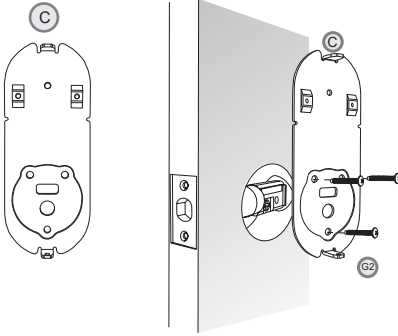

1. Detach the Interior Mounting Plate from the interior unit.
2. Fasten the interior mounting plate with three TH+M5x40 (G2) 90% of the way.
3. Align the Exterior Unit with the Interior Mounting Plate and then tighten the screws.
4. Cover the rubber pad on the Interior Mounting plate.

**CAUTION:** Do not over-tighten, and check the movement of dead bolt by the mechanical key.

### 4. Installing the Magnetic Sensor

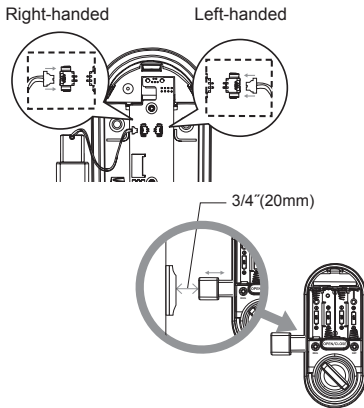

Install the door side magnetic sensor. It should be installed in right way of the door.

**CAUTION:** The gap of the magnet sensors between the door side and the door-frame should be within 3/4" (20mm). If the gap is too wide, pull out the door side magnetic sensor to adjust the gap enough to detect.

### 5. Connecting the cable

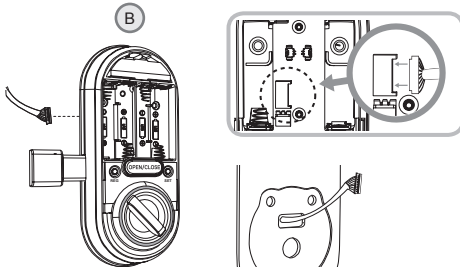

1. Connect the cable from the exterior unit to the interior unit.
2. After connecting the cable, push the cable into the hole of the door.



### 6. Fix Screw for the Interior Unit

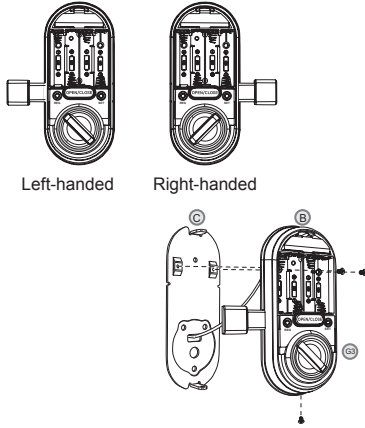

1. Before installing the interior unit, check the direction of the thumb turn while the dead bolt is in the OPEN POSITION.
2. Open the battery cover.
3. Align the Interior Unit on to the Interior Mounting Plate, and attach it with 4 screws.

**CAUTION:** Check the movement of the dead bolt by the thumb turn.

### 7. Final Check

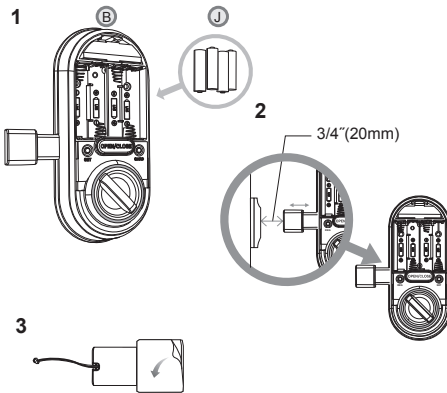

1. Install 4 batteries. A Melody will sound when all 4 batteries are installed correctly.
2. Close the door to detect the magnetic sensor. You can hear the beep sound when the magnetic sensor detects. After that, press [OPEN/CLOSE] button to check whether the dead bolt works properly.
3. Stick the magnetic sensor with attention on the distance.

**CAUTION:** The gap between the door side and the door-frame magnetic sensors should be close enough to be detected.

### OPTION : Connection for Video Intercom

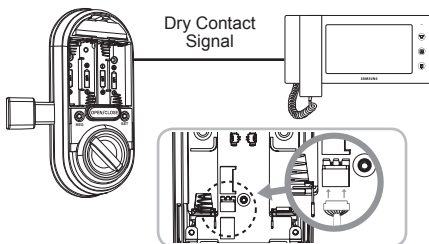

Connect the cable of video intercom to the Interior Unit.

SHN-WDD510 receives 1 second of dry contact signal to open the door remotely. It is normally compatible with SHT-3006 and other Samsung Video Intercom systems.

# Setting of Right-Handed / Left Handed

\*All status should be checked while the dead bolt is in OPEN POSITION.

Left-handed

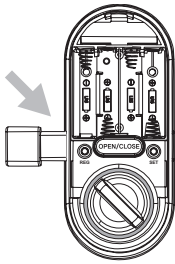

Right-handed

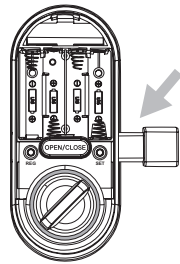

Right-handed

Left-handed

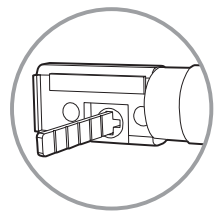
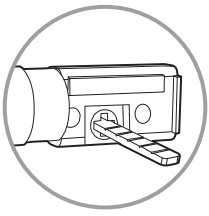
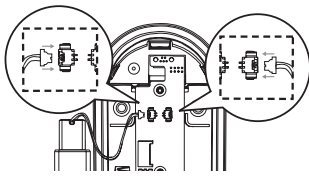

Tailpiece

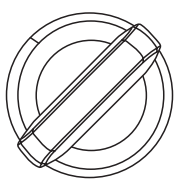
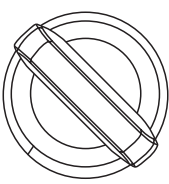

Thumb turn

# PROGRAMMING

## Programming Features

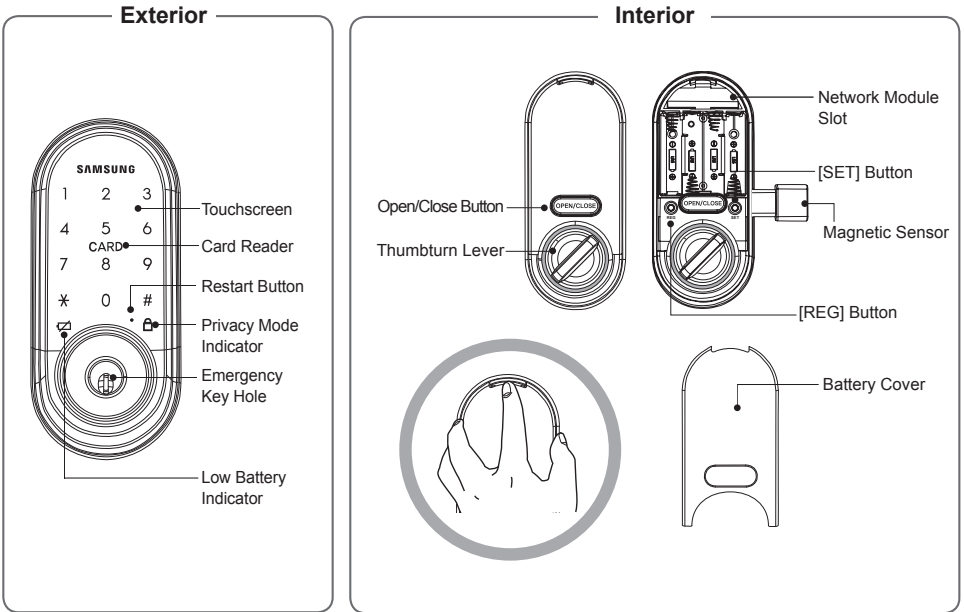

Symbols	Description	Symbols	Description
	Touch the <b>[Touchscreen]</b> .		Press the <b>[*]</b> button. It is used to complete number entry.
	<b>SET:</b> Used for setting the Additional Functions.		Enter the Master PIN Code (4~10 digits). Factory Default: <b>1234</b>
	<b>REG:</b> Open the battery cover of the Interior Unit and press the <b>[REG]</b> button. It is used to begin or exit the Program mode.		Press the Number buttons.
	<b>REG3:</b> Press the <b>[REG]</b> button for 3 seconds.		
	Enter the User PIN Code (4~10 digits).		Repeat the process inside the rectangle.

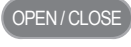
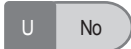
Symbols	Description	Symbols	Description
	Touch the Card reader with the User Card.		Press the [OPEN/CLOSE] button.
	Enter the User Number. Can be set from 1 to 100.		

## Definitions

**Indicator Lamp** : Indicates the operational status when the Card is being read or the lock is in operation.

**Intrusion Detection Function** : When the Interior Unit is forcibly detached while the door is locked, it is detected by the magnetic sensor and an alarm is sounded. (The function is not activated when the magnet is not used.)The Intrusion Detection function is a basic function and cannot be enabled or disabled.

**Locking Mode (Auto/Manual)** : You can enable or disable the function for locking the door automatically when it is closed. The factory default is 'Auto mode'.

- Auto: The door is locked automatically 2 seconds after it is closed. However, it does not function if the magnet is not used or the batteries are completely discharged.

- Manual: When the door does not lock automatically when it is closed, touch the [Touchscreen] or the [OPEN/CLOSE] button on the Interior Unit will lock the door.

**Low Voltage Indicator** : Refers to the state when the operating voltage of the lock is lower than the standard voltage, and activates the Low Voltage Alarm ("Please change the batteries") to indicate that the batteries need to be replaced. Use the Emergency Key when the batteries are completely discharged. In case of the low voltage, the low-voltage LED flickers when using doorlock.

**Magnetic Sensor** : Detects the opening and closing of the door.

**Thumbturn Lever** : When the batteries are completely discharged, this device is used to mechanically lock or unlock the door from inside.

**Master PIN Code** : You can enter only one Master PIN (4-10 digits) Code. You can register the User PIN Codes/Cards after authenticating with the Master PIN (4-10 digits) Code. You can open the door with the Master PIN Code, and the factory default is '1234'.

**OPEN/CLOSE Button** : A one-touch button to open the locked door. (It is also used to lock the door from inside in the Manual locking mode.)

**Privacy Mode** : Privacy Mode prevents the lock from being unlocked from the outside. You can enable it by using the [OPEN/CLOSE] button. The Privacy Mode LED on, when Privacy Mode function is activated.

**Random Security Function** : This mode prevents the disclosure of the PIN Code by entering the PIN Code after authenticating 2 arbitrarily selected numbers. When the buttons for 2 arbitrarily selected numbers are illuminated, pressing the 2 illuminated buttons illuminates the whole touchscreen. You can enable or disable the Random Security function. This function is **enabled** by default.

**Registration Button** : This button is used to change Master PIN Code/User PIN Codes/User

Cards or the lock settings. It is found below the battery cover of the Interior Unit. The length of time the [REG] button is pressed varies depending on the function.

**Resetting** : Deletes all registered information and restores the factory default. After resetting, change the Master PIN Code for security.

**Restart Button** : This button resets the lock when the lock stops functioning. Registered information is not deleted.

**Set Button** : Used for setting the Additional Functions. It is found below the battery cover of the Interior Unit.

**Sound Setting** : The volume during the input of numbers and opening or locking of the door can be set from Level 0 ~ Level 2. The sound is muted at Level 0 and is at maximum volume at Level 2. The registration mode operates at Level 1 regardless of the sound setting.

**User Card** : You can register up to 100 User Cards including the User PIN Codes. You can open the door with a User Card.

**User Number** : It is the same number as the registered user's address and can be set from 1 to 100. The User Number should be managed with caution as it is used to register or delete User PIN Codes/Cards.

**User PIN Code** : You can register up to 100 User PIN Codes (4-10 digits) including the User Cards. You can open the door with a User PIN Code.

**Network Module** : After registering Network Module, Smart doorlock is able to be remotely-controlled via Gateway(optional).

## Status Indicators

### Low Battery Indicator

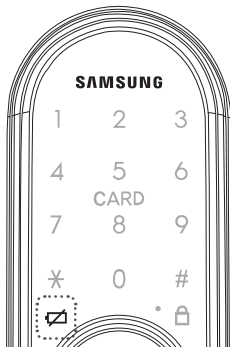

### Privacy Mode Indicator

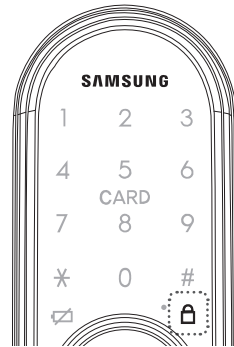

## Lock Activation



Touch the **[Touchscreen]**.  
Touch lock with back of hand or fingers to activate.

## Changing the Master PIN Code

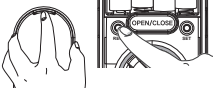

Open the battery cover of the Interior Unit and press the **[REG]** button briefly.



When the touchscreen is illuminated, enter the current Master PIN Code (default is '1234') and press the **[\*]** button.

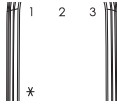

Press the **[\*]** button after pressing the **[1]** button.

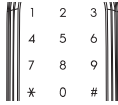

Enter the new Master PIN Code and press the **[\*]** button.

**Note:** Master PIN Code must be 4~10 digits.



# Managing User PIN Code/ Card

## Registering a User PIN Code/ Card

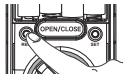

Open the battery cover of the Interior Unit and press the **[REG]** button briefly.



When the touchscreen is illuminated, enter the current Master PIN Code (default is '1234') and press the **[\*]** button.

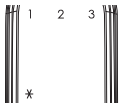

Press the **[\*]** button after pressing the **[2]** button.

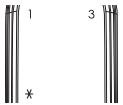

Press the **[\*]** button after pressing the **[1]** button.



Enter a User Number (1~ 100) to register the User PIN Code and press the **[\*]** button.  
 \*Choose a User Number that has not already been used.  
 \*\*If don't enter a User Number and press (0) when registering, the User Number is sequentially assigned on the empty User Number from 1 to 100.

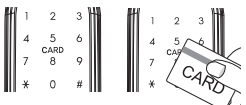

Enter a new User PIN Code and press **[\*]** button. Touch the Card reader with the Card to register.  
**Note:** User PIN Code must be 4~10 digits.



Enter another User Number or press the **[REG]** button to quit.



## Deleting User PIN Code / User Card

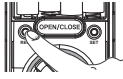

Open the battery cover of the Interior Unit and press the **[REG]** button briefly.

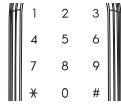

When the touchscreen is illuminated, enter the current Master PIN Code (default is '1234') and press the **[\*]** button.

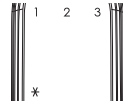

Press the **[\*]** button after pressing the **[2]** button.

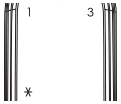

Press the **[\*]** button after pressing the **[3]** button.



Enter the User Number (1 to 100) and press the **[\*]** button.

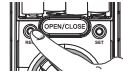

Enter another User Number or press the **[REG]** button to quit.







# Managing Network Module

## Registering Network Module

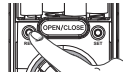
**Note:** After registering Network Module, Smart doorlock is able to be remotely controlled via Gateway(optional).



Open the battery cover of the Interior Unit and press the **[REG]** button briefly.



When the touchscreen is illuminated, enter the current Master PIN Code (default is '1234') and press the **[\*]** button.

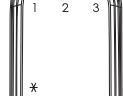

Press the **[\*]** button after pressing the **[3]** button.

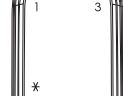

Press the **[\*]** button after pressing the **[1]** button.



## Deleting Network Module

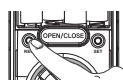

Open the battery cover of the Interior Unit and press the **[REG]** button briefly.



When the touchscreen is illuminated, enter the current Master PIN Code (default is '1234') and press the **[\*]** button.

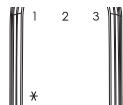

Press the **[\*]** button after pressing the **[3]** button.

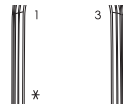

Press the **[\*]** button after pressing the **[3]** button.



## Basic Lock Operation Overview

### Opening the Door with a PIN Code

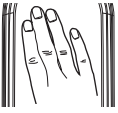

Touch the **[Touchscreen]**.

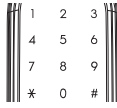

Enter the PIN Code and press the **[\*]** button.

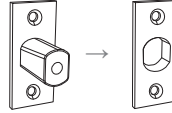

The door opens within one second.

### Opening the Door with a Card

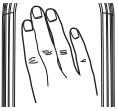

Touch the **[Touchscreen]**.

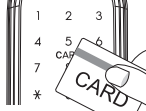

Touch the Card reader with an Access Card

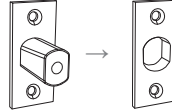

The door opens within one second.

## Privacy Mode Functions

### Activating Privacy Mode

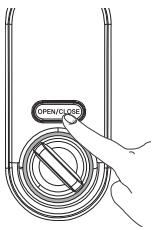

Press the **[OPEN/CLOSE]** button for 3 seconds while the door is locked.

**OPEN / CLOSE** 3

### Deactivating Privacy Mode

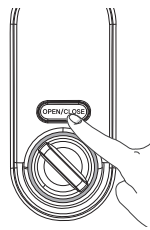

Press the **[OPEN/CLOSE]** button or turn the Thumbturn lever.

**OPEN / CLOSE**

# Programming Through Menu Mode Using Master Code

## Program Operation in Master Mode

\*: Master Program Mode Only

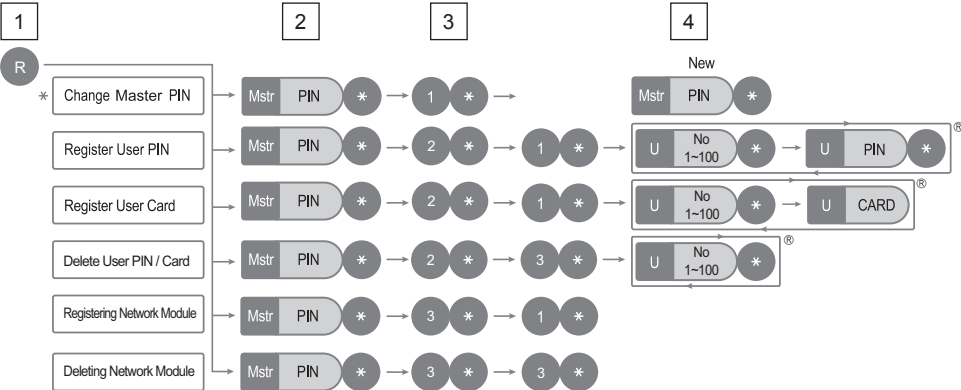

**Note:** Maximum number of user registration is 100. (User PIN Codes, User Cards, Key Fobs)

## Additional Function Mode

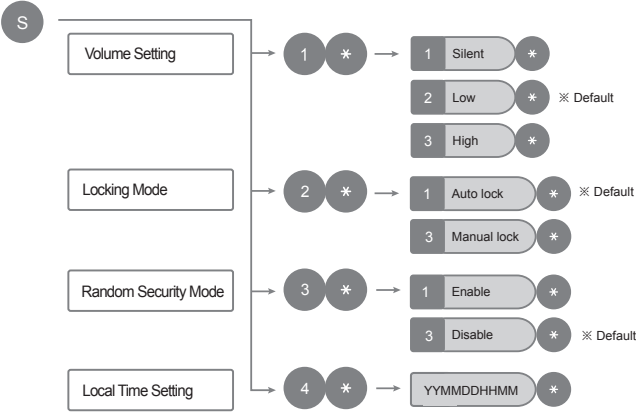

# MISCELLANEOUS

## Miscellaneous Information

### Reset to Factory Default

Resetting the lock will delete all registered information.

**Note:** All registered Master and user data will be deleted, and the lock will be reset to default settings.



Press the **[REG]** button for 3 seconds.

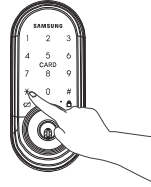

Enter the current Master PIN Code or "4560852580" and press the **[\*]** button.

Function	Factory Default
Master PIN Code	1234
Volume	Low
User PIN Code/Card	None
Locking Mode	Auto
Random Security	Disabled

### Restart Function

**Note:** Restarting does not delete registered information.

If there is no response after touching the **[Touchscreen]**, use a pin to press the **[Restart]** button on the left of the external power contact of the Exterior Unit.

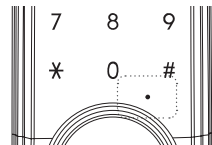

## Troubleshooting

When the lock doesn't function correctly, please check the items below.

If you can't resolve the problem, please contact the nearest service center.

Problem	Resolution	Reference
There is no power.	<ul style="list-style-type: none"> <li>• Check if the batteries are inserted in the correct polarity.</li> <li>• Check that the batteries have a full charge.</li> <li>• Check that the Exterior Unit cable has not come loose.</li> </ul>	-
I can't change the Master PIN Code.	<ul style="list-style-type: none"> <li>• There was a delay while changing the PIN Code. The touchscreen must be illuminated when changing the PIN Code. Also, after entering the first digit, the next digit must be entered within 20 seconds.</li> <li>• Replace the batteries if they are discharged.</li> <li>• Refer to the 'Changing the Master PIN Code' section in the user manual and try again. Ensure that the Master PIN Code is 4~10 digits long.</li> </ul>	Page 14
I can't register the User PIN Code.	<ul style="list-style-type: none"> <li>• The User Number has already been used. Delete the desired User Number and re-register.</li> <li>• Ensure that the User PIN Code is 4~10 digits long.</li> </ul>	Page 15
I can't register the User Card.	<ul style="list-style-type: none"> <li>• The User Number has already been used. Delete the desired User Number and re-register.</li> <li>• Ensure that the card is touched to the card reader within 20 seconds of entering the User Number.</li> </ul>	Page 15
I entered the PIN Code and pressed the [*] button, but the door won't open.	<ul style="list-style-type: none"> <li>• Check that the registered PIN Code was entered correctly.</li> <li>• If the touchscreen illumination turns off while entering the PIN Code, the button input was not registered. Touch the <b>[Touchscreen]</b> to illuminate the touchscreen and enter the PIN Code again from the beginning. (The touchscreen illumination is turned off automatically if there is no input within 5 seconds.)</li> </ul>	Page 18
I can't unlock the door with my Card.	<ul style="list-style-type: none"> <li>• The Card is either unregistered or unrecognized.</li> <li>• The Card must touch the Card reader correctly.</li> </ul>	Page 18
My PIN Code or Card is authenticated, but the door won't open.	The lock may be malfunctioning. Please contact service center.	-

<p>The door won't lock automatically when I close it.</p>	<ul style="list-style-type: none"> <li>● Check if Auto Locking is set. When Manual Locking is set, touching the <b>[Touchscreen]</b> locks the door.</li> <li>● If the door doesn't lock automatically when Auto Locking is set, then the lock has been installed incorrectly.</li> <li>● The Auto Locking function is not activated when the batteries are completely discharged. Check if the batteries are discharged.</li> </ul>	<p>Page 19</p>
<p>There is no response when I touch the <b>[Touchscreen]</b>.</p>	<ul style="list-style-type: none"> <li>● Use a pin to press the hole on the front of the Exterior unit.</li> <li>● If doing the above does nothing, contact the service center.</li> </ul>	<p>Page 20</p>



## Product Specifications

Item	Specifications	
Voltage	4 AA Alkaline 1.5V Batteries (LR6) (6V)	
Operation Method	Electronic Control Method (PIN Code entry or Card reading)	
Weight	1.8Kg (including both inside and Exterior Unit)	
Product Dimensions	Exterior Unit	69.8 mm (W) x 159.8 mm (H) x 35.2 mm (D)
		2-3/4" (W) x 6-9/32" (H) x 1-3/8" (D)
	Interior Unit	70.4 mm (W) x 163.8 mm (H) x 39 mm (D)
		2-25/32" (W) x 6-7/16" (H) x 1-17/32" (D)

The content of this manual is subject to change without prior notice to the user in order to enhance the performance of the product.

## FCC NOTICE

**NOTE :** This equipment has been tested and found to comply with the limits for a Class B digital device, pursuant to part 15 of the FCC Rules. These limits are designed to provide reasonable protection against harmful interference in a residential installation.

This equipment generates, uses and can radiate radio frequency energy and, if not installed and used in accordance with the instructions, may cause harmful interference to radio communications. However, there is no guarantee that interference will not occur in a particular installation. If this equipment does cause harmful interference to radio or television reception, which can be determined by turning the equipment off and on, the user is encouraged to try to correct the interference by one or more of the following measures:

- Reorient or relocate the receiving antenna.
- Increase the separation between the equipment and receiver.
- Connect the equipment into an outlet on a circuit different from that to which the receiver is connected.
- Consult the dealer or an experienced radio/TV technician for help.

### CAUTION :

- Changes or modifications not expressly approved by the manufacturer responsible for compliance could void the user's authority to operate the equipment.
- This equipment complies with the FCC RF radiation exposure limits set forth for an uncontrolled environment.

This equipment should be installed and operated with a minimum distance of 20cm between the radiator and any part of your body.



 LIMITED PRODUCT WARRANTY **Installation of the product is considered acceptance of warranty conditions**

SAMSUNG SDS CO., LTD (SAMSUNG SDS) warrants its products to be free from manufacturing defects in materials and workmanship for 12 months from the date of purchase. SAMSUNG SDS will, within said period, at its option, repair or replace any product failing to operate correctly without charge to the original purchaser or user.

This warranty shall not apply to any equipment, or any part thereof, which has been repaired by others, improperly installed, improperly used, abused, altered, damaged, subjected to acts of God, or on which any serial numbers have been altered, defaced or removed. SAMSUNG SDS does not warrant the performance or sale conditions of the seller/installer.

There are no warranties, express or implied, which extend beyond the description on the face hereof. There is no express or implied warranty of merchantability of a warranty of fitness for a particular purpose. Additionally, this warranty is in lieu of all other obligations or liabilities on the part of SAMSUNG SDS.

Any action for breach of warranty, including but not limited to any implied warranty of merchantability, must be brought within the six months following the end of the warranty period. In no case shall SAMSUNG SDS be liable to anyone for any consequential or incidental damages for breach or this or any other warranty, express or implied, even if the loss or damage is caused by the seller's own negligence or fault.

SAMSUNG SDS shall have no obligation under this warranty, or otherwise, if the product has been repaired by others, improperly installed, improperly used, abused, altered, damaged, subjected to accident, nuisance, flood, fire or acts of God, or on which any serial numbers have been altered, defaced or removed. SAMSUNG SDS and its distributor will not be responsible for any dismantling, reassembly or reinstallation charges. This warranty contains the entire warranty. It is the sole warranty and any prior agreements or representations, whether oral or written, are either merged herein or are expressly cancelled. SAMSUNG SDS neither assumes, nor authorizes any other person purporting to act on its behalf to modify, to change, or to assume for it, any other warranty or liability concerning its products. In no event shall SAMSUNG SDS be liable for an amount in excess of SAMSUNG SDS's original selling price of the product, for any loss or damage, whether direct, indirect, incidental, consequential, or otherwise arising out of any failure of the product. Seller's warranty, as hereinabove set forth, shall not be enlarged, diminished or affected by and no obligation or liability shall arise or grow out of Seller's rendering of technical advice or service in connection with Buyer's order of the goods furnished hereunder.

SAMSUNG SDS recommends that the entire system be completely tested weekly.

Warning: Despite frequent testing, and due to, but not limited to, any or all of the following; criminal tampering, electrical or communications disruption, it is possible for the system to fail to perform as expected. SAMSUNG SDS does not represent that the product/system may not be compromised or circumvented; or that the product or system will prevent any personal injury or property loss by burglary, robbery, fire or otherwise; nor that the product or system will in all cases provide adequate warning or protection. A properly installed and maintained alarm may only reduce risk of burglary, robbery, fire or otherwise but it is not insurance or a guarantee that these events will not occur.





Consequently, seller shall have no liability for any personal injury, property damage, or other loss based on a claim the product failed to give warning.

Therefore, the installer should in turn advise the consumer to take any and all precautions for his or her safety including, but not limited to, fleeing the premises and calling police or fire department, in order to mitigate the possibilities of harm and/or damage. SAMSUNG SDS is not an insurer of either the property or safety of the user's family or employees, and limits its liability for any loss or damage including incidental or consequential damages to SAMSUNG SDS's original selling price of the product regardless of the cause of such loss or damage.

Some states do not allow limitations on how long an implied warranty lasts or do not allow the exclusion or limitation of incidental or consequential damages, or differentiate in their treatment of limitations of liability for ordinary or gross negligence, so the above limitations or exclusions may not apply to you. This Warranty gives you specific legal rights and you may also have other rights which vary from state to state.

In case of the product defect, contact our authorized Customer Service Center. In order to exercise the warranty, you must contact our authorized Customer Service Center and obtain a proper RMA # - the product must be returned to our authorized Customer Service Center at user's shipping expense and the replacement product will be shipped back at our expense.

For product service, the product in all cases must be accompanied by below warranty form. Customer must ask the reseller or installer to fill out the warranty form indicated below, otherwise the product warranty may be considered void.

Visit our website at [www.sds.samsung.com](http://www.sds.samsung.com) and go to Support menu to find the contact information of our worldwide distributors.

-----  
Date of Purchase or Installation : \_\_\_\_\_ (MM/DD/YY)

Name, telephone and full address of purchaser : \_\_\_\_\_  
\_\_\_\_\_  
\_\_\_\_\_

Stamp or Signature of authorized reseller / installer

Product Code and Serial Number :

\_\_\_\_\_  
\_\_\_\_\_



**Drilling Template Sheet : 2-3/8" (60mm) Backset**

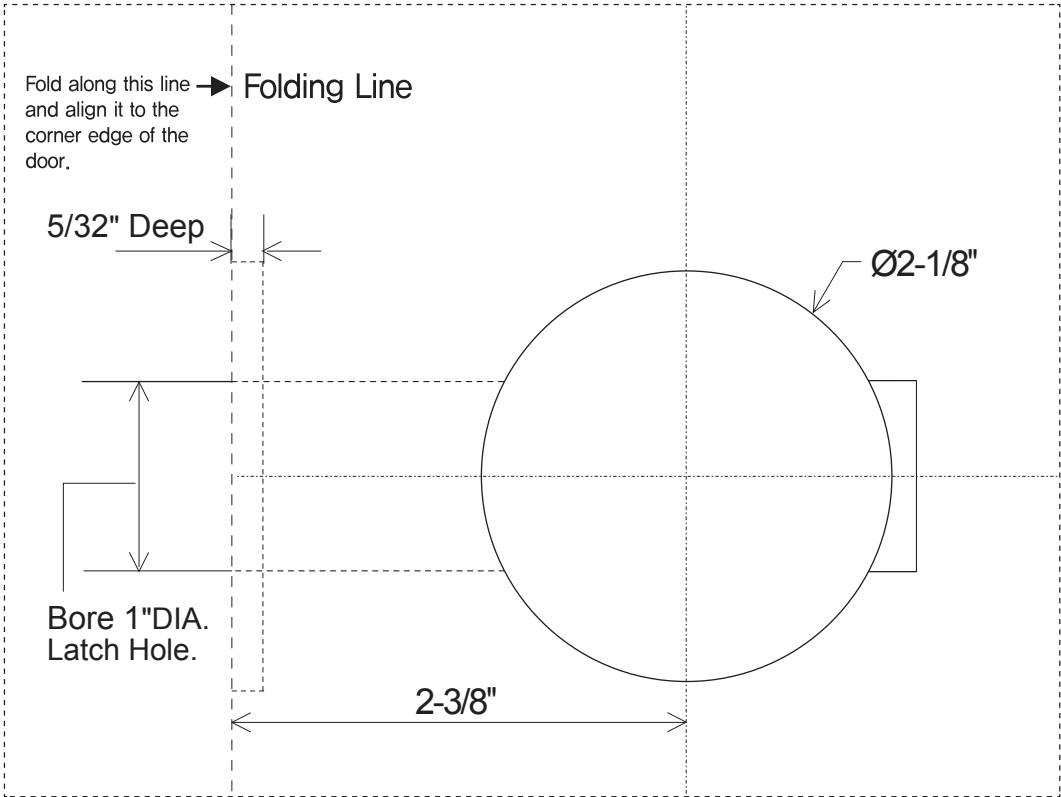

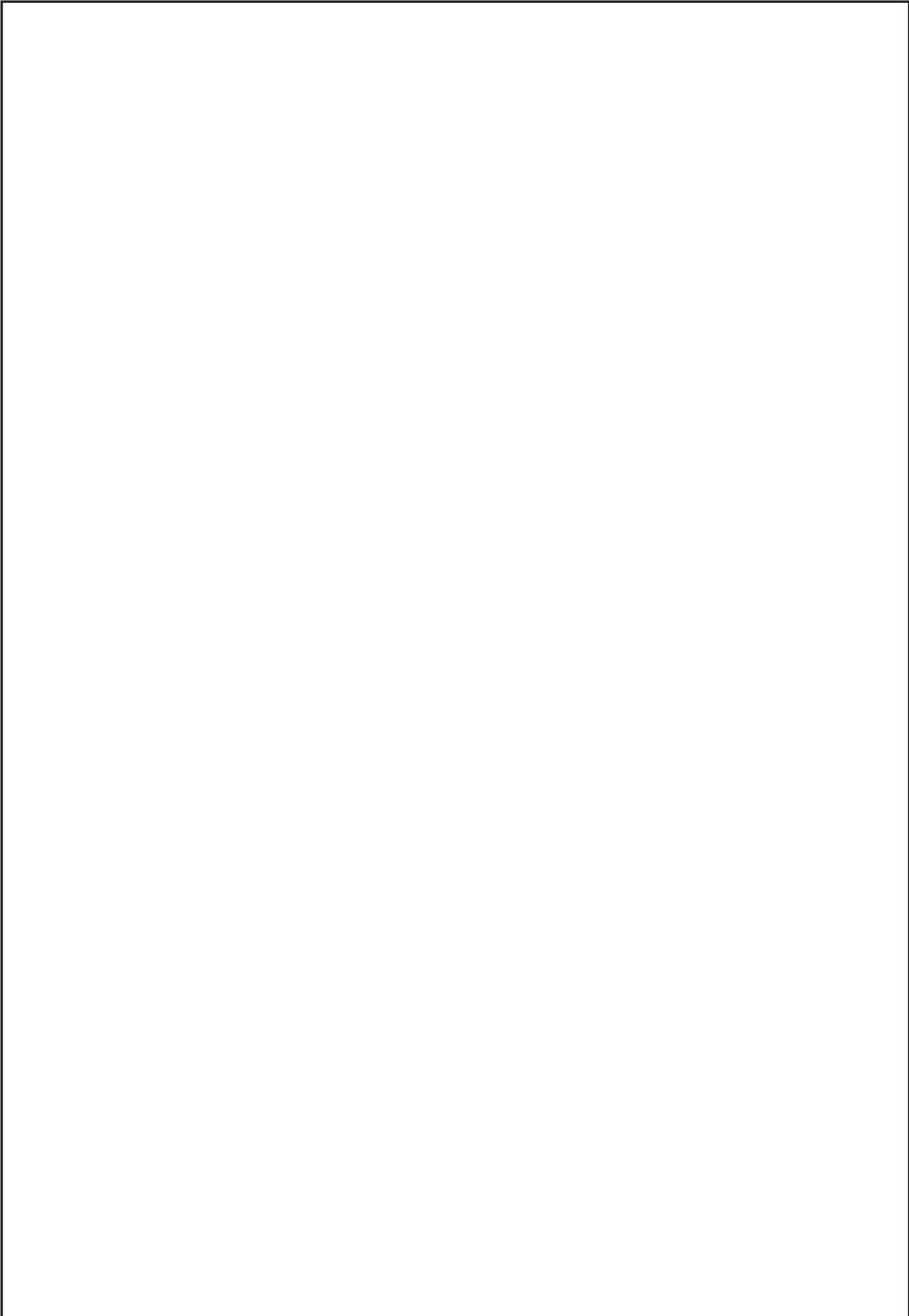

Drilling Template Sheet : 2-3/4" (70mm) Backset

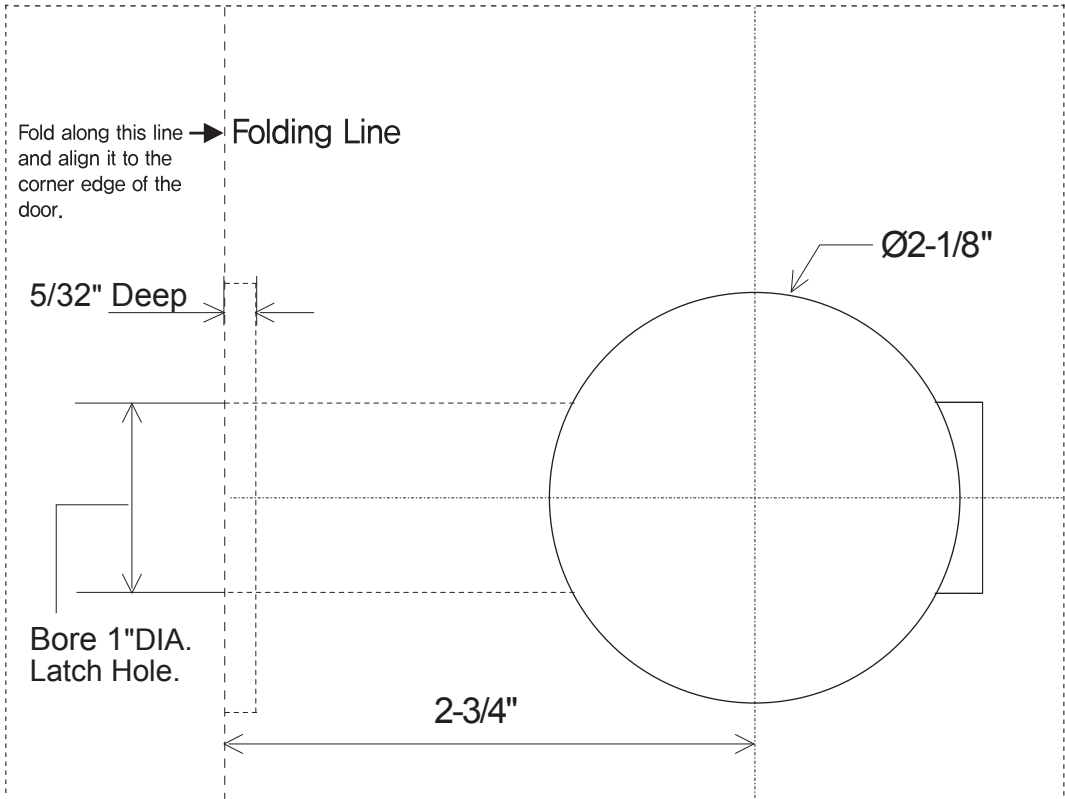

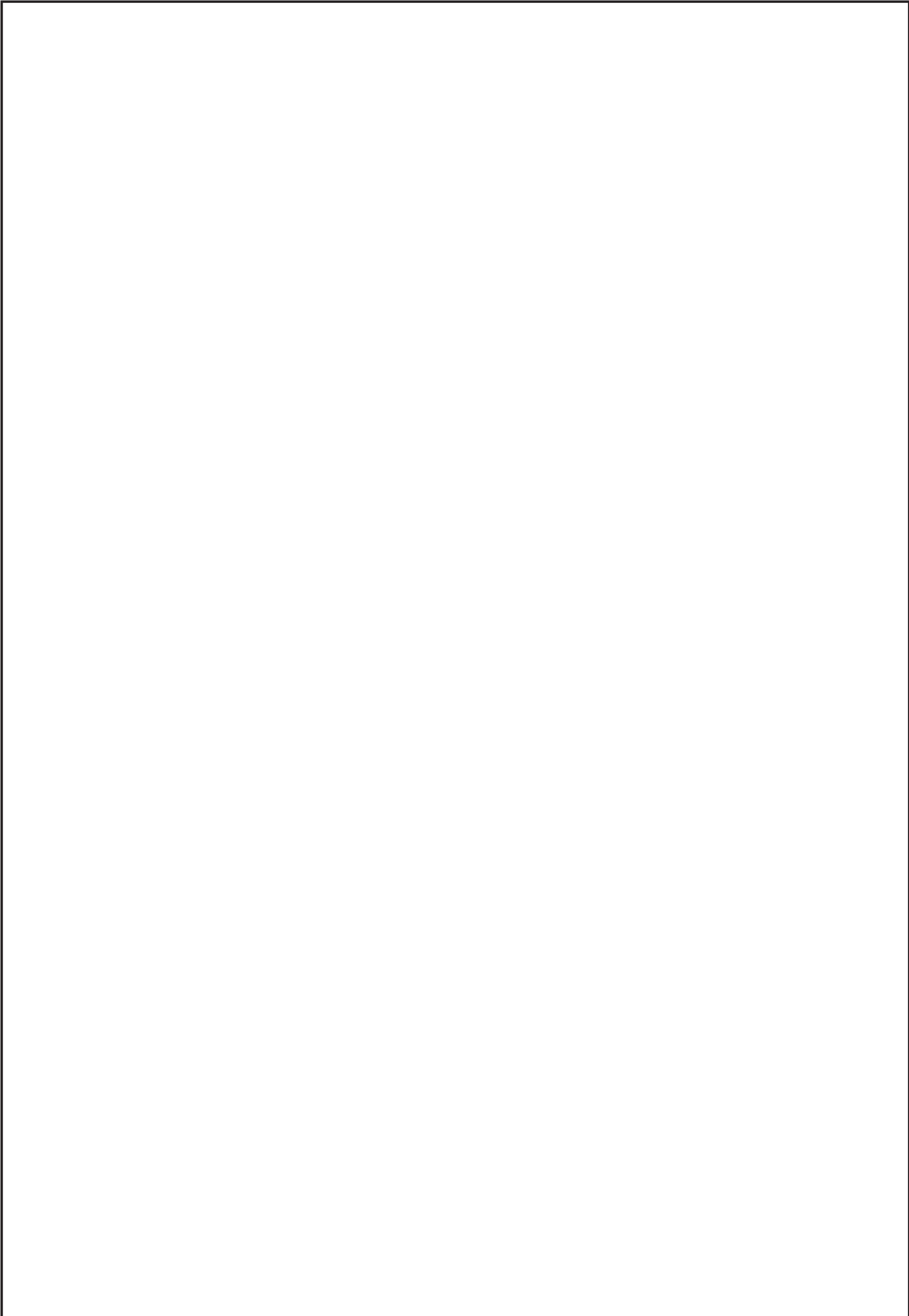

## Tailpiece Setting

• Tailpiece drawing

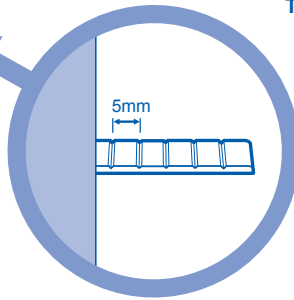
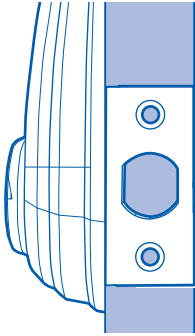

Thickness of the door

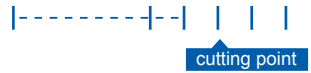

1. Check the thickness of your door.
2. According to your door thickness, cut the tailpiece.

**Note:** Cut the tailpiece 5mm longer than the door thickness.

### How to cut

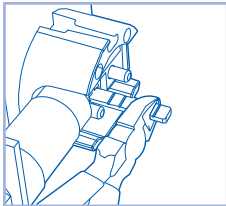

1. Press the V-cut line with pincers to make more cut line.

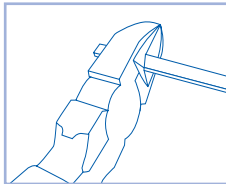

2. Hold the the end of the tailpiece with pincers.
3. Bend it up and down until it is separated.

**Product information and customer service contact**

**SAMSUNG SDS**

SAMSUNG SDS Co.,Ltd., reserves the right to change availability of any item in this catalog, its design, construction, and/or its materials.

Copyright © 2014, SAMSUNG SDS Co.,Ltd. All right reserved.

Reproduction in whole or in part without the express written permission of SAMSUNG SDS is prohibited.