



FCC/IC TEST REPORT

According to
CFR47 §15.407&RSS-247 Issue 2

Applicant : Mitac Digital Technology Corporation
Address : No.200, Wen Hwa 2nd Rd., Kuei Shan Dist. 33383 Taoyuan City,TAIWAN
Manufacturer : Mitac Computer (Kunshan) Co., Ltd.
Address : No. 269, 2nd Avenue, District A, Comprehensive Free Trade Zone, 215300
Kunshan, Jiangsu, PEOPLES REPUBLIC OF CHINA
Equipment : Tablet
Model No. : N642
FCC ID : P4Q-N642-M1005
IC : 2420C-N642-M1005
Test Period : July 25, 2019~August 15, 2019

- The test result refers exclusively to the test presented test model / sample.
- Without written approval of **Cerpass Technology (Suzhou) Co., Ltd.**, the test report shall not be reproduced exc- ept in full.
- The test report must not be used by the clients to claim product certification approval by any agency of the Government.

I **HEREBY CERTIFY THAT** :

The measurements shown in this test report were made in accordance with the procedures given in **ANSI C63.10 – 2013&FCC Part15.407&RSS-247 Issue 2** and the energy emitted by this equipment was **passed**.

Approved by:

Miro Chueh
EMC/RF Manager

Laboratory Accreditation:

Cerpass Technology Corporation Test Laboratory



TAF LAB Code: 1439

Cerpass Technology (SuZhou) Co., Ltd.



A2LA LAB Code: 4981.01



Contents

1. Test Configuration of Equipment under Test.....	5
1.1 Feature of Equipment under Test	5
1.2 Description of Antenna	6
1.3 Working Frequencies	7
1.4 Power Parameter Value	8
1.5 The Worst Transmission Mode	9
1.6 Duty Cycle	10
1.7 Test Manner	13
2. Technical Test	14
2.1 Summary of Test Result	14
2.2 General Information of Test	15
2.3 Measuring Equipment	16
2.4 Measurement Uncertainty	17
3. Test of Conducted Emission	18
3.1 Test Limit	18
3.2 Test Standard	18
3.3 Test Procedures	18
3.4 Test Setup	19
3.5 Test Result	20
4. Test of Radiated Emission.....	28
4.1 Test Limit.....	28
4.2 Test Standard	28
4.3 Test Procedures	29
4.4 Test Setup	30
4.5 Test Result	32
5. 26dB and 99% Occupied Bandwidth.....	58
5.1 Test Limit	58
5.2 Test Standard	58
5.3 Test Procedures	58
5.4 Test Setup	59
5.5 Test Result	60
6. 6dB Bandwidth Measurement	76
6.1 Test Limit	76
6.2 Test Standard	76
6.3 Test Procedures	76
6.4 Test Setup	76
6.5 Test Result	77
7. Power Output	81
7.1 Test Limit	81
7.2 Test Standard	81
7.3 Test Procedures	82
7.4 Test Setup	82



7.5	Test Result.....	83
8.	Power Spectral Density	89
8.1	Test Limit	89
8.2	Test Standard.....	89
8.3	Test Procedures.....	90
8.4	Test Setup.....	90
8.5	Test Result.....	91
9.	Band Edges Measurement	103
9.1	Test Limit	103
9.2	Test Standard.....	105
9.3	Test Procedures.....	105
9.4	Test Setup.....	106
9.5	Test Result.....	107

**History of this test report**

Report No.	Version	Issue Date	Description
SEFD1907033-A	Rev 01	Aug. 16, 2019	Original



1. Test Configuration of Equipment under Test

1.1 Feature of Equipment under Test

EUT Type	Tablet	
Model Name	N642	
Wireless Module	Qualcomm WCN3660B	
TX Frequency Range	2.4GHz: 2400MHz ~ 2483.5MHz 5GHz: 5150MHz~5350MHz, 5470MHz~5725MHz, 5725MHz~5850MHz	
Number of Channel	2.4GHz BT-BDR(GFSK): 79, BT-EDR(Pi/4 DQPSK): 79, BT-EDR(8DPSK): 79 BT-LE(GFSK): 40 802.11b/g, 802.11n-HT20 : 13 802.11n-HT40: 9 5GHz 802.11a, 802.11n-HT20: 25 802.11n-HT40: 12	
Type of Modulation	BT-BDR(GFSK), BT-EDR(Pi/4 DQPSK), BT-EDR(8DPSK) for FHSS BT-LE (GFSK) for DTS DBPSK, DQPSK, CCK for DSSS BPSK, QPSK, 16-QAM, 64-QAM for OFDM in 802.11a/g/n mode	
Data Rate	BT-BDR(GFSK): 1Mbps, BT-EDR(Pi/4 DQPSK): 2Mbps, BT-EDR(8DPSK) : 3Mbps, BT-LE(GFSK): 1Mbps 802.11b: up to 11Mbps, 802.11a/g: up to 54Mbps, 802.11n: up to MCS7	
Antenna Type	IFA	
Antenna Peak Gain	2.4~2.4835GHz: 4.35dBi, 5.15~5.35GHz: 2.91dBi,5.47~5.725GHz: 4.33dBi, 5.725~5.85GHz: 5.41dBi	
Device Category	Portable	
RF Exposure Environment	General Population/ Uncontrolled	
Power supply1	Model:	CVW120200
	Input:	100-240V~1.2A 50-60Hz 0.75A
	Output:	DC 12V --2.0A
Power supply2	Model:	POE-GTI-3556ND4
	Input:	100-240V
	Output:	DC 56V--0.625A



1.2 Description of Antenna

Manufacturer	Model	Specification
Awan	MIC-N642 Locking WIFI	IFA Antenna for WIFI 802.11a/b/g application



1.3 Working Frequencies

802.11a/n(20MHz) Working Frequency of Each Channel:							
Channel	Frequency	Channel	Frequency	Channel	Frequency	Channel	Frequency
36	5180 MHz	40	5200 MHz	44	5220 MHz	48	5240 MHz
52	5260 MHz	56	5280 MHz	60	5300 MHz	64	5320 MHz
100	5500 MHz	104	5520 MHz	108	5540 MHz	112	5560 MHz
116	5580 MHz	120	5600 MHz	124	5620 MHz	128	5640 MHz
132	5660 MHz	136	5680 MHz	140	5700 MHz	144	5720 MHz
149	5745 MHz	153	5765 MHz	157	5785 MHz	161	5805 MHz
165	5825 MHz	N/A	N/A	N/A	N/A	N/A	N/A
802.11n (40MHz) Working Frequency of Each Channel:							
Channel	Frequency	Channel	Frequency	Channel	Frequency	Channel	Frequency
38	5190 MHz	46	5230 MHz	54	5270 MHz	62	5310 MHz
102	5510 MHz	110	5550 MHz	118	5590 MHz	126	5630 MHz
134	5670 MHz	142	5710 MHz	151	5755 MHz	159	5795 MHz



1.4 Power Parameter Value

Ch.	Freq(MHz)	11a	802.11n HT20
36	5180	18	18
40	5200	18	18
48	5240	18	18
52	5260	18	18
56	5280	18	18
64	5320	18	18
100	5500	18	18
120	5600	18	18
140	5700	18	18
144	5720	18	18
149	5745	18	18
157	5785	18	18
165	5825	18	18

Ch.	Freq(MHz)	802.11n HT40
38	5190	18
46	5230	18
46	5230	18
54	5270	18
102	5510	18
118	5590	18
134	5670	18
142	5710	18
151	5755	18
159	5795	18



1.5 The Worst Transmission Mode

Test Mode
Mode 1: Transmit by 802.11 a 6Mbps
Mode 2: Transmit by 802.11n (20MHz) 6.5Mbps
Mode 3: Transmit by 802.11n (40MHz) 13.5Mbps



1.6 Duty Cycle

Mode	Frequency(MHz)	Measurement (%)
802.11a	5200	86.69
802.11a	5280	86.69
802.11a	5600	86.69
802.11a	5785	86.69

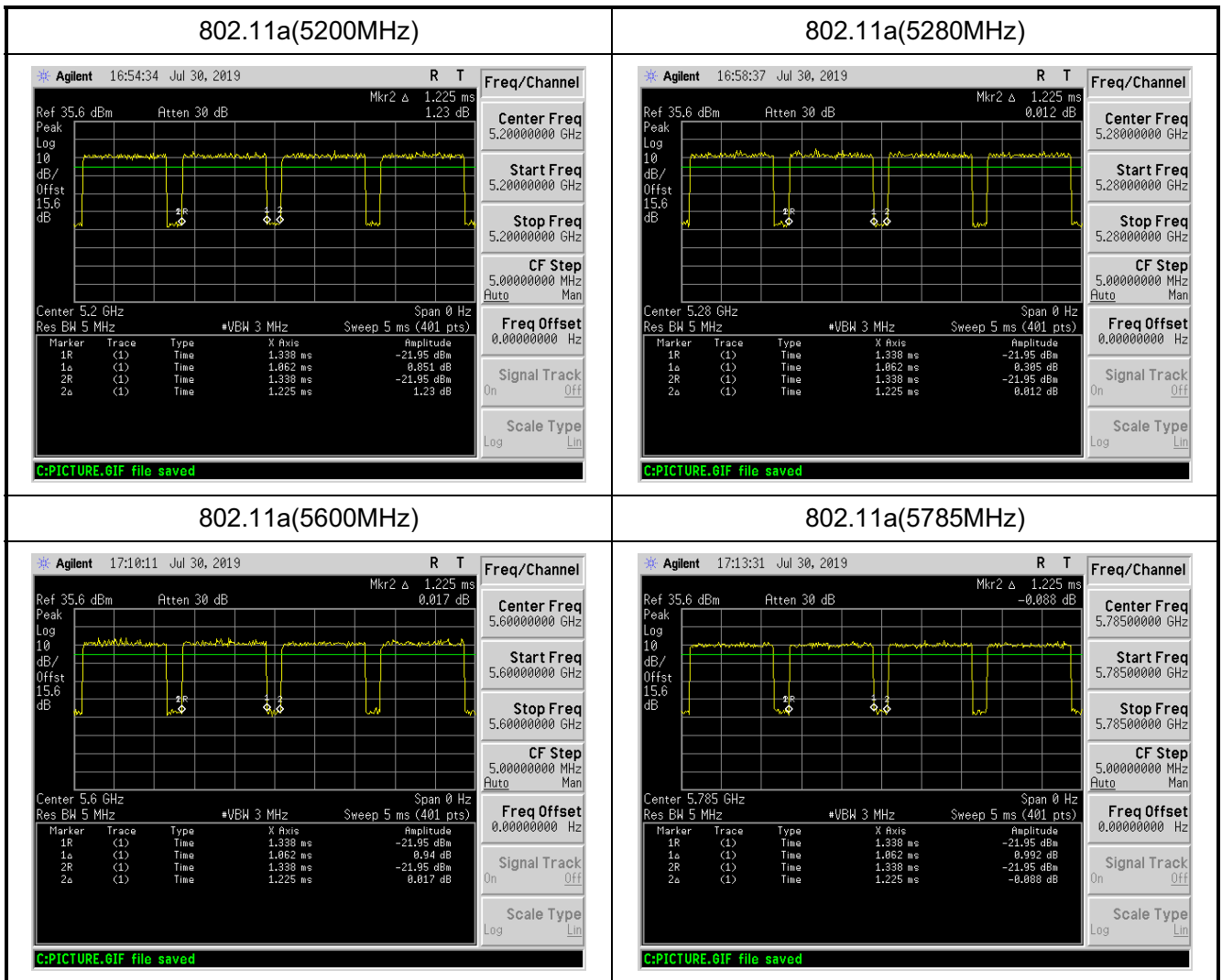



Mode	Frequency(MHz)	Measurement (%)
802.11n HT20	5200	86.29
802.11n HT20	5280	86.29
802.11n HT20	5600	86.29
802.11n HT20	5785	86.29

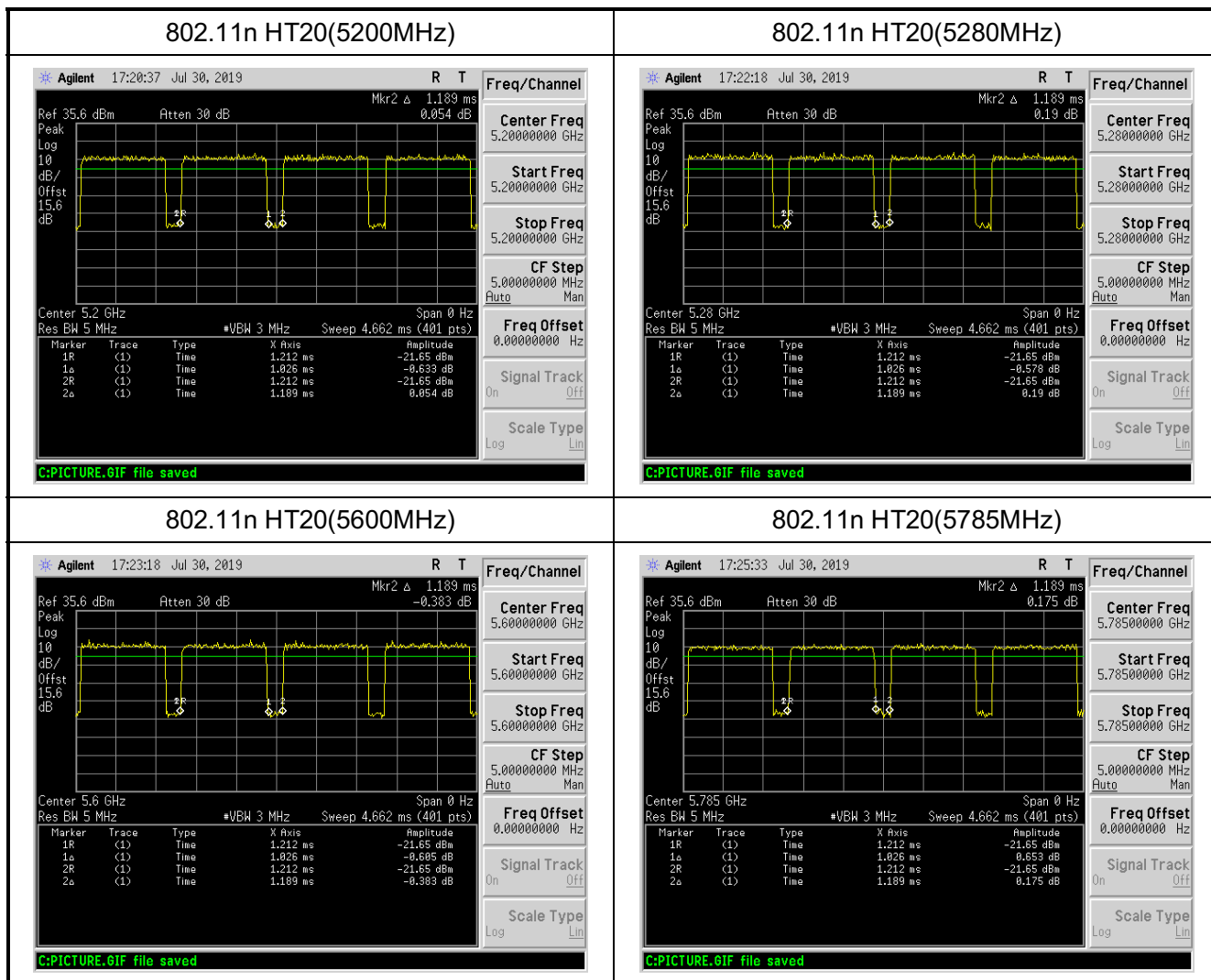



Mode	Frequency(MHz)	Measurement (%)
802.11n HT40	5190	73.91
802.11n HT40	5270	73.91
802.11n HT40	5590	73.91
802.11n HT40	5755	73.91

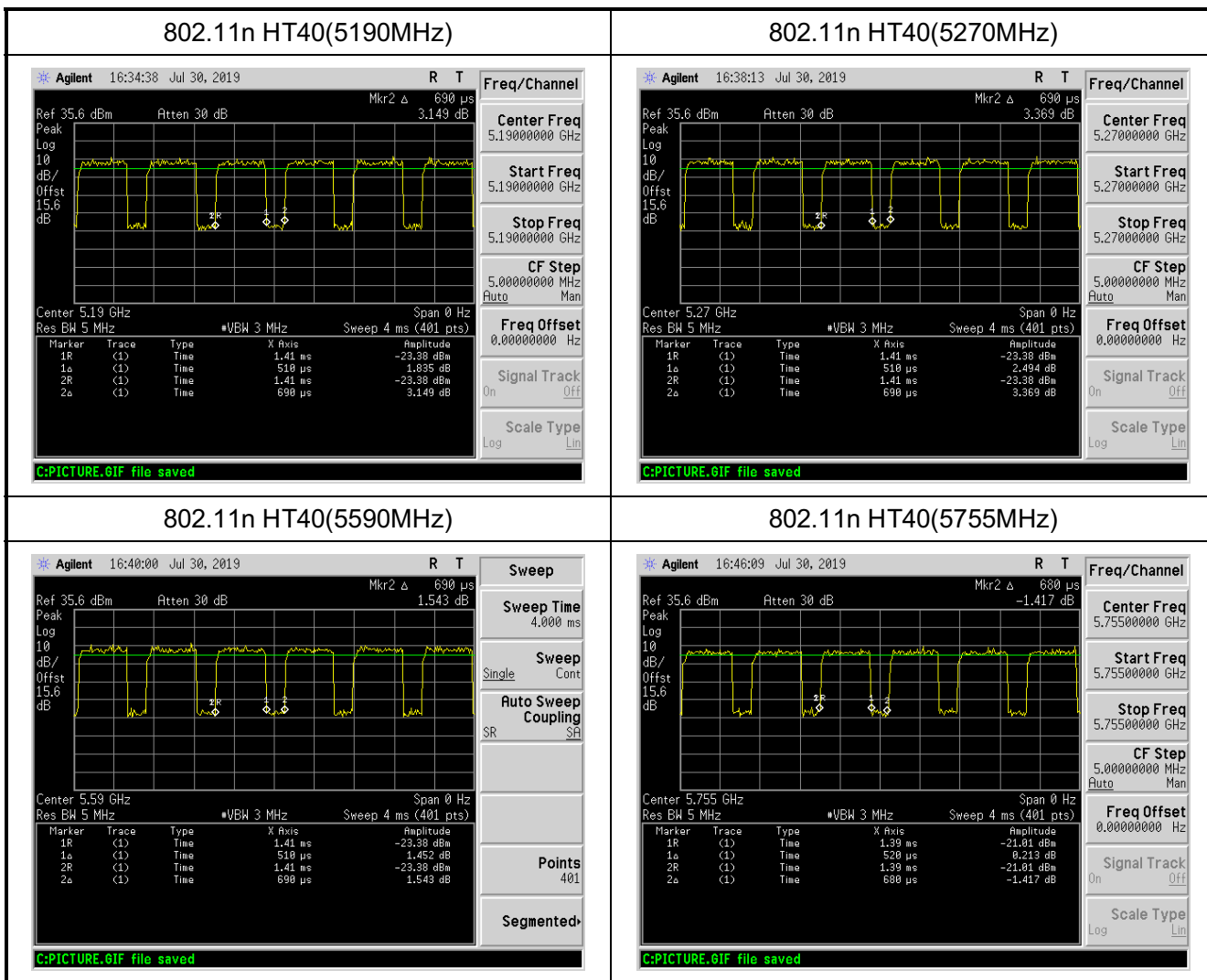



1.7 Test Manner

Test Manner	
a	Setup the EUT and simulators according to ANSI C63.10
b	Turn on the power of equipment.
c	Access the test software, set the test mode and test channel, then start to test.

Note: Regards to the frequency band operation: the lowest, middle and highest frequency of channel were selected to perform the test, then shown on this report.



2. Technical Test

2.1 Summary of Test Result

- No deviations from the test standards
 Deviations from the test standards as below description:

FCC/IC Part Section(s)	Test Description	Test Result
FCC 15.407(a)	26dB Bandwidth	Compliance
FCC 15.407(e) RSS-247 Issue 2 February 2017 Section 6.2.4.1	6dB Bandwidth	Compliance
FCC 15.407(h)(1) RSS-247 Issue 2 February 2017 Section 6.2.1.1& 6.2.2.1&6.2.3.1&6.2.4.1	Maximum Conducted Output Power	Compliance
FCC 15.407 (h)(1) RSS-247 Issue 2 February 2017 Section 6.2.1.1& 6.2.2.1&6.2.3.1&6.2.4.1	Transmit Power Control	Compliance
FCC 15.407(a)(1)(ii), (2), (3), (5) RSS-247 Issue 2 February 2017 Section 6.2.1.1& 6.2.2.1&6.2.3.1&6.2.4.1	Peak Power Spectral Density	Compliance
15.407(b)(1), (2), (3), (4)	Undesirable Emissions	Compliance
FCC 15.205, 15.209 15.407(b)(5), (6), (7) RSS-247 Issue 2 February 2017 Section 6.2.1.2& 6.2.2.2&6.2.3.2&6.2.4.2	General Field Strength Limits (Restricted Bands and Radiated Emission Limits)	Compliance
FCC 15.207 RSS-Gen Issue 4 November 2014 Section 8.8	AC Conducted Emissions 150kHz - 30MHz	Compliance



2.2 General Information of Test

<input type="checkbox"/>	Test Site	Cerpass Technology Corporation Test Laboratory Address: No.10, Ln. 2, Lianfu St., Luzhu Dist., Taoyuan City 33848, Taiwan (R.O.C.) Tel:+886-3-3226-888 Fax:+886-3-3226-881 Address: No.68-1, Shihbachongsi, Shihding Township, New Taipei City 223, Taiwan, R.O.C. Tel: +886-2-2663-8582
	TAF	1439
	FCC	TW1079, TW1061
	IC	4934E-1, 4934E-2
	VCCI	T-2205 for Telecommunication Test C-4663 for Conducted emission test R-4399, R-4218 for Radiated emission test G-812, G-813 for radiated disturbance above 1GHz
<input checked="" type="checkbox"/>	Test Site	Cerpass Technology (Suzhou) Co.,Ltd Address: No.66,Tangzhuang Road, Suzhou Industrial Park, Jiangsu 215006, China Tel: +86-512-6917-5888 Fax: +86-512-6917-5666
	CNAS	L5515
	FCC	CN1243
	A2LA	4981.01
	IC	7290A-1, 7290A-2
VCCI	T-1945 for Telecommunication Test C-12919 for Conducted emission test R-12670 for Radiated emission test G-227 for radiated disturbance above 1GHz	



2.3 Measuring Equipment

Instrument/Ancillary	Manufacturer	Model No.	Serial No.	Calibration Date	Due Date.
EMI Test Receiver	R&S	ESCI	101183	2019.06.28	2020.06.27
Preamplifier	HP	8447F	3113A05915	2019.02.25	2020.02.24
Preamplifier	FIELD	AFS44-00101800 -25-10P-44	1579008	2018.10.14	2019.10.13
Bilog Antenna	Sunol Science	JB1	A072414-1	2019.06.26	2020.06.26
Spectrum Analyzer	Agilent	N9010A	MY45118947	2018.10.11	2019.10.10
Temperature/ Humidity Meter	mingle	ETH529	N/A	2019.02.25	2020.02.24
Spectrum Analyzer	R&S	FSP40	100047	2019.03.07	2020.03.06
PREAMPLIFIER	AGILENT	8449B	3008A01954	2019.03.05	2020.03.04
HORN ANTENNA	EMCO	3115	31589	2019.03.09	2020.03.08
HIGH PASS FILTER	HP	84300-80038	002	2019.03.05	2020.03.04
SERIES POWER METER	ANRITSU	ML2495A	1224005	2019.03.05	2020.03.04
POWER SENSOR	ANRITSU	MA2411B	1207295	2019.03.05	2020.03.04
Bluetooth Tester	R&S	CBT	101133	2019.03.12	2020.03.11



2.4 Measurement Uncertainty

ISO/IEC 17025 requires that an estimate of the measurement uncertainties associated with the emissions test results be included in the report. The measurement uncertainties given below are based on a 95% confidence level (based on a coverage factor (k=2)).

RF Conducted Measurement

Test Item	Uncertainty	Limit	
Radio Frequency	$\pm 8.7 \times 10^{-7}$	$\pm 1 \times 10^{-5}$	
RF output power, conducted	$\pm 0.63 \text{dB}$	$\pm 1.5 \text{dB}$	
Power density, conducted	$\pm 1.21 \text{dB}$	$\pm 3 \text{dB}$	
Unwanted emissions, conducted	30-1000MHz	$\pm 0.51 \text{dB}$	$\pm 3 \text{dB}$
	1-25GHz	$\pm 0.67 \text{dB}$	$\pm 3 \text{dB}$
All emissions, radiated	30-1000MHz	$\pm 2.28 \text{dB}$	$\pm 6 \text{dB}$
	1-25GHz	$\pm 2.59 \text{dB}$	$\pm 6 \text{dB}$
Temperature	$\pm 0.8^\circ\text{C}$	$\pm 1^\circ\text{C}$	
Humidity	$\pm 3\%$	$\pm 5\%$	
DC and low frequency voltages	$\pm 3\%$	$\pm 3\%$	

AC Conducted Measurement

Measurement	Frequency	Uncertainty
Conducted emissions(LINE)	9KHz-30MHz	+/- 0.7738 dB
Conducted emissions(NEUTRAL)	9KHz-30MHz	+/- 0.7886 dB
Conducted emissions(10Mbps)	150KHz-30MHz	+/- 1.3013dB
Conducted emissions(100Mbps)	150KHz-30MHz	+/- 1.3197 dB
Conducted emissions(1000Mbps)	150KHz-30MHz	+/- 1.2987 dB

Radiated Measurement

Measurement	Polarity	Frequency	Uncertainty
Radiated emissions	Horizontal	below 1GHz	+/- 3.8936 dB
	Vertical	below 1GHz	+/- 3.8928 dB
	Horizontal	above 1GHz	+/- 5.18858dB
	Vertical	above 1GHz	+/- 5.18928 dB



3. Test of Conducted Emission

3.1 Test Limit

Conducted Emissions were measured from 150 kHz to 30 MHz with a bandwidth of 9 KHz on the 120 VAC power and return leads of the EUT according to the methods defined in ANSI C63.10-2013 Section 6.2. The EUT was placed on a nonmetallic stand in a shielded room 0.8 meters above the ground plane as shown in section 6.2.2. The interface cables and equipment positioning were varied within limits of reasonable applications to determine the position produced maximum conducted emissions.

Frequency (MHz)	Quasi Peak (dB μ V)	AVG (dB μ V)
0.15 – 0.5	66-56*	56-46*
0.5 – 5.0	56	46
5.0 – 30.0	60	50

*Decreases with the logarithm of the frequency.

3.2 Test Standard

ANSI C63.10: 2013 Section 6.2.

3.3 Test Procedures

The EUT was placed on a platform of nominal size, 1 m by 1.5 m, raised 80 cm above the conducting ground plane. The vertical conducting plane was located 40 cm to the rear of the EUT. All other surfaces of EUT were at least 80 cm from any other grounded conducting surface. The EUT and simulators are connected to the main power through a line impedance stabilization network (LISN). The LISN provides a 50 ohm /50uH coupling impedance for the measuring equipment. The peripheral devices are also connected to the main power through a LISN. (Please refer to the block diagram of the test setup and photographs) Each current-carrying conductor of the EUT power cord, except the ground (safety) conductor, was individually connected through a LISN to the input power source.

The excess length of the power cord between the EUT and the LISN receptacle were folded back and forth at the center of the lead to form a bundle not exceeding 40 cm in length.

Conducted emissions were investigated over the frequency range from 0.15MHz to 30MHz using a receiver bandwidth of 9 kHz.



3.4 Test Setup

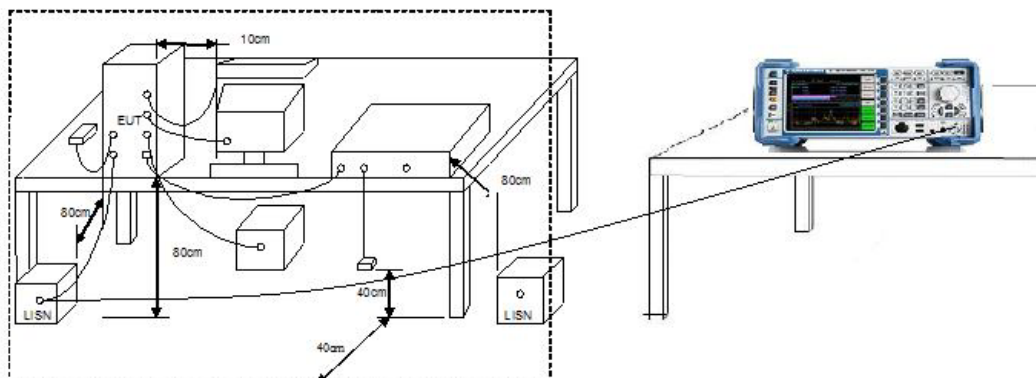



3.5 Test Result

Test Standard:	FCC_ClassB_QP	Probe:	L1
Test item:	Conduction Emission	Test Time:	2019/8/1310:21:43
Applicant:	Mitac Digital Technology Company	Power Rating:	AC 120V/60Hz
Product:	Tablet	Temp.(C)/Hum.(%)/Air p.(hpa):	26(°C)/60%/1000hpa
Model No.:	N642	Test Engineer:	Chris
Test Mode:	Wi-Fi 5G		
Remark:	Adapter Power		

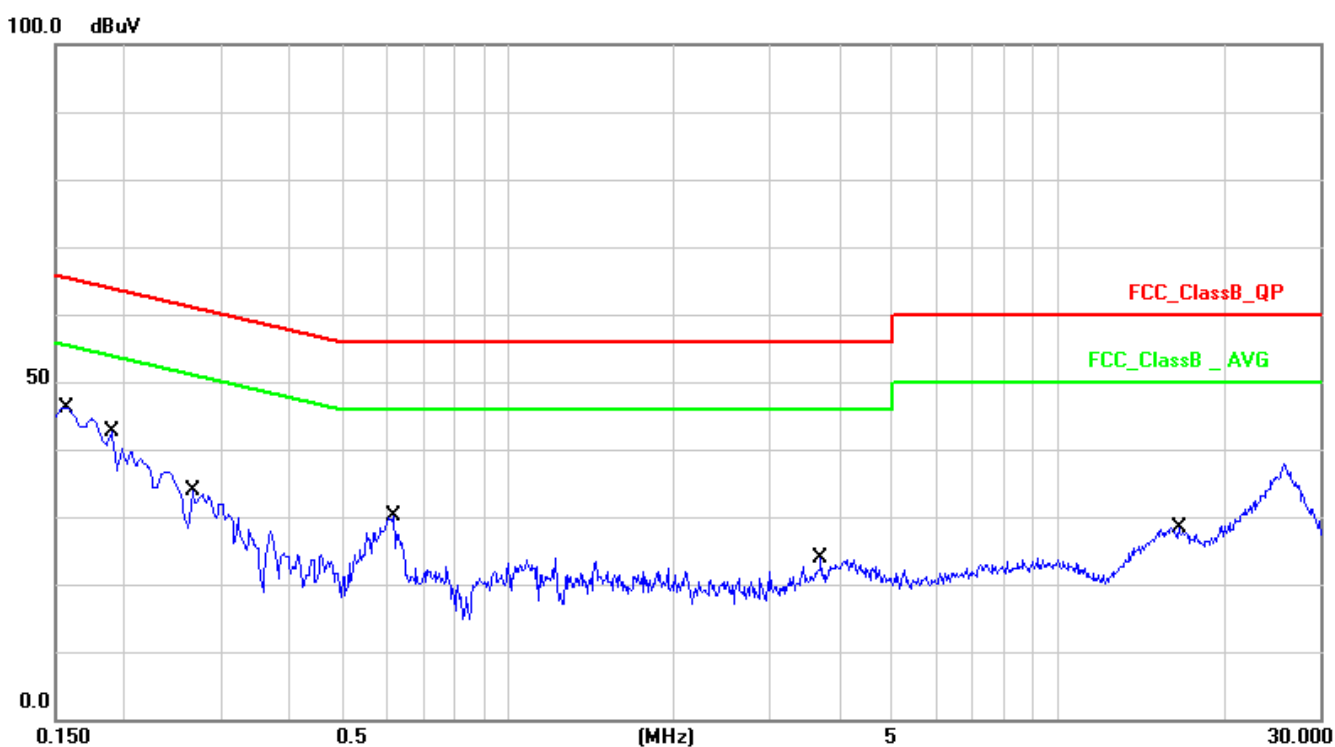

No.	Frequency (MHz)	Factor (dB)	Reading (dBuV)	Level (dBuV)	Limit (dBuV)	Margin (dB)	Detector
1	0.1580	10.15	32.42	42.57	65.56	-22.99	QP
2	0.1580	10.15	14.62	24.77	55.56	-30.79	AVG
3	0.1900	10.13	28.76	38.89	64.03	-25.14	QP
4	0.1900	10.13	10.40	20.53	54.03	-33.50	AVG
5	0.2660	10.14	20.95	31.09	61.24	-30.15	QP
6	0.2660	10.14	7.42	17.56	51.24	-33.68	AVG
7	0.6180	10.15	16.74	26.89	56.00	-29.11	QP
8	0.6180	10.15	6.93	17.08	46.00	-28.92	AVG
9	3.7020	10.23	6.36	16.59	56.00	-39.41	QP
10	3.7020	10.23	0.21	10.44	46.00	-35.56	AVG



11	16.5820	10.50	13.35	23.85	60.00	-36.15	QP
12	16.5820	10.50	7.17	17.67	50.00	-32.33	AVG

Note: Level = Reading + Factor

Margin = Level – Limit

Factor = (LISN or ISN or PLC or current probe) Factor + Cable Loss + Attenuator



Test Standard:	FCC_ClassB_QP	Probe:	N
Test item:	Conduction Emission	Test Time:	2019/8/1310:24:36
Applicant:	Mitac Digital Technology Company	Power Rating:	AC 120V/60Hz
Product:	Tablet	Temp.(C)/Hum.(%)/Air p.(hpa):	26(°C)/60%/1000hpa
Model No.:	N642	Test Engineer:	Chris
Test Mode:	Wi-Fi 5G		
Remark:	Adapter Power		

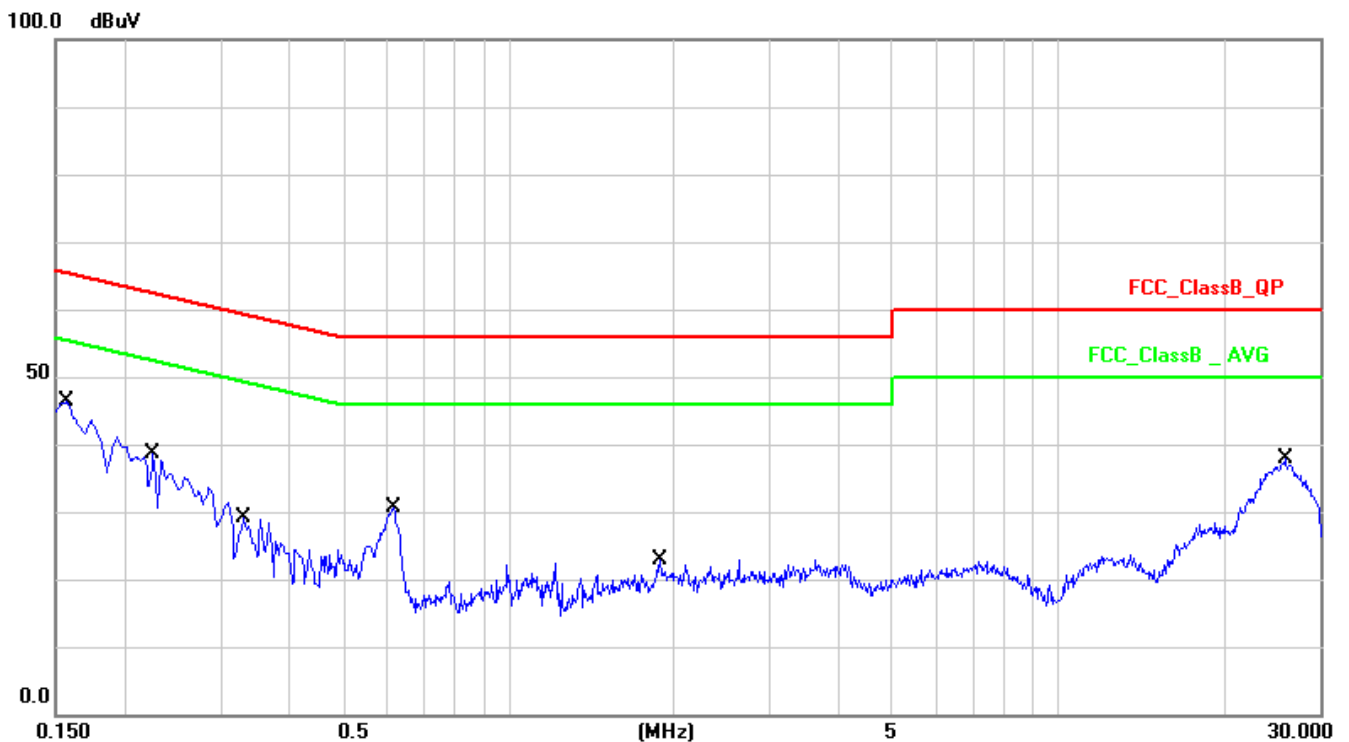

No.	Frequency (MHz)	Factor (dB)	Reading (dBuV)	Level (dBuV)	Limit (dBuV)	Margin (dB)	Detector
1	0.1580	10.15	31.98	42.13	65.56	-23.43	QP
2	0.1580	10.15	13.44	23.59	55.56	-31.97	AVG
3	0.2260	10.14	24.07	34.21	62.59	-28.38	QP
4	0.2260	10.14	6.68	16.82	52.59	-35.77	AVG
5	0.3300	10.14	14.26	24.40	59.45	-35.05	QP
6	0.3300	10.14	2.30	12.44	49.45	-37.01	AVG
7	0.6180	10.16	18.18	28.34	56.00	-27.66	QP
8	0.6180	10.16	9.76	19.92	46.00	-26.08	AVG
9	1.8900	10.19	6.48	16.67	56.00	-39.33	QP
10	1.8900	10.19	1.08	11.27	46.00	-34.73	AVG
11	25.8660	10.36	21.31	31.67	60.00	-28.33	QP



12	25.8660	10.36	12.02	22.38	50.00	-27.62	AVG
----	---------	-------	-------	-------	-------	--------	-----

Note: Level = Reading + Factor

Margin = Level – Limit

Factor = (LISN or ISN or PLC or current probe) Factor + Cable Loss + Attenuator



Test Standard:	FCC_ClassB_QP	Probe:	L1
Test item:	Conduction Emission	Test Time:	2019/8/13 10:57:35
Applicant:	Mitac Digital Technology Company	Power Rating:	AC 120V/60Hz
Product:	Tablet	Temp.(C)/Hum.(%)/Air p.(hpa):	26(°C)/60%/1000hpa
Model No.:	N642	Test Engineer:	Chris
Test Mode:	Wi-Fi 5G		
Remark:	POE Power		

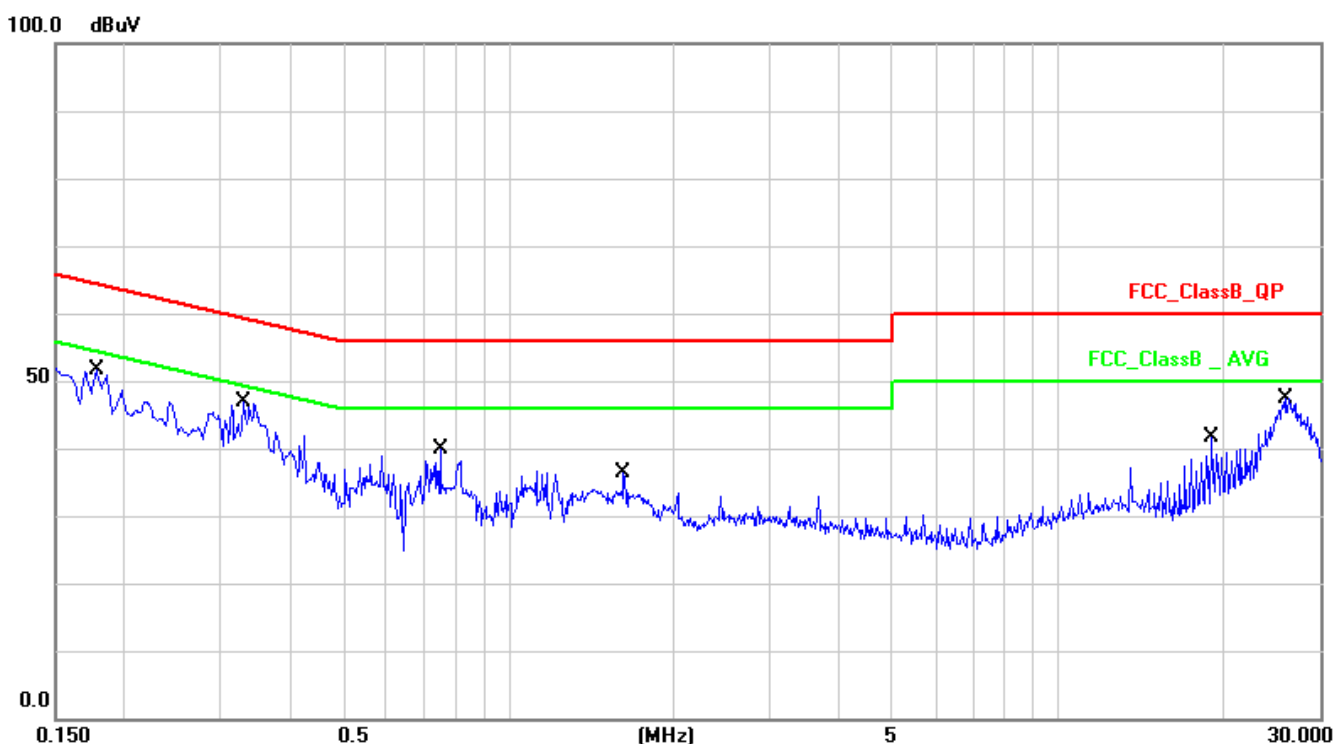

No.	Frequency (MHz)	Factor (dB)	Reading (dBuV)	Level (dBuV)	Limit (dBuV)	Margin (dB)	Detector
1	0.1780	10.13	34.40	44.53	64.57	-20.04	QP
2	0.1780	10.13	16.13	26.26	54.57	-28.31	AVG
3	0.3300	10.14	32.17	42.31	59.45	-17.14	QP
4	0.3300	10.14	24.31	34.45	49.45	-15.00	AVG
5	0.7539	10.15	20.93	31.08	56.00	-24.92	QP
6	0.7539	10.15	12.73	22.88	46.00	-23.12	AVG
7	1.6260	10.18	23.04	33.22	56.00	-22.78	QP
8	1.6260	10.18	18.54	28.72	46.00	-17.28	AVG
9	19.1180	10.41	22.11	32.52	60.00	-27.48	QP
10	19.1180	10.41	15.84	26.25	50.00	-23.75	AVG
11	26.0380	10.45	31.18	41.63	60.00	-18.37	QP



12	26.0380	10.45	25.36	35.81	50.00	-14.19	AVG
----	---------	-------	-------	-------	-------	--------	-----

Note: Level = Reading + Factor

Margin = Level – Limit

Factor = (LISN or ISN or PLC or current probe) Factor + Cable Loss + Attenuator



Test Standard:	FCC_ClassB_QP	Probe:	N
Test item:	Conduction Emission	Test Time:	2019/8/1310:55:02
Applicant:	Mitac Digital Technology Company	Power Rating:	AC 120V/60Hz
Product:	Tablet	Temp.(C)/Hum.(%)/Air p.(hpa):	26(°C)/60%/1000hpa
Model No.:	N642	Test Engineer:	Chris
Test Mode:	Wi-Fi 5G		
Remark:	POE Power		

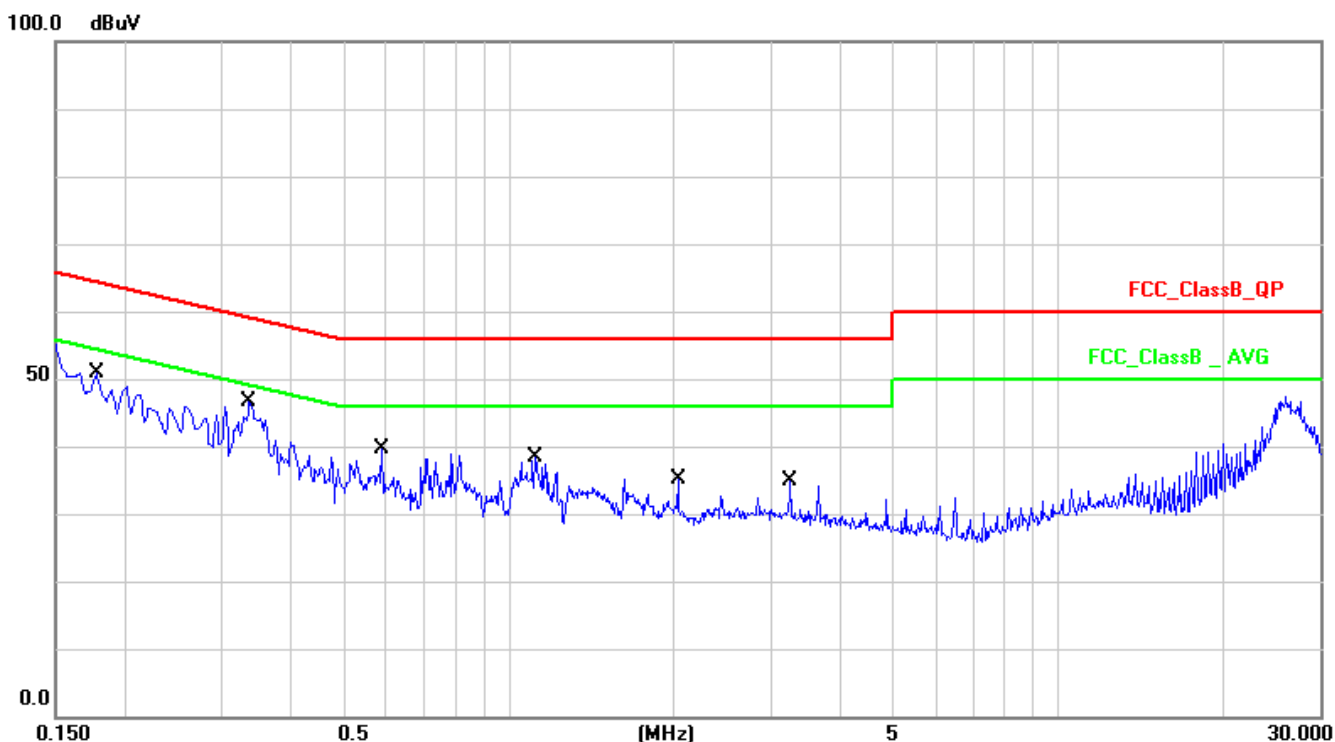

No.	Frequency (MHz)	Factor (dB)	Reading (dBuV)	Level (dBuV)	Limit (dBuV)	Margin (dB)	Detector
1	0.1780	10.14	34.63	44.77	64.57	-19.80	QP
2	0.1780	10.14	16.23	26.37	54.57	-28.20	AVG
3	0.3379	10.14	33.06	43.20	59.25	-16.05	QP
4	0.3379	10.14	25.64	35.78	49.25	-13.47	AVG
5	0.5899	10.15	22.36	32.51	56.00	-23.49	QP
6	0.5899	10.15	14.74	24.89	46.00	-21.11	AVG
7	1.1220	10.19	22.58	32.77	56.00	-23.23	QP
8	1.1220	10.19	15.16	25.35	46.00	-20.65	AVG
9	2.0380	10.19	20.53	30.72	56.00	-25.28	QP
10	2.0380	10.19	15.90	26.09	46.00	-19.91	AVG
11	3.2620	10.24	16.84	27.08	56.00	-28.92	QP



12	3.2620	10.24	11.60	21.84	46.00	-24.16	AVG
----	--------	-------	-------	-------	-------	--------	-----

Note: Level = Reading + Factor

Margin = Level – Limit

Factor = (LISN or ISN or PLC or current probe) Factor + Cable Loss + Attenuator



4. Test of Radiated Emission

4.1 Test Limit

According to §15.209(a), except as provided elsewhere in this Subpart, the emissions from an intentional radiator shall not exceed the field strength levels specified in the following table:

FCC Part 15 Subpart C Paragraph 15.209		
FREQUENCIES (MHz)	FIELD STRENGTH (micro volts/meter)	MEASUREMENT DISTANCE (meters)
0.009~0.490	2400/F(kHz)	300
0.490~1.705	24000/F(kHz)	30
1.705~30.0	30	30
30~88	100	3
88~216	150	3
216~960	200	3
Above 960	500	3

Note 1: The lower limit shall apply at the transition frequency.

Note 2: Distance refers to the distance in meters between the measuring instrument Antenna and the closed point of any part of the device or system.

Note 3: E field strength (dBuV/m) = 20 log E field strength (uV/m)

Note 4: **Except as provided in paragraph (g), fundamental emissions from intentional radiators operating under this section shall not be located in the frequency bands 54-72 MHz, 76-88 MHz, 174-216 MHz or 470-806 MHz. However, operation within these frequency bands is permitted under other sections of this part, e.g., §§15.231 and 15.241.

4.2 Test Standard

KDB 789033 D02v02r01 – Section G



4.3 Test Procedures

Quasi-Peak Field Strength Measurements:

1. Analyzer center frequency was set to the frequency of the radiated spurious emission of interest
2. Span was set greater than 1MHz
3. RBW = 120 kHz
4. Detector = CISPR quasi-peak
5. Sweep time = auto couple
6. Trace was allowed to stabilize

Peak Field Strength Measurements:

1. Analyzer center frequency was set to the frequency of the radiated spurious emission of interest
2. RBW = 1MHz
3. VBW = 3MHz
4. Detector = peak
5. Sweep time = auto couple
6. Trace mode = max hold
7. Trace was allowed to stabilize

AVE Field Strength Measurements:

1. Analyzer center frequency was set to the frequency of the radiated spurious emission of interest
2. RBW = 1MHz
3. VBW = 3MHz
4. Detector = power average (Average)
5. Number of measurement points = 1001 (Number of points must be $> 2 \times \text{span}/\text{RBW}$)
6. Sweep time = auto
7. Trace was averaged over at 100 sweeps



4.4 Test Setup

9kHz~30MHz Test Setup

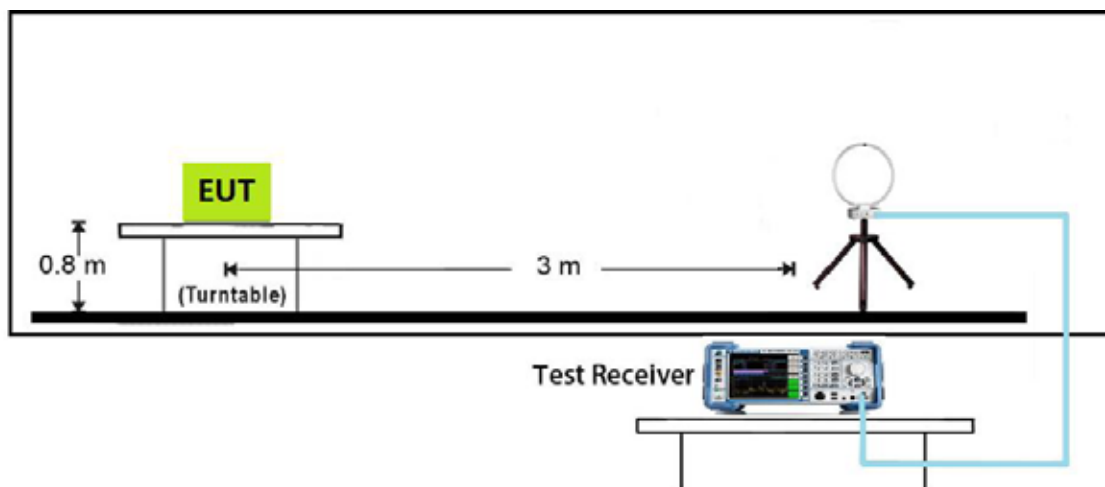

30MHz~1GHz Test Setup

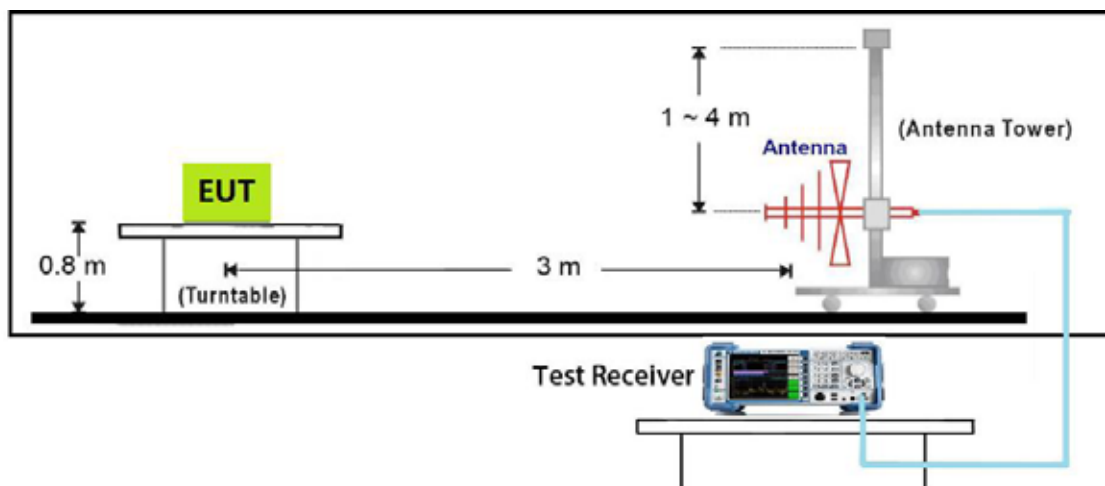



1GHz~18GHz Test Setup

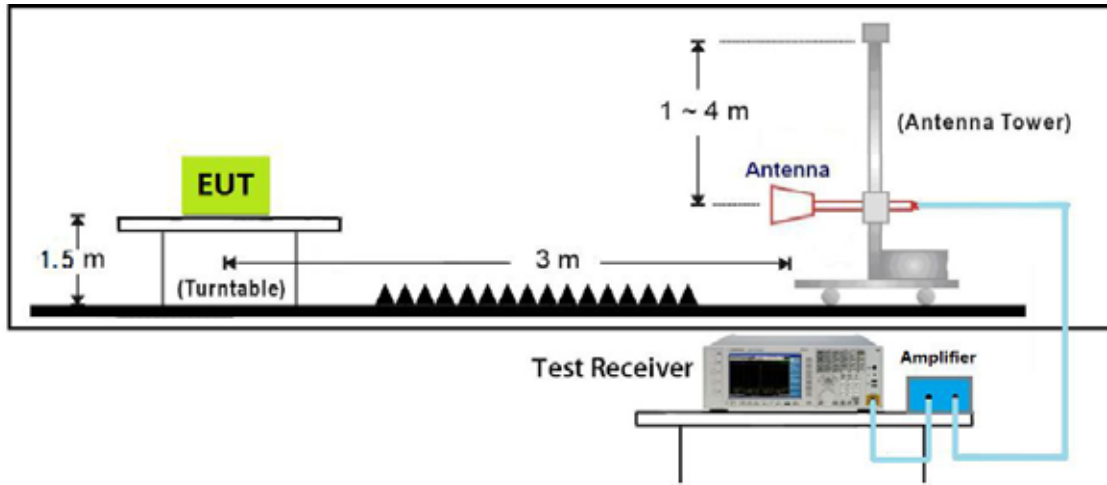

18GHz~40GHz Test Setup

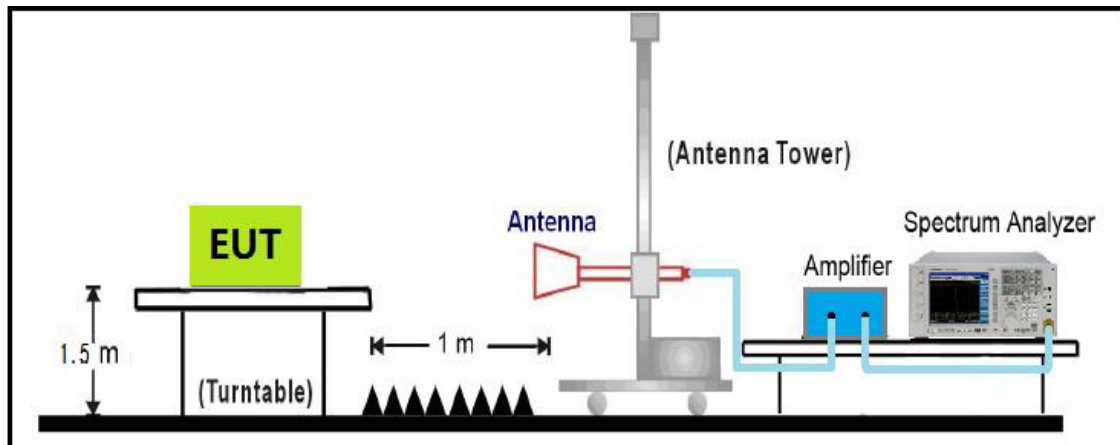



4.5 Test Result

The worst case of Radiated Emission below 1GHz:

Test Distance:	3M		
Test Standard:	FCC Class B 3M Radiation	Ant. Polarization:	Horizontal
Test item:	Radiation Emission	Test Time:	2019-8-1516:01:23
Applicant:	Mitac Digital Technology Company	Power Rating:	AC 120V/60Hz
Product:	Tablet	Temp.(C)/Hum.(/Air p.(hpa):	26(°C)/60%/983hpa
Model No.:	N642	Test Engineer:	Chris
Test Mode:	Wi-Fi 5G		
Remark:	Adapter Power		

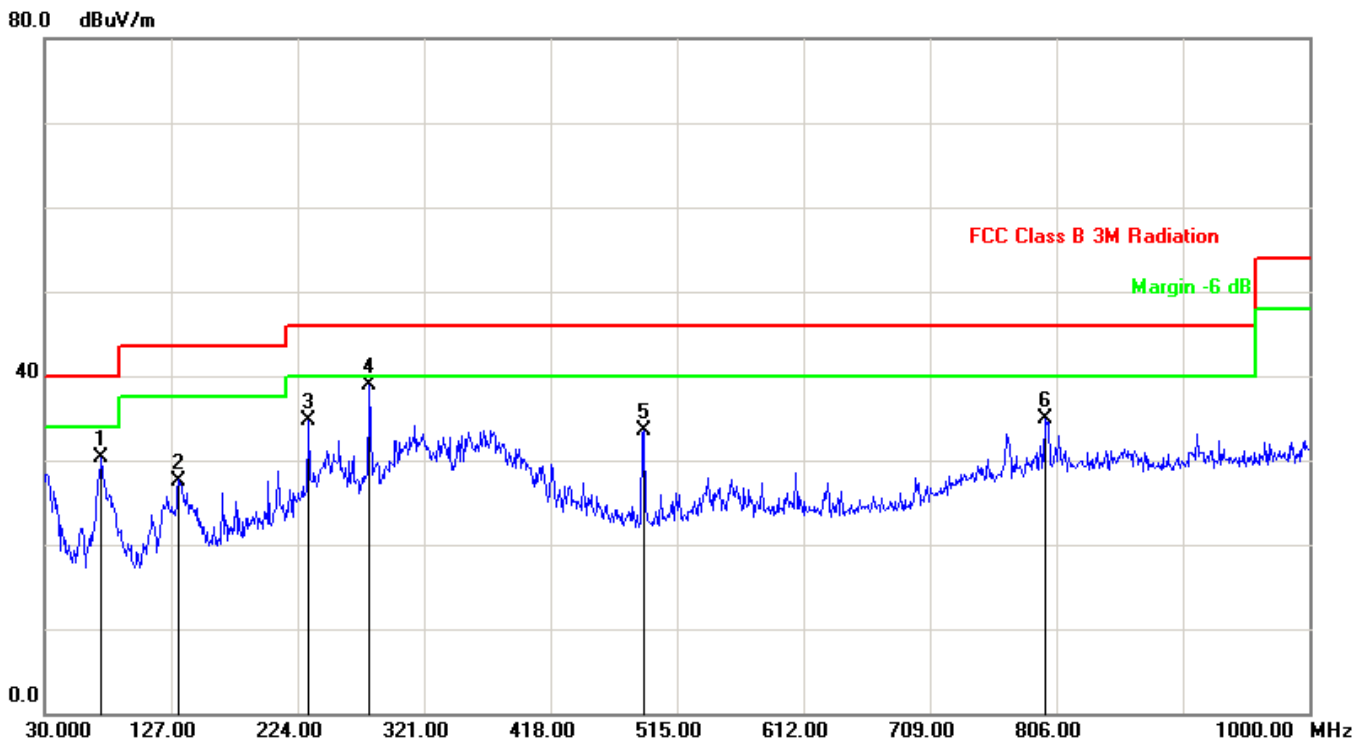

No.	Frequency (MHz)	Factor (dB/m)	Reading (dBuV)	Level (dBuV/m)	Limit (dBuV/m)	Margin (dB)	Det.
1	73.6500	-16.26	46.47	30.21	40.00	-9.79	peak
2	132.8200	-12.07	39.67	27.60	43.50	-15.90	peak
3	232.7300	-10.91	45.56	34.65	46.00	-11.35	peak
4	279.2900	-8.29	47.19	38.90	46.00	-7.10	peak
5	489.7800	-5.49	39.00	33.51	46.00	-12.49	peak
6	797.2700	1.78	33.18	34.96	46.00	-11.04	peak

Note: Measure Level (dBμV/m) = Reading Level (dBμV) + Factor (dB)

Factor (dB) = Cable Loss (dB) + Antenna Factor (dB/m) - Pre_Amplifier Gain (dB)



Test Distance:	3M		
Test Standard:	FCC Class B 3M Radiation	Ant. Polarization:	Vertical
Test item:	Radiation Emission	Test Time:	2019-8-1516:05:04
Applicant:	Mitac Digital Technology Company	Power Rating:	AC 120V/60Hz
Product:	Tablet	Temp.(C)/Hum.(%)/Air p.(hpa):	26(°C)/60%/983hpa
Model No.:	N642	Test Engineer:	Chris
Test Mode:	Wi-Fi 5G		
Remark:	Adapter Power		

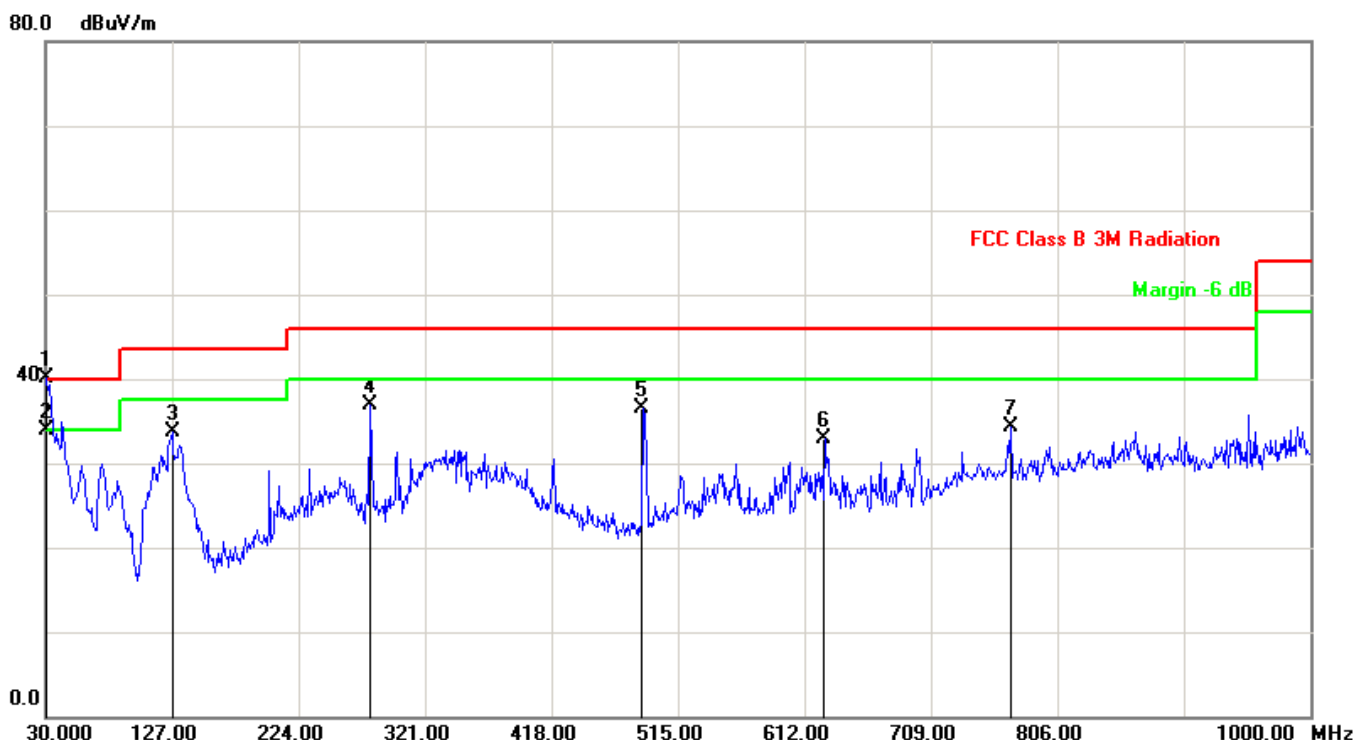

No.	Frequency (MHz)	Factor (dB/m)	Reading (dBuV)	Level (dBuV/m)	Limit (dBuV/m)	Margin (dB)	Det.
1	30.0000	-4.25	44.33	40.08	40.00	0.08	peak
2	30.0000	-4.25	38.12	33.87	40.00	-6.13	QP
3	127.0000	-12.12	45.77	33.65	43.50	-9.85	peak
4	279.2900	-8.29	45.14	36.85	46.00	-9.15	peak
5	487.8399	-5.49	41.94	36.45	46.00	-9.55	peak
6	627.5198	-3.53	36.37	32.84	46.00	-13.16	peak
7	770.1100	1.42	32.88	34.30	46.00	-11.70	peak

Note: Measure Level (dBμV/m) = Reading Level (dBμV) + Factor (dB)

Factor (dB) = Cable Loss (dB) + Antenna Factor (dB/m) - Pre_Amplifier Gain (dB)



Test Distance:	3M		
Test Standard:	FCC Class B 3M Radiation	Ant. Polarization:	Horizontal
Test item:	Radiation Emission	Test Time:	2019-8-1520:38:33
Applicant:	Mitac Digital Technology Company	Power Rating:	AC 120V/60Hz
Product:	Tablet	Temp.(C)/Hum.(/Air p.(hpa):	26(°C)/60%/983hpa
Model No.:	N642	Test Engineer:	Chris
Test Mode:	Wi-Fi 5G		
Remark:	POE Power		

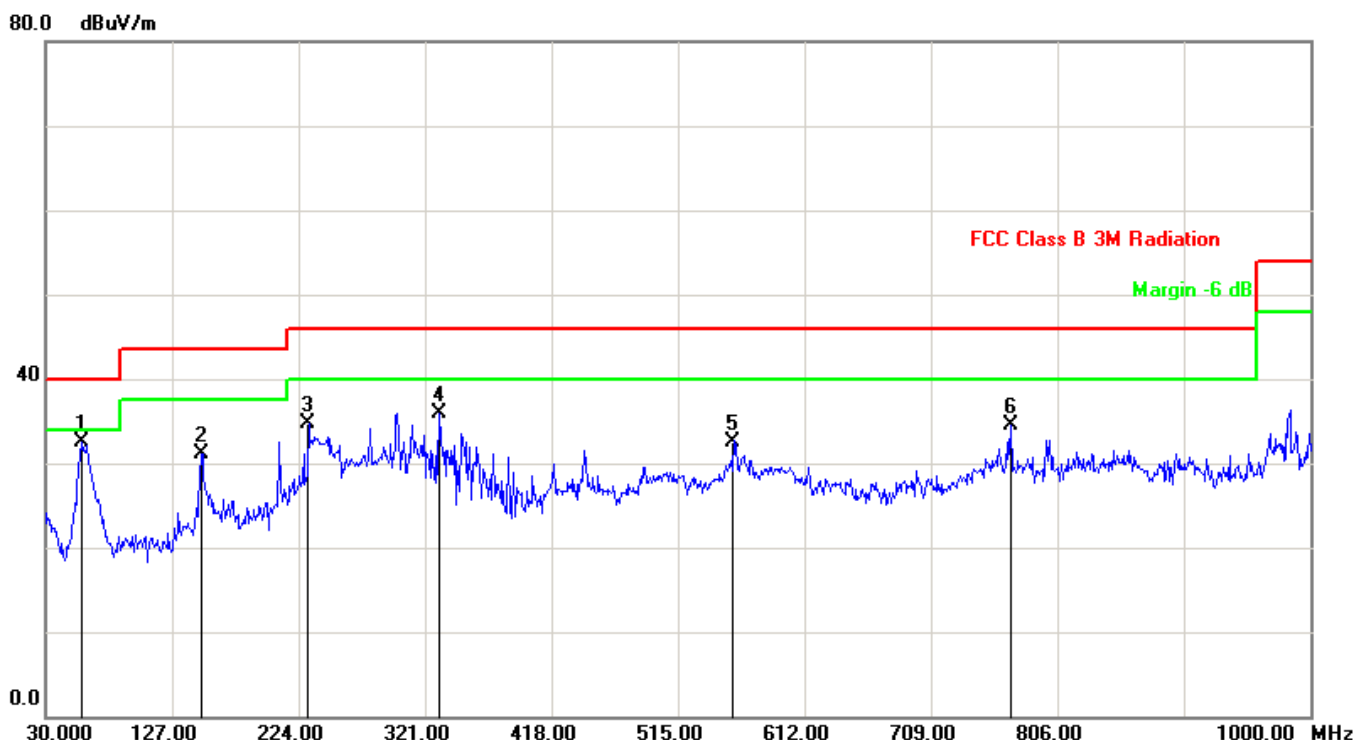

No.	Frequency (MHz)	Factor (dB/m)	Reading (dBuV)	Level (dBuV/m)	Limit (dBuV/m)	Margin (dB)	Det.
1	58.1300	-14.55	47.03	32.48	40.00	-7.52	peak
2	149.3100	-12.52	43.67	31.15	43.50	-12.35	peak
3	231.7598	-10.96	45.60	34.64	46.00	-11.36	peak
4	331.6700	-7.91	43.75	35.84	46.00	-10.16	peak
5	557.6798	-3.98	36.58	32.60	46.00	-13.40	peak
6	770.1100	1.42	33.01	34.43	46.00	-11.57	peak

Note: Measure Level (dBuV/m) = Reading Level (dBuV) + Factor (dB)

Factor (dB) = Cable Loss (dB) + Antenna Factor (dB/m) - Pre_Amplifier Gain (dB)



Test Distance:	3M		
Test Standard:	FCC Class B 3M Radiation	Ant. Polarization:	Vertical
Test item:	Radiation Emission	Test Time:	2019-8-1520:42:19
Applicant:	Mitac Digital Technology Company	Power Rating:	AC 120V/60Hz
Product:	Tablet	Temp.(C)/Hum.(/Air p.(hpa):	26(°C)/60%/983hpa
Model No.:	N642	Test Engineer:	Chris
Test Mode:	Wi-Fi 5G		
Remark:	POE Power		

80.0 dBuV/m

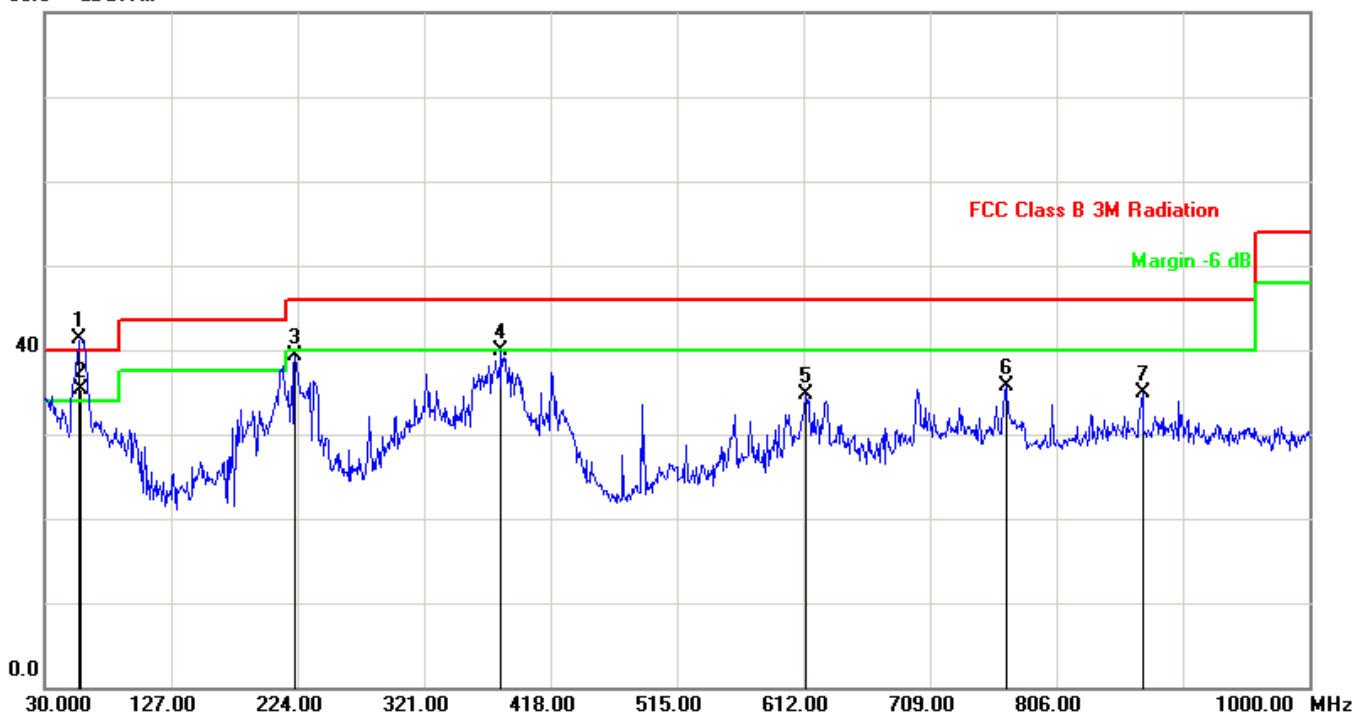

No.	Frequency (MHz)	Factor (dB/m)	Reading (dBuV)	Level (dBuV/m)	Limit (dBuV/m)	Margin (dB)	Det.
1	57.1599	-12.18	53.43	41.25	40.00	1.25	peak
2	57.9900	-12.32	47.66	35.34	40.00	-4.66	QP
3	222.0600	-12.16	51.44	39.28	46.00	-6.72	peak
4	380.1700	-7.00	46.95	39.95	46.00	-6.05	peak
5	613.9400	-1.51	36.26	34.75	46.00	-11.25	peak
6	768.1698	0.93	34.69	35.62	46.00	-10.38	peak
7	871.9600	2.02	32.87	34.89	46.00	-11.11	peak

Note: Measure Level (dB μ V/m) = Reading Level (dB μ V) + Factor (dB)

Factor (dB) = Cable Loss (dB) + Antenna Factor (dB/m) - Pre_Amplifier Gain (dB)

**Radiated Emission above 1GHz:**

Mode1: Transmit by 802.11a

CH	Antenna Polarity	Frequency (MHz)	Reading Level (dBuV/m)	Factor (dB)	Measure Level (dBuV/m)	Limit (dBuV/m)	Margin (dB)	Detector
36	H	10360	38.28	11.66	49.94	54(note3)	-4.06	PK
	H	15540	28.42	21.57	49.99	54(note3)	-4.01	PK
	V	10360	36.78	11.66	48.44	54(note3)	-5.56	PK
	V	15540	28.52	21.57	50.09	54(note3)	-3.91	PK
40	H	10400	38.48	11.76	50.24	54(note3)	-3.76	PK
	H	15600	28.87	20.68	49.55	54(note3)	-4.45	PK
	V	10400	37.98	11.76	49.74	54(note3)	-4.26	PK
	V	15600	28.89	20.68	49.57	54(note3)	-4.43	PK
48	H	10480	37.82	11.95	49.77	54(note3)	-4.23	PK
	H	15720	32.10	18.90	51.00	54(note3)	-3.00	PK
	V	10480	38.15	11.95	50.10	54(note3)	-3.90	PK
	V	15720	30.99	18.90	49.89	54(note3)	-4.11	PK
52	H	10520	38.31	12.03	50.34	54(note3)	-3.66	PK
	H	15780	28.33	18.00	46.33	54(note3)	-7.67	PK
	V	10520	37.12	12.03	49.15	54(note3)	-4.85	PK
	V	15780	28.39	18.00	46.39	54(note3)	-7.61	PK
56	H	10560	37.98	12.08	50.06	54(note3)	-3.94	PK
	H	15840	28.69	17.11	45.80	54(note3)	-8.20	PK
	V	10560	37.79	12.08	49.87	54(note3)	-4.13	PK
	V	15840	29.27	17.11	46.38	54(note3)	-7.62	PK
64	H	10640	37.74	12.19	49.93	54(note3)	-4.07	PK
	H	15960	32.47	15.33	47.80	54(note3)	-6.20	PK
	V	10640	37.70	12.19	49.89	54(note3)	-4.11	PK
	V	15960	31.49	15.33	46.82	54(note3)	-7.18	PK
100	H	11000	37.86	12.69	50.55	54(note3)	-3.45	PK
	H	16500	27.38	14.81	42.19	54(note3)	-11.81	PK
	V	11000	36.54	12.69	49.23	54(note3)	-4.77	PK
	V	16500	27.18	14.81	41.99	54(note3)	-12.01	PK
120	H	11200	37.48	12.29	49.77	54(note3)	-4.23	PK
	H	16800	27.23	16.97	44.20	54(note3)	-9.80	PK
	V	11200	36.61	12.29	48.90	54(note3)	-5.10	PK



	V	16800	26.90	16.97	43.87	54(note3)	-10.13	PK
140	H	11400	37.81	11.89	49.70	54(note3)	-4.30	PK
	H	17100	30.85	19.29	50.14	54(note3)	-3.86	PK
	V	11400	37.77	11.89	49.66	54(note3)	-4.34	PK
	V	17100	30.46	19.29	49.75	54(note3)	-4.25	PK
144	H	11440	36.55	11.81	48.36	54(note3)	-5.64	PK
	H	17160	26.54	19.82	46.36	54(note3)	-7.64	PK
	V	11440	36.95	11.81	48.76	54(note3)	-5.24	PK
	V	17160	27.30	19.82	47.12	54(note3)	-6.88	PK
149	H	11490	36.06	11.71	47.77	54(note3)	-6.23	PK
	H	17235	24.72	20.48	45.20	54(note3)	-8.80	PK
	V	11490	32.86	11.71	44.57	54(note3)	-9.43	PK
	V	17235	24.73	20.48	45.21	54(note3)	-8.79	PK
157	H	11570	35.59	11.78	47.37	54(note3)	-6.63	PK
	H	17355	26.08	21.53	47.61	54(note3)	-6.39	PK
	V	11570	34.78	11.78	46.56	54(note3)	-7.44	PK
	V	17355	27.25	21.53	48.78	54(note3)	-5.22	PK
165	H	11650	35.47	11.87	47.34	54(note3)	-6.66	PK
	H	17475	27.31	22.59	49.90	54(note3)	-4.10	PK
	V	11650	35.35	11.87	47.22	54(note3)	-6.78	PK
	V	17475	26.86	22.59	49.45	54(note3)	-4.55	PK

Note: 1. Measure Level = Reading Level + Factor.

2. The test trace is same as the ambient noise (the test frequency range: 9kHz~30MHz, 18GHz~40GHz), therefore no data appear in the report.

3. This limit applies for using average detector, if the test result on peak is lower than average limit, then average measurement needn't be performed.



Mode2: Transmit by 802.11n(20MHz)

CH	Antenna Polarity	Frequency (MHz)	Reading Level (dBuV/m)	Factor (dB)	Measure Level (dBuV/m)	Limit (dBuV/m)	Margin (dB)	Detector
36	H	10360	37.45	11.66	49.11	54(note3)	-4.89	PK
	H	15540	29.21	21.57	50.78	54(note3)	-3.22	PK
	V	10360	37.56	11.66	49.22	54(note3)	-4.78	PK
	V	15540	28.74	21.57	50.31	54(note3)	-3.69	PK
40	H	10400	38.02	11.76	49.78	54(note3)	-4.22	PK
	H	15600	29.02	20.68	49.70	54(note3)	-4.30	PK
	V	10400	37.94	11.76	49.70	54(note3)	-4.30	PK
	V	15600	29.12	20.68	49.80	54(note3)	-4.20	PK
48	H	10480	38.44	11.95	50.39	54(note3)	-3.61	PK
	H	15720	31.05	18.90	49.95	54(note3)	-4.05	PK
	V	10480	37.61	11.95	49.56	54(note3)	-4.44	PK
	V	15720	31.27	18.90	50.17	54(note3)	-3.83	PK
52	H	10520	37.28	12.03	49.31	54(note3)	-4.69	PK
	H	15780	28.99	18.00	46.99	54(note3)	-7.01	PK
	V	10520	37.69	12.03	49.72	54(note3)	-4.28	PK
	V	15780	28.26	18.00	46.26	54(note3)	-7.74	PK
56	H	10560	37.55	12.08	49.63	54(note3)	-4.37	PK
	H	15840	28.99	17.11	46.10	54(note3)	-7.90	PK
	V	10560	37.74	12.08	49.82	54(note3)	-4.18	PK
	V	15840	29.56	17.11	46.67	54(note3)	-7.33	PK
64	H	10640	38.61	12.19	50.80	54(note3)	-3.20	PK
	H	15960	31.17	15.33	46.50	54(note3)	-7.50	PK
	V	10640	37.30	12.19	49.49	54(note3)	-4.51	PK
	V	15960	31.36	15.33	46.69	54(note3)	-7.31	PK
100	H	11000	36.61	12.69	49.30	54(note3)	-4.70	PK
	H	16500	28.88	14.81	43.69	54(note3)	-10.31	PK
	V	11000	36.94	12.69	49.63	54(note3)	-4.37	PK
	V	16500	27.15	14.81	41.96	54(note3)	-12.04	PK
120	H	11200	37.71	12.29	50.00	54(note3)	-4.00	PK
	H	16800	28.81	16.97	45.78	54(note3)	-8.22	PK
	V	11200	36.60	12.29	48.89	54(note3)	-5.11	PK
	V	16800	29.05	16.97	46.02	54(note3)	-7.98	PK



140	H	11400	37.68	11.89	49.57	54(note3)	-4.43	PK
	H	17100	29.90	19.29	49.19	54(note3)	-4.81	PK
	V	11400	36.84	11.89	48.73	54(note3)	-5.27	PK
	V	17100	30.50	19.29	49.79	54(note3)	-4.21	PK
144	H	11440	35.65	11.81	47.46	54(note3)	-6.54	PK
	H	17160	28.38	19.82	48.20	54(note3)	-5.80	PK
	V	11440	36.39	11.81	48.20	54(note3)	-5.80	PK
	V	17160	27.33	19.82	47.15	54(note3)	-6.85	PK
149	H	11490	36.79	11.71	48.50	54(note3)	-5.50	PK
	H	17235	26.35	20.48	46.83	54(note3)	-7.17	PK
	V	11490	36.34	11.71	48.05	54(note3)	-5.95	PK
	V	17235	27.21	20.48	47.69	54(note3)	-6.31	PK
157	H	11570	37.77	11.78	49.55	54(note3)	-4.45	PK
	H	17355	27.25	21.53	48.78	54(note3)	-5.22	PK
	V	11570	37.13	11.78	48.91	54(note3)	-5.09	PK
	V	17355	26.31	21.53	47.84	54(note3)	-6.16	PK
165	H	11650	34.76	11.87	46.63	54(note3)	-7.37	PK
	H	17475	27.34	22.59	49.93	54(note3)	-4.07	PK
	V	11650	35.97	11.87	47.84	54(note3)	-6.16	PK
	V	17475	27.15	22.59	49.74	54(note3)	-4.26	PK

Note: 1. Measure Level = Reading Level + Factor.

2. The test trace is same as the ambient noise (the test frequency range: 9kHz~30MHz, 18GHz~40GHz), therefore no data appear in the report.

3. This limit applies for using average detector, if the test result on peak is lower than average limit, then average measurement needn't be performed.



Mode3: Transmit by 802.11n(40MHz)

CH	Antenna Polarity	Frequency (MHz)	Reading Level (dBuV/m)	Factor (dB)	Measure Level (dBuV/m)	Limit (dBuV/m)	Margin (dB)	Detector
38	H	10380	37.78	11.71	49.49	54(note3)	-4.51	PK
	H	15570	28.35	21.17	49.52	54(note3)	-4.48	PK
	V	10380	37.50	11.71	49.21	54(note3)	-4.79	PK
	V	15570	28.87	21.17	50.04	54(note3)	-3.96	PK
46	H	10460	38.39	11.89	50.28	54(note3)	-3.72	PK
	H	15690	29.67	19.39	49.06	54(note3)	-4.94	PK
	V	10460	36.20	11.89	48.09	54(note3)	-5.91	PK
	V	15690	31.17	19.39	50.56	54(note3)	-3.44	PK
54	H	10540	37.57	12.06	49.63	54(note3)	-4.37	PK
	H	15810	28.39	17.87	46.26	54(note3)	-7.74	PK
	V	10540	37.55	12.06	49.61	54(note3)	-4.39	PK
	V	15810	28.79	17.87	46.66	54(note3)	-7.34	PK
62	H	10620	38.14	12.17	50.31	54(note3)	-3.69	PK
	H	15930	29.49	17.34	46.83	54(note3)	-7.17	PK
	V	10620	36.05	12.17	48.22	54(note3)	-5.78	PK
	V	15930	30.95	17.34	48.29	54(note3)	-5.71	PK
102	H	11020	37.05	12.65	49.70	54(note3)	-4.30	PK
	H	16530	27.61	15.11	42.72	54(note3)	-11.28	PK
	V	11020	36.61	12.65	49.26	54(note3)	-4.74	PK
	V	16530	27.64	15.11	42.75	54(note3)	-11.25	PK
118	H	11180	37.54	12.33	49.87	54(note3)	-4.13	PK
	H	16770	27.82	16.96	44.78	54(note3)	-9.22	PK
	V	11180	35.33	12.33	47.66	54(note3)	-6.34	PK
	V	16770	29.35	16.96	46.31	54(note3)	-7.69	PK
134	H	11340	35.80	12.01	47.81	54(note3)	-6.19	PK
	H	17010	28.32	18.82	47.14	54(note3)	-6.86	PK
	V	11340	35.72	12.01	47.73	54(note3)	-6.27	PK
	V	17010	26.80	18.82	45.62	54(note3)	-8.38	PK
142	H	11420	36.17	11.85	48.02	54(note3)	-5.98	PK
	H	17130	27.79	19.74	47.53	54(note3)	-6.47	PK
	V	11420	35.03	11.85	46.88	54(note3)	-7.12	PK
	V	17130	26.21	19.74	45.95	54(note3)	-8.05	PK



151	H	11510	36.70	11.76	48.46	54(note3)	-5.54	PK
	H	17265	25.57	20.50	46.07	54(note3)	-7.93	PK
	V	11510	37.71	11.76	49.47	54(note3)	-4.53	PK
	V	17265	27.02	20.50	47.52	54(note3)	-6.48	PK
159	H	11590	34.43	11.95	46.38	54(note3)	-7.62	PK
	H	17385	27.35	20.62	47.97	54(note3)	-6.03	PK
	V	11590	34.40	11.95	46.35	54(note3)	-7.65	PK
	V	17385	26.34	20.62	46.96	54(note3)	-7.04	PK

Note: 1. Measure Level = Reading Level + Factor.

2. The test trace is same as the ambient noise (the test frequency range: 9kHz~30MHz, 18GHz~40GHz), therefore no data appear in the report.

3. This limit applies for using average detector, if the test result on peak is lower than average limit, then average measurement needn't be performed.

**The worst case of Radiated Emission Above 1GHz:**

Test Distance:	3M		
Test Standard:	FCC Class B Above 1G 3M Radiation PK	Ant. Polarization:	Horizontal
Test item:	Radiation Emission	Test Time:	2019-8-321:08:44
Applicant:	Mitac Digital Technology Company	Power Rating:	AC 120V/60Hz
Product:	Tablet	Temp.(C)/Hum.(%)/Air p.(hpa):	26(°C)/60%/983hpa
Model No.:	N642	Test Engineer:	Chris
Test Mode:	Wi-Fi 5G-802.11a 5180MHz		
Remark:	POE Power		

100.0 dBuV/m

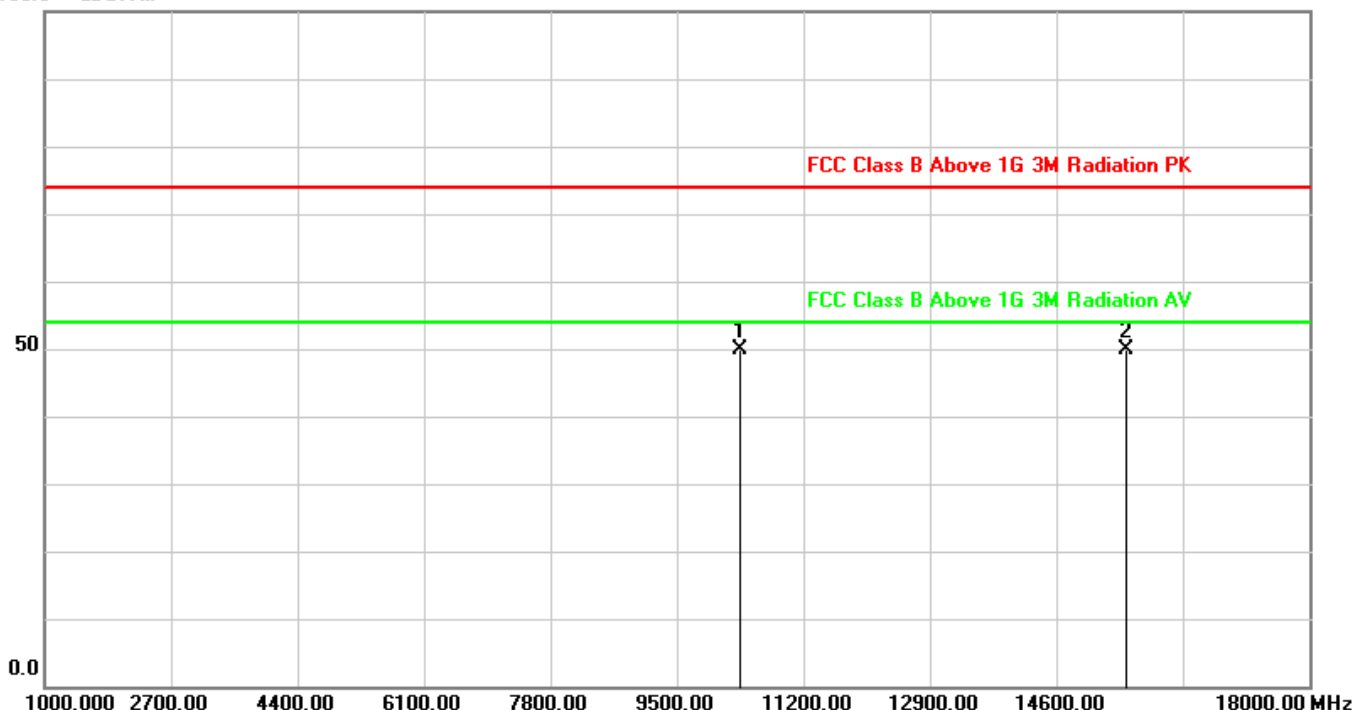

No.	Frequency (MHz)	Factor (dB/m)	Reading (dBuV)	Level (dBuV/m)	Limit (dBuV/m)	Margin (dB)	Det.
1	10360.000	11.66	38.28	49.94	74.00	-24.06	peak
2	15540.000	21.57	28.42	49.99	74.00	-24.01	peak

Note: 1. All Readings below 1GHz are Quasi-Peak, above are performed with peak and/or AVG measurements as necessary.

2. Measurement Level = Reading Level + Correct Factor.

3. The test trace is same as the ambient noise (the test frequency range: 9kHz~30MHz, 18GHz~40GHz), therefore no data appear in the report.

4. This limit applies for using average detector, if the test result on peak is lower than average limit, then average measurement needn't be performed.



Test Distance:	3M		
Test Standard:	FCC Class B Above 1G 3M	Ant. Polarization:	Vertical
	Radiation PK		
Test item:	Radiation Emission	Test Time:	2019-8-321:10:09
Applicant:	Mitac Digital Technology Company	Power Rating:	AC 120V/60Hz
Product:	Tablet	Temp.(C)/Hum.(%)/Air p.(hpa):	26(°C)/60%/983hpa
Model No.:	N642	Test Engineer:	Chris
Test Mode:	Wi-Fi 5G-802.11a 5180MHz		
Remark:	POE Power		

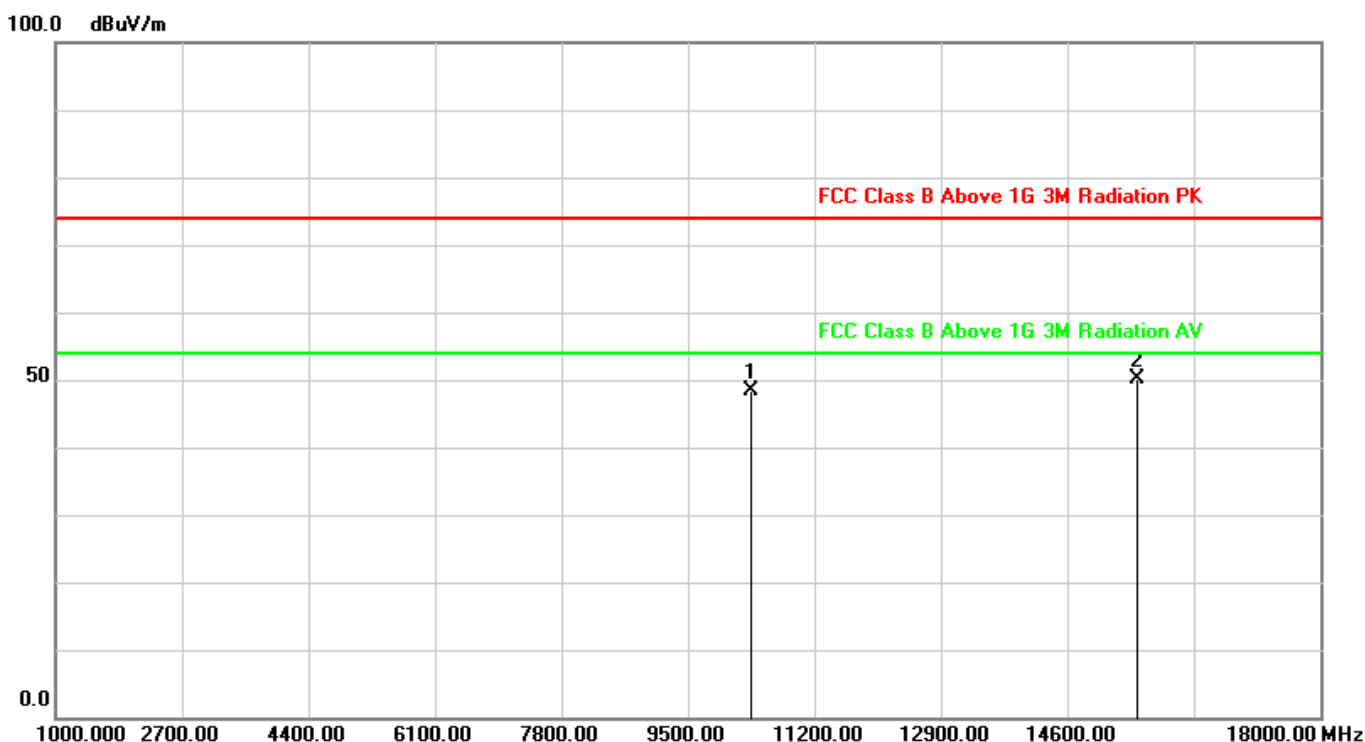

No.	Frequency (MHz)	Factor (dB/m)	Reading (dBuV)	Level (dBuV/m)	Limit (dBuV/m)	Margin (dB)	Det.
1	10360.000	11.66	36.78	48.44	74.00	-25.56	peak
2	15540.000	21.57	28.52	50.09	74.00	-23.91	peak

Note: 1. All Readings below 1GHz are Quasi-Peak, above are performed with peak and/or AVG measurements as necessary.

2. Measurement Level = Reading Level + Correct Factor.

3. The test trace is same as the ambient noise (the test frequency range: 9kHz~30MHz, 18GHz~40GHz), therefore no data appear in the report.

4. This limit applies for using average detector, if the test result on peak is lower than average limit, then average measurement needn't be performed.



Test Distance:	3M		
Test Standard:	FCC Class B Above 1G 3M	Ant. Polarization:	Horizontal
	Radiation PK		
Test item:	Radiation Emission	Test Time:	2019-8-321:14:00
Applicant:	Mitac Digital Technology Company	Power Rating:	AC 120V/60Hz
Product:	Tablet	Temp.(C)/Hum.(%)/Air p.(hpa):	26(°C)/60%/983hpa
Model No.:	N642	Test Engineer:	Chris
Test Mode:	Wi-Fi 5G-802.11a 5200MHz		
Remark:	POE Power		

100.0 dBuV/m

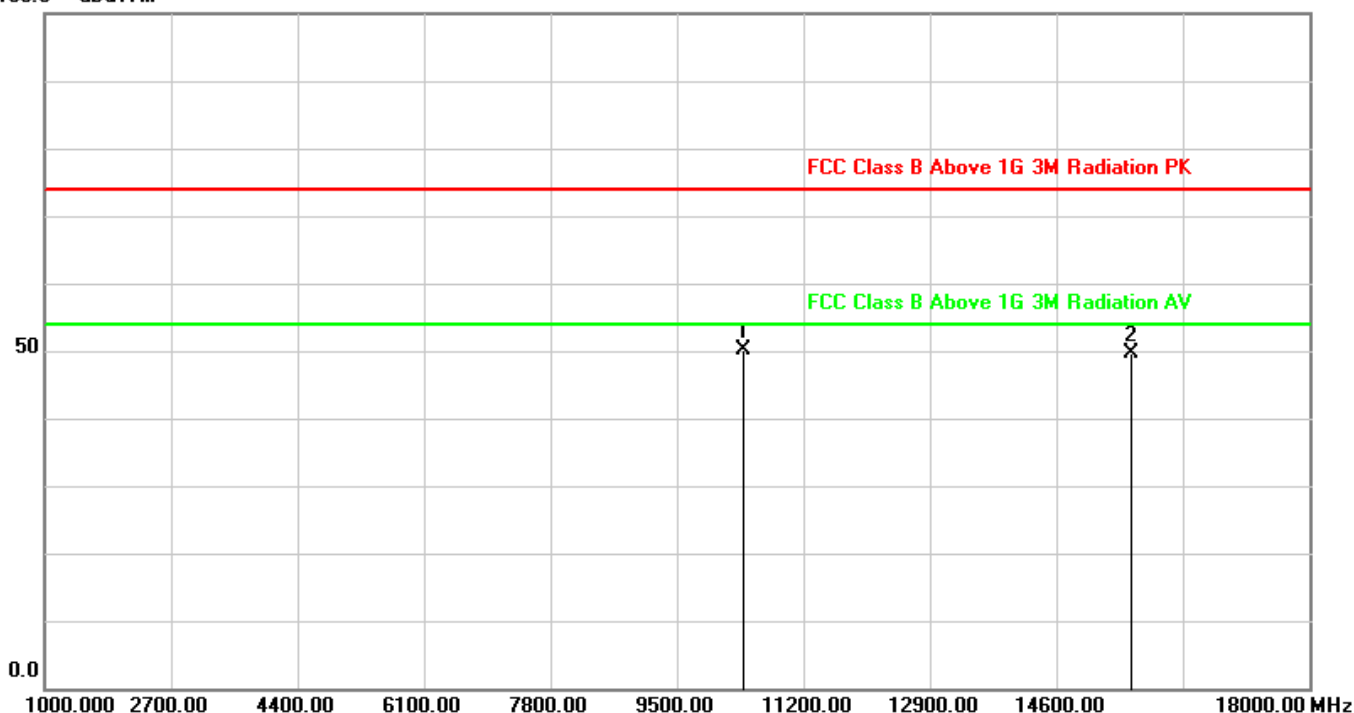

No.	Frequency (MHz)	Factor (dB/m)	Reading (dBuV)	Level (dBuV/m)	Limit (dBuV/m)	Margin (dB)	Det.
1	10400.000	11.76	38.48	50.24	74.00	-23.76	peak
2	15600.000	20.68	28.87	49.55	74.00	-24.45	peak

Note: 1. All Readings below 1GHz are Quasi-Peak, above are performed with peak and/or AVG measurements as necessary.

2. Measurement Level = Reading Level + Correct Factor.

3. The test trace is same as the ambient noise (the test frequency range: 9kHz~30MHz, 18GHz~40GHz), therefore no data appear in the report.

4. This limit applies for using average detector, if the test result on peak is lower than average limit, then average measurement needn't be performed.



Test Distance:	3M		
Test Standard:	FCC Class B Above 1G 3M	Ant. Polarization:	Vertical
	Radiation PK		
Test item:	Radiation Emission	Test Time:	2019-8-321:15:26
Applicant:	Mitac Digital Technology Company	Power Rating:	AC 120V/60Hz
Product:	Tablet	Temp.(C)/Hum.(%)/Air p.(hpa):	26(°C)/60%/983hpa
Model No.:	N642	Test Engineer:	Chris
Test Mode:	Wi-Fi 5G-802.11a 5200MHz		
Remark:	POE Power		

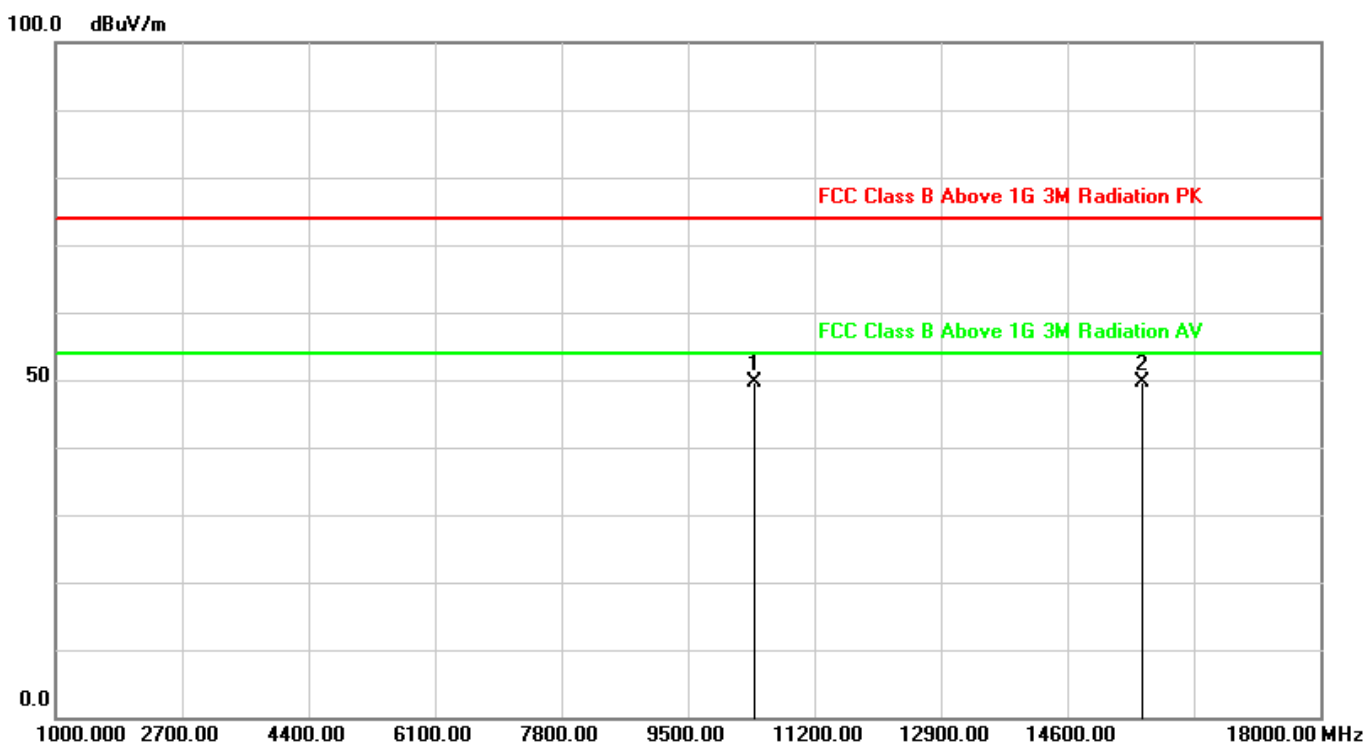

No.	Frequency (MHz)	Factor (dB/m)	Reading (dBuV)	Level (dBuV/m)	Limit (dBuV/m)	Margin (dB)	Det.
1	10400.000	11.76	37.98	49.74	74.00	-24.26	peak
2	15600.000	20.68	28.89	49.57	74.00	-24.43	peak

Note: 1. All Readings below 1GHz are Quasi-Peak, above are performed with peak and/or AVG measurements as necessary.

2. Measurement Level = Reading Level + Correct Factor.

3. The test trace is same as the ambient noise (the test frequency range: 9kHz~30MHz, 18GHz~40GHz), therefore no data appear in the report.

4. This limit applies for using average detector, if the test result on peak is lower than average limit, then average measurement needn't be performed.



Test Distance:	3M		
Test Standard:	FCC Class B Above 1G 3M	Ant. Polarization:	Horizontal
	Radiation PK		
Test item:	Radiation Emission	Test Time:	2019-8-321:18:38
Applicant:	Mitac Digital Technology Company	Power Rating:	AC 120V/60Hz
Product:	Tablet	Temp.(C)/Hum.(%)/Air p.(hpa):	26(°C)/60%/983hpa
Model No.:	N642	Test Engineer:	Chris
Test Mode:	Wi-Fi 5G-802.11a 5240MHz		
Remark:	POE Power		

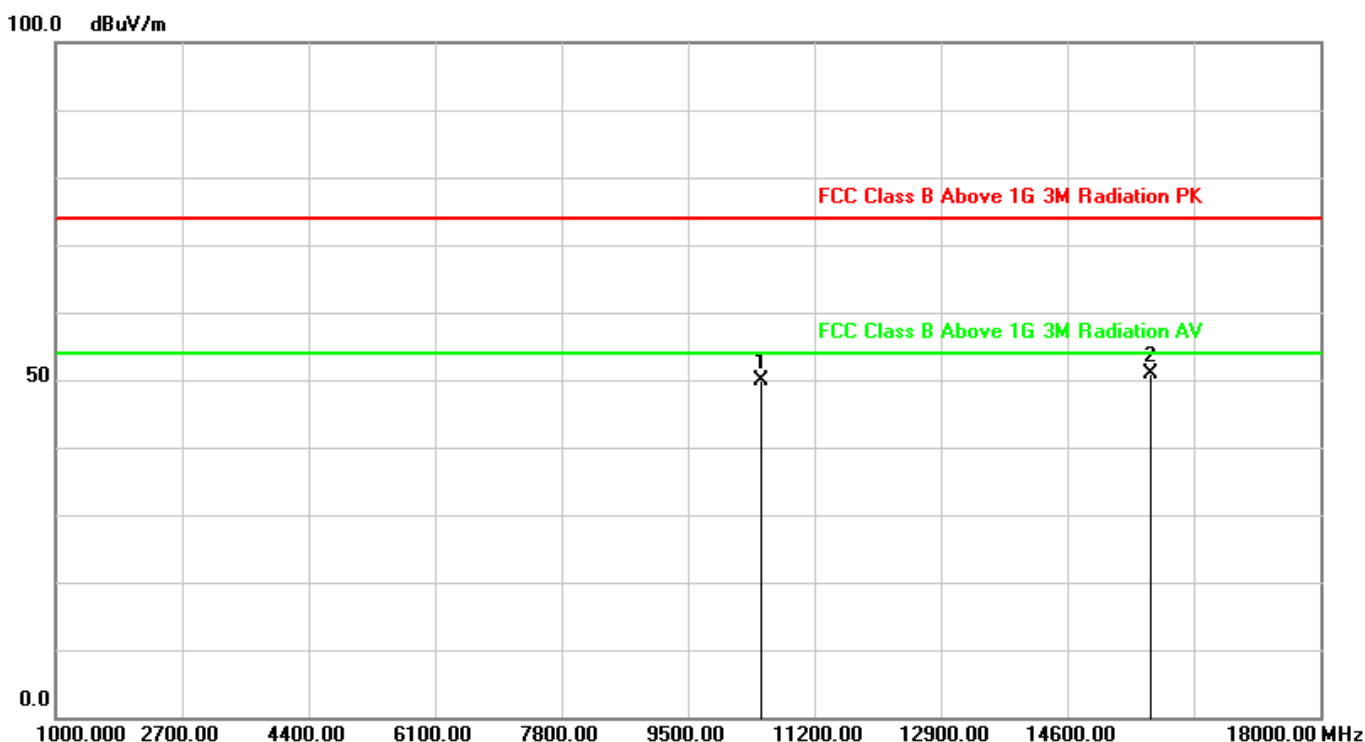

No.	Frequency (MHz)	Factor (dB/m)	Reading (dBuV)	Level (dBuV/m)	Limit (dBuV/m)	Margin (dB)	Det.
1	10480.000	11.95	37.82	49.77	74.00	-24.23	peak
2	15720.000	18.90	32.10	51.00	74.00	-23.00	peak

Note: 1. All Readings below 1GHz are Quasi-Peak, above are performed with peak and/or AVG measurements as necessary.

2. Measurement Level = Reading Level + Correct Factor.

3. The test trace is same as the ambient noise (the test frequency range: 9kHz~30MHz, 18GHz~40GHz), therefore no data appear in the report.

4. This limit applies for using average detector, if the test result on peak is lower than average limit, then average measurement needn't be performed.



Test Distance:	3M		
Test Standard:	FCC Class B Above 1G 3M	Ant. Polarization:	Vertical
	Radiation PK		
Test item:	Radiation Emission	Test Time:	2019-8-321:20:04
Applicant:	Mitac Digital Technology Company	Power Rating:	AC 120V/60Hz
Product:	Tablet	Temp.(C)/Hum.(%)/Air p.(hpa):	26(°C)/60%/983hpa
Model No.:	N642	Test Engineer:	Chris
Test Mode:	Wi-Fi 5G-802.11a 5240MHz		
Remark:	POE Power		

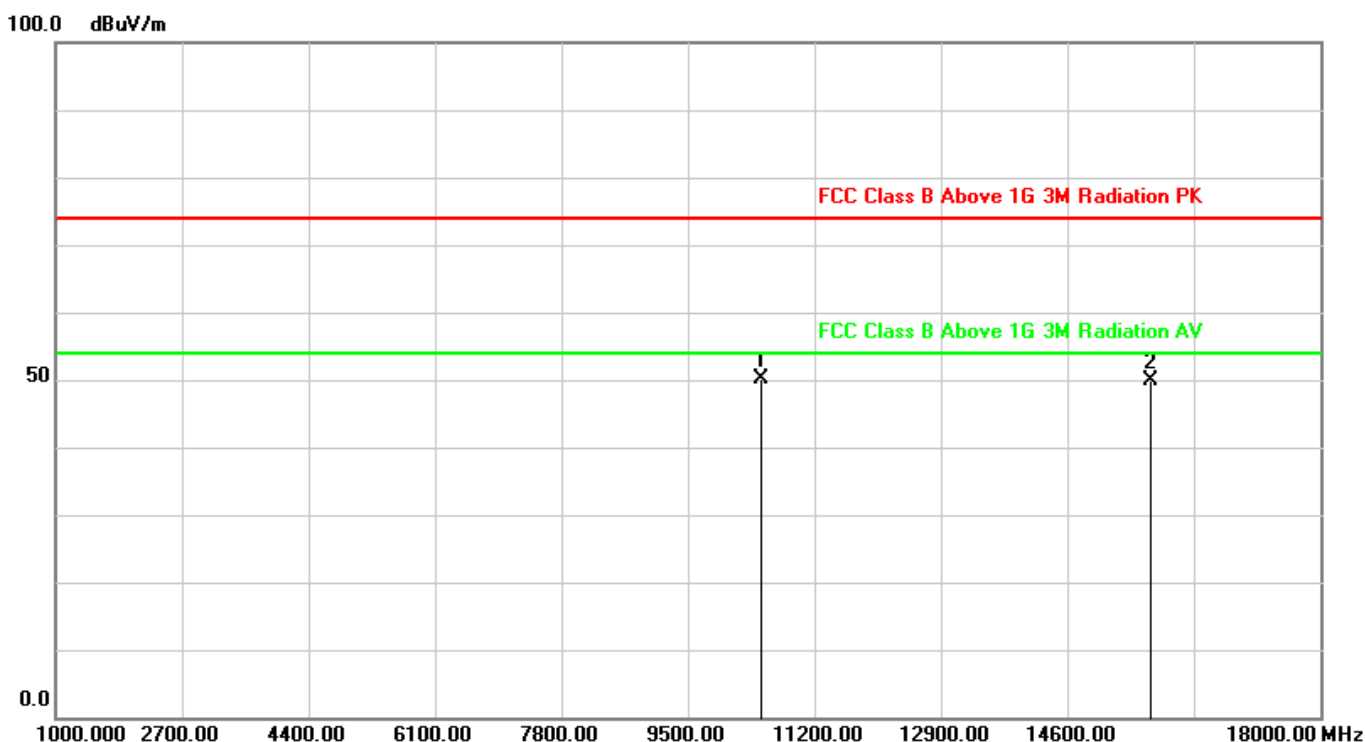

No.	Frequency (MHz)	Factor (dB/m)	Reading (dBuV)	Level (dBuV/m)	Limit (dBuV/m)	Margin (dB)	Det.
1	10480.000	11.95	38.15	50.10	74.00	-23.90	peak
2	15720.000	18.90	30.99	49.89	74.00	-24.11	peak

Note: 1. All Readings below 1GHz are Quasi-Peak, above are performed with peak and/or AVG measurements as necessary.

2. Measurement Level = Reading Level + Correct Factor.

3. The test trace is same as the ambient noise (the test frequency range: 9kHz~30MHz, 18GHz~40GHz), therefore no data appear in the report.

4. This limit applies for using average detector, if the test result on peak is lower than average limit, then average measurement needn't be performed.



Test Distance:	3M		
Test Standard:	FCC Class B Above 1G 3M	Ant. Polarization:	Horizontal
	Radiation PK		
Test item:	Radiation Emission	Test Time:	2019-8-321:23:40
Applicant:	Mitac Digital Technology Company	Power Rating:	AC 120V/60Hz
Product:	Tablet	Temp.(C)/Hum.(%)/Air p.(hpa):	26(°C)/60%/983hpa
Model No.:	N642	Test Engineer:	Chris
Test Mode:	Wi-Fi 5G-802.11n-HT20 5180MHz		
Remark:	POE Power		

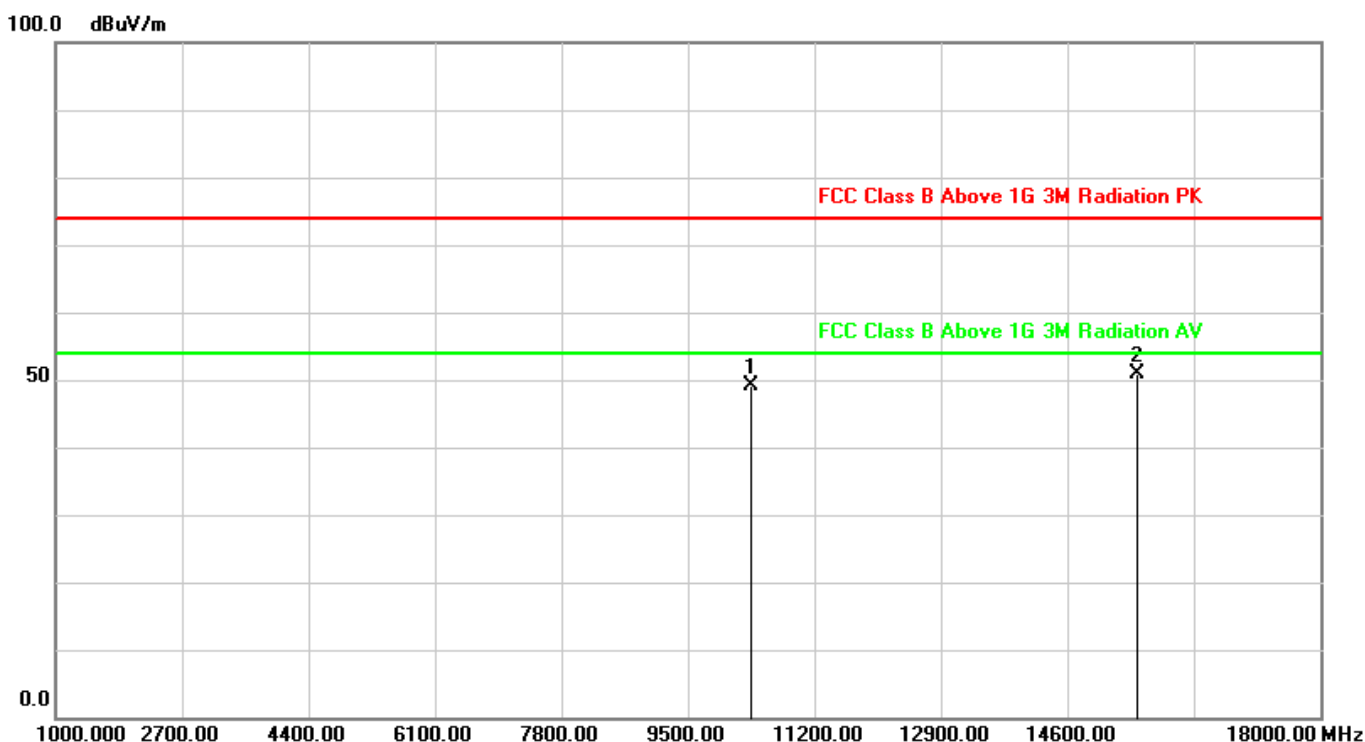

No.	Frequency (MHz)	Factor (dB/m)	Reading (dBuV)	Level (dBuV/m)	Limit (dBuV/m)	Margin (dB)	Det.
1	10360.000	11.66	37.45	49.11	74.00	-24.89	peak
2	15540.000	21.57	29.21	50.78	74.00	-23.22	peak

Note: 1. All Readings below 1GHz are Quasi-Peak, above are performed with peak and/or AVG measurements as necessary.

2. Measurement Level = Reading Level + Correct Factor.

3. The test trace is same as the ambient noise (the test frequency range: 9kHz~30MHz, 18GHz~40GHz), therefore no data appear in the report.

4. This limit applies for using average detector, if the test result on peak is lower than average limit, then average measurement needn't be performed.



Test Distance:	3M		
Test Standard:	FCC Class B Above 1G 3M	Ant. Polarization:	Vertical
	Radiation PK		
Test item:	Radiation Emission	Test Time:	2019-8-321:25:06
Applicant:	Mitac Digital Technology Company	Power Rating:	AC 120V/60Hz
Product:	Tablet	Temp.(C)/Hum.(%)/Air p.(hpa):	26(°C)/60%/983hpa
Model No.:	N642	Test Engineer:	Chris
Test Mode:	Wi-Fi 5G-802.11n-HT20 5180MHz		
Remark:	POE Power		

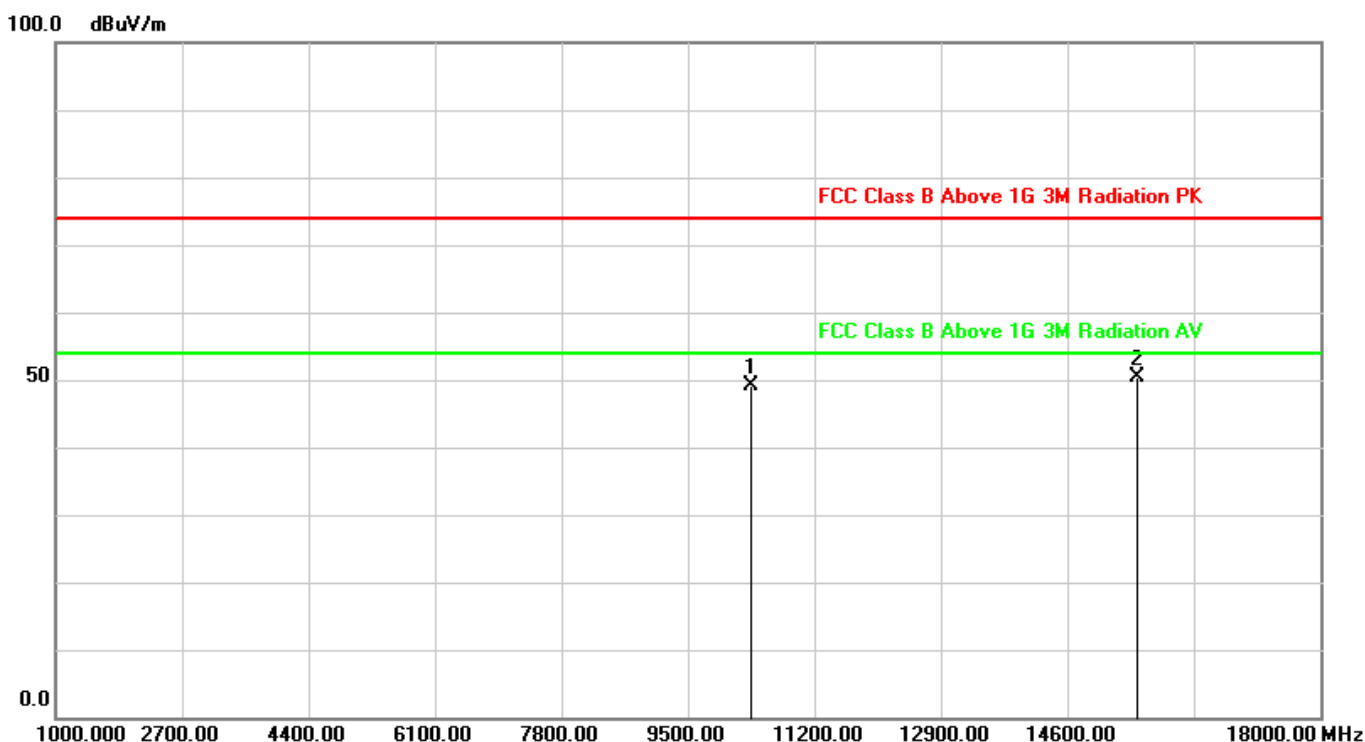

No.	Frequency (MHz)	Factor (dB/m)	Reading (dBuV)	Level (dBuV/m)	Limit (dBuV/m)	Margin (dB)	Det.
1	10360.000	11.66	37.56	49.22	74.00	-24.78	peak
2	15540.000	21.57	28.74	50.31	74.00	-23.69	peak

Note: 1. All Readings below 1GHz are Quasi-Peak, above are performed with peak and/or AVG measurements as necessary.

2. Measurement Level = Reading Level + Correct Factor.

3. The test trace is same as the ambient noise (the test frequency range: 9kHz~30MHz, 18GHz~40GHz), therefore no data appear in the report.

4. This limit applies for using average detector, if the test result on peak is lower than average limit, then average measurement needn't be performed.



Test Distance:	3M		
Test Standard:	FCC Class B Above 1G 3M	Ant. Polarization:	Horizontal
	Radiation PK		
Test item:	Radiation Emission	Test Time:	2019-8-321:28:55
Applicant:	Mitac Digital Technology Company	Power Rating:	AC 120V/60Hz
Product:	Tablet	Temp.(C)/Hum.(%)/Air p.(hpa):	26(°C)/60%/983hpa
Model No.:	N642	Test Engineer:	Chris
Test Mode:	Wi-Fi 5G-802.11n-HT20 5200MHz		
Remark:	POE Power		

100.0 dBuV/m

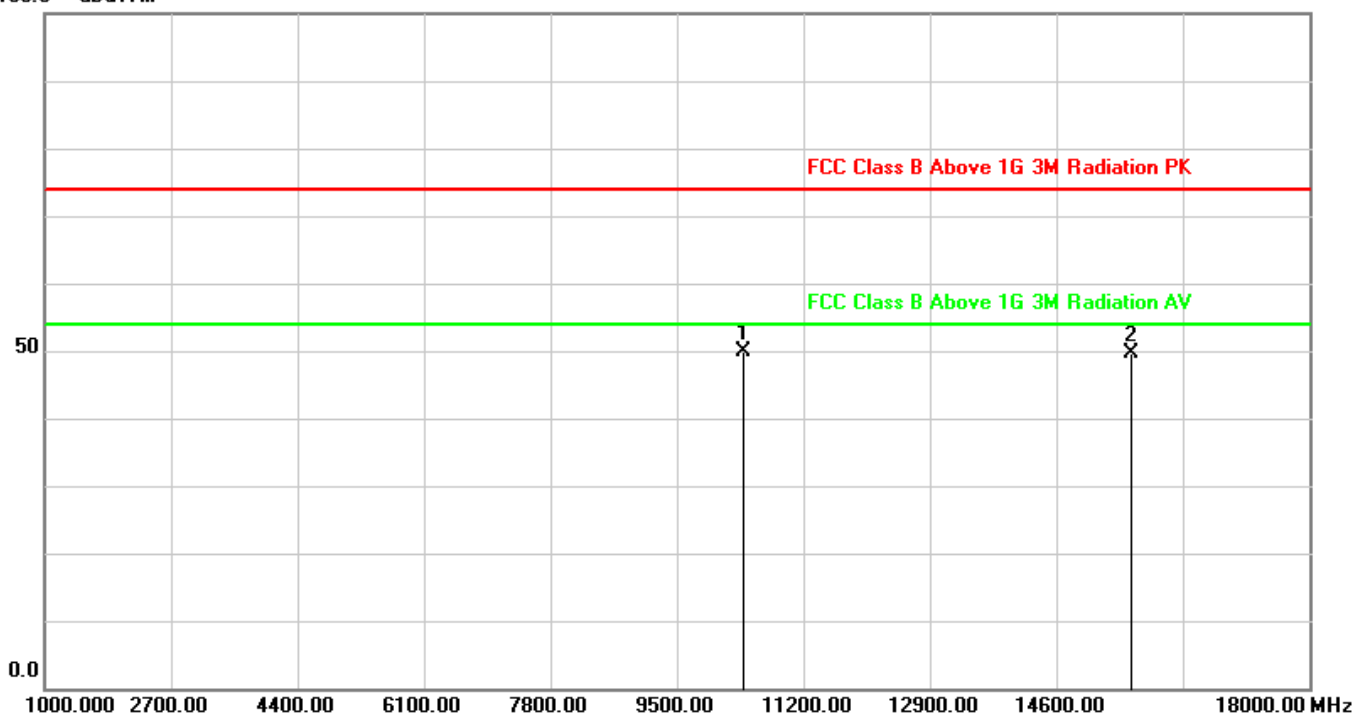

No.	Frequency (MHz)	Factor (dB/m)	Reading (dBuV)	Level (dBuV/m)	Limit (dBuV/m)	Margin (dB)	Det.
1	10400.000	11.76	38.02	49.78	74.00	-24.22	peak
2	15600.000	20.68	29.02	49.70	74.00	-24.30	peak

Note: 1. All Readings below 1GHz are Quasi-Peak, above are performed with peak and/or AVG measurements as necessary.

2. Measurement Level = Reading Level + Correct Factor.

3. The test trace is same as the ambient noise (the test frequency range: 9kHz~30MHz, 18GHz~40GHz), therefore no data appear in the report.

4. This limit applies for using average detector, if the test result on peak is lower than average limit, then average measurement needn't be performed.



Test Distance:	3M		
Test Standard:	FCC Class B Above 1G 3M	Ant. Polarization:	Vertical
	Radiation PK		
Test item:	Radiation Emission	Test Time:	2019-8-321:30:21
Applicant:	Mitac Digital Technology Company	Power Rating:	AC 120V/60Hz
Product:	Tablet	Temp.(C)/Hum.(%)/Air p.(hpa):	26(°C)/60%/983hpa
Model No.:	N642	Test Engineer:	Chris
Test Mode:	Wi-Fi 5G-802.11n-HT20 5200MHz		
Remark:	POE Power		

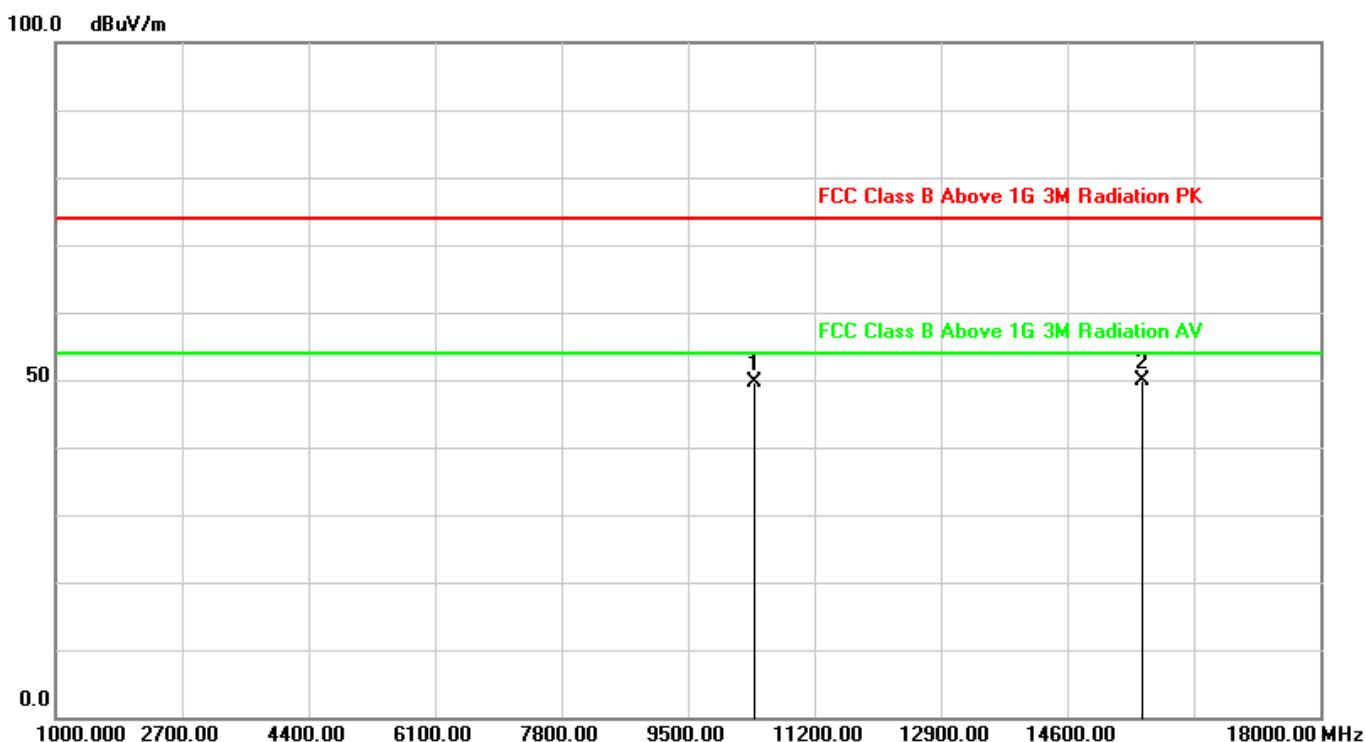

No.	Frequency (MHz)	Factor (dB/m)	Reading (dBuV)	Level (dBuV/m)	Limit (dBuV/m)	Margin (dB)	Det.
1	10400.000	11.76	37.94	49.70	74.00	-24.30	peak
2	15600.000	20.68	29.12	49.80	74.00	-24.20	peak

Note: 1. All Readings below 1GHz are Quasi-Peak, above are performed with peak and/or AVG measurements as necessary.

2. Measurement Level = Reading Level + Correct Factor.

3. The test trace is same as the ambient noise (the test frequency range: 9kHz~30MHz, 18GHz~40GHz), therefore no data appear in the report.

4. This limit applies for using average detector, if the test result on peak is lower than average limit, then average measurement needn't be performed.



Test Distance:	3M		
Test Standard:	FCC Class B Above 1G 3M	Ant. Polarization:	Horizontal
	Radiation PK		
Test item:	Radiation Emission	Test Time:	2019-8-321:33:28
Applicant:	Mitac Digital Technology Company	Power Rating:	AC 120V/60Hz
Product:	Tablet	Temp.(C)/Hum.(%)/Air p.(hpa):	26(°C)/60%/983hpa
Model No.:	N642	Test Engineer:	Chris
Test Mode:	Wi-Fi 5G-802.11n-HT20 5240MHz		
Remark:	POE Power		

100.0 dBuV/m

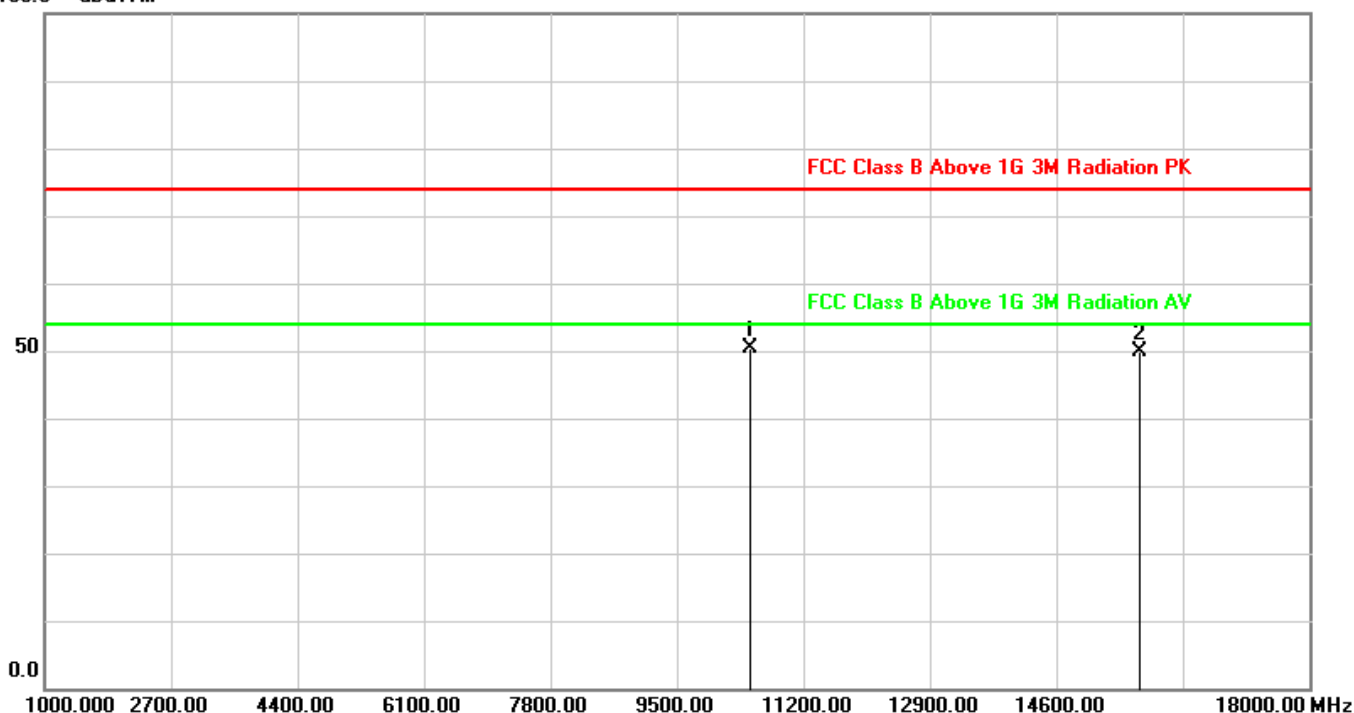

No.	Frequency (MHz)	Factor (dB/m)	Reading (dBuV)	Level (dBuV/m)	Limit (dBuV/m)	Margin (dB)	Det.
1	10480.000	11.95	38.44	50.39	74.00	-23.61	peak
2	15720.000	18.90	31.05	49.95	74.00	-24.05	peak

Note: 1. All Readings below 1GHz are Quasi-Peak, above are performed with peak and/or AVG measurements as necessary.

2. Measurement Level = Reading Level + Correct Factor.

3. The test trace is same as the ambient noise (the test frequency range: 9kHz~30MHz, 18GHz~40GHz), therefore no data appear in the report.

4. This limit applies for using average detector, if the test result on peak is lower than average limit, then average measurement needn't be performed.



Test Distance:	3M		
Test Standard:	FCC Class B Above 1G 3M	Ant. Polarization:	Vertical
	Radiation PK		
Test item:	Radiation Emission	Test Time:	2019-8-321:34:54
Applicant:	Mitac Digital Technology Company	Power Rating:	AC 120V/60Hz
Product:	Tablet	Temp.(C)/Hum.(%)/Air p.(hpa):	26(°C)/60%/983hpa
Model No.:	N642	Test Engineer:	Chris
Test Mode:	Wi-Fi 5G-802.11n-HT20 5240MHz		
Remark:	POE Power		

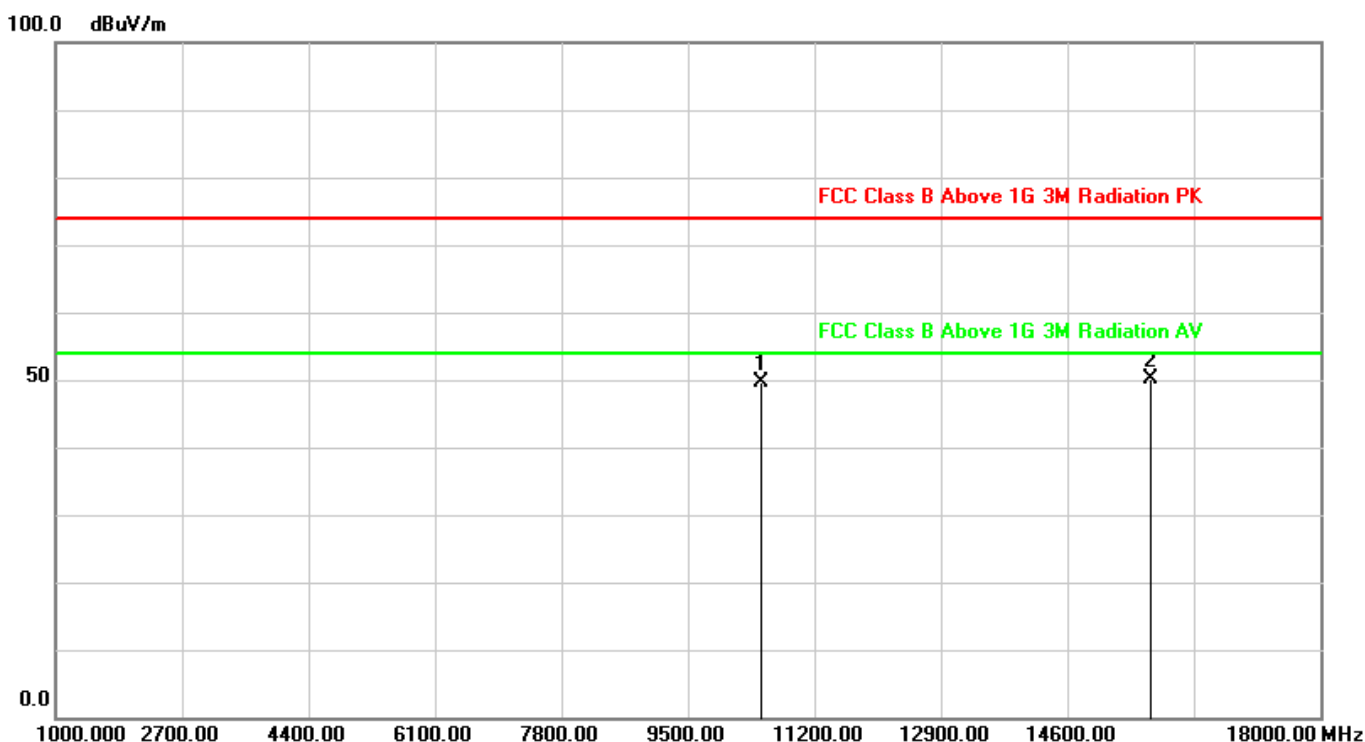

No.	Frequency (MHz)	Factor (dB/m)	Reading (dBuV)	Level (dBuV/m)	Limit (dBuV/m)	Margin (dB)	Det.
1	10480.000	11.95	37.61	49.56	74.00	-24.44	peak
2	15720.000	18.90	31.27	50.17	74.00	-23.83	peak

Note: 1. All Readings below 1GHz are Quasi-Peak, above are performed with peak and/or AVG measurements as necessary.

2. Measurement Level = Reading Level + Correct Factor.

3. The test trace is same as the ambient noise (the test frequency range: 9kHz~30MHz, 18GHz~40GHz), therefore no data appear in the report.

4. This limit applies for using average detector, if the test result on peak is lower than average limit, then average measurement needn't be performed.



Test Distance:	3M		
Test Standard:	FCC Class B Above 1G 3M	Ant. Polarization:	Horizontal
	Radiation PK		
Test item:	Radiation Emission	Test Time:	2019-8-321:38:48
Applicant:	Mitac Digital Technology Company	Power Rating:	AC 120V/60Hz
Product:	Tablet	Temp.(C)/Hum.(/Air p.(hpa):	26(°C)/60%/983hpa
Model No.:	N642	Test Engineer:	Chris
Test Mode:	Wi-Fi 5G-802.11n-HT40 5190MHz		
Remark:	POE Power		

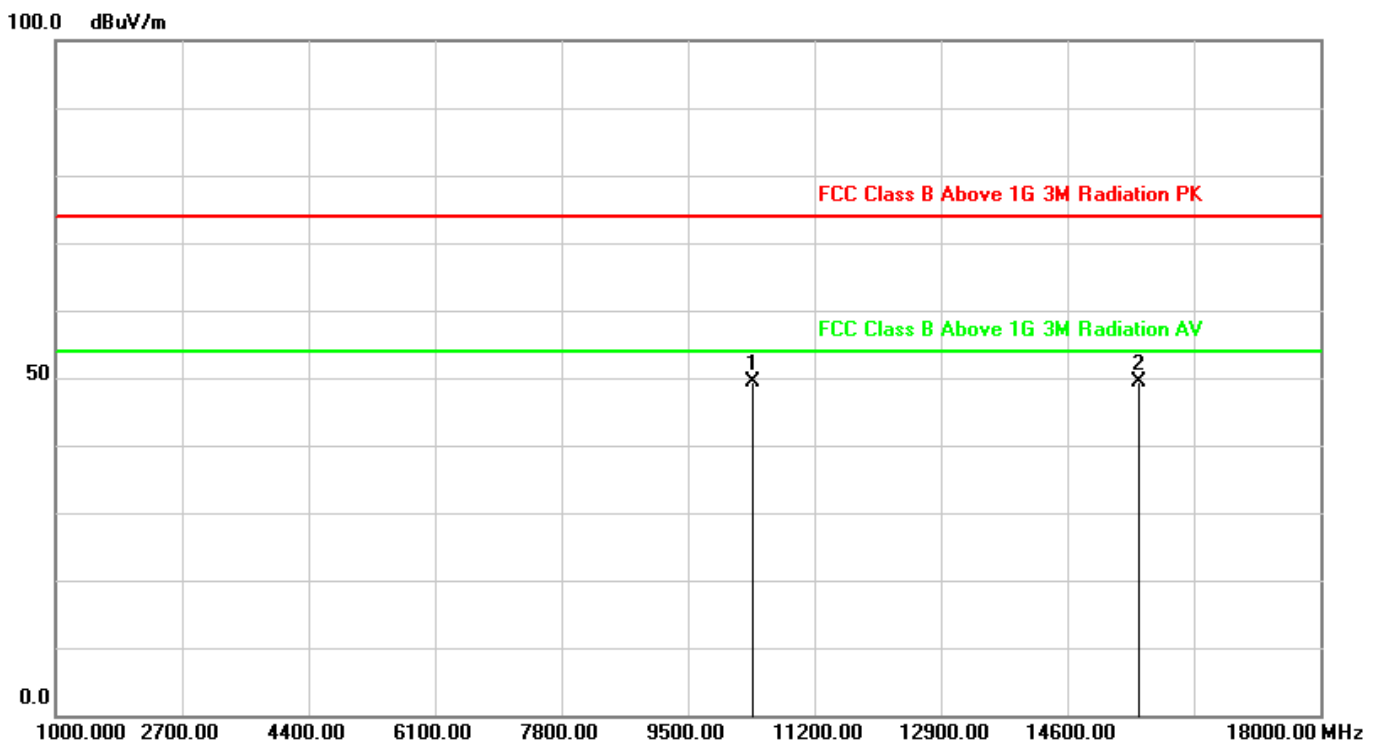

No.	Frequency (MHz)	Factor (dB/m)	Reading (dBuV)	Level (dBuV/m)	Limit (dBuV/m)	Margin (dB)	Det.
1	10380.000	11.71	37.78	49.49	74.00	-24.51	peak
2	15570.000	21.13	28.35	49.48	74.00	-24.52	peak

Note: 1. All Readings below 1GHz are Quasi-Peak, above are performed with peak and/or AVG measurements as necessary.

2. Measurement Level = Reading Level + Correct Factor.

3. The test trace is same as the ambient noise (the test frequency range: 9kHz~30MHz, 18GHz~40GHz), therefore no data appear in the report.

4. This limit applies for using average detector, if the test result on peak is lower than average limit, then average measurement needn't be performed.



Test Distance:	3M		
Test Standard:	FCC Class B Above 1G 3M	Ant. Polarization:	Vertical
	Radiation PK		
Test item:	Radiation Emission	Test Time:	2019-8-321:40:14
Applicant:	Mitac Digital Technology Company	Power Rating:	AC 120V/60Hz
Product:	Tablet	Temp.(C)/Hum.(%)/Air p.(hpa):	26(°C)/60%/983hpa
Model No.:	N642	Test Engineer:	Chris
Test Mode:	Wi-Fi 5G-802.11n-HT40 5190MHz		
Remark:	POE Power		

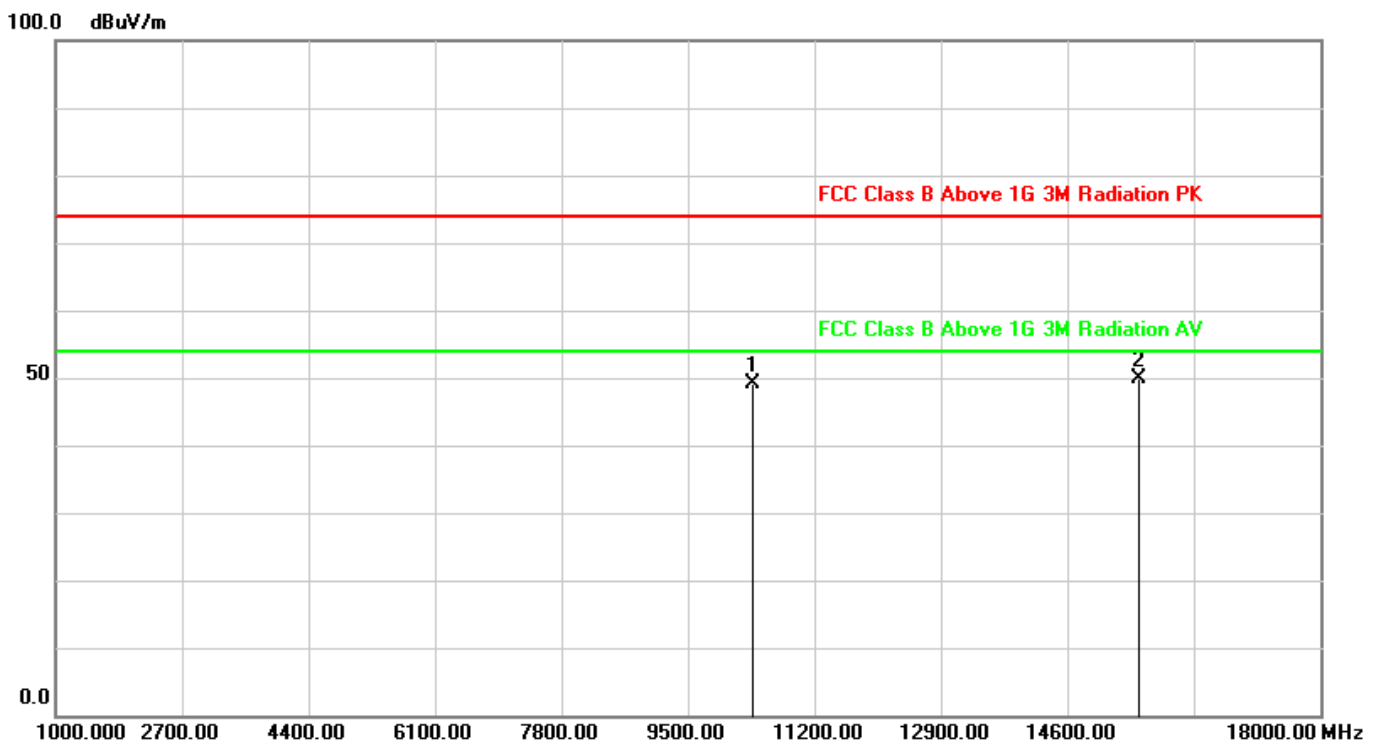

No.	Frequency (MHz)	Factor (dB/m)	Reading (dBuV)	Level (dBuV/m)	Limit (dBuV/m)	Margin (dB)	Det.
1	10380.000	11.71	37.50	49.21	74.00	-24.79	peak
2	15570.000	21.13	28.87	50.00	74.00	-24.00	peak

Note: 1. All Readings below 1GHz are Quasi-Peak, above are performed with peak and/or AVG measurements as necessary.

2. Measurement Level = Reading Level + Correct Factor.

3. The test trace is same as the ambient noise (the test frequency range: 9kHz~30MHz, 18GHz~40GHz), therefore no data appear in the report.

4. This limit applies for using average detector, if the test result on peak is lower than average limit, then average measurement needn't be performed.



Test Distance:	3M		
Test Standard:	FCC Class B Above 1G 3M	Ant. Polarization:	Horizontal
	Radiation PK		
Test item:	Radiation Emission	Test Time:	2019-8-321:43:34
Applicant:	Mitac Digital Technology Company	Power Rating:	AC 120V/60Hz
Product:	Tablet	Temp.(C)/Hum.(%)/Air p.(hpa):	26(°C)/60%/983hpa
Model No.:	N642	Test Engineer:	Chris
Test Mode:	Wi-Fi 5G-802.11n-HT40 5230MHz		
Remark:	POE Power		

100.0 dBuV/m

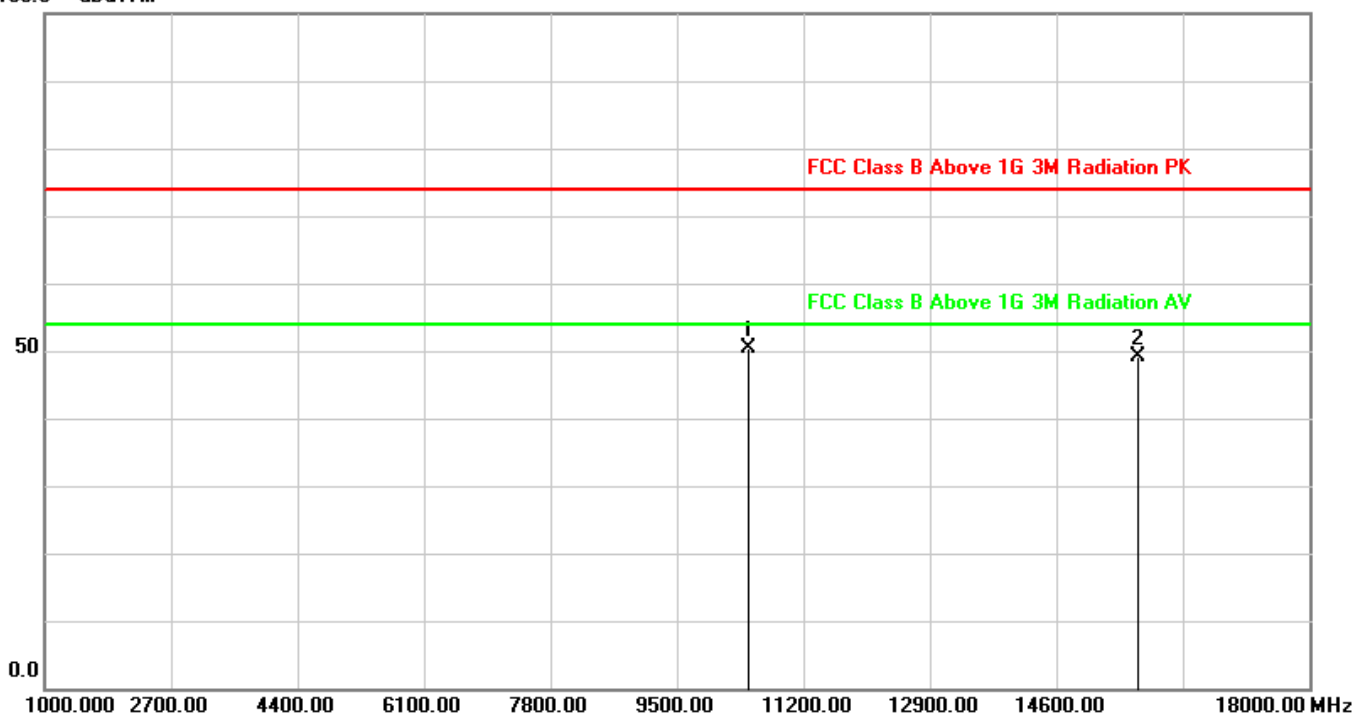

No.	Frequency (MHz)	Factor (dB/m)	Reading (dBuV)	Level (dBuV/m)	Limit (dBuV/m)	Margin (dB)	Det.
1	10460.000	11.90	38.39	50.29	74.00	-23.71	peak
2	15690.000	19.34	29.67	49.01	74.00	-24.99	peak

Note: 1. All Readings below 1GHz are Quasi-Peak, above are performed with peak and/or AVG measurements as necessary.

2. Measurement Level = Reading Level + Correct Factor.

3. The test trace is same as the ambient noise (the test frequency range: 9kHz~30MHz, 18GHz~40GHz), therefore no data appear in the report.

4. This limit applies for using average detector, if the test result on peak is lower than average limit, then average measurement needn't be performed.



Test Distance:	3M		
Test Standard:	FCC Class B Above 1G 3M	Ant. Polarization:	Vertical
	Radiation PK		
Test item:	Radiation Emission	Test Time:	2019-8-321:44:59
Applicant:	Mitac Digital Technology Company	Power Rating:	AC 120V/60Hz
Product:	Tablet	Temp.(C)/Hum.(%)/Air p.(hpa):	26(°C)/60%/983hpa
Model No.:	N642	Test Engineer:	Chris
Test Mode:	Wi-Fi 5G-802.11n-HT40 5230MHz		
Remark:	POE Power		

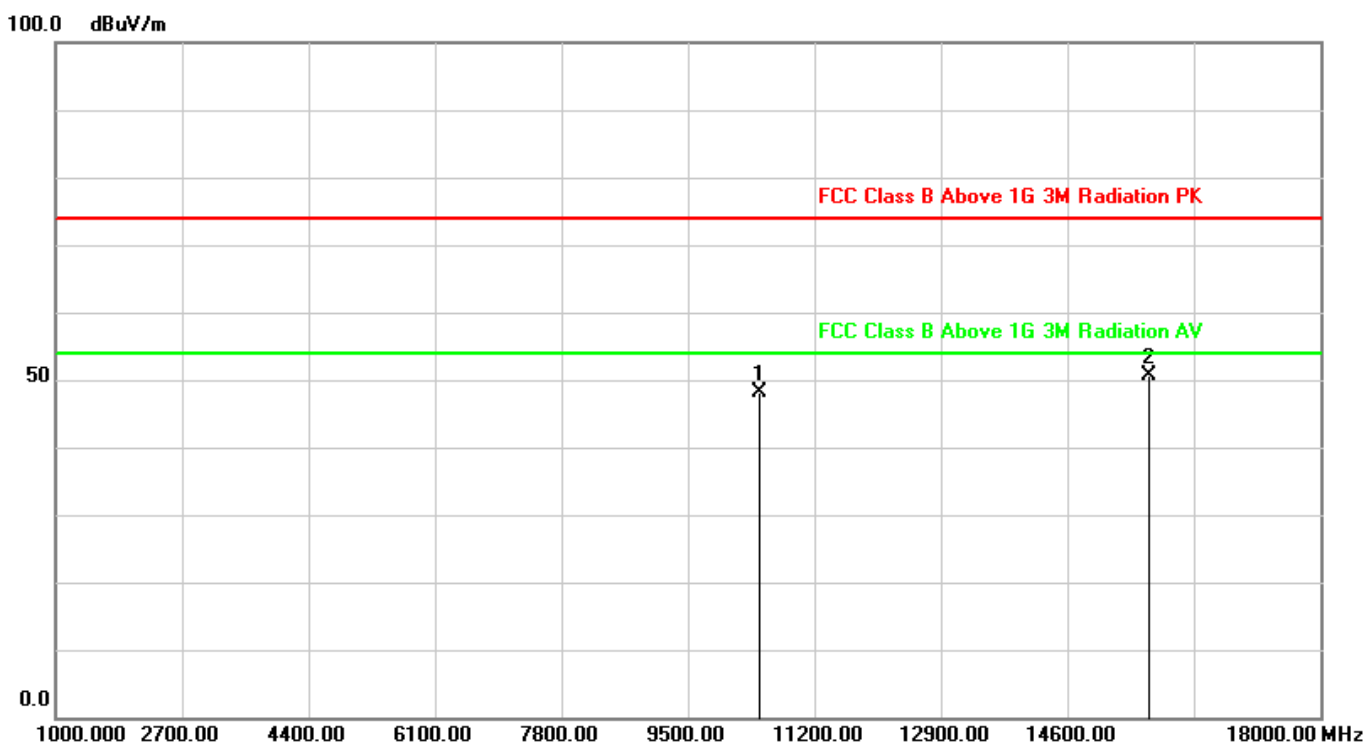

No.	Frequency (MHz)	Factor (dB/m)	Reading (dBuV)	Level (dBuV/m)	Limit (dBuV/m)	Margin (dB)	Det.
1	10460.000	11.90	36.20	48.10	74.00	-25.90	peak
2	15690.000	19.34	31.17	50.51	74.00	-23.49	peak

Note: 1. All Readings below 1GHz are Quasi-Peak, above are performed with peak and/or AVG measurements as necessary.

2. Measurement Level = Reading Level + Correct Factor.

3. The test trace is same as the ambient noise (the test frequency range: 9kHz~30MHz, 18GHz~40GHz), therefore no data appear in the report.

4. This limit applies for using average detector, if the test result on peak is lower than average limit, then average measurement needn't be performed.



5. 26dB and 99% Occupied Bandwidth

5.1 Test Limit

N/A

5.2 Test Standard

KDB 789033 D02v02r01– Section C.1

5.3 Test Procedures

The EUT was tested according to KDB 789033 for compliance to FCC 47CFR 15.407 requirements.

Emission Bandwidth

- Use a RBW = approximately 1% of the emission bandwidth.
- Set the VBW > RBW
- Detector = Peak.
- Trace mode = max hold.
- Measure the maximum width of the emission that is 26 dB down from the peak of the emission. Compare this with the RBW setting of the analyzer. Readjust RBW and repeat measurement as needed until the RBW/EBW ratio is approximately 1%.

99% Occupied Bandwidth

- Set center frequency to the nominal EUT channel center frequency.
- Set span = 1.5 times to 5.0 times the OBW.
- Set RBW = 1 % to 5 % of the OBW.
- Set VBW $\geq 3 \cdot$ RBW.
- Video averaging is not permitted. Where practical, a sample detection and single sweep mode shall be used. Otherwise, peak detection and max hold mode (until the trace stabilizes) shall be used.
- Use the 99 % power bandwidth function of the instrument (if available).
- If the instrument does not have a 99 % power bandwidth function, the trace data points are recovered and directly summed in power units. The recovered amplitude data points, beginning at the lowest frequency, are placed in a running sum until 0.5 % of the total is reached; that frequency is recorded as the lower frequency. The process is repeated until 99.5 % of the total is reached; that frequency is recorded as the upper frequency. The 99% occupied bandwidth is the difference between these two frequencies.



5.4 Test Setup

Spectrum Analyzer

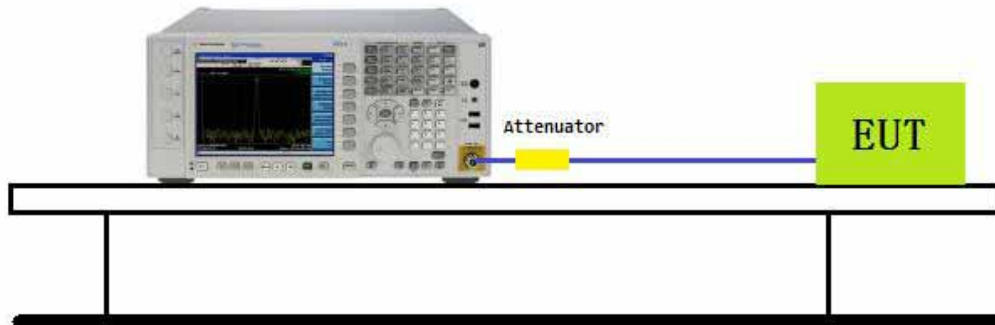



5.5 Test Result

5.5.1 Non-straddle Channel

Test Item	26dB Bandwidth Measurement
Test Engineer:	Chris
Test Date	2019-07-30

Test Mode	Data Rate (Mbps)	Channel No.	Frequency (MHz)	26dB Bandwidth (MHz)	Result
802.11a	6	36	5180	22.603	Pass
		40	5200	22.607	Pass
		48	5240	22.534	Pass
		52	5260	22.907	Pass
		56	5280	22.770	Pass
		64	5320	22.322	Pass
		100	5500	22.605	Pass
		120	5600	22.544	Pass
		140	5700	22.300	Pass
		149	5745	22.542	Pass
		157	5785	22.727	Pass
		165	5825	22.865	Pass

Test Mode	Data Rate (Mbps)	Channel No.	Frequency (MHz)	26dB Bandwidth (MHz)	Result
802.11n HT20	6.5	36	5180	23.036	Pass
		40	5200	22.964	Pass
		48	5240	22.628	Pass
		52	5260	22.487	Pass
		56	5280	22.599	Pass
		64	5320	22.938	Pass
		100	5500	22.621	Pass
		120	5600	22.638	Pass
		140	5700	23.140	Pass
		149	5745	23.066	Pass
		157	5785	23.002	Pass
		165	5825	22.976	Pass



Test Mode	Data Rate (Mbps)	Channel No.	Frequency (MHz)	26dB Bandwidth (MHz)	Result
802.11n HT40	13.5	38	5190	44.179	Pass
		46	5230	44.288	Pass
		54	5270	44.264	Pass
		62	5310	43.225	Pass
		102	5510	43.689	Pass
		118	5590	44.468	Pass
		134	5670	44.278	Pass
		151	5755	44.185	Pass
		159	5795	44.520	Pass



802.11a 26dB Bandwidth

Channel 36 (5180MHz)

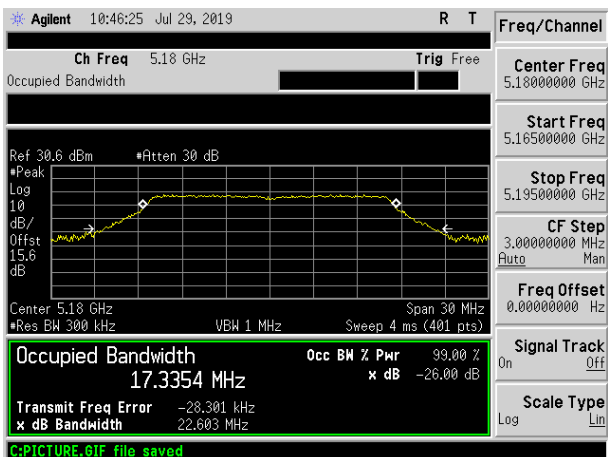

Channel 40 (5200MHz)

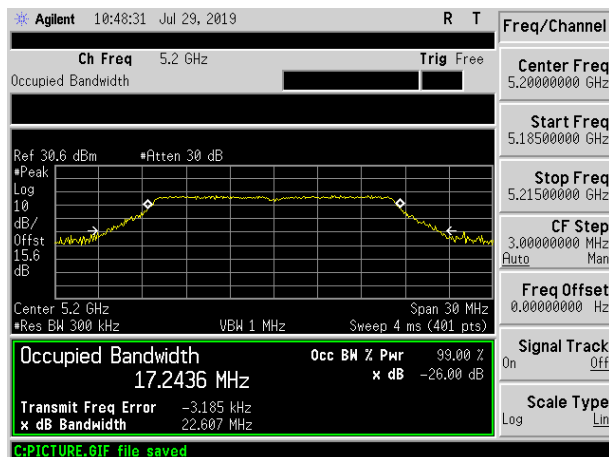

Channel 48 (5240MHz)

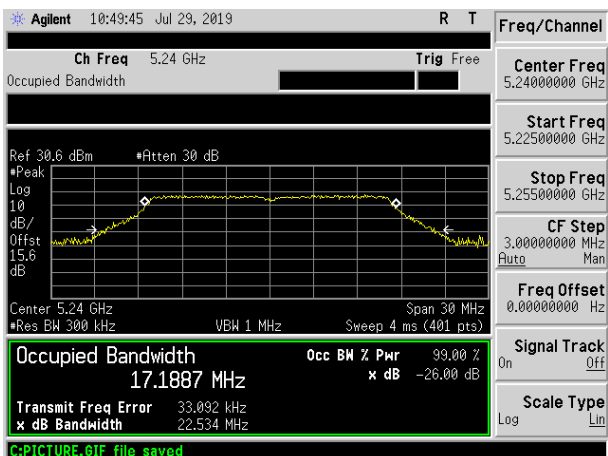

Channel 52 (5260MHz)

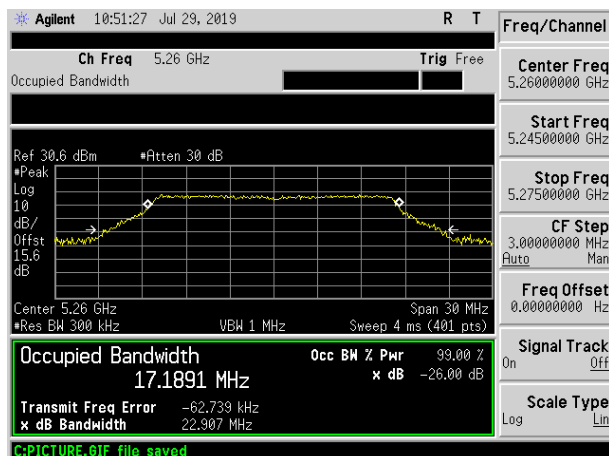

Channel 56 (5280MHz)

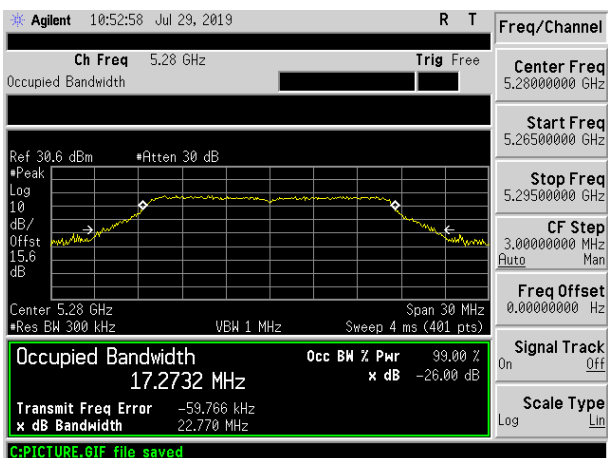

Channel 64 (5320MHz)

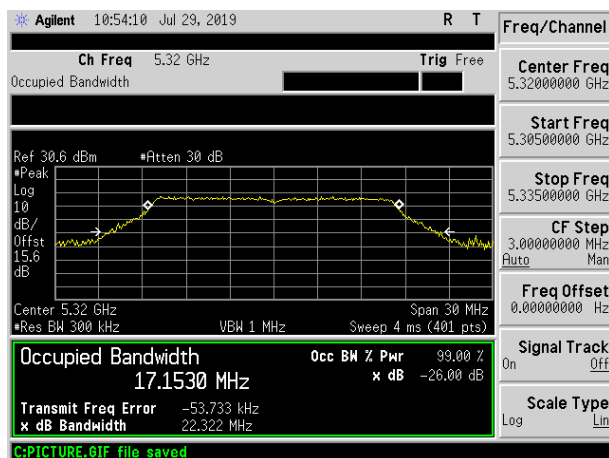

Channel 100 (5500MHz)

Channel 120 (5600MHz)

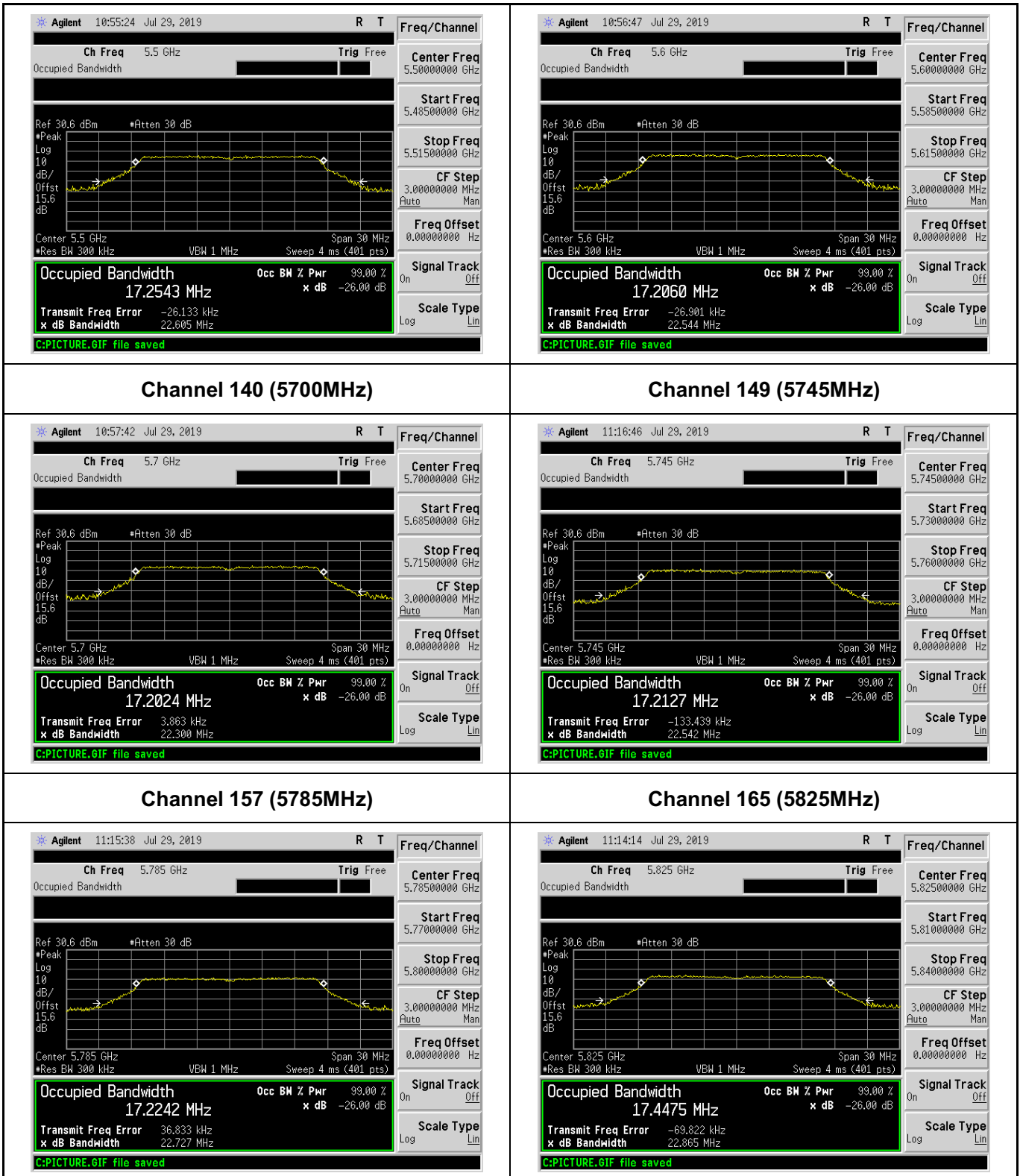



802.11n HT20 26dB Bandwidth

Channel 36 (5180MHz)

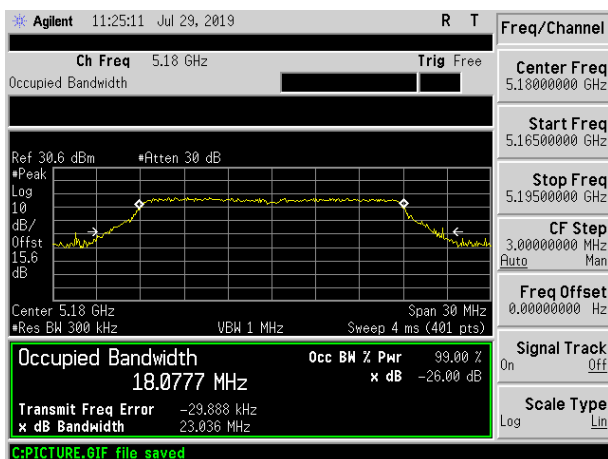

Channel 40 (5200MHz)

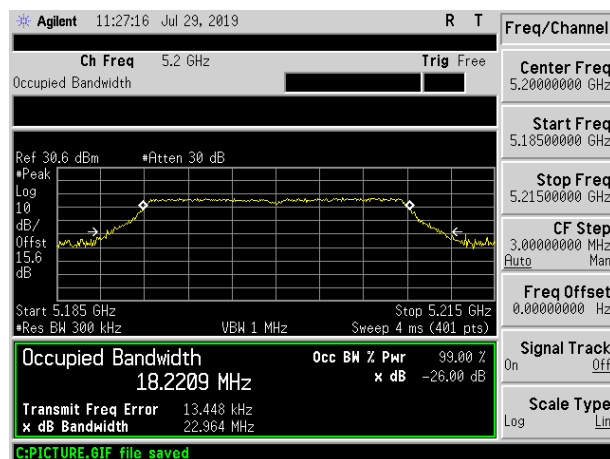

Channel 48 (5240MHz)

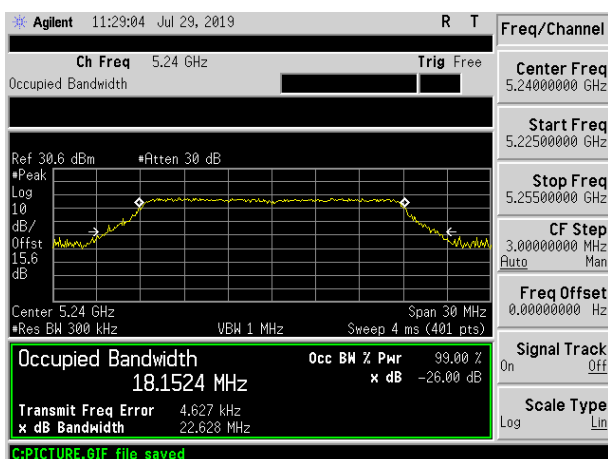

Channel 52 (5260MHz)

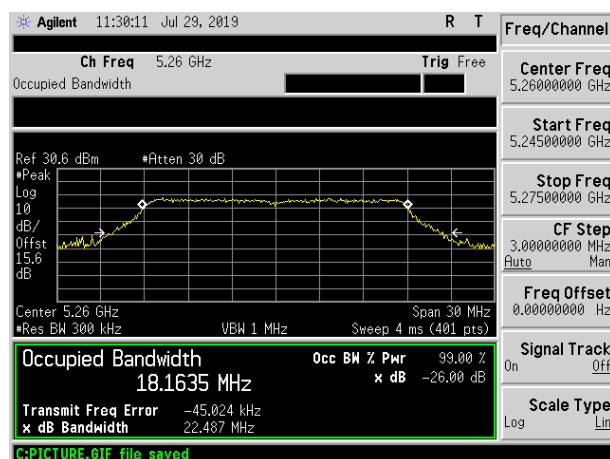

Channel 56 (5280MHz)

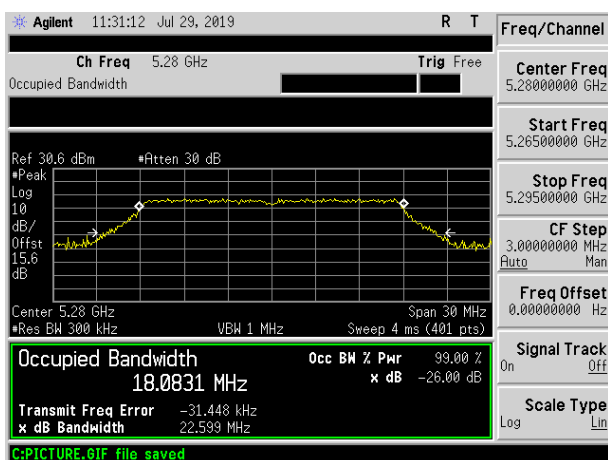

Channel 64 (5320MHz)

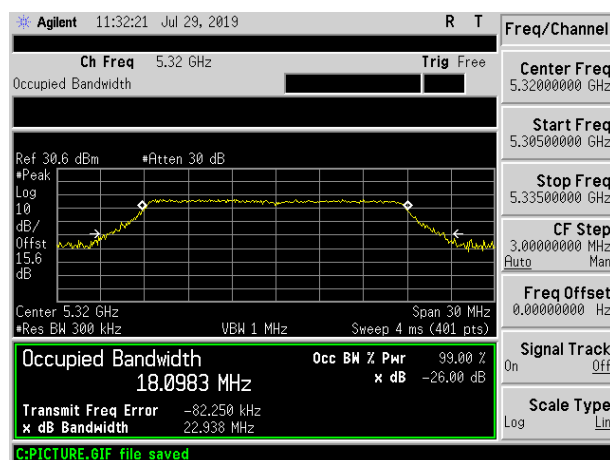

Channel 100 (5500MHz)

Channel 120 (5600MHz)

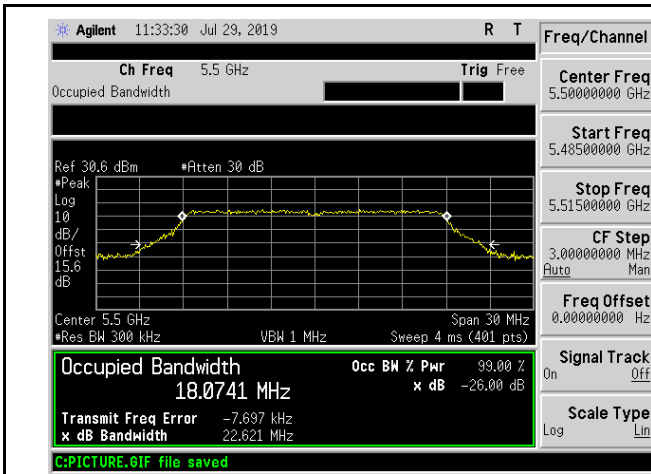

Channel 140 (5700MHz)

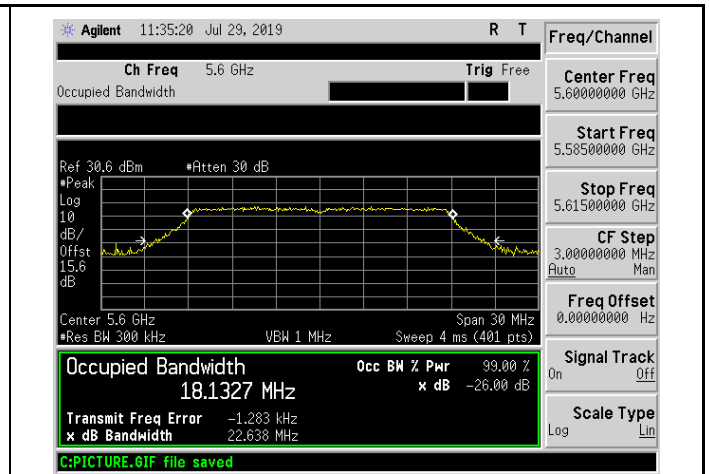

Channel 149 (5745MHz)

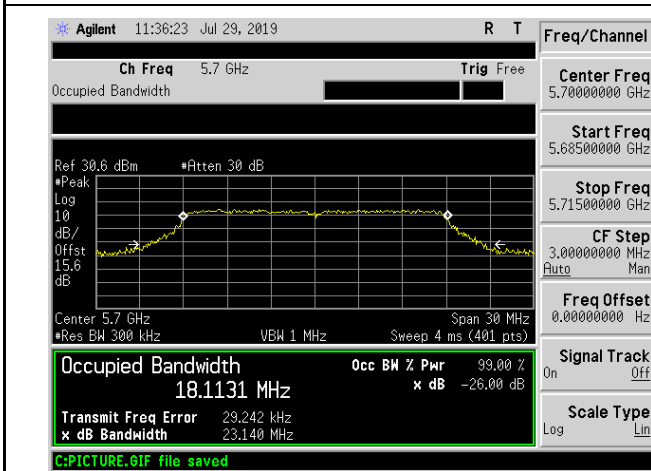

Channel 157 (5785MHz)

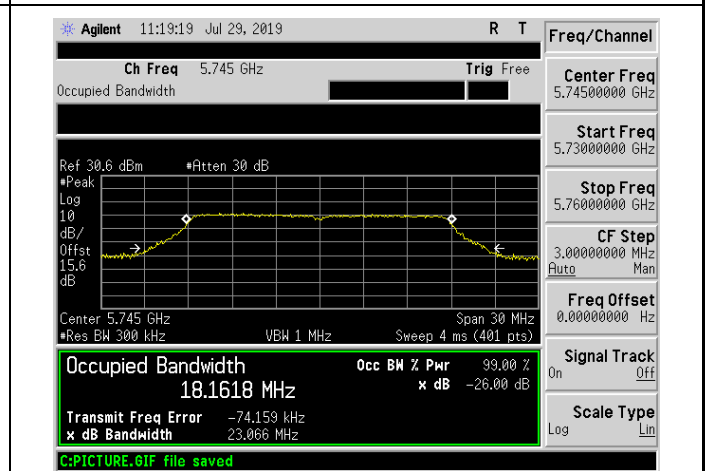

Channel 165 (5825MHz)

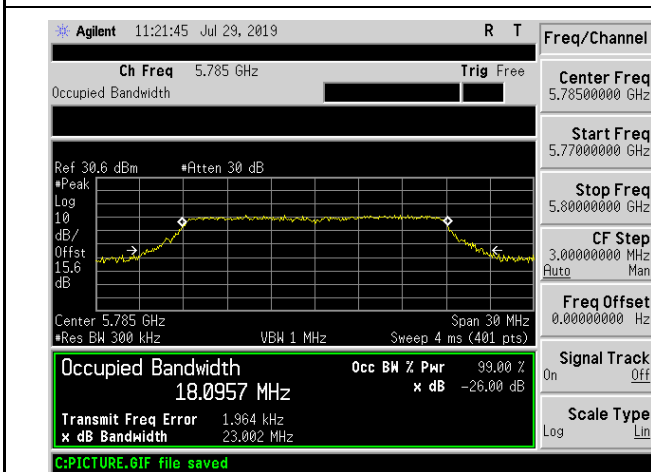

Channel 157 (5785MHz)

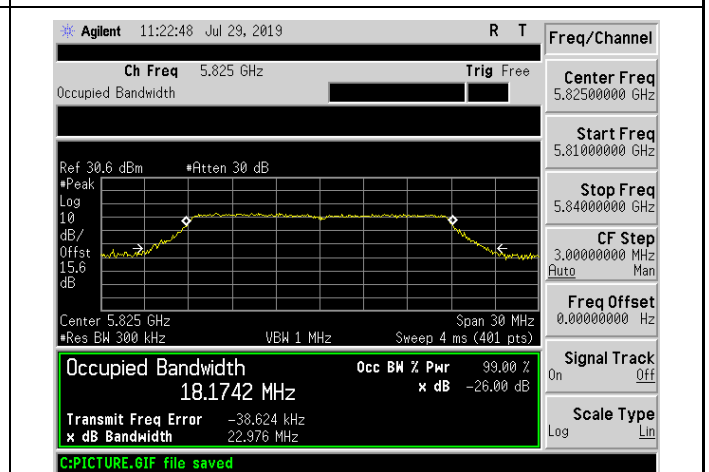

Channel 165 (5825MHz)



802.11n HT40 26dB Bandwidth

Channel 38 (5190MHz)

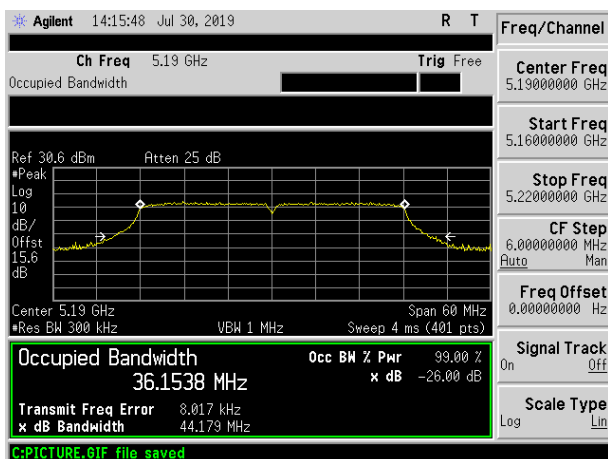

Channel 46 (5230MHz)

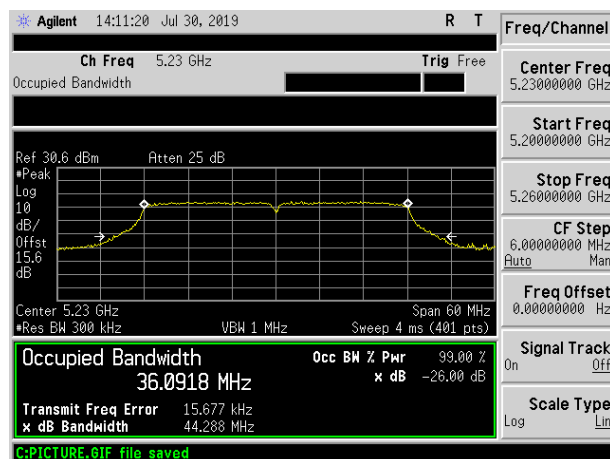

Channel 54 (5270MHz)

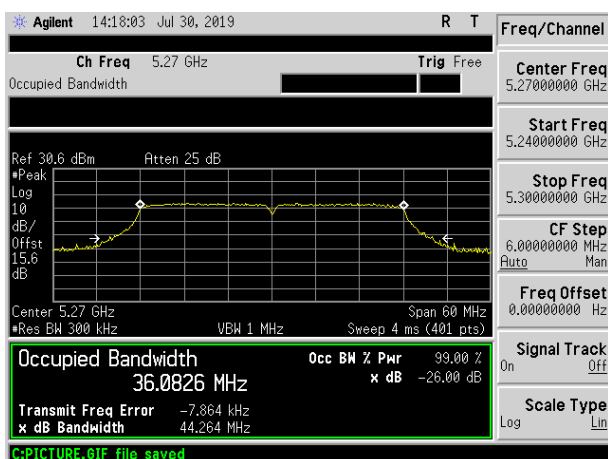

Channel 62 (5310MHz)

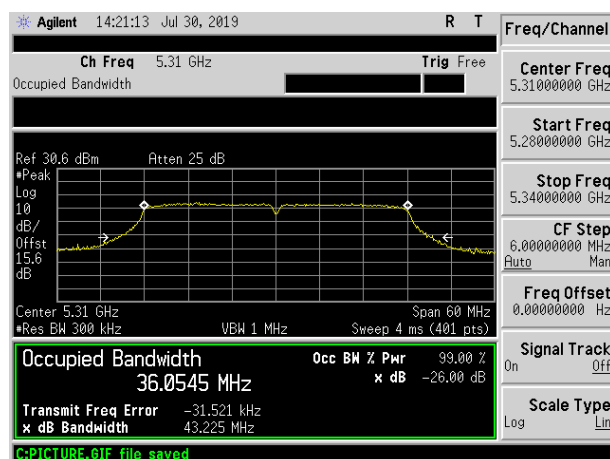

Channel 102 (5510MHz)

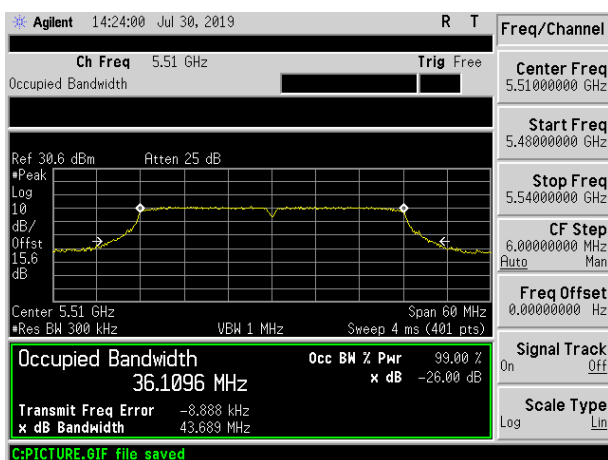

Channel 118 (5590MHz)

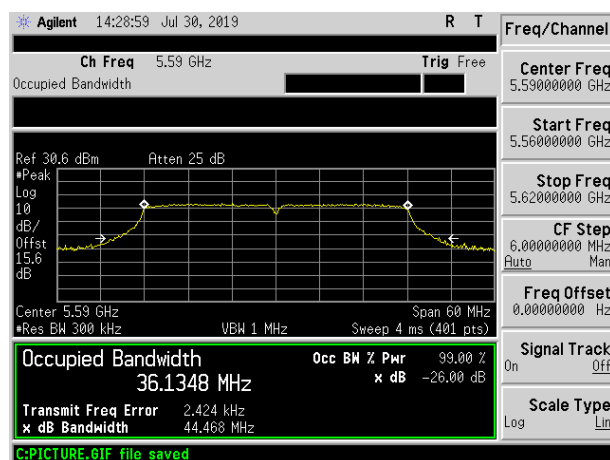

Channel 134 (5670MHz)

Channel 151 (5755MHz)



<p>Agilent 14:31:19 Jul 30, 2019 R T</p> <p>Ch Freq 5.67 GHz Trig Free</p> <p>Center Freq 5.67000000 GHz</p> <p>Start Freq 5.64000000 GHz</p> <p>Stop Freq 5.70000000 GHz</p> <p>CF Step 6.00000000 MHz</p> <p>Freq Offset 0.00000000 Hz</p> <p>Occupied Bandwidth 36.1913 MHz</p> <p>Transmit Freq Error -43.621 kHz</p> <p>C:PICTURE.GIF file saved</p>	<p>Agilent 14:54:22 Jul 30, 2019 R T</p> <p>Ch Freq 5.755 GHz Trig Free</p> <p>Center Freq 5.75500000 GHz</p> <p>Start Freq 5.72500000 GHz</p> <p>Stop Freq 5.78500000 GHz</p> <p>CF Step 6.00000000 MHz</p> <p>Freq Offset 0.00000000 Hz</p> <p>Occupied Bandwidth 36.2466 MHz</p> <p>Transmit Freq Error -89.441 kHz</p> <p>C:PICTURE.GIF file saved</p>
<p>Channel 159 (5795MHz)</p>	<p>N/A</p>
<p>Agilent 14:58:24 Jul 30, 2019 R T</p> <p>Ch Freq 5.795 GHz Trig Free</p> <p>Center Freq 5.79500000 GHz</p> <p>Start Freq 5.76500000 GHz</p> <p>Stop Freq 5.82500000 GHz</p> <p>CF Step 6.00000000 MHz</p> <p>Freq Offset 0.00000000 Hz</p> <p>Occupied Bandwidth 36.1348 MHz</p> <p>Transmit Freq Error 71.246 kHz</p> <p>C:PICTURE.GIF file saved</p>	<p>N/A</p>



Test Item	99% Bandwidth Measurement
Test Engineer:	Chris
Test Date	2019-08-05

Test Mode	Data Rate (Mbps)	Channel No.	Frequency (MHz)	99% Bandwidth (MHz)	Result
802.11a	6	48	5240	16.830	Pass
		52	5260	16.866	Pass
802.11n HT20	6.5	48	5240	17.848	Pass
		52	5260	17.954	Pass
802.11n HT40	13.5	46	5230	36.126	Pass
		54	5270	36.175	Pass



802.11a 99% Bandwidth

Channel 48 (5240MHz)

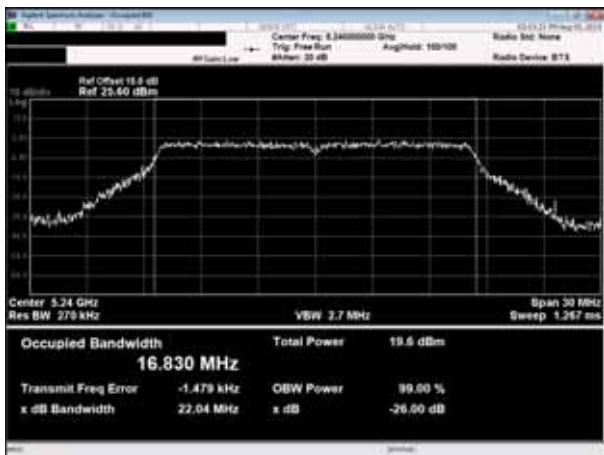

Channel 52 (5260MHz)

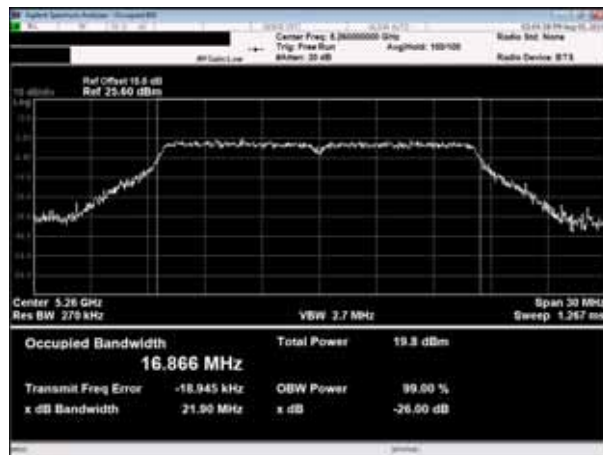



802.11n HT20 99% Bandwidth

Channel 48 (5240MHz)

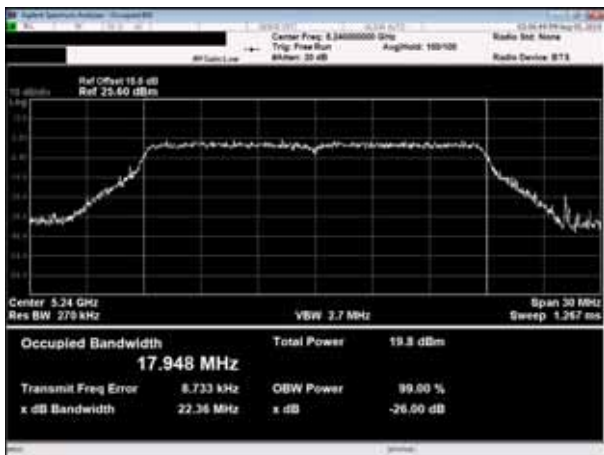

Channel 52 (5260MHz)

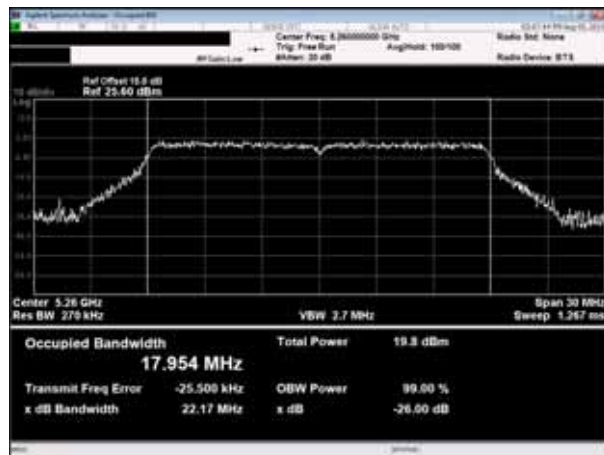



802.11n HT40 99% Bandwidth

Channel 46 (5230MHz)

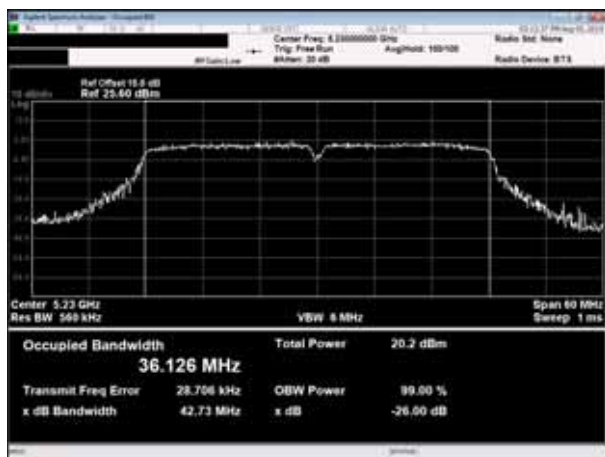

Channel 54 (5270MHz)

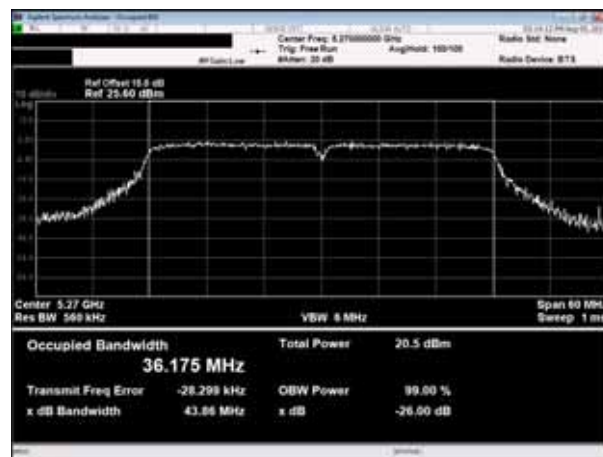



5.5.2 Straddle Channel

Test Item	26dB and 99% Bandwidth Measurement
Test Engineer:	Chris
Test Date	2019-08-03

Within 5470-5725MHz Band, Straddle Channel

Test Mode	Channel No.	Frequency (MHz)	26dB Bandwidth (MHz)	99% Bandwidth (MHz)	Result
802.11a	144	5720	16.94	13.88	Pass
802.11n HT20	144	5720	17.06	14.30	Pass
802.11n HT40	142	5710	36.60	33.00	Pass

Extends across 5725MHz Band, Straddle Channel

Test Mode	Channel No.	Frequency (MHz)	26dB Bandwidth (MHz)	99% Bandwidth (MHz)	Result
802.11a	144	5720	6.64	3.76	Pass
802.11n HT20	144	5720	7.00	4.24	Pass
802.11n HT40	142	5710	6.96	3.12	Pass



802.11n(40MHz)

Channel 142 (5710MHz)

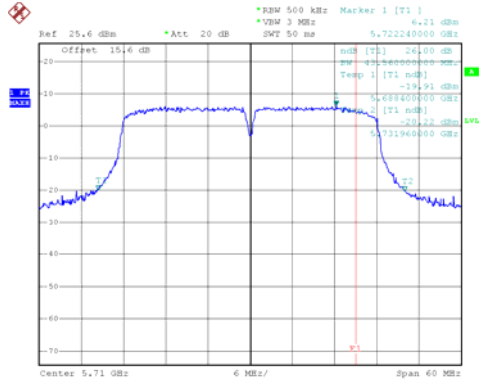

Channel 142 (5710MHz)

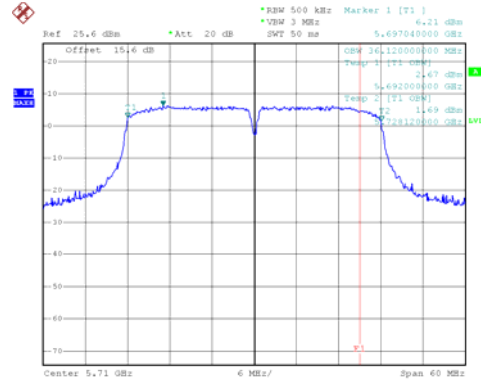



6. 6dB Bandwidth Measurement

6.1 Test Limit

Section 15.407(e) specifies the minimum 6 dB emission bandwidth of at least 500 kHz for the band 5.725-5.85 GHz.

6.2 Test Standard

KDB 789033 D02v02r01 – Section C.2

6.3 Test Procedures

1. Set center frequency to the nominal EUT channel center frequency.
2. RBW = 100 kHz.
3. VBW \cong 3 \times RBW.
4. Detector = Peak.
5. Trace mode = max hold.
6. Sweep = auto couple.
7. Allow the trace to stabilize.
8. Measure the maximum width of the emission that is constrained by the frequencies associated with the two outermost amplitude points (upper and lower frequencies) that are attenuated by 6 dB relative to the maximum level measured in the fundamental emission.

Note: The automatic bandwidth measurement capability of a spectrum analyzer or EMI receiver may be employed if it implements the functionality described above.

6.4 Test Setup

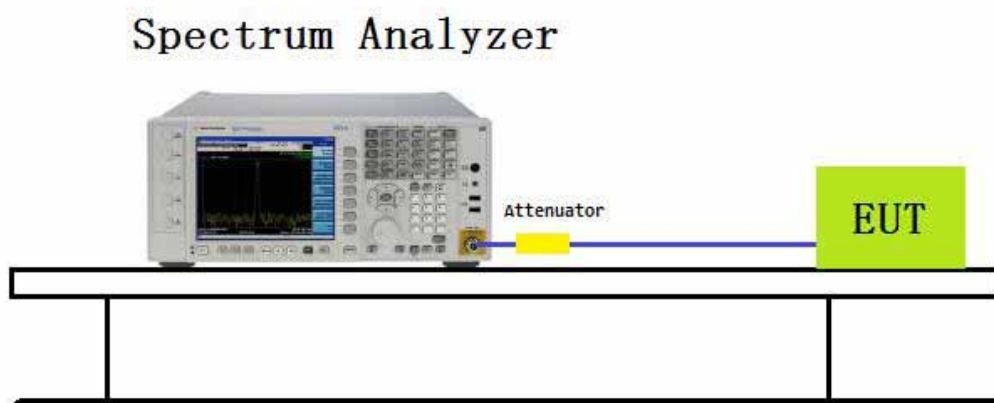



6.5 Test Result

Test Item	6dB Bandwidth Measurement
Test Engineer:	Chris
Test Date	2019-07-30

Test Mode	Data Rate (Mbps)	Channel No.	Frequency (MHz)	6dB Bandwidth (MHz)	Limit (MHz)	Result
802.11a	6	149	5745	16.429	≥ 0.5	Pass
		157	5785	16.443	≥ 0.5	Pass
		165	5825	16.444	≥ 0.5	Pass
802.11n(20MHz)	6.5	149	5745	17.642	≥ 0.5	Pass
		157	5785	17.634	≥ 0.5	Pass
		165	5825	17.648	≥ 0.5	Pass
802.11n(40MHz)	13.5	151	5755	35.882	≥ 0.5	Pass
		159	5795	35.348	≥ 0.5	Pass



802.11a 6dB Bandwidth

Channel 149 (5745MHz)

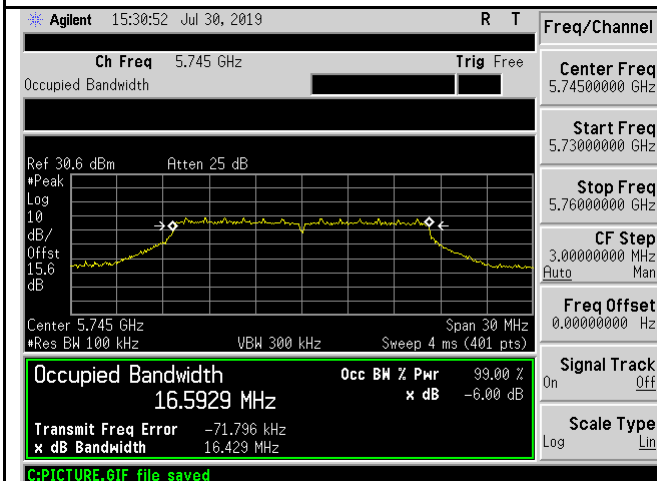

Channel 157 (5785MHz)

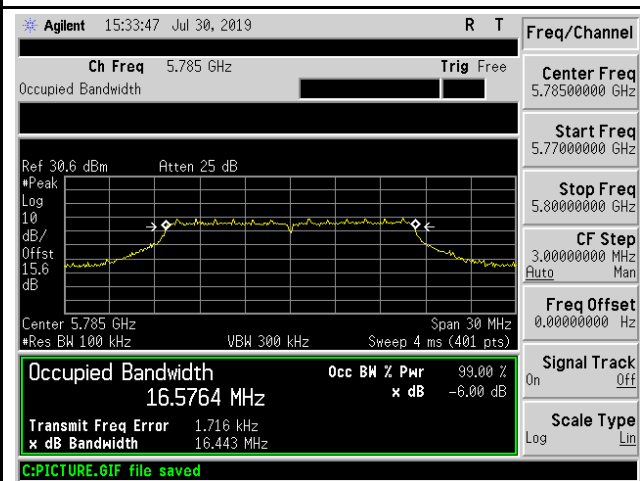

Channel 165 (5825MHz)

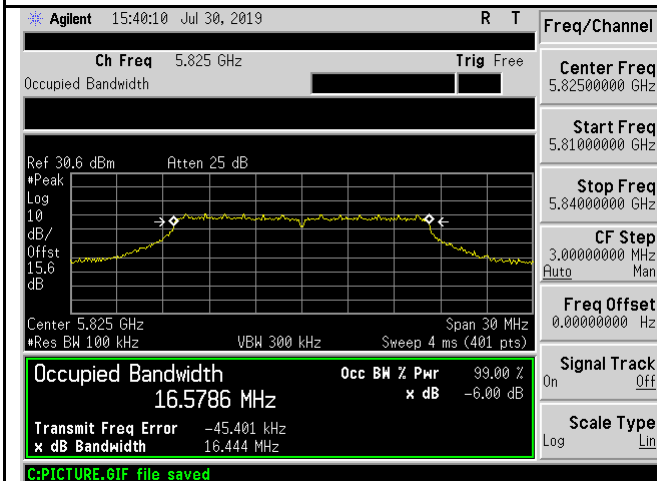



802.11n(20MHz) 6dB Bandwidth

Channel 149 (5745MHz)

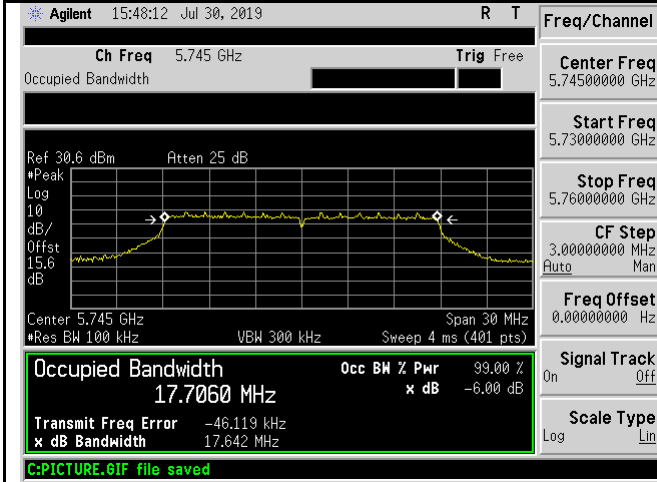

Channel 157 (5785MHz)

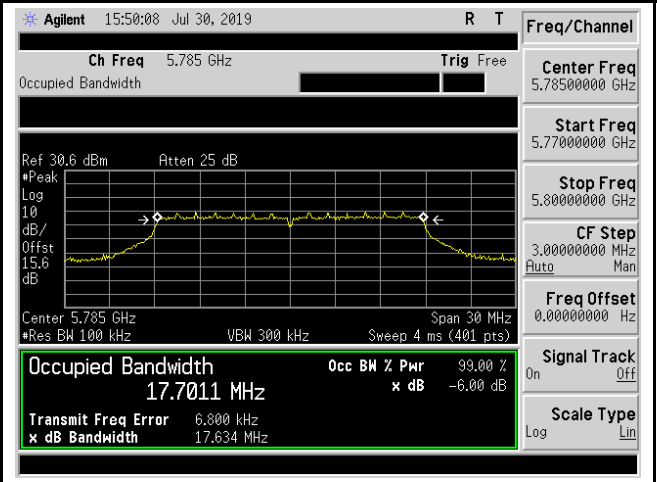

Channel 165 (5825MHz)

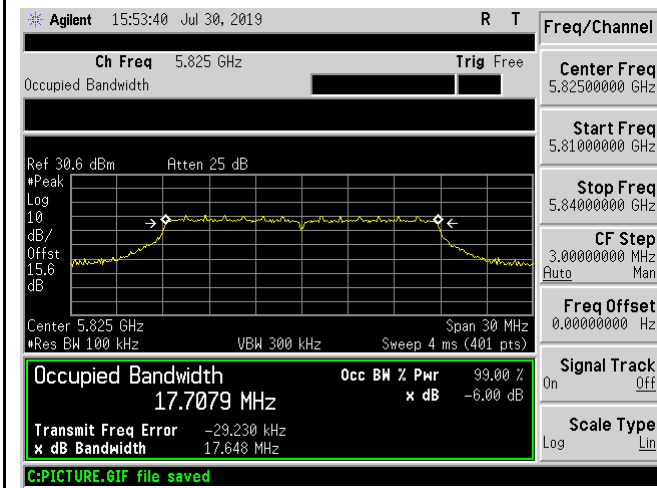



802.11n(40MHz) 6dB Bandwidth

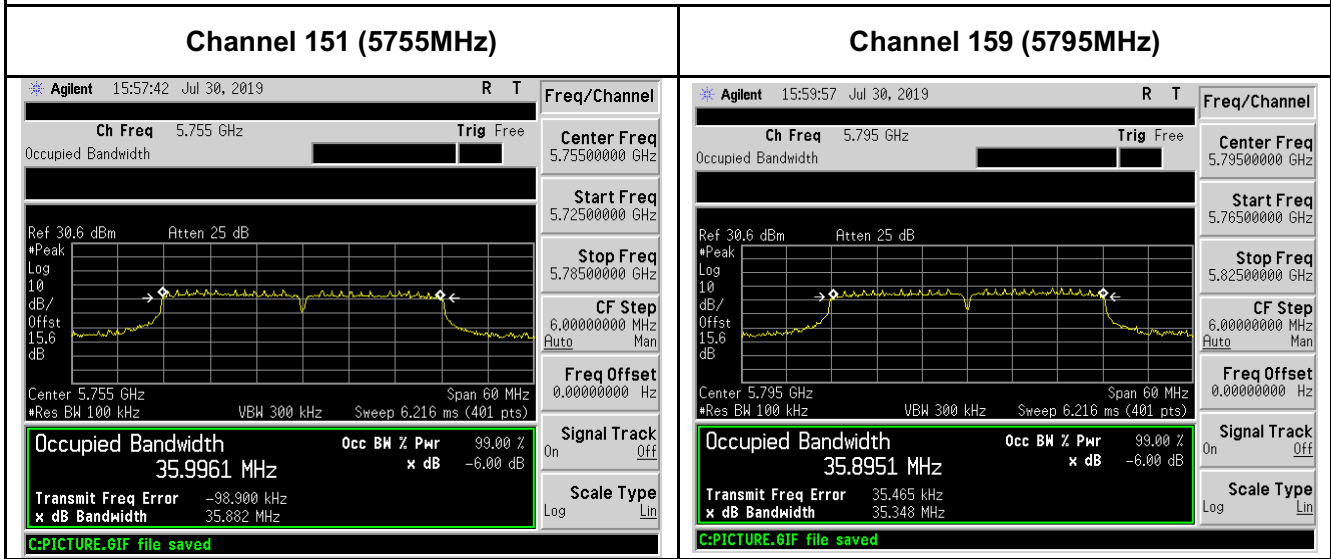



7. Power Output

7.1 Test Limit

According to §15.407(a) Power Limits:

- For an indoor access point operating in the band 5.15-5.25 GHz, the maximum conducted output power over the frequency band of operation shall not exceed 1 W (30dBm).. If transmitting antenna of directional gain greater than 6 dBi are used, the maximum conducted output power shall be reduced by the amount in dB that directional gain of the antenna exceeds 6 dBi.
- For the band 5.25-5.35 GHz and 5.47-5.725 GHz bands, the maximum conducted output power over the frequency bands of operation shall not exceed the lesser of 250 mW or $11 \text{ dBm} + 10 \log B$, where B is the 26 dB emission bandwidth in megahertz. If transmitting antenna of directional gain greater than 6 dBi are used, the maximum conducted output power shall be reduced by the amount in dB that directional gain of the antenna exceeds 6 dBi.
- For the band 5.725-5.825 GHz, the maximum conducted output power over the frequency band of operation shall not exceed the lesser of 1 W or $17 \text{ dBm} + 10 \log B$, where B is the 26 dB emission bandwidth in MHz. If transmitting antenna of directional gain greater than 6 dBi are used, the maximum conducted output power shall be reduced by the amount in dB that directional gain of the antenna exceeds 6 dBi. However, fixed point-to-point U-NII devices operating in this band may employ transmitting antenna with directional gain up to 23 dBi without any corresponding reduction in the transmitter peak output power. For fixed, point-to-point U-NII transmitters that employ a directional antenna gain greater than 23 dBi, a 1 dB reduction in peak transmitter power for each 1 dB of antenna gain in excess of 23 dBi would be required.

7.2 Test Standard

KDB 789033 D02v02r01 - Section E) 3) b) Method PM-G



7.3 Test Procedures

Measurements may be performed using a wideband gated RF power meter provided that the gate parameters are adjusted such that the power is measured only when the EUT is transmitting at its maximum power control level. Since the measurement is made only during the ON time of the transmitter, no duty cycle correction factor is required.

7.4 Test Setup

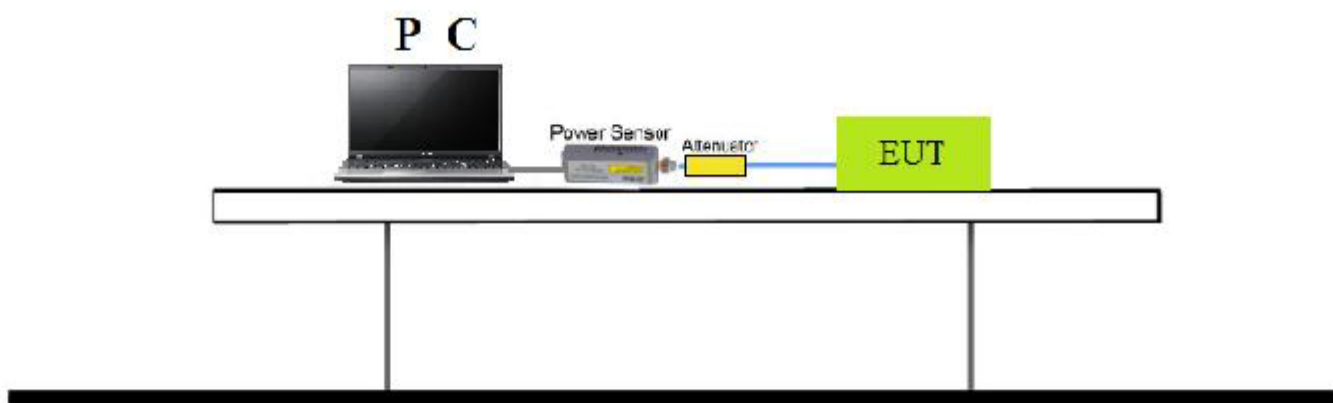



7.5 Test Result

7.5.1 Non-straddle Channel

Test Item	Power Measurement
Test Engineer:	Chris
Test Date	2019-07-31

Band 5150-5250MHz

Test Mode	Channel	Frequency (MHz)	RMS Power (dBm)	Limit (dBm)	Result
802.11a	Low	5180	18.138	24	Pass
	Middle	5200	17.827	24	Pass
	High	5240	18.422	24	Pass
802.11n(20MHz)	Low	5180	18.181	24	Pass
	Middle	5200	17.852	24	Pass
	High	5240	18.477	24	Pass
802.11n(40MHz)	Low	5190	18.285	24	Pass
	High	5230	18.407	24	Pass

Band 5250-5350MHz

Test Mode	Channel	Frequency (MHz)	RMS Power (dBm)	Limit (dBm)	Result
802.11a	Low	5260	18.358	24	Pass
	Middle	5280	17.849	24	Pass
	High	5320	17.491	24	Pass
802.11n(20MHz)	Low	5260	18.363	24	Pass
	Middle	5280	17.916	24	Pass
	High	5320	17.500	24	Pass
802.11n(40MHz)	Low	5270	18.264	24	Pass
	High	5310	17.787	24	Pass

**Band 5470-5725MHz**

Test Mode	Channel	Frequency (MHz)	RMS Power (dBm)	Limit (dBm)	Result
802.11a	Low	5500	15.489	24	Pass
	Middle	5600	16.802	24	Pass
	High	5700	14.147	24	Pass
802.11n(20MHz)	Low	5500	15.600	24	Pass
	Middle	5600	16.823	24	Pass
	High	5700	14.163	24	Pass
802.11n(40MHz)	Low	5510	15.435	24	Pass
	Middle	5590	17.042	24	Pass
	High	5670	14.503	24	Pass

Band 5725-5850MHz

Test Mode	Channel	Frequency (MHz)	RMS Power (dBm)	Limit (dBm)	Result
802.11a	Low	5745	12.232	30	Pass
	Middle	5785	12.627	30	Pass
	High	5825	14.146	30	Pass
802.11n(20MHz)	Low	5745	12.337	30	Pass
	Middle	5785	12.635	30	Pass
	High	5825	14.177	30	Pass
802.11n(40MHz)	Low	5755	12.210	30	Pass
	High	5795	13.288	30	Pass



7.5.2 Straddle Channel

Test Item	Power Measurement
Test Engineer:	Chris
Test Date	2019-08-02

Within 5470-5725MHz Band, Straddle Channel

Test Mode	Channel No.	Freq. (MHz)	Measured Power(dBm)	Duty Cycle (%)	Total Power (dBm)	Power Limit (dBm)	Result
802.11a	144	5720	11.77	86.69	12.39	24	Pass
802.11n(20MHz)	144	5720	11.78	86.29	12.42	24	Pass
802.11n(40MHz)	142	5710	12.58	73.91	1389	24	Pass

Note 1: When EUT duty cycle $\geq 98\%$, the Total Power (dBm/MHz) = Measured Power. When EUT duty cycle $< 98\%$, the Total Power (dBm/MHz) = Measured Power + $10 \cdot \log(1/\text{Duty Cycle})$.

Extends across 5725MHz Band, Straddle Channel

Test Mode	Channel No.	Freq. (MHz)	Measured Power(dBm)	Duty Cycle (%)	Total Power (dBm)	Power Limit (dBm)	Result
802.11a	144	5720	5.72	86.69	6.34	30	Pass
802.11n(20MHz)	144	5720	5.85	86.29	6.49	30	Pass
802.11n(40MHz)	142	5710	1.51	73.91	2.82	30	Pass

Note 1: When EUT duty cycle $\geq 98\%$, the Total Power (dBm/MHz) = Measured Power. When EUT duty cycle $< 98\%$, the Total Power (dBm/MHz) = Measured Power + $10 \cdot \log(1/\text{Duty Cycle})$.



802.11a

Channel 144 (5720MHz)

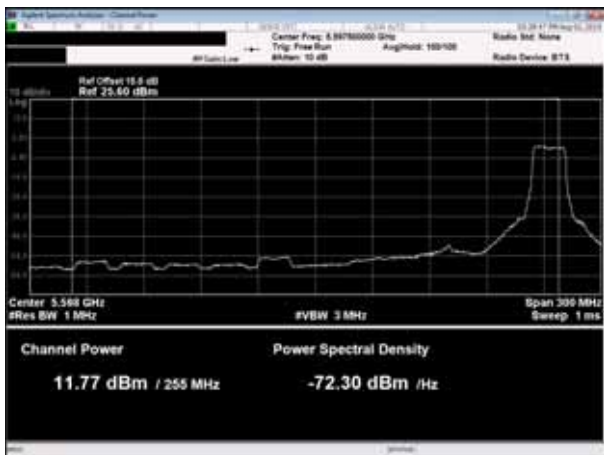

Channel 144 (5720MHz)

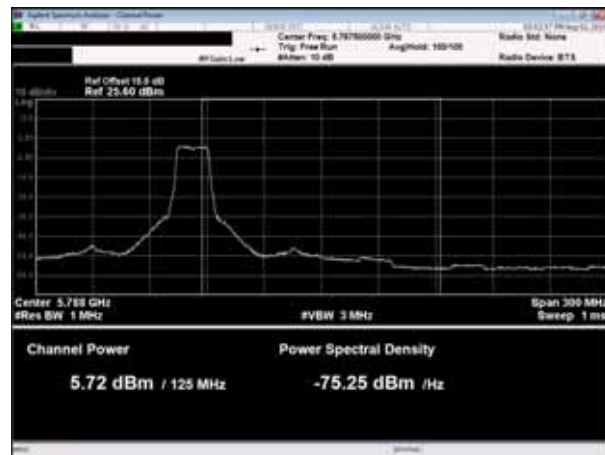



802.11n(20MHz)

Channel 144 (5720MHz)

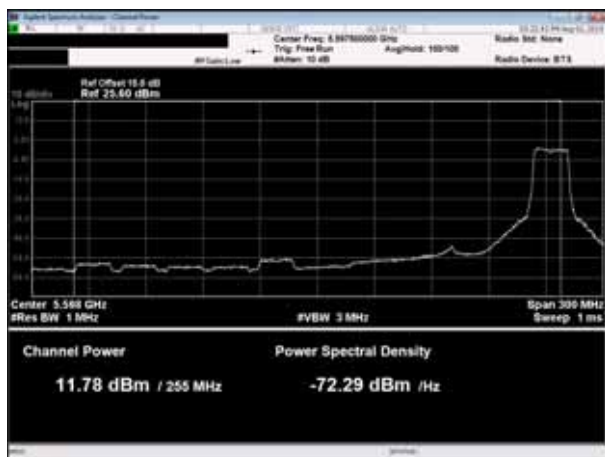

Channel 144 (5720MHz)

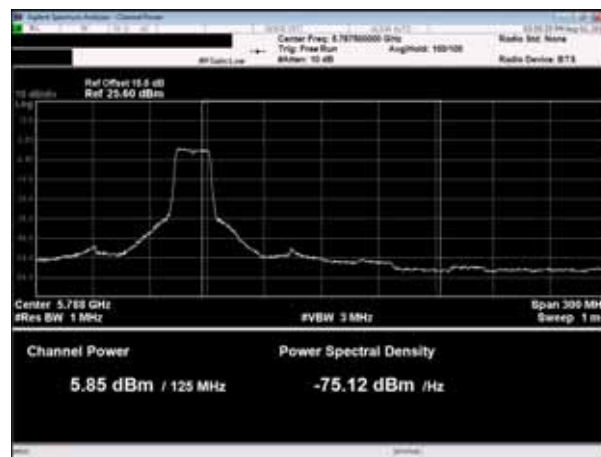



802.11n(40MHz)

Channel 142 (5710MHz)

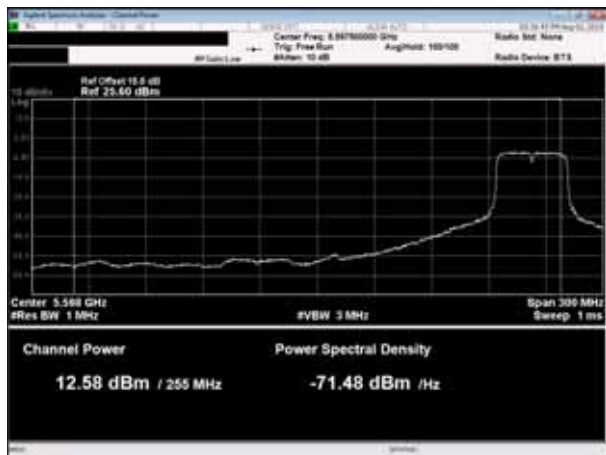

Channel 142 (5710MHz)

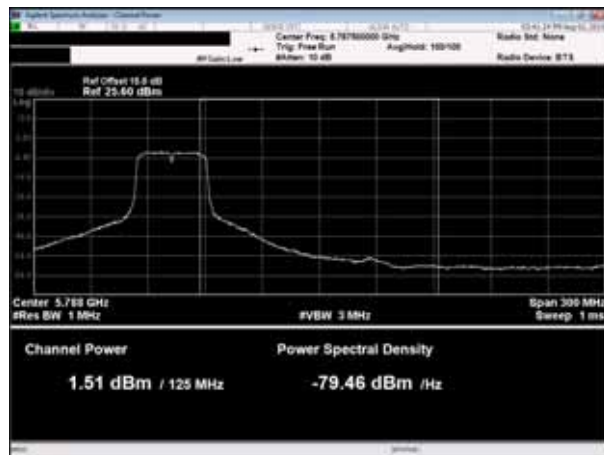



8. Power Spectral Density

8.1 Test Limit

According to FCC 47 CFR Section 15.407 a) PSD Limits:

For an indoor access point operating in the band 5.15-5.25 GHz, the maximum power spectral density shall not exceed 17 dBm in any 1 megahertz band.

For the 5.25-5.35 GHz and 5.47-5.725 GHz bands, the maximum power spectral density shall not exceed 11 dBm in any 1 megahertz band.

For the band 5.725-5.85 GHz, the maximum power spectral density shall not exceed 30 dBm in any 500-kHz band.

If transmitting antennas of directional gain greater than 6dBi are used, the peak power spectral density shall be reduced by the amount in dB that the directional gain of the antenna exceeds 6dBi.

8.2 Test Standard

KDB 789033 D02v02r01 - Section F



8.3 Test Procedures

1. Analyzer was set to the center frequency of the UNII channel under investigation
2. Span was set to encompass the entire 26dB EBW of the signal.
3. RBW = 1MHz, if measurement bandwidth of Maximum PSD is specified in 500 kHz, RBW = 100 kHz
4. VBW = 3MHz
5. Number of sweep points $\geq 2 \times (\text{span} / \text{RBW})$
6. Detector = power averaging (RMS)
7. Sweep time = auto
8. Trigger = free run
9. Use the peak search function on the instrument to find the peak of the spectrum and record its value.
10. Add $10 \cdot \log(1/x)$, where x is the duty cycle, to the measured power in order to compute the average power during the actual transmission times (because the measurement represents an average over both the on and off times of the transmission). For example, add $10 \cdot \log(1/0.25) = 6$ dB if the duty cycle is 25 percent.
11. When the measurement bandwidth of Maximum PSD is specified in 500 kHz, add a constant factor $10 \cdot \log(500\text{kHz}/100\text{kHz}) = 7$ dB to the measured result.

8.4 Test Setup

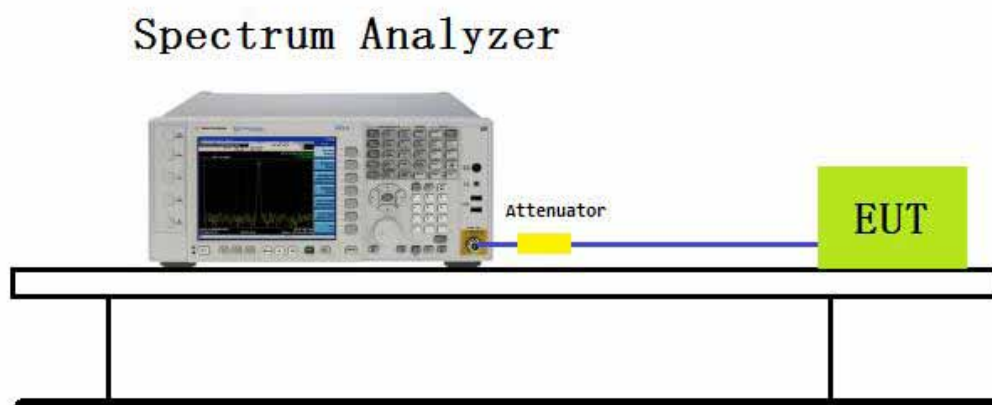



8.5 Test Result

8.5.1 Non-straddle Channel

Test Item	PSD Measurement
Test Engineer:	Chris
Test Date	2019-07-31

Test Mode	Data Rate (Mbps)	Channel No.	Freq. (MHz)	Measured PSD (dBm/MHz)	Duty Cycle (%)	Total PSD (dBm/MHz)	PSD Limit (dBm/MHz)	Result
802.11a	6	36	5180	3.617	86.69	4.237	≤ 11	Pass
		40	5200	3.196	86.69	3.816	≤ 11	Pass
		48	5240	4.214	86.69	4.834	≤ 11	Pass
802.11n(20MHz)	6.5	36	5180	3.402	86.29	4.042	≤ 11	Pass
		40	5200	3.098	86.29	3.738	≤ 11	Pass
		48	5240	3.786	86.29	4.426	≤ 11	Pass
802.11n(40MHz)	13.5	38	5190	0.741	73.91	2.054	≤ 11	Pass
		46	5230	0.903	73.91	2.216	≤ 11	Pass

Note 1: When EUT duty cycle $\geq 98\%$, the Total PSD (dBm/MHz) = Measured PSD. When EUT duty cycle $< 98\%$, the Total PSD (dBm/MHz) = Measured PSD + $10 \cdot \log(1/\text{Duty Cycle})$.

Test Mode	Data Rate (Mbps)	Channel No.	Freq. (MHz)	Measured PSD (dBm/MHz)	Duty Cycle (%)	Total PSD (dBm/MHz)	PSD Limit (dBm/MHz)	Result
802.11a	6	52	5260	4.198	86.69	4.818	≤ 11	Pass
		56	5280	3.688	86.69	4.308	≤ 11	Pass
		64	5320	3.662	86.69	4.282	≤ 11	Pass
802.11n(20MHz)	6.5	52	5260	3.940	86.29	4.580	≤ 11	Pass
		56	5280	3.490	86.29	4.130	≤ 11	Pass
		64	5320	3.234	86.29	3.874	≤ 11	Pass
802.11n(40MHz)	13.5	54	5270	1.012	73.91	2.325	≤ 11	Pass
		62	5310	1.003	73.91	2.316	≤ 11	Pass

Note 1: When EUT duty cycle $\geq 98\%$, the Total PSD (dBm/MHz) = Measured PSD. When EUT duty cycle $< 98\%$, the Total PSD (dBm/MHz) = Measured PSD + $10 \cdot \log(1/\text{Duty Cycle})$.



Test Mode	Data Rate (Mbps)	Channel No.	Freq. (MHz)	Measured PSD (dBm/MHz)	Duty Cycle (%)	Total PSD (dBm/MHz)	PSD Limit (dBm/MHz)	Result
802.11a	6	100	5500	1.849	86.69	2.469	≤ 11	Pass
		120	5600	3.423	86.69	4.043	≤ 11	Pass
		140	5700	1.121	86.69	1.741	≤ 11	Pass
802.11n(20MHz)	6.5	100	5500	1.276	86.29	1.916	≤ 11	Pass
		120	5600	3.184	86.29	3.824	≤ 11	Pass
		140	5700	0.732	86.29	1.372	≤ 11	Pass
802.11n(40MHz)	13.5	102	5510	-1.056	73.91	0.257	≤ 11	Pass
		118	5590	0.691	73.91	2.004	≤ 11	Pass
		134	5670	-1.543	73.91	-0.230	≤ 11	Pass

Note 1: When EUT duty cycle $\geq 98\%$, the Total PSD (dBm/MHz) = Measured PSD. When EUT duty cycle $< 98\%$, the Total PSD (dBm/MHz) = Measured PSD + $10 \cdot \log(1/\text{Duty Cycle})$.

Test Mode	Data Rate (Mbps)	Channel No.	Freq. (MHz)	Measured PSD (dBm/500kHz)	Duty Cycle (%)	Total PSD (dBm/500kHz)	Limit (dBm/500kHz)	Result
802.11a	6	149	5745	-2.858	86.69	-2.238	≤ 30	Pass
		157	5785	-3.162	86.69	-2.542	≤ 30	Pass
		165	5825	-1.238	86.69	-0.618	≤ 30	Pass
802.11n(20MHz)	6.5	149	5745	-3.172	86.29	-2.532	≤ 30	Pass
		157	5785	-3.154	86.29	-2.514	≤ 30	Pass
		165	5825	-1.578	86.29	-0.938	≤ 30	Pass
802.11n(40MHz)	13.5	151	5755	-5.921	73.91	-4.608	≤ 30	Pass
		159	5795	-5.206	73.91	-3.893	≤ 30	Pass

Note 1: When EUT duty cycle $\geq 98\%$, the Total PSD (dBm/500kHz) = Measured PSD. When EUT duty cycle $< 98\%$, the Total PSD (dBm/500kHz) = Measured PSD + $10 \cdot \log(1/\text{Duty Cycle})$.



802.11a Power Spectral Density

Channel 36 (5180MHz)

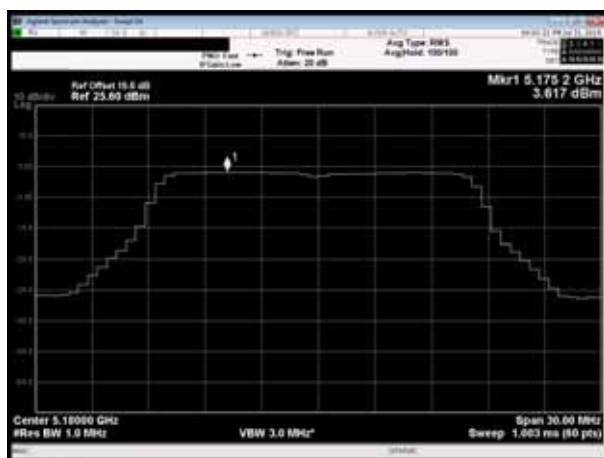

Channel 40 (5200MHz)

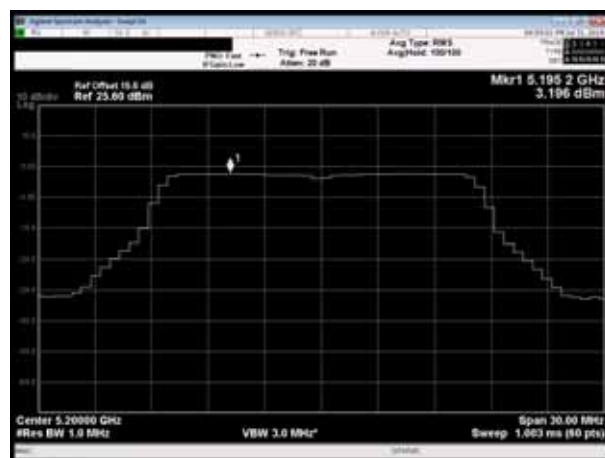

Channel 48 (5240MHz)

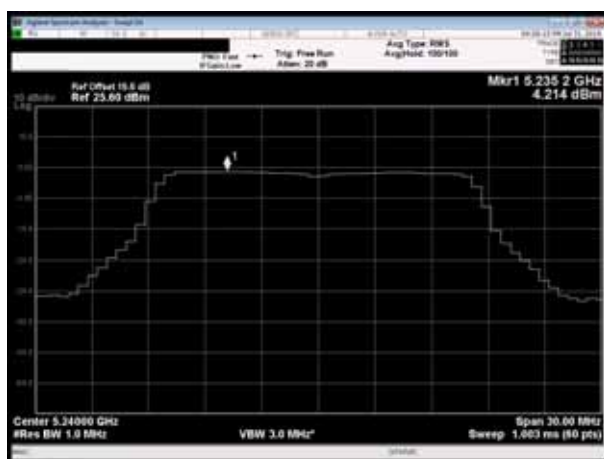

Channel 52 (5260MHz)

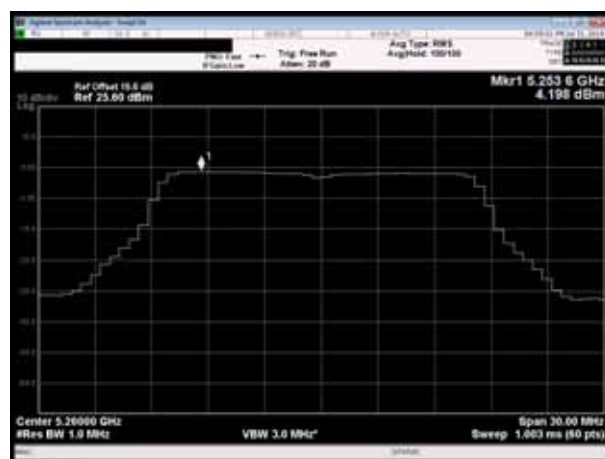

Channel 56 (5280MHz)

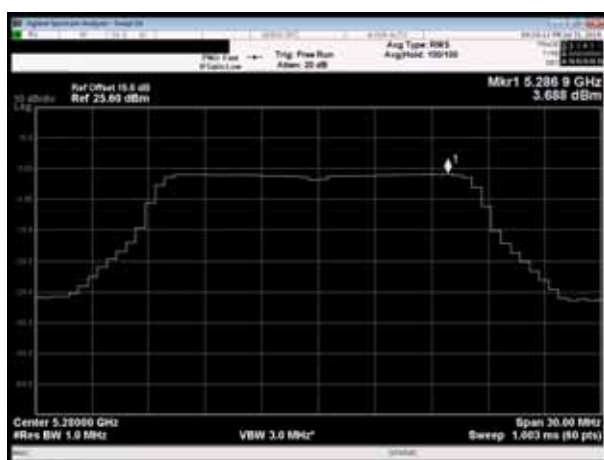

Channel 64 (5320MHz)

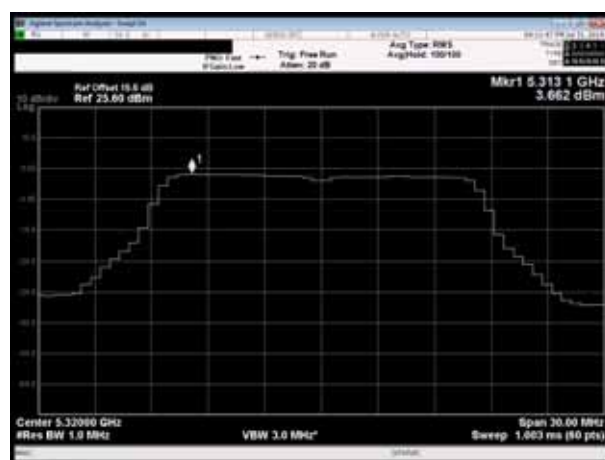

Channel 100 (5500MHz)

Channel 120 (5600MHz)

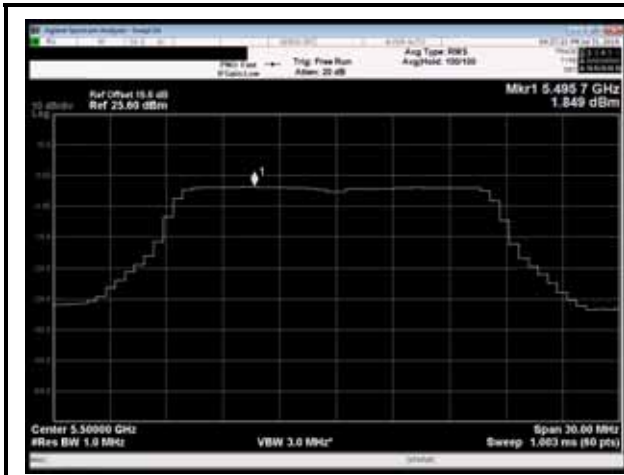

Channel 140 (5700MHz)

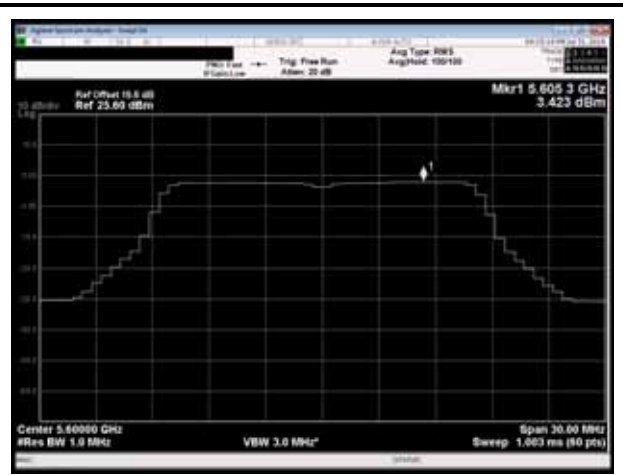

Channel 149 (5745MHz)

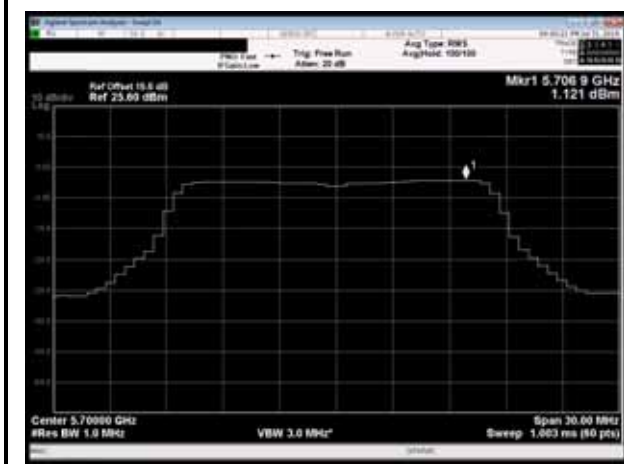

Channel 157 (5785MHz)

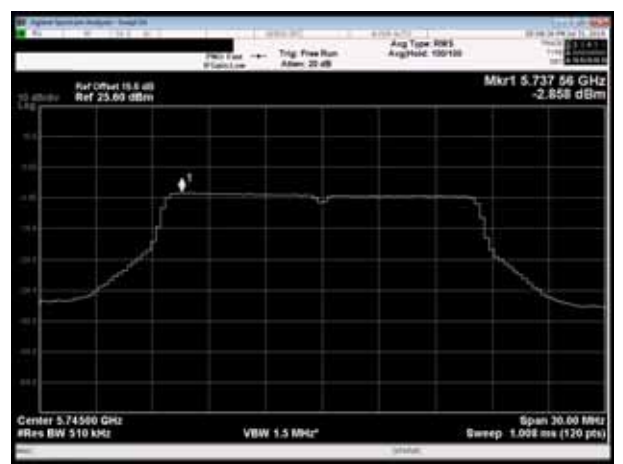

Channel 165 (5825MHz)

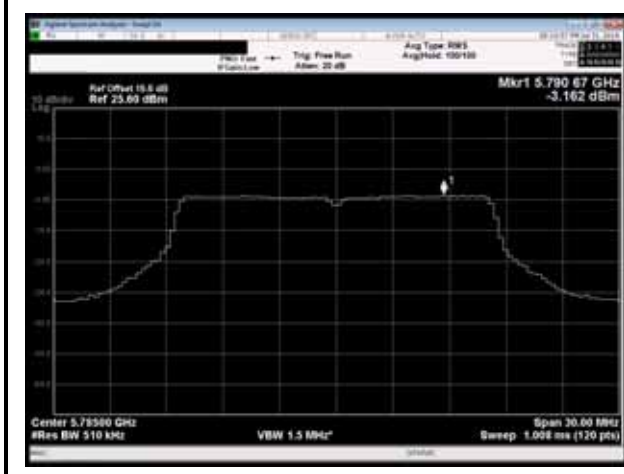

Channel 157 (5785MHz)

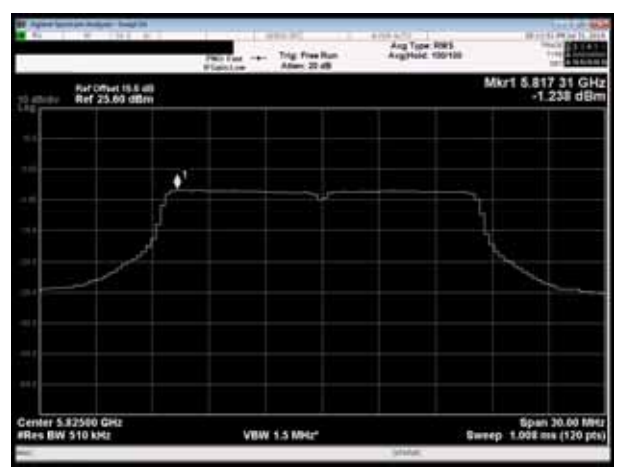

Channel 165 (5825MHz)



802.11n(20MHz) Power Spectral Density

Channel 36 (5180MHz)

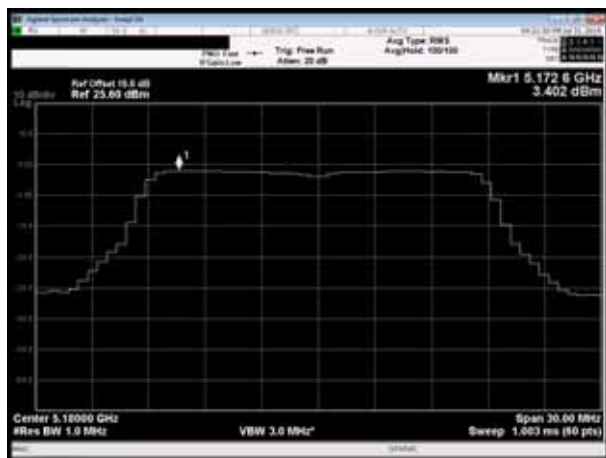

Channel 40 (5200MHz)

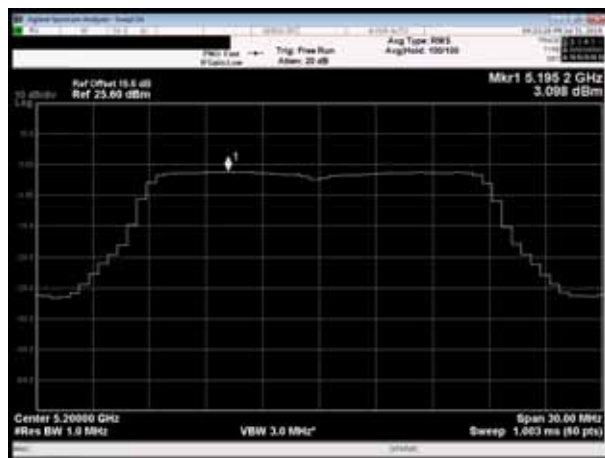

Channel 48 (5240MHz)

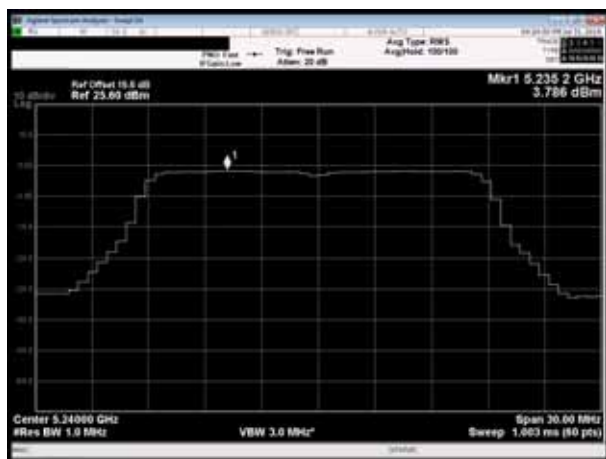

Channel 52 (5260MHz)

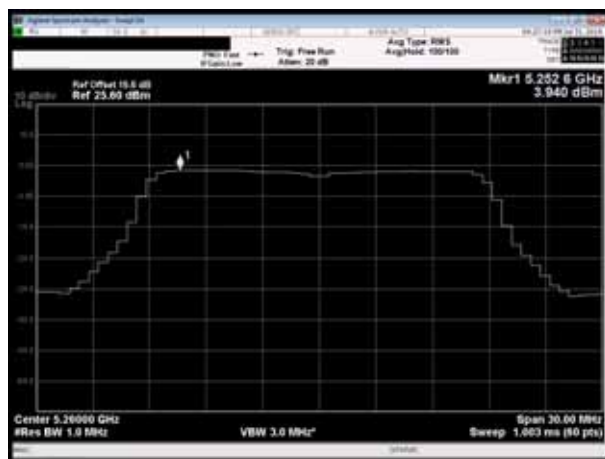

Channel 56 (5280MHz)

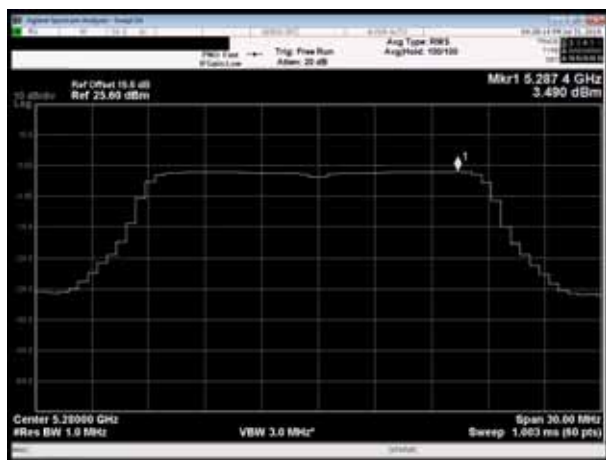

Channel 64 (5320MHz)

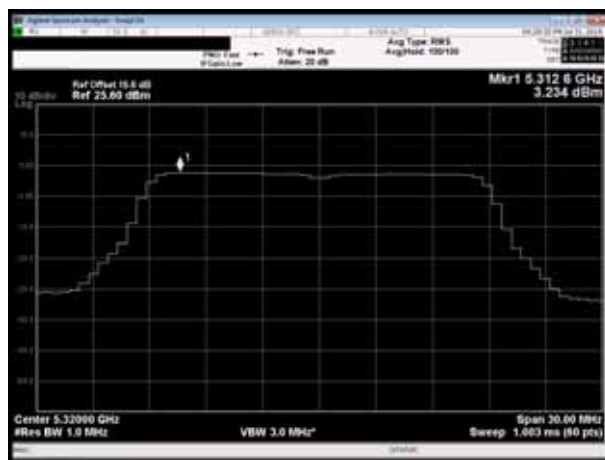

Channel 100 (5500MHz)

Channel 120 (5600MHz)

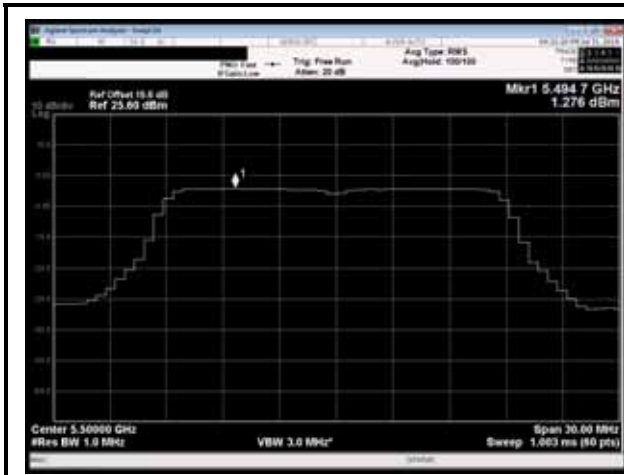

Channel 140 (5700MHz)

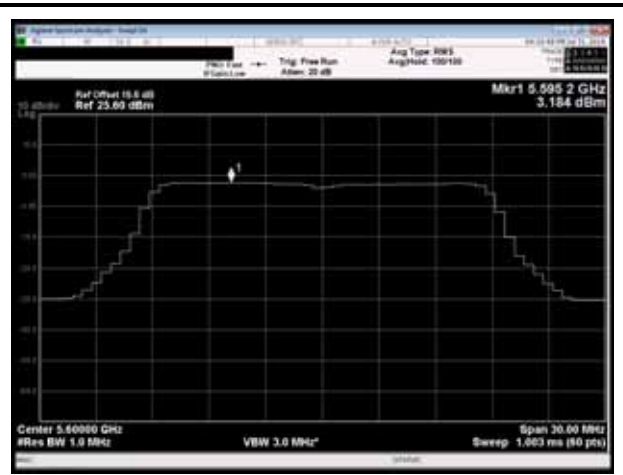

Channel 149 (5745MHz)

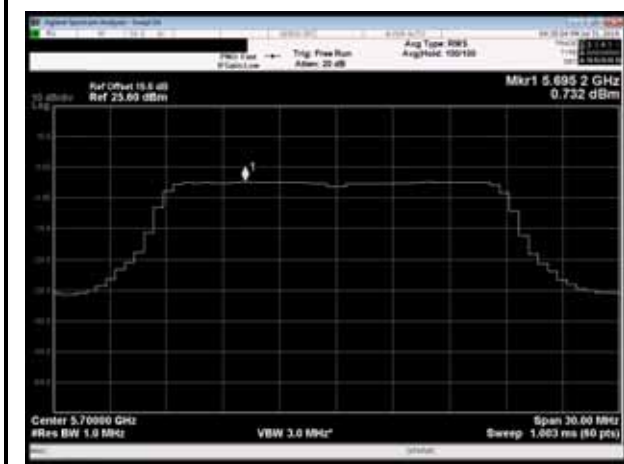

Channel 157 (5785MHz)

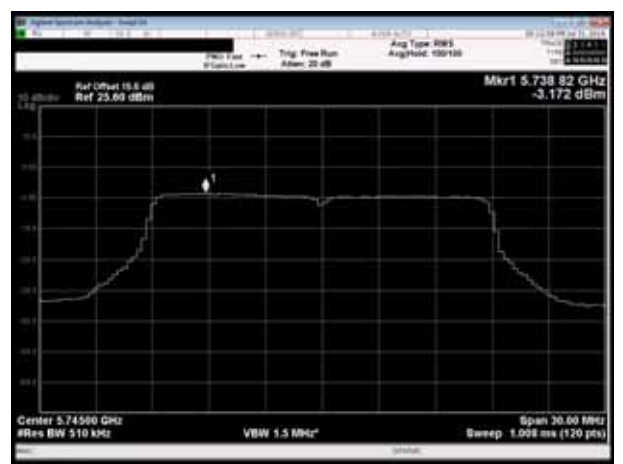

Channel 165 (5825MHz)

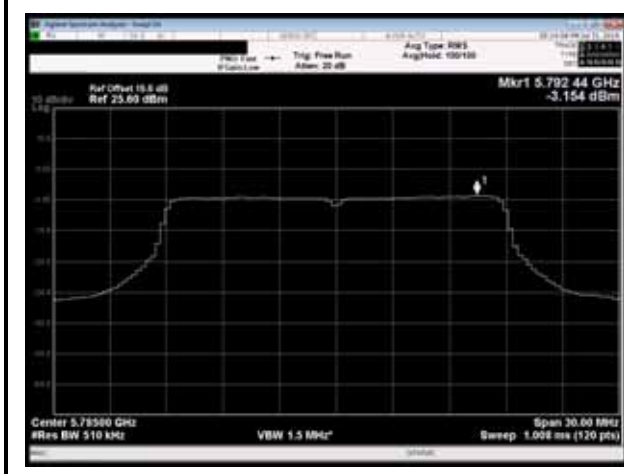

Channel 157 (5785MHz)

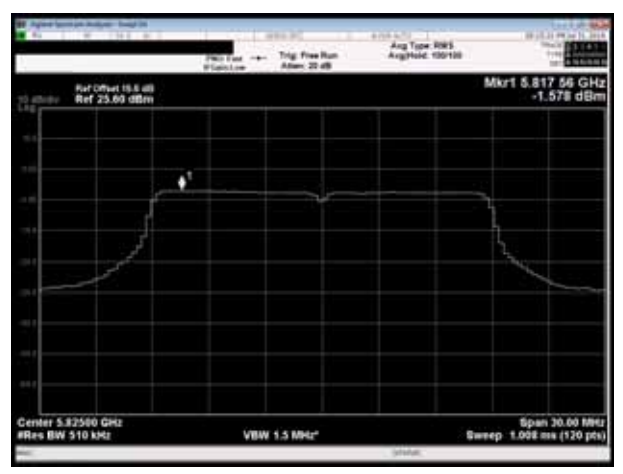

Channel 165 (5825MHz)



802.11n(40MHz) Power Spectral Density

Channel 38 (5190MHz)

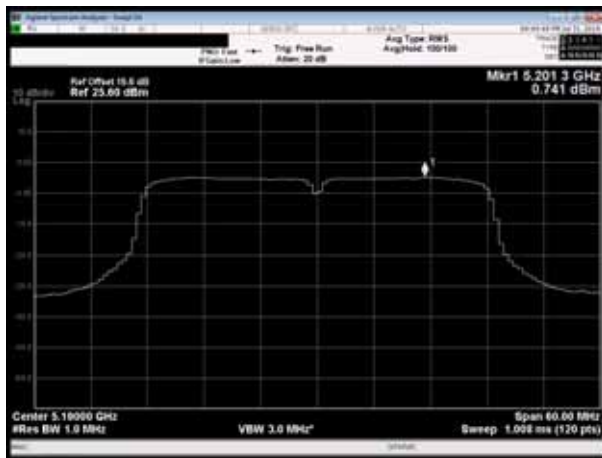

Channel 46 (5230MHz)

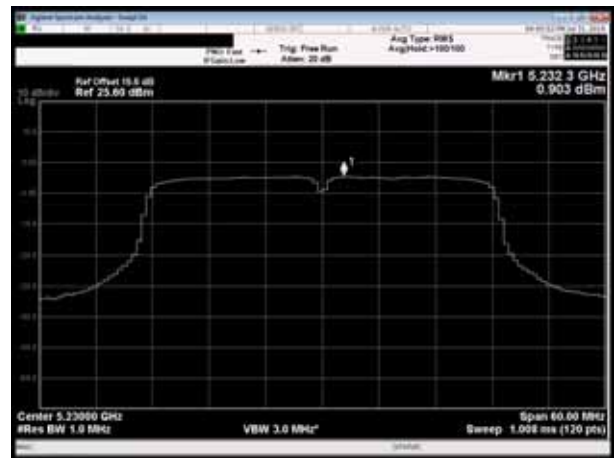

Channel 54 (5270MHz)

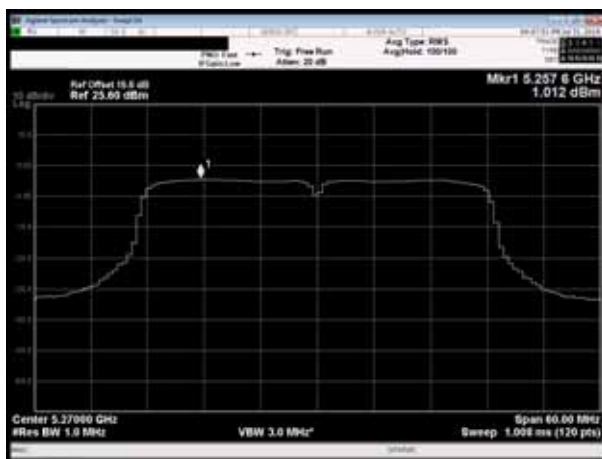

Channel 62 (5310MHz)

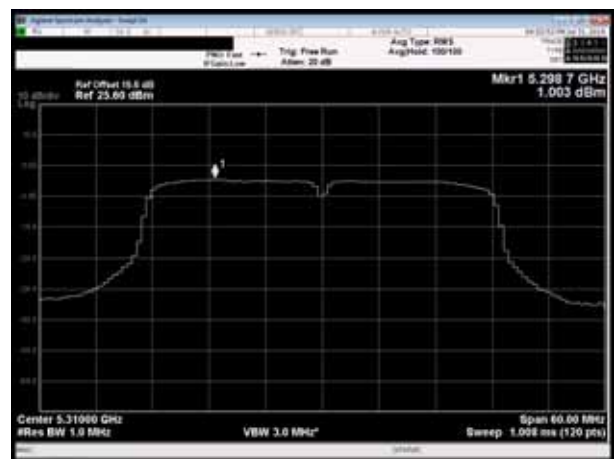

Channel 102 (5510MHz)

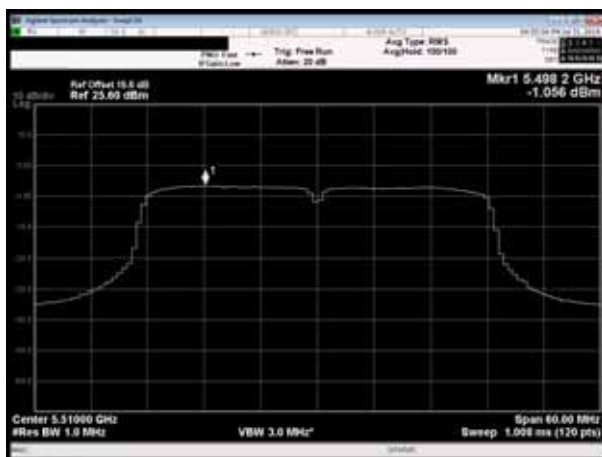

Channel 118 (5590MHz)

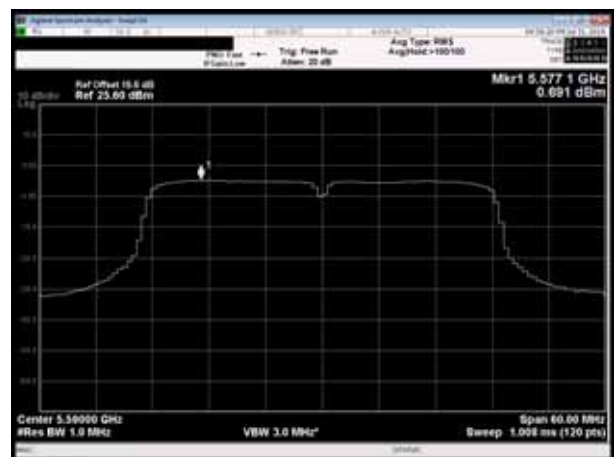

Channel 134 (5670MHz)

Channel 151 (5755MHz)



<p>Channel 159 (5795MHz)</p>	<p>N/A</p>
	<p>N/A</p>



8.5.2 Straddle Channel

Test Item	PSD Measurement
Test Engineer:	Chris
Test Date	2019-08-05

Within 5470-5725MHz Band, Straddle Channel

Test Mode	Data Rate (Mbps)	Channel No.	Freq. (MHz)	Measured PSD (dBm/MHz)	Duty Cycle (%)	Total PSD (dBm/MHz)	PSD Limit (dBm/MHz)	Result
802.11a	6	144	5720	-1.226	86.69	-0.606	≤ 11	Pass
802.11n(20MHz)	6.5	144	5720	-1.312	86.29	-0.672	≤ 11	Pass
802.11n(40MHz)	13.5	142	5710	-4.150	73.91	-2.837	≤ 11	Pass

Note 1: When EUT duty cycle $\geq 98\%$, the Total PSD (dBm/MHz) = Measured PSD. When EUT duty cycle $< 98\%$, the Total PSD (dBm/MHz) = Measured PSD + $10 \cdot \log(1/\text{Duty Cycle})$.

Extends across 5725MHz Band, Straddle Channel

Test Mode	Data Rate (Mbps)	Channel No.	Freq. (MHz)	Measured PSD (dBm/500kHz)	Duty Cycle (%)	Total PSD (dBm/500kHz)	Limit (dBm/500kHz)	Result
802.11a	6	144	5720	-4.129	86.69	-3.509	≤ 30	Pass
802.11n(20MHz)	6.5	144	5720	-4.314	86.29	-3.674	≤ 30	Pass
802.11n(40MHz)	13.5	142	5710	-7.250	73.91	-5.937	≤ 30	Pass

Note 1: When EUT duty cycle $\geq 98\%$, the Total PSD (dBm/500kHz) = Measured PSD. When EUT duty cycle $< 98\%$, the Total PSD (dBm/500kHz) = Measured PSD + $10 \cdot \log(1/\text{Duty Cycle})$.



802.11a

Channel 144 (5720MHz)

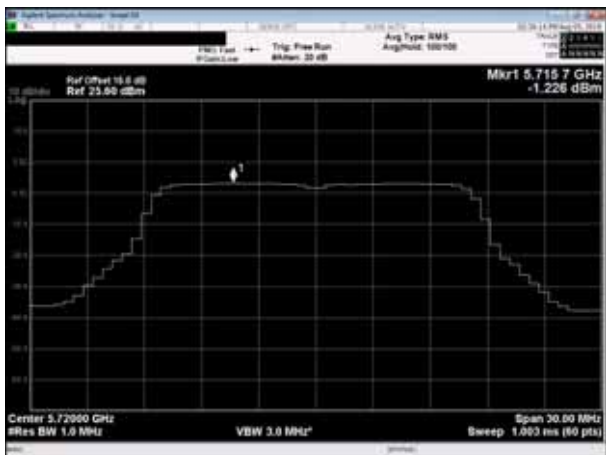

Channel 144 (5720MHz)

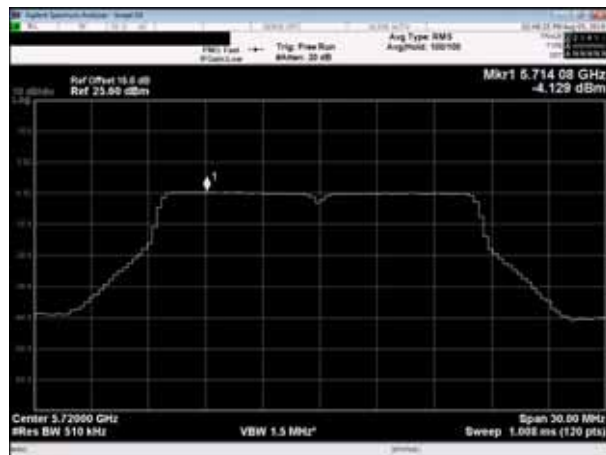



802.11n(20MHz)

Channel 144 (5720MHz)

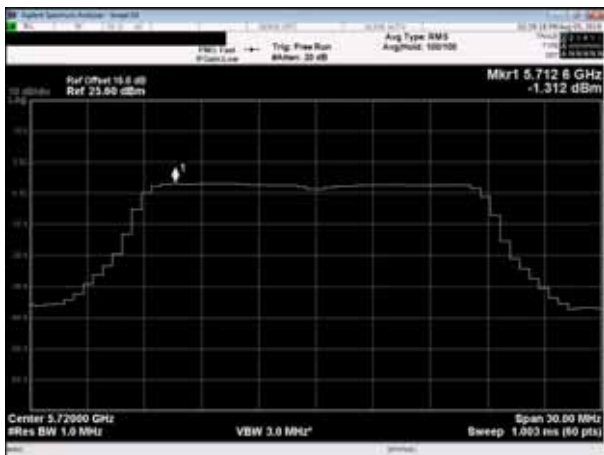

Channel 144 (5720MHz)

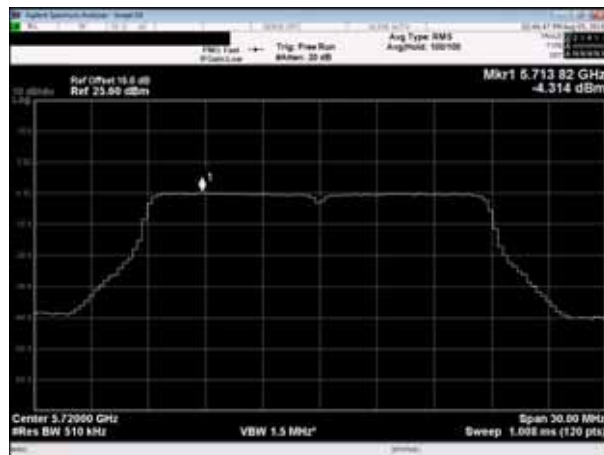



802.11n(40MHz)

Channel 142 (5710MHz)

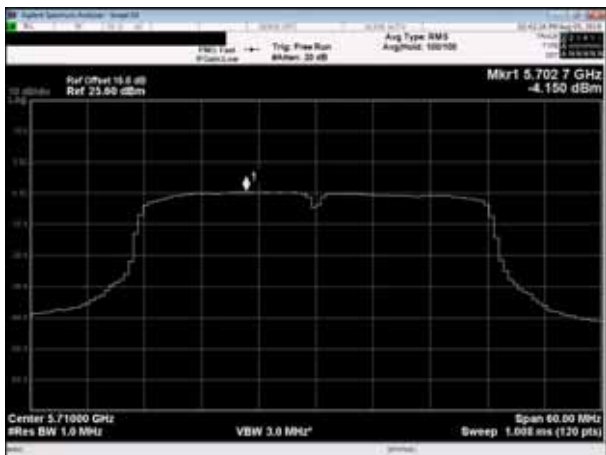

Channel 142 (5710MHz)

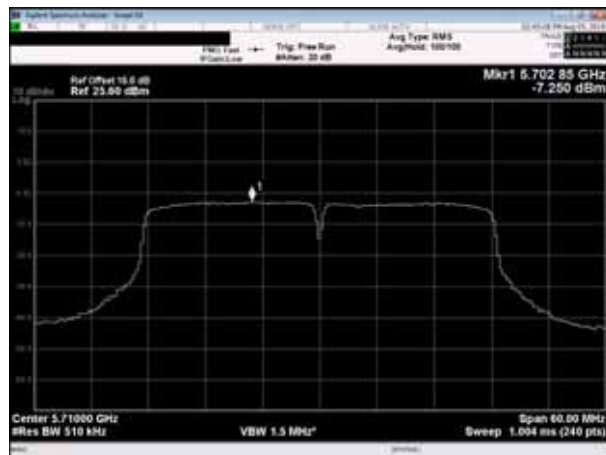



9. Band Edges Measurement

9.1 Test Limit

For 15.205 requirement:

Radiated emissions which fall in the restricted bands, as defined in Section 15.205(a) of FCC part 15, must also comply with the radiated emission limits specified in Section 15.209(a).

MHz	MHz	MHz	GHz
0.090 - 0.110	16.42 - 16.423	399.9 - 410	4.5 - 5.15
¹ 0.495 - 0.505	16.69475 - 16.69525	608 - 614	5.35 - 5.46
2.1735 - 2.1905	16.80425 - 16.80475	960 - 1240	7.25 - 7.75
4.125 - 4.128	25.5 - 25.67	1300 - 1427	8.025 - 8.5
4.17725 - 4.17775	37.5 - 38.25	1435 - 1626.5	9.0 - 9.2
4.20725 - 4.20775	73 - 74.6	1645.5 - 1646.5	9.3 - 9.5
6.215 - 6.218	74.8 - 75.2	1660 - 1710	10.6 - 12.7
6.26775 - 6.26825	108 - 121.94	1718.8 - 1722.2	13.25 - 13.4
6.31175 - 6.31225	123 - 138	2200 - 2300	14.47 - 14.5
8.291 - 8.294	149.9 - 150.05	2310 - 2390	15.35 - 16.2
8.362 - 8.366	156.52475 - 156.52525	2483.5 - 2500	17.7 - 21.4
8.37625 - 8.38675	156.7 - 156.9	2690 - 2900	22.01 - 23.12
8.41425 - 8.41475	162.0125 - 167.17	3260 - 3267	23.6 - 24.0
12.29 - 12.293	167.72 - 173.2	3332 - 3339	31.2 - 31.8
12.51975 - 12.52025	240 - 285	3345.8 - 3358	36.43 - 36.5
12.57675 - 12.57725	322 - 335.4	3600 - 4400	(²)

**For 15.407(b) requirement:**

For transmitters operating in the 5.15-5.25 GHz band: all emissions outside of the 5.15-5.35 GHz band shall not exceed an EIRP of -27 dBm/MHz.

Operating Frequency Band (MHz)	EIRP Limit (dBm/MHz)	Equivalent Field Strength at 3m (dBuV/m)
5150 - 5350	-27	68.2
5470 - 5725	-27	68.2

For transmitters operating in the 5.725-5.85 GHz band:

All emissions shall be limited to a level of -27 dBm/MHz at 75 MHz or more above or below the band edge increasing linearly to 10 dBm/MHz at 25 MHz above or below the band edge, and from 25 MHz above or below the band edge increasing linearly to a level of 15.6 dBm/MHz at 5 MHz above or below the band edge, and from 5 MHz above or below the band edge increasing linearly to a level of 27 dBm/MHz at the band edge.

Note:

1. Refer to KDB 789033 D02v02r01 G)2)c), as specified in § 15.407(b)(1)-(3) specifies that emissions outside of the respective U-NII bands are subject to a maximum emission limit of -27 dBm/MHz. § 15.407(b)(4) provides two requirement options for devices that operate in the 5.725 – 5.85 GHz band. If the option specified in § 15.407(b)(4)(ii) is exercised, then the procedures specified in Clause 11.11 of ANSI C63.10-2013 and/or in Section 11.0 of KDB Publication 558074 shall be utilized. In general, an out-of-band emission that complies with both the peak and average power limits of § 15.209 is not required to also satisfy the -27 dBm/MHz or -17 dBm/MHz maximum emission limit.
2. All out of band emissions appearing in a restricted band as specified in Section 15.205 of the Title 47 CFR must not exceed the limits shown in Table per Section 15.209.

FCC Part 15 Subpart C Paragraph 15.209		
Frequency [MHz]	Field Strength [V/m]	Measured Distance [Meters]
0.009 – 0.490	2400/F (kHz)	300
0.490 – 1.705	24000/F (kHz)	30
1.705 - 30	30	30
30 - 88	100	3
88 - 216	200	3
216 - 960	200	3
Above 960	500	3



9.2 Test Standard

KDB 789033 D02v02r01 G)2)c)

9.3 Test Procedures

Peak Field Strength Measurements:

Analyzer center frequency was set to the frequency of the radiated spurious emission of interest

1. RBW = 1MHz
2. VBW = 3MHz
3. Detector = peak
4. Sweep time = auto couple
5. Trace mode = max hold
6. Trace was allowed to stabilize

AVE Field Strength Measurements:

(i) RBW = 1 MHz.

(ii) Video bandwidth.

■ If the EUT is configured to transmit with duty cycle $\geq 98\%$, set $VBW \leq RBW/100$ (i.e., 10 kHz) but not less than 10 Hz.

■ If the EUT duty cycle is $< 98\%$, set $VBW \geq 1/T$, where T is defined in section II.B.1.a).

(iii) Video bandwidth mode or display mode

■ The instrument shall be set to ensure that video filtering is applied in the power domain. Typically, this requires setting the detector mode to rms and setting the Average-VBW Type to power averaging (rms).

■ As an alternative, the analyzer may be set to linear detector mode. Ensure that video filtering is applied in linear voltage domain (rather than in a log or dB domain). Some analyzers require linear display mode in order to accomplish this. Others have a setting for Average-VBW Type, which can be set to "Voltage" regardless of the display mode.

(iv) Detector = Peak.

(v) Sweep time = auto.

(vi) Trace mode = max hold.

(vii) Allow max hold to run for at least 50 traces if the transmitted signal is continuous or has at least 98% duty cycle. For lower duty cycles, increase the minimum number of traces by a factor of $1/x$, where x is the duty cycle. For example, use at least 200 traces if the duty cycle is 25%. (If a specific emission is demonstrated to be continuous—i.e., 100% duty cycle—rather than turning on and off with the transmit cycle, at least 50 traces shall be averaged.)



9.4 Test Setup

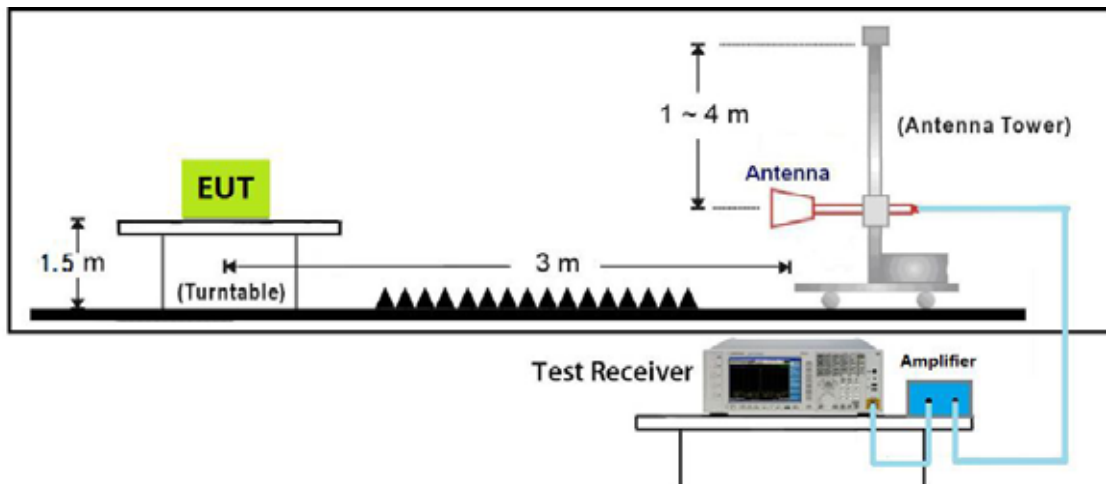



9.5 Test Result

9.5.1 Non-straddle Channel

9.5.1.1 Restricted-Band Bandedge

Engineer: Chris	
Site: AC102	Time: 2019/08/03 - 19:35
Limit: FCC_Part15.209_RE(3m)	Margin: 0
Probe: N/A	Polarity: Horizontal
EUT: Tablet	Power: AC 120V/60Hz
Note: 802.11a 5180MHz	

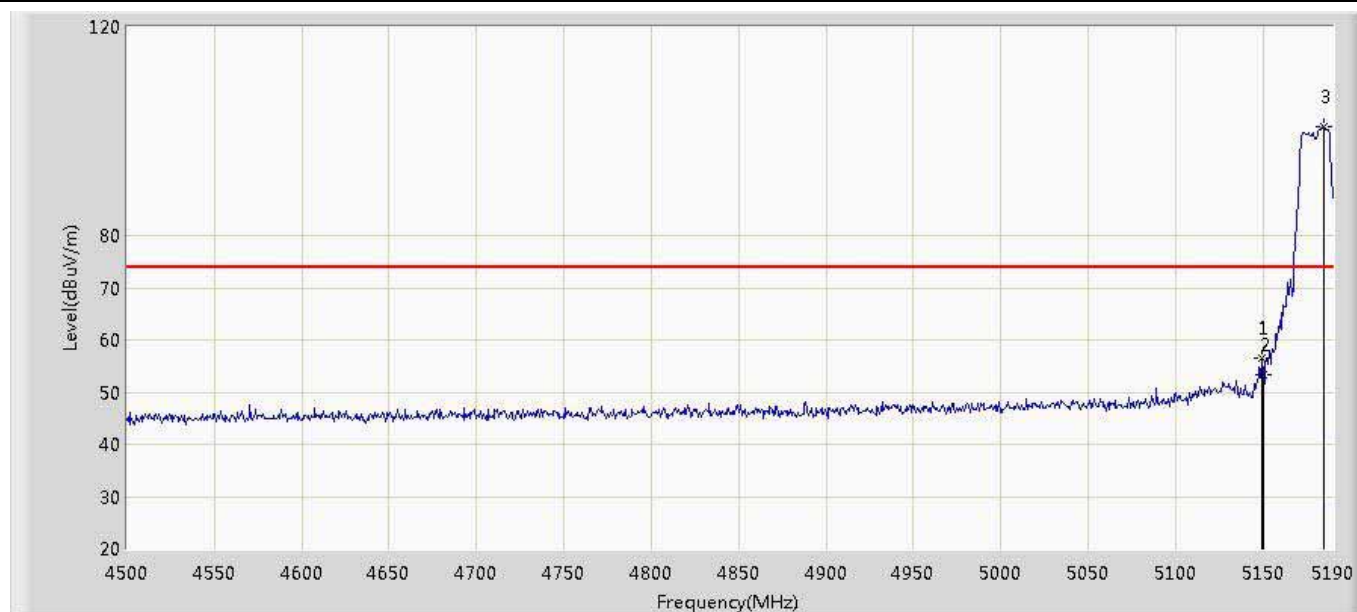

No	Mark	Frequency (MHz)	Measure Level (dBuV/m)	Reading Level (dBuV)	Over Limit (dB)	Limit (dBuV/m)	Factor (dB)	Type
1		5149.290	56.427	51.617	-17.573	74.000	4.810	PK
2		5150.000	53.198	48.385	-20.802	74.000	4.813	PK
3	*	5184.480	100.864	95.919	N/A	N/A	4.945	PK

Note:

1. All Readings below 1GHz are Quasi-Peak, above are performed with peak and/or average measurements as necessary.
2. " * ", means this data is the worst emission level.
3. Measurement Level = Reading Level + Factor(Probe+Cable-Amp).



Engineer: Chris	
Site: AC102	Time: 2019/08/03 - 19:41
Limit: FCC_Part15.209_RE(3m)	Margin: 0
Probe: N/A	Polarity: Horizontal
EUT: Tablet	Power: AC 120V/60Hz
Note: 802.11a 5180MHz	

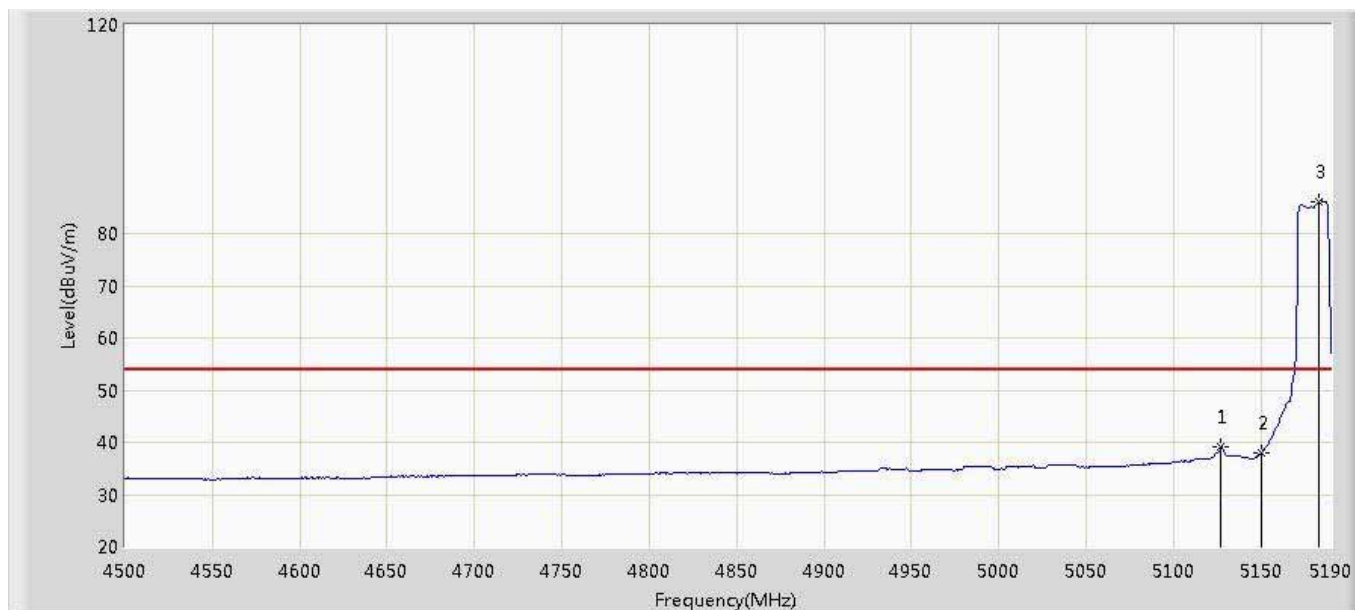

No	Mark	Frequency (MHz)	Measure Level (dBuV/m)	Reading Level (dBuV)	Over Limit (dB)	Limit (dBuV/m)	Factor (dB)	Type
1		5127.210	39.095	34.369	-14.905	54.000	4.726	AV
2		5150.000	38.054	33.241	-15.946	54.000	4.813	AV
3	*	5183.100	86.202	81.262	N/A	N/A	4.940	AV

Note:

1. All Readings below 1GHz are Quasi-Peak, above are performed with peak and/or average measurements as necessary.
2. " * ", means this data is the worst emission level.
3. Measurement Level = Reading Level + Factor(Probe+Cable-Amp).



Engineer: Chris	
Site: AC102	Time: 2019/08/03 - 19:43
Limit: FCC_Part15.209_RE(3m)	Margin: 0
Probe: N/A	Polarity: Vertical
EUT: Tablet	Power: AC 120V/60Hz
Note: 802.11a 5180MHz	

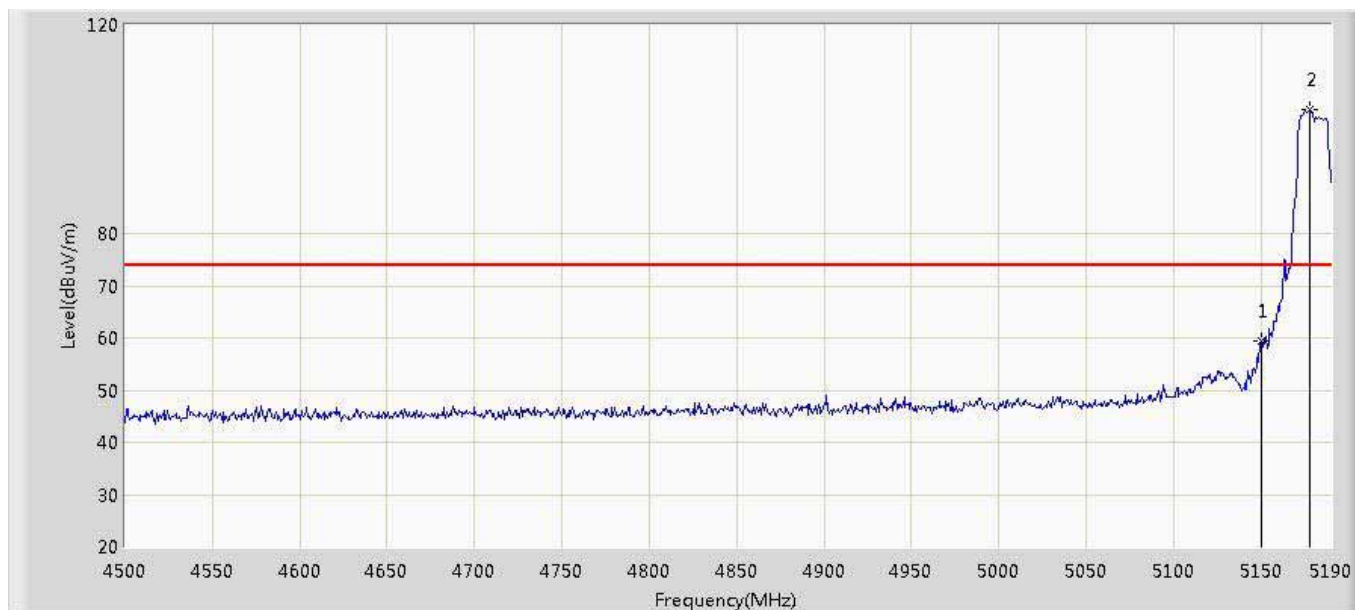

N o	Mar k	Frequency (MHz)	Measure Level (dBuV/m)	Reading Level (dBuV)	Over Limit (dB)	Limit (dBuV/m)	Factor (dB)	Type
1		5150.000	59.510	54.697	-14.490	74.000	4.813	PK
2	*	5177.580	103.778	98.860	N/A	N/A	4.918	PK

Note:

1. All Readings below 1GHz are Quasi-Peak, above are performed with peak and/or average measurements as necessary.
2. " * ", means this data is the worst emission level.
3. Measurement Level = Reading Level + Factor(Probe+Cable-Amp).



Engineer: Chris	
Site: AC102	Time: 2019/08/03 - 19:50
Limit: FCC_Part15.209_RE(3m)	Margin: 0
Probe: N/A	Polarity: Vertical
EUT: Tablet	Power: AC 120V/60Hz
Note: 802.11a 5180MHz	

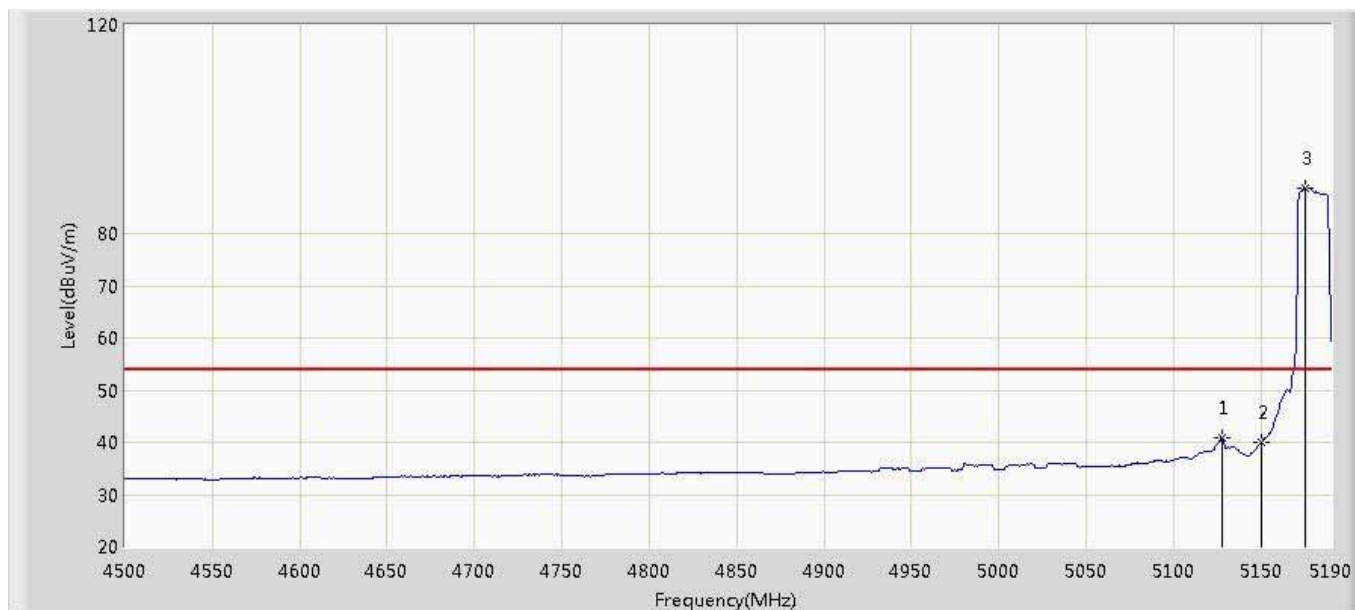

No	Mark	Frequency (MHz)	Measure Level (dBuV/m)	Reading Level (dBuV)	Over Limit (dB)	Limit (dBuV/m)	Factor (dB)	Type
1		5127.900	40.978	36.249	-13.022	54.000	4.729	AV
2		5150.000	40.085	35.272	-13.915	54.000	4.813	AV
3	*	5175.510	88.826	83.916	N/A	N/A	4.910	AV

Note:

1. All Readings below 1GHz are Quasi-Peak, above are performed with peak and/or average measurements as necessary.
2. " * ", means this data is the worst emission level.
3. Measurement Level = Reading Level + Factor(Probe+Cable-Amp).



Engineer: Chris	
Site: AC102	Time: 2019/08/03 - 19:53
Limit: FCC_Part15.209_RE(3m)	Margin: 0
Probe: N/A	Polarity: Horizontal
EUT: Tablet	Power: AC 120V/60Hz
Note: 802.11a 5320MHz	

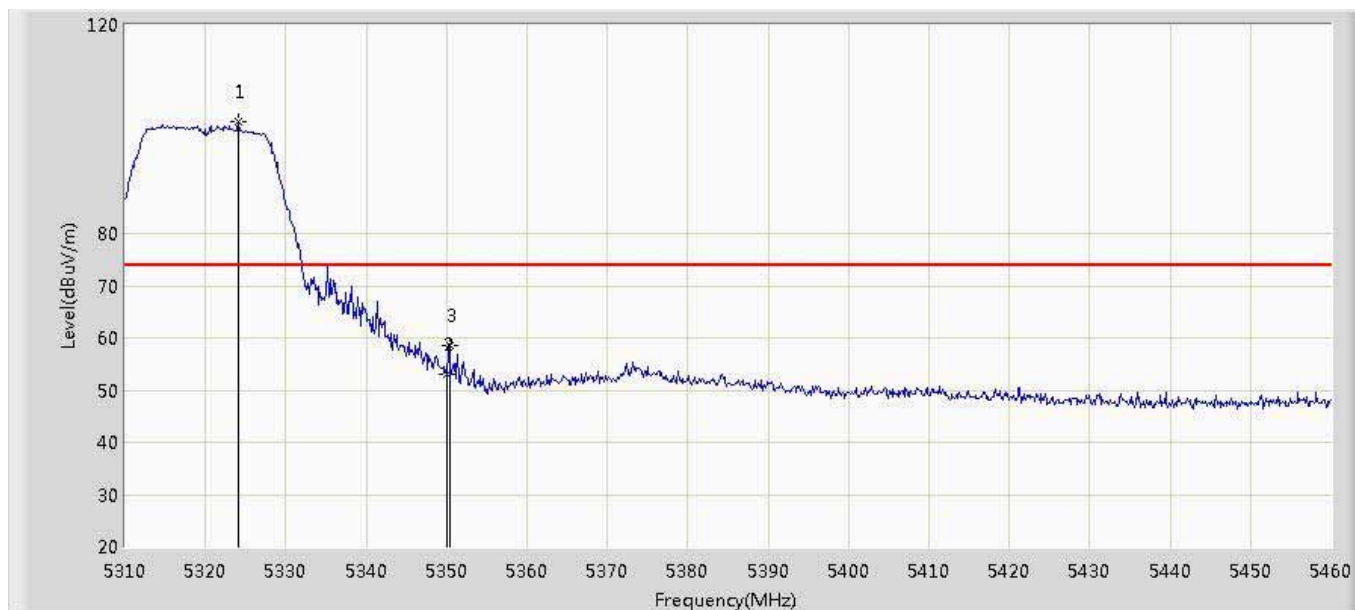

No	Mark	Frequency (MHz)	Measure Level (dBuV/m)	Reading Level (dBuV)	Over Limit (dB)	Limit (dBuV/m)	Factor (dB)	Type
1	*	5324.100	101.451	95.973	N/A	N/A	5.478	PK
2		5350.000	52.931	47.354	-21.069	74.000	5.577	PK
3		5350.350	58.409	52.831	-15.591	74.000	5.578	PK

Note:

1. All Readings below 1GHz are Quasi-Peak, above are performed with peak and/or average measurements as necessary.
2. " * ", means this data is the worst emission level.
3. Measurement Level = Reading Level + Factor(Probe+Cable-Amp).



Engineer: Chris	
Site: AC102	Time: 2019/08/03 - 19:56
Limit: FCC_Part15.209_RE(3m)	Margin: 0
Probe: N/A	Polarity: Horizontal
EUT: Tablet	Power: AC 120V/60Hz
Note: 802.11a 5320MHz	

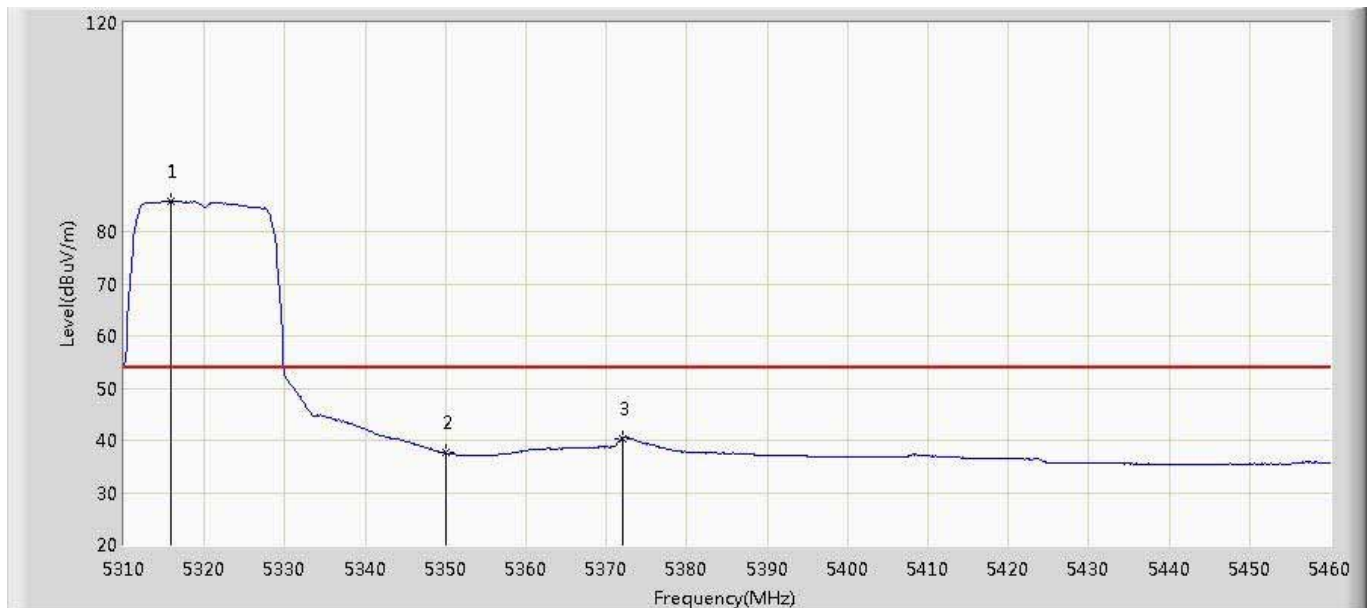

N o	Mar k	Frequency (MHz)	Measure Level (dBuV/m)	Reading Level (dBuV)	Over Limit (dB)	Limit (dBuV/m)	Factor (dB)	Type
1	*	5315.850	85.815	80.368	N/A	N/A	5.447	AV
2		5350.000	37.594	32.017	-16.406	54.000	5.577	AV
3		5371.950	40.407	34.746	-13.593	54.000	5.661	AV

Note:

1. All Readings below 1GHz are Quasi-Peak, above are performed with peak and/or average measurements as necessary.
2. " * ", means this data is the worst emission level.
3. Measurement Level = Reading Level + Factor(Probe+Cable-Amp).



Engineer: Chris	
Site: AC102	Time: 2019/08/03 - 19:57
Limit: FCC_Part15.209_RE(3m)	Margin: 0
Probe: N/A	Polarity: Vertical
EUT: Tablet	Power: AC 120V/60Hz
Note: 802.11a 5320MHz	

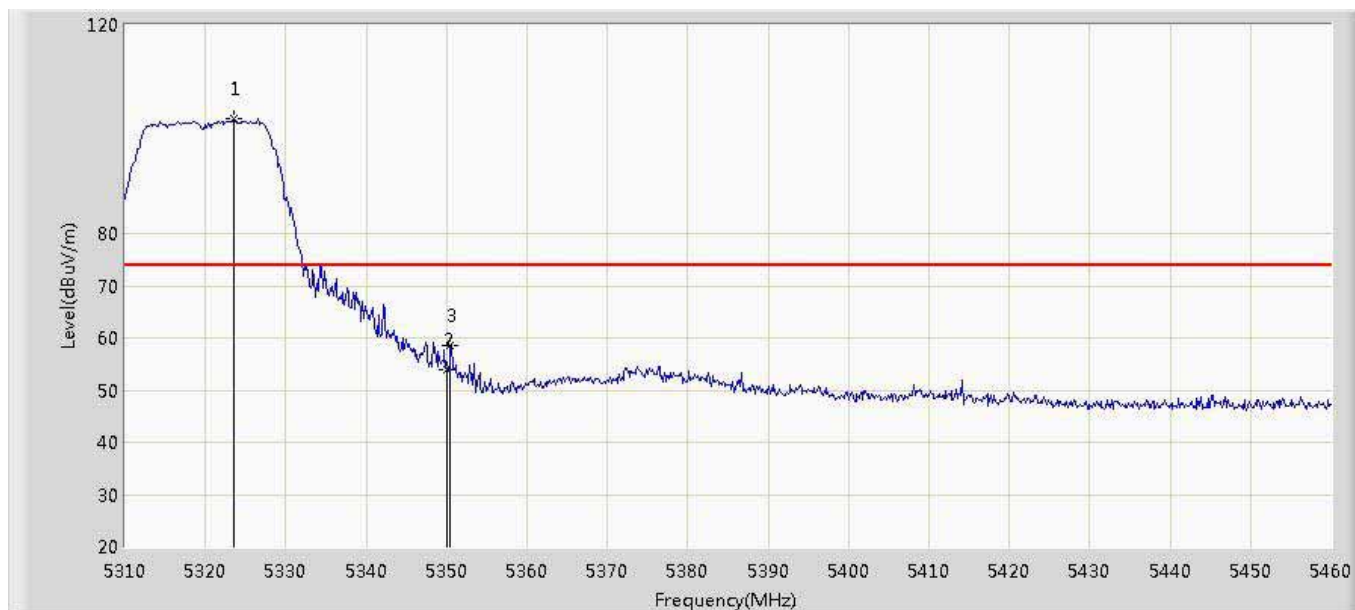

No	Mark	Frequency (MHz)	Measure Level (dBuV/m)	Reading Level (dBuV)	Over Limit (dB)	Limit (dBuV/m)	Factor (dB)	Type
1	*	5323.500	102.073	96.597	N/A	N/A	5.476	PK
2		5350.000	53.987	48.410	-20.013	74.000	5.577	PK
3		5350.500	58.692	53.113	-15.308	74.000	5.579	PK

Note:

1. All Readings below 1GHz are Quasi-Peak, above are performed with peak and/or average measurements as necessary.
2. " * ", means this data is the worst emission level.
3. Measurement Level = Reading Level + Factor(Probe+Cable-Amp).



Engineer: Chris	
Site: AC102	Time: 2019/08/03 - 19:59
Limit: FCC_Part15.209_RE(3m)	Margin: 0
Probe: N/A	Polarity: Vertical
EUT: Tablet	Power: AC 120V/60Hz
Note: 802.11a 5320MHz	

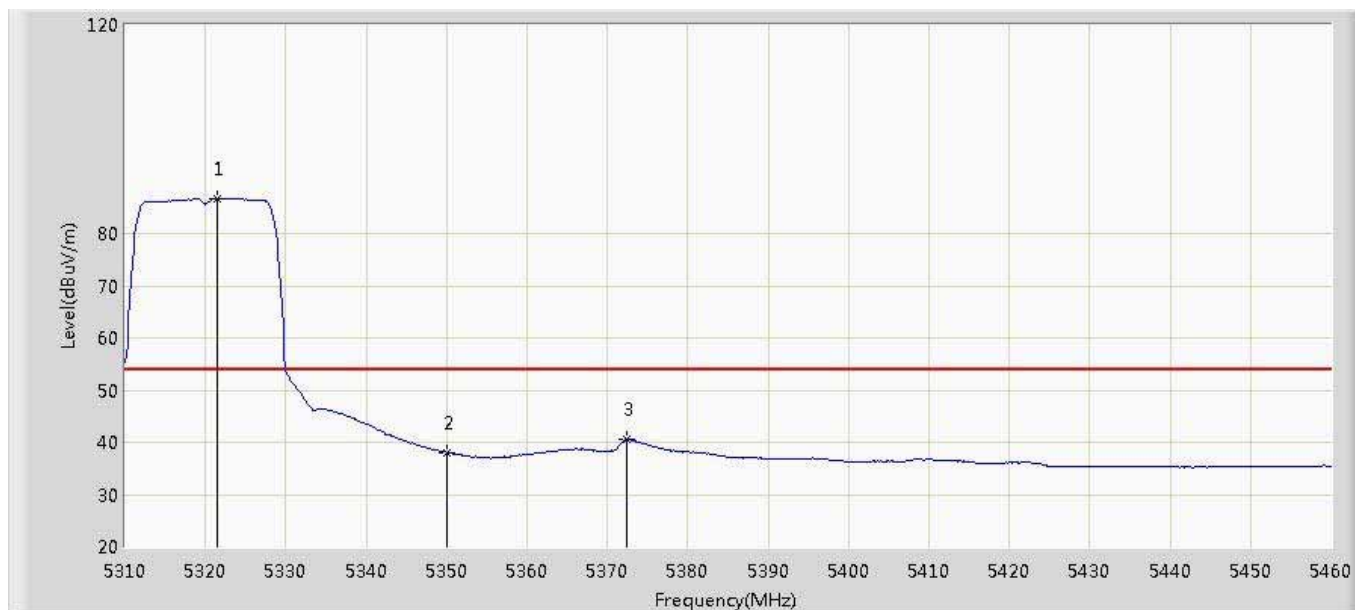

N o	Mar k	Frequency (MHz)	Measure Level (dBuV/m)	Reading Level (dBuV)	Over Limit (dB)	Limit (dBuV/m)	Factor (dB)	Type
1	*	5321.400	86.673	81.206	N/A	N/A	5.467	AV
2		5350.000	38.082	32.505	-15.918	54.000	5.577	AV
3		5372.400	40.547	34.884	-13.453	54.000	5.663	AV

Note:

1. All Readings below 1GHz are Quasi-Peak, above are performed with peak and/or average measurements as necessary.
2. " * ", means this data is the worst emission level.
3. Measurement Level = Reading Level + Factor(Probe+Cable-Amp).



Engineer: Chris	
Site: AC102	Time: 2019/08/03 - 20:01
Limit: FCC_Part15.209_RE(3m)	Margin: 0
Probe: N/A	Polarity: Horizontal
EUT: Tablet	Power: AC 120V/60Hz
Note: 802.11n-HT20 5180MHz	

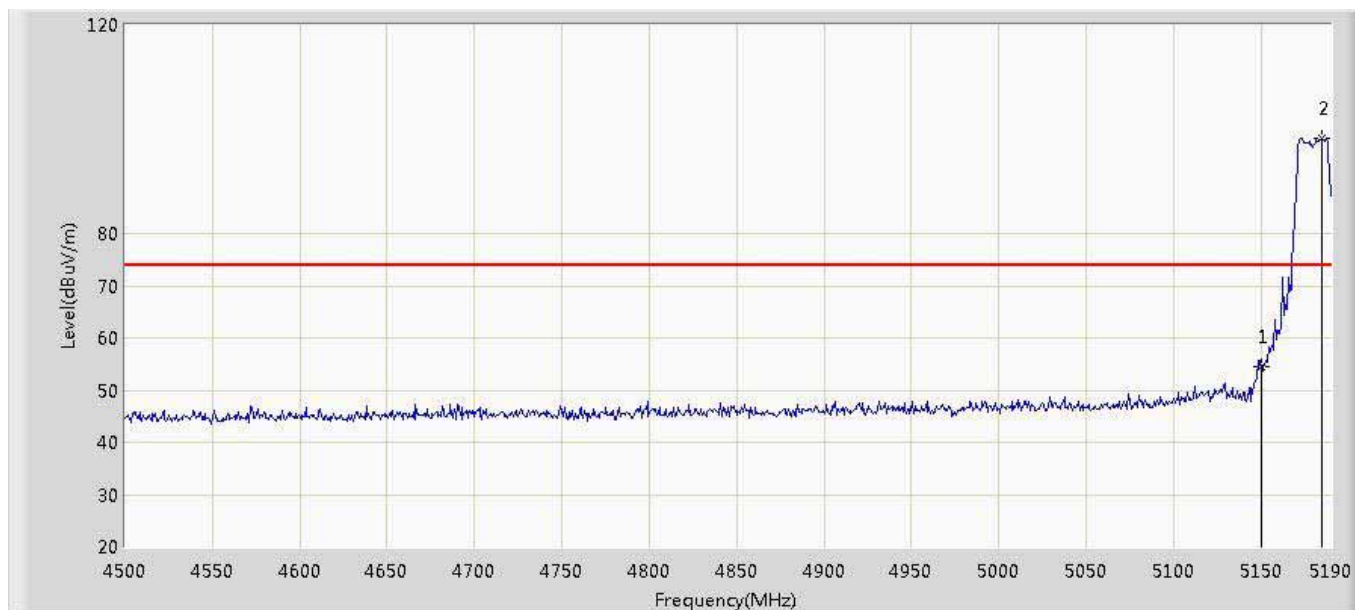

No	Mark	Frequency (MHz)	Measure Level (dBuV/m)	Reading Level (dBuV)	Over Limit (dB)	Limit (dBuV/m)	Factor (dB)	Type
1		5150.000	54.356	49.543	-19.644	74.000	4.813	PK
2	*	5184.480	98.349	93.404	N/A	N/A	4.945	PK

Note:

1. All Readings below 1GHz are Quasi-Peak, above are performed with peak and/or average measurements as necessary.
2. " * ", means this data is the worst emission level.
3. Measurement Level = Reading Level + Factor(Probe+Cable-Amp).



Engineer: Chris	
Site: AC102	Time: 2019/08/03 - 20:04
Limit: FCC_Part15.209_RE(3m)	Margin: 0
Probe: N/A	Polarity: Horizontal
EUT: Tablet	Power: AC 120V/60Hz
Note: 802.11n-HT20 5180MHz	

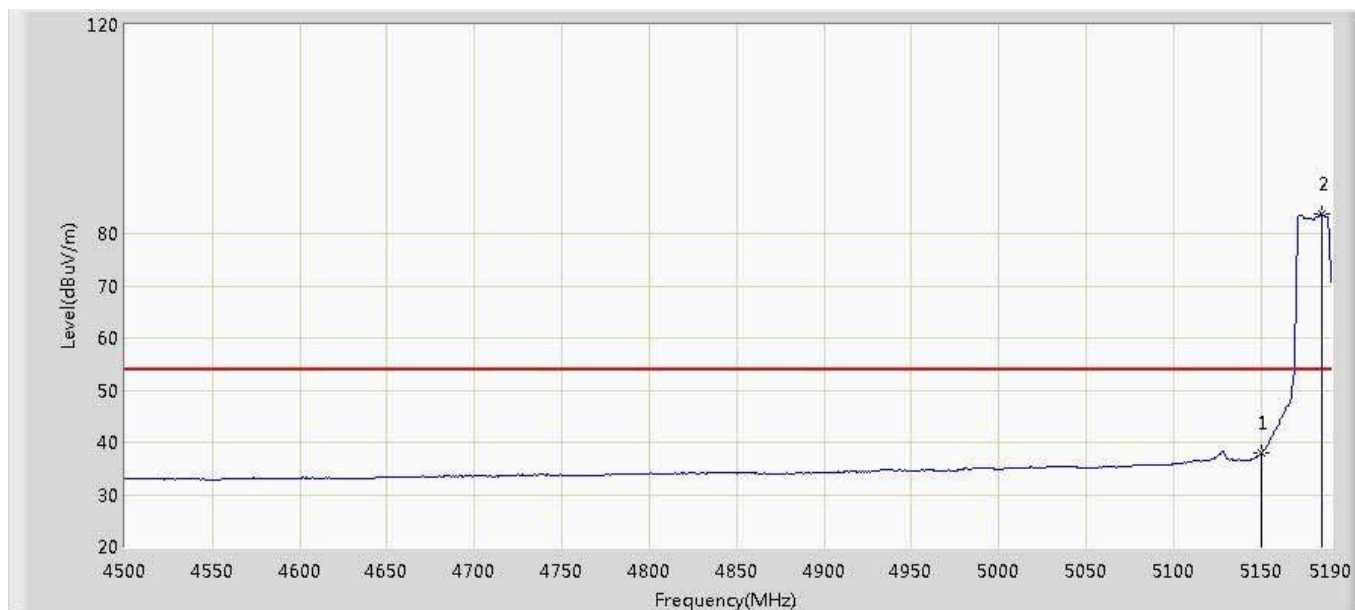

N	Mar	Frequency (MHz)	Measure Level (dBuV/m)	Reading Level (dBuV)	Over Limit (dB)	Limit (dBuV/m)	Factor (dB)	Type
1		5150.000	37.989	33.176	-16.011	54.000	4.813	AV
2	*	5184.480	83.651	78.706	N/A	N/A	4.945	AV

Note:

1. All Readings below 1GHz are Quasi-Peak, above are performed with peak and/or average measurements as necessary.
2. " * ", means this data is the worst emission level.
3. Measurement Level = Reading Level + Factor(Probe+Cable-Amp).



Engineer: Chris	
Site: AC102	Time: 2019/08/03 - 20:06
Limit: FCC_Part15.209_RE(3m)	Margin: 0
Probe: N/A	Polarity: Vertical
EUT: Tablet	Power: AC 120V/60Hz
Note: 802.11n-HT20 5180MHz	

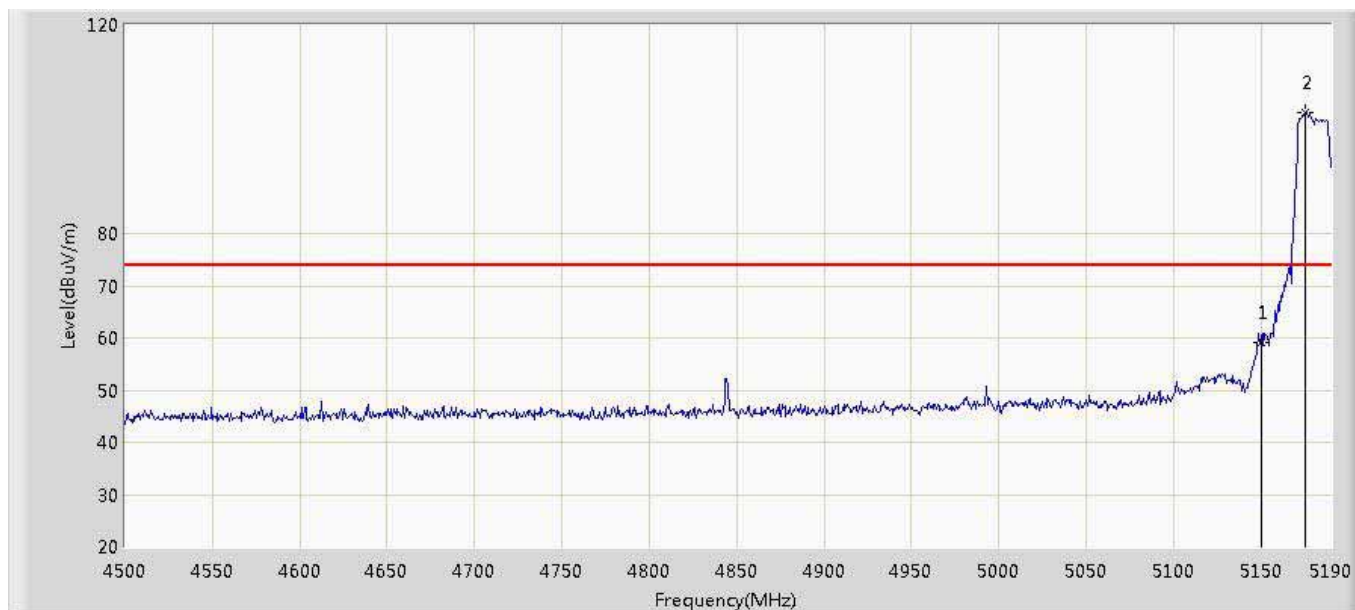

N	Mar	Frequency (MHz)	Measure Level (dBuV/m)	Reading Level (dBuV)	Over Limit (dB)	Limit (dBuV/m)	Factor (dB)	Type
1		5150.000	59.271	54.458	-14.729	74.000	4.813	PK
2	*	5175.510	103.139	98.229	N/A	N/A	4.910	PK

Note:

1. All Readings below 1GHz are Quasi-Peak, above are performed with peak and/or average measurements as necessary.
2. " * ", means this data is the worst emission level.
3. Measurement Level = Reading Level + Factor(Probe+Cable-Amp).



Engineer: Chris	
Site: AC102	Time: 2019/08/03 - 20:08
Limit: FCC_Part15.209_RE(3m)	Margin: 0
Probe: N/A	Polarity: Vertical
EUT: Tablet	Power: AC 120V/60Hz
Note: 802.11n-HT20 5180MHz	

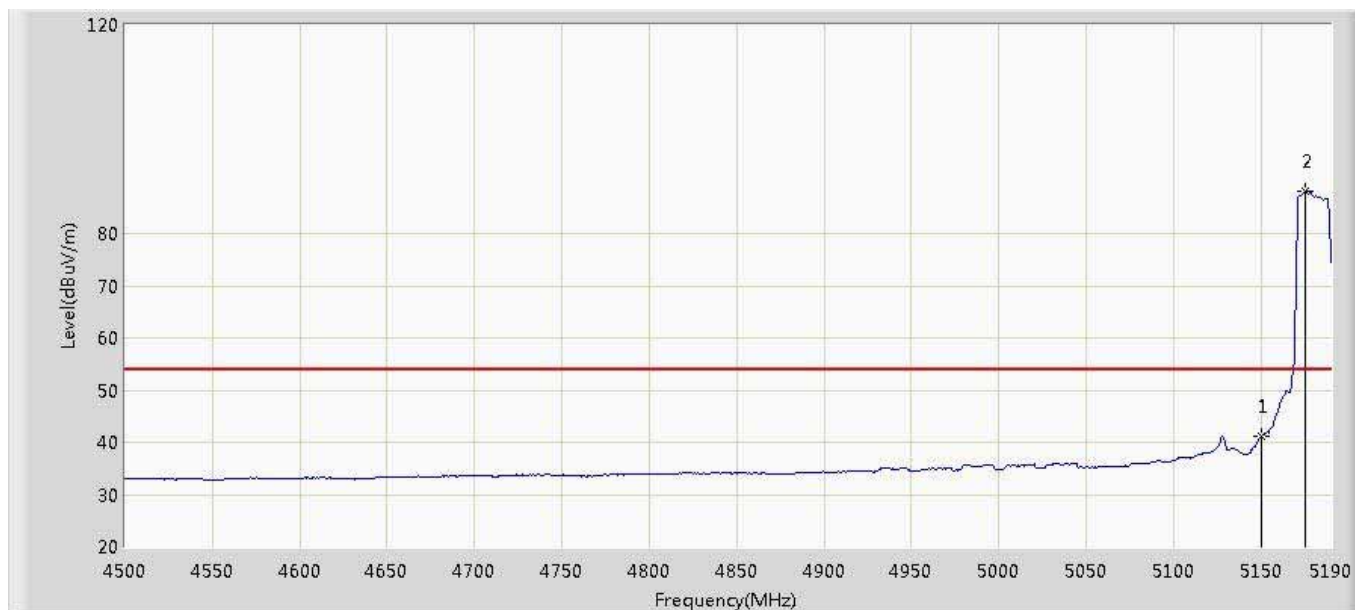

N	Mar	Frequency (MHz)	Measure Level (dBuV/m)	Reading Level (dBuV)	Over Limit (dB)	Limit (dBuV/m)	Factor (dB)	Type
1		5150.000	41.099	36.286	-12.901	54.000	4.813	AV
2	*	5175.510	87.987	83.077	N/A	N/A	4.910	AV

Note:

1. All Readings below 1GHz are Quasi-Peak, above are performed with peak and/or average measurements as necessary.
2. " * ", means this data is the worst emission level.
3. Measurement Level = Reading Level + Factor(Probe+Cable-Amp).



Engineer: Chris	
Site: AC102	Time: 2019/08/03 - 20:11
Limit: FCC_Part15.209_RE(3m)	Margin: 0
Probe: N/A	Polarity: Horizontal
EUT: Tablet	Power: AC 120V/60Hz
Note: 802.11n-HT20 5320MHz	

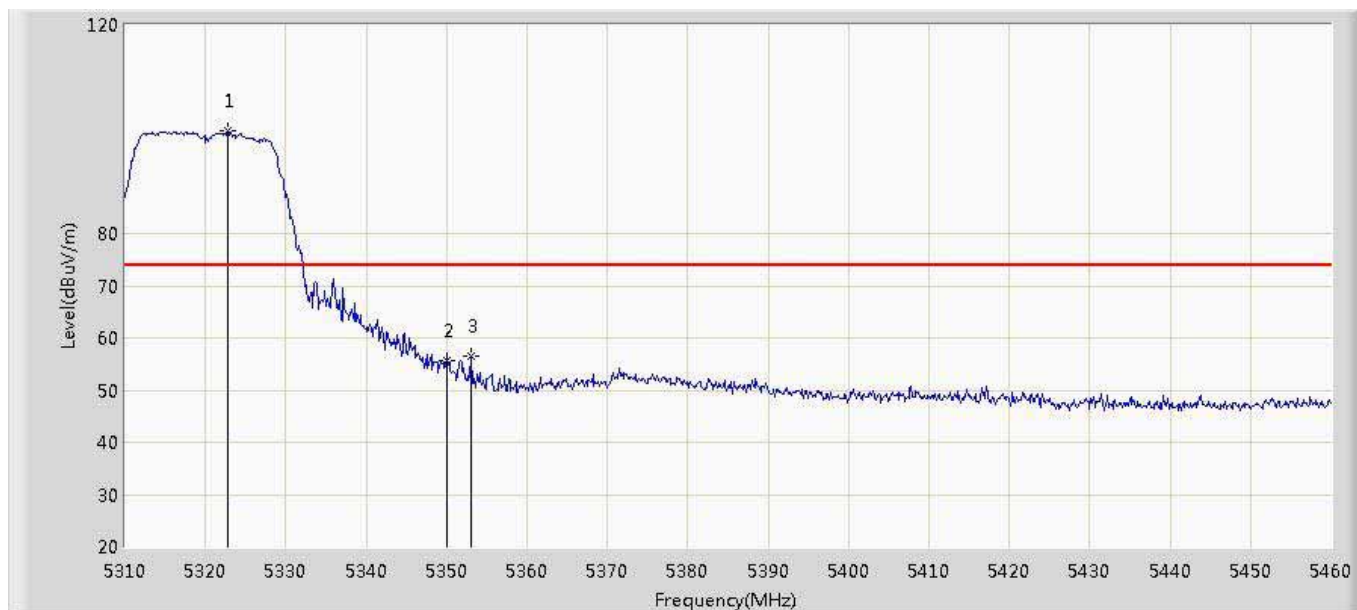

No	Mark	Frequency (MHz)	Measure Level (dBuV/m)	Reading Level (dBuV)	Over Limit (dB)	Limit (dBuV/m)	Factor (dB)	Type
1	*	5322.750	99.783	94.310	N/A	N/A	5.473	PK
2		5350.000	55.715	50.138	-18.285	74.000	5.577	PK
3		5353.050	56.418	50.829	-17.582	74.000	5.589	PK

Note:

1. All Readings below 1GHz are Quasi-Peak, above are performed with peak and/or average measurements as necessary.
2. " * ", means this data is the worst emission level.
3. Measurement Level = Reading Level + Factor(Probe+Cable-Amp).



Engineer: Chris	
Site: AC102	Time: 2019/08/03 - 20:12
Limit: FCC_Part15.209_RE(3m)	Margin: 0
Probe: N/A	Polarity: Horizontal
EUT: Tablet	Power: AC 120V/60Hz
Note: 802.11n-HT20 5320MHz	

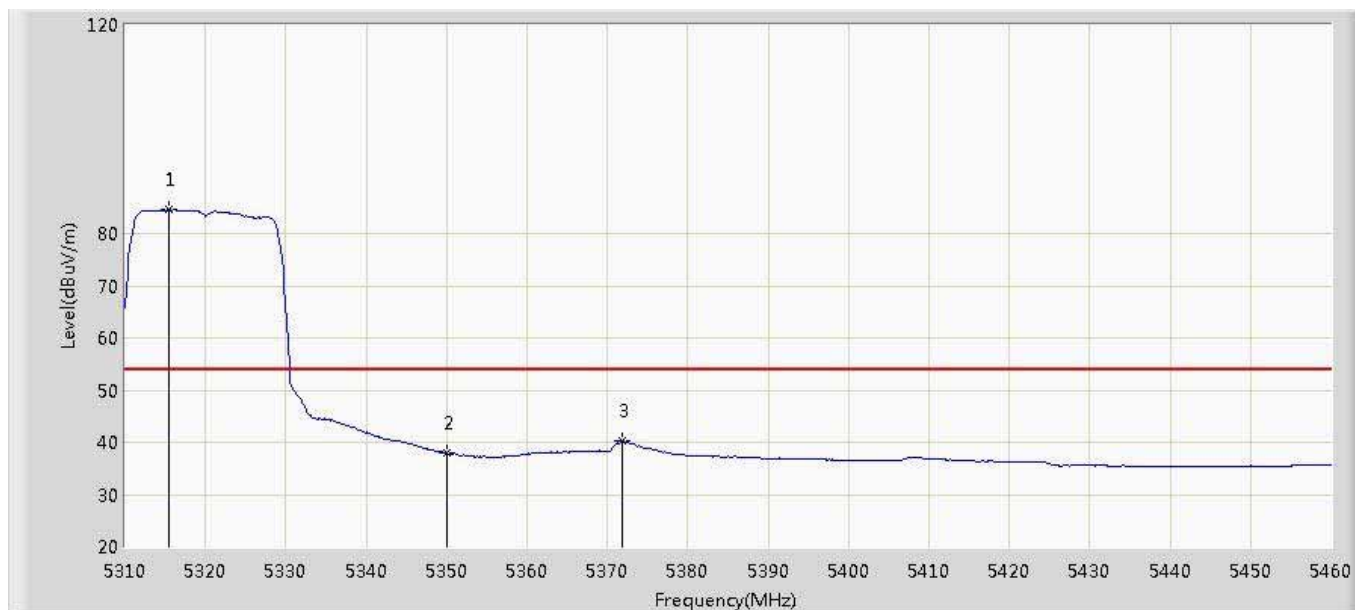

No	Mark	Frequency (MHz)	Measure Level (dBuV/m)	Reading Level (dBuV)	Over Limit (dB)	Limit (dBuV/m)	Factor (dB)	Type
1	*	5315.400	84.515	79.070	N/A	N/A	5.445	AV
2		5350.000	37.965	32.388	-16.035	54.000	5.577	AV
3		5371.800	40.343	34.683	-13.657	54.000	5.660	AV

Note:

1. All Readings below 1GHz are Quasi-Peak, above are performed with peak and/or average measurements as necessary.
2. " * ", means this data is the worst emission level.
3. Measurement Level = Reading Level + Factor(Probe+Cable-Amp).



Engineer: Chris	
Site: AC102	Time: 2019/08/03 - 20:13
Limit: FCC_Part15.209_RE(3m)	Margin: 0
Probe: N/A	Polarity: Vertical
EUT: Tablet	Power: AC 120V/60Hz
Note: 802.11n-HT20 5320MHz	

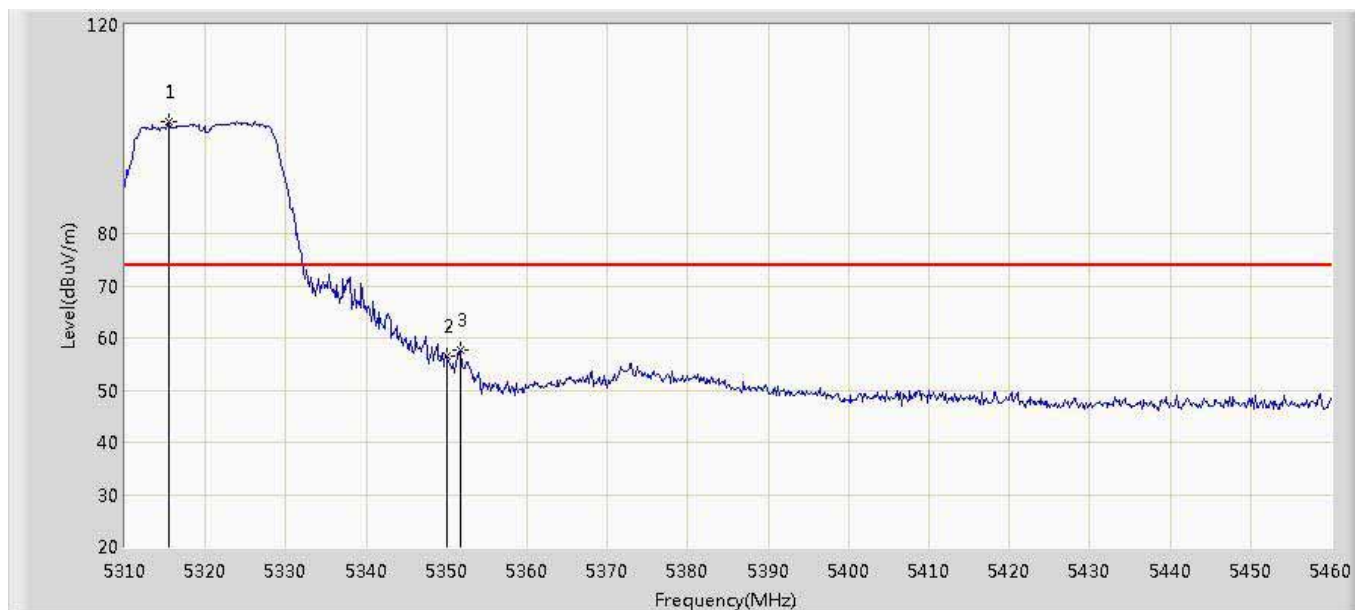

No	Mark	Frequency (MHz)	Measure Level (dBuV/m)	Reading Level (dBuV)	Over Limit (dB)	Limit (dBuV/m)	Factor (dB)	Type
1	*	5315.400	101.459	96.014	N/A	N/A	5.445	PK
2		5350.000	56.600	51.023	-17.400	74.000	5.577	PK
3		5351.700	57.764	52.180	-16.236	74.000	5.584	PK

Note:

1. All Readings below 1GHz are Quasi-Peak, above are performed with peak and/or average measurements as necessary.
2. " * ", means this data is the worst emission level.
3. Measurement Level = Reading Level + Factor(Probe+Cable-Amp).



Engineer: Chris	
Site: AC102	Time: 2019/08/03 - 20:16
Limit: FCC_Part15.209_RE(3m)	Margin: 0
Probe: N/A	Polarity: Vertical
EUT: Tablet	Power: AC 120V/60Hz
Note: 802.11n-HT20 5320MHz	

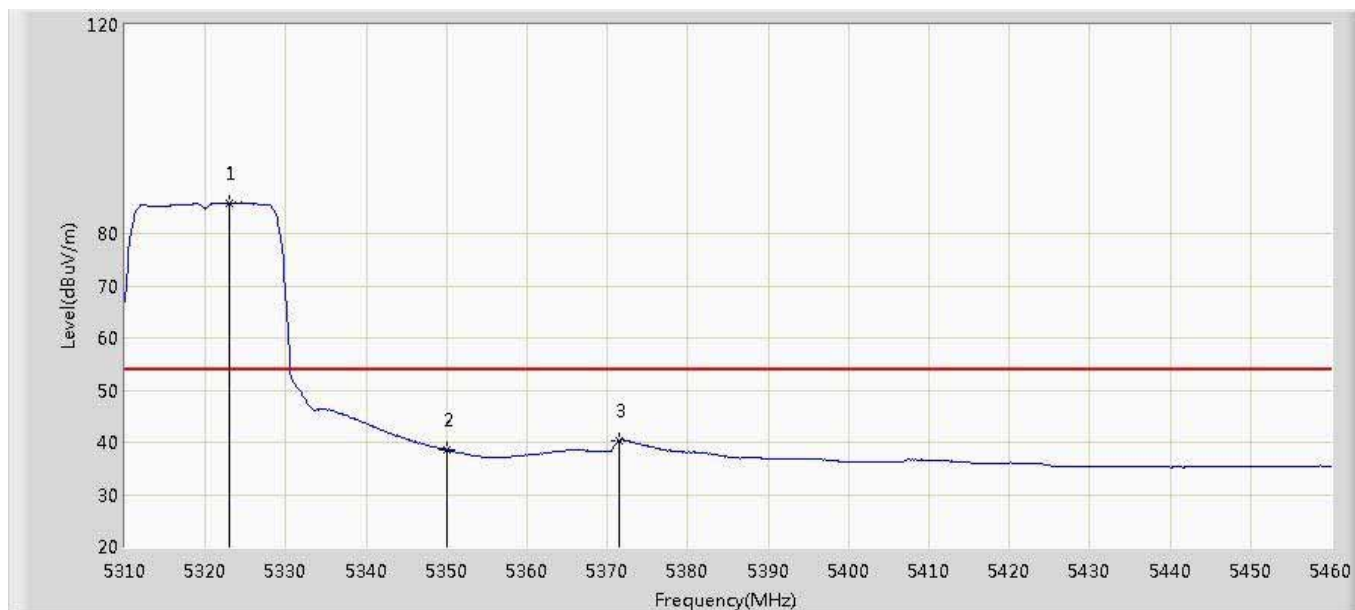

No	Mark	Frequency (MHz)	Measure Level (dBuV/m)	Reading Level (dBuV)	Over Limit (dB)	Limit (dBuV/m)	Factor (dB)	Type
1	*	5322.900	85.881	80.408	N/A	N/A	5.473	AV
2		5350.000	38.535	32.958	-15.465	54.000	5.577	AV
3		5371.500	40.362	34.703	-13.638	54.000	5.659	AV

Note:

1. All Readings below 1GHz are Quasi-Peak, above are performed with peak and/or average measurements as necessary.
2. " * ", means this data is the worst emission level.
3. Measurement Level = Reading Level + Factor(Probe+Cable-Amp).



Engineer: Chris	
Site: AC102	Time: 2019/08/03 - 20:18
Limit: FCC_Part15.209_RE(3m)	Margin: 0
Probe: N/A	Polarity: Horizontal
EUT: Tablet	Power: AC 120V/60Hz
Note: 802.11n-HT40 5190MHz	

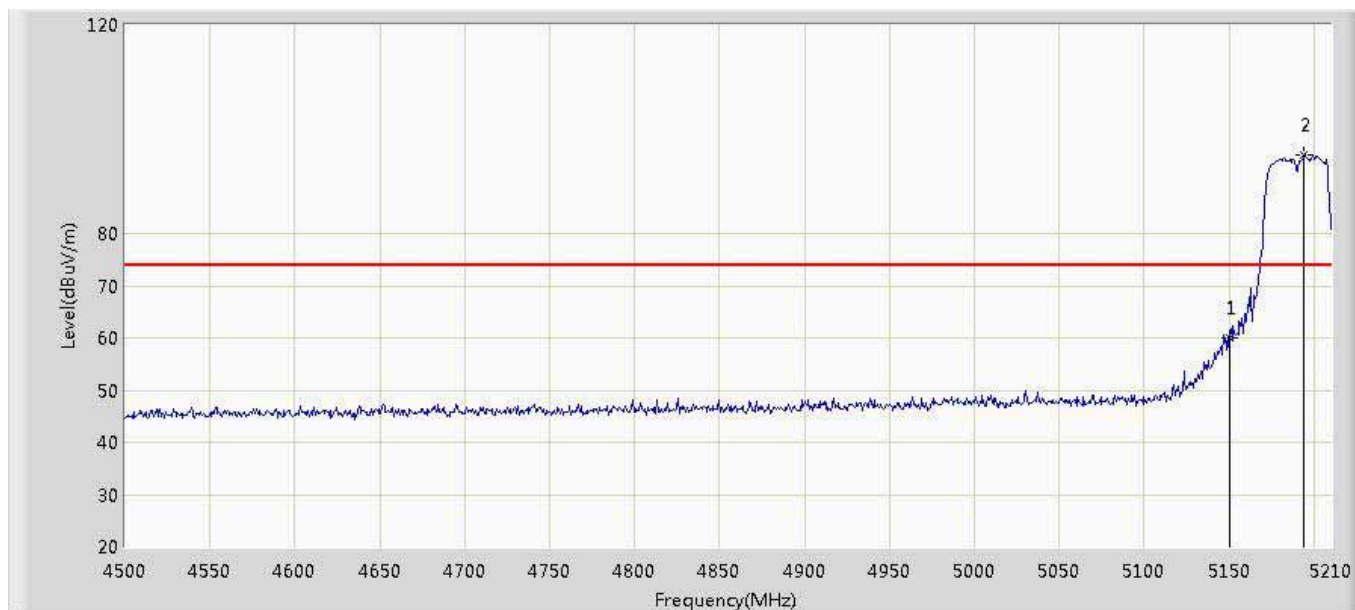

N	Mar	Frequency (MHz)	Measure Level (dBuV/m)	Reading Level (dBuV)	Over Limit (dB)	Limit (dBuV/m)	Factor (dB)	Type
1		5150.000	59.996	55.183	-14.004	74.000	4.813	PK
2	*	5194.380	95.012	90.030	N/A	N/A	4.982	PK

Note:

1. All Readings below 1GHz are Quasi-Peak, above are performed with peak and/or average measurements as necessary.
2. " * ", means this data is the worst emission level.
3. Measurement Level = Reading Level + Factor(Probe+Cable-Amp).



Engineer: Chris	
Site: AC102	Time: 2019/08/03 - 20:22
Limit: FCC_Part15.209_RE(3m)	Margin: 0
Probe: N/A	Polarity: Horizontal
EUT: Tablet	Power: AC 120V/60Hz
Note: 802.11n-HT40 5190MHz	

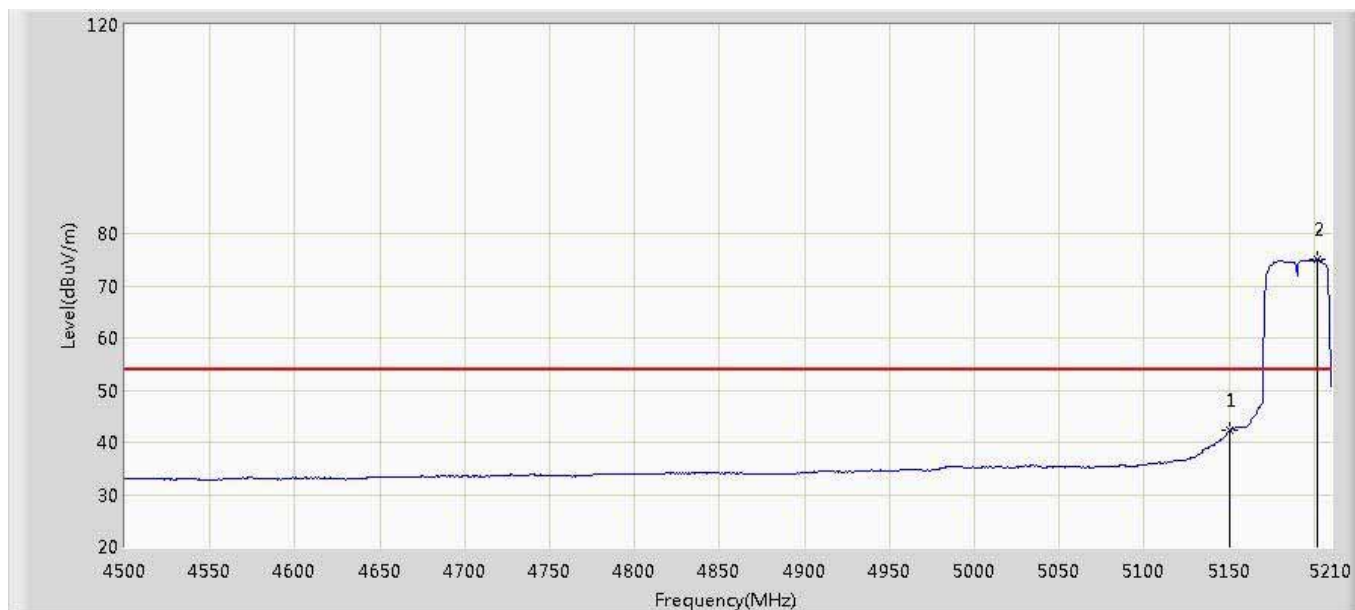

N	Mar	Frequency (MHz)	Measure Level (dBuV/m)	Reading Level (dBuV)	Over Limit (dB)	Limit (dBuV/m)	Factor (dB)	Type
1		5150.000	42.194	37.381	-11.806	54.000	4.813	AV
2	*	5202.190	75.185	70.173	N/A	N/A	5.012	AV

Note:

1. All Readings below 1GHz are Quasi-Peak, above are performed with peak and/or average measurements as necessary.
2. " * ", means this data is the worst emission level.
3. Measurement Level = Reading Level + Factor(Probe+Cable-Amp).



Engineer: Chris	
Site: AC102	Time: 2019/08/03 - 20:24
Limit: FCC_Part15.209_RE(3m)	Margin: 0
Probe: N/A	Polarity: Vertical
EUT: Tablet	Power: AC 120V/60Hz
Note: 802.11n-HT40 5190MHz	

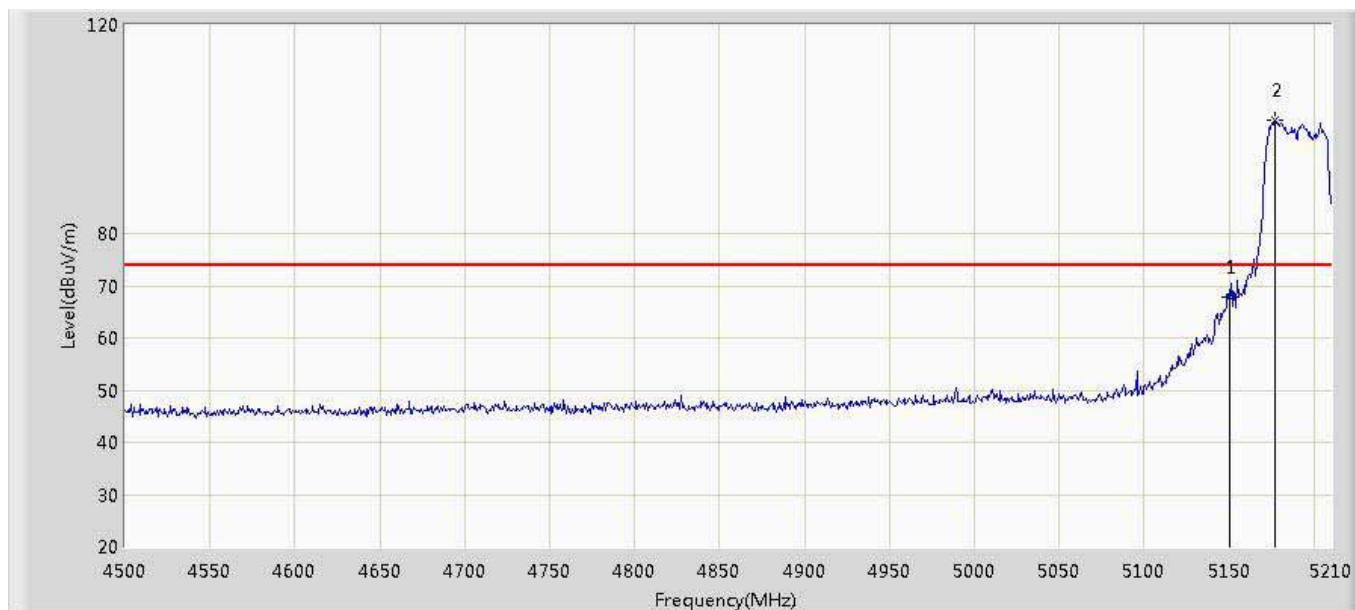

N	Mar	Frequency (MHz)	Measure Level (dBuV/m)	Reading Level (dBuV)	Over Limit (dB)	Limit (dBuV/m)	Factor (dB)	Type
1		5150.000	67.849	63.036	-6.151	74.000	4.813	PK
2	*	5177.340	101.651	96.734	N/A	N/A	4.917	PK

Note:

1. All Readings below 1GHz are Quasi-Peak, above are performed with peak and/or average measurements as necessary.
2. " * ", means this data is the worst emission level.
3. Measurement Level = Reading Level + Factor(Probe+Cable-Amp).



Engineer: Chris	
Site: AC102	Time: 2019/08/03 - 20:27
Limit: FCC_Part15.209_RE(3m)	Margin: 0
Probe: N/A	Polarity: Vertical
EUT: Tablet	Power: AC 120V/60Hz
Note: 802.11n-HT40 5190MHz	

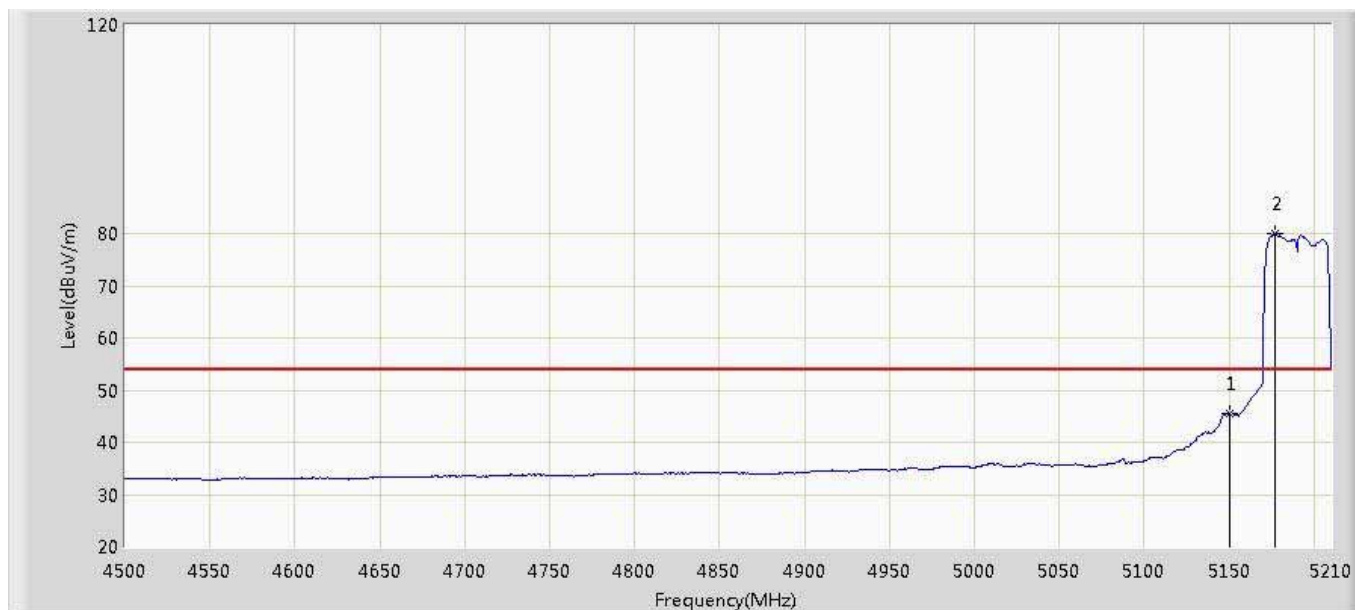

N	Mar	Frequency (MHz)	Measure Level (dBuV/m)	Reading Level (dBuV)	Over Limit (dB)	Limit (dBuV/m)	Factor (dB)	Type
1		5150.000	45.582	40.769	-8.418	54.000	4.813	AV
2	*	5177.340	80.044	75.127	N/A	N/A	4.917	AV

Note:

1. All Readings below 1GHz are Quasi-Peak, above are performed with peak and/or average measurements as necessary.
2. " * ", means this data is the worst emission level.
3. Measurement Level = Reading Level + Factor(Probe+Cable-Amp).



Engineer: Chris	
Site: AC102	Time: 2019/08/03 - 20:40
Limit: FCC_Part15.209_RE(3m)	Margin: 0
Probe: N/A	Polarity: Horizontal
EUT: Tablet	Power: AC 120V/60Hz
Note: 802.11n-HT40 5310MHz	

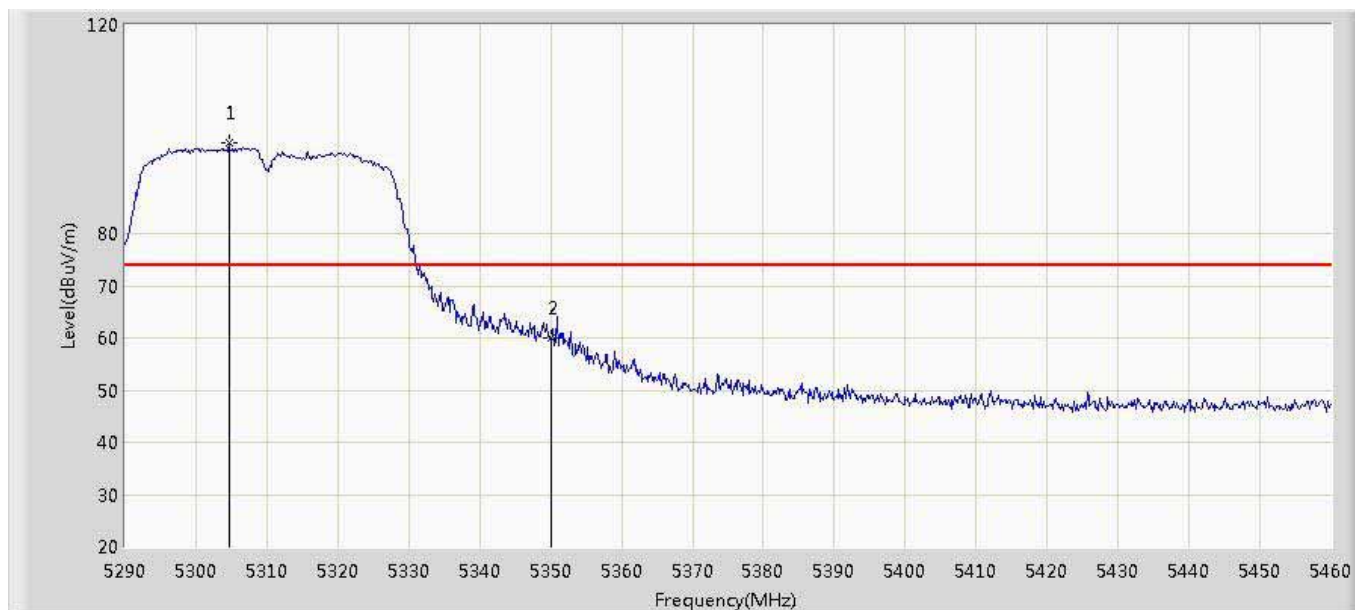

N	Mar	Frequency (MHz)	Measure Level (dBuV/m)	Reading Level (dBuV)	Over Limit (dB)	Limit (dBuV/m)	Factor (dB)	Type
1	*	5304.620	97.297	91.893	N/A	N/A	5.404	PK
2		5350.000	59.859	54.282	-14.141	74.000	5.577	PK

Note:

1. All Readings below 1GHz are Quasi-Peak, above are performed with peak and/or average measurements as necessary.
2. " * ", means this data is the worst emission level.
3. Measurement Level = Reading Level + Factor(Probe+Cable-Amp).



Engineer: Chris	
Site: AC102	Time: 2019/08/03 - 20:41
Limit: FCC_Part15.209_RE(3m)	Margin: 0
Probe: N/A	Polarity: Horizontal
EUT: Tablet	Power: AC 120V/60Hz
Note: 802.11n-HT40 5310MHz	

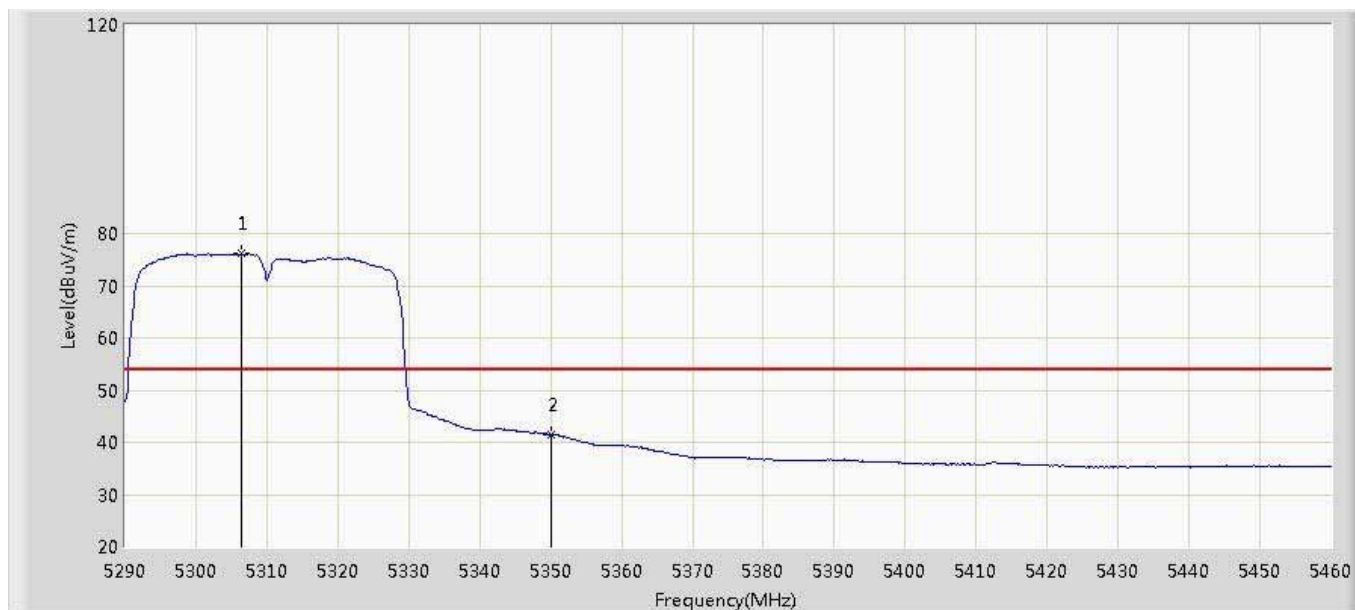

N	Mar	Frequency (MHz)	Measure Level (dBuV/m)	Reading Level (dBuV)	Over Limit (dB)	Limit (dBuV/m)	Factor (dB)	Type
1	*	5306.490	76.137	70.726	N/A	N/A	5.411	AV
2		5350.000	41.501	35.924	-12.499	54.000	5.577	AV

Note:

1. All Readings below 1GHz are Quasi-Peak, above are performed with peak and/or average measurements as necessary.
2. " * ", means this data is the worst emission level.
3. Measurement Level = Reading Level + Factor(Probe+Cable-Amp).



Engineer: Chris	
Site: AC102	Time: 2019/08/03 - 20:42
Limit: FCC_Part15.209_RE(3m)	Margin: 0
Probe: N/A	Polarity: Vertical
EUT: Tablet	Power: AC 120V/60Hz
Note: 802.11n-HT40 5310MHz	

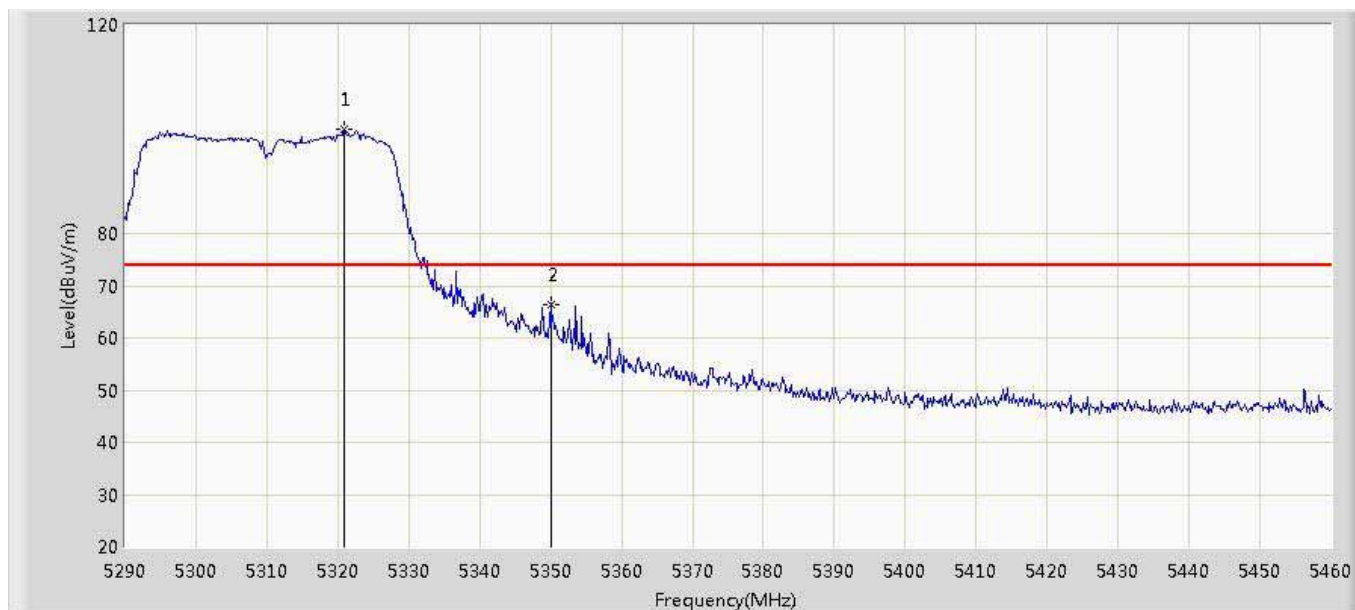

No	Mark	Frequency (MHz)	Measure Level (dBuV/m)	Reading Level (dBuV)	Over Limit (dB)	Limit (dBuV/m)	Factor (dB)	Type
1	*	5320.940	99.910	94.444	N/A	N/A	5.466	PK
2		5350.000	66.394	60.817	-7.606	74.000	5.577	PK

Note:

1. All Readings below 1GHz are Quasi-Peak, above are performed with peak and/or average measurements as necessary.
2. " * ", means this data is the worst emission level.
3. Measurement Level = Reading Level + Factor(Probe+Cable-Amp).



Engineer: Chris	
Site: AC102	Time: 2019/08/03 - 20:44
Limit: FCC_Part15.209_RE(3m)	Margin: 0
Probe: N/A	Polarity: Vertical
EUT: Tablet	Power: AC 120V/60Hz
Note: 802.11n-HT40 5310MHz	

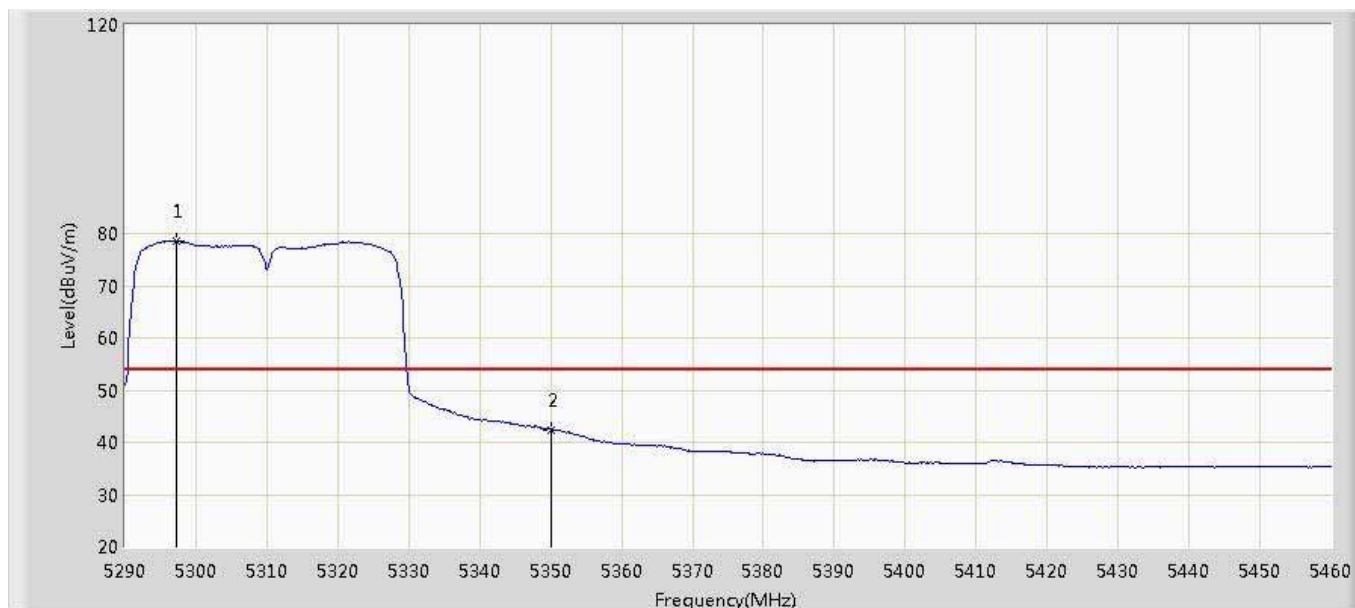

N	Mar	Frequency (MHz)	Measure Level (dBuV/m)	Reading Level (dBuV)	Over Limit (dB)	Limit (dBuV/m)	Factor (dB)	Type
1	*	5297.310	78.545	73.170	N/A	N/A	5.375	AV
2		5350.000	42.457	36.880	-11.543	54.000	5.577	AV

Note:

1. All Readings below 1GHz are Quasi-Peak, above are performed with peak and/or average measurements as necessary.
2. " * ", means this data is the worst emission level.
3. Measurement Level = Reading Level + Factor(Probe+Cable-Amp).

**9.5.1.1 Authorized-Band Bandedge**

Test Item	Bandedge Measurement
Test Engineer:	Chris
Test Date	2019-08-01

Test Mode	Data Rate (Mbps)	Channel No.	Freq. (MHz)	EIRP Band-edge (dBm/MHz)	EIRP Band-edge Limit (dBm/MHz)	Result
802.11a	6	36	5180	-30	≤ -27	Pass
		48	5240	-45	≤ -27	Pass
		52	5260	-44	≤ -27	Pass
		64	5320	-32	≤ -27	Pass
		100	5500	-31	≤ -27	Pass
		140	5700	-29	≤ -27	Pass
		149	5745	-42	See FCC 15.407(b)(4)(i)	Pass
		165	5825	-41	See FCC 15.407(b)(4)(i)	Pass

Note: EIRP Band-edge = EIRP Band-edge Limit – Margin.



802.11a Authorized-band band-edge

Channel 36 (5180MHz)

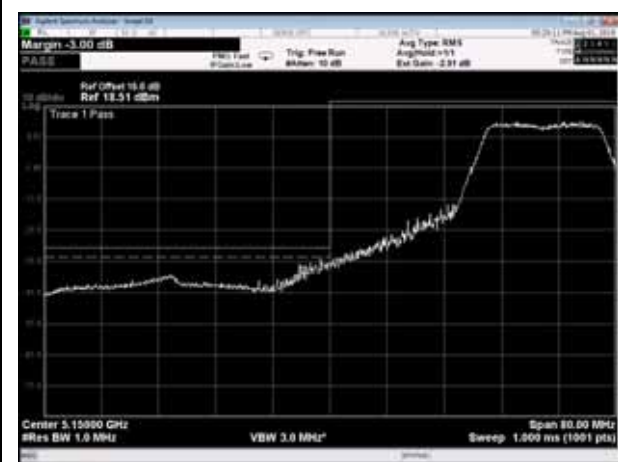

Channel 48 (5240MHz)

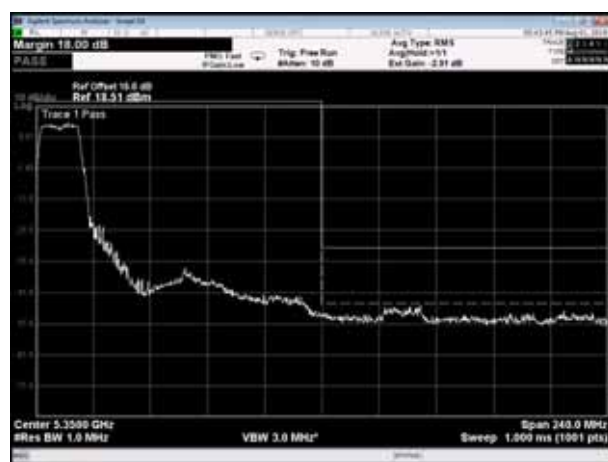

Channel 52 (5260MHz)

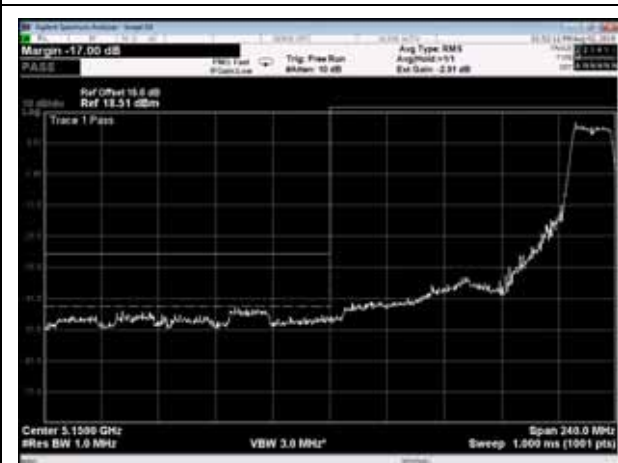

Channel 64 (5320MHz)

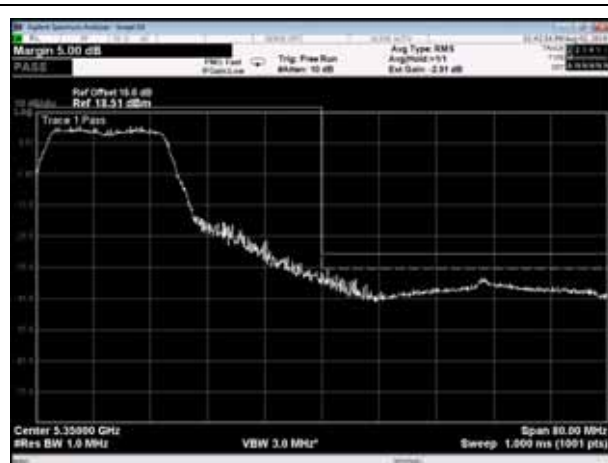

Channel 100 (5500MHz)

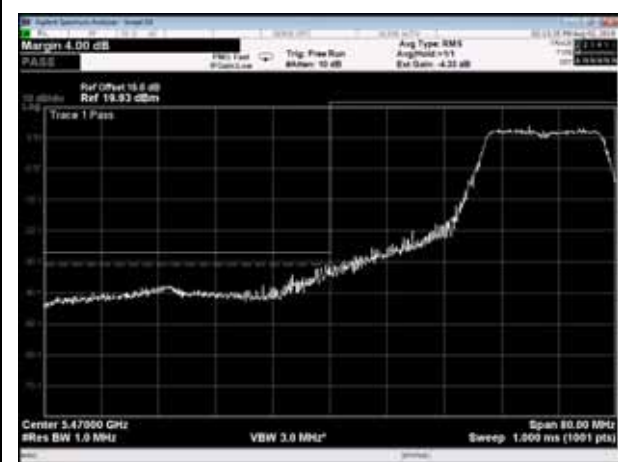

Channel 140 (5700MHz)

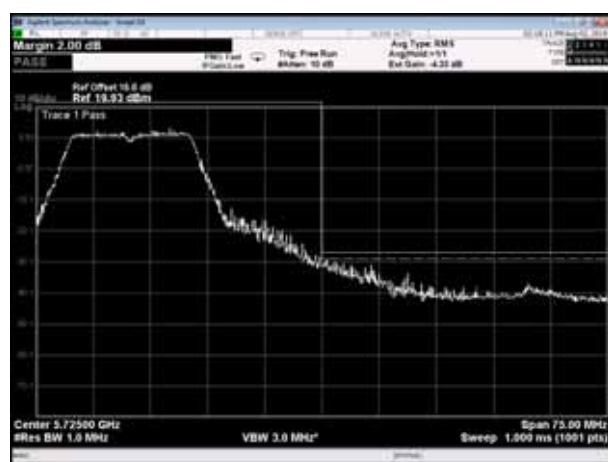

Channel 149 (5745MHz)

Channel 165 (5825MHz)

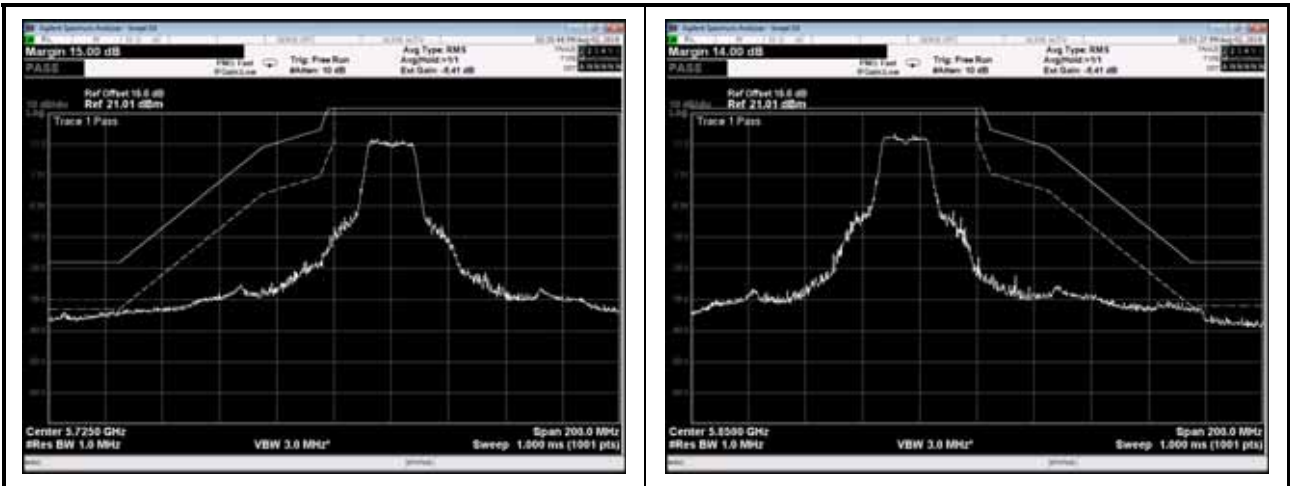



Test Mode	Data Rate (Mbps)	Channel No.	Freq. (MHz)	EIRP Band-edge (dBm/MHz)	EIRP Band-edge Limit (dBm/MHz)	Result
802.11n 20MHz	6.5	36	5180	-34	≤ -27	Pass
		48	5240	-44	≤ -27	Pass
		52	5260	-43	≤ -27	Pass
		64	5320	-31	≤ -27	Pass
		100	5500	-29	≤ -27	Pass
		140	5700	-28	≤ -27	Pass
		149	5745	-41	See FCC 15.407(b)(4)(i)	Pass
		165	5825	-40	See FCC 15.407(b)(4)(i)	Pass

Note: EIRP Band-edge = EIRP Band-edge Limit – Margin.



802.11n(20MHz) Authorized-band band-edge

Channel 36 (5180MHz)

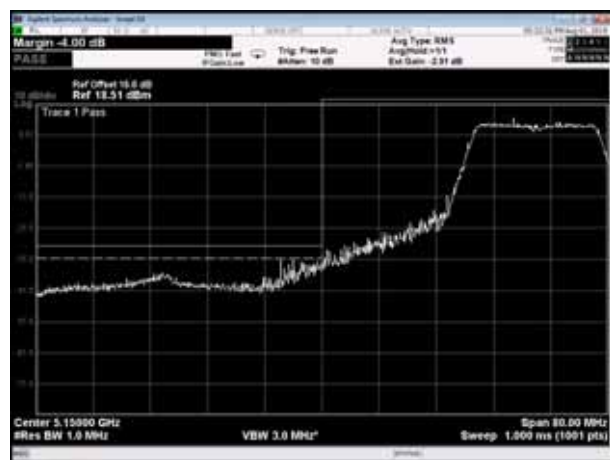

Channel 48 (5240MHz)

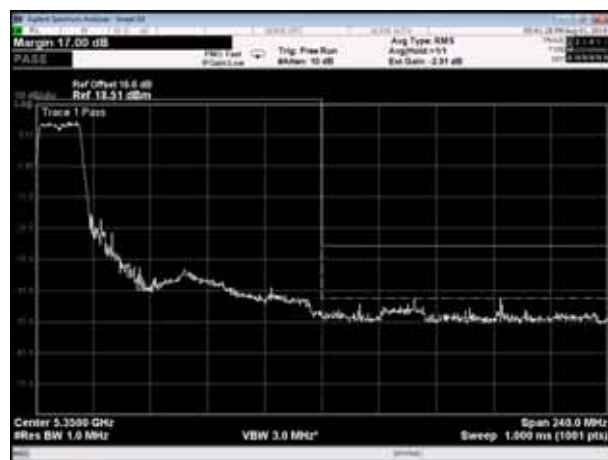

Channel 52 (5260MHz)



Channel 64 (5320MHz)

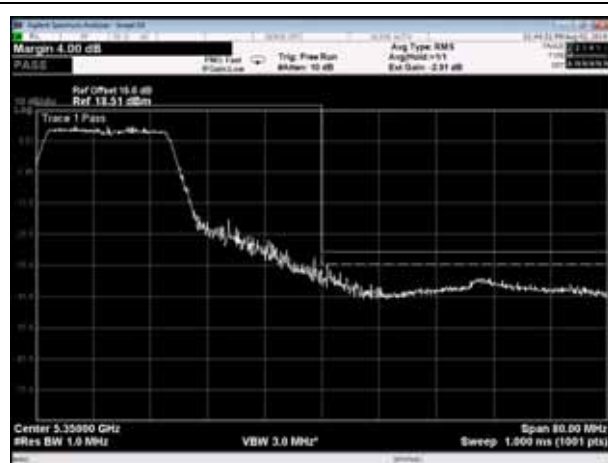

Channel 100 (5500MHz)

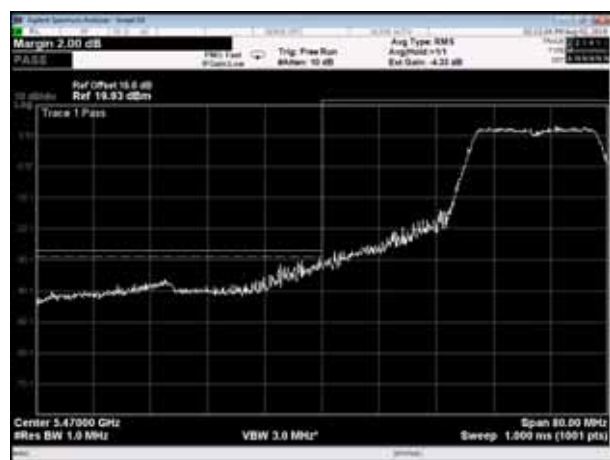

Channel 140 (5700MHz)

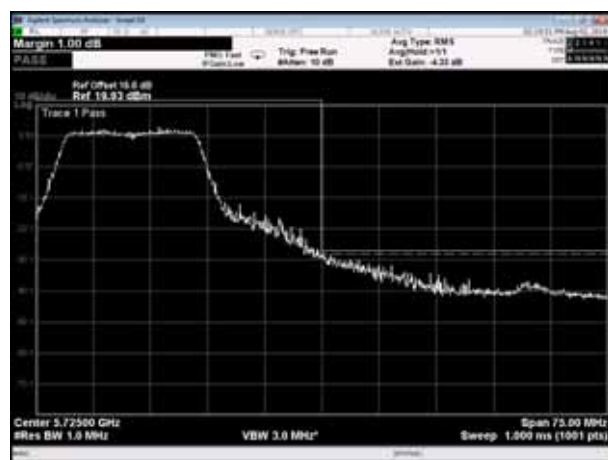

Channel 149 (5745MHz)

Channel 165 (5825MHz)

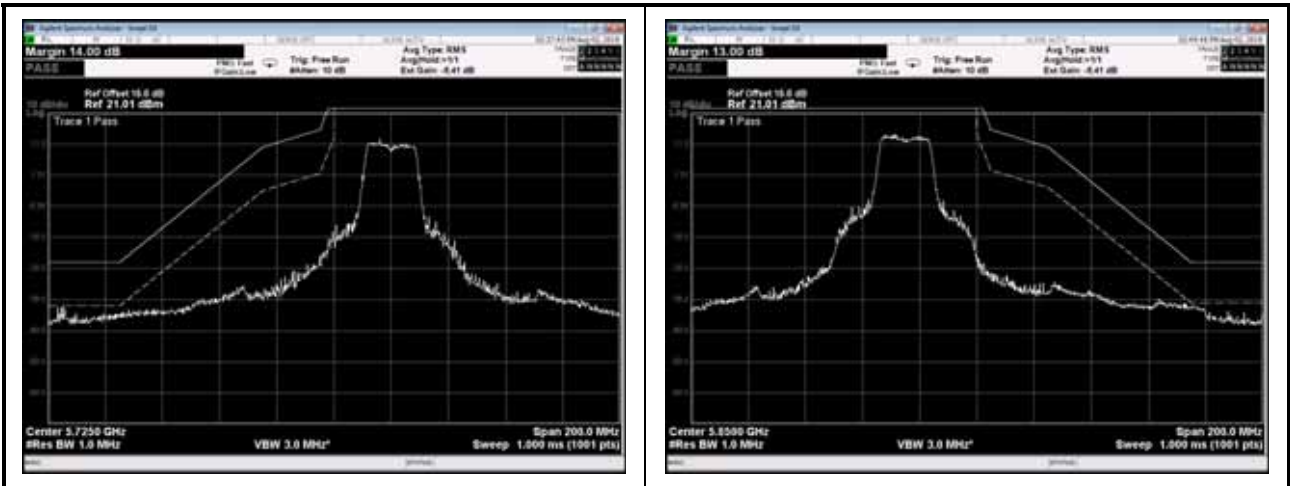



Test Mode	Data Rate (Mbps)	Channel No.	Freq. (MHz)	EIRP Band-edge (dBm/MHz)	EIRP Band-edge Limit (dBm/MHz)	Result
802.11n 40MHz	13.5	38	5190	-28	≤ -27	Pass
		46	5230	-47	≤ -27	Pass
		54	5270	-44	≤ -27	Pass
		62	5310	-29	≤ -27	Pass
		102	5510	-28	≤ -27	Pass
		134	5670	-32	≤ -27	Pass
		151	5755	-40	See FCC 15.407(b)(4)(i)	Pass
		159	5795	-43	See FCC 15.407(b)(4)(i)	Pass

Note: EIRP Band-edge = EIRP Band-edge Limit – Margin.



802.11n(40MHz) Authorized-band band-edge

Channel 38 (5190MHz)

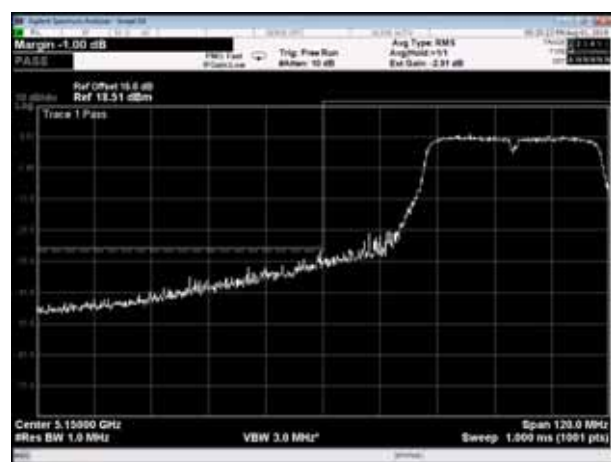

Channel 46 (5230MHz)

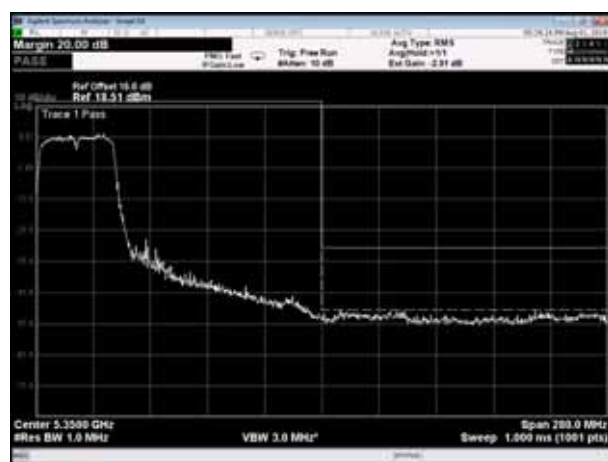

Channel 54 (5270MHz)

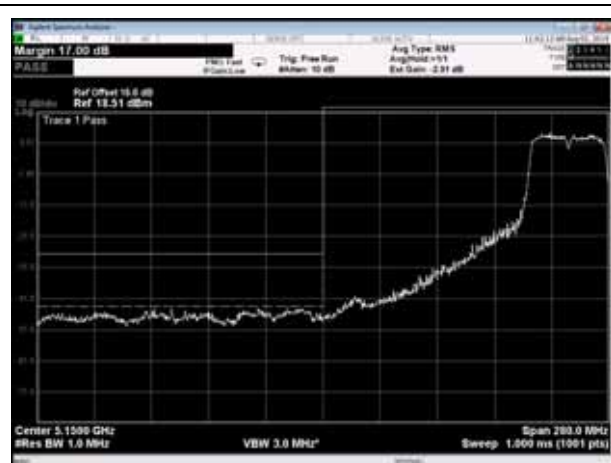

Channel 62 (5310MHz)

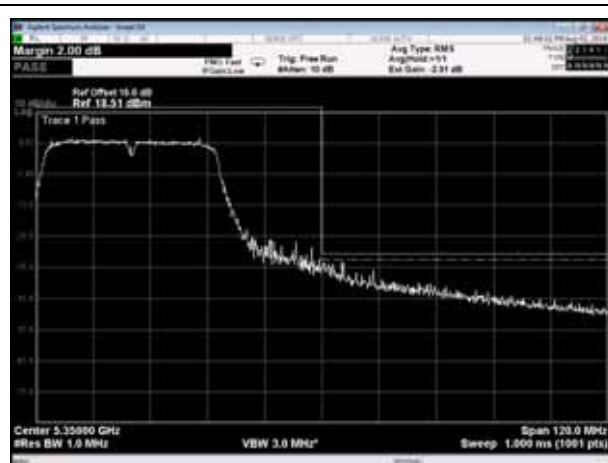

Channel 102 (5510MHz)

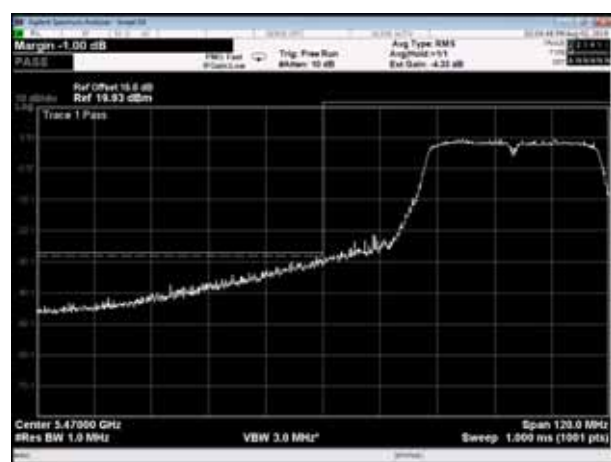

Channel 134 (5670MHz)

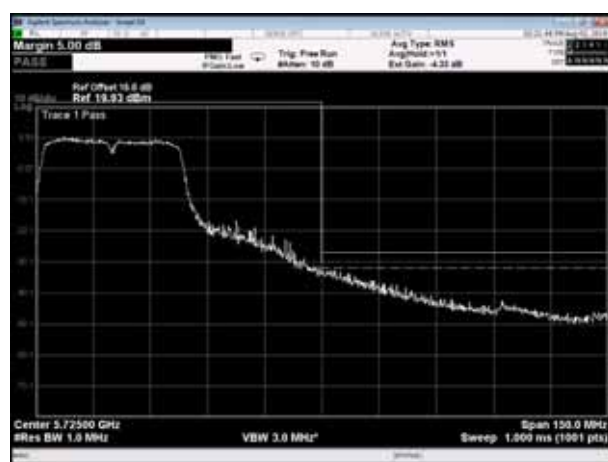

Channel 151 (5755MHz)

Channel 159 (5795MHz)

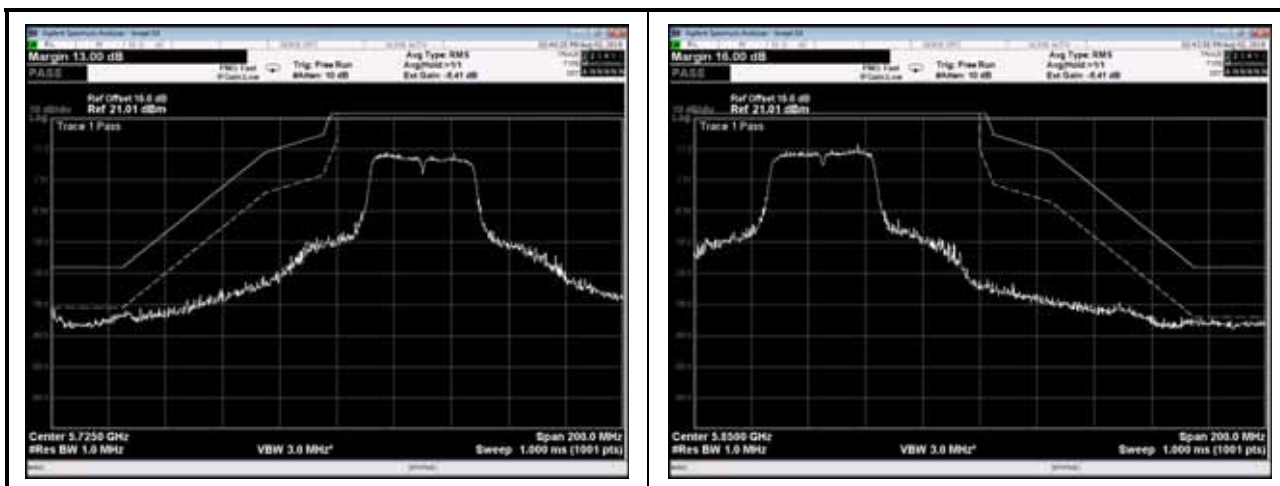



9.5.2 Straddle Channel

9.5.2.1 Authorized-Band Bandedge

Test Item	Bandedge Measurement
Test Engineer:	Chris
Test Date	2019-08-02

Test Mode	Channel No.	Freq. (MHz)	EIRP Band-edge (dBm/MHz)	EIRP Band-edge Limit (dBm/MHz)	Result
802.11a	144	5720	-43	≤ -27	Pass
	144	5720	-45	≤ -27	Pass
802.11n 20MHz	144	5720	-45	≤ -27	Pass
	144	5720	-44	≤ -27	Pass
802.11n 40MHz	142	5710	-44	≤ -27	Pass
	142	5710	-44	≤ -27	Pass

Note: EIRP Band-edge = EIRP Band-edge Limit – Margin.



802.11a Authorized-band band-edge

Channel 144 (5720MHz)

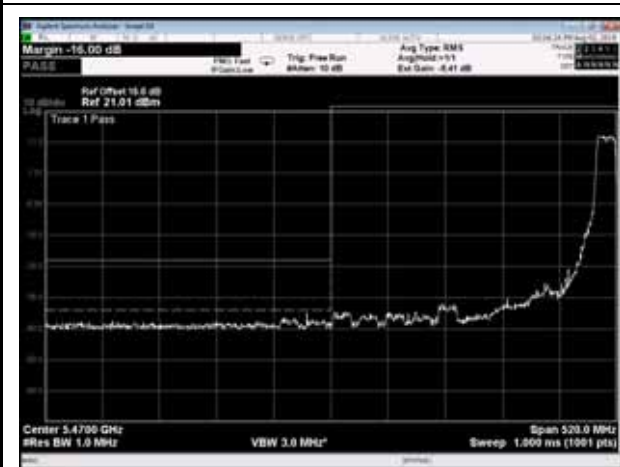

Channel 144 (5720MHz)





802.11n(20MHz) Authorized-band band-edge

Channel 144 (5720MHz)

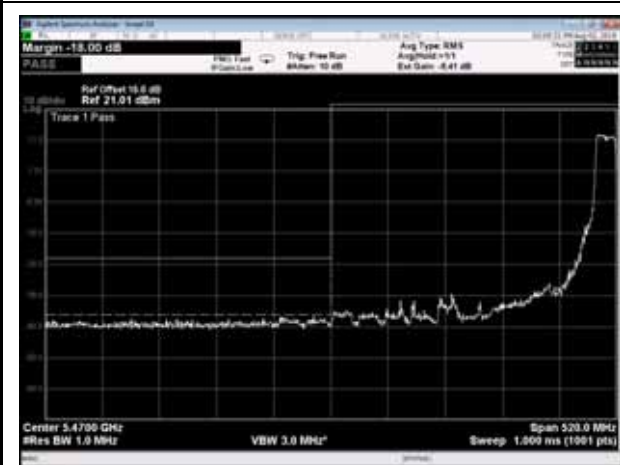

Channel 144 (5720MHz)

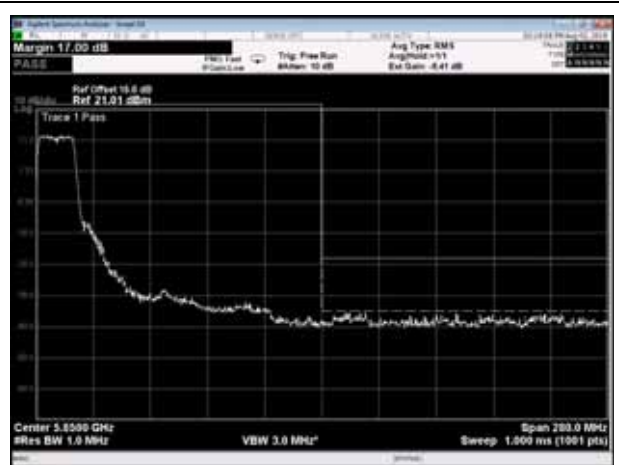



802.11n(40MHz) Authorized-band band-edge

Channel 142 (5710MHz)

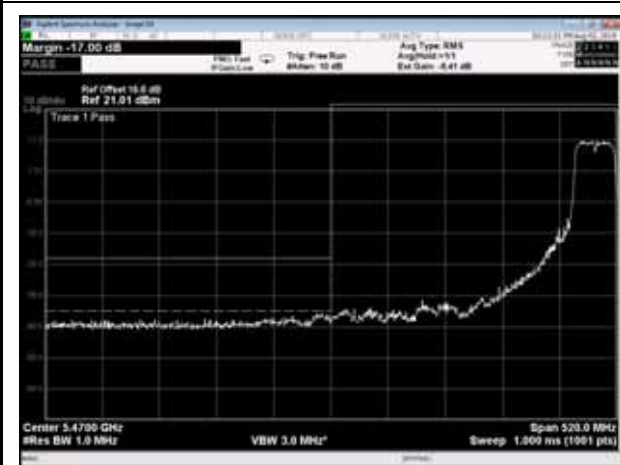

Channel 142 (5710MHz)

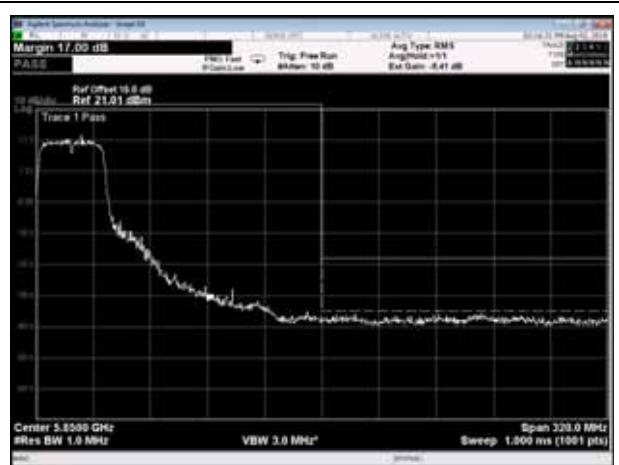

***** END OF REPORT *****