

User's Manual

R00

Trademarks

All brand and product names are trademarks or registered trademarks of their respective companies.

Note

The information in this manual is subject to change without notice.



Table of Contents

1	Getting Started	1
1.1	Understanding Hardware Components.....	1
	Front Components	1
	Back Components.....	2
	Right-side Components.....	2
	Top Components.....	3
	Bottom Components	3
1.2	Performing the Initial Start Up.....	4
1.3	Using Your Device in a Vehicle.....	5
	Using the Device Holder	5
	Connecting the Car Charger	5
	Connecting the TMC Antenna.....	6
1.4	Operating Basics.....	7
	Turning On and Off	7
	Navigating on the Screen.....	7
	Home Screen	7
1.5	Inserting a SD/MMC Card.....	9
2	Pictures	11
2.1	Starting and Exiting Pictures.....	11
2.2	Preparing the Pictures for Your Device.....	11
2.3	Viewing Pictures in Thumbnail View	12
2.4	Viewing a Picture in Full Screen	12
2.5	On-Screen Control Buttons.....	13
2.6	Viewing the Slideshow	15
3	Settings	17
3.1	Starting and Exiting Settings.....	17
3.2	Backlight.....	18
3.3	Volume	19
3.4	Screen	20
3.5	Power	21
3.6	Date&Time	22

3.7	Change Language.....	23
3.8	Bluetooth	24
4	Bluetooth HF Phone	25
4.1	About Bluetooth HF Phone	25
4.2	Pairing with a Mobile Phone.....	25
4.3	Placing a Call	28
	Keypad	28
	Call History	28
4.4	Operations during a Call	29
4.5	Receiving a Call	30
4.6	Miscellaneous Buttons	30
	Connect.....	31
	Pair Mode.....	31
	Bluetooth Manager.....	32
	Exit	32
5	Bluetooth Manager	33
5.1	About Bluetooth Manager	33
5.2	Starting and Exiting Bluetooth Manager	33
5.3	Turning On/Off Bluetooth Radio.....	34
5.4	Exploring Devices	35
5.5	Using My Shortcuts	37
5.6	Viewing Active Connections.....	38
5.7	Configuring Bluetooth Settings.....	39
6	ActiveSync	41
6.1	About ActiveSync	41
	Installing ActiveSync	41
	Using ActiveSync	43
7	Troubleshooting and Maintenance	45
7.1	Reset and Restart	45
	Reset Your System	45
	Restarting Your Device	46
7.2	Troubleshooting	46
	Power Problems.....	46
	Screen Problems.....	46
	Connection Problems.....	47
	GPS Problems.....	47
7.3	Maintaining Your Device	47

8	Regulatory Information	49
8.1	Regulations Statements	49
	FCC Regulatory information / Disclaimers	49
	European Notice	50
8.2	Safety Precautions	51
	About Charging	51
	About the Charger	51
	About the Battery	51
	Additional Information	52



Warnings and Notices

- For your safety, do not operate the controls of the product while driving.
- Use this product with caution. The product is a navigation aid. It does not provide exact measurements of direction, distance, location or topography.
- The calculated route is for reference only. Always follow the posted traffic signs, speed limits and road restrictions.
- When you leave your car, do not leave your device on the dashboard in direct sunlight. This can cause the battery to overheat and malfunction.
- The Global Positioning System (GPS) is operated by the United States government, which is solely responsible for its performance. Any change to the GPS system can affect the accuracy of all GPS equipment world-wide.
- GPS satellite signals cannot typically pass through solid materials (except glass). GPS location information is not typically available inside buildings, tunnels, or underground parking lots.
- A minimum of 4 GPS satellite signals is needed to calculate your GPS position. Signal reception can be affected by weather events or overhead obstacles (e.g. dense foliage and tall buildings).
- Other wireless devices in the vehicle may interfere with the reception of satellite signals and cause the reception to be unstable.

- A device holder is needed when using the device in a car. Be sure to place the device in an appropriate place, so as not to obstruct the driver's view, or deployment of airbags.

Do not mount where the driver's field of vision is blocked.

Do not place on the dashboard unsecured.

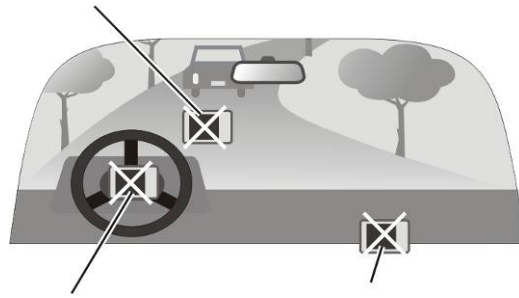

Do not mount in front of airbag panels.

Do not mount in front of an airbag field of deployment.

1

Getting Started

1.1 Understanding Hardware Components

NOTE: Depending upon the specific model purchased, the color of your device may not exactly match the device shown in this manual.

Front Components

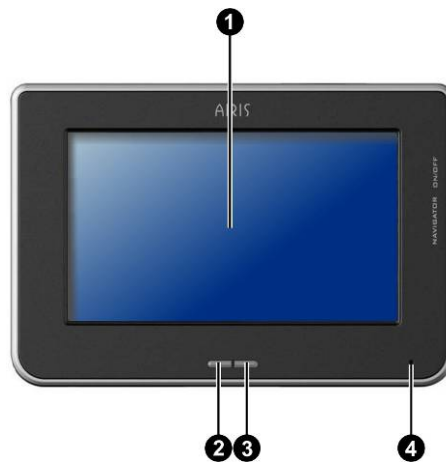

Ref	Component	Description
①	Touch Screen	Displays the output of your device. Tap the screen with your stylus to select menu commands or enter information.
②	Bluetooth Indicator	Flashes in blue to indicate that Bluetooth is on.
③	Charge Indicator	Glow bright amber to indicate that the battery is charging, and turns green when the battery is fully charged.
④	Microphone	For Bluetooth hands-free calling.

Back Components



Ref	Component	Description
①	Speaker	Sends out music, sounds and voice.
②	Stylus	Tap the touch screen to make selections and enter information. Pull the stylus out of its slot to use it, and store it in the slot when not in use.

Right-side Components

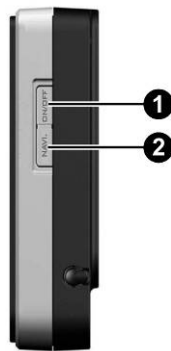

Ref	Component	Description
①	Power Button	Turns on and off the device.
②	Navigation Button	Starts the navigation software.

Top Components



Ref	Component	Description
①	External Antenna Connector	This connector (under rubber dust cover) allows use of an optional external GPS antenna with magnetic mount, which may be positioned on top of the car for better GPS signal reception in areas with poor reception.
②	SD/MMC Slot	Accepts a SD (Secure Digital) or MMC (MultiMediaCard) card for accessing data such as pictures.

Bottom Components



Ref	Component	Description
①	ON/OFF Switch	The main power/battery cutoff switch.
②	Headphone/TMC Connector	Connects to stereo headphones or the TMC (Traffic Message Channel) antenna for receiving TMC information.
③	Mini-USB Connector	Connects to the charger or USB cable.

1.2 Performing the Initial Start Up

1. Using a pointed pen, slide the ON/OFF switch to the ON position.

⚠ **CAUTION:** Always leave the ON/OFF switch in the ON position for normal operation



2. Your device turns on.
3. The Home screen appears. You can now use your device.



1.3 Using Your Device in a Vehicle

Using the Device Holder

CAUTION:

- Select an appropriate location for the device holder. Never place the holder where the driver's field of vision is blocked.
- If the car's windshield is tinted with a reflective coating, an external antenna (optional) may be needed to route the antenna to the top of the car through a window. When closing the car window, be careful not to pinch the antenna cable.

Use the device holder to fix your device in a vehicle. Make sure that the GPS antenna has a clear view of the sky.



Connecting the Car Charger

The car charger supplies power to your device when you are using the device in a car.

CAUTION: To protect your device against sudden surges in current, connect the car charger only after the car engine has been started.

1. Connect one end of the car charger to the power connector of your device.
2. Connect the other end to the cigarette lighter in the car to power and charge your device. The indicator on the car charger lights in green to indicate that power is being supplied to your device.



To Cigarette L

CAUTION: For optimal performance of the lithium battery:

- Do not charge the battery where the temperature is high (e.g. in direct sunlight).
- There is no need to fully discharge the battery before charging. You can charge the battery before it is discharged.
- When storing the product for a long period of time, be sure to fully charge the battery at least once every two weeks. Over discharge of the battery can affect the charging performance.

NOTE: Your device can also be charged when it is connected to a desktop computer via the USB cable. If you intend to charge your device in this way, turn off your device so that it takes less time to charge the battery.

Connecting the TMC Antenna

TMC antenna allows you to receive radio transmissions that are used to inform drivers of traffic, weather, and other driving conditions.

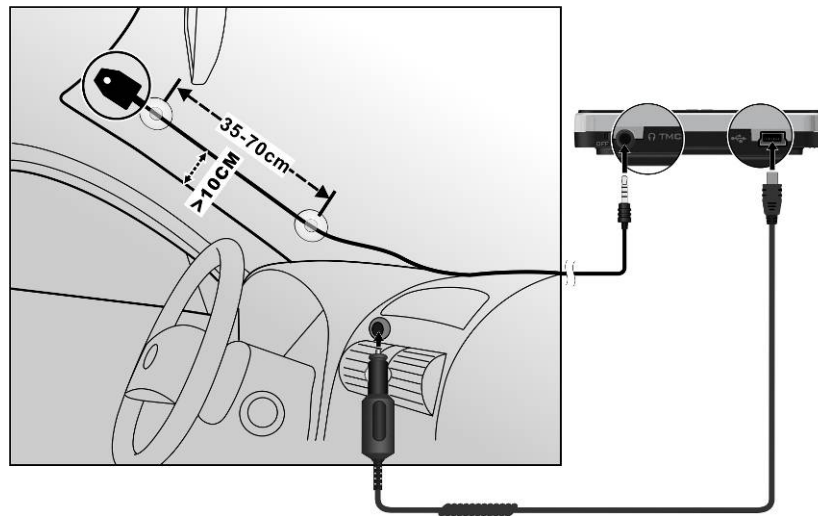

TMC information is monitored by the navigation software. Once the information is received, you can view it on your device and traffic icons will appear in the map view. Certain roads with reported traffic will be highlighted and you can choose to avoid those roads and an alternate route will be automatically calculated. (See the navigation software manual for detailed information.)

1.4 Operating Basics

Turning On and Off

For normal operation, turn off the device by briefly pressing the power button. The device enters a suspended state.

When you next briefly press the power button, the system resumes. You will either be back to where you left off or see the Home screen.

Navigating on the Screen

To operate your device, touch the screen with your stylus. You can perform the following actions:

- **Tap**
Touch the screen once with your stylus to open items or select onscreen buttons or options.
- **Drag**
Hold your stylus on the screen and drag up/down/left/right or across the screen.
- **Tap and hold**
Tap and hold your stylus until an action is complete, or a result or menu is shown.



Home Screen

The first time you initialize your device, the Home screen appears. The Home screen is your starting place for various tasks. Tap a button to start a task or open another menu.



Button Name	Description	For Detailed Information
Navigation	Starts the navigation software.	See the manual supplied with the software.
Pictures	Displays pictures (.jpg, .gif, and .bmp formats).	Chapter 2
Settings	Customizes the system settings.	Chapter 3

1.5 Inserting a SD/MMC Card

Your device has a SD/MMC slot where you can insert an optional Secure Digital or MultiMediaCard storage card.

To use a SD/MMC card, insert it into the slot, with the connector pointing to the slot and its label facing the front of the device.



To remove a card, first make sure that no application is accessing the card, then slightly push the top edge of the card to release it and pull it out of the slot.

NOTE:

- Make sure that no foreign objects enter the slot.
- Keep a SD or MMC card in a well-protected box to avoid dust and humidity when you are not using it.

2 Pictures

2.1 Starting and Exiting Pictures

Pictures allows you to view pictures in JPEG, GIF and BMP formats and view the slideshow of the pictures on your device.

Tap the Pictures button on the Home screen to start the program.



To exit the program, tap  .

2.2 Preparing the Pictures for Your Device

Before using the program, have the JPEG/GIF/BMP files ready on either your device's flash memory or on a storage card. Use ActiveSync to copy files from your computer to the correct location. (See Chapter 6 for information.)

2.3 Viewing Pictures in Thumbnail View

1. If your files are in a storage card, insert the card into your device.
2. Tap the Pictures button on the Home screen to start the program.
3. The program will search the matching files in the specific folder on your device and in all folders on a storage card. It then displays the pictures in the thumbnail view. You can press the Up or Down arrow button to go to next or previous page.

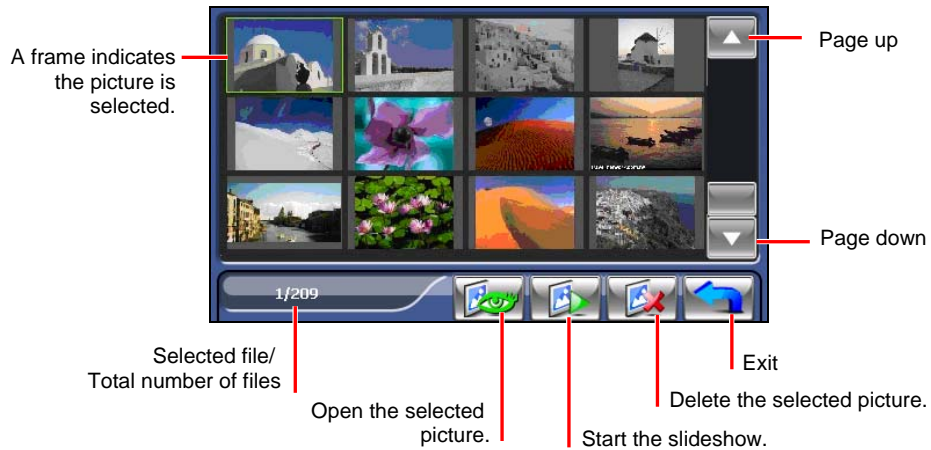

2.4 Viewing a Picture in Full Screen

When you tap a picture twice in the thumbnail view, the picture is displayed in full screen.

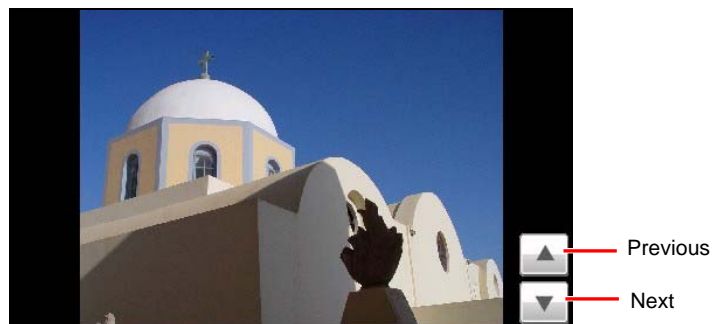





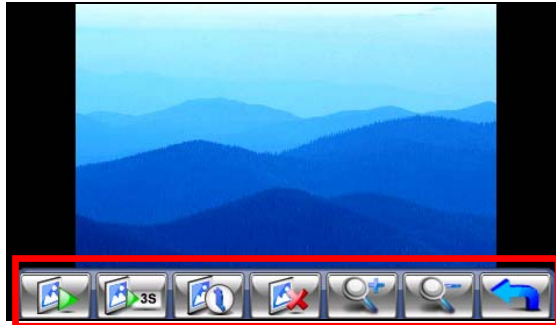

To go back to the thumbnail view, tap anywhere on the screen to display the control buttons and then tap .

2.5 On-Screen Control Buttons

On-screen control buttons provide various functions and settings. Tap anywhere on the picture to display the buttons as shown below. To close the buttons, tap the picture again.



Control Button	Name	Description
	Slideshow	Starts the slideshow. (See section 2.6 for detailed information.)
	Interval	Sets the length of time each slide is displayed before moving on to the next slide. Tap the button to switch to the next available option.  1 second  3 seconds  5 seconds
	Information	Enables or disables the displaying of the name and date of the file.

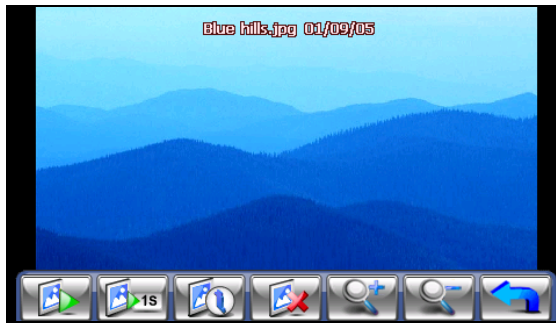

Delete

Deletes the current picture.



Zoom

Opens the zoom bar.



Tap the button as many times as needed to zoom in to 1.2x, 1.5x, 1.8x, or 2.0x. When you have zoomed in the picture, you can drag the picture to view other parts of the picture.

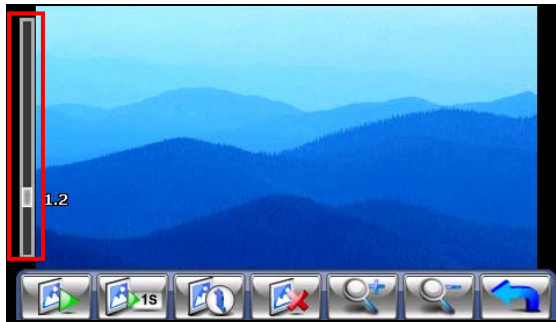

To close the zoom bar, tap .



Back

Goes back to the thumbnail view.

2.6 Viewing the Slideshow

To view the slideshow of all your pictures, use one of the following ways:

- When in the thumbnail view, tap  to start the slideshow.



- When in full screen, tap anywhere on the picture to display the on-screen control buttons. Then tap  to start the slideshow.

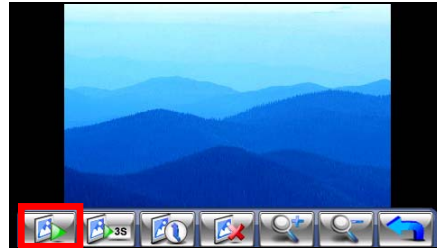

A small triangle at the lower left corner of the screen indicates that the slideshow is on. To stop the slideshow, tap anywhere on the screen.





3 Settings

3.1 Starting and Exiting Settings

You can customize the system settings such as backlight brightness, volume, and language. Once you change the settings, the new settings will remain until you change them again.

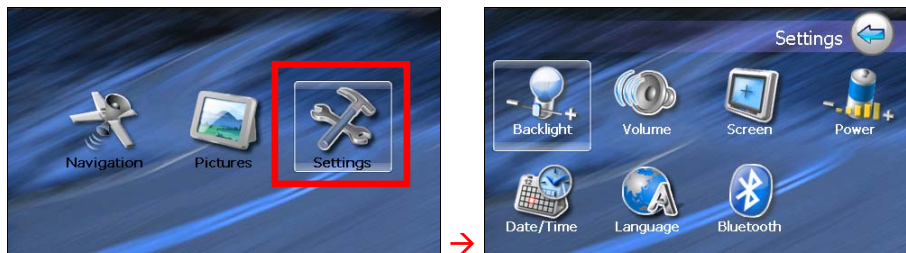
Tap the Settings button on the Home screen. The Settings menu appears as shown below.



To exit Settings, tap .

The following sections describe the various buttons and their functions.

3.2 Backlight

1. Tap the Settings button on the Home screen.
2. Tap the Backlight button.



3. Move the knob along the track bar to adjust the brightness of the backlight. To darken the backlight, move the knob to the left. To lighten the backlight, move the knob to the right.

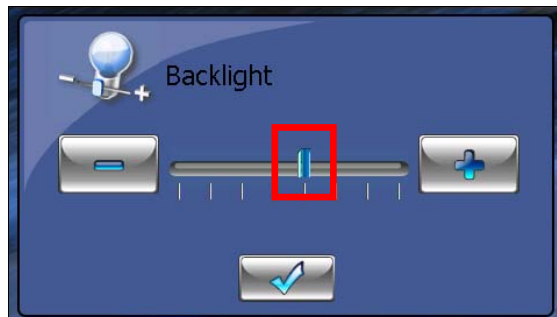

4. Tap  to save the changes.

3.3 Volume

1. Tap the Settings button on the Home screen.
2. Tap the Volume button.



3. Move the knob along the track bar to adjust the volume. To decrease the volume, move the knob to the left. To increase the volume, move the knob to the right.

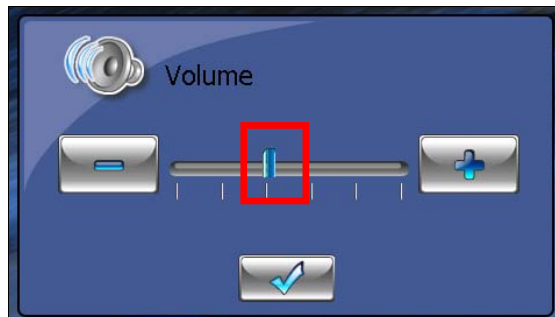

4. Tap  save the changes.

3.4 Screen

You can calibrate the touch screen if it is not responding accurately to your taps.

1. Tap the Settings button on the Home screen.
2. Tap the Screen button.



3. Tap  to start the calibration.



4. Tap and hold the centre of the target.
5. When the target moves to another position, tap and hold the centre of the new target. Repeat each time to complete the calibration process.
6. When completed, tap .

3.5 Power

To check the remaining power level of your battery and/or set up the power saving feature:

1. Tap the Settings button on the Home screen.
2. Tap the Power button.



3. The screen shows the remaining power of your battery.

You can set a timer to automatically turn off your device when it is idle for a set period of time. The options include **Never**, **30 minutes**, **20 minutes**, and **10 minutes**.



4. Tap  to save the changes.

3.6 Date&Time

1. Tap the Settings button on the Home screen.
2. Tap the Date&Time button.





3. To change the time zone, tap the left/right arrow in the “Time Zone” item.

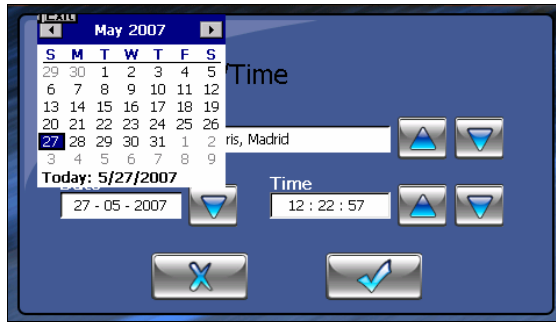

4. To change the date, tap the down arrow in the “Date” item. A calendar pops up. Tap the left arrow on the calendar to go to the earlier month and year or the right arrow to the later month and year. Alternatively, you can tap the month or year on top of the calendar to directly change the month or year.

When the calendar shows the current month, tap the date on the calendar.



5. To set the time, first tap the hour, minute, or second in the “Time” item and then tap the up arrow to increase or down arrow to decrease the value.
6. Tap  to save the changes.

3.7 Change Language

1. Tap the Settings button on the Home screen.
2. Tap the Change Language button.



3. Tap the left/right arrow button to select the desired language.

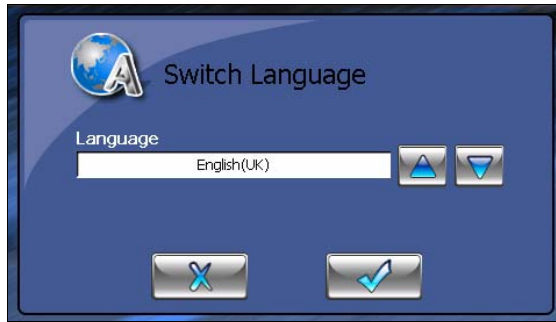

4. Tap  to save the changes.

3.8 Bluetooth

1. Tap the Settings button on the Home screen.
2. Tap the Bluetooth button.

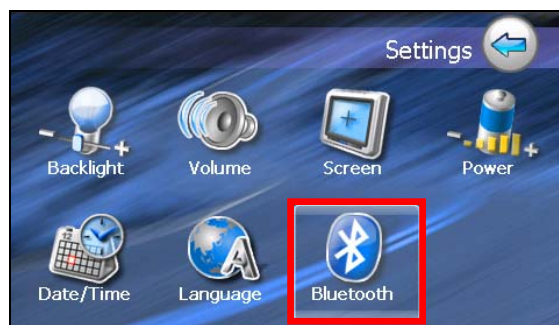

3. See the next two chapters for detailed information on using Bluetooth® connectivity.

4

Bluetooth HF Phone

4.1 About Bluetooth HF Phone

Your device can serve as a hands-free (HF) device for a Bluetooth mobile phone. After establishing the Bluetooth connection, you can tap your device to place and receive phone calls instead of picking up the mobile phone, and can use the built-in speakers and microphone for your conversation.

4.2 Pairing with a Mobile Phone

1. Tap the Settings button on the Home screen and then the Bluetooth button. The Bluetooth radio turns on.

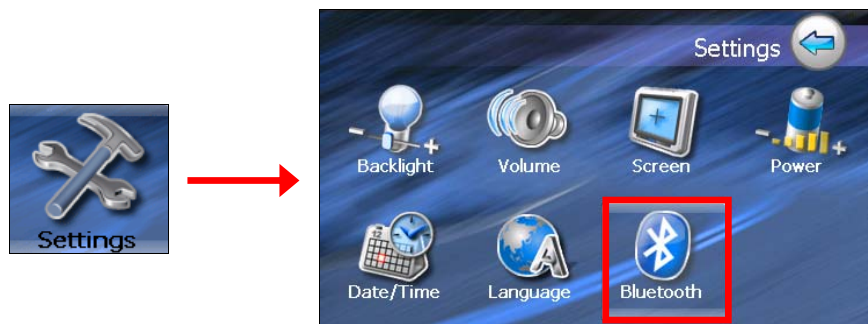



NOTE: The below procedure describes the scenario when you initiate the Bluetooth connection from your mobile phone. You can also initiate the Bluetooth connection from your device. (See section 5.4 for information.)

2. When the Keypad screen appears, you can dial a phone number. The connection with a Bluetooth mobile phone is required. (See the following steps for information.)

Or, you can tap  to go to the Bluetooth HF Phone main screen.

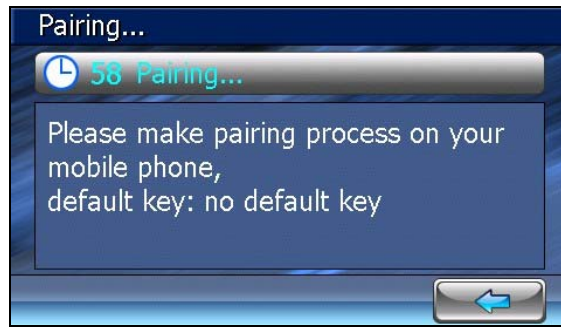
3. If this is the first time you use the program, your device will switch to Pair Mode and wait for the pairing action from your mobile phone for 60 seconds. The connection will be established as long as you initiate the pairing process on your mobile phone within this period.



4. If prompted to enter the passkey, tap the passkey specified by the mobile phone and tap .

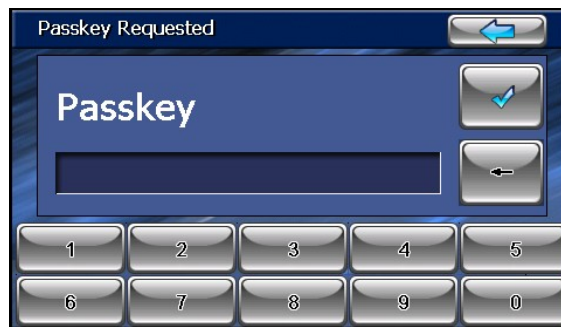

5. You will see the Bluetooth HF Phone main screen after the pairing is completed. The status bar at the bottom shows the name of the mobile phone connected.

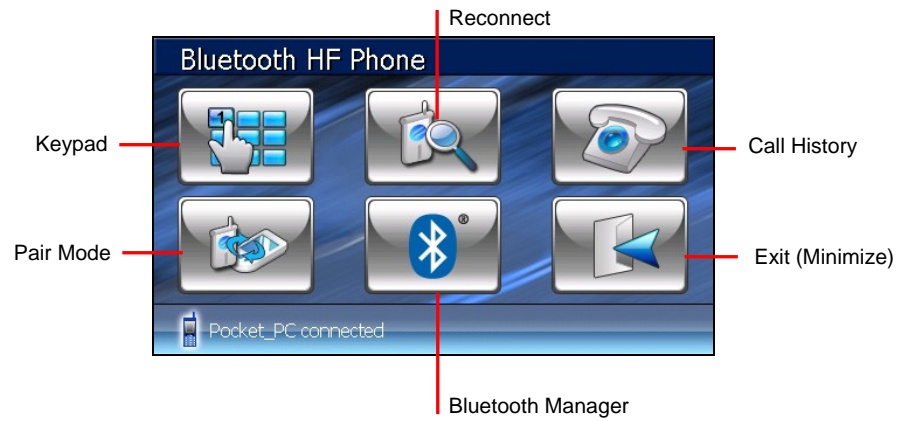

The next time you run the program, your device will automatically search and pair with one of the last connected mobile phones.



NOTE:

- Your device must be in Pair Mode for the mobile phone to discover your device. If you need to manually set your device to Pair Mode, tap Pair Mode on the main screen.
- Some mobile phones can automatically connect the hands-free service.
- Up to 8 sets of paired mobile phones can be stored. A 9th paired mobile phone will replace the oldest one.
- The Bluetooth HF Phone program cannot access the data such as the phone book and call history stored in a connected mobile phone.

4.3 Placing a Call

After pairing with your mobile phone, you can place a call using the Keypad or Call History button on the Bluetooth HF Phone main screen.

Keypad

By tapping the  Keypad button on the Bluetooth HF Phone main screen, you can enter the telephone number with the onscreen keypad. After entering the telephone number, tap  to place the call.



NOTE:



- International calls require a country code to be included in the phone number. On your device, the country code is separated from the rest of the number sequence by a plus (+) sign. If you are making an international call, tap and hold the * key until the + sign appears.
- To delete the last digit entered, tap the **Backspace** button.

Call History

NOTE: Bluetooth HF Phone cannot access the call history stored in a connected mobile phone.

Tap the  Call History button on the Bluetooth HF Phone main screen to display the recent incoming, outgoing, or missed calls together with information such as date, time, and duration of each call.



Tap the respective button (incoming , outgoing , or missed ) to view the last 20 calls of the selected type.



With an item selected, you can tap  to dial the number or  to delete the item.

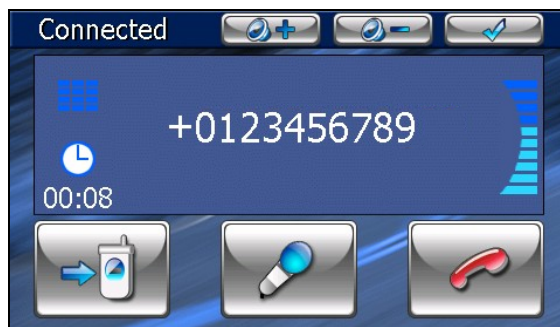

To clear all items in the current list, tap .

4.4 Operations during a Call



During a phone call:

- If you need to input other numbers, such as an extension number, tap  to open the keypad and tap the digits. The keypad will close when you tap the button again or when there has been no input for 5 seconds.
- Tap  to mute your sound so that the other party cannot hear you. To end the mute mode, tap the same button again.

- Tap  to end the call.
- Tap  to switch the call to your mobile phone. To switch back to your device, tap the same button again.

4.5 Receiving a Call

When you have a call after pairing with a mobile phone, the device rings and displays the Incoming Call screen.



To accept the call, tap .

To reject the call, tap .

To mute the ring tone before receiving or rejecting, tap .

4.6 Miscellaneous Buttons

In addition to buttons for placing a call, there are **Connect**, **Pair Mode**, **Bluetooth Manager**, and **Exit** buttons on the Bluetooth HF Phone main screen as described below.

Connect

By tapping the  Connect button on the Bluetooth HF Phone main screen, you can manually search the last paired mobile phones for an available connection.

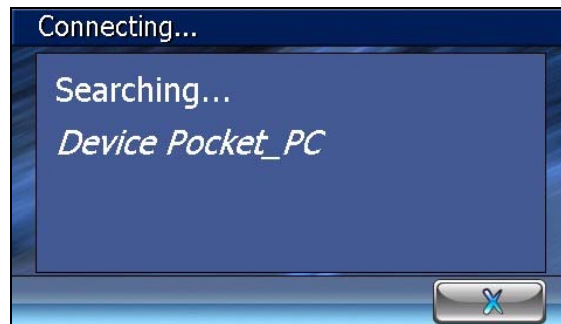

Pair Mode

By tapping the  Pair Mode button on the Bluetooth HF Phone main screen, you can manually set your device to Pair Mode. Within the duration of 60 seconds, you can initiate the pairing process on your mobile phone to discover your device as a hands-free device.

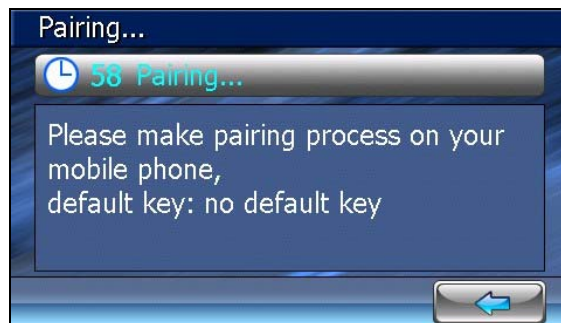

Bluetooth Manager



By tapping the  Bluetooth Manager button on the Bluetooth HF Phone main screen, you can run the Bluetooth Manager program. (See Chapter 5 for information on Bluetooth Manager.)

Exit



To hide the Bluetooth HF Phone screen, tap the  Exit button on the Bluetooth HF Phone main screen. Bluetooth HF Phone is still running in the background

■ **NOTE:** To know how to turn off Bluetooth radio, see section 5.3.

5

Bluetooth Manager

5.1 About Bluetooth Manager

Your device incorporates Bluetooth wireless communications technology. Devices with Bluetooth capabilities can exchange information over a distance of about 10 meters (30 feet) without requiring a physical connection.

Bluetooth Manger allows you to configure and use the Bluetooth capabilities of your device.

5.2 Starting and Exiting Bluetooth Manager

- 1 Tap the Settings button on the Home screen and then the Bluetooth button.

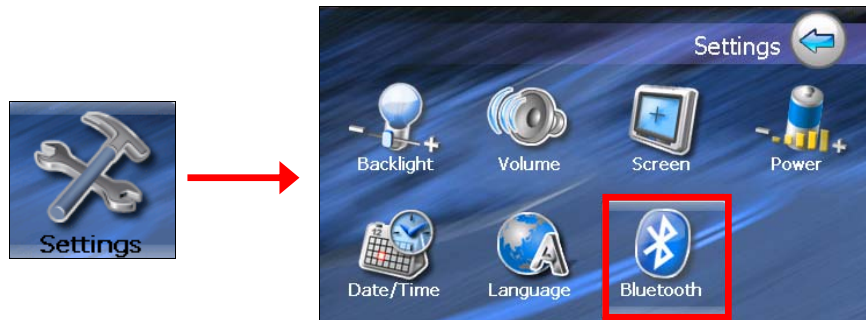

- 2 When the Bluetooth HF Phone screen appears, tap .



3 The Bluetooth Manager screen appears as shown below.



4 To exit the program, tap . You will be back to the Bluetooth HF Phone screen.

5.3 Turning On/Off Bluetooth Radio

Whenever you start Bluetooth Manager, Bluetooth radio is turned on. The Bluetooth indicator on your device flashed in blue.

Exiting Bluetooth Manager doesn't turn off Bluetooth radio. To turn off Bluetooth radio, tap  in the Bluetooth Manager screen. The flashing Bluetooth indicator goes off.

5.4 Exploring Devices

NOTE: To use the service of a remote device with Bluetooth capability, make sure that the remote device is in discoverable mode.

- 1 Start Bluetooth Manager as described in section 5.2.
- 2 Tap Explore a Bluetooth Device to search for nearby devices.



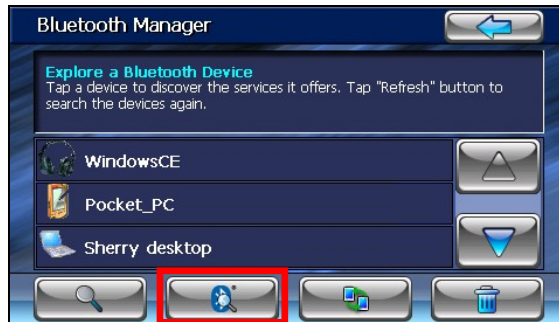

- 3 The device list appears on the screen. Tap the target device and tap  to browse the services of the device.

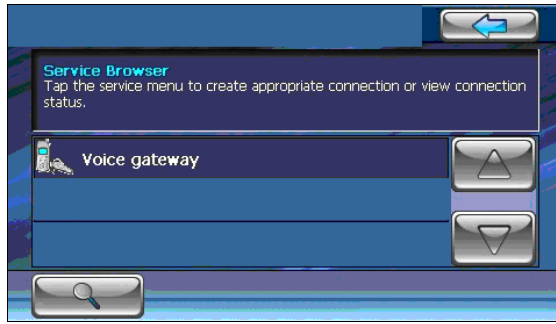

NOTE: You can also tap the  button to pair with the selected device before browsing its services.

- 4 Tap the service you want to use.



- 5 When prompted to enter the passkey, tap the passkey requested by the target device and tap .

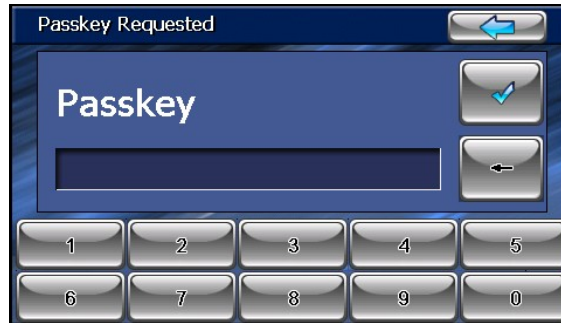

NTOE: Once you have established a Bluetooth connection with a remote device, it will be saved as a shortcut. You can then use My Shortcuts to conveniently use the same service again. (See section 5.6 for information.)

5.5 Using My Shortcuts

Once you have established a Bluetooth connection with a remote device, it will be saved as a shortcut. My Shortcuts allows you to conveniently use the same service again by tapping the particular shortcut item.

- 1 Start Bluetooth Manager as described in section 5.2.
- 2 Tap My Shortcuts.



- 3 Tap the desired item and tap  to establish a connection again.



5.6 Viewing Active Connections

After starting Bluetooth Manager, tap  to view the active connections. After you tap an item, you can tap  to disconnect the selected device.

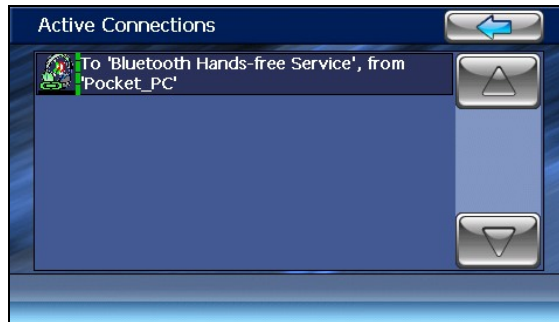

5.7 Configuring Bluetooth Settings

After starting Bluetooth Manager, tap  to configure Bluetooth settings.

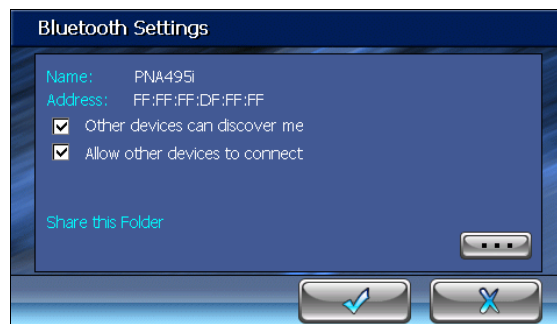

The available options are:

- **Other devices can discover me**
- **Allow other devices to connect**
- **Share this Folder**

Tap  to specify the folder to share with the remote device.

NOTE: When you transfer picture files to your device via Bluetooth connection, the files are transferred to this shared folder. Unless the files are in the correct location for the **Pictures** program, the **Pictures** program cannot detect them.

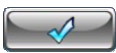
Tap  to save any changes you have made.

6

ActiveSync

6.1 About ActiveSync

ActiveSync allows you to establish the connection between your device and computer.

CAUTION: During ActiveSync installation, do not connect your device to your computer before the message on the screen asks you to.

Installing ActiveSync

- 1 Turn on your computer and your device.
- 2 Insert the provided DVD into the DVD drive of your computer. The auto run screen appears.



- 3 Click the **Install** button in the **ActiveSync** section. The installation wizard will start automatically. Follow the onscreen instructions to finish the installation. A status window indicates the progress of the installation.



- 4 When prompted, connect the mini-USB end of the USB cable to your device and the other end to a USB port on your computer.



- 5 When the “Set up partnership” screen appears, select **No** and **Next** to connect as a guest device.

NOTE: This device does not support synchronization with your computer. Therefore, you do not need to set up a partnership.

Using ActiveSync

Once ActiveSync is installed on your computer, you can use it to transfer files (i.e. pictures files) between your device and your computer.

CAUTION: Be discreet when you delete files from your device. Deleting files of which the function is unknown can cause programs or features to malfunction.

Whenever you connect your device to your computer with the USB cable, the “Set up partnership” screen appears. Always select **No** and **Next** to connect as a guest device. Then you can use the **Explorer** function to browse the mobile device and transfer data. (See the **ActiveSync** online Help for instructions on copying files.)

7

Troubleshooting and Maintenance

7.1 Reset and Restart

Reset Your System

Occasionally, you may need to reset your device. For example, you should reset your system when it stops responding; or appears to be “frozen” or “locked up.”

You can use the following steps to perform a “hard reset.”

1. Disconnect all cables, including the charger, from your device.
2. Use a pointed pen to slide the ON/OFF switch to the OFF position.
3. Wait for 1 minute and then slide the switch back to the ON position.

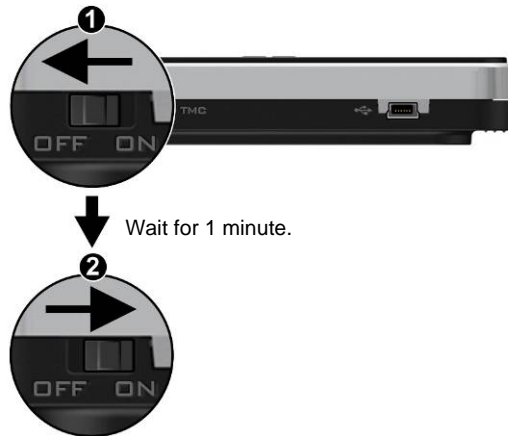

Restarting Your Device

To restart your device, press the power button for 1 second until the “Power Off Selection” screen appears and then tap Restart.

7.2 Troubleshooting

NOTE: If you encounter a problem you cannot solve, contact an authorized service center for assistance.

Power Problems

Power does not turn on when using battery power

- The remaining battery power may be too low to run your device. Charge the battery.

Screen Problems

Screen responds slowly

- Make sure that your device is not running out of battery power. If the problem still exists, reset your system.

Screen freezes

- Reset your system.

Screen is hard to read

- Make sure that the backlight of the display is on.
- Move to a location with more light.

Inaccurate response to taps

- Recalibrate the touch screen.

Connection Problems

Cable Connection Problems

- Make sure that your device and your computer are both turned on before trying to establish a connection.
- Make sure that the cable is securely plugged into the USB port on your computer and on the device. Connect the USB cable directly to your computer—do not run the cable through a USB hub.
- Reset your device before connecting the cable. Always disconnect your device before you restart your computer.

GPS Problems

- When there are no valid signals available, consider the following:
- Make sure that the GPS antenna has a clear view of the sky.
- Note that the GPS reception can be affected by:
 - ✓ Bad weather
 - ✓ Dense overhead obstacles (e.g. trees and tall buildings)
 - ✓ Other wireless device in the car
 - ✓ Reflective car window tint

7.3 Maintaining Your Device

Taking good care of your device will ensure trouble-free operation and reduce the risk of damage to your device.

- Keep your device away from excessive moisture and extreme temperatures.
- Avoid exposing your device to direct sunlight or strong ultraviolet light for extended periods of time.
- Do not place anything on top of your device or drop objects on your device.
- Do not drop your device or subject it to severe shock.
- Do not subject your device to sudden and severe temperature changes. This could cause moisture condensation inside the unit, which could damage your

device. In the event of moisture condensation, allow the device to dry out completely before use.

- Take care not to sit on the device. We advise not to carry the device in one's back pocket for that reason.
- The screen surface can easily be scratched. Avoid touching it with sharp objects. Non-adhesive generic screen protectors designed specifically for use on portable devices with LCD panels may be used to help protect the screen from minor scratches.
- Never clean your device with it powered on. Use a soft, lint-free cloth moistened with water to wipe the screen and the exterior of your device.
- Do not use paper towels to clean the screen.
- Never attempt to disassemble, repair or make any modifications to your device. Disassembly, modification or any attempt at repair could cause damage to your device and even bodily injury or property damage and will void any warranty.
- Do not store or carry flammable liquids, gases or explosive materials in the same compartment as your device, its parts or accessories.

8

Regulatory Information

NOTE: Marking labels located on the exterior of your device indicate the regulations that your model complies with. Please check the marking labels on your device and refer to the corresponding statements in this chapter. Some notices apply to specific models only.

8.1 Regulations Statements

FCC Regulatory information / Disclaimers

Installation and use of this Portable Navigator must be in strict accordance with the instructions included in the user documentation provided with the product. Any changes or modifications (including the antennas) made to this device that are not expressly approved by the manufacturer may void the user's authority to operate the equipment. The manufacturer is not responsible for any radio or television interference caused by unauthorized modification of this device, or the substitution of the connecting cables and equipment other than manufacturer specified. It is the responsibility of the user to correct any interference caused by such unauthorized modification, substitution or attachment. Manufacturer and its authorized resellers or distributors will assume no liability for any damage or violation of government regulations arising from failing to comply with these guidelines.

This device complies with Part 15 of the FCC Rules. Operation is subject to the following two conditions:

- This device may not cause harmful interference.
- This device must accept any interference received, including interference that may cause undesired operation.

European Notice

Products with the CE marking comply with Radio & Telecommunication Terminal Equipment Directive (R&TTE) (1999/5/EEC), the Electromagnetic Compatibility Directive (89/336/EEC) and the Low Voltage Directive (73/23/EEC) – as amended by Directive 93/68/ECC - issued by the Commission of the European Community.

Compliance with these directives implies conformity to the following European Standards:

EN301489-1&EN301489-19: Electronic compatibility and Radio spectrum Matters (ERM), ElectroMagnetic Compatibility (EMC) standard for radio equipment and services;

Part 1: Common technical requirements

EN55022: Radio disturbance characteristics

EN55024: Immunity characteristics

EN6100-3-2: Limits for harmonic current emissions

EN6100-3-3: Limitation of voltage fluctuation and flicker in low-voltage supply system

EN60950 / IEC 60950: Product Safety

EN300328: Electromagnetic compatibility and Radio spectrum matters (ERM); Wideband transmission systems; Data transmission equipment operating in the 2.4GHz ISM band and using wide band modulation techniques; Harmonized EN covering essential requirements under article 3.2 of the R&TTE Directive
The manufacturer cannot be held responsible for modifications made by the User and the consequences thereof, which may alter the conformity of the product with the CE Marking.



8.2 Safety Precautions

- Prolonged listening of music in maximum volume can damage the ears.
- The use of headphones other than those recommended/supplied can cause hearing impairment due to excessive sound pressure.

About Charging

- Use only the charger supplied with your device. Use of another type of charger will result in malfunction and/or danger.
- This product is intended to be supplied by a LISTED Power Unit marked with “LPS”, “Limited Power Source” and output rated + 5 V dc / 1.0 A”.
- Use a specified battery in the equipment.

About the Charger

- Do not use the charger in a high moisture environment. Never touch the charger when your hands or feet are wet.
- Allow adequate ventilation around the charger when using it to operate the device or charge the battery. Do not cover the charger with paper or other objects that will reduce cooling. Do not use the charger while it is inside a carrying case.
- Connect the charger to a proper power source. The voltage requirements are found on the product case and/or packaging.
- Do not use the charger if the cord becomes damaged.
- Do not attempt to service the unit. There are no serviceable parts inside. Replace the unit if it is damaged or exposed to excess moisture.

About the Battery

- Use a specified charger approved by the manufacturer.

CAUTION: This unit contains a non-replaceable internal Lithium Ion battery. The battery can burst or explode, releasing hazardous chemicals. To reduce the risk of fire or burns, do not disassemble, crush, puncture, or dispose of in fire or water.

- Important instructions (for service personnel only)

- ✓ **Caution:** Risk of explosion if battery is replaced by an incorrect type. Dispose of used batteries according to the instructions.
- ✓ Replace only with the same or equivalent type recommended by the manufacturer.
- ✓ The battery must be recycled or disposed of properly.
- ✓ Use the battery only in the specified equipment.

Additional Information



If you want to dispose this product, do not mix it with general household waste. There is a separate collection system for used electronic products in accordance with legislation that requires proper treatment, recovery and recycling.

