



FCC ID: P4Q-N653  
 Report No.: T210421W01-RP

IC: 2420C-N653  
 Ref. No.: T200407W01-RP5

Page: 1 / 26  
 Rev.: 00

**FCC 47 CFR PART 15 SUBPART C &  
 INDUSTRY CANADA RSS-210  
 Class II Permissive Change**

**TEST REPORT**

**For**

**PRO 8475**

**Model No.: N653**

**Trade Name: MiTAC, Webfleet Solutions**

Issued to

<b>FCC:</b>	<b>Mitac Digital Technology Corporation 4F., No. 1, R&amp;D Road 2, Hsinchu Science Park, Hsinchu 30076 Taiwan</b>
<b>IC:</b>	<b>MiTAC Digital Technology Corporation 4F., No. 1, R&amp;D Road 2, Hsinchu Science Park, Hsinchu 30076 Taiwan</b>

Issued by

**Compliance Certification Services Inc.  
 Wugu Laboratory  
 No.11, Wugong 6th Rd., Wugu Dist.,  
 New Taipei City, Taiwan. (R.O.C.)  
 Issued Date: June 2, 2021**

Unless otherwise stated the results shown in this test report refer only to the sample(s) tested and such sample(s) are retained for 90 days only.  
 除非另有說明，此報告結果僅對測試之樣品負責，同時此樣品僅保留90天。本報告未經本公司書面許可，不可部份複製。

This document is issued by the Company subject to its General Conditions of Service printed overleaf, available on request or accessible at <http://www.sgs.com.tw/Terms-and-Conditions> and, for electronic format documents, subject to Terms and Conditions for Electronic Documents at <http://www.sgs.com.tw/Terms-and-Conditions>. Attention is drawn to the limitation of liability, indemnification and jurisdiction issues defined therein. Any holder of this document is advised that information contained hereon reflects the Company's findings at the time of its intervention only and within the limits of client's instruction, if any. The Company's sole responsibility is to its Client and this document does not exonerate parties to a transaction from exercising all their rights and obligations under the transaction documents. This document cannot be reproduced, except in full, without prior written approval of the Company. Any unauthorized alteration, forgery or falsification of the content or appearance of this document is unlawful and offenders may be prosecuted to the fullest extent of the law.

### Revision History

Rev.	Issue Date	Revisions	Effect Page	Revised By
00	June 2, 2021	Initial Issue Note <sup>(01)</sup>	ALL	Allison Chen

**Note** <sup>(01)</sup>

- Applicant added new NFC antenna and verify radiated spurious emission test data.

## TABLE OF CONTENTS

<b>1.</b>	<b>TEST RESULT CERTIFICATION.....</b>	<b>4</b>
<b>2.</b>	<b>EUT DESCRIPTION.....</b>	<b>6</b>
<b>3.</b>	<b>TEST METHODOLOGY.....</b>	<b>7</b>
3.1	EUT CONFIGURATION.....	7
3.2	FCC PART 15.205 RESTRICTED BANDS OF OPERATIONS.....	7
3.3	RSS GEN SECTION 8.10 RESTRICTED BANDS OF OPERATIONS.....	8
3.4	DESCRIPTION OF TEST MODES.....	9
<b>4.</b>	<b>TEST SUMMARY.....</b>	<b>10</b>
<b>5.</b>	<b>INSTRUMENT CALIBRATION.....</b>	<b>11</b>
5.1	MEASURING INSTRUMENT CALIBRATION.....	11
5.2	MEASUREMENT EQUIPMENT USED.....	11
5.3	MEASUREMENT UNCERTAINTY.....	12
<b>6.</b>	<b>FACILITIES AND ACCREDITATIONS.....</b>	<b>13</b>
6.1	FACILITIES.....	13
6.2	EQUIPMENT.....	13
<b>7.</b>	<b>SETUP OF EQUIPMENT UNDER TEST.....</b>	<b>14</b>
7.1	SETUP CONFIGURATION OF EUT.....	14
7.2	SUPPORT EQUIPMENT.....	14
<b>8.</b>	<b>FCC PART 15.225 REQUIREMENTS &amp; RSS-210 REQUIREMENTS.....</b>	<b>15</b>
8.1	FUNDAMENTAL AND RADIATED EMISSIONS.....	15
	<b>APPENDIX A PHOTOGRAPHS OF TEST SETUP.....</b>	<b>A-1</b>
	<b>APPENDIX 1 - PHOTOGRAPHS OF EUT</b>	

## 1. TEST RESULT CERTIFICATION

**FCC Applicant:** Mitac Digital Technology Corporation  
4F., No. 1, R&D Road 2, Hsinchu Science Park, Hsinchu  
30076 Taiwan

**IC Applicant:** MiTAC Digital Technology Corporation  
4F., No. 1, R&D Road 2, Hsinchu Science Park, Hsinchu  
30076 Taiwan

**FCC Manufacturer:** MITAC COMPUTER (KUNSHAN) CO., LTD.  
No. 269, 2nd Avenue, District A, Comprehensive Free Trade  
Zone, Kunshan, Jiangsu, P.R. China

**IC Manufacturer:** MITAC COMPUTER (KUNSHAN) CO., LTD.  
No. 269, 2nd Rd, Export Processing Zone Changjiang South  
Road Kushan, Jiangsu China (Peoples Republic Of)

**Equipment Under Test:** PRO 8475

**Trade Name:** MiTAC, Webfleet Solutions

**Model No.:** N653

**Date of Test:** May 6, 2021

APPLICABLE STANDARDS	
STANDARD	TEST RESULT
FCC 47 CFR Part 15 Subpart C & RSS-210 Issue 10 and RSS-GEN Issue 5	No non-compliance noted
Statements of Conformity	
Determination of compliance is based on the results of the compliance measurement, not taking into account measurement instrumentation uncertainty.	

**We hereby certify that:**

The above equipment was tested by Compliance Certification Services Inc. The test data, data evaluation, test procedures, and equipment configurations shown in this report were made in accordance with the procedures given in ANSI C63.10: 2013 and the energy emitted by the sample tested as described in this report is in compliance with the requirements of FCC Rules Part 15.225.

The test results of this report relate only to the tested sample identified in this report.

Approved by:



---

Kevin Tsai  
Deputy Manager  
Compliance Certification Services Inc.

## 2. EUT DESCRIPTION

<b>Product</b>	PRO 8475
<b>Model No.</b>	N653
<b>Model Discrepancy</b>	Difference of the those trade names (list on this report) are just for marketing purpose only.
<b>Trade</b>	MiTAC, Webfleet Solutions
<b>Received Date</b>	April 21, 2021
<b>Power Supply</b>	1. Powered from Rechargeable Li-ion Polymer Battery. Rating: 3.7VDC, 4000mAh, 14.8Wh 2. Powered from Cradle Fleet cable 12/24V (Pogo power pin) USB Type-C 5V
<b>Frequency Range</b>	13.56MHz
<b>Modulation Technique</b>	ASK
<b>Number of Channels</b>	1 Channel
<b>Antenna Requirement</b>	Antenna type: Integral

**Remark:**

1. The sample selected for test was engineering sample that approximated to production product and was provided by manufacturer.
2. Disclaimer: Antenna information is provided by the applicant, test results of this report are applicable to the sample EUT received.

### 3. TEST METHODOLOGY

The tests documented in this report were performed in accordance with ANSI C63.10: 2013 and FCC CFR 47 Part 15.207, 15.209, 15.225.

The tests documented in this report were performed in accordance with IC RSS-210, IC RSS-Gen, and ANSI C63.10: 2013

#### 3.1 EUT CONFIGURATION

The EUT configuration for testing is installed on RF field strength measurement to meet the Commissions requirement and operating in a manner that intends to maximize its emission characteristics in a continuous normal application.

#### 3.2 FCC PART 15.205 RESTRICTED BANDS OF OPERATIONS

(a) Except as shown in paragraph (d) of this section, only spurious emissions are permitted in any of the frequency bands listed below:

MHz	MHz	MHz	GHz
0.090 - 0.110	16.42 - 16.423	399.9 - 410	4.5 - 5.15
<sup>1</sup> 0.495 - 0.505	16.69475 - 16.69525	608 - 614	5.35 - 5.46
2.1735 - 2.1905	16.80425 - 16.80475	960 - 1240	7.25 - 7.75
4.125 - 4.128	25.5 - 25.67	1300 - 1427	8.025 - 8.5
4.17725 - 4.17775	37.5 - 38.25	1435 - 1626.5	9.0 - 9.2
4.20725 - 4.20775	73 - 74.6	1645.5 - 1646.5	9.3 - 9.5
6.215 - 6.218	74.8 - 75.2	1660 - 1710	10.6 - 12.7
6.26775 - 6.26825	108 - 121.94	1718.8 - 1722.2	13.25 - 13.4
6.31175 - 6.31225	123 - 138	2200 - 2300	14.47 - 14.5
8.291 - 8.294	149.9 - 150.05	2310 - 2390	15.35 - 16.2
8.362 - 8.366	156.52475 -	2483.5 - 2500	17.7 - 21.4
8.37625 - 8.38675	156.52525	2655 - 2900	22.01 - 23.12
8.41425 - 8.41475	156.7 - 156.9	3260 - 3267	23.6 - 24.0
12.29 - 12.293	162.0125 - 167.17	3332 - 3339	31.2 - 31.8
12.51975 - 12.52025	167.72 - 173.2	3345.8 - 3358	36.43 - 36.5
12.57675 - 12.57725	240 - 285	3600 - 4400	( <sup>2</sup> )
13.36 - 13.41	322 - 335.4		

<sup>1</sup> Until February 1, 1999, this restricted band shall be 0.490-0.510 MHz.

<sup>2</sup> Above 38.6

(b) Except as provided in paragraphs (d) and (e), the field strength of emissions appearing within these frequency bands shall not exceed the limits shown in Section 15.209. At frequencies equal to or less than 1000 MHz, compliance with the limits in Section 15.209 shall be demonstrated using measurement instrumentation employing a CISPR quasi-peak detector. Above 1000 MHz, compliance with the emission limits in Section 15.209 shall be demonstrated based on the average value of the measured emissions. The provisions in Section 15.35 apply to these measurements.

### 3.3 RSS GEN SECTION 8.10 RESTRICTED BANDS OF OPERATIONS

Restricted frequency bands, identified in table 7, are designated primarily for safety-of-life services (distress calling and certain aeronautical activities), certain satellite downlinks, radio astronomy and some government uses. Except where otherwise indicated, the following conditions related to the restricted frequency bands apply:

- (a) The transmit frequency, including fundamental components of modulation, of licence-exempt radio apparatus shall not fall within the restricted frequency bands listed in table 7 except for apparatus compliant with RSS-287, Emergency Position Indicating Radio Beacons (EPIRB), Emergency Locator Transmitters (ELT), Personal Locator Beacons (PLB), and Maritime Survivor Locator Devices (MSLD).
- (b) Unwanted emissions that fall into restricted frequency bands listed in table 7 shall comply with the limits specified in table 5 and table 6.
- (c) Unwanted emissions that do not fall within the restricted frequency bands listed in table 7 shall comply either with the limits specified in the applicable RSS or with those specified in table 5 and table 6.

Table 7 – Restricted frequency bands <sup>Note 1</sup>			
MHz	MHz	MHz	GHz
0.090 - 0.110	16.42 - 16.423	608 - 614	9.0 - 9.2
0.495 - 0.505	16.69475 - 16.69525	960 - 1427	9.3 - 9.5
2.1735 - 2.1905	16.80425 - 16.80475	1435 - 1626.5	10.6 - 12.7
3.020 - 3.026	25.5 - 25.67	1645.5 - 1646.5	13.25 - 13.4
4.125 - 4.128	37.5 - 38.25	1660 - 1710	14.47 - 14.5
4.17725 - 4.17775	73 - 74.6	1718.8 - 1722.2	15.35 - 16.2
4.20725 - 4.20775	74.8 - 75.2	2200 - 2300	17.7 - 21.4
5.677 - 5.683	108 - 138	2310 - 2390	22.01 - 23.12
6.215 - 6.218	149.9 - 150.05	2483.5 - 2500	23.6 - 24.0
6.26775 - 6.26825	156.52475 -	2655 - 2900	31.2 - 31.8
6.31175 - 6.31225	156.52525	3260 - 3267	36.43 - 36.5
8.291 - 8.294	156.7 - 156.9	3332 - 3339	Above 38.6
8.362 - 8.366	162.0125 - 167.17	3345.8 - 3358	
8.37625 - 8.38675	167.72 - 173.2	3500 - 4400	
8.41425 - 8.41475	240 - 285	4500 - 5150	
12.29 - 12.293	322 - 335.4	5350 - 5460	
12.51975 - 12.52025	399.9 - 410	7250 - 7750	
12.57675 - 12.57725		8025 - 8500	
13.36 - 13.41			

**Note 1:** Certain frequency bands listed in table 7 and in bands above 38.6 GHz are designated for licence-exempt applications. These frequency bands and the requirements that apply to related devices are set out in the 200 and 300 series of RSSs.



### 3.4 DESCRIPTION OF TEST MODES

The EUT had been tested under engineering test mode condition and the EUT staying in continuous transmitting mode.

All modes and data rates were investigated and it was determined that ISO 14443A/B and ISO 18092 Type y, 106/212/424/848 kbps.

All data rates were investigated and it was determined that 106 Kbps was considered worst-case. Therefore, all testing was performed in 106 Kbps mode.

Radiated Emission Measurement Above 1G	
<b>Test Condition</b>	<b>Radiated Emission Above 1G</b>
<b>Power supply Mode</b>	<b>Mode 1: EUT power by Cradle+Power supply Mode 2: EUT power by Adapter</b>
<b>Worst Mode</b>	<input checked="" type="checkbox"/> Mode 1 <input type="checkbox"/> Mode 2 <input type="checkbox"/> Mode 3 <input type="checkbox"/> Mode 4
<b>Worst Position</b>	<input type="checkbox"/> Placed in fixed position. <input type="checkbox"/> Placed in fixed position at X-Plane (E2-Plane) <input type="checkbox"/> Placed in fixed position at Y-Plane (E1-Plane) <input checked="" type="checkbox"/> Placed in fixed position at Z-Plane (H-Plane)

Radiated Emission Measurement Below 1G	
<b>Test Condition</b>	<b>Radiated Emission Below 1G</b>
<b>Power supply Mode</b>	<b>Mode 1: EUT power by Cradle+Power supply Mode 2: EUT power by Adapter</b>
<b>Worst Mode</b>	<input checked="" type="checkbox"/> Mode 1 <input type="checkbox"/> Mode 2 <input type="checkbox"/> Mode 3 <input type="checkbox"/> Mode 4

Remark:

1. The worst mode was record in this test report.
2. EUT pre-scanned in three axis ,X,Y, Z and two polarity, for radiated measurement. The worst case(Z-Plane) were recorded in this report

## 4. TEST SUMMARY

FCC Standard Sec.	IC Standard Sec.	Chapter	Test Item	Result
15.203	RSS-GEN Sec. 8.3	2	Antenna Requirement	Pass
15.215	RSS-210	-	Occupied Bandwidth (99%) and 20dB Bandwidth	N/A
15.209	RSS-210	8.1	Radiated Emissions	Pass
15.225	RSS-210	-	Frequency Stability	N/A
15.207	RSS-GEN Sec. 8.8	-	AC Power-line Conducted Emission	N/A

## 5. INSTRUMENT CALIBRATION

### 5.1 MEASURING INSTRUMENT CALIBRATION

The measuring equipment, which was utilized in performing the tests documented herein, has been calibrated in accordance with the manufacturer's recommendations for utilizing calibration equipment, which is traceable to recognized national standards.

### 5.2 MEASUREMENT EQUIPMENT USED

#### Equipment Used for Emissions Measurement

3M 966 Chamber Test Site					
Equipment	Manufacturer	Model	S/N	Cal Date	Cal Due
Bilog Antenna	Sunol Sciences	JB3	A030105	07/24/2020	07/23/2021
Coaxial Cable	HUBER SUHNER	SUCOFLEX 104PEA	20995	02/24/2021	02/23/2022
Digital Thermo-Hygro Meter	WISEWIND	1206	D07	01/06/2021	01/05/2022
Loop Ant	COM-POWER	AL-130	121051	04/07/2021	04/06/2022
Pre-Amplifier	EMEC	EM330	060609	02/24/2021	02/23/2022
PSA Series Spectrum Analyzer	Agilent	E4446A	MY46180323	07/24/2020	07/23/2021
Antenna Tower	CCS	CC-A-1F	N/A	N.C.R	N.C.R
Controller	CCS	CC-C-1F	N/A	N.C.R	N.C.R
Turn Table	CCS	CC-T-1F	N/A	N.C.R	N.C.R
<b>Software</b>	e3 6.11-20180419c				

**Remark:**

1. Each piece of equipment is scheduled for calibration once a year.
2. N.C.R. = No Calibration Request.

### 5.3 MEASUREMENT UNCERTAINTY

PARAMETER	UNCERTAINTY
AC Powerline Conducted Emission	+/- 1.2575
Emission bandwidth, 20dB bandwidth	+/- 0.0014
RF output power, conducted	+/- 1.14
Power density, conducted	+/- 1.40
3M Semi Anechoic Chamber / 9K~30M	+/- 2.30
3M Semi Anechoic Chamber / 30M~200M	+/- 4.12
3M Semi Anechoic Chamber / 200M~1000M	+/- 4.68
3M Semi Anechoic Chamber / 1G~8G	+/- 5.18
3M Semi Anechoic Chamber / 8G~18G	+/- 5.47
3M Semi Anechoic Chamber / 18G~26G	+/- 3.81
3M Semi Anechoic Chamber / 26G~40G	+/- 3.87

**Remark:** This uncertainty represents an expanded uncertainty expressed at approximately the 95% confidence level using a coverage factor of k=2.

## 6. FACILITIES AND ACCREDITATIONS

### 6.1 FACILITIES

All measurement facilities used to collect the measurement data are located at

- No.199, Chunghsen Road, Hsintien City, Taipei Hsien, Taiwan, R.O.C.  
Tel: 886-2-2217-0894 / Fax: 886-2-2217-1029
- No.11, Wugong 6th Rd., Wugu Dist., New Taipei City, Taiwan. (R.O.C.)  
Tel: 886-2-2299-9720 / Fax: 886-2-2299-9721, ISED CAB number: 2324G

The sites are constructed in conformance with the requirements of ANSI C63.7, ANSI C63.10: 2013 and CISPR Publication 22.

### 6.2 EQUIPMENT

Radiated emissions are measured with one or more of the following types of linearly polarized antennas: tuned dipole, bucolical, log periodic, bi-log, and/or ridged waveguide, horn. Spectrum analyzers with pre-selectors and quasi-peak detectors are used to perform radiated measurements.

Conducted emissions are measured with Line Impedance Stabilization Networks and EMI Test Receivers.

Calibrated wideband preamplifiers, coaxial cables, and coaxial attenuators are also used for making measurements.

All receiving equipment conforms to CISPR Publication 16-1, "Radio Interference Measuring Apparatus and Measurement Methods."

## 7. SETUP OF EQUIPMENT UNDER TEST

### 7.1 SETUP CONFIGURATION OF EUT

See test photographs attached in Appendix A for the actual connections between EUT and support equipment.

### 7.2 SUPPORT EQUIPMENT

No.	Device Type	Brand	Model	Series No.	FCC ID
1	DC Power Source	Agilent	E3640A	N/A	N/A

**Remark:**

1. All the equipment/cables were placed in the worst-case configuration to maximize the emission during the test.
2. Grounding was established in accordance with the manufacturer's requirements and conditions for the intended use.

## 8. FCC PART 15.225 REQUIREMENTS & RSS-210 REQUIREMENTS

### 8.1 FUNDAMENTAL AND RADIATED EMISSIONS

#### LIMIT

According to §15.225

- (a) The field strength of any emissions within the band 13.553 – 13.567 MHz shall not exceed 15,848 microvolts / meter at 30 meters.
- (b) Within the bands 13.410 – 13.553 MHz and 13.567 -13.710 MHz, the field strength of any emissions shall not exceed 334 microvolts / meter at 30 meters.
- (c) Within the bands 13.110 – 13.410 MHz and 13.710 – 14.010 MHz the field strength of any emissions shall not exceed 106 microvolts / meter at 30 meters.
- (d) The field strength of any emissions appearing outside of the 13.110 – 14.010 MHz and shall not exceed the general radiated emission limits in §15.209.

According to §15.225, except as provided elsewhere in this Subpart, the emissions from an intentional radiator shall not exceed the field strength levels specified in the following table:

Frequency (MHz)	Field Strength (µV/m at meter)	Measurement Distance (meter)
0.009 – 0.490	2400 / F (kHz)	300
0.490 – 1.705	24000 / F (kHz)	30
1.705 – 30.0	30	30
30 - 88	100**	3
88-216	150**	3
216-960	200**	3
Above 960	500	3

\*\* Except as provided in paragraph (g), fundamental emissions from intentional radiators operating under this Section shall not be located in the frequency bands 54-72 MHz, 76-88 MHz, 174-216 MHz or 470-806 MHz. However, operation within these frequency bands is permitted under other sections of this Part, e.g., Sections 15.231 and 15.241.

Report No.: T210421W01-RP

Ref. No.: T200407W01-RP5

According to RSS 210 §B.6

The field strength of any emission shall not exceed the following limits:

- (a) 15.848 mV/m (84 dBµV/m) at 30 m, within the band 13.553-13.567 MHz;
- (b) 334 µV/m (50.5 dBµV/m) at 30 m, within the bands 13.410-13.553 MHz and 13.567-13.710 MHz;
- (c) 106 µV/m (40.5 dBµV/m) at 30 m, within the bands 13.110-13.410 MHz and 13.710-14.010 MHz; and
- (d) RSS-Gen general field strength limits for frequencies outside the band 13.110-14.010 MHz.

### **Below 30 MHz**

Frequency	Magnetic field strength (H-Field) (µA/m)	Measurement Distance (metres)
9-490 kHz <sup>Note 1</sup>	6.37/F (F in kHz)	300
490-1,705 kHz	63.7/F (F in kHz)	30
1.705-30 MHz	0.08	30

Note 1: The emission limits for the ranges 9-90 kHz and 110-490 kHz are based on measurements employing a linear average detector.

### **Above 30 MHz**

Frequency	Field strength (µV/m at 3 m)
30-88	100
88-216	150
216-960	200
Above 960	500



## Test Configuration

### 9kHz ~ 30MHz

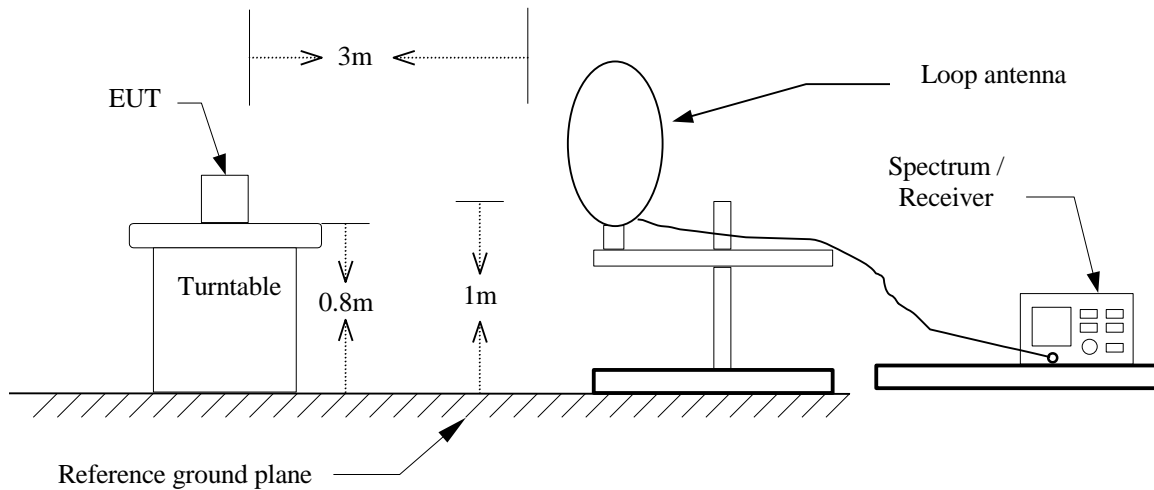

### 30MHz ~ 1GHz

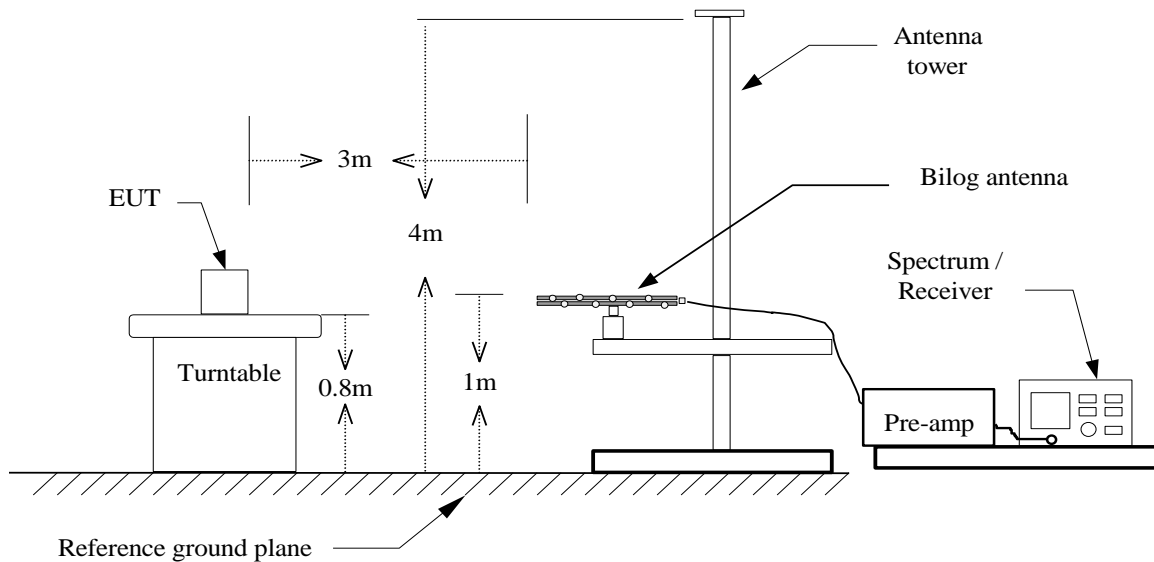

## **TEST PROCEDURE**

### **For 9kHz ~ 30MHz**

1. The EUT is placed on a turntable, which is 0.8m above ground plane.
2. The turntable shall be rotated for 360 degrees to determine the position of maximum emission level.
3. EUT is set 3m away from the receiving antenna, The center of the loop shall be 1 m above the ground then to find out the highest emissions.
4. Maximum procedure was performed on the six highest emissions to ensure EUT compliance.
5. Set the spectrum analyzer in the following setting as:  
9KHz-490KHz : RBW=200Hz / VBW=1kHz / Sweep=AUTO  
490KHz-30MHz : RBW=10kHz / VBW=30kHz / Sweep=AUTO
6. Repeat above procedures until the measurements for all frequencies are complete.

### **For 30MHz ~ 1GHz**

1. The EUT is placed on a turntable, which is 0.8m above ground plane.
2. The turntable shall be rotated for 360 degrees to determine the position of maximum emission level.
3. EUT is set 3m away from the receiving antenna, which is varied from 1m to find out the highest emissions.
4. Maximum procedure was performed on the six highest emissions to ensure EUT compliance.
5. And also, each emission was to be maximized by changing the polarization of receiving antenna both horizontal and vertical.
6. Set the spectrum analyzer in the following setting as:  
RBW=100kHz / VBW=300kHz / Sweep=AUTO
7. Repeat above procedures until the measurements for all frequencies are complete.

### **Remark :**

Although these tests were performed other than open area test site, adequate comparison measurements were confirmed against 30 m open are test site. Therefore sufficient tests were made to demonstrate that the alternative site produces results that correlate with the ones of tests made in an open field based on KDB 414788.

Report No.: T210421W01-RP

Ref. No.: T200407W01-RP5

Operation Mode: TX mode

Test Date: May 6, 2021

Temperature: 22.6°C

Tested by: Ray Li

Humidity: 56 % RH

Polarity: Ver.

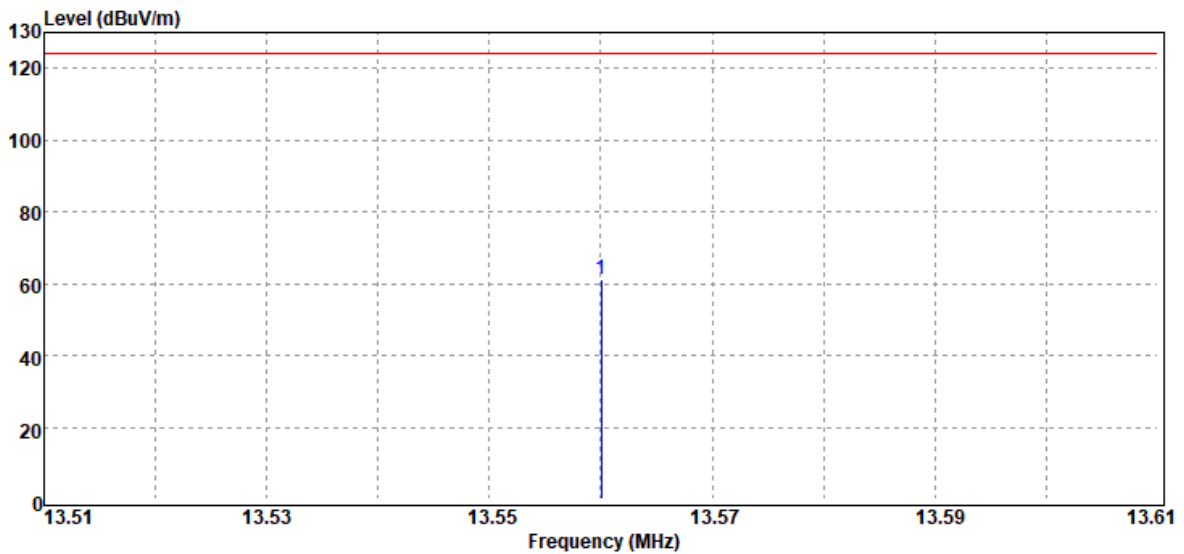

No.	Freq. MHz	Detector Mode PK/QP/AV	Spectrum Reading Level dB $\mu$ V	Factor dB	Actual FS dB $\mu$ V/m	Limit @3m dB $\mu$ V/m	Margin dB
1	13.56	Peak	45.18	15.91	61.09	124.00	-62.91

**Remark:**

1. Radiated emissions measured were made with an instrument using peak/quasi-peak/average detector mode.
2. Measurements above show only up to 6 maximum emissions noted, or would be lesser, with " N/A " remark, if no specific emissions from the EUT are recorded (ie: margin>20dB from the applicable limit) and considered that's already beyond the background noise floor.
3. Margin (dB) = Result (dBuV/m) – Limit (dBuV/m).
4. 9kHz to 490kHz Limit (@3m) = 2400(F/kHz)+ 40\*Log (300 meters/3 meters)  
490kHz to 1.705MHz Limit (@3m) = 2400(F/kHz)+ 40\*Log (30 meters/3 meters)  
1.705MHz to 30MHz Limit (@3m) = 30 + 40\*Log (30 meters/3 meters)

Report No.: T210421W01-RP

Ref. No.: T200407W01-RP5

Operation Mode: TX mode

Test Date: May 6, 2021

Temperature: 22.6°C

Tested by: Ray Li

Humidity: 56 % RH

Polarity: Hor.

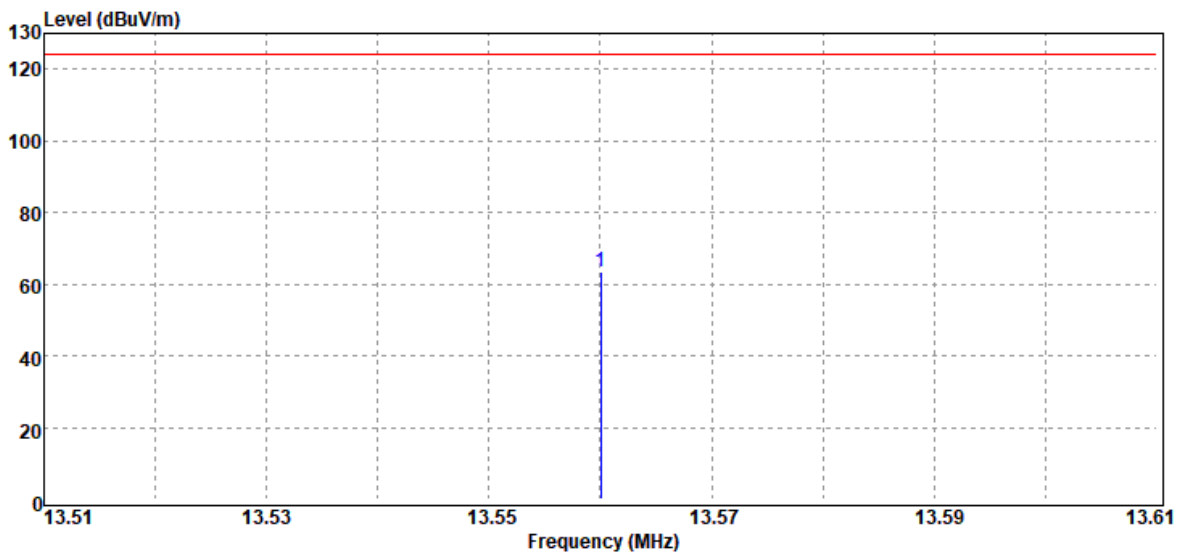

No.	Freq. MHz	Detector Mode PK/QP/AV	Spectrum Reading Level dBµV	Factor dB	Actual FS dBµV/m	Limit @3m dBµV/m	Margin dB
1	13.56	Peak	47.62	15.91	63.53	124.00	-60.47

**Remark:**

1. Radiated emissions measured were made with an instrument using peak/quasi-peak/average detector mode.
2. Measurements above show only up to 6 maximum emissions noted, or would be lesser, with " N/A " remark, if no specific emissions from the EUT are recorded (ie: margin>20dB from the applicable limit) and considered that's already beyond the background noise floor.
3. Margin (dB) = Result (dBuV/m) – Limit (dBuV/m).
4. 9kHz to 490kHz Limit (@3m) = 2400(F/kHz)+ 40\*Log (300 meters/3 meters)  
490kHz to 1.705MHz Limit (@3m) = 2400(F/kHz)+ 40\*Log (30 meters/3 meters)  
1.705MHz to 30MHz Limit (@3m) = 30 + 40\*Log (30 meters/3 meters)

Report No.: T210421W01-RP

Ref. No.: T200407W01-RP5

**Test Result of Mask**

<b>Operation Mode:</b>	TX mode	<b>Test Date:</b>	May 6, 2021
<b>Temperature:</b>	22.6°C	<b>Tested by:</b>	Ray Li
<b>Humidity:</b>	56 % RH	<b>Polarity:</b>	Ver.

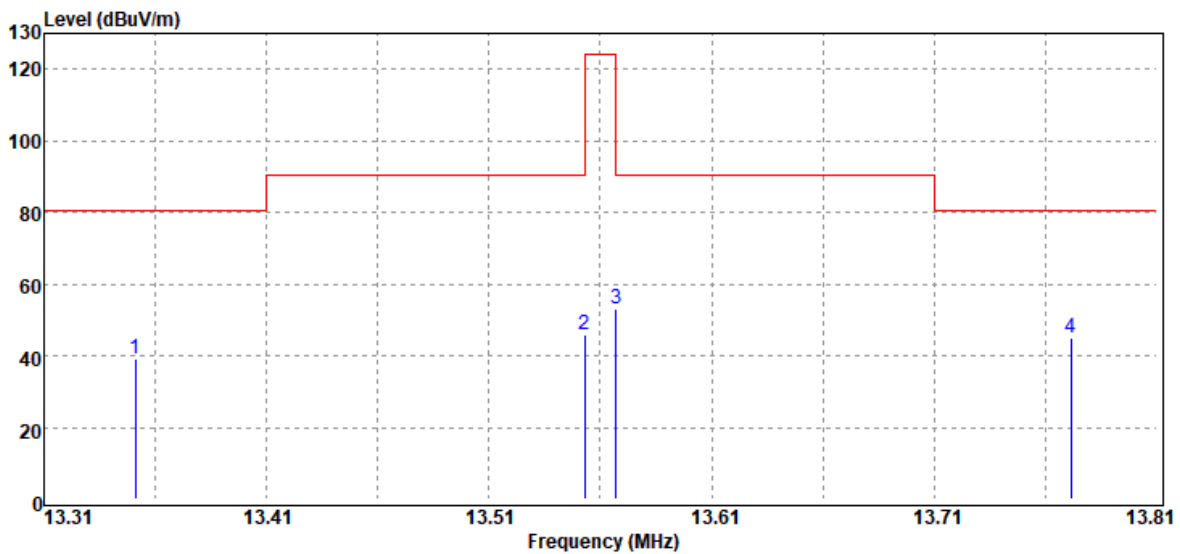

No.	Freq. MHz	Detector Mode PK/QP/AV	Spectrum Reading Level dB $\mu$ V	Factor dB	Actual FS dB $\mu$ V/m	Limit @3m dB $\mu$ V/m	Margin dB
1	13.35	Peak	23.34	15.92	39.26	80.54	-41.28
2	13.55	Peak	30.12	15.91	46.03	90.47	-44.44
3	13.57	Peak	37.37	15.91	53.28	90.47	-37.19
4	13.77	Peak	29.30	15.90	45.20	80.50	-35.30

**Remark:**

1. Radiated emissions measured were made with an instrument using peak/quasi-peak/average detector mode.
2. Measurements above show only up to 6 maximum emissions noted, or would be lesser, with " N/A " remark, if no specific emissions from the EUT are recorded (ie: margin>20dB from the applicable limit) and considered that's already beyond the background noise floor.
3. Margin (dB) = Result (dBuV/m) – Limit (dBuV/m).
4. 9kHz to 490kHz Limit (@3m) = 2400(F/kHz)+ 40\*Log (300 meters/3 meters)  
490kHz to 1.705MHz Limit (@3m) = 2400(F/kHz)+ 40\*Log (30 meters/3 meters)  
1.705MHz to 30MHz Limit (@3m) = 30 + 40\*Log (30 meters/3 meters)

Report No.: T210421W01-RP

Ref. No.: T200407W01-RP5

Rev.: 00

### Test Result of Mask

**Operation Mode:** TX mode

**Test Date:** May 6, 2021

**Temperature:** 22.6°C

**Tested by:** Ray Li

**Humidity:** 56 % RH

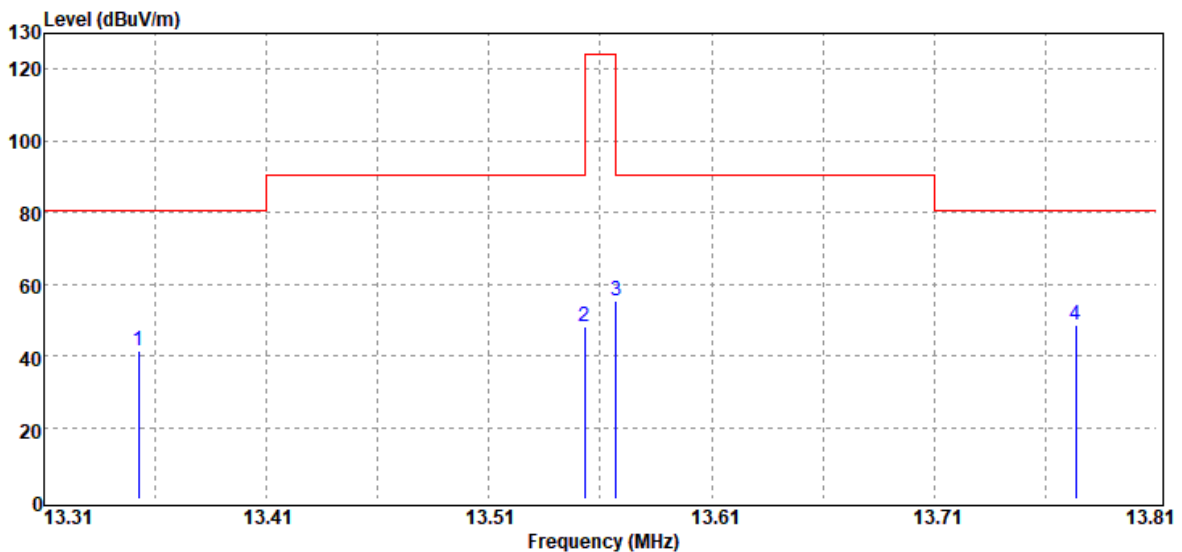
**Polarity:** Hor.

No.	Freq. MHz	Detector Mode PK/QP/AV	Spectrum Reading Level dB $\mu$ V	Factor dB	Actual FS dB $\mu$ V/m	Limit @3m dB $\mu$ V/m	Margin dB
1	13.35	Peak	25.44	15.92	41.36	80.54	-39.18
2	13.55	Peak	32.01	15.91	47.92	90.47	-42.55
3	13.57	Peak	39.58	15.91	55.49	90.47	-34.98
4	13.77	Peak	32.62	15.90	48.52	80.50	-31.98

#### Remark:

1. Radiated emissions measured were made with an instrument using peak/quasi-peak/average detector mode.
2. Measurements above show only up to 6 maximum emissions noted, or would be lesser, with " N/A " remark, if no specific emissions from the EUT are recorded (ie: margin>20dB from the applicable limit) and considered that's already beyond the background noise floor.
3. Margin (dB) = Result (dBuV/m) – Limit (dBuV/m).
4. 9kHz to 490kHz Limit (@3m) = 2400(F/kHz)+ 40\*Log (300 meters/3 meters)  
 490kHz to 1.705MHz Limit (@3m) = 2400(F/kHz)+ 40\*Log (30 meters/3 meters)  
 1.705MHz to 30MHz Limit (@3m) = 30 + 40\*Log (30 meters/3 meters)

Report No.: T210421W01-RP

Ref. No.: T200407W01-RP5

### 9kHz ~ 30MHz

**Operation Mode:** TX mode  
**Temperature:** 22.6°C  
**Humidity:** 56 % RH

**Test Date:** May 6, 2021  
**Tested by:** Ray Li  
**Polarity:** Ver.

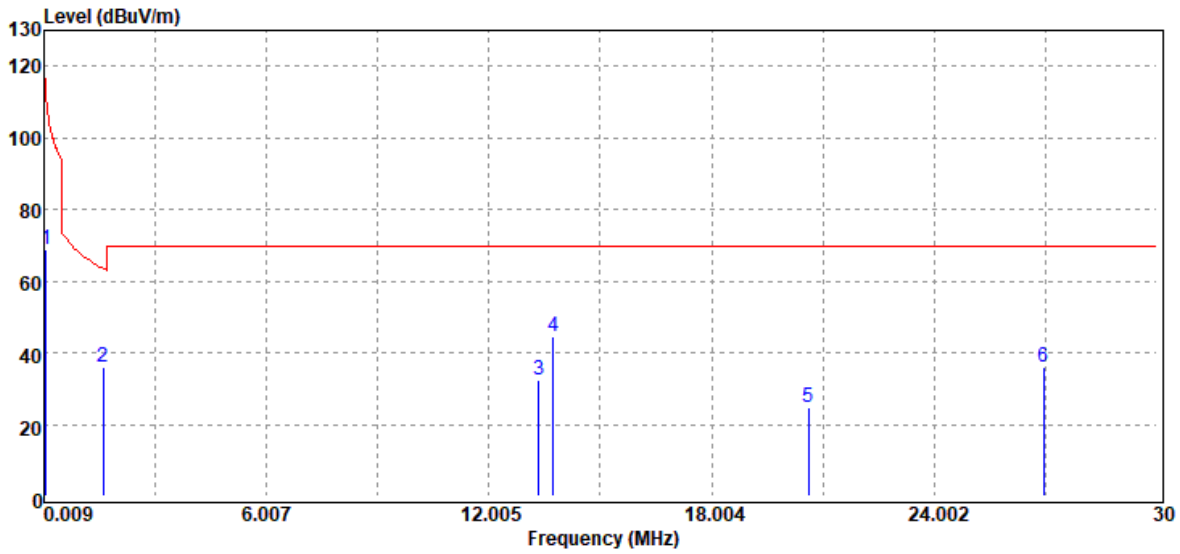

No.	Freq. MHz	Detector Mode PK/QP/AV	Spectrum Reading Level dB $\mu$ V	Factor dB	Actual FS dB $\mu$ V/m	Limit @3m dB $\mu$ V/m	Margin dB
1	0.07	Peak	54.91	13.84	68.75	110.83	-42.08
2	1.60	Peak	20.98	14.86	35.84	63.53	-27.69
3	13.36	Peak	16.46	15.92	32.38	69.54	-37.16
4	13.75	Peak	28.45	15.90	44.35	69.54	-25.19
5	20.61	Peak	9.32	15.44	24.76	69.54	-44.78
6	26.94	Peak	21.64	14.19	35.83	69.54	-33.71

**Remark:**

- 9kHz to 490kHz Limit(@3m) = 2400(F/kHz)+ 40\*Log (300 meters/3 meters)  
490kHz to 1.705MHz Limit (@3m) = 2400(F/kHz)+ 40\*Log (30 meters/3 meters)  
1.705MHz to 30MHz Limit (@3m) = 30 + 40\*Log (30 meters/3 meters)

Report No.: T210421W01-RP

Ref. No.: T200407W01-RP5

**Operation Mode:** TX mode  
**Temperature:** 22.6°C  
**Humidity:** 56 % RH

**Test Date:** May 6, 2021  
**Tested by:** Ray Li  
**Polarity:** Hor.

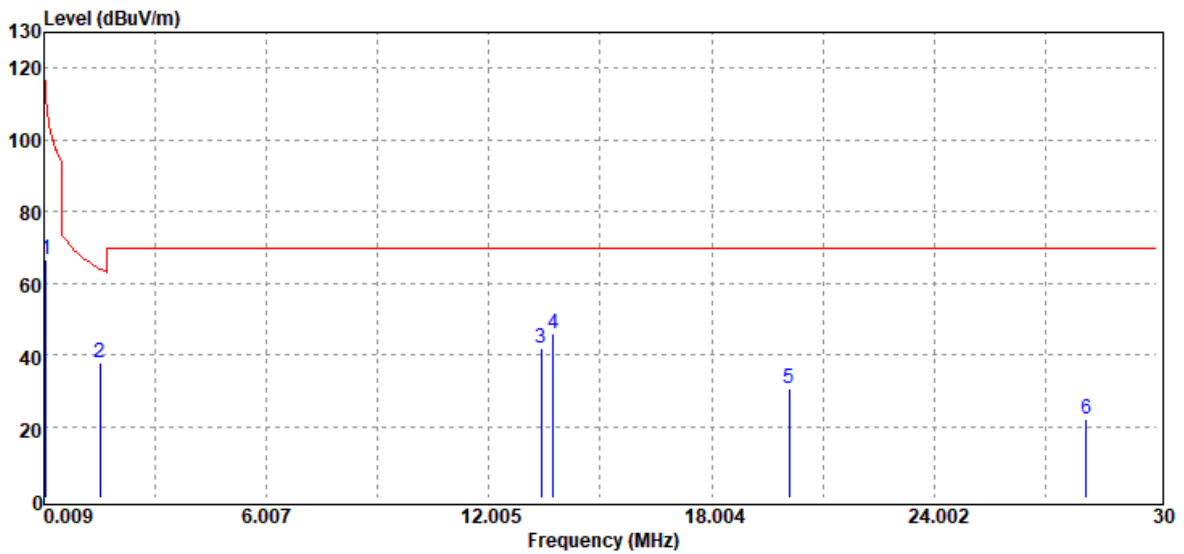

No.	Freq. MHz	Detector Mode PK/QP/AV	Spectrum Reading Level dB $\mu$ V	Factor dB	Actual FS dB $\mu$ V/m	Limit @3m dB $\mu$ V/m	Margin dB
1	0.07	Peak	52.86	13.84	66.70	110.83	-44.13
2	1.51	Peak	22.79	14.83	37.62	64.03	-26.41
3	13.42	Peak	25.78	15.91	41.69	69.54	-27.85
4	13.75	Peak	30.06	15.90	45.96	69.54	-23.58
5	20.10	Peak	14.82	15.55	30.37	69.54	-39.17
6	28.11	Peak	8.19	13.99	22.18	69.54	-47.36

**Remark:**

- 9kHz to 490kHz Limit(@3m) =  $2400(F/kHz) + 40 * \text{Log}(300 \text{ meters}/3 \text{ meters})$   
490kHz to 1.705MHz Limit (@3m) =  $2400(F/kHz) + 40 * \text{Log}(30 \text{ meters}/3 \text{ meters})$   
1.705MHz to 30MHz Limit (@3m) =  $30 + 40 * \text{Log}(30 \text{ meters}/3 \text{ meters})$



Report No.: T210421W01-RP

Ref. No.: T200407W01-RP5

Rev.: 00

**30MHz ~ 1GHz**

**Operation Mode:** TX mode

**Test Date:** May 6, 2021

**Temperature:** 22.6°C

**Tested by:** Ray Li

**Humidity:** 56 % RH

**Polarity:** Ver. / Hor.

Freq. MHz	Detector Mode PK/QP/AV	Spectrum Reading Level dBµV	Factor dB	Actual FS dBµV/m	Limit @3m dBµV/m	Margin dB	Polarity
41.64	Peak	47.72	-10.69	37.03	40.00	-2.97	V
175.50	Peak	41.10	-11.11	29.99	43.50	-13.51	V
330.70	Peak	33.09	-7.08	26.01	46.00	-19.99	V
516.94	Peak	28.67	-2.64	26.03	46.00	-19.97	V
745.86	Peak	28.45	2.14	30.59	46.00	-15.41	V
975.75	Peak	25.35	5.46	30.81	54.00	-23.19	V
42.61	Peak	41.24	-11.31	29.93	40.00	-10.07	H
175.50	Peak	46.92	-11.11	35.81	43.50	-7.69	H
319.06	Peak	35.97	-7.41	28.56	46.00	-17.44	H
505.30	Peak	30.36	-2.99	27.37	46.00	-18.63	H
757.50	Peak	29.72	2.29	32.01	46.00	-13.99	H
987.39	Peak	26.07	5.40	31.47	54.00	-22.53	H

## Vertical

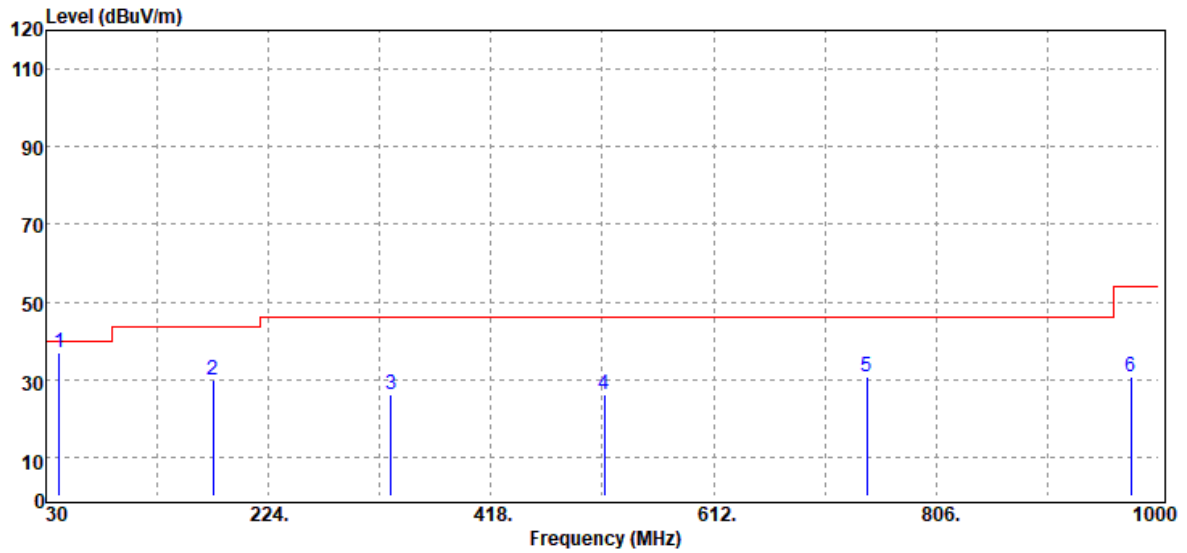

## Horizontal

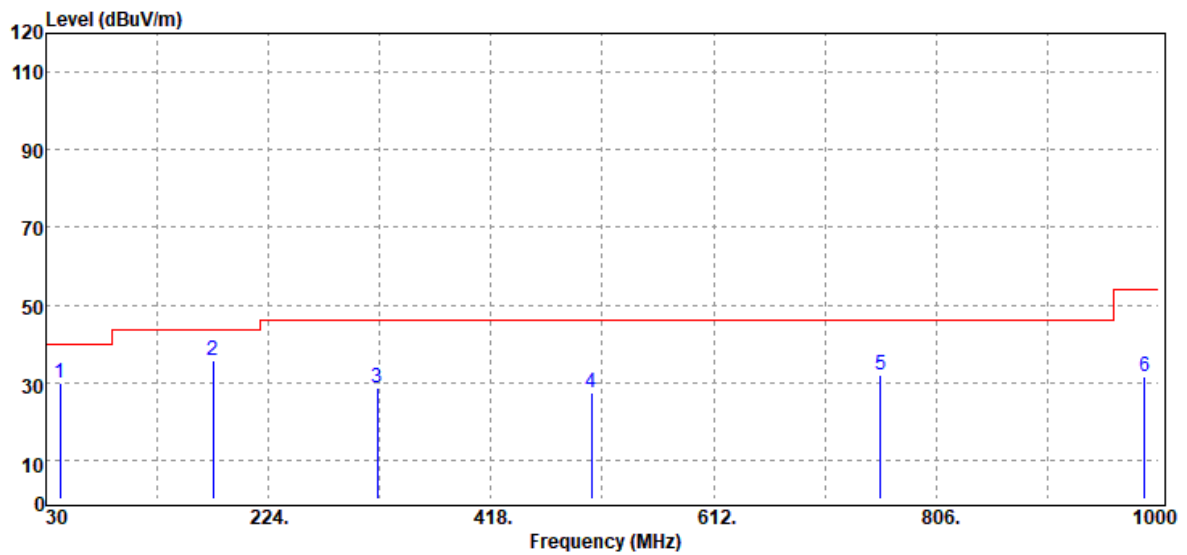

- End of Test Report -