

# RADIO TEST REPORT

## FCC 47 CFR PART 15 SUBPART C

### INDUSTRY CANADA RSS-247

<b>Test Standard</b>	<b>FCC Part 15.247 IC RSS-247 issue 2 and IC RSS-GEN issue 5</b>
<b>Product name</b>	<b>PRO 8475</b>
<b>Trade Name</b>	<b>MiTAC, Webfleet Solutions</b>
<b>Model</b>	<b>N653</b>
<b>Test Result</b>	<b>Pass</b>
<b>Statements of Conformity</b>	<b>Determination of compliance is based on the results of the compliance measurement, not taking into account measurement instrumentation uncertainty.</b>

The test Result was tested by Compliance Certification Services Inc. The test data, data evaluation, test procedures, and equipment configurations shown in this report were given in ANSI C63.10: 2013 and compliance standards.

The test results of this report relate only to the tested sample (EUT) identified in this report.

The test Report of full or partial shall not copy. Without written approval of Compliance Certification Services Inc. (Wugu Laboratory).

*Approved by:*



---

Kevin Tsai  
Deputy Manager

Unless otherwise stated the results shown in this test report refer only to the sample(s) tested and such sample(s) are retained for 90 days only.  
除非另有說明，此報告結果僅對測試之樣品負責，同時此樣品僅保留90天。本報告未經本公司書面許可，不可部份複製。

This document is issued by the Company subject to its General Conditions of Service printed overleaf, available on request or accessible at <http://www.sgs.com.tw/Terms-and-Conditions> and, for electronic format documents, subject to Terms and Conditions for Electronic Documents at <http://www.sgs.com.tw/Terms-and-Conditions>. Attention is drawn to the limitation of liability, indemnification and jurisdiction issues defined therein. Any holder of this document is advised that information contained hereon reflects the Company's findings at the time of its intervention only and within the limits of client's instruction, if any. The Company's sole responsibility is to its Client and this document does not exonerate parties to a transaction from exercising all their rights and obligations under the transaction documents. This document cannot be reproduced, except in full, without prior written approval of the Company. Any unauthorized alteration, forgery or falsification of the content or appearance of this document is unlawful and offenders may be prosecuted to the fullest extent of the law.

### Revision History

Rev.	Issue Date	Revisions	Effect Page	Revised By
00	May 21, 2020	Initial Issue	ALL	Allison Chen
01	June 9, 2020	See the following note Rev.(01)	ALL	Allison Chen

**Rev.(01)**

1. Added test data for conduction, power table and radiated emission.
2. Revised product name: PRO 8475, and model name: N653.

## Table of contents

<b>1.</b>	<b>GENERAL INFORMATION.....</b>	<b>4</b>
<b>1.1</b>	<b>EUT INFORMATION.....</b>	<b>4</b>
<b>1.2</b>	<b>EUT CHANNEL INFORMATION.....</b>	<b>5</b>
<b>1.3</b>	<b>ANTENNA INFORMATION.....</b>	<b>5</b>
<b>1.4</b>	<b>MEASUREMENT UNCERTAINTY.....</b>	<b>6</b>
<b>1.5</b>	<b>FACILITIES AND TEST LOCATION.....</b>	<b>6</b>
<b>1.6</b>	<b>INSTRUMENT CALIBRATION.....</b>	<b>7</b>
<b>1.7</b>	<b>SUPPORT AND EUT ACCESSORIES EQUIPMENT.....</b>	<b>8</b>
<b>1.8</b>	<b>TEST METHODOLOGY AND APPLIED STANDARDS.....</b>	<b>8</b>
<b>2.</b>	<b>TEST SUMMERY.....</b>	<b>9</b>
<b>3.</b>	<b>DESCRIPTION OF TEST MODES.....</b>	<b>10</b>
<b>3.1</b>	<b>THE WORST MODE OF OPERATING CONDITION.....</b>	<b>10</b>
<b>3.2</b>	<b>THE WORST MODE OF MEASUREMENT.....</b>	<b>11</b>
<b>4.</b>	<b>TEST RESULT.....</b>	<b>12</b>
<b>4.1</b>	<b>AC POWER LINE CONDUCTED EMISSION.....</b>	<b>12</b>
<b>4.2</b>	<b>OUTPUT POWER MEASUREMENT.....</b>	<b>15</b>
<b>4.3</b>	<b>RADIATION BANDEDGE AND SPURIOUS EMISSION.....</b>	<b>18</b>
<b>4.4</b>	<b>TEST DATA RE-USE SUMMARY.....</b>	<b>65</b>
<b>APPENDIX 1 - PHOTOGRAPHS OF EUT</b>		

## 1. GENERAL INFORMATION

### 1.1 EUT INFORMATION

<b>FCC Applicant</b>	Mitac Digital Technology Corporation No.200, Wen Hwa 2nd Rd.,Kuei Shan Dist. Taoyuan, 33383 Taiwan
<b>IC Applicant</b>	MiTAC Digital Technology Corporation No.200, Wenhua 2nd Rd., Guishan Dist. Taoyuan City 333 Taiwan
<b>Manufacturer</b>	MITAC COMPUTER (KUNSHAN) CO., LTD. No. 269, 2nd Avenue, District A, Comprehensive Free Trade Zone, Kunshan, Jiangsu, P.R. China
<b>Equipment</b>	PRO 8475
<b>Model</b>	N653
<b>Model Discrepancy</b>	Difference of the those trade names (list on this report) are just for marketing purpose only.
<b>Trade Name</b>	MiTAC, Webfleet Solutions
<b>Received Date</b>	April 7, 2020
<b>Date of Test</b>	June 1 ~ 5, 2020
<b>Power Supply</b>	1.Powered from Rechargeable Li-ion Polymer Battery. Rating: 3.7VDC, 4000mAh, 14.8Wh 2.Powered from Cradle Fleet cable 12/24V (Pogo power pin) USB Type-C 5V
<b>HW Version</b>	R04
<b>SW Version</b>	R01

Report No.: T200407W01-RP3

## 1.2 EUT CHANNEL INFORMATION

Frequency Range	802.11b/g/n HT 20: 2412MHz ~ 2462MHz 802.11n HT 40: 2422MHz ~ 2452MHz
Modulation Type	1. IEEE 802.11b mode: CCK 2. IEEE 802.11g mode: OFDM 3. IEEE 802.11n HT 20 MHz mode : OFDM 4. IEEE 802.11n HT 40 MHz mode : OFDM
Number of channel	1. IEEE 802.11b mode: 11 Channels 2. IEEE 802.11g mode: 11 Channels 3. IEEE 802.11n HT 20 MHz mode : 11 Channels 4. IEEE 802.11n HT 40 MHz mode : 7 Channels

**Remark:**

Refer as ANSI C63.10: 2013 clause 5.6.1 Table 4 and RSS-GEN Table A1 for test channels

Number of frequencies to be tested		
Frequency range in which device operates	Number of frequencies	Location in frequency range of operation
<input type="checkbox"/> 1 MHz or less	1	Middle
<input type="checkbox"/> 1 MHz to 10 MHz	2	1 near top and 1 near bottom
<input checked="" type="checkbox"/> More than 10 MHz	3	1 near top, 1 near middle, and 1 near bottom

## 1.3 ANTENNA INFORMATION

Antenna Type	<input type="checkbox"/> PIFA <input type="checkbox"/> PCB <input type="checkbox"/> Dipole <input type="checkbox"/> Coils <input checked="" type="checkbox"/> Integral
Antenna Gain	Gain: 1.31 dBi
Antenna Connector	i-pex

Report No.: T200407W01-RP3

## 1.4 MEASUREMENT UNCERTAINTY

PARAMETER	UNCERTAINTY
AC Powerline Conducted Emission	+/- 1.2575
Emission bandwidth, 20dB bandwidth	+/- 0.0014
RF output power, conducted	+/- 1.14
Power density, conducted	+/- 1.40
3M Semi Anechoic Chamber / 30M~200M	+/- 4.12
3M Semi Anechoic Chamber / 200M~1000M	+/- 4.68
3M Semi Anechoic Chamber / 1G~8G	+/- 5.18
3M Semi Anechoic Chamber / 8G~18G	+/- 5.47
3M Semi Anechoic Chamber / 18G~26G	+/- 3.81
3M Semi Anechoic Chamber / 26G~40G	+/- 3.87

**Remark:**

1. This uncertainty represents an expanded uncertainty expressed at approximately the 95% confidence level using a coverage factor of  $k=2$
2. ISO/IEC 17025 requires that an estimate of the measurement uncertainties associated with the emissions test results be included in the report.

## 1.5 FACILITIES AND TEST LOCATION

All measurement facilities used to collect the measurement data are located at  
No.11, Wugong 6th Rd., Wugu Dist., New Taipei City, Taiwan. (R.O.C.)

Test site	Test Engineer	Remark
AC Conduction Room	Dally Hong	-
Radiation	Jerry Chang	-
RF Conducted	Jane Wang	-

**Remark:** The sites are constructed in conformance with the requirements of ANSI C63.7, ANSI C63.4 and CISPR Publication 22.

Report No.: T200407W01-RP3

## 1.6 INSTRUMENT CALIBRATION

RF Conducted Test Site					
Equipment	Manufacturer	Model	S/N	Cal Date	Cal Due
Coaxial Cable	Woken	WC12	CC001	06/28/2019	06/27/2020
EXA Signal Analyzer	KEYSIGHT	N9010B	MY55460167	07/31/2019	07/30/2020
Power Meter	Anritsu	ML2487A	6K00003260	05/21/2020	05/20/2021
Power Seneor	Anritsu	MA2490A	032910	05/21/2020	05/20/2021
Software	N/A				

3M 966 Chamber Test Site					
Equipment	Manufacturer	Model	S/N	Cal Date	Cal Due
Band Reject Filters	MICRO TRONICS	BRM 50702	120	02/25/2020	02/24/2021
Bilog Antenna	Sunol Sciences	JB3	A030105	07/26/2019	07/25/2020
Coaxial Cable	HUBER SUHNER	SUCOFLEX 104PEA	20995	02/25/2020	02/24/2021
Coaxial Cable	EMCI	EMC105	190914+25111	09/20/2019	09/19/2020
Digital Thermo-Hygro Meter	WISEWIND	1206	D07	01/15/2020	01/14/2021
double Ridged Guide Horn Antenna	ETC	MCTD 1209	DRH13M02003	10/04/2019	10/03/2020
Loop Ant	COM-POWER	AL-130	121051	03/27/2020	03/26/2021
Pre-Amplifier	EMEC	EM330	060609	02/25/2020	02/24/2021
Pre-Amplifier	HP	8449B	3008A00965	02/25/2020	02/24/2021
Signal Analyzer	Agilent	N9010A	MY52220817	03/19/2020	03/18/2021
Antenna Tower	CCS	CC-A-1F	N/A	N.C.R	N.C.R
Controller	CCS	CC-C-1F	N/A	N.C.R	N.C.R
Turn Table	CCS	CC-T-1F	N/A	N.C.R	N.C.R
Software	e3 6.11-20180413				

AC line Conduction Test Room					
Equipment	Manufacturer	Model	S/N	Cal Date	Cal Due
CABLE	EMCI	CFD300-NL	CERF	06/27/2019	06/26/2020
EMI Test Receiver	R&S	ESCI	100064	07/26/2019	07/25/2020
LISN	SCHAFFNER	NNB 41	03/10013	02/13/2020	02/12/2021
Software	EZ-EMC(CCS-3A1-CE-wugu)				

**Remark:** Each piece of equipment is scheduled for calibration once a year.

## 1.7 SUPPORT AND EUT ACCESSORIES EQUIPMENT

EUT Accessories Equipment						
No.	Equipment	Brand	Model	Series No.	FCC ID	IC ID
	N/A					

Support Equipment						
No.	Equipment	Brand	Model	Series No.	FCC ID	IC ID
1	NB(L)	Toshiba	PORTEGE R30-A	N/A	PD97260H	N/A
2	DC Power Source	Agilent	E3640A	N/A	N/A	N/A

## 1.8 TEST METHODOLOGY AND APPLIED STANDARDS

The test methodology, setups and results comply with all requirements in accordance with ANSI C63.10:2013, FCC Part 2, FCC Part 15.247, KDB 558074 D01, RSS-247 Issue 2 and RSS-GEN Issue 5.



## 2. TEST SUMMERY

FCC Standard Section	IC Standard Section	Report Section	Test Item	Result
15.203	-	1.3	Antenna Requirement	Pass
15.207(a)	RSS-GEN 8.8	4.1	AC Conducted Emission	Pass
15.247(b)(3)	RSS-247(5.4)(d)	4.2	Output Power Measurement	Pass
15.247(d)	RSS-GEN 8.9, 8.10	4.3	Radiation Band Edge	Pass
15.247(d)	RSS-GEN 8.9, 8.10	4.3	Radiation Spurious Emission	Pass

Report No.: T200407W01-RP3

### 3. DESCRIPTION OF TEST MODES

#### 3.1 THE WORST MODE OF OPERATING CONDITION

Operation mode	IEEE 802.11b mode :1Mbps IEEE 802.11g mode :6Mbps IEEE 802.11n HT20 mode :MCS0 IEEE 802.11n HT40 mode :MCS0
Test Channel Frequencies	<b>IEEE 802.11b mode :</b> 1. Lowest Channel : 2412MHz 2. Middle Channel : 2437MHz 3. Highest Channel : 2462MHz <b>IEEE 802.11g mode :</b> 1. Lowest Channel : 2412MHz 2. Middle Channel : 2437MHz 3. Highest Channel : 2462MHz <b>IEEE 802.11n HT20 mode :</b> 1. Lowest Channel : 2412MHz 2. Middle Channel : 2437MHz 3. Highest Channel : 2462MHz <b>IEEE 802.11n HT40 mode :</b> 1. Lowest Channel : 2422MHz 2. Middle Channel : 2437MHz 3. Highest Channel : 2452MHz
Operation Transmitter	IEEE 802.11b mode :1T1R IEEE 802.11g mode :1T1R IEEE 802.11n HT20 mode : 1T1R IEEE 802.11n HT40 mode : 1T1R

**Remark:**

1. EUT pre-scanned data rate of output power for each mode, the worst data rate were recorded in this report.

### 3.2 THE WORST MODE OF MEASUREMENT

AC Power Line Conducted Emission	
Test Condition	AC Power line conducted emission for line and neutral
Power supply Mode	Mode 1: EUT power by Battery Mode 2: EUT+Cradle
Worst Mode	<input checked="" type="checkbox"/> Mode 1 <input type="checkbox"/> Mode 2 <input type="checkbox"/> Mode 3 <input type="checkbox"/> Mode 4

Radiated Emission Measurement Above 1G	
Test Condition	Radiated Emission Above 1G
Power supply Mode	Mode 1: EUT power by Battery Mode 2: EUT+Cradle
Worst Mode	<input checked="" type="checkbox"/> Mode 1 <input type="checkbox"/> Mode 2 <input type="checkbox"/> Mode 3 <input type="checkbox"/> Mode 4
Worst Position	<input type="checkbox"/> Placed in fixed position. <input type="checkbox"/> Placed in fixed position at X-Plane (E2-Plane) <input type="checkbox"/> Placed in fixed position at Y-Plane (E1-Plane) <input checked="" type="checkbox"/> Placed in fixed position at Z-Plane (H-Plane)

Radiated Emission Measurement Below 1G	
Test Condition	Radiated Emission Below 1G
Power supply Mode	Mode 1: EUT power by Battery Mode 2: EUT+Cradle
Worst Mode	<input checked="" type="checkbox"/> Mode 1 <input type="checkbox"/> Mode 2 <input type="checkbox"/> Mode 3 <input type="checkbox"/> Mode 4

**Remark:**

1. The worst mode was record in this test report.
2. EUT pre-scanned in three axis ,X,Y, Z and two polarity, for radiated measurement. The worst case(Z-Plane) were recorded in this report
3. AC power line conducted emission and for below 1G radiation emission were performed the EUT transmit at the highest output power channel as worse case.

Report No.: T200407W01-RP3

## 4. TEST RESULT

### 4.1 AC POWER LINE CONDUCTED EMISSION

#### 4.1.1 Test Limit

According to §15.207(a) and RSS-GEN section 8.8,

Frequency Range (MHz)	Limits(dBµV)	
	Quasi-peak	Average
0.15 to 0.50	66 to 56*	56 to 46*
0.50 to 5	56	46
5 to 30	60	50

\* Decreases with the logarithm of the frequency.

#### 4.1.2 Test Procedure

Test method Refer as ANSI C63.10: 2013 clause 6.2,

1. The EUT was placed on a non-conducted table, which is 0.8m above horizontal ground plane and 0.4m above vertical ground plane.
2. EUT connected to the line impedance stabilization network (LISN)
3. Receiver set RBW of 9kHz and Detector Peak, and note as quasi-peak and average.
4. Maximum procedure was performed on the six highest emissions to ensure EUT compliance.
5. Recorded Line for Neutral and Line.

#### 4.1.3 Test Setup

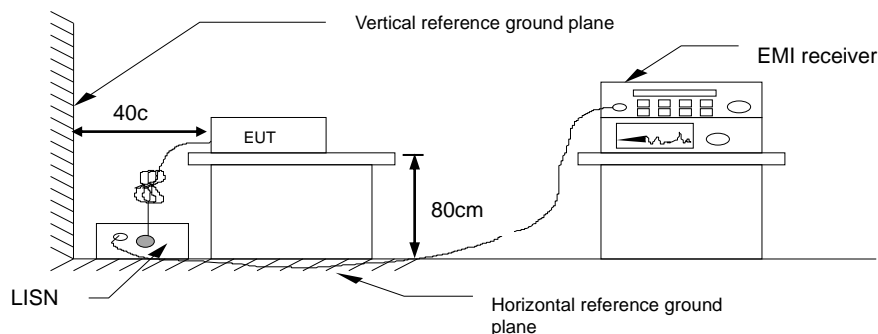

#### 4.1.4 Test Result

**Pass.**

Report No.: T200407W01-RP3

**Test Data**

Test Mode:	Mode 1	Temp/Hum	24(°C)/ 50%RH
Phase:	Line	Test Date	June 1, 2020
		Test Engineer	Dally Hong

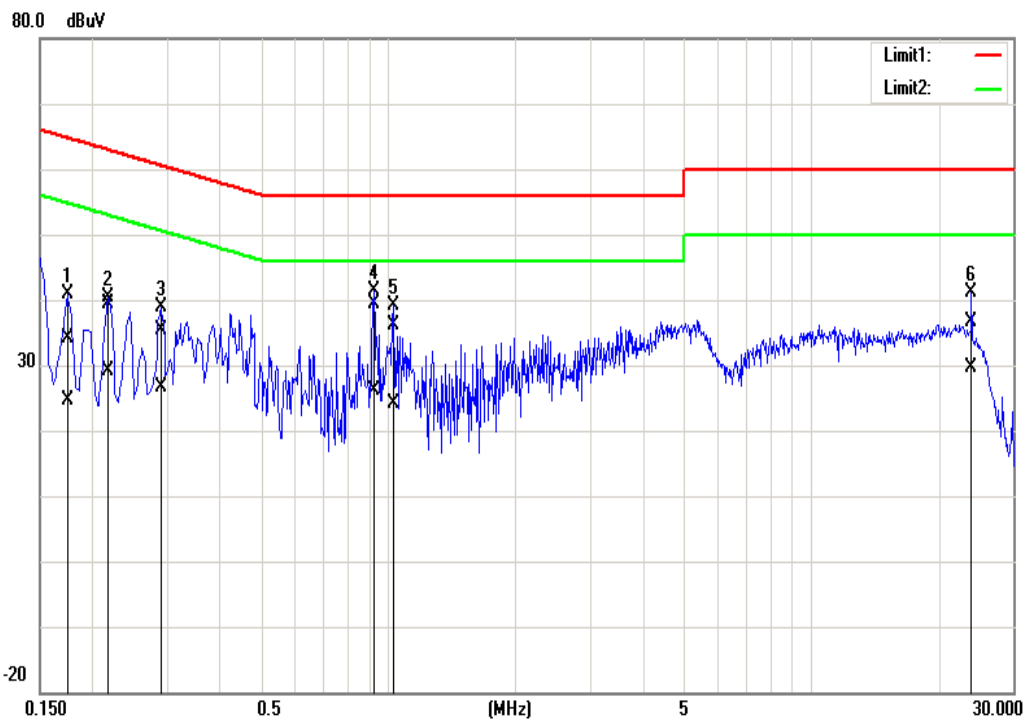

Frequency (MHz)	Quasi Peak reading (dBuV)	Average reading (dBuV)	Correction factor (dB)	Quasi Peak result (dBuV)	Average result (dBuV)	Quasi Peak limit (dBuV)	Average limit (dBuV)	Quasi Peak margin (dB)	Average margin (dB)	Remark
0.1740	23.96	14.53	10.22	41.18	24.75	64.76	54.77	-30.58	-30.02	Pass
0.2180	29.08	19.03	10.21	37.29	29.24	62.89	52.89	-23.60	-23.65	Pass
0.2900	25.10	16.31	10.21	36.31	26.52	60.52	50.52	-25.21	-24.00	Pass
0.9260	29.24	15.88	10.24	39.48	26.12	56.00	46.00	-16.52	-19.88	Pass
1.0300	25.83	13.87	10.24	34.07	24.11	56.00	46.00	-19.93	-21.89	Pass
23.9260	26.21	19.41	10.33	33.54	29.74	60.00	50.00	-23.46	-20.26	Pass

Report No.: T200407W01-RP3

Test Mode:	Mode 1	Temp/Hum	24(°C)/ 50%RH
Phase:	Neutral	Test Date	June 1, 2020
		Test Engineer	Dally Hong

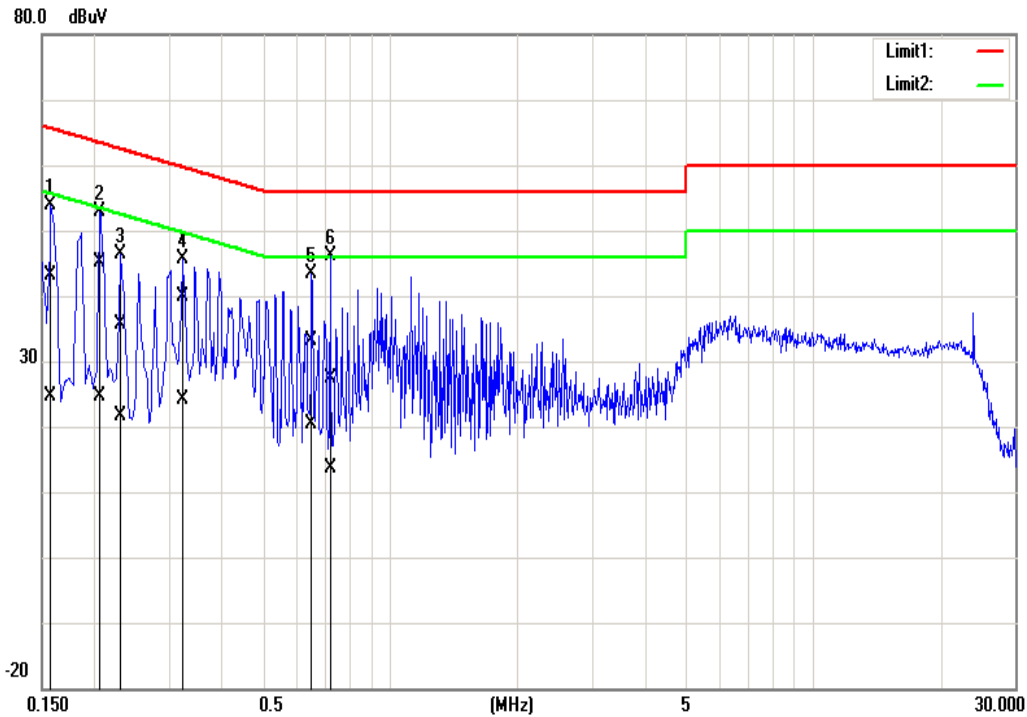

Frequency (MHz)	Quasi Peak reading (dBuV)	Average reading (dBuV)	Correction factor (dB)	Quasi Peak result (dBuV)	Average result (dBuV)	Quasi Peak limit (dBuV)	Average limit (dBuV)	Quasi Peak margin (dB)	Average margin (dB)	Remark
0.1580	32.85	14.50	10.19	43.04	24.69	65.57	55.57	-22.53	-30.88	Pass
0.2060	35.03	14.34	10.19	36.22	24.53	63.37	53.37	-18.15	-28.84	Pass
0.2300	25.42	11.44	10.19	38.61	21.63	62.45	52.45	-26.84	-30.82	Pass
0.3220	29.63	13.95	10.19	38.82	24.14	59.66	49.66	-19.84	-25.52	Pass
0.6540	22.97	10.07	10.19	37.16	20.26	56.00	46.00	-22.84	-25.74	Pass
0.7220	17.20	3.44	10.21	39.41	13.65	56.00	46.00	-28.59	-32.35	Pass

Report No.: T200407W01-RP3

## 4.2 OUTPUT POWER MEASUREMENT

### 4.2.1 Test Limit

According to §15.247(b) (3) and RSS-247 section 5.4(d),

#### Peak output power :

For systems using digital modulation in the 2400-2483.5 MHz: 1 Watt(30 dBm) and the e.i.r.p. shall not exceed 4Watt(36 dBm), base on the use of antennas with directional gain not exceed 6 dBi If transmitting antennas of directional gain greater than 6dBi are used the peak output power the conducted output power from the intentional radiator shall be reduced by the amount in dB that the directional gain of the antenna exceeds 6 dBi. In case of point-to-point operation, the limit has to be reduced by 1dB for every 3 dB that the directional gain of the antenna exceeds 6 dBi.

Limit	<input checked="" type="checkbox"/> Antenna not exceed 6 dBi : 30dBm <input type="checkbox"/> Antenna with DG greater than 6 dBi : [Limit = 30 – (DG – 6)] <input type="checkbox"/> Point-to-point operation :
-------	---

Average output power : For reporting purposes only.

### 4.2.2 Test Procedure

Test method Refer as KDB 558074 D01.

1. The EUT RF output connected to the power meter by RF cable.
2. Setting maximum power transmit of EUT.
3. The path loss was compensated to the results for each measurement.
4. Measure and record the result of Peak output power and Average output power. in the test report.

### 4.2.3 Test Setup

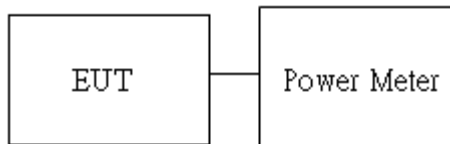

Report No.: T200407W01-RP3

### 4.2.4 Test Result

**Peak output power :**

Wifi 2.4G										
Config	CH	Freq. (MHz)	power set	PK Power (dBm)	PK Power (W)	EIRP PK Power (dBm)	EIRP PK Power (W)	DG (dBi)	Limit (dBm)	EIRP Limit (dBm)
IEEE 802.11b Data rate: 1Mbps	Low	2412	15.0	19.12	0.0817	20.43	0.1104	1.31	30	36
	Mid	2437	15.5	19.26	0.0843	20.57	0.1140			
	High	2462	15.5	19.21	0.0834	20.52	0.1127			
IEEE 802.11g Data rate: 6Mbps	Low	2412	15.0	21.24	0.1330	22.55	0.1799			
	Mid	2437	16.0	21.55	0.1429	22.86	0.1932			
	High	2462	15.5	21.43	0.1390	22.74	0.1879			
IEEE 802.11n HT20 Data rate: MCS0	Low	2412	15.0	21.16	0.1306	22.47	0.1766			
	Mid	2437	16.0	21.73	0.1489	23.04	0.2014			
	High	2462	15.5	21.65	0.1462	22.96	0.1977			
IEEE 802.11n HT40 Data rate: MCS0	Low	2422	14.0	21.11	0.1291	22.42	0.1746			
	Mid	2437	15.5	21.20	0.1318	22.51	0.1782			
	High	2452	15.5	21.36	0.1368	22.67	0.1849			



**Average output power :**

Wifi 2.4G			
Config	CH	Freq. (MHz)	AV Power (dBm)
IEEE 802.11b Data rate: 1Mbps	Low	2412	16.42
	Mid	2437	16.23
	High	2462	16.38
IEEE 802.11g Data rate: 6Mbps	Low	2412	14.60
	Mid	2437	14.77
	High	2462	14.62
IEEE 802.11n HT20 Data rate: MCS0	Low	2412	14.55
	Mid	2437	14.82
	High	2462	14.62
IEEE 802.11n HT40 Data rate: MCS0	Low	2422	14.61
	Mid	2437	14.89
	High	2452	14.62

Report No.: T200407W01-RP3

## 4.3 RADIATION BANDEDGE AND SPURIOUS EMISSION

### 4.3.1 Test Limit

FCC according to §15.247(d), §15.209 and §15.205,

IC according to RSS-247 section 5.5, RSS-Gen, Section 8.9 and 8.10

In any 100 kHz bandwidth outside the authorized frequency band, all harmonic and spurious must be least 20 dB below the highest emission level with the authorized frequency band. Radiation emission which fall in the restricted bands must also follow the FCC section 15.209 as below limit in table.

#### Below 30 MHz

Frequency	Field Strength (microvolts/m)	Magnetic H-Field (microamperes/m)	Measurement Distance (metres)
9-490 kHz	2,400/F (F in kHz)	2,400/F (F in kHz)	300
490-1,705 kHz	24,000/F (F in kHz)	24,000/F (F in kHz)	30
1.705-30 MHz	30	N/A	30

#### Above 30 MHz

Frequency	Field Strength (microvolts/m)	Measurement Distance (metres)
30-88	100	3
88-216	150	3
216-960	200	3
Above 960	500	3

**Remark:**

Although these tests were performed other than open area test site, adequate comparison measurements were confirmed against 30 m open are test site. Therefore sufficient tests were made to demonstrate that the alternative site produces results that correlate with the ones of tests made in an open field based on KDB 414788.

IC according to RSS-247 section 5.5, RSS-Gen, Section 8.9 and 8.10

**RSS-Gen Table 3 and Table 5 – General Field Strength Limits for Transmitters and Receivers at Frequencies Above 30 MHz** <sup>(Note)</sup>

Frequency (MHz)	Field Strength microvolts/m at 3 metres (watts, e.i.r.p.)	
	Transmitters	Receivers
30-88	100 (3 nW)	100 (3 nW)
88-216	150 (6.8 nW)	150 (6.8 nW)
216-960	200 (12 nW)	200 (12 nW)
Above 960	500 (75 nW)	500 (75 nW)

**Note:** Measurements for compliance with the limits in table 3 may be performed at distances other than 3 metres, in accordance with Section 6.6.

**RSS-Gen Table 6: General Field Strength Limits for Transmitters at Frequencies Below 30 MHz (Transmit)**

Frequency	Magnetic field strength (H-Field) ( $\mu\text{A/m}$ )	Measurement Distance (m)
9-490 kHz <sup>Note</sup>	6.37/F (F in kHz)	300
490-1,705 kHz	63.7/F (F in kHz)	30
1.705-30 MHz	0.08	30

**Note:** The emission limits for the ranges 9-90 kHz and 110-490 kHz are based on measurements employing a linear average detector.

### 4.3.2 Test Procedure

Test method Refer as KDB 558074 D01.

1. The EUT is placed on a turntable, Above 1 GHz is 1.5m and below 1 GHz is 0.8m above ground plane. The EUT Configured un accordance with ANSI C63.10: 2013, and the EUT set in a continuous mode.

2. The turntable shall be rotated for 360 degrees to determine the position of maximum emission level. And EUT is set 3m away from the receiving antenna, which is scanned from 1m to 4m above the ground plane to find out the highest emissions. Measurement are made polarized in both the vertical and the horizontal positions with antenna.

3. Span shall wide enough to full capture the emission measured. The SA from 9kHz to 26.5GHz set to the low, Mid and High channels with the EUT transmit.

Note: No emission found between lowest internal used/generated frequency to 30MHz (9KHz~30MHz)

Remark:

Although these tests were performed other than open area test site, adequate comparison measurements were confirmed against 30 m open are test site. Therefore sufficient tests were made to demonstrate that the alternative site produces results that correlate with the ones of tests made in an open field based on KDB 414788.

4. The SA setting following :

(1) Below 1G : RBW = 100kHz, VBW  $\geq$  3 RBW, Sweep = Auto, Detector = Peak, Trace = Max hold.

(2) Above 1G :

(2.1) For Peak measurement : RBW = 1MHz, VBW  $\geq$  3 RBW, Sweep = Auto, Detector = Peak, Trace = Max hold.

(2.2) For Average measurement : RBW = 1MHz, VBW

·If Duty Cycle  $\geq$  98%, VBW=10Hz.

·If Duty Cycle < 98%, VBW=1/T.

### 4.3.3 Test Setup

#### 9kHz ~ 30MHz

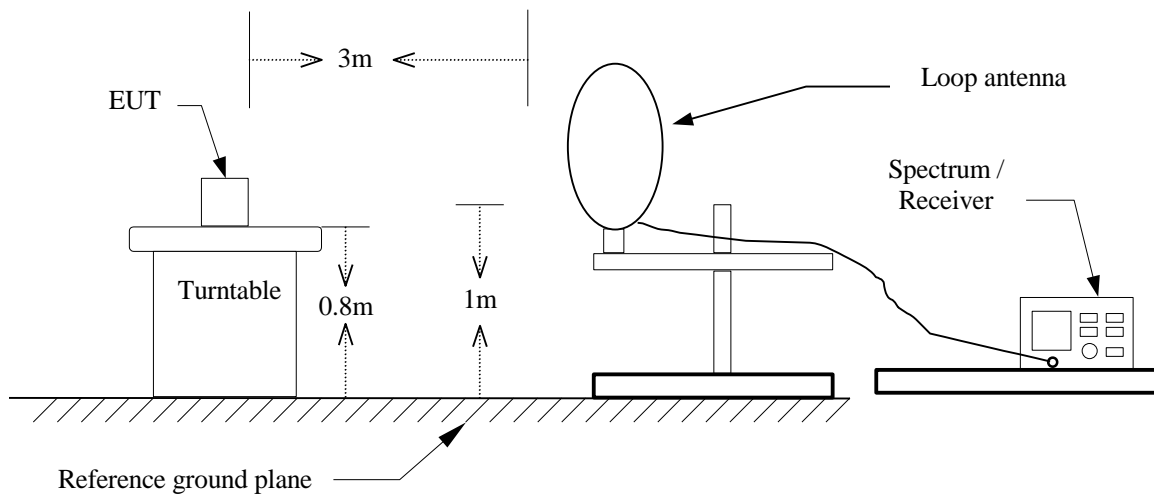

#### 30MHz ~ 1GHz

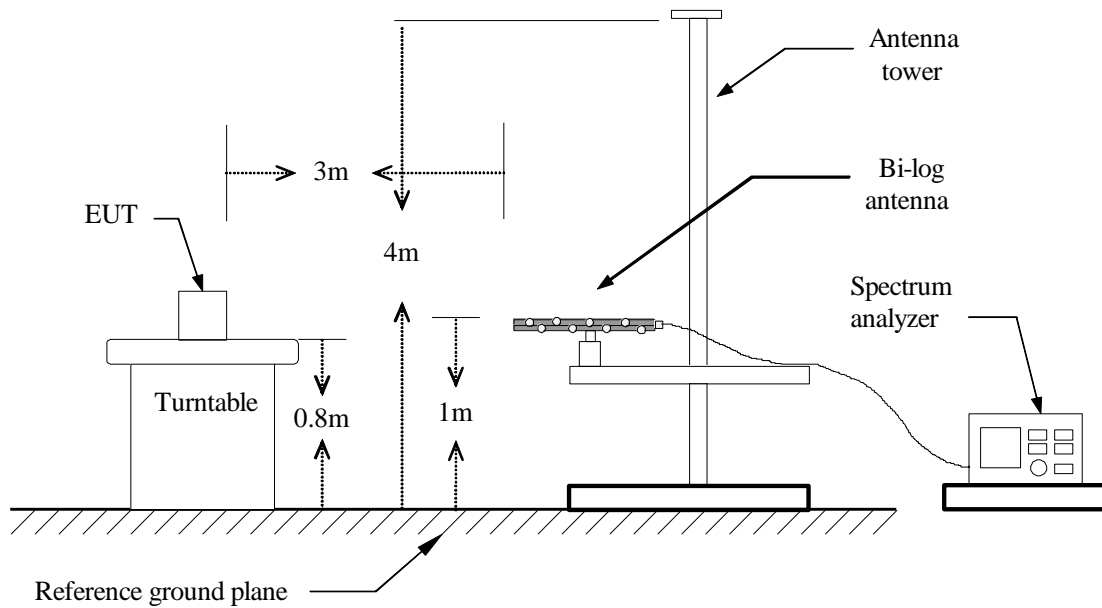

## Above 1 GHz

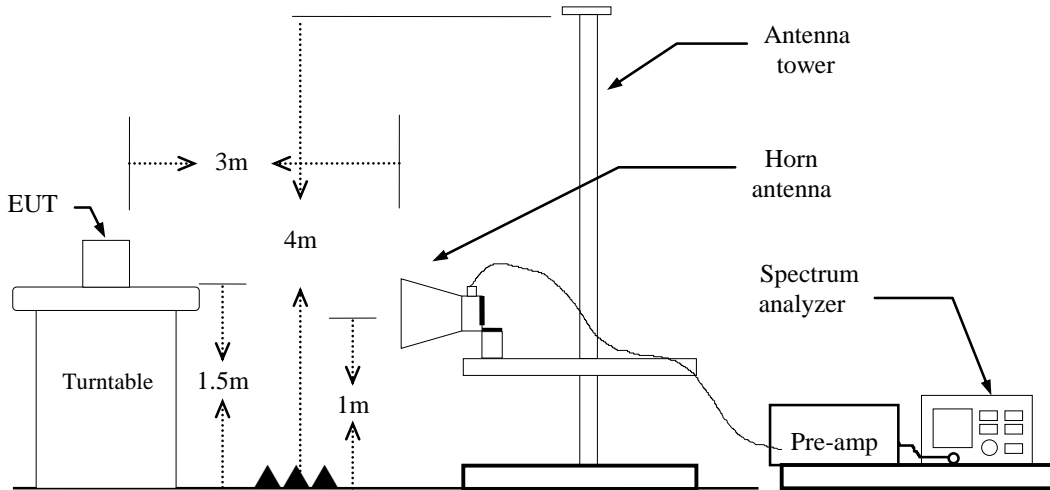

Report No.: T200407W01-RP3

### 4.3.4 Test Result

#### Band Edge Test Data

Test Mode	IEEE 802.11b Low CH 2412MHz	Temp/Hum	24(°C)/ 50%RH
Test Item	Band Edge	Test Date	June 4, 2020
Polarize	Vertical	Test Engineer	Jerry Chang
Detector	Peak / Average		

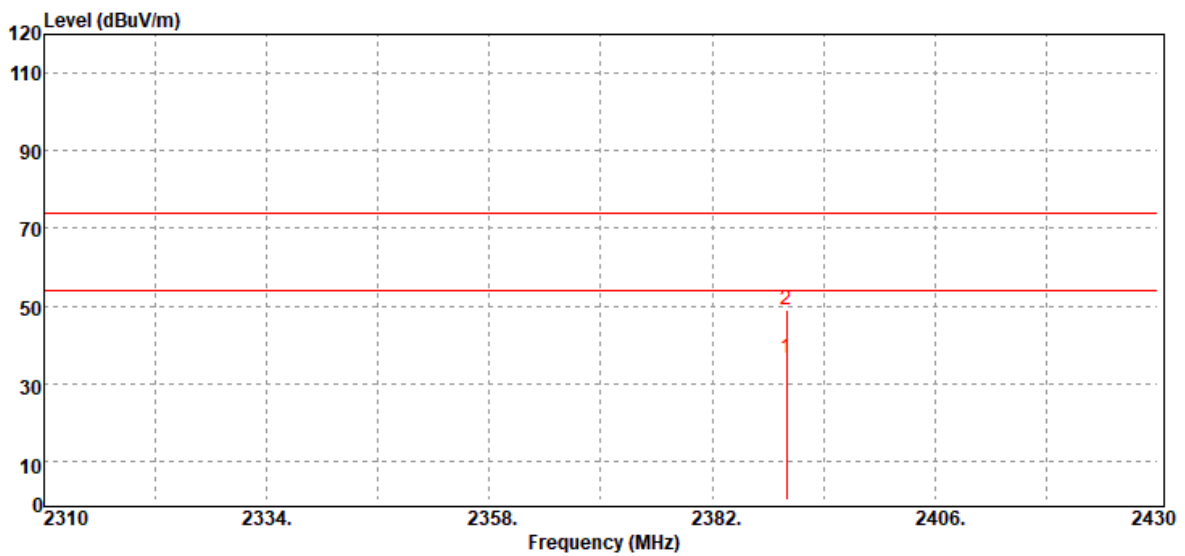

Frequency (MHz)	Detector Mode (PK/QP/AV)	Spectrum Reading Level (dB $\mu$ V)	Factor (dB)	Actual FS (dB $\mu$ V/m)	Limit @3m (dB $\mu$ V/m)	Margin (dB)
2390.00	Average	39.53	-3.17	36.36	54.00	-17.64
2390.00	Peak	52.30	-3.17	49.13	74.00	-24.87

Report No.: T200407W01-RP3

Test Mode	IEEE 802.11b Low CH 2412MHz	Temp/Hum	24(°C)/ 50%RH
Test Item	Band Edge	Test Date	June 4, 2020
Polarize	Horizontal	Test Engineer	Jerry Chang
Detector	Peak & Average		

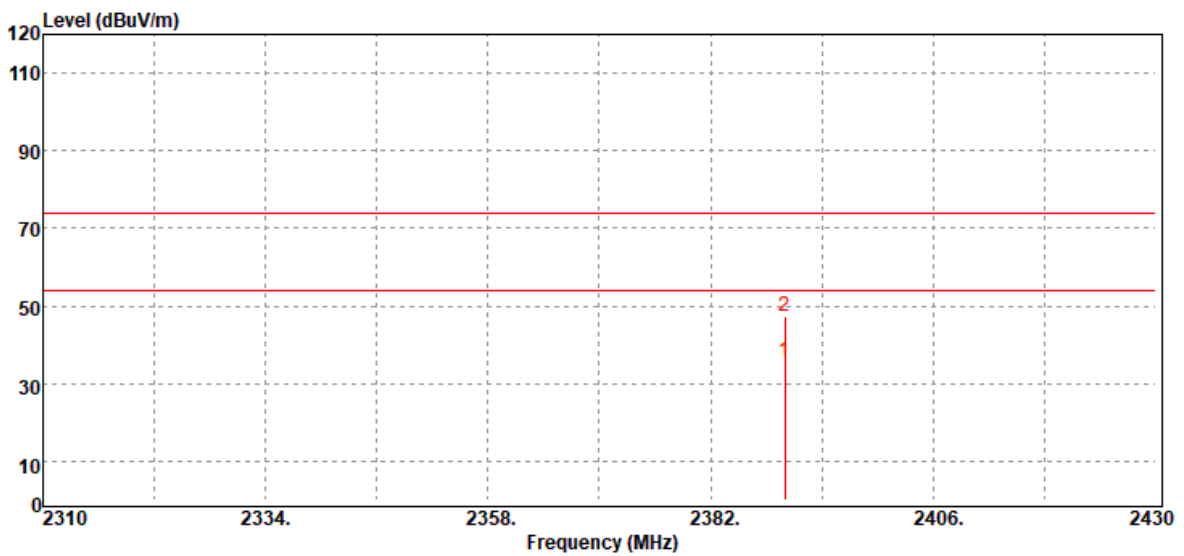

Frequency (MHz)	Detector Mode (PK/QP/AV)	Spectrum Reading Level (dBμV)	Factor (dB)	Actual FS (dBμV/m)	Limit @3m (dBμV/m)	Margin (dB)
2390.00	Average	38.79	-3.17	35.62	54.00	-18.38
2390.00	Peak	50.39	-3.17	47.22	74.00	-26.78



Report No.: T200407W01-RP3

Test Mode	IEEE 802.11b High CH 2462MHz	Temp/Hum	24(°C)/ 50%RH
Test Item	Band Edge	Test Date	June 4, 2020
Polarize	Vertical	Test Engineer	Jerry Chang
Detector	Peak / Average		

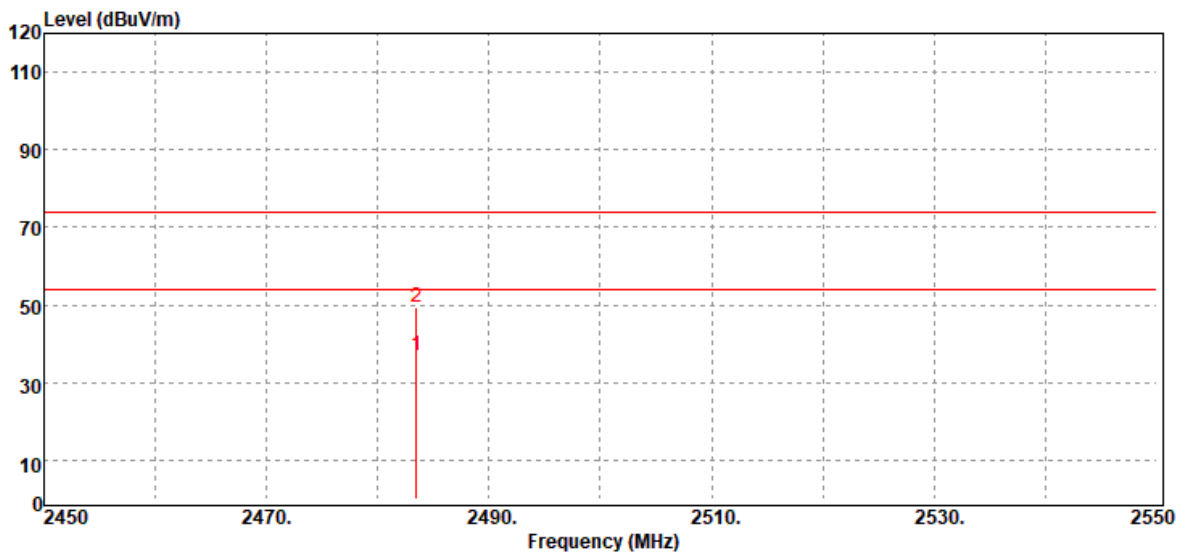

Frequency (MHz)	Detector Mode (PK/QP/AV)	Spectrum Reading Level (dBμV)	Factor (dB)	Actual FS (dBμV/m)	Limit @3m (dBμV/m)	Margin (dB)
2483.50	Average	39.48	-2.71	36.77	54.00	-17.23
2483.50	Peak	52.02	-2.71	49.31	74.00	-24.69

Report No.: T200407W01-RP3

Test Mode	IEEE 802.11b High CH 2462MHz	Temp/Hum	24(°C)/ 50%RH
Test Item	Band Edge	Test Date	June 4, 2020
Polarize	Horizontal	Test Engineer	Jerry Chang
Detector	Peak & Average		

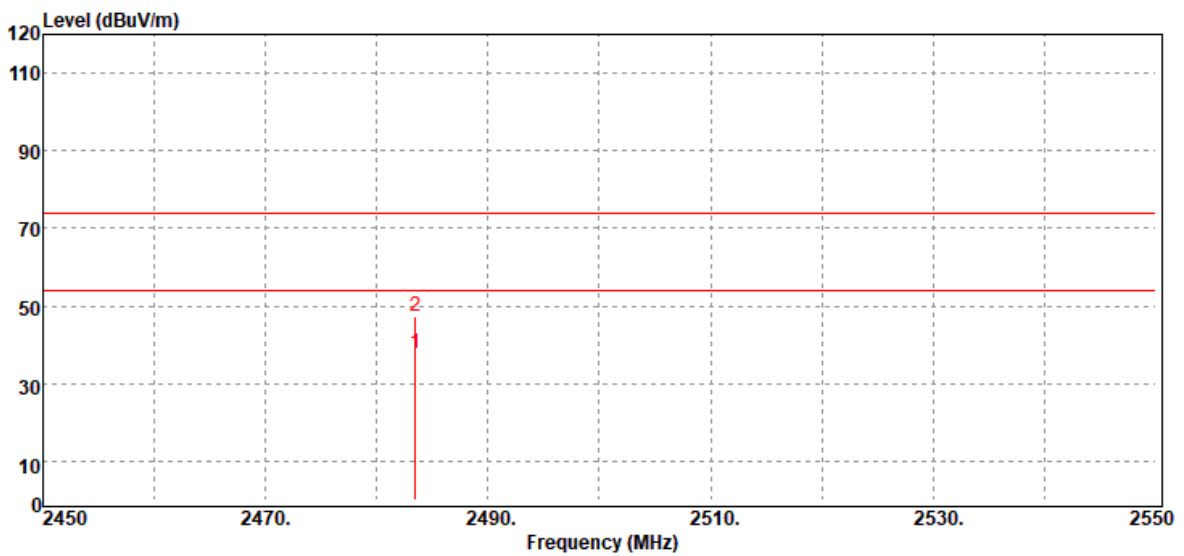

Frequency (MHz)	Detector Mode (PK/QP/AV)	Spectrum Reading Level (dBμV)	Factor (dB)	Actual FS (dBμV/m)	Limit @3m (dBμV/m)	Margin (dB)
2483.50	Average	40.51	-2.71	37.80	54.00	-16.20
2483.50	Peak	50.13	-2.71	47.42	74.00	-26.58

Report No.: T200407W01-RP3

Test Mode	IEEE 802.11g Low CH 2412MHz	Temp/Hum	24(°C)/ 50%RH
Test Item	Band Edge	Test Date	June 5, 2020
Polarize	Vertical	Test Engineer	Jerry Chang
Detector	Peak / Average		

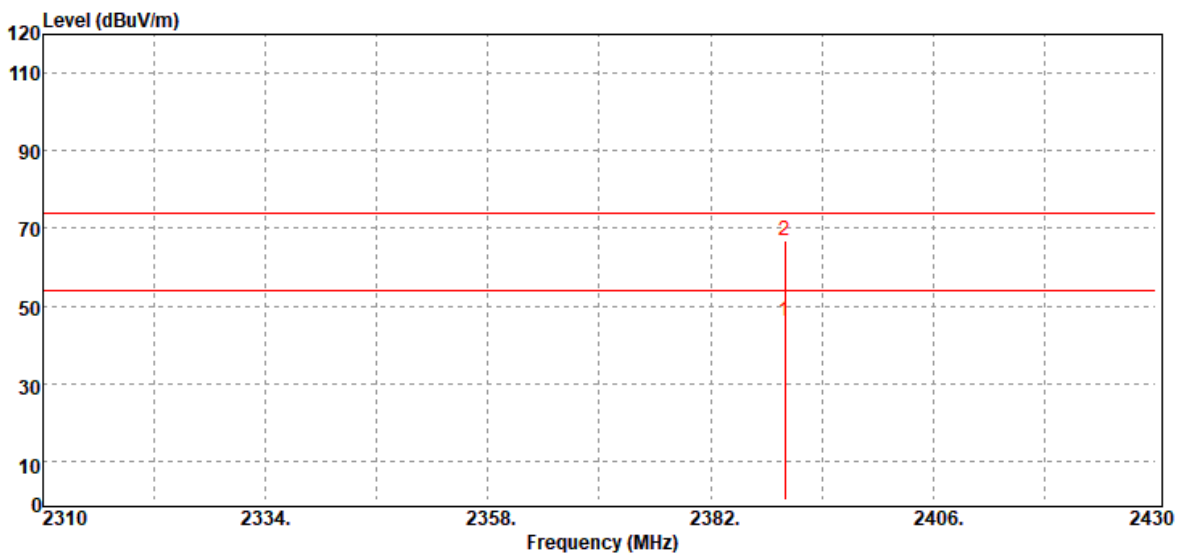

Frequency (MHz)	Detector Mode (PK/QP/AV)	Spectrum Reading Level (dB $\mu$ V)	Factor (dB)	Actual FS (dB $\mu$ V/m)	Limit @3m (dB $\mu$ V/m)	Margin (dB)
2390.00	Average	49.15	-3.17	45.98	54.00	-8.02
2390.00	Peak	70.08	-3.17	66.91	74.00	-7.09

Report No.: T200407W01-RP3

Test Mode	IEEE 802.11g Low CH 2412MHz	Temp/Hum	24(°C)/ 50%RH
Test Item	Band Edge	Test Date	June 5, 2020
Polarize	Horizontal	Test Engineer	Jerry Chang
Detector	Peak & Average		

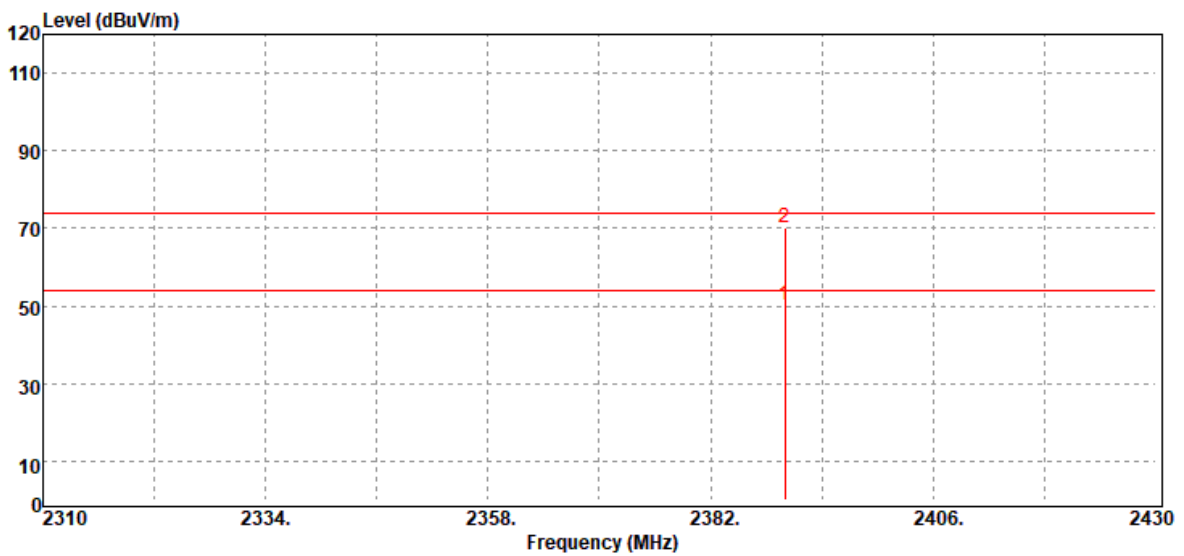

Frequency (MHz)	Detector Mode (PK/QP/AV)	Spectrum Reading Level (dBμV)	Factor (dB)	Actual FS (dBμV/m)	Limit @3m (dBμV/m)	Margin (dB)
2390.00	Average	53.47	-3.17	50.30	54.00	-3.70
2390.00	Peak	73.38	-3.17	70.21	74.00	-3.79

Report No.: T200407W01-RP3

Test Mode	IEEE 802.11g High CH 2462MHz	Temp/Hum	24(°C)/ 50%RH
Test Item	Band Edge	Test Date	June 5, 2020
Polarize	Vertical	Test Engineer	Jerry Chang
Detector	Peak / Average		

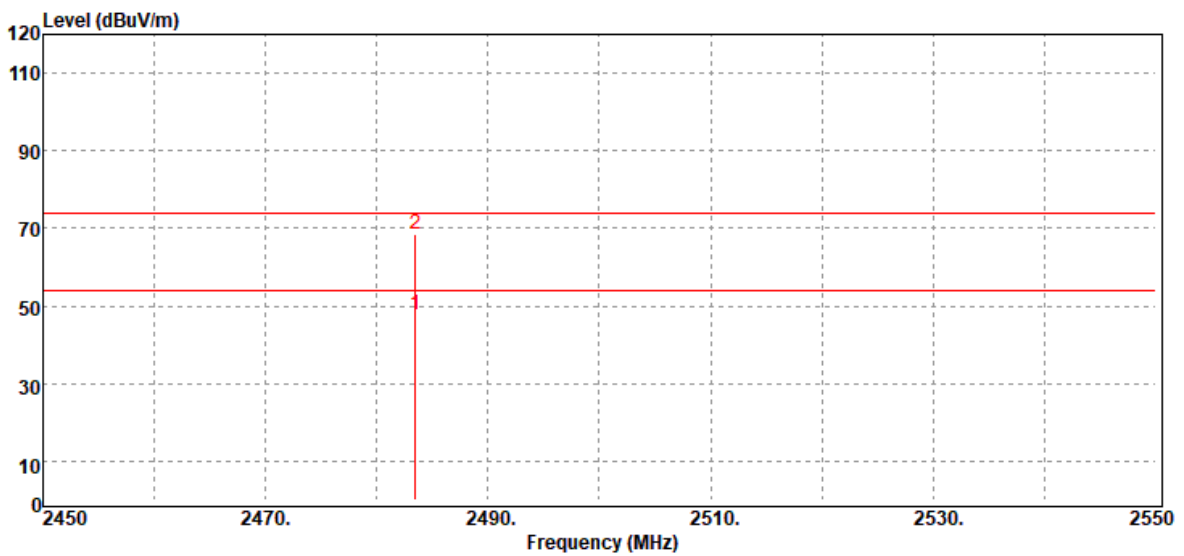

Frequency (MHz)	Detector Mode (PK/QP/AV)	Spectrum Reading Level (dB $\mu$ V)	Factor (dB)	Actual FS (dB $\mu$ V/m)	Limit @3m (dB $\mu$ V/m)	Margin (dB)
2483.50	Average	50.32	-2.71	47.61	54.00	-6.39
2483.50	Peak	71.18	-2.71	68.47	74.00	-5.53

Report No.: T200407W01-RP3

Test Mode	IEEE 802.11g High CH 2462MHz	Temp/Hum	24(°C)/ 50%RH
Test Item	Band Edge	Test Date	June 5, 2020
Polarize	Horizontal	Test Engineer	Jerry Chang
Detector	Peak & Average		

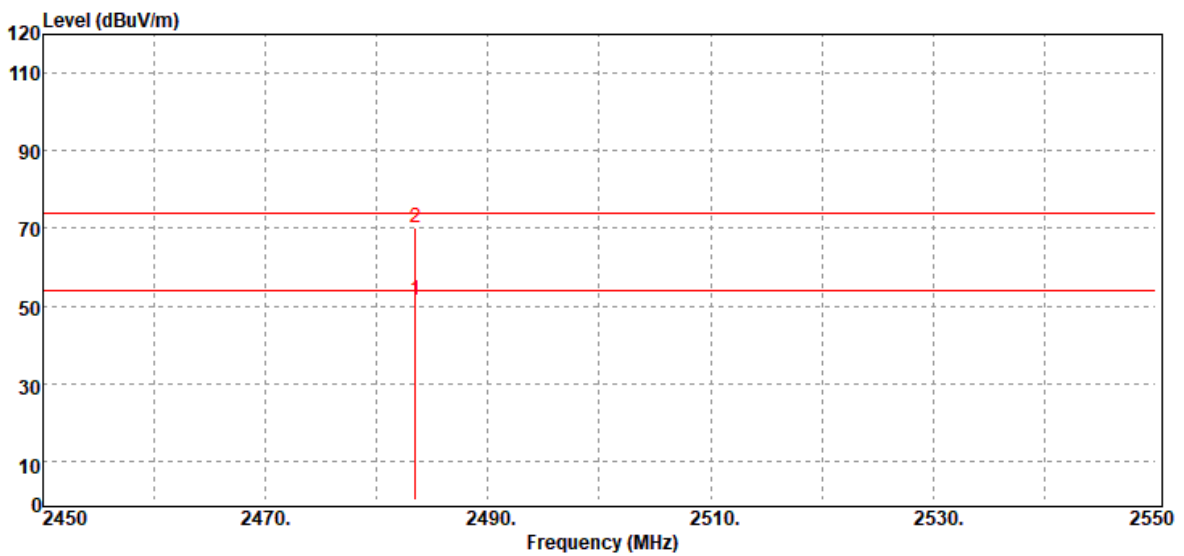

Frequency (MHz)	Detector Mode (PK/QP/AV)	Spectrum Reading Level (dB $\mu$ V)	Factor (dB)	Actual FS (dB $\mu$ V/m)	Limit @3m (dB $\mu$ V/m)	Margin (dB)
2483.50	Average	54.13	-2.71	51.42	54.00	-2.58
2483.50	Peak	72.81	-2.71	70.10	74.00	-3.90

Report No.: T200407W01-RP3

Test Mode	IEEE 802.11n HT20 Low CH 2412MHz	Temp/Hum	24(°C)/ 50%RH
Test Item	Band Edge	Test Date	June 4, 2020
Polarize	Vertical	Test Engineer	Jerry Chang
Detector	Peak / Average		

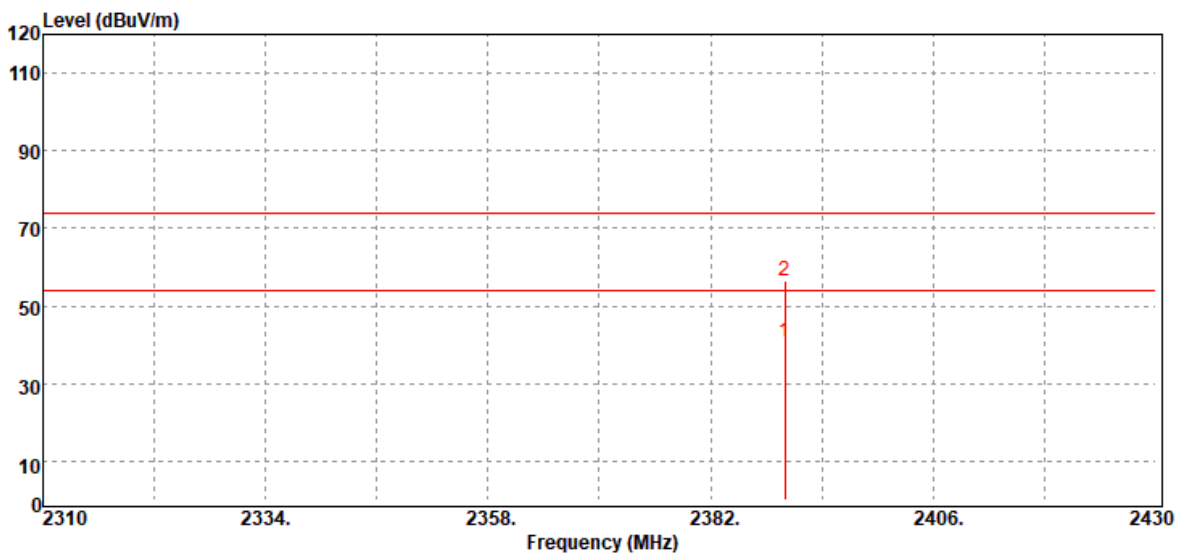

Frequency (MHz)	Detector Mode (PK/QP/AV)	Spectrum Reading Level (dBμV)	Factor (dB)	Actual FS (dBμV/m)	Limit @3m (dBμV/m)	Margin (dB)
2390.00	Average	43.68	-3.17	40.51	54.00	-13.49
2390.00	Peak	59.75	-3.17	56.58	74.00	-17.42

Report No.: T200407W01-RP3

Test Mode	IEEE 802.11 n20 Low CH 2412MHz	Temp/Hum	24(°C)/ 50%RH
Test Item	Band Edge	Test Date	June 4, 2020
Polarize	Horizontal	Test Engineer	Jerry Chang
Detector	Peak & Average		

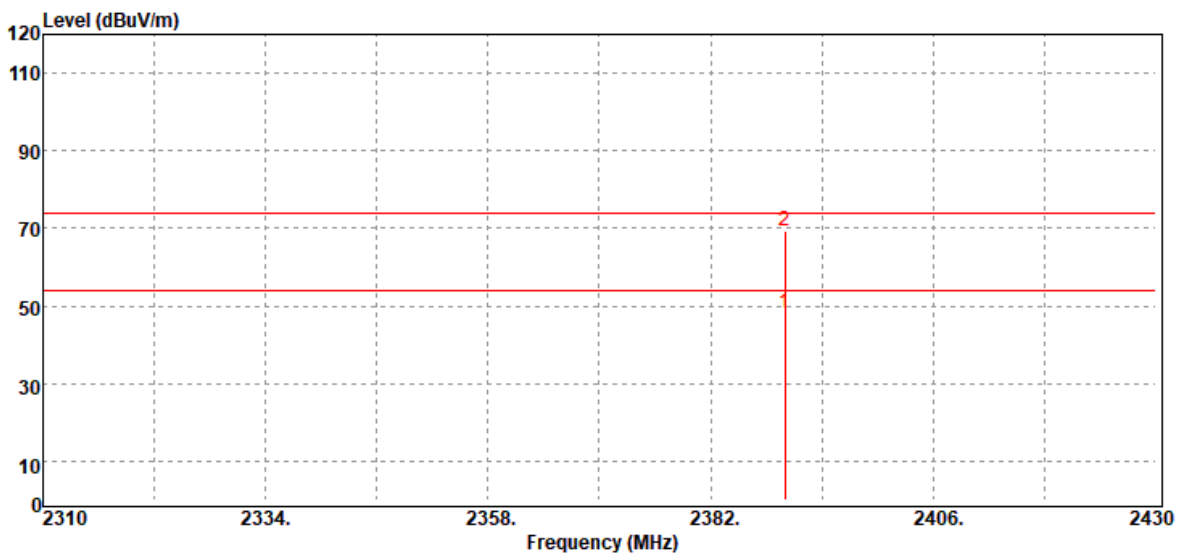

Frequency (MHz)	Detector Mode (PK/QP/AV)	Spectrum Reading Level (dBμV)	Factor (dB)	Actual FS (dBμV/m)	Limit @3m (dBμV/m)	Margin (dB)
2390.00	Average	51.38	-3.17	48.21	54.00	-5.79
2390.00	Peak	72.33	-3.17	69.16	74.00	-4.84



Report No.: T200407W01-RP3

Test Mode	IEEE 802.11n HT20 High CH 2462MHz	Temp/Hum	24(°C)/ 50%RH
Test Item	Band Edge	Test Date	June 4, 2020
Polarize	Vertical	Test Engineer	Jerry Chang
Detector	Peak / Average		

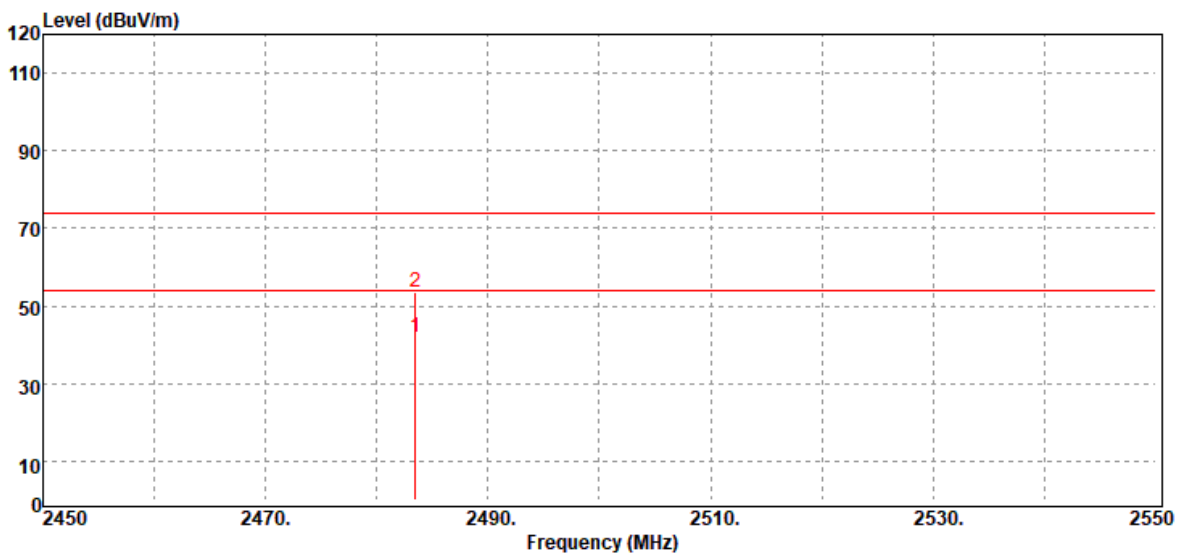

Frequency (MHz)	Detector Mode (PK/QP/AV)	Spectrum Reading Level (dB $\mu$ V)	Factor (dB)	Actual FS (dB $\mu$ V/m)	Limit @3m (dB $\mu$ V/m)	Margin (dB)
2483.50	Average	44.55	-2.71	41.84	54.00	-12.16
2483.50	Peak	56.44	-2.71	53.73	74.00	-20.27

Report No.: T200407W01-RP3

Test Mode	IEEE 802.11n20 High CH 2462MHz	Temp/Hum	24(°C)/ 50%RH
Test Item	Band Edge	Test Date	June 4, 2020
Polarize	Horizontal	Test Engineer	Jerry Chang
Detector	Peak & Average		

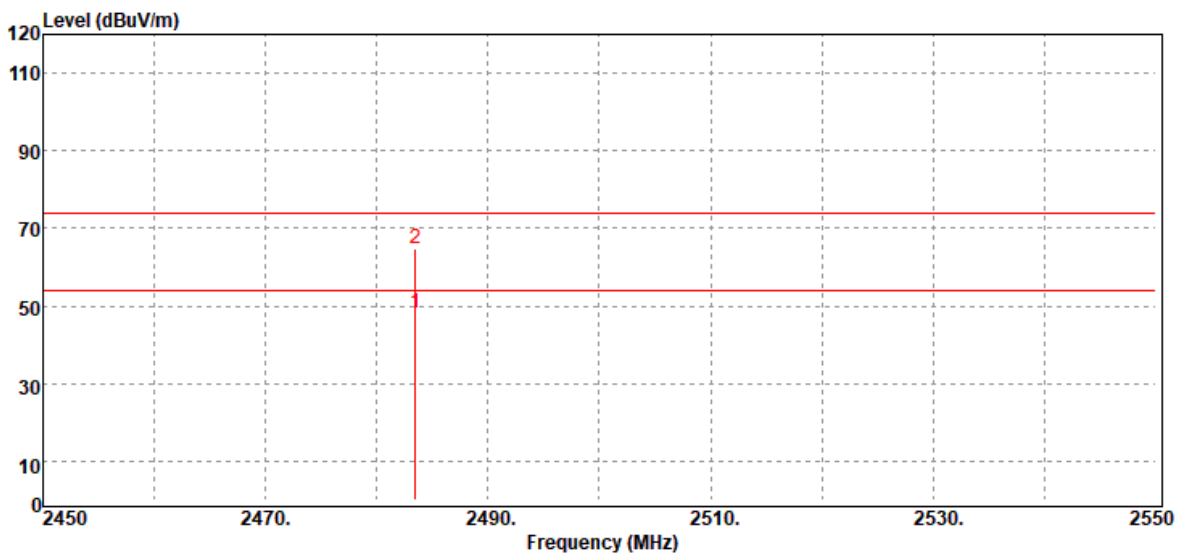

Frequency (MHz)	Detector Mode (PK/QP/AV)	Spectrum Reading Level (dBμV)	Factor (dB)	Actual FS (dBμV/m)	Limit @3m (dBμV/m)	Margin (dB)
2483.50	Average	51.04	-2.71	48.33	54.00	-5.67
2483.50	Peak	67.30	-2.71	64.59	74.00	-9.41

Report No.: T200407W01-RP3

Test Mode	IEEE 802.11n HT40 Low CH 2422MHz	Temp/Hum	24(°C)/ 50%RH
Test Item	Band Edge	Test Date	June 4, 2020
Polarize	Vertical	Test Engineer	Jerry Chang
Detector	Peak / Average	Test Voltage	

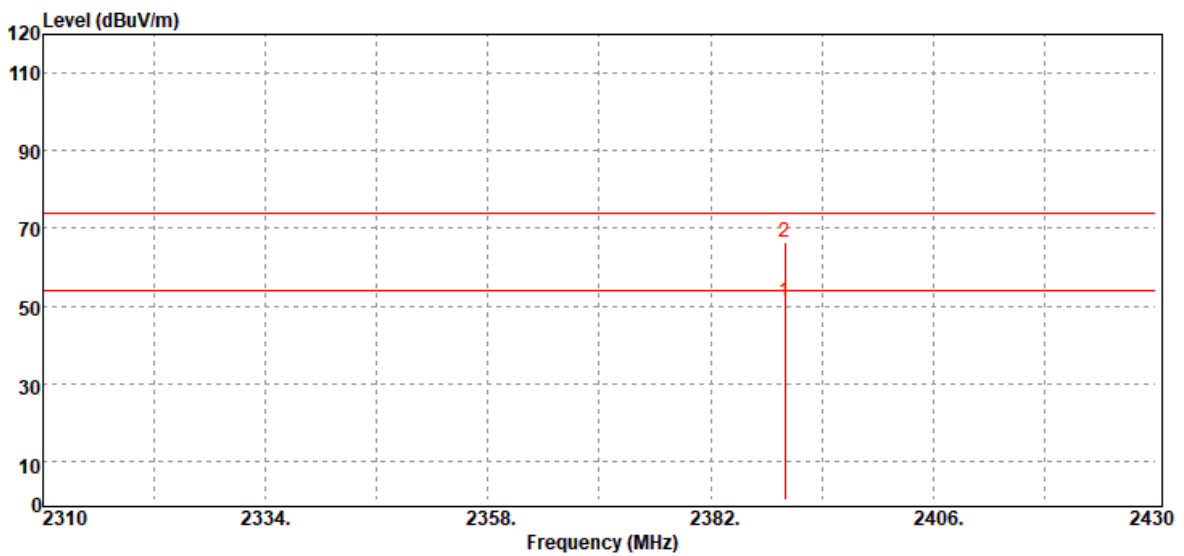

Frequency (MHz)	Detector Mode (PK/QP/AV)	Spectrum Reading Level (dBμV)	Factor (dB)	Actual FS (dBμV/m)	Limit @3m (dBμV/m)	Margin (dB)
2390.00	Average	54.12	-3.17	50.95	54.00	-3.05
2390.00	Peak	69.74	-3.17	66.57	74.00	-7.43

Report No.: T200407W01-RP3

Test Mode	IEEE 802.11n HT40 Low CH 2422MHz	Temp/Hum	24(°C)/ 50%RH
Test Item	Band Edge	Test Date	June 4, 2020
Polarize	Horizontal	Test Engineer	Jerry Chang
Detector	Peak / Average	Test Voltage	

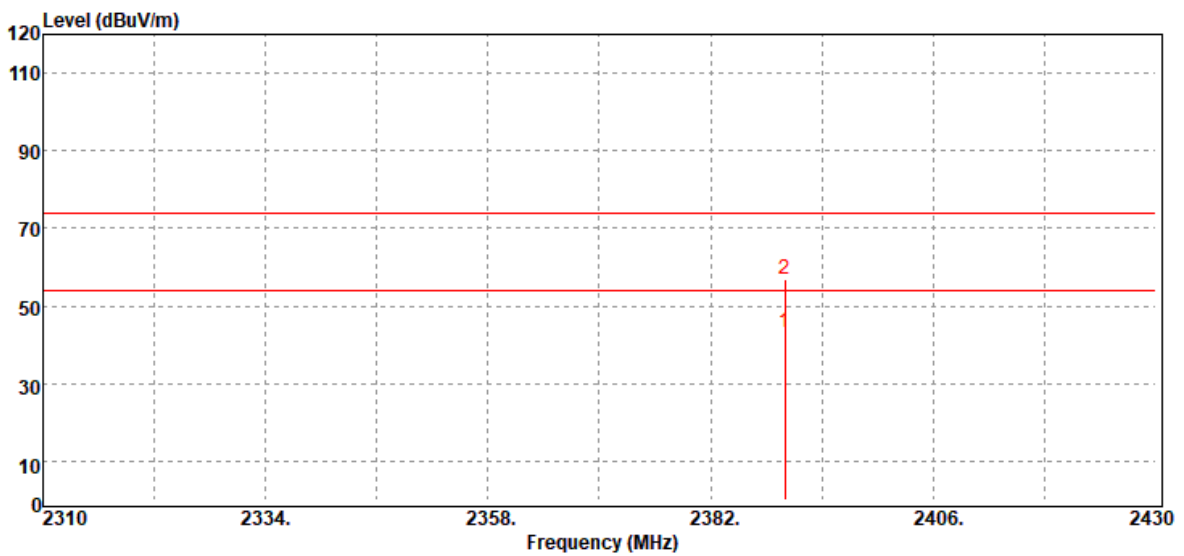

Frequency (MHz)	Detector Mode (PK/QP/AV)	Spectrum Reading Level (dBμV)	Factor (dB)	Actual FS (dBμV/m)	Limit @3m (dBμV/m)	Margin (dB)
2390.00	Average	46.24	-3.17	43.07	54.00	-10.93
2390.00	Peak	60.10	-3.17	56.93	74.00	-17.07

Report No.: T200407W01-RP3

Test Mode	IEEE 802.11n HT40 High CH 2452MHz	Temp/Hum	24(°C)/ 50%RH
Test Item	Band Edge	Test Date	June 4, 2020
Polarize	Vertical	Test Engineer	Jerry Chang
Detector	Peak / Average	Test Voltage	

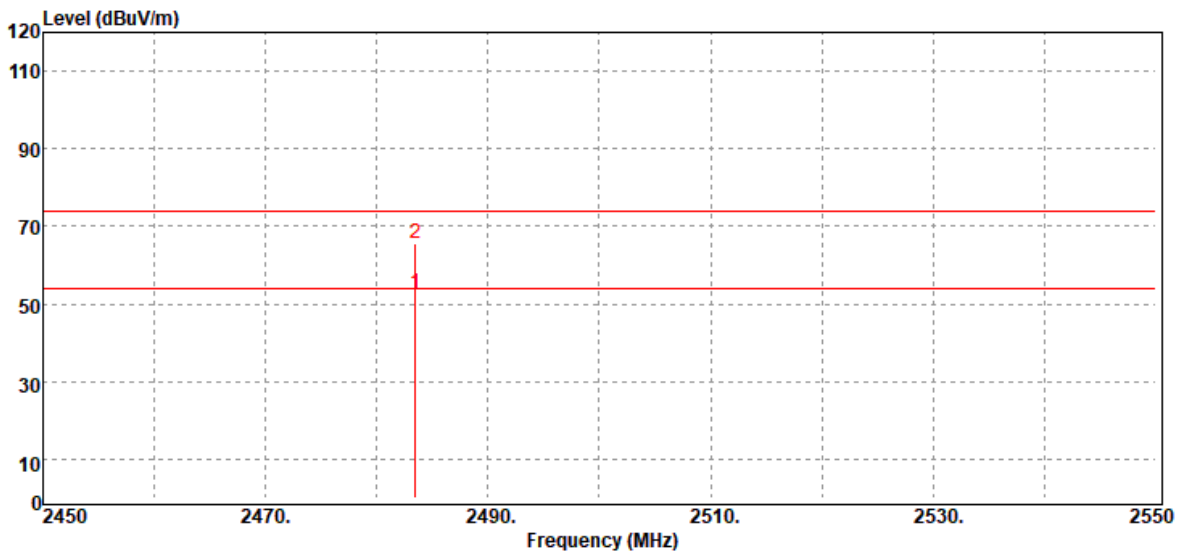

Frequency (MHz)	Detector Mode (PK/QP/AV)	Spectrum Reading Level (dB $\mu$ V)	Factor (dB)	Actual FS (dB $\mu$ V/m)	Limit @3m (dB $\mu$ V/m)	Margin (dB)
2483.50	Average	55.61	-2.71	52.90	54.00	-1.10
2483.50	Peak	68.41	-2.71	65.70	74.00	-8.30

Report No.: T200407W01-RP3

Test Mode	IEEE 802.11n HT40 High CH 2452MHz	Temp/Hum	24(°C)/ 50%RH
Test Item	Band Edge	Test Date	June 4, 2020
Polarize	Horizontal	Test Engineer	Jerry Chang
Detector	Peak / Average	Test Voltage	

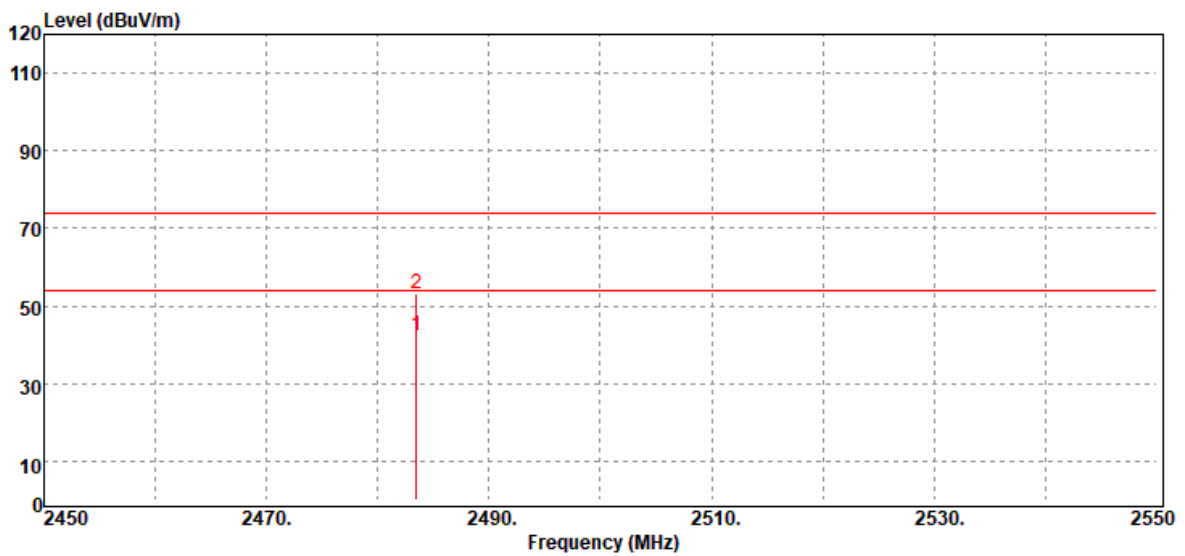

Frequency (MHz)	Detector Mode (PK/QP/AV)	Spectrum Reading Level (dB $\mu$ V)	Factor (dB)	Actual FS (dB $\mu$ V/m)	Limit @3m (dB $\mu$ V/m)	Margin (dB)
2483.50	Average	45.06	-2.71	42.35	54.00	-11.65
2483.50	Peak	55.67	-2.71	52.96	74.00	-21.04

Report No.: T200407W01-RP3

**Below 1G Test Data**

Test Mode	Mode 1	Temp/Hum	24(°C)/ 50%RH
Test Item	30MHz-1GHz	Test Date	June 5, 2020
Polarize	Vertical	Test Engineer	Jerry Chang
Detector	Peak	Test Voltage	

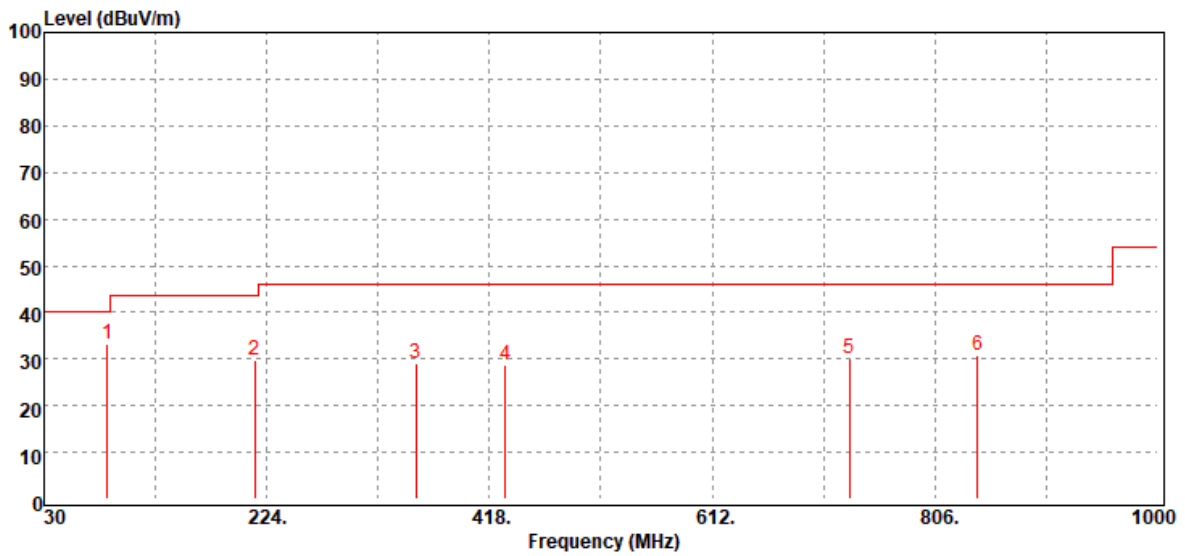

Freq. (MHz)	Detector Mode (PK/QP/AV)	Spectrum Reading Level (dBµV)	Factor (dB)	Actual FS (dBµV/m)	Limit @3m (dBµV/m)	Margin (dB)
84.86	Peak	48.92	-15.81	33.11	40.00	-6.89
213.54	Peak	41.51	-11.85	29.66	43.50	-13.84
354.15	Peak	36.20	-7.07	29.13	46.00	-16.87
431.49	Peak	33.58	-4.78	28.80	46.00	-17.20
731.50	Peak	29.55	0.54	30.09	46.00	-15.91
843.48	Peak	28.38	2.56	30.94	46.00	-15.06

*Note: No emission found between lowest internal used/generated frequency to 30MHz(9KHz~30MHz)*

Report No.: T200407W01-RP3

Test Mode	Mode 1	Temp/Hum	24(°C)/ 50%RH
Test Item	30MHz-1GHz	Test Date	June 5, 2020
Polarize	Horizontal	Test Engineer	Jerry Chang
Detector	Peak	Test Voltage	

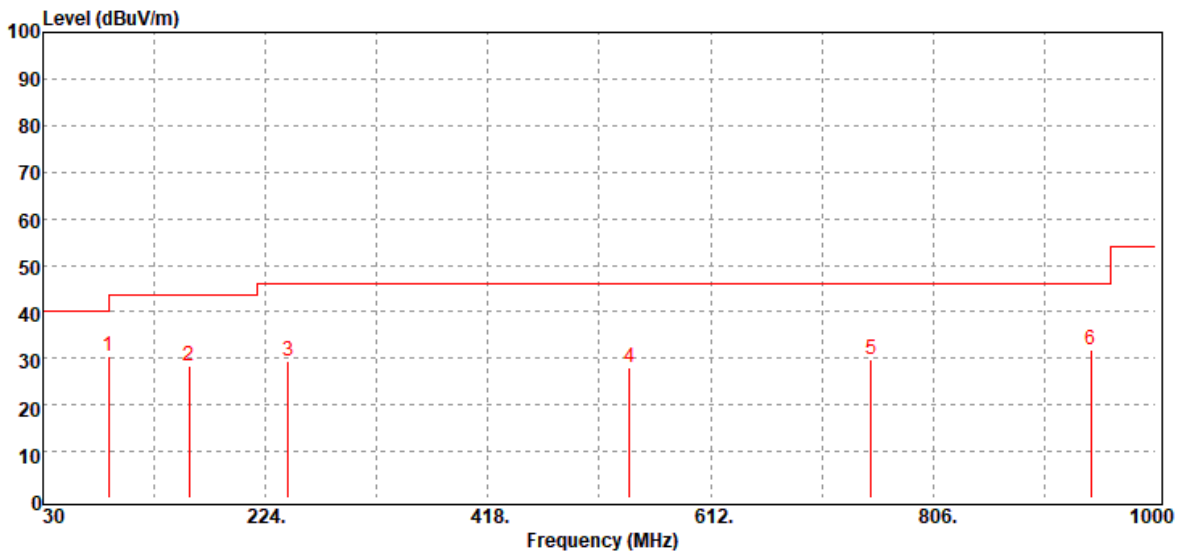

Freq. (MHz)	Detector Mode (PK/QP/AV)	Spectrum Reading Level (dBμV)	Factor (dB)	Actual FS (dBμV/m)	Limit @3m (dBμV/m)	Margin (dB)
87.14	Peak	46.19	-15.79	30.40	40.00	-9.60
157.38	Peak	38.84	-10.32	28.52	43.50	-14.98
243.86	Peak	39.92	-10.56	29.36	46.00	-16.64
541.56	Peak	30.44	-2.57	27.87	46.00	-18.13
751.61	Peak	29.04	0.86	29.90	46.00	-16.10
943.51	Peak	27.73	3.98	31.71	46.00	-14.29

Note: No emission found between lowest internal used/generated frequency to 30MHz(9KHz~30MHz)



Report No.: T200407W01-RP3

**Above 1G Test Data**

Test Mode	IEEE 802.11b Low CH	Temp/Hum	24(°C)/ 50%RH
Test Item	Harmonic	Test Date	June 5, 2020
Polarize	Vertical	Test Engineer	Jerry Chang
Detector	Peak		

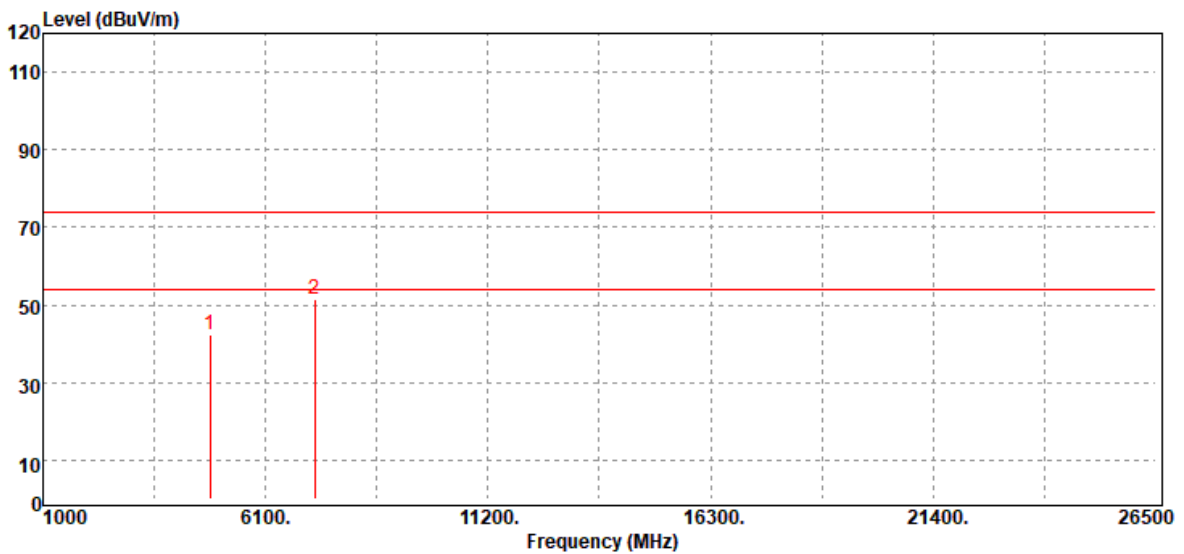

Freq. (MHz)	Detector Mode (PK/QP/AV)	Spectrum Reading Level (dBμV)	Factor (dB)	Actual FS (dBμV/m)	Limit @3m (dBμV/m)	Margin (dB)
4824.00	Peak	38.86	3.35	42.21	74.00	-31.79
7236.00	Peak	40.62	10.79	51.41	74.00	-22.59
N/A						

**Remark:**

1. Measuring frequencies from 1 GHz to the 10th harmonic of highest fundamental frequency.
2. For above 1GHz, the EUT peak value was under average limit, therefore the Average value compliance with the average limit

Report No.: T200407W01-RP3

Test Mode	IEEE 802.11b Low CH	Temp/Hum	24(°C)/ 50%RH
Test Item	Harmonic	Test Date	June 5, 2020
Polarize	Horizontal	Test Engineer	Jerry Chang
Detector	Peak		

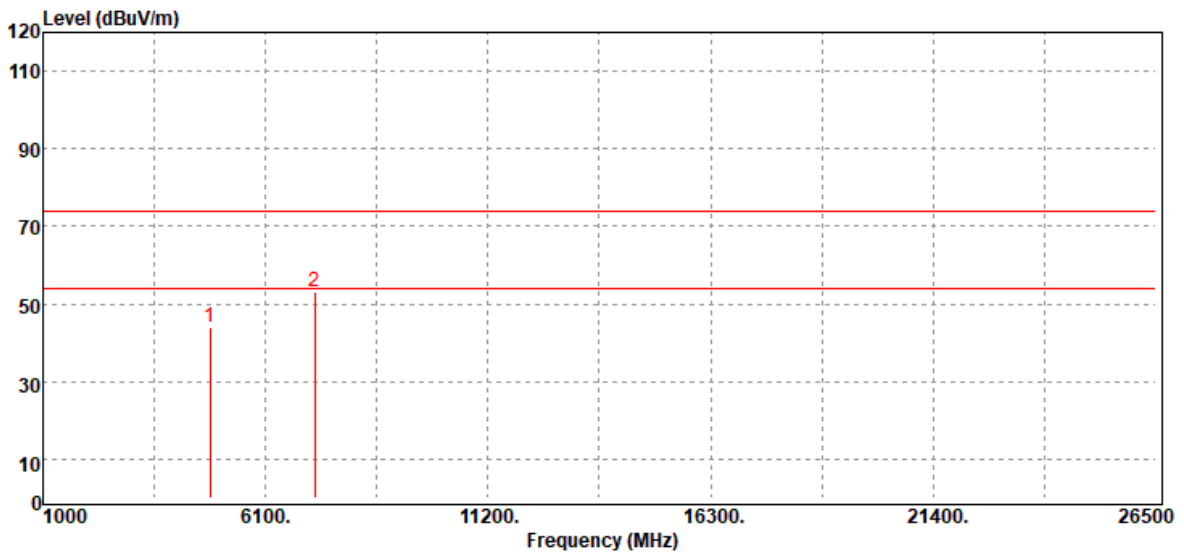

Freq. (MHz)	Detector Mode (PK/QP/AV)	Spectrum Reading Level (dBμV)	Factor (dB)	Actual FS (dBμV/m)	Limit @3m (dBμV/m)	Margin (dB)
4824.00	Peak	40.71	3.35	44.06	74.00	-29.94
7236.00	Peak	42.31	10.79	53.10	74.00	-20.90
N/A						

**Remark:**

1. Measuring frequencies from 1 GHz to the 10th harmonic of highest fundamental frequency.
2. For above 1GHz, the EUT peak value was under average limit, therefore the Average value compliance with the average limit

Report No.: T200407W01-RP3

Test Mode	IEEE 802.11b Mid CH	Temp/Hum	24(°C)/ 50%RH
Test Item	Harmonic	Test Date	June 5, 2020
Polarize	Vertical	Test Engineer	Jerry Chang
Detector	Peak		

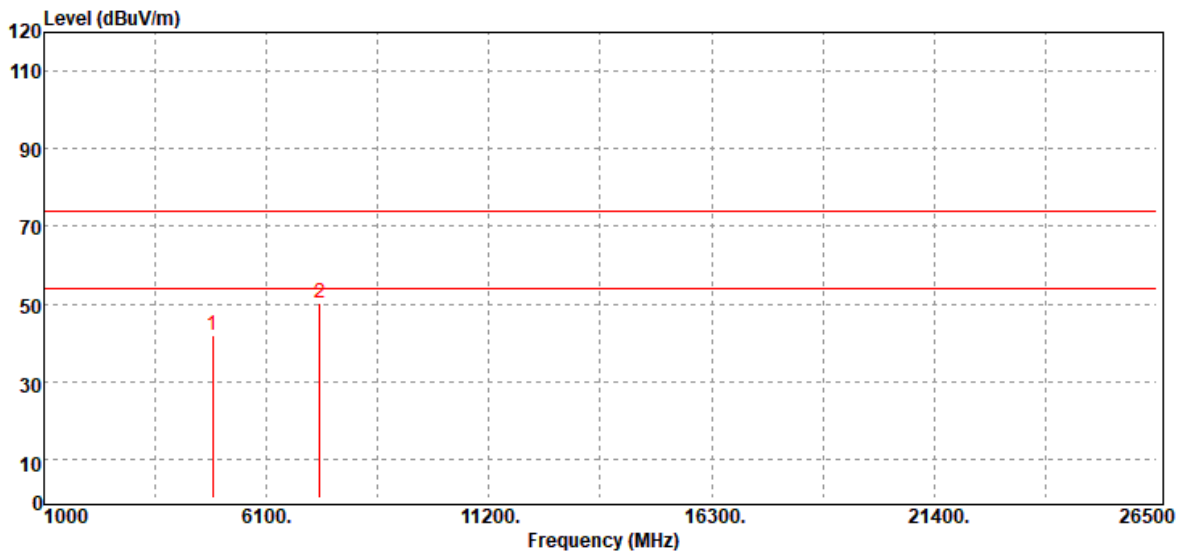

Freq. (MHz)	Detector Mode (PK/QP/AV)	Spectrum Reading Level (dBμV)	Factor (dB)	Actual FS (dBμV/m)	Limit @3m (dBμV/m)	Margin (dB)
4874.00	Peak	38.60	3.48	42.08	74.00	-31.92
7311.00	Peak	39.19	11.06	50.25	74.00	-23.75
N/A						

**Remark:**

1. Measuring frequencies from 1 GHz to the 10th harmonic of highest fundamental frequency.
2. For above 1GHz, the EUT peak value was under average limit, therefore the Average value compliance with the average limit

Report No.: T200407W01-RP3

Test Mode	IEEE 802.11b Mid CH	Temp/Hum	24(°C)/ 50%RH
Test Item	Harmonic	Test Date	June 5, 2020
Polarize	Horizontal	Test Engineer	Jerry Chang
Detector	Peak		

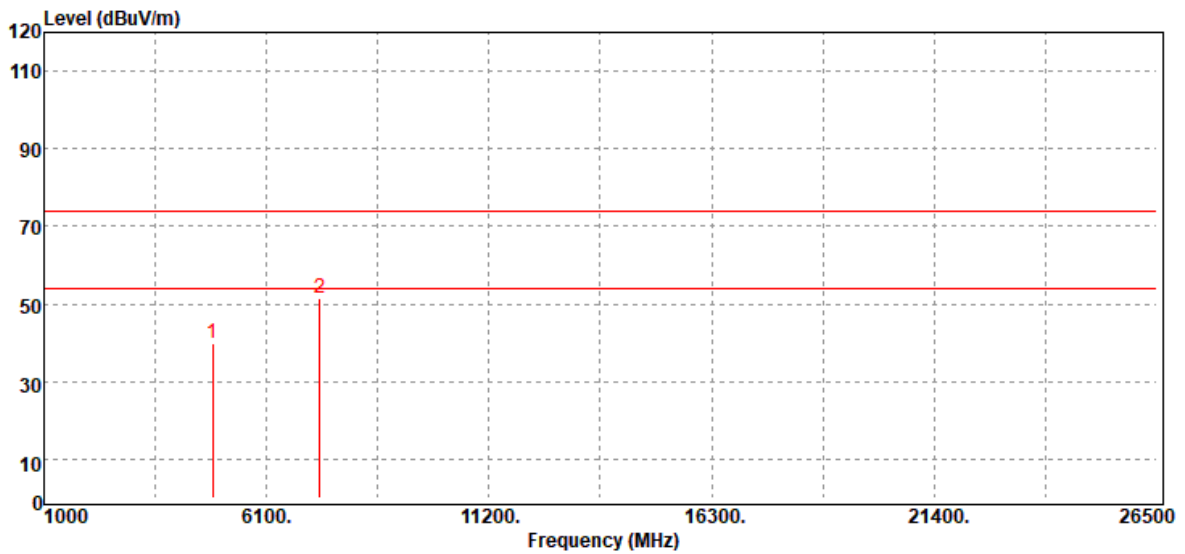

Freq. (MHz)	Detector Mode (PK/QP/AV)	Spectrum Reading Level (dBμV)	Factor (dB)	Actual FS (dBμV/m)	Limit @3m (dBμV/m)	Margin (dB)
4874.00	Peak	36.41	3.48	39.89	74.00	-34.11
7311.00	Peak	40.57	11.06	51.63	74.00	-22.37
N/A						

**Remark:**

1. Measuring frequencies from 1 GHz to the 10th harmonic of highest fundamental frequency.
2. For above 1GHz, the EUT peak value was under average limit, therefore the Average value compliance with the average limit

Report No.: T200407W01-RP3

Test Mode	IEEE 802.11b High CH	Temp/Hum	24(°C)/ 50%RH
Test Item	Harmonic	Test Date	June 5, 2020
Polarize	Vertical	Test Engineer	Jerry Chang
Detector	Peak		

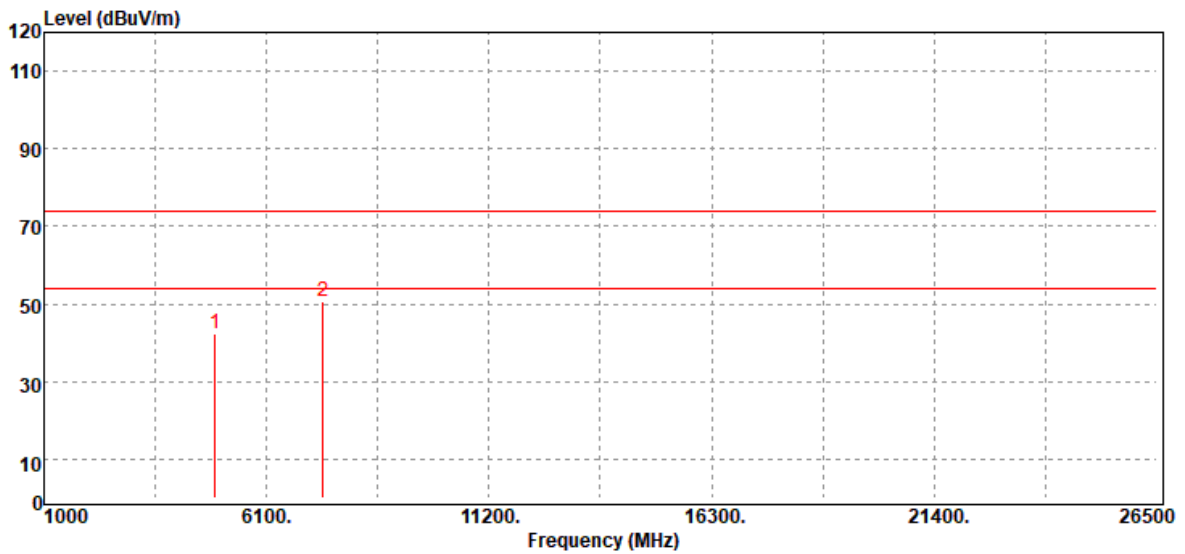

Freq. (MHz)	Detector Mode (PK/QP/AV)	Spectrum Reading Level (dBμV)	Factor (dB)	Actual FS (dBμV/m)	Limit @3m (dBμV/m)	Margin (dB)
4924.00	Peak	38.44	4.01	42.45	74.00	-31.55
7386.00	Peak	40.06	10.80	50.86	74.00	-23.14
N/A						

**Remark:**

1. Measuring frequencies from 1 GHz to the 10th harmonic of highest fundamental frequency.
2. For above 1GHz, the EUT peak value was under average limit, therefore the Average value compliance with the average limit

Report No.: T200407W01-RP3

Test Mode	IEEE 802.11b High CH	Temp/Hum	24(°C)/ 50%RH
Test Item	Harmonic	Test Date	June 5, 2020
Polarize	Horizontal	Test Engineer	Jerry Chang
Detector	Peak		

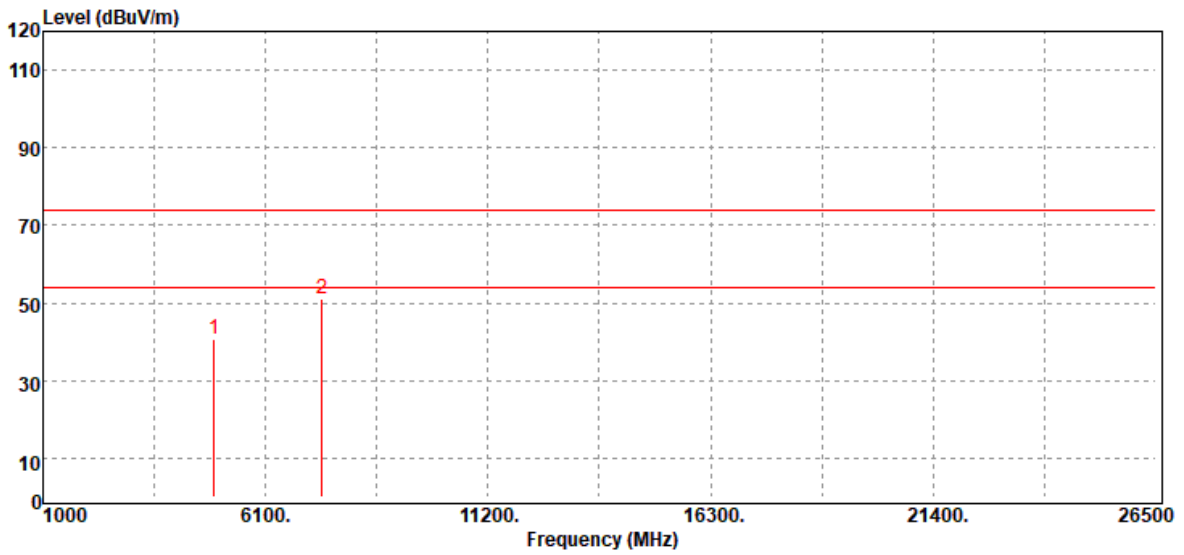

Freq. (MHz)	Detector Mode (PK/QP/AV)	Spectrum Reading Level (dBμV)	Factor (dB)	Actual FS (dBμV/m)	Limit @3m (dBμV/m)	Margin (dB)
4924.00	Peak	36.84	4.01	40.85	74.00	-33.15
7386.00	Peak	40.44	10.80	51.24	74.00	-22.76
N/A						

**Remark:**

1. Measuring frequencies from 1 GHz to the 10th harmonic of highest fundamental frequency.
2. For above 1GHz, the EUT peak value was under average limit, therefore the Average value compliance with the average limit

Report No.: T200407W01-RP3

Test Mode	IEEE 802.11g Low CH	Temp/Hum	24(°C)/ 50%RH
Test Item	Harmonic	Test Date	June 5, 2020
Polarize	Vertical	Test Engineer	Jerry Chang
Detector	Peak		

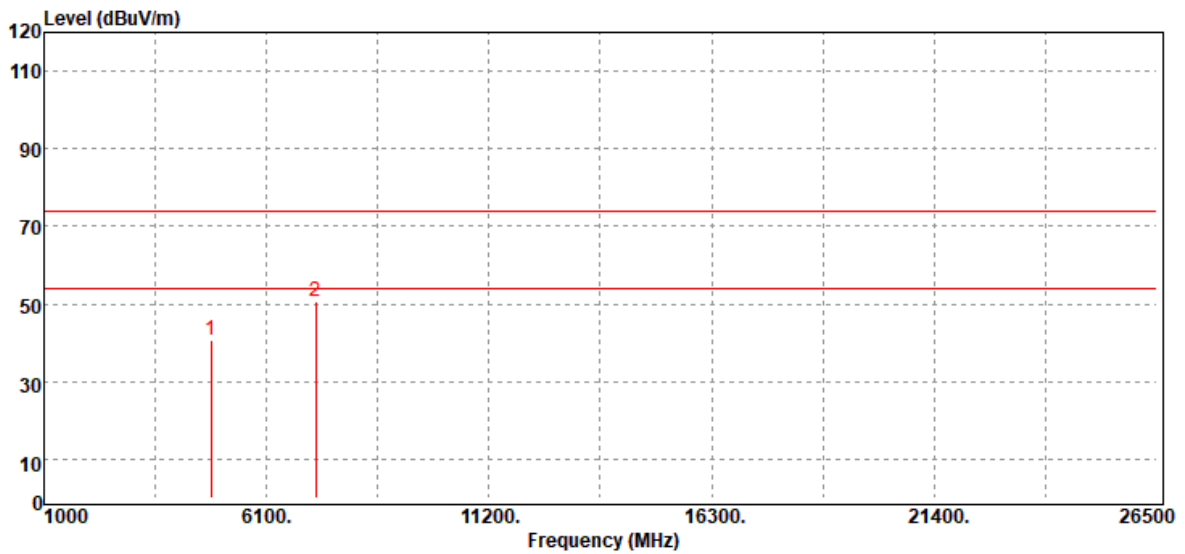

Freq. (MHz)	Detector Mode (PK/QP/AV)	Spectrum Reading Level (dBµV)	Factor (dB)	Actual FS (dBµV/m)	Limit @3m (dBµV/m)	Margin (dB)
4824.00	Peak	37.52	3.35	40.87	74.00	-33.13
7236.00	Peak	40.04	10.79	50.83	74.00	-23.17
N/A						

**Remark:**

1. Measuring frequencies from 1 GHz to the 10th harmonic of highest fundamental frequency.
2. For above 1GHz, the EUT peak value was under average limit, therefore the Average value compliance with the average limit

Report No.: T200407W01-RP3

Test Mode	IEEE 802.11g Low CH	Temp/Hum	24(°C)/ 50%RH
Test Item	Harmonic	Test Date	June 5, 2020
Polarize	Horizontal	Test Engineer	Jerry Chang
Detector	Peak		

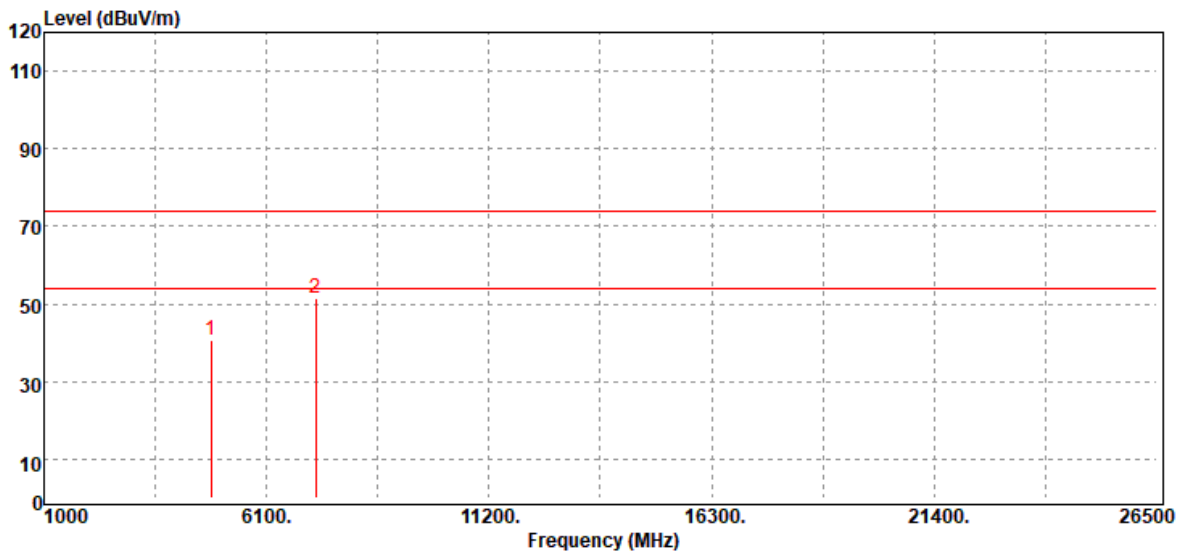

Freq. (MHz)	Detector Mode (PK/QP/AV)	Spectrum Reading Level (dBμV)	Factor (dB)	Actual FS (dBμV/m)	Limit @3m (dBμV/m)	Margin (dB)
4824.00	Peak	37.27	3.35	40.62	74.00	-33.38
7236.00	Peak	40.79	10.79	51.58	74.00	-22.42
N/A						

**Remark:**

1. Measuring frequencies from 1 GHz to the 10th harmonic of highest fundamental frequency.
2. For above 1GHz, the EUT peak value was under average limit, therefore the Average value compliance with the average limit



Report No.: T200407W01-RP3

Test Mode	IEEE 802.11g Mid CH	Temp/Hum	24(°C)/ 50%RH
Test Item	Harmonic	Test Date	June 5, 2020
Polarize	Vertical	Test Engineer	Jerry Chang
Detector	Peak		

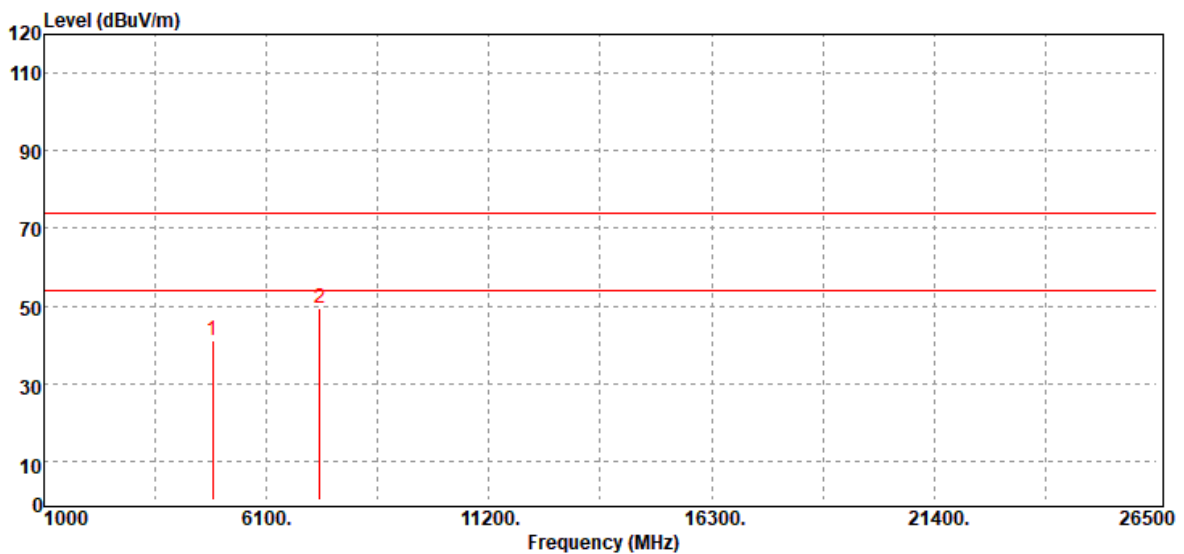

Freq. (MHz)	Detector Mode (PK/QP/AV)	Spectrum Reading Level (dBμV)	Factor (dB)	Actual FS (dBμV/m)	Limit @3m (dBμV/m)	Margin (dB)
4874.00	Peak	37.76	3.48	41.24	74.00	-32.76
7311.00	Peak	38.50	11.06	49.56	74.00	-24.44
N/A						

**Remark:**

1. Measuring frequencies from 1 GHz to the 10th harmonic of highest fundamental frequency.
2. For above 1GHz, the EUT peak value was under average limit, therefore the Average value compliance with the average limit

Report No.: T200407W01-RP3

Test Mode	IEEE 802.11g Mid CH	Temp/Hum	24(°C)/ 50%RH
Test Item	Harmonic	Test Date	June 5, 2020
Polarize	Horizontal	Test Engineer	Jerry Chang
Detector	Peak		

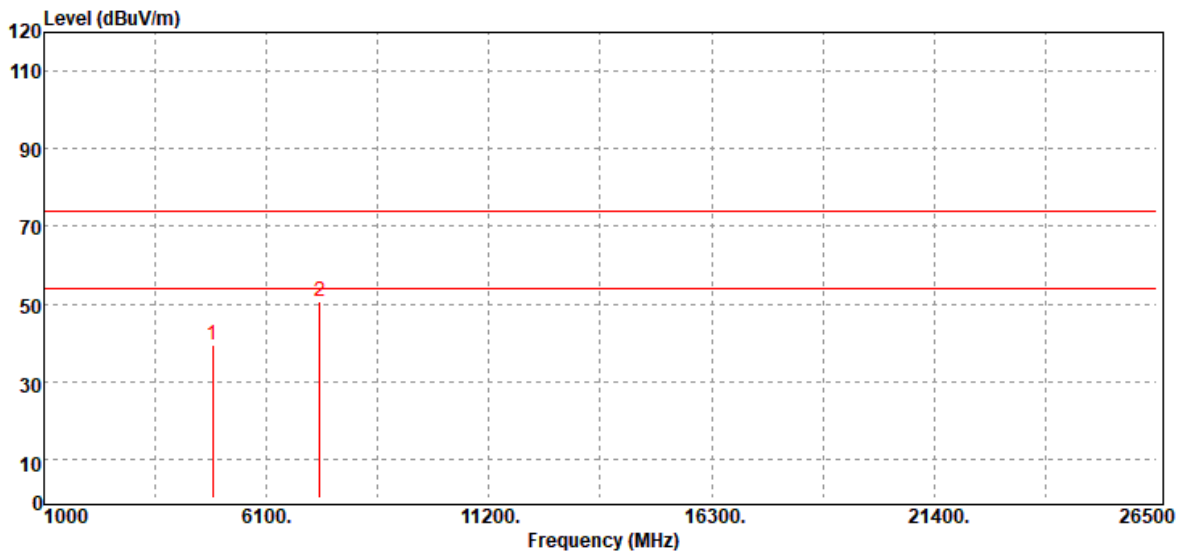

Freq. (MHz)	Detector Mode (PK/QP/AV)	Spectrum Reading Level (dB $\mu$ V)	Factor (dB)	Actual FS (dB $\mu$ V/m)	Limit @3m (dB $\mu$ V/m)	Margin (dB)
4874.00	Peak	36.09	3.48	39.57	74.00	-34.43
7311.00	Peak	39.72	11.06	50.78	74.00	-23.22
N/A						

**Remark:**

1. Measuring frequencies from 1 GHz to the 10th harmonic of highest fundamental frequency.
2. For above 1GHz, the EUT peak value was under average limit, therefore the Average value compliance with the average limit

Report No.: T200407W01-RP3

Test Mode	IEEE 802.11g High CH	Temp/Hum	24(°C)/ 50%RH
Test Item	Harmonic	Test Date	June 5, 2020
Polarize	Vertical	Test Engineer	Jerry Chang
Detector	Peak		

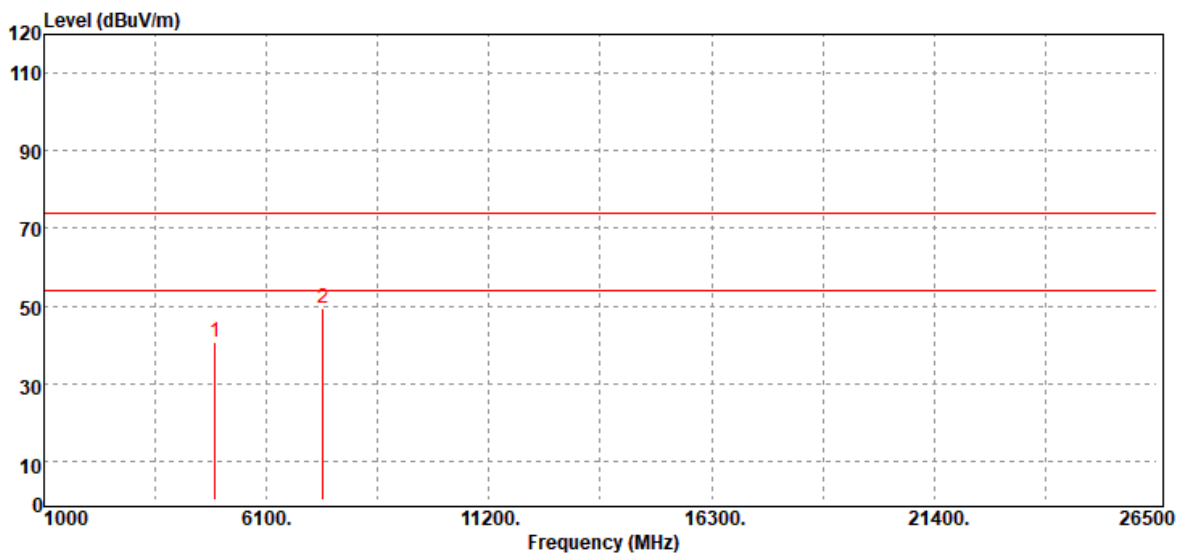

Freq. (MHz)	Detector Mode (PK/QP/AV)	Spectrum Reading Level (dBμV)	Factor (dB)	Actual FS (dBμV/m)	Limit @3m (dBμV/m)	Margin (dB)
4924.00	Peak	36.58	4.01	40.59	74.00	-33.41
7386.00	Peak	38.74	10.80	49.54	74.00	-24.46
N/A						

**Remark:**

1. Measuring frequencies from 1 GHz to the 10th harmonic of highest fundamental frequency.
2. For above 1GHz, the EUT peak value was under average limit, therefore the Average value compliance with the average limit

Report No.: T200407W01-RP3

Test Mode	IEEE 802.11g High CH	Temp/Hum	24(°C)/ 50%RH
Test Item	Harmonic	Test Date	June 5, 2020
Polarize	Horizontal	Test Engineer	Jerry Chang
Detector	Peak		

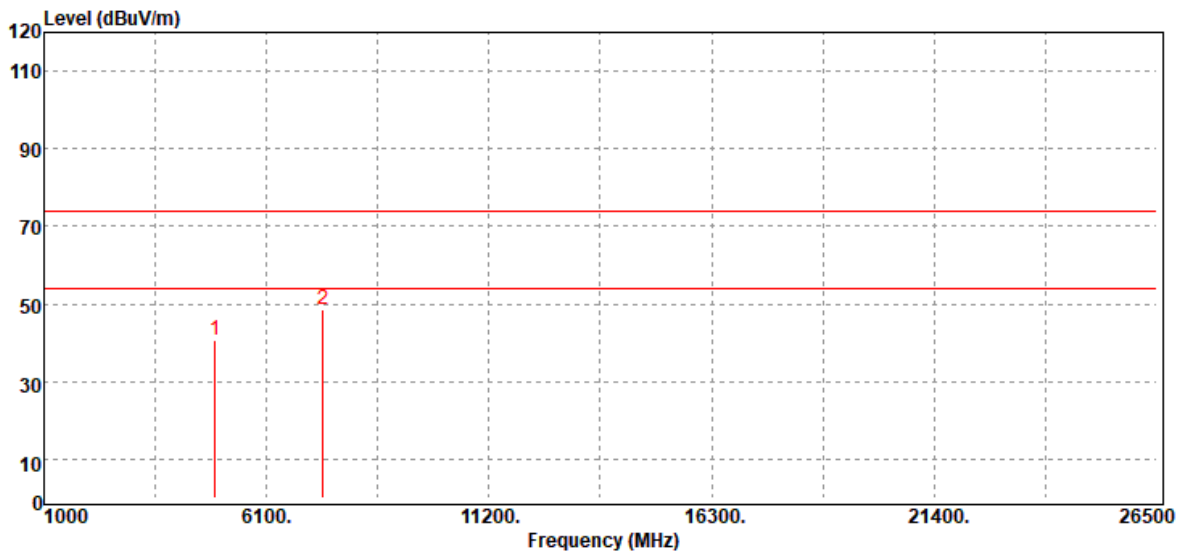

Freq. (MHz)	Detector Mode (PK/QP/AV)	Spectrum Reading Level (dBμV)	Factor (dB)	Actual FS (dBμV/m)	Limit @3m (dBμV/m)	Margin (dB)
4924.00	Peak	36.59	4.01	40.60	74.00	-33.40
7386.00	Peak	37.72	10.80	48.52	74.00	-25.48
N/A						

**Remark:**

1. Measuring frequencies from 1 GHz to the 10th harmonic of highest fundamental frequency.
2. For above 1GHz, the EUT peak value was under average limit, therefore the Average value compliance with the average limit

Report No.: T200407W01-RP3

Test Mode	IEEE 802.11n HT20 Low CH	Temp/Hum	24(°C)/ 50%RH
Test Item	Harmonic	Test Date	June 5, 2020
Polarize	Vertical	Test Engineer	Jerry Chang
Detector	Peak		

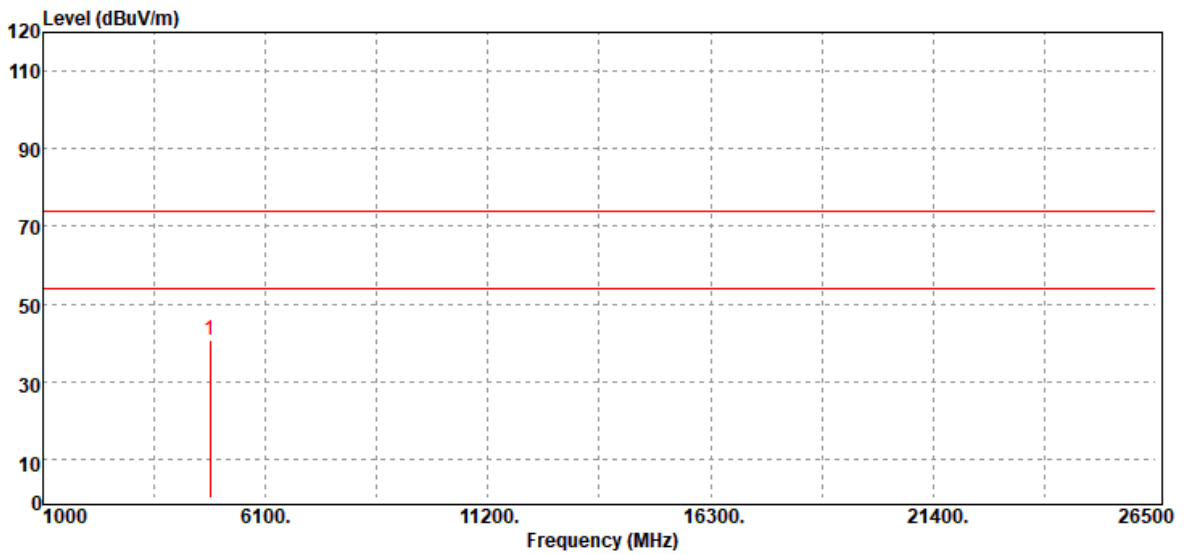

Freq. (MHz)	Detector Mode (PK/QP/AV)	Spectrum Reading Level (dB $\mu$ V)	Factor (dB)	Actual FS (dB $\mu$ V/m)	Limit @3m (dB $\mu$ V/m)	Margin (dB)
4824.00	Peak	37.38	3.35	40.73	74.00	-33.27
N/A						

**Remark:**

1. Measuring frequencies from 1 GHz to the 10th harmonic of highest fundamental frequency.
2. For above 1GHz, the EUT peak value was under average limit, therefore the Average value compliance with the average limit

Report No.: T200407W01-RP3

Test Mode	IEEE 802.11n HT20 Low CH	Temp/Hum	24(°C)/ 50%RH
Test Item	Harmonic	Test Date	June 5, 2020
Polarize	Horizontal	Test Engineer	Jerry Chang
Detector	Peak		

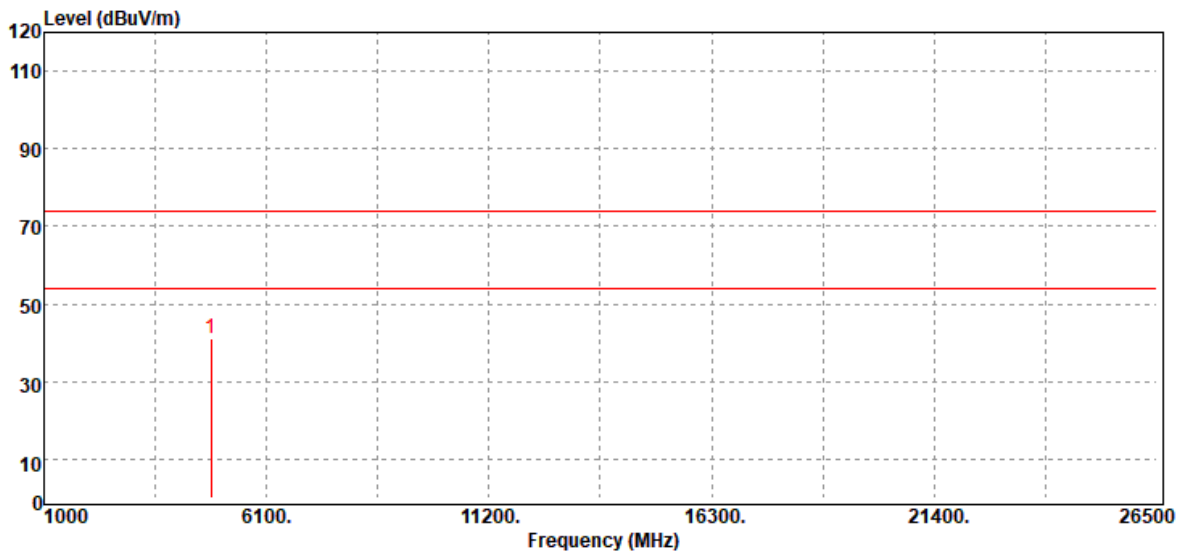

Freq. (MHz)	Detector Mode (PK/QP/AV)	Spectrum Reading Level (dB $\mu$ V)	Factor (dB)	Actual FS (dB $\mu$ V/m)	Limit @3m (dB $\mu$ V/m)	Margin (dB)
4824.00	Peak	37.61	3.35	40.96	74.00	-33.04
N/A						

**Remark:**

1. Measuring frequencies from 1 GHz to the 10th harmonic of highest fundamental frequency.
2. For above 1GHz, the EUT peak value was under average limit, therefore the Average value compliance with the average limit

Report No.: T200407W01-RP3

Test Mode	IEEE 802.11n HT20 Mid CH	Temp/Hum	24(°C)/ 50%RH
Test Item	Harmonic	Test Date	June 5, 2020
Polarize	Vertical	Test Engineer	Jerry Chang
Detector	Peak		

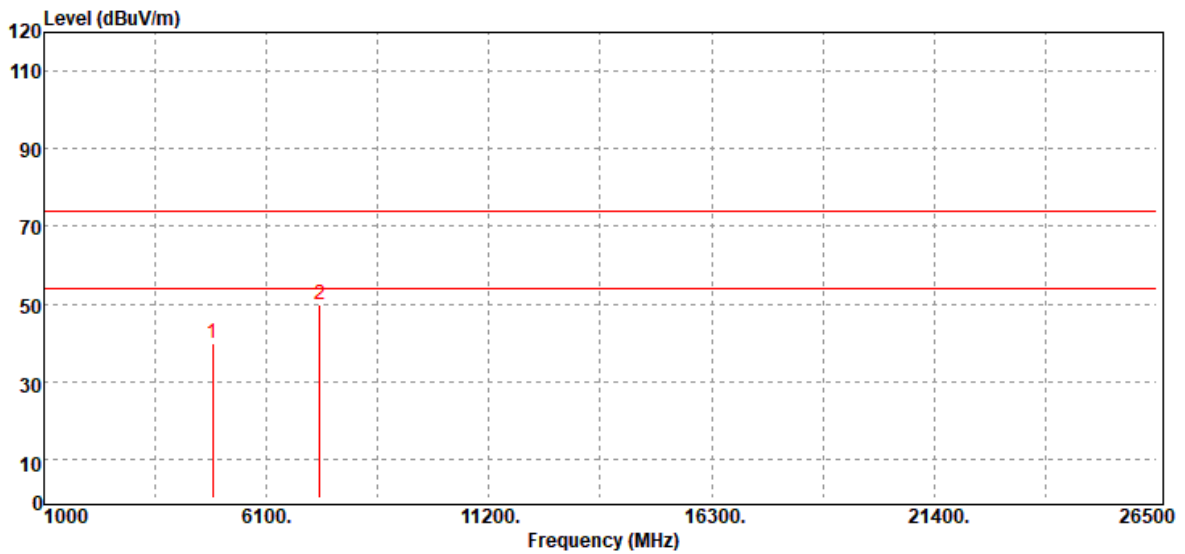

Freq. (MHz)	Detector Mode (PK/QP/AV)	Spectrum Reading Level (dBµV)	Factor (dB)	Actual FS (dBµV/m)	Limit @3m (dBµV/m)	Margin (dB)
4874.00	Peak	36.30	3.48	39.78	74.00	-34.22
7311.00	Peak	38.82	11.06	49.88	74.00	-24.12
N/A						

**Remark:**

1. Measuring frequencies from 1 GHz to the 10th harmonic of highest fundamental frequency.
2. For above 1GHz, the EUT peak value was under average limit, therefore the Average value compliance with the average limit

Report No.: T200407W01-RP3

Test Mode	IEEE 802.11n HT20 Mid CH	Temp/Hum	24(°C)/ 50%RH
Test Item	Harmonic	Test Date	June 5, 2020
Polarize	Horizontal	Test Engineer	Jerry Chang
Detector	Peak		

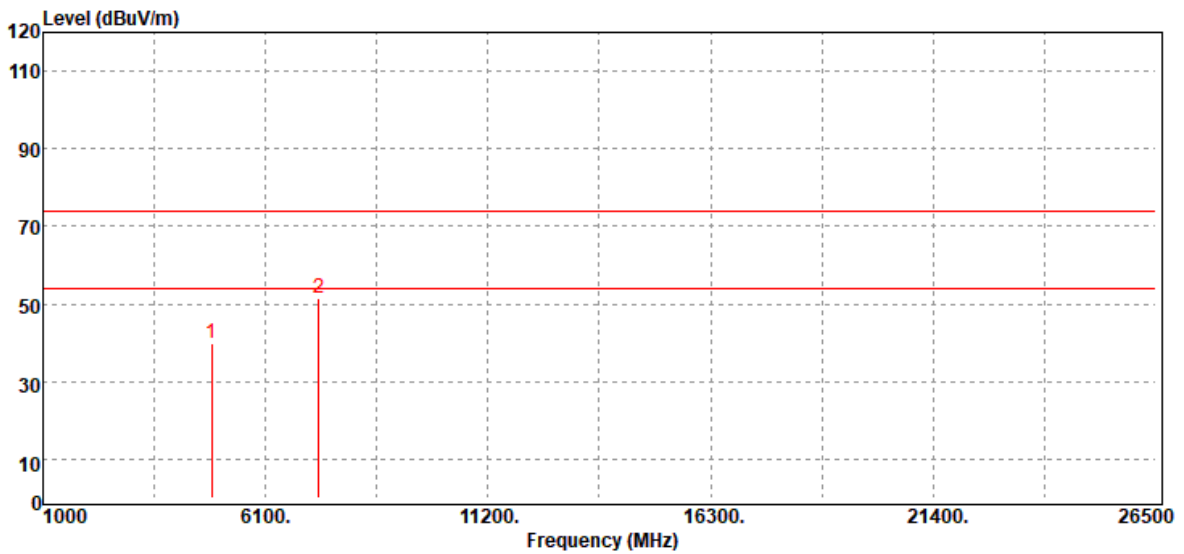

Freq. (MHz)	Detector Mode (PK/QP/AV)	Spectrum Reading Level (dBμV)	Factor (dB)	Actual FS (dBμV/m)	Limit @3m (dBμV/m)	Margin (dB)
4874.00	Peak	36.20	3.48	39.68	74.00	-34.32
7311.00	Peak	40.57	11.06	51.63	74.00	-22.37
N/A						

**Remark:**

1. Measuring frequencies from 1 GHz to the 10th harmonic of highest fundamental frequency.
2. For above 1GHz, the EUT peak value was under average limit, therefore the Average value compliance with the average limit



Report No.: T200407W01-RP3

Test Mode	IEEE 802.11n HT20 High CH	Temp/Hum	24(°C)/ 50%RH
Test Item	Harmonic	Test Date	June 5, 2020
Polarize	Vertical	Test Engineer	Jerry Chang
Detector	Peak		

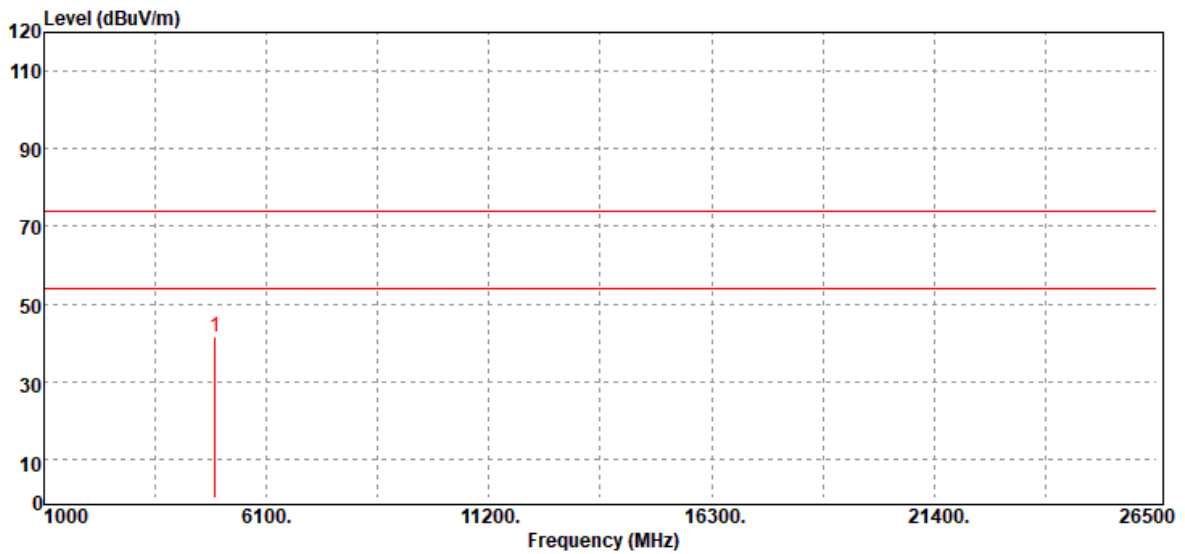

Freq. (MHz)	Detector Mode (PK/QP/AV)	Spectrum Reading Level (dB $\mu$ V)	Factor (dB)	Actual FS (dB $\mu$ V/m)	Limit @3m (dB $\mu$ V/m)	Margin (dB)
4924.00	Peak	37.33	4.01	41.34	74.00	-32.66
N/A						

**Remark:**

1. Measuring frequencies from 1 GHz to the 10th harmonic of highest fundamental frequency.
2. For above 1GHz, the EUT peak value was under average limit, therefore the Average value compliance with the average limit

Report No.: T200407W01-RP3

Test Mode	IEEE 802.11n HT20 High CH	Temp/Hum	24(°C)/ 50%RH
Test Item	Harmonic	Test Date	June 5, 2020
Polarize	Horizontal	Test Engineer	Jerry Chang
Detector	Peak		

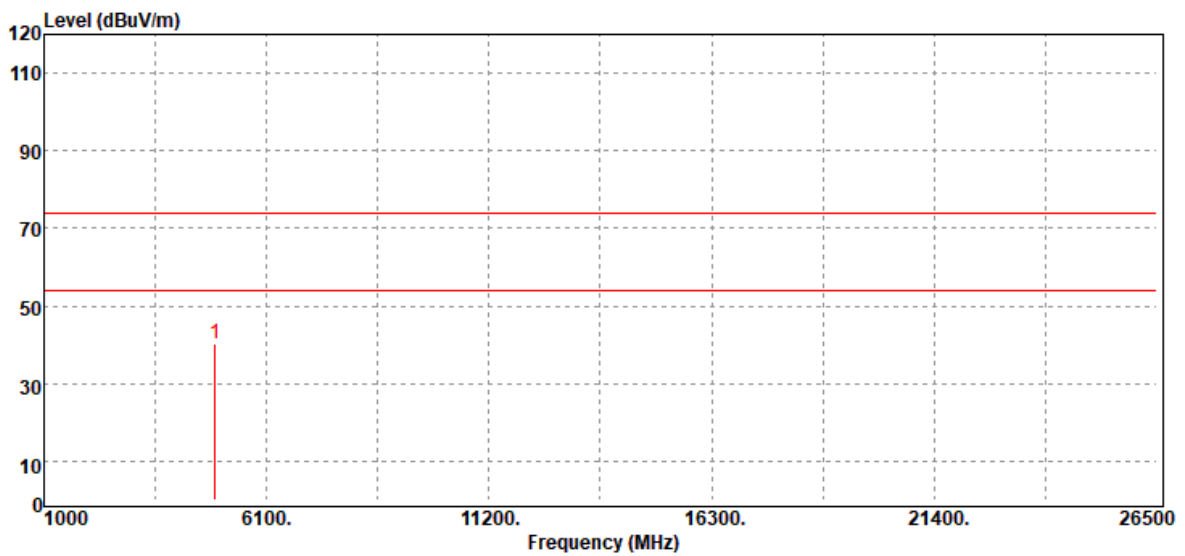

Freq. (MHz)	Detector Mode (PK/QP/AV)	Spectrum Reading Level (dB $\mu$ V)	Factor (dB)	Actual FS (dB $\mu$ V/m)	Limit @3m (dB $\mu$ V/m)	Margin (dB)
4924.00	Peak	36.31	4.01	40.32	74.00	-33.68
N/A						

**Remark:**

1. Measuring frequencies from 1 GHz to the 10th harmonic of highest fundamental frequency.
2. For above 1GHz, the EUT peak value was under average limit, therefore the Average value compliance with the average limit

Report No.: T200407W01-RP3

Test Mode	IEEE 802.11n HT40 Low CH	Temp/Hum	24(°C)/ 50%RH
Test Item	Harmonic	Test Date	June 5, 2020
Polarize	Vertical	Test Engineer	Jerry Chang
Detector	Peak		

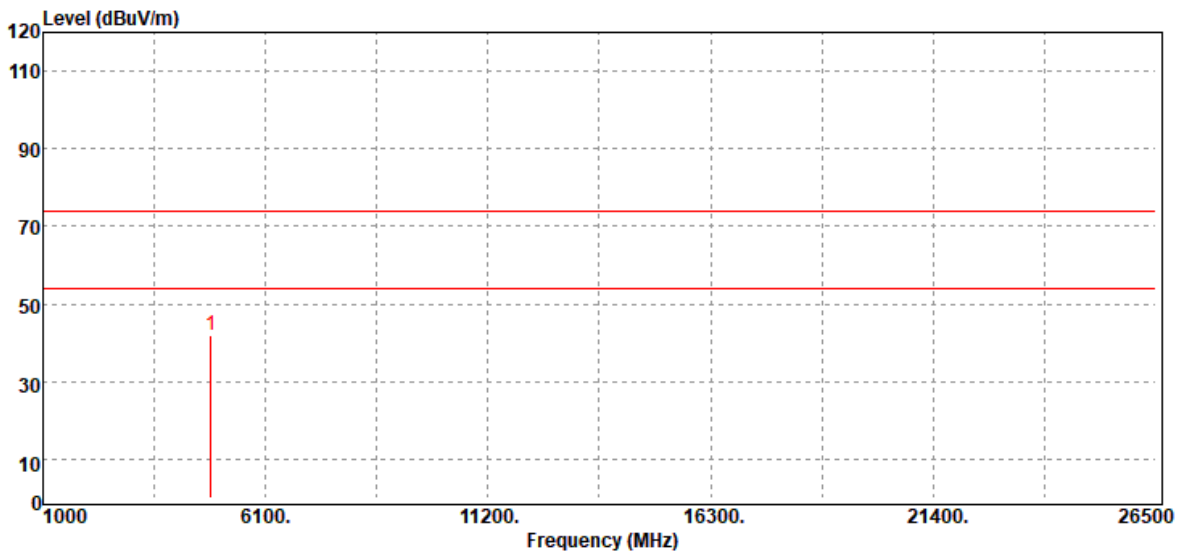

Freq. (MHz)	Detector Mode (PK/QP/AV)	Spectrum Reading Level (dBμV)	Factor (dB)	Actual FS (dBμV/m)	Limit @3m (dBμV/m)	Margin (dB)
4844.00	Peak	38.62	3.35	41.97	74.00	-32.03
N/A						

**Remark:**

1. Measuring frequencies from 1 GHz to the 10th harmonic of highest fundamental frequency.
2. For above 1GHz, the EUT peak value was under average limit, therefore the Average value compliance with the average limit

Report No.: T200407W01-RP3

Test Mode	IEEE 802.11n HT40 Low CH	Temp/Hum	24(°C)/ 50%RH
Test Item	Harmonic	Test Date	June 5, 2020
Polarize	Horizontal	Test Engineer	Jerry Chang
Detector	Peak		

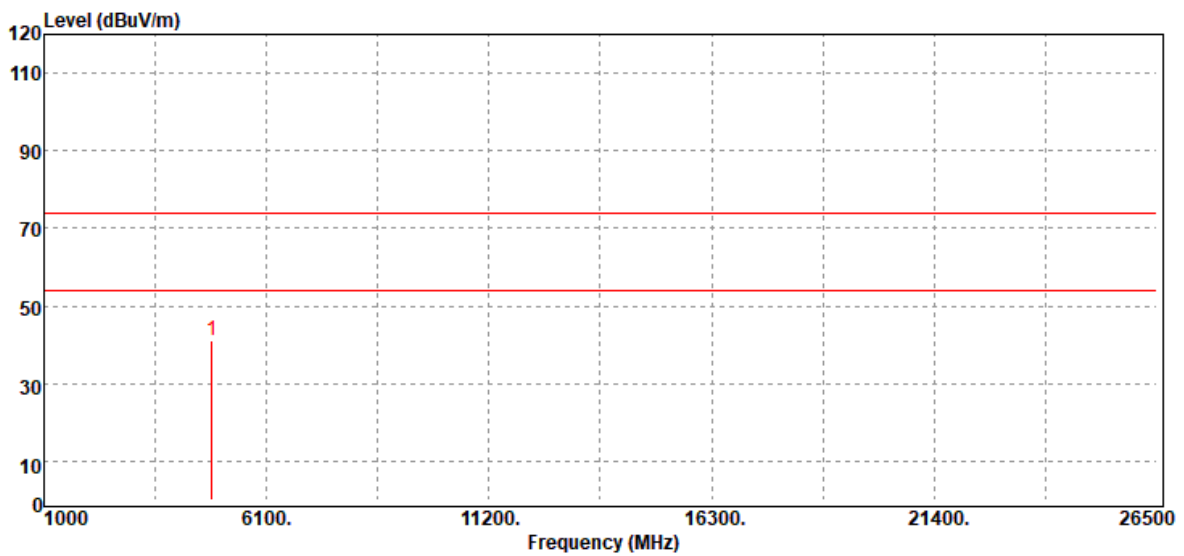

Freq. (MHz)	Detector Mode (PK/QP/AV)	Spectrum Reading Level (dBμV)	Factor (dB)	Actual FS (dBμV/m)	Limit @3m (dBμV/m)	Margin (dB)
4844.00	Peak	37.87	3.35	41.22	74.00	-32.78
N/A						

**Remark:**

1. Measuring frequencies from 1 GHz to the 10th harmonic of highest fundamental frequency.
2. For above 1GHz, the EUT peak value was under average limit, therefore the Average value compliance with the average limit

Report No.: T200407W01-RP3

Test Mode	IEEE 802.11n HT40 Mid CH	Temp/Hum	24(°C)/ 50%RH
Test Item	Harmonic	Test Date	June 5, 2020
Polarize	Vertical	Test Engineer	Jerry Chang
Detector	Peak		

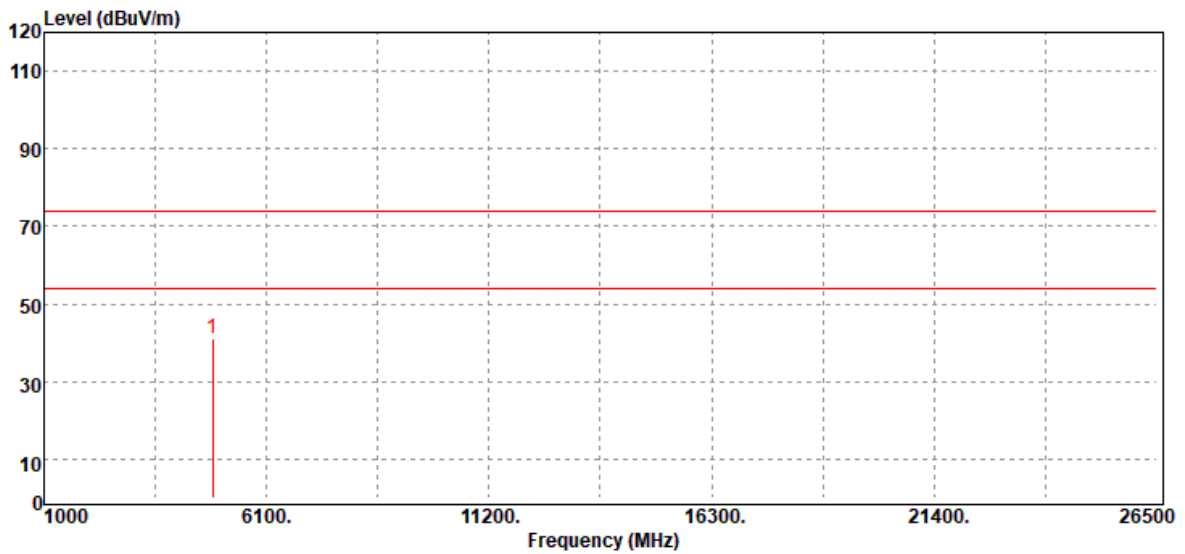

Freq. (MHz)	Detector Mode (PK/QP/AV)	Spectrum Reading Level (dBμV)	Factor (dB)	Actual FS (dBμV/m)	Limit @3m (dBμV/m)	Margin (dB)
4874.00	Peak	37.65	3.48	41.13	74.00	-32.87
N/A						

**Remark:**

1. Measuring frequencies from 1 GHz to the 10th harmonic of highest fundamental frequency.
2. For above 1GHz, the EUT peak value was under average limit, therefore the Average value compliance with the average limit

Report No.: T200407W01-RP3

Test Mode	IEEE 802.11n HT40 Mid CH	Temp/Hum	24(°C)/ 50%RH
Test Item	Harmonic	Test Date	June 5, 2020
Polarize	Horizontal	Test Engineer	Jerry Chang
Detector	Peak		

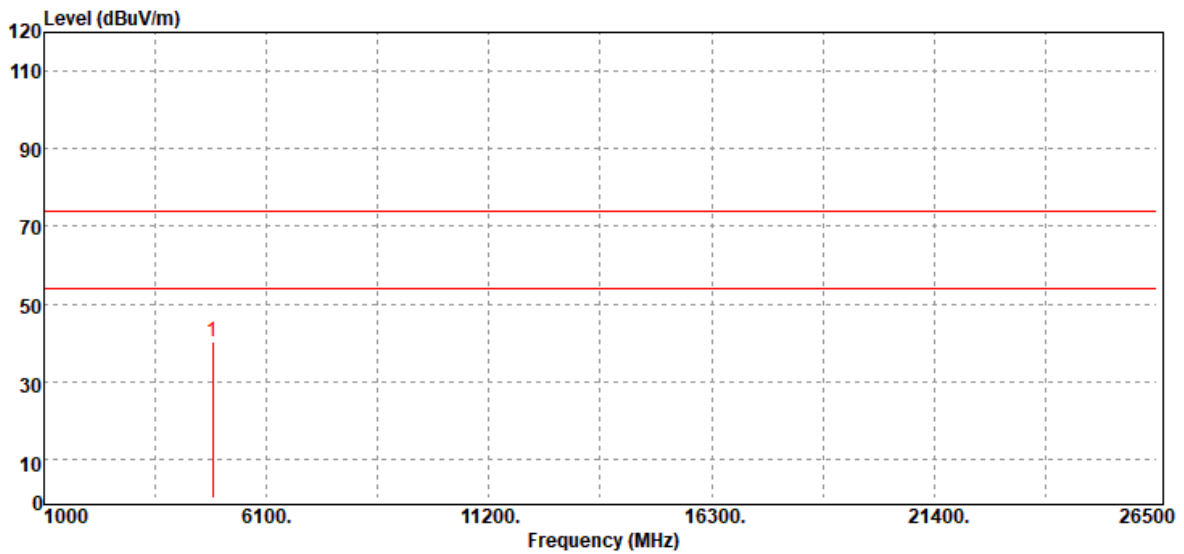

Freq. (MHz)	Detector Mode (PK/QP/AV)	Spectrum Reading Level (dB $\mu$ V)	Factor (dB)	Actual FS (dB $\mu$ V/m)	Limit @3m (dB $\mu$ V/m)	Margin (dB)
4874.00	Peak	36.86	3.48	40.34	74.00	-33.66
N/A						

**Remark:**

1. Measuring frequencies from 1 GHz to the 10th harmonic of highest fundamental frequency.
2. For above 1GHz, the EUT peak value was under average limit, therefore the Average value compliance with the average limit

Report No.: T200407W01-RP3

Test Mode	IEEE 802.11n HT40 High CH	Temp/Hum	24(°C)/ 50%RH
Test Item	Harmonic	Test Date	June 5, 2020
Polarize	Vertical	Test Engineer	Jerry Chang
Detector	Peak		

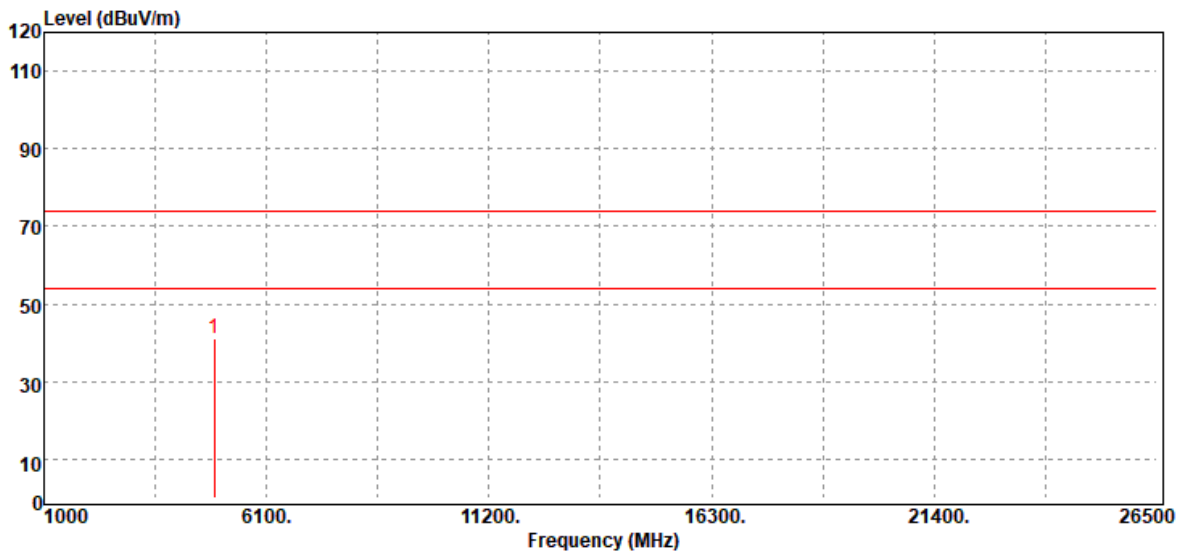

Freq. (MHz)	Detector Mode (PK/QP/AV)	Spectrum Reading Level (dBμV)	Factor (dB)	Actual FS (dBμV/m)	Limit @3m (dBμV/m)	Margin (dB)
4904.00	Peak	37.35	3.69	41.04	74.00	-32.96
N/A						

**Remark:**

1. Measuring frequencies from 1 GHz to the 10th harmonic of highest fundamental frequency.
2. For above 1GHz, the EUT peak value was under average limit, therefore the Average value compliance with the average limit

Report No.: T200407W01-RP3

Test Mode	IEEE 802.11n HT40 High CH	Temp/Hum	24(°C)/ 50%RH
Test Item	Harmonic	Test Date	June 5, 2020
Polarize	Horizontal	Test Engineer	Jerry Chang
Detector	Peak		

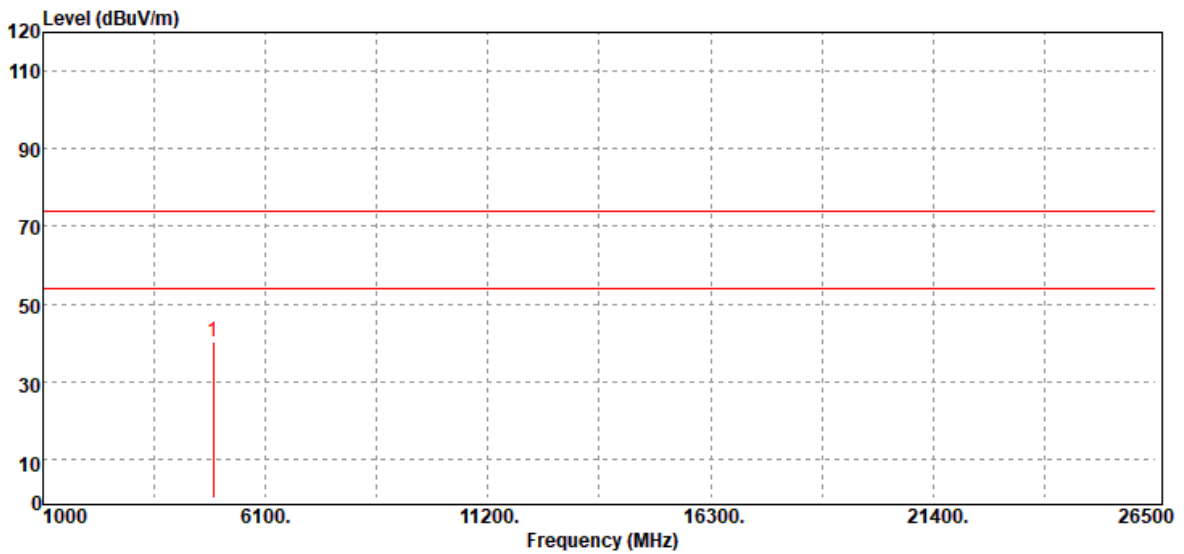

Freq. (MHz)	Detector Mode (PK/QP/AV)	Spectrum Reading Level (dB $\mu$ V)	Factor (dB)	Actual FS (dB $\mu$ V/m)	Limit @3m (dB $\mu$ V/m)	Margin (dB)
4904.00	Peak	36.76	3.69	40.45	74.00	-33.55
N/A						

**Remark:**

1. Measuring frequencies from 1 GHz to the 10th harmonic of highest fundamental frequency.
2. For above 1GHz, the EUT peak value was under average limit, therefore the Average value compliance with the average limit





Report No.: T200407W01-RP3

Page 65 / 66  
Rev. 01

## 4.4 TEST DATA RE-USE SUMMARY

### Introduction Section:

The application re-uses data collected on a similar device. The subject device of this application (Model: N653, FCC ID: P4Q-N653, IC: 2420C-N653) is electrically identical to the reference device (Model: N635, FCC ID: P4Q-N635A, IC: 2420C-N635A) for the portions of the circuitry corresponding to the data being re-used, as treated by KDB Publication 484596 D01.

### Differences Brief Description:

The WLAN, WWAN, BT and RFID hardware of this device are identical to the implementation in

FCC ID: P4Q-N653.

IC: 2420C-N653

The Product Equality Declaration document includes detailed information about the changes between the devices. The data from that application has been verified through appropriate spot checks to demonstrate compliance for this device as shown in the summary table below.

Report No.: T200407W01-RP3

### Spot Check Verification Result Summary

Equipment Class	Reference FCC ID / IC No.	Folder Test	Report Title/ Section
DTS-WLAN	P4Q-N635A / 2420C-N635A	T191105W01-RP3	All Section ( <i>Except for AC Conducted Emission, Output Power Measurement, Radiation Band Edge, Radiation Spurious Emission</i> )

### Summary of the spot check for Unlicensed bands and Licensed bands

In order to confirm hardware similarity of the subject device with the reference device, we used same setting power to radiated emission measurement were performed on the subject device for the Band edge and Harmonic, the test result were similar with FCC ID: P4Q-N635A / IC: 2420C-N635A.

#### WLAN

Report	Test Item	CH.	Measured Frequency (MHz)	P4Q-N635A / 2420C-N635A		P4Q-N653 / 2420C-N653		Gap (dB)	
				Peak	Average	Peak	Average	Peak	Average
DTS (WLAN)	Band edge	Low	2390	67.67	48.4	70.21	50.3	-2.54	-1.9
		High	2483.5	72.14	53.95	70.1	51.42	2.04	2.53
	RSE	Low	7236	52.14	-	51.58	-	0.56	-

**- End of Test Report -**