



FCC/IC TEST REPORT

According to
CFR47 §15.247&RSS-247 Issue 2

Applicant : Mitac Digital Technology Corporation
Address : No. 200, Wen Hwa 2nd Rd., Kuei Shan Dist. 33383 Taoyuan City, TAIWAN
Manufacturer : Mitac Computer (Kunshan) Co., Ltd.
Address : No. 269, 2nd Avenue, District A, Comprehensive Free Trade Zone, 215300
Kunshan, Jiangsu, PEOPLES REPUBLIC OF CHINA
Equipment : Tablet
Model No. : N642
FCC ID : P4Q-N642-M1005
IC : 2420C-N642-M1005
Test Period : July 25, 2019~August 15, 2019

- The test result refers exclusively to the test presented test model / sample.
- Without written approval of **Cerpass Technology (Suzhou) Co., Ltd.**, the test report shall not be reproduced except in full.
- The test report must not be used by the clients to claim product certification approval by any agency of the Government.

I **HEREBY** CERTIFY THAT :

The measurements shown in this test report were made in accordance with the procedures given in **ANSI C63.10 – 2013&FCC Part15.247&RSS-247 Issue 2** and the energy emitted by this equipment was **passed**.

Approved by:

Miro Chueh
EMC/RF Manager

Laboratory Accreditation:

Cerpass Technology Corporation Test Laboratory



TAF LAB Code: 1439

Cerpass Technology (SuZhou) Co., Ltd.



A2LA LAB Code: 4981.01



Contents

1. Test Configuration of Equipment under Test	5
1.1 Feature of Equipment under Test.....	5
1.2 Description of Antenna.....	5
1.3 Working Frequencies	6
1.4 Power Parameter Value	7
1.5 The Worst Transmission Mode	8
1.6 Test Manner	9
2. Technical Test	10
2.1 Summary of Test Result.....	10
2.2 General Information of Test.....	12
2.3 Measuring Equipment.....	13
2.4 Measurement Uncertainty.....	14
3. AC Conducted Emission Measurement	15
3.1 Test Limit	15
3.2 Test Procedures	15
3.3 Test Setup	15
3.4 Test Result	16
4. Radiated Emission Measurement	24
4.1 Test Limit	24
4.2 Test Standard	25
4.3 Test Procedures.....	25
4.4 Test Setup.....	25
4.5 Test Result	27
5. 20dB Bandwidth Measurement	49
5.1 Test Limit	49
5.2 Test Standard	49
5.3 Test Setup	49
5.4 Test Setup Layout	49
5.5 Test Result	50
6. Channel Carrier Frequencies Separation Measurement	53
6.1 Test Limit	53
6.2 Test Standard	53
6.3 Test Setup	53
6.4 Test Setup Layout	53
6.5 Test Result	54
7. Dwell Time Measurement	57
7.1 Test Limit	57
7.2 Test Standard	57
7.3 Test Setup	57
7.4 Test Setup Layout	57
7.5 Test Result	58
8. Number of Hopping Channels Measurement	61
8.1 Test Limit	61



8.2 Test Standard 61

8.3 Test Setup 61

8.4 Test Setup Layout 61

8.5 Test Result 62

9. Peak Output Power Measurement 65

9.1 Test Limit 65

9.2 Test Standard 65

9.3 Test Setup 65

9.4 Test Setup Layout 65

9.5 Test Result 66

10. Conducted Spurious Emissions Measurement 75

10.1 Limit 75

10.2 Test Procedure 76

10.3 Test Setup 76

10.4 Test Result 77

11. Radiated Emission Band Edge Measurement 85

11.1 Limit 85

11.2 Test Procedure 85

11.3 Test Setup 86

11.4 Test Result 87



History of this Test Report

Report No.	Version	Issue Date	Description
SEFA1907033-A	Rev 01	Aug. 16, 2019	Original



1. Test Configuration of Equipment under Test

1.1 Feature of Equipment under Test

EUT Type	Tablet	
Model Name	N642	
Wireless Module	Qualcomm WCN3660B	
TX Frequency Range	2.4GHz: 2400MHz ~ 2483.5MHz	
Number of Channel	2.4GHz BT-BDR(GFSK): 79, BT-EDR(Pi/4 DQPSK): 79, BT-EDR(8DPSK): 79 BT-LE(GFSK): 40 802.11b/g, 802.11n-HT20 : 13 802.11n-HT40: 9	
Type of Modulation	BT-BDR(GFSK), BT-EDR(Pi/4 DQPSK), BT-EDR(8DPSK) for FHSS BT-LE (GFSK) for DTS DBPSK, DQPSK, CCK for DSSS in 802.11b mode BPSK, QPSK, 16-QAM, 64-QAM for OFDM in 802.11g/n mode	
Data Rate	BT-BDR(GFSK): 1Mbps, BT-EDR(Pi/4 DQPSK): 2Mbps, BT-EDR(8DPSK) : 3Mbps, BT-LE(GFSK): 1Mbps 802.11b: up to 11Mbps, 802.11g: up to 54Mbps, 802.11n: up to MCS7	
Antenna Type	IFA	
Antenna Peak Gain	2.4~2.4835GHz: 4.35dBi	
Device Category	Portable	
RF Exposure Environment	General Population/ Uncontrolled	
Power supply1	Model:	CVW120200
	Input:	100-240V~1.2A 50-60Hz 0.75A
	Output:	DC 12V --2.0A
Power supply2	Model:	POE-GTI-3556ND4
	Input:	100-240V
	Output:	DC 56V--0.625A

1.2 Description of Antenna

Manufacturer	Model	Specification
Awan	MIC-N642 Locking WIFI	IFA Antenna for WIFI 802.11a/b/g application



1.3 Working Frequencies

Bluetooth Working Frequency of Each Channel:							
Channel	Frequency	Channel	Frequency	Channel	Frequency	Channel	Frequency
00	2402 MHz	01	2403 MHz	02	2404 MHz	03	2405 MHz
04	2406 MHz	05	2407 MHz	06	2408 MHz	07	2409 MHz
08	2410 MHz	09	2411 MHz	10	2412 MHz	11	2413 MHz
12	2414 MHz	13	2415 MHz	14	2416 MHz	15	2417 MHz
16	2418 MHz	17	2419 MHz	18	2420 MHz	19	2421 MHz
20	2422 MHz	21	2423 MHz	22	2424 MHz	23	2425 MHz
24	2426 MHz	25	2427 MHz	26	2428 MHz	27	2429 MHz
28	2430 MHz	29	2431 MHz	30	2432 MHz	31	2433 MHz
32	2434 MHz	33	2435 MHz	34	2436 MHz	35	2437 MHz
36	2438 MHz	37	2439 MHz	38	2440 MHz	39	2441 MHz
40	2442 MHz	41	2443 MHz	42	2444 MHz	43	2445 MHz
44	2446 MHz	45	2447 MHz	46	2448 MHz	47	2449 MHz
48	2450 MHz	49	2451 MHz	50	2452 MHz	51	2453 MHz
52	2454 MHz	53	2455 MHz	54	2456 MHz	55	2457 MHz
56	2458 MHz	57	2459 MHz	58	2460 MHz	59	2461 MHz
60	2462 MHz	61	2463 MHz	62	2464 MHz	63	2465 MHz
64	2466 MHz	65	2467 MHz	66	2468 MHz	67	2469 MHz
68	2470 MHz	69	2471 MHz	70	2472 MHz	71	2473 MHz
72	2474 MHz	73	2475 MHz	74	2476 MHz	75	2477 MHz
76	2478 MHz	77	2479 MHz	78	2480 MHz	N/A	N/A



1.4 Power Parameter Value

Mode	Frequency (MHz)	Power Setting
DH5	2402	9
	2441	9
	2480	9
2DH5	2402	9
	2441	9
	2480	9
3DH5	2402	9
	2441	9
	2480	9



1.5 The Worst Transmission Mode

Test Mode
Mode 1: Transmit by DH5(GFSK) 1Mbps
Mode 2: Transmit by 2DH5($\pi/4$ -DQPSK) 2Mbps
Mode 3: Transmit by 3DH5(8DPSK) 3Mbps



1.6 Test Manner

Test Manner	
a	Setup the EUT and simulators according to ANSI C63.10
b	Turn on the power of equipment.
c	Access the test software, set the test mode and test channel, then start to test.

Note: Regards to the frequency band operation: the lowest, middle and highest frequency of channel were selected to perform the test, then shown on this report.



2. Technical Test

2.1 Summary of Test Result

- No deviations from the test standards
 Deviations from the test standards as below description:

FCC/IC Part Section(s)	Test Description	Test Result
FCC CFR Title 47 Part 15 Subpart C: 2019 Section 15.207 RSS-Gen Issue 4 November 2014 Section 8.8	AC Conducted Emission	Compliance
FCC CFR Title 47 Part 15 Subpart C: 2019 Section 15.209 RSS-Gen Issue 4 November 2014 Section 8.9	Radiated Emission	Compliance
FCC CFR Title 47 Part 15 Subpart C: 2019 Section 15.247(a)(1); RSS-247 Issue 2 February 2017 Section 5.1(a)	20dB Bandwidth	Compliance
FCC CFR Title 47 Part 15 Subpart C: 2019 Section 15.247(a)(1); RSS-247 Issue 2 February 2017 Section 5.1(b)	Channel Carrier Frequencies Separation	Compliance
FCC CFR Title 47 Part 15 Subpart C: 2019 Section 15.247(a)(1); RSS-247 Issue 2 February 2017 Section 5.1(c)	Dwell Time	Compliance
FCC CFR Title 47 Part 15 Subpart C: 2019 Section 15.247(b); RSS-247 Issue 2 February 2017 Section 5.1(b)	Number of Hopping Channels	Compliance
FCC CFR Title 47 Part 15 Subpart C: 2019 Section 15.247(b); RSS-247 Issue 2 February 2017 Section 5.1(b)	Peak Output Power	Compliance
FCC CFR Title 47 Part 15 Subpart C: 2019 Section 15.247(d);	Band-edge Compliance & Conducted Spurious Emissions	Compliance



RSS-247 Issue 2 February 2017 Section 5.5		
FCC CFR Title 47 Part 15 Subpart C: 2019 Section 15.247(d); RSS-247 Issue 2 February 2017 Section 5.5	Radiated Emission Band Edges	Compliance



2.2 General Information of Test

<input type="checkbox"/>	Test Site	Cerpass Technology Corporation Test Laboratory Address: No.10, Ln. 2, Lianfu St., Luzhu Dist., Taoyuan City 33848, Taiwan (R.O.C.) Tel:+886-3-3226-888 Fax:+886-3-3226-881 Address: No.68-1, Shihbachongsi, Shihding Township, New Taipei City 223, Taiwan, R.O.C. Tel: +886-2-2663-8582
	TAF	1439
	FCC	TW1079, TW1061
	IC	4934E-1, 4934E-2
	VCCI	T-2205 for Telecommunication Test C-4663 for Conducted emission test R-4399, R-4218 for Radiated emission test G-812, G-813 for radiated disturbance above 1GHz
<input checked="" type="checkbox"/>	Test Site	Cerpass Technology (Suzhou) Co.,Ltd Address: No.66,Tangzhuang Road, Suzhou Industrial Park, Jiangsu 215006, China Tel: +86-512-6917-5888 Fax: +86-512-6917-5666
	CNAS	L5515
	FCC	CN1243
	A2LA	4981.01
	IC	7290A-1, 7290A-2
VCCI	T-1945 for Telecommunication Test C-12919 for Conducted emission test R-12670 for Radiated emission test G-227 for radiated disturbance above 1GHz	



2.3 Measuring Equipment

Instrument/Ancillary	Manufacturer	Model No.	Serial No.	Calibration Date	Due Date.
EMI Test Receiver	R&S	ESCI	101183	2019.06.28	2020.06.27
Preamplifier	HP	8447F	3113A05915	2019.02.25	2020.02.24
Preamplifier	FIELD	AFS44-00101800 -25-10P-44	1579008	2018.10.14	2019.10.13
Bilog Antenna	Sunol Science	JB1	A072414-1	2019.06.26	2020.06.26
Spectrum Analyzer	Agilent	N9010A	MY45118947	2018.10.11	2019.10.10
Temperature/ Humidity Meter	mingle	ETH529	N/A	2019.02.25	2020.02.24
Spectrum Analyzer	R&S	FSP40	100047	2019.03.07	2020.03.06
PREAMPLIFIER	AGILENT	8449B	3008A01954	2019.03.05	2020.03.04
HORN ANTENNA	EMCO	3115	31589	2019.03.09	2020.03.08
HIGH PASS FILTER	HP	84300-80038	002	2019.03.05	2020.03.04
SERIES POWER METER	ANRITSU	ML2495A	1224005	2019.03.05	2020.03.04
POWER SENSOR	ANRITSU	MA2411B	1207295	2019.03.05	2020.03.04
Bluetooth Tester	R&S	CBT	101133	2019.03.12	2020.03.11



2.4 Measurement Uncertainty

ISO/IEC 17025 requires that an estimate of the measurement uncertainties associated with the emissions test results be included in the report. The measurement uncertainties given below are based on a 95% confidence level (based on a coverage factor (k=2)).

RF Conducted Measurement

Test Item	Uncertainty	Limit
Radio Frequency	$\pm 8.7 \times 10^{-7}$	$\pm 1 \times 10^{-5}$
RF output power, conducted	$\pm 0.63 \text{ dB}$	$\pm 1.5 \text{ dB}$
Power density, conducted	$\pm 1.21 \text{ dB}$	$\pm 3 \text{ dB}$
Unwanted emissions, conducted	30-1000MHz	$\pm 0.51 \text{ dB}$
	1-25GHz	$\pm 0.67 \text{ dB}$
All emissions, radiated	30-1000MHz	$\pm 2.28 \text{ dB}$
	1-25GHz	$\pm 2.59 \text{ dB}$
Temperature	$\pm 0.8^\circ \text{C}$	$\pm 1^\circ \text{C}$
Humidity	$\pm 3\%$	$\pm 5\%$
DC and low frequency voltages	$\pm 3\%$	$\pm 3\%$

AC Conducted Measurement

Measurement	Frequency	Uncertainty
Conducted emissions(LINE)	9KHz-30MHz	+/- 0.7738 dB
Conducted emissions(NEUTRAL)	9KHz-30MHz	+/- 0.7886 dB
Conducted emissions(10Mbps)	150KHz-30MHz	+/- 1.3013dB
Conducted emissions(100Mbps)	150KHz-30MHz	+/- 1.3197 dB
Conducted emissions(1000Mbps)	150KHz-30MHz	+/- 1.2987 dB

Radiated Measurement

Measurement	Polarity	Frequency	Uncertainty
Radiated emissions	Horizontal	below 1GHz	+/- 3.8936 dB
	Vertical	below 1GHz	+/- 3.8928 dB
	Horizontal	above 1GHz	+/- 5.18858dB
	Vertical	above 1GHz	+/- 5.18928 dB

3. AC Conducted Emission Measurement

3.1 Test Limit

Conducted Emissions were measured from 150 kHz to 30 MHz with a bandwidth of 9 KHz on the 120 VAC power and return leads of the EUT according to the methods defined in ANSI C63.10-2013 Section 6.2. The EUT was placed on a nonmetallic stand in a shielded room 0.8 meters above the ground plane as shown in section 6.2.2. The interface cables and equipment positioning were varied within limits of reasonable applications to determine the position produced maximum conducted emissions.

Frequency (MHz)	Quasi Peak (dB μ V)	Average (dB μ V)
0.15 – 0.5	66-56*	56-46*
0.5 – 5.0	56	46
5.0 – 30.0	60	50

*Decreases with the logarithm of the frequency.

3.2 Test Procedures

- The EUT was placed 0.4 meter from the conducting wall of the shielding room was kept at least 80 centimeters from any other grounded conducting surface.
- Connect EUT to the power mains through a line impedance stabilization network (LISN).
- All the support units are connecting to the other LISN.
- The LISN provides 50 ohm coupling impedance for the measuring instrument.
- The FCC states that a 50 ohm, 50 micro-Henry LISN should be used.
- Both sides of AC line were checked for maximum conducted interference.
- The frequency range from 150 kHz to 30 MHz was searched.
- Set the test-receiver system to Peak Detect Function and Specified Bandwidth with Maximum Hold Mode.

3.3 Test Setup

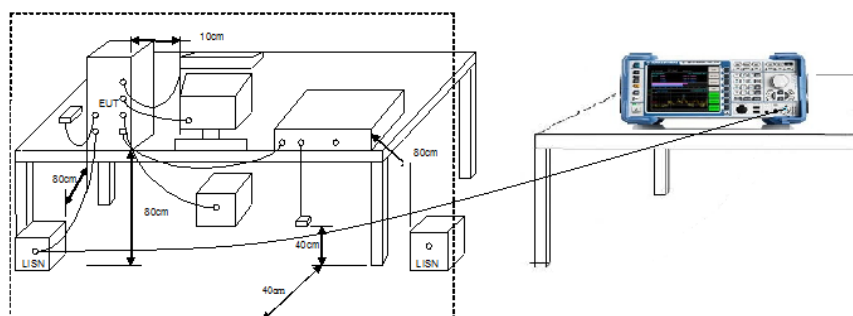



3.4 Test Result

Test Standard:	FCC_ClassB_QP	Probe:	L1
Test item:	Conduction Emission	Test Time:	2019/8/139:56:13
Applicant:	Mitac Digital Technology Company	Power Rating:	AC 120V/60Hz
Product:	Tablet	Temp.(C)/Hum.(%)/Air p.(hpa):	26(°C)/60%/1000hpa
Model No.:	N642	Test Engineer:	Chris
Test Mode:	BT3.0		
Remark:	Adapter Power		

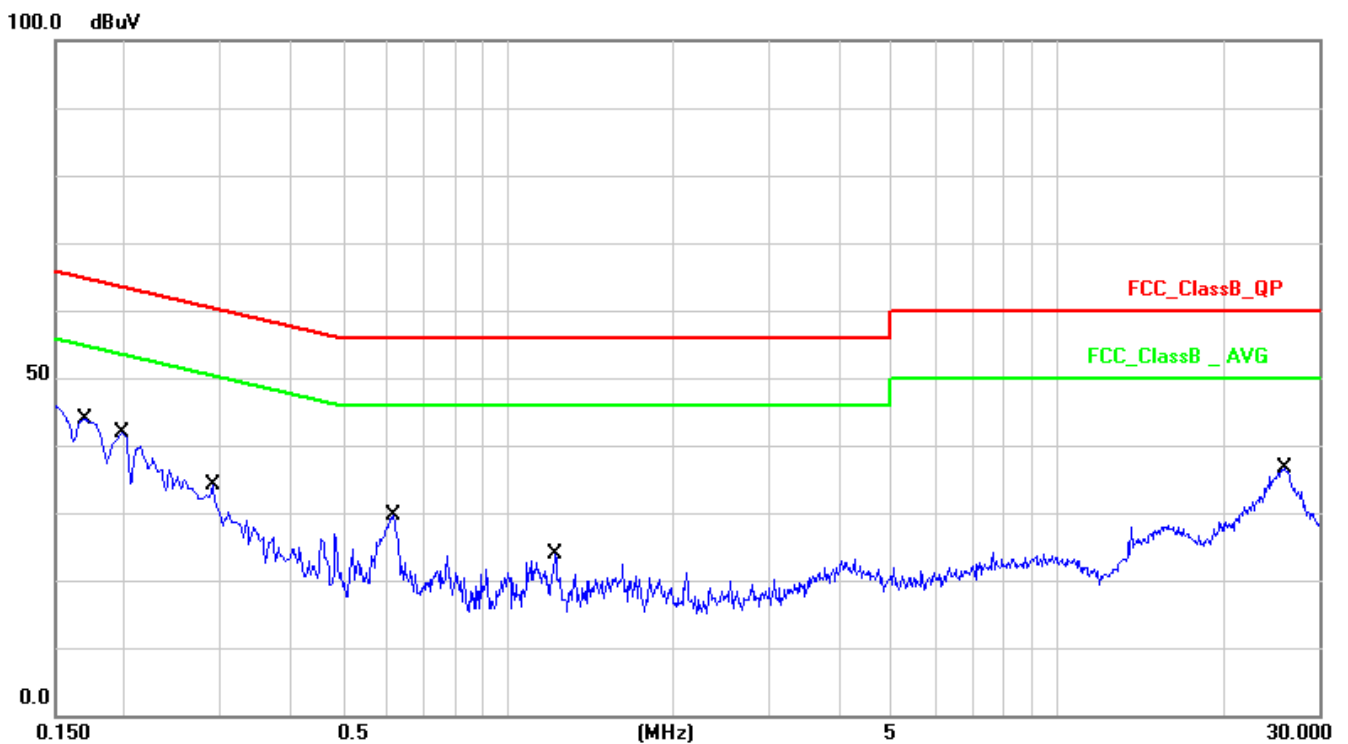

No.	Frequency (MHz)	Factor (dB)	Reading (dBuV)	Level (dBuV)	Limit (dBuV)	Margin (dB)	Detector
1	0.1700	10.15	30.67	40.82	64.96	-24.14	QP
2	0.1700	10.15	13.51	23.66	54.96	-31.30	AVG
3	0.1980	10.13	27.13	37.26	63.69	-26.43	QP
4	0.1980	10.13	10.58	20.71	53.69	-32.98	AVG
5	0.2900	10.14	18.57	28.71	60.52	-31.81	QP
6	0.2900	10.14	5.60	15.74	50.52	-34.78	AVG
7	0.6180	10.15	17.00	27.15	56.00	-28.85	QP
8	0.6180	10.15	7.74	17.89	46.00	-28.11	AVG
9	1.2220	10.17	7.28	17.45	56.00	-38.55	QP
10	1.2220	10.17	1.64	11.81	46.00	-34.19	AVG



11	26.1060	10.45	20.25	30.70	60.00	-29.30	QP
12	26.1060	10.45	10.23	20.68	50.00	-29.32	AVG

Note: Level = Reading + Factor

Margin = Level – Limit

Factor = (LISN or ISN or PLC or current probe) Factor + Cable Loss + Attenuator



Test Standard:	FCC_ClassB_QP	Probe:	N
Test item:	Conduction Emission	Test Time:	2019/8/1310:05:24
Applicant:	Mitac Digital Technology Company	Power Rating:	AC 120V/60Hz
Product:	Tablet	Temp.(C)/Hum.(%)/Air p.(hpa):	26(°C)/60%/1000hpa
Model No.:	N642	Test Engineer:	Chris
Test Mode:	BT3.0		
Remark:	Adapter Power		

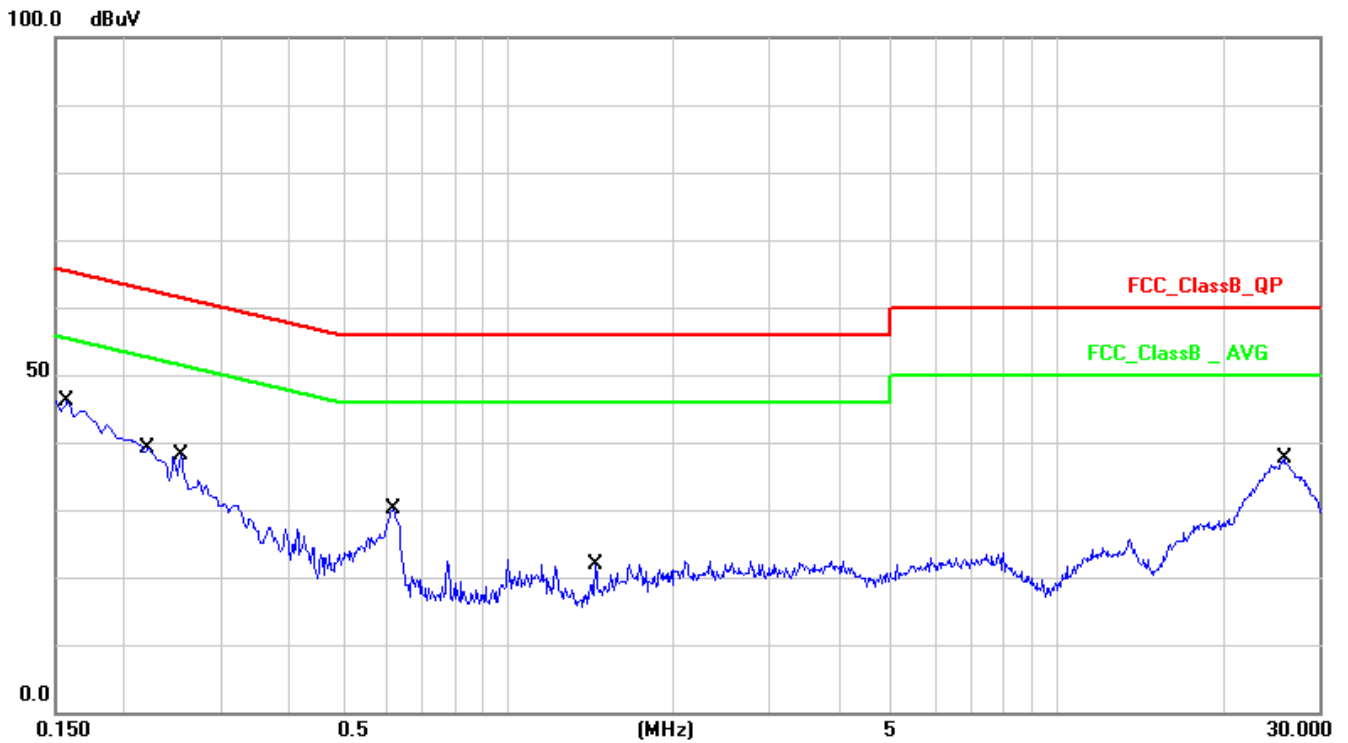

No.	Frequency (MHz)	Factor (dB)	Reading (dBuV)	Level (dBuV)	Limit (dBuV)	Margin (dB)	Detector
1	0.1580	10.15	31.96	42.11	65.56	-23.45	QP
2	0.1580	10.15	13.29	23.44	55.56	-32.12	AVG
3	0.2220	10.14	24.93	35.07	62.74	-27.67	QP
4	0.2220	10.14	7.35	17.49	52.74	-35.25	AVG
5	0.2540	10.14	20.32	30.46	61.62	-31.16	QP
6	0.2540	10.14	3.45	13.59	51.62	-38.03	AVG
7	0.6180	10.16	17.30	27.46	56.00	-28.54	QP
8	0.6180	10.16	9.02	19.18	46.00	-26.82	AVG
9	1.4460	10.19	5.91	16.10	56.00	-39.90	QP
10	1.4460	10.19	-0.28	9.91	46.00	-36.09	AVG



11	25.9940	10.35	20.96	31.31	60.00	-28.69	QP
12	25.9940	10.35	11.56	21.91	50.00	-28.09	AVG

Note: Level = Reading + Factor

Margin = Level – Limit

Factor = (LISN or ISN or PLC or current probe) Factor + Cable Loss + Attenuator



Test Standard:	FCC_ClassB_QP	Probe:	L1
Test item:	Conduction Emission	Test Time:	2019/8/1311:12:03
Applicant:	Mitac Digital Technology Company	Power Rating:	AC 120V/60Hz
Product:	Tablet	Temp.(C)/Hum.(%)/Air p.(hpa):	26(°C)/60%/1000hpa
Model No.:	N642	Test Engineer:	Chris
Test Mode:	BT 3.0		
Remark:	POE Power		

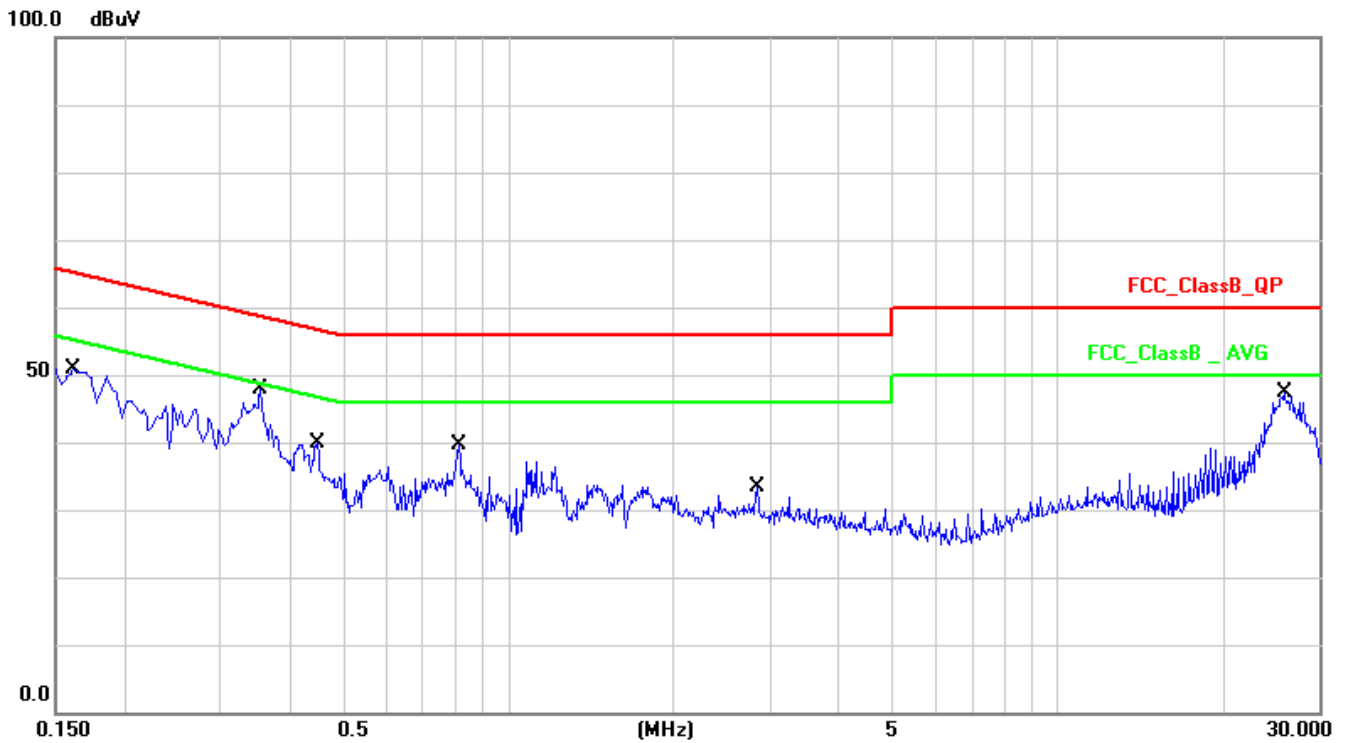

No.	Frequency (MHz)	Factor (dB)	Reading (dBuV)	Level (dBuV)	Limit (dBuV)	Margin (dB)	Detector
1	0.1620	10.15	35.43	45.58	65.36	-19.78	QP
2	0.1620	10.15	17.33	27.48	55.36	-27.88	AVG
3	0.3540	10.15	31.57	41.72	58.87	-17.15	QP
4	0.3540	10.15	23.50	33.65	48.87	-15.22	AVG
5	0.4500	10.16	24.37	34.53	56.87	-22.34	QP
6	0.4500	10.16	17.61	27.77	46.87	-19.10	AVG
7	0.8139	10.16	26.52	36.68	56.00	-19.32	QP
8	0.8139	10.16	20.47	30.63	46.00	-15.37	AVG
9	2.8420	10.20	21.14	31.34	56.00	-24.66	QP
10	2.8420	10.20	16.88	27.08	46.00	-18.92	AVG
11	25.9860	10.45	31.77	42.22	60.00	-17.78	QP



12	25.9860	10.45	25.84	36.29	50.00	-13.71	AVG
----	---------	-------	-------	-------	-------	--------	-----

Note: Level = Reading + Factor

Margin = Level – Limit

Factor = (LISN or ISN or PLC or current probe) Factor + Cable Loss + Attenuator



Test Standard:	FCC_ClassB_QP	Probe:	N
Test item:	Conduction Emission	Test Time:	2019/8/1311:14:55
Applicant:	Mitac Digital Technology Company	Power Rating:	AC 120V/60Hz
Product:	Tablet	Temp.(C)/Hum.(%)/Air p.(hpa):	26(°C)/60%/1000hpa
Model No.:	N642	Test Engineer:	Chris
Test Mode:	BT 3.0		
Remark:	POE Power		

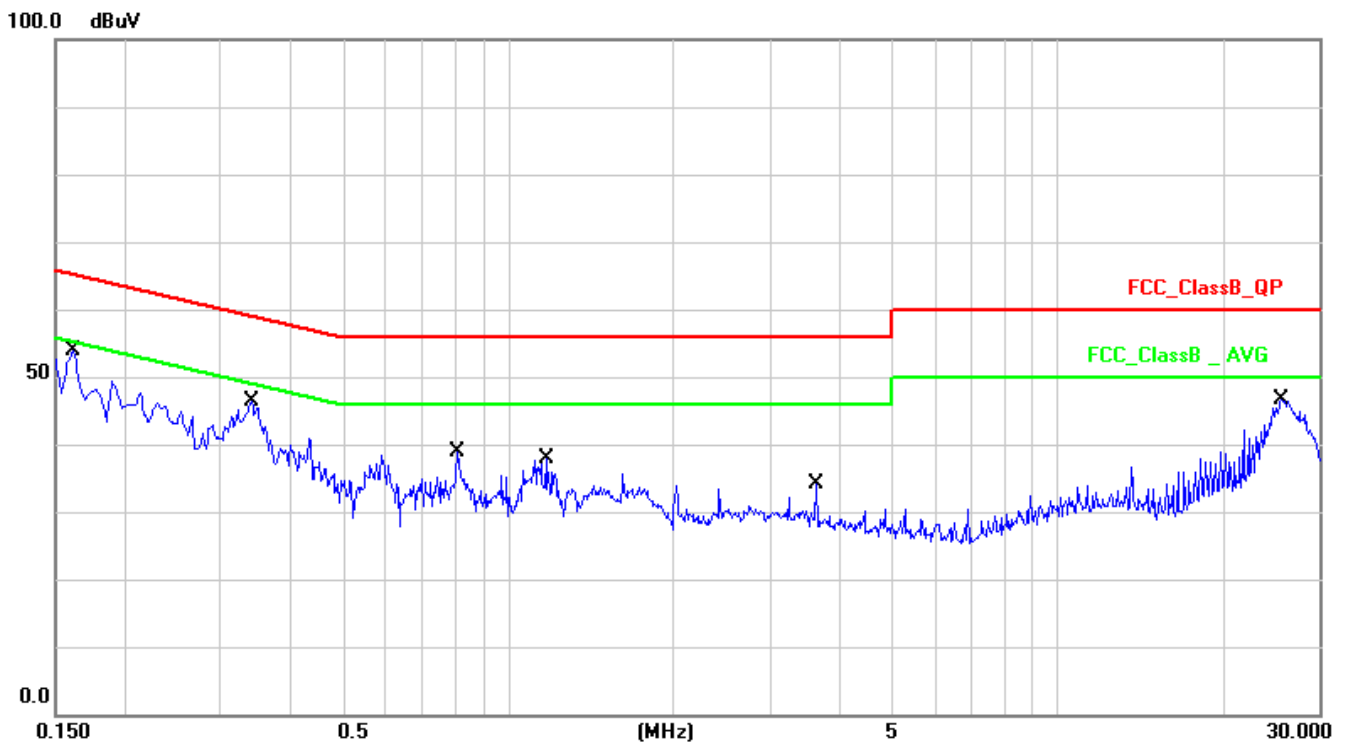

No.	Frequency (MHz)	Factor (dB)	Reading (dBuV)	Level (dBuV)	Limit (dBuV)	Margin (dB)	Detector
1	0.1620	10.15	35.33	45.48	65.36	-19.88	QP
2	0.1620	10.15	17.22	27.37	55.36	-27.99	AVG
3	0.3420	10.14	33.52	43.66	59.15	-15.49	QP
4	0.3420	10.14	26.26	36.40	49.15	-12.75	AVG
5	0.8100	10.17	25.03	35.20	56.00	-20.80	QP
6	0.8100	10.17	18.84	29.01	46.00	-16.99	AVG
7	1.1740	10.19	21.80	31.99	56.00	-24.01	QP
8	1.1740	10.19	14.86	25.05	46.00	-20.95	AVG
9	3.6500	10.24	19.19	29.43	56.00	-26.57	QP
10	3.6500	10.24	14.65	24.89	46.00	-21.11	AVG



11	25.7139	10.36	31.25	41.61	60.00	-18.39	QP
12	25.7139	10.36	25.39	35.75	50.00	-14.25	AVG

Note: Level = Reading + Factor

Margin = Level – Limit

Factor = (LISN or ISN or PLC or current probe) Factor + Cable Loss + Attenuator



4. Radiated Emission Measurement

4.1 Test Limit

In any 100kHz bandwidth outside the frequency band in which the spread spectrum or digitally modulated intentional radiator is operating, the radio frequency power that is produced by the intentional radiator shall be at least 20dB below that in the 100kHz bandwidth within the band that contains the highest level of the desired power, based on either an RF conducted or a radiated measurement. If the transmitter measurement is based on the maximum conducted output power, the attenuation required under this paragraph shall be 30dB instead of 20dB. In addition, radiated emissions which fall in section 15.205(a) the restricted bands must also comply with the radiated emission limit specified in section 15.209(a).

FREQUENCIES (MHz)	FIELD STRENGTH (micro volts/meter)	MEASUREMENT DISTANCE (meters)
0.009~0.490	2400/F(kHz)	300
0.490~1.705	24000/F(kHz)	30
1.705~30.0	30	30
30~88	100	3
88~216	150	3
216~960	200	3
Above 960	500	3

For unintentional device, according to CISPR PUB.22, for Class B digital devices, the general requirement of field strength of radiated emissions from intentional radiators at a distance of 10 meters shall not exceed the above table.

Frequency (MHz)	Distance Meters	Radiated (dB μ V/ M)
30-230	10	30
230-1000	10	37



4.2 Test Standard

ANSI C63.10-2013-Section 6.10.5

4.3 Test Procedures

- The EUT was placed on a rotatable table top 0.8 meter for frequency below 1GHz and 1.5meter for frequency above 1GHz above ground.
- The EUT was set 3 meters from the interference receiving antenna which was mounted on the top of a variable height antenna tower.
- The table was rotated 360 degrees to determine the position of the highest radiation.
- The antenna is a broadband antenna and its height is varied between one meter and four meters above ground to find the maximum value of the field strength both horizontal polarization and vertical polarization of the antenna are set to make the measurement.
- For each suspected emission the EUT was arranged to its worst case and then tune the antenna tower (from 1 M to 4 M) and turn table (from 0 degree to 360 degrees) to find the maximum reading.
- Set the test-receiver system to Peak or CISPR quasi-peak Detect Function and specified bandwidth with Maximum Hold Mode.
- If the emission level of the EUT in peak mode was 3 dB lower than the limit specified, then testing will be stopped and peak values of EUT will be reported, otherwise, the emissions which do not have 3 dB margin will be repeated one by one using the quasi-peak method and reported.
- For testing above 1GHz, the emission level of the EUT in peak mode was 20dB lower than average limit (that means the emission level in peak mode also complies with the limit in average mode), then testing will be stopped and peak values of EUT will be reported, otherwise, the emissions will be measured in average mode again and reported.

4.4 Test Setup

9kHz~30MHz Test Setup

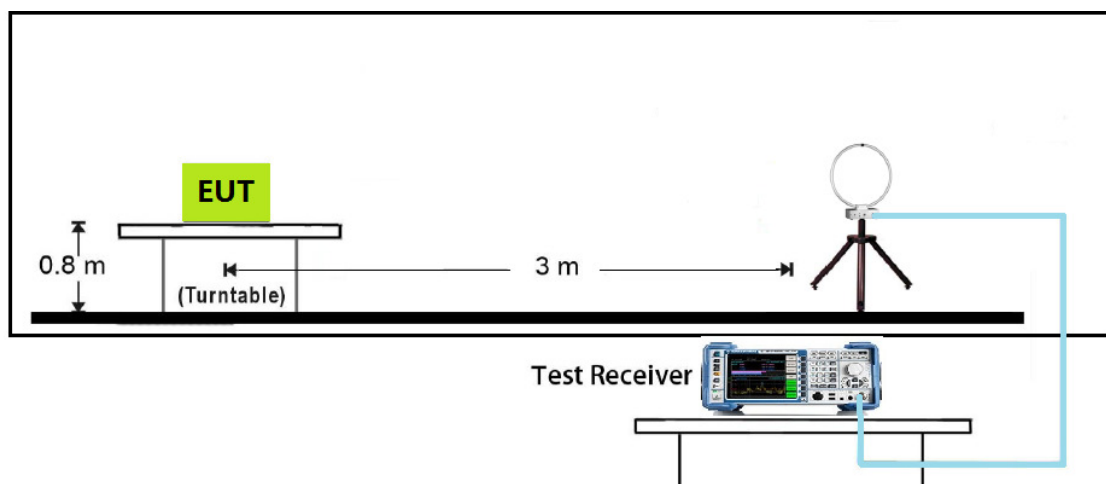



Below 1GHz Test Setup

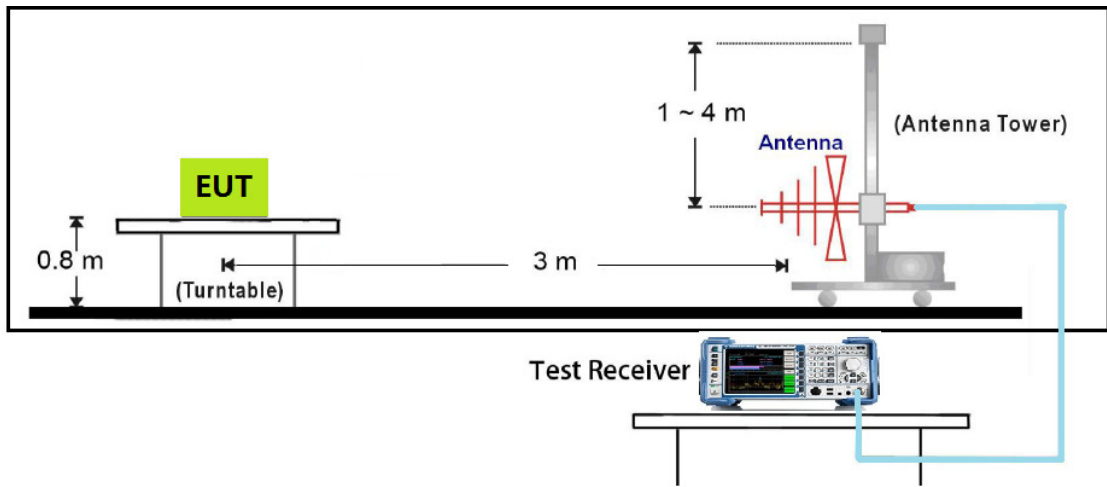

1GHz~18GHz Test Setup

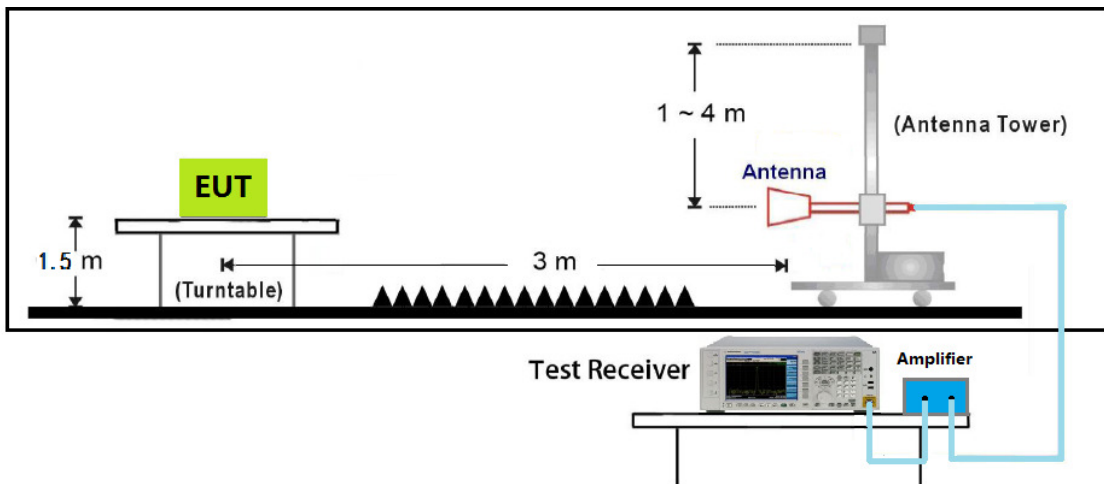

18GHz~40GHz Test Setup

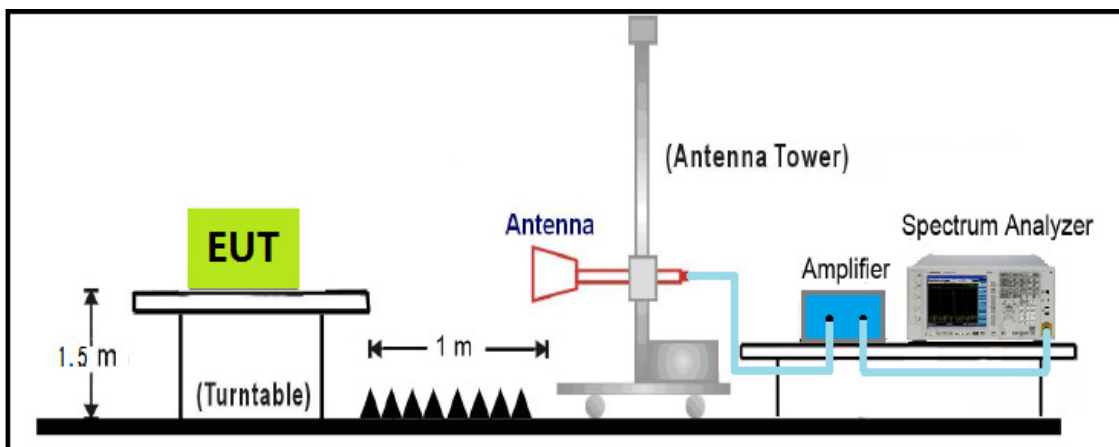



4.5 Test Result

The worst case of Radiated Emission below 1GHz:

Test Distance:	3M		
Test Standard:	FCC Class B 3M Radiation	Ant. Polarization:	Horizontal
Test item:	Radiation Emission	Test Time:	2019-8-1516:14:35
Applicant:	Mitac Digital Technology Company	Power Rating:	AC 120V/60Hz
Product:	Tablet	Temp.(C)/Hum.(/Air p.(hpa):	26(°C)/60%/983hpa
Model No.:	N642	Test Engineer:	Chris
Test Mode:	BT3.0		
Remark:	Adapter Power		

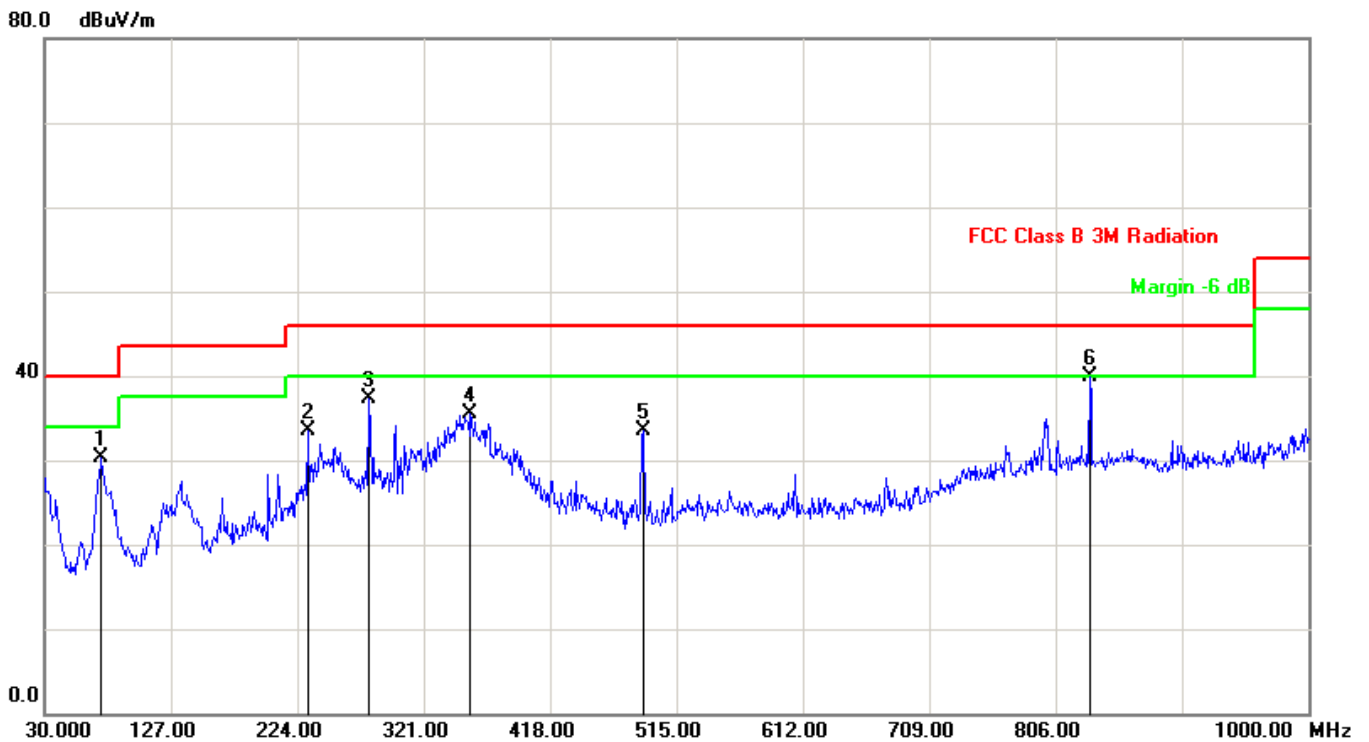

No.	Frequency (MHz)	Factor (dB/m)	Reading (dBuV)	Level (dBuV/m)	Limit (dBuV/m)	Margin (dB)	Det.
1	73.6500	-16.26	46.60	30.34	40.00	-9.66	peak
2	231.7600	-10.96	44.48	33.52	46.00	-12.48	peak
3	279.2900	-8.29	45.53	37.24	46.00	-8.76	peak
4	356.8900	-7.83	43.27	35.44	46.00	-10.56	peak
5	489.7800	-5.49	38.93	33.44	46.00	-12.56	peak
6	832.1900	2.21	37.68	39.89	46.00	-6.11	peak

Note: Measure Level (dBuV/m) = Reading Level (dBuV) + Factor (dB)

Factor (dB) = Cable Loss (dB) + Antenna Factor (dB/m) - Pre_Amplifier Gain (dB)



Test Distance:	3M		
Test Standard:	FCC Class B 3M Radiation	Ant. Polarization:	Vertical
Test item:	Radiation Emission	Test Time:	2019-8-1516:09:44
Applicant:	Mitac Digital Technology Company	Power Rating:	AC 120V/60Hz
Product:	Tablet	Temp.(C)/Hum.(/Air p.(hpa):	26(°C)/60%/983hpa
Model No.:	N642	Test Engineer:	Chris
Test Mode:	BT3.0		
Remark:	Adapter Power		

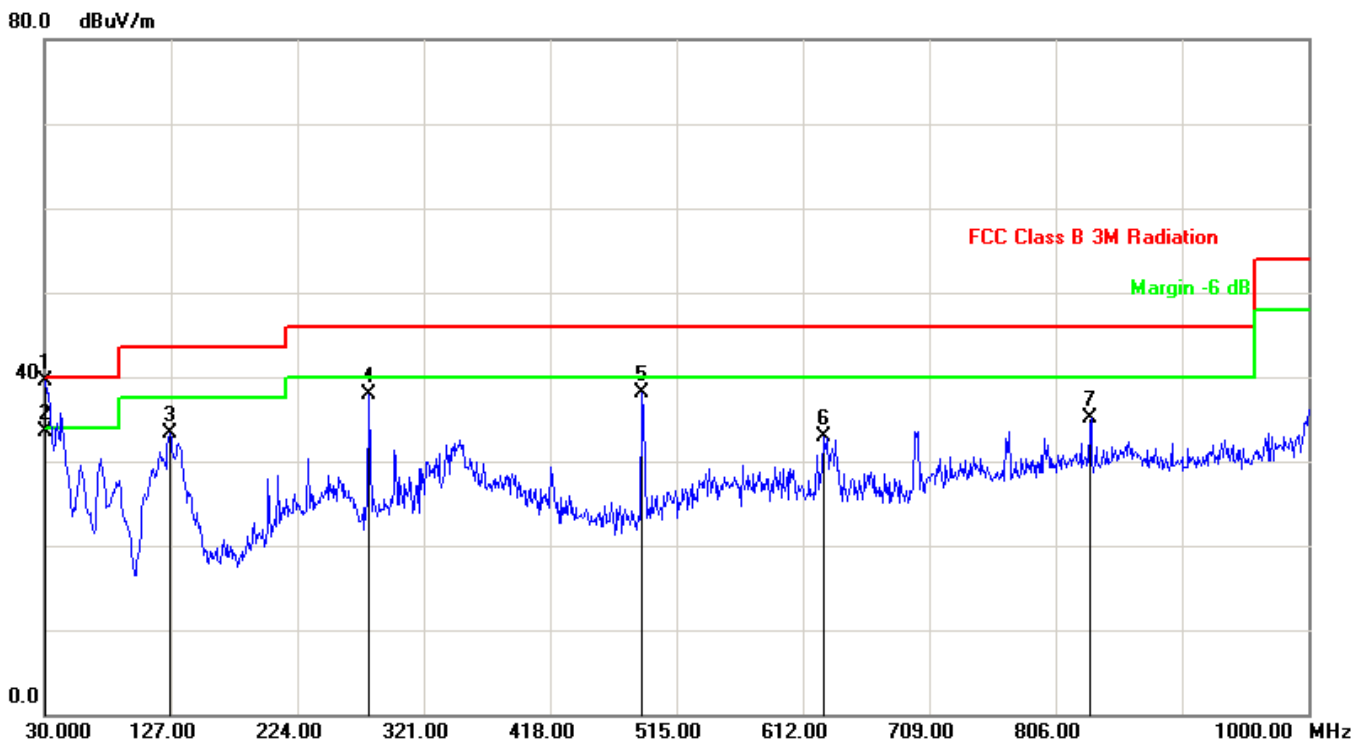

No.	Frequency (MHz)	Factor (dB/m)	Reading (dBuV)	Level (dBuV/m)	Limit (dBuV/m)	Margin (dB)	Det.
1	30.9700	-4.67	44.23	39.56	40.00	-0.44	peak
2	30.9700	-4.67	38.24	33.57	40.00	-6.43	QP
3	126.0300	-12.13	45.39	33.26	43.50	-10.24	peak
4	278.3200	-8.38	46.25	37.87	46.00	-8.13	peak
5	487.8400	-5.49	43.64	38.15	46.00	-7.85	peak
6	627.5200	-3.53	36.44	32.91	46.00	-13.09	peak
7	833.1599	2.22	32.88	35.10	46.00	-10.90	peak

Note: Measure Level (dBuV/m) = Reading Level (dBuV) + Factor (dB)

Factor (dB) = Cable Loss (dB) + Antenna Factor (dB/m) - Pre_Amplifier Gain (dB)



Test Distance:	3M		
Test Standard:	FCC Class B 3M Radiation	Ant. Polarization:	Horizontal
Test item:	Radiation Emission	Test Time:	2019-8-1520:13:50
Applicant:	Mitac Digital Technology Company	Power Rating:	AC 120V/60Hz
Product:	Tablet	Temp.(C)/Hum.(/Air p.(hpa):	26(°C)/60%/983hpa
Model No.:	N642	Test Engineer:	Chris
Test Mode:	BT3.0		
Remark:	POE Power		

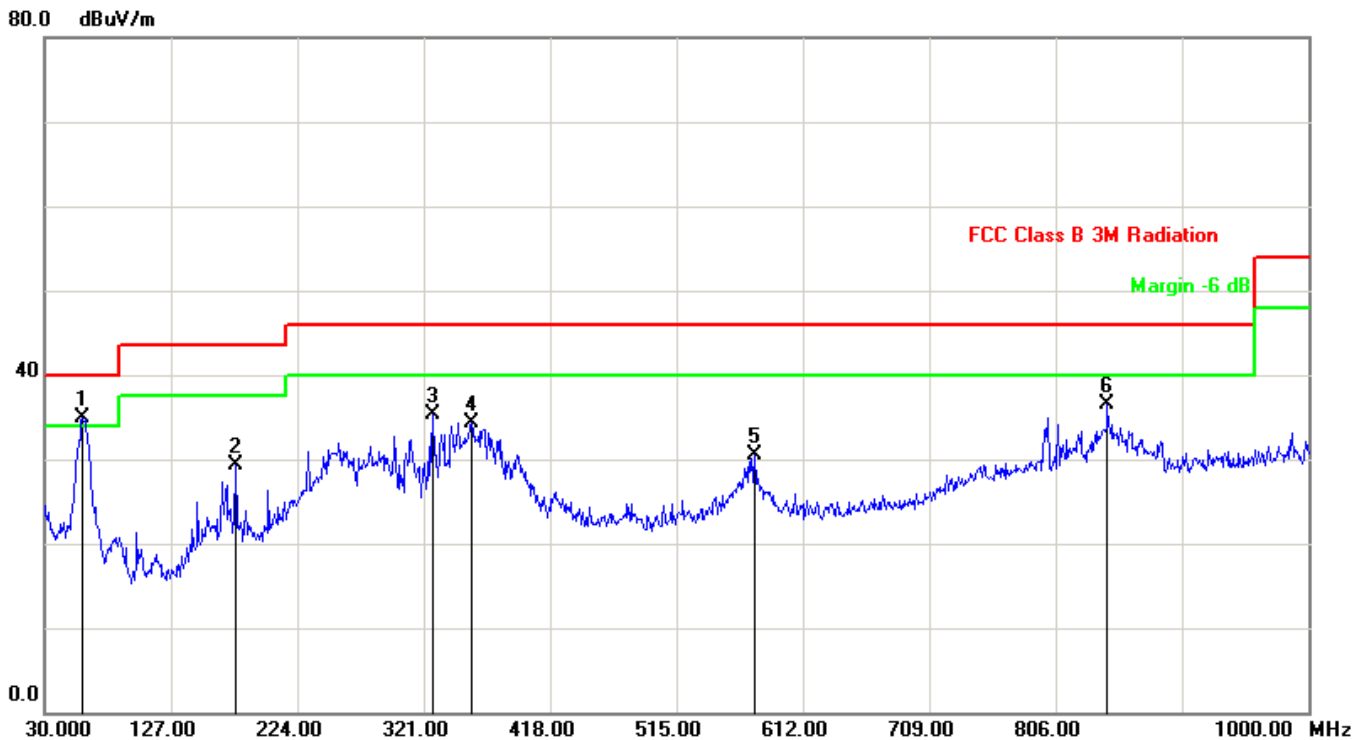

No.	Frequency (MHz)	Factor (dB/m)	Reading (dBuV)	Level (dBuV/m)	Limit (dBuV/m)	Margin (dB)	Det.
1	59.1000	-14.75	49.65	34.90	40.00	-5.10	peak
2	176.4700	-12.60	41.90	29.30	43.50	-14.20	peak
3	327.7900	-7.90	43.27	35.37	46.00	-10.63	peak
4	357.8599	-7.81	42.04	34.23	46.00	-11.77	peak
5	575.1400	-3.87	34.31	30.44	46.00	-15.56	peak
6	845.7700	2.37	34.19	36.56	46.00	-9.44	peak

Note: Measure Level (dBuV/m) = Reading Level (dBuV) + Factor (dB)

Factor (dB) = Cable Loss (dB) + Antenna Factor (dB/m) - Pre_Amplifier Gain (dB)



Test Distance:	3M		
Test Standard:	FCC Class B 3M Radiation	Ant. Polarization:	Vertical
Test item:	Radiation Emission	Test Time:	2019-8-1520:17:55
Applicant:	Mitac Digital Technology Company	Power Rating:	AC 120V/60Hz
Product:	Tablet	Temp.(C)/Hum.(/Air p.(hpa):	26(°C)/60%/983hpa
Model No.:	N642	Test Engineer:	Chris
Test Mode:	BT3.0		
Remark:	POE Power		

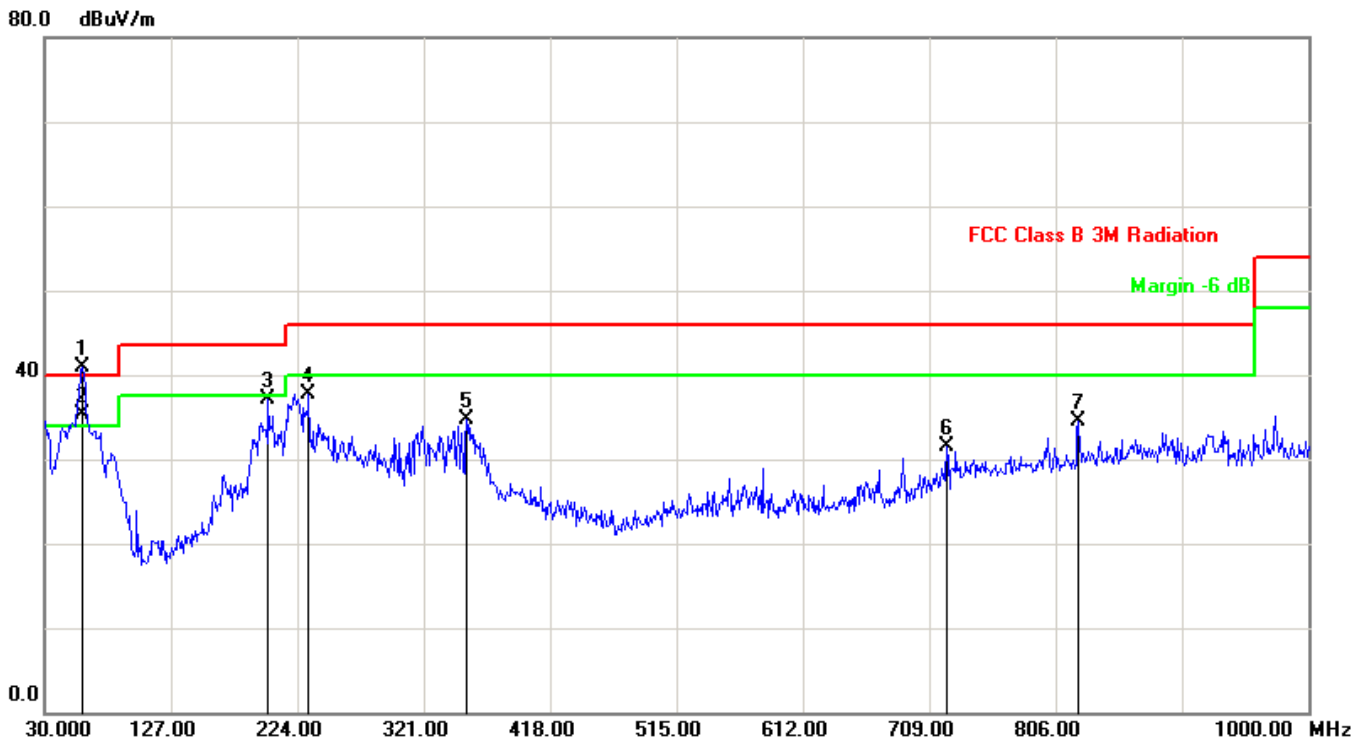

No.	Frequency (MHz)	Factor (dB/m)	Reading (dBuV)	Level (dBuV/m)	Limit (dBuV/m)	Margin (dB)	Det.
1	59.1000	-14.75	55.71	40.96	40.00	0.96	peak
2	59.6600	-14.86	50.25	35.39	40.00	-4.61	QP
3	201.6899	-11.43	48.48	37.05	43.50	-6.45	peak
4	232.7299	-10.91	48.57	37.66	46.00	-8.34	peak
5	353.9800	-7.88	42.67	34.79	46.00	-11.21	peak
6	722.5800	-0.59	32.14	31.55	46.00	-14.45	peak
7	823.4600	2.10	32.44	34.54	46.00	-11.46	peak

Note: Measure Level (dBuV/m) = Reading Level (dBuV) + Factor (dB)

Factor (dB) = Cable Loss (dB) + Antenna Factor (dB/m) - Pre_Amplifier Gain (dB)

**Radiated Emission above 1GHz:**

Test Distance:	3M		
Test Standard:	FCC Class B Above 1G 3M Radiation PK	Ant. Polarization:	Horizontal
Test item:	Radiation Emission	Test Time:	2019-8-618:38:22
Applicant:	Mitac Digital Technology Company	Power Rating:	AC 120V/60Hz
Product:	Tablet	Temp.(C)/Hum.(%)/Air p.(hpa):	26(°C)/60%/983hpa
Model No.:	N642	Test Engineer:	Chris
Test Mode:	BT3.0-DH5 2402MHz		
Remark:	POE Power		

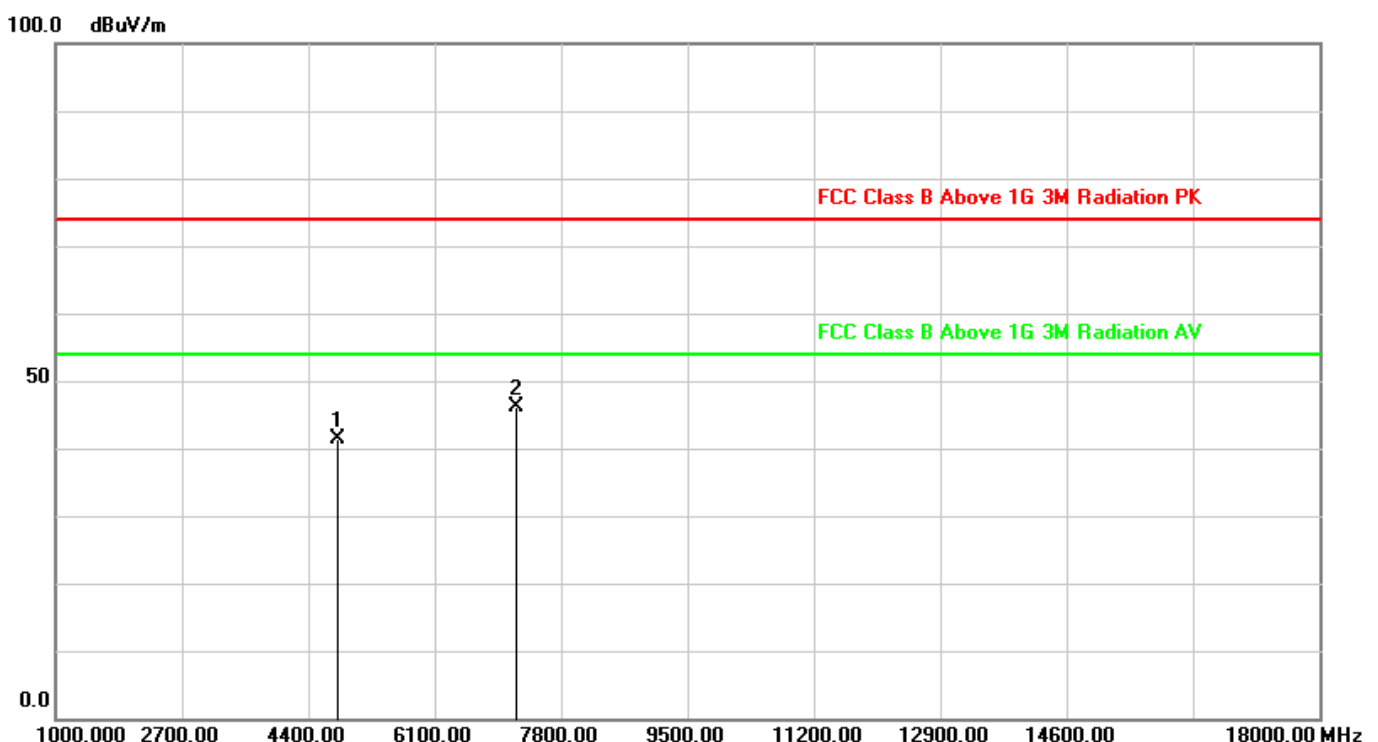

No.	Frequency (MHz)	Factor (dB/m)	Reading (dBuV)	Level (dBuV/m)	Limit (dBuV/m)	Margin (dB)	Det.
1	4804.000	3.28	38.15	41.43	74.00	-32.57	peak
2	7206.000	8.19	38.06	46.25	74.00	-27.75	peak

Note: 1. All Readings below 1GHz are Quasi-Peak, above are performed with peak and/or AVG measurements as necessary.

2. Measurement Level = Reading Level + Correct Factor.

3. The test trace is same as the ambient noise (the test frequency range: 9kHz~30MHz, 18GHz~40GHz), therefore no data appear in the report.

4. This limit applies for using average detector, if the test result on peak is lower than average limit, then average measurement needn't be performed.



Test Distance:	3M		
Test Standard:	FCC Class B Above 1G 3M	Ant. Polarization:	Vertical
	Radiation PK		
Test item:	Radiation Emission	Test Time:	2019-8-618:42:46
Applicant:	Mitac Digital Technology Company	Power Rating:	AC 120V/60Hz
Product:	Tablet	Temp.(C)/Hum.(%)/Air p.(hpa):	26(°C)/60%/983hpa
Model No.:	N642	Test Engineer:	Chris
Test Mode:	BT3.0-DH5 2402MHz		
Remark:	POE Power		

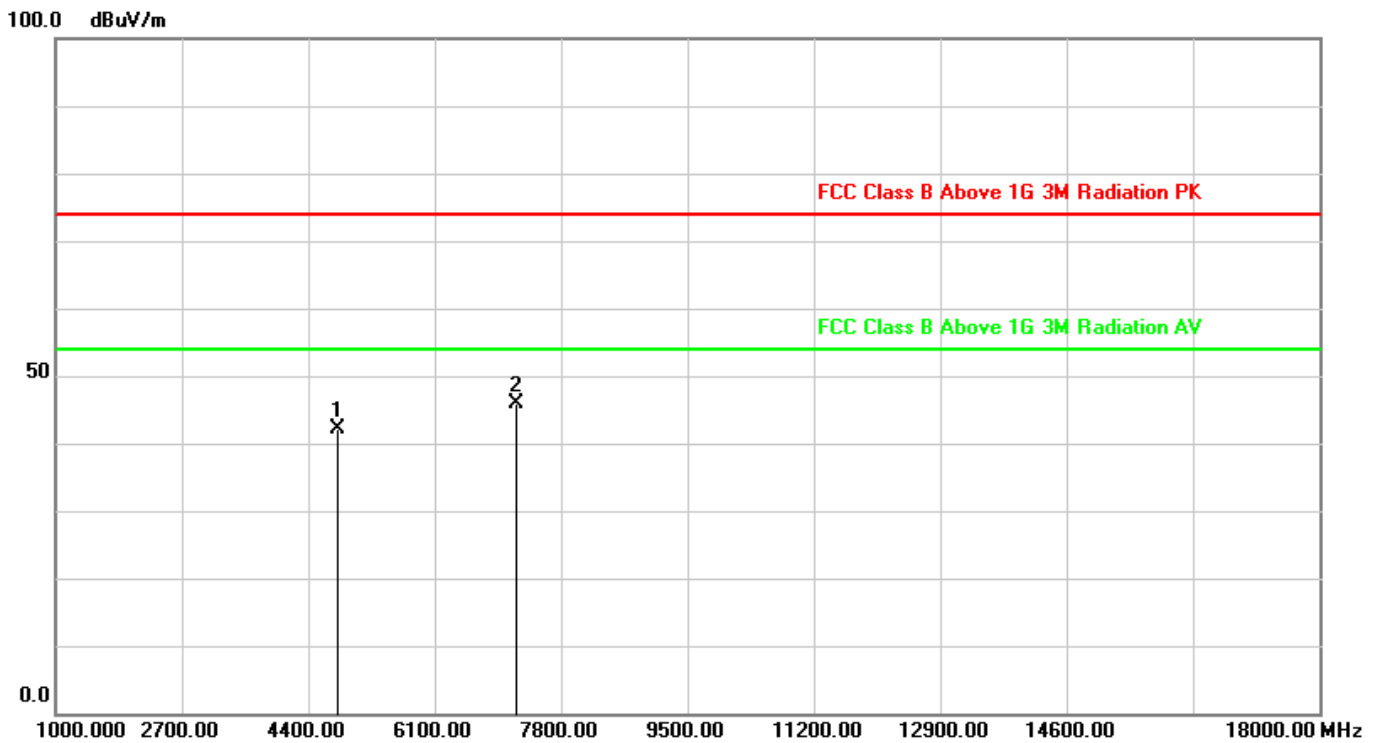

No.	Frequency (MHz)	Factor (dB/m)	Reading (dBuV)	Level (dBuV/m)	Limit (dBuV/m)	Margin (dB)	Det.
1	4804.000	3.28	38.73	42.01	74.00	-31.99	peak
2	7206.000	8.19	37.59	45.78	74.00	-28.22	peak

Note: 1. All Readings below 1GHz are Quasi-Peak, above are performed with peak and/or AVG measurements as necessary.

2. Measurement Level = Reading Level + Correct Factor.

3. The test trace is same as the ambient noise (the test frequency range: 9kHz~30MHz, 18GHz~40GHz), therefore no data appear in the report.

4. This limit applies for using average detector, if the test result on peak is lower than average limit, then average measurement needn't be performed.



Test Distance:	3M		
Test Standard:	FCC Class B Above 1G 3M	Ant. Polarization:	Horizontal
	Radiation PK		
Test item:	Radiation Emission	Test Time:	2019-8-618:47:48
Applicant:	Mitac Digital Technology Company	Power Rating:	AC 120V/60Hz
Product:	Tablet	Temp.(C)/Hum.(%)/Air p.(hpa):	26(°C)/60%/983hpa
Model No.:	N642	Test Engineer:	Chris
Test Mode:	BT3.0-DH5 2441MHz		
Remark:	POE Power		

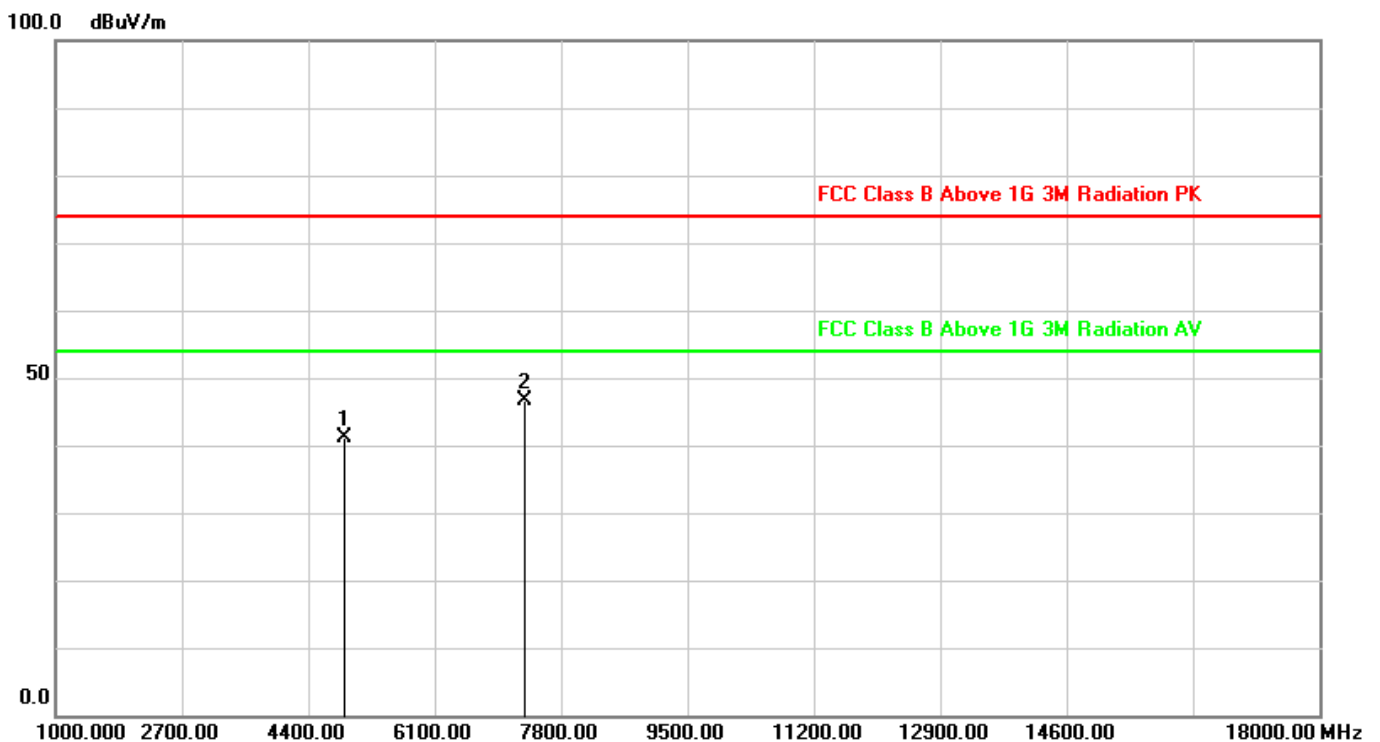

No.	Frequency (MHz)	Factor (dB/m)	Reading (dBuV)	Level (dBuV/m)	Limit (dBuV/m)	Margin (dB)	Det.
1	4882.000	3.44	37.65	41.09	74.00	-32.91	peak
2	7323.000	8.28	38.36	46.64	74.00	-27.36	peak

Note: 1. All Readings below 1GHz are Quasi-Peak, above are performed with peak and/or AVG measurements as necessary.

2. Measurement Level = Reading Level + Correct Factor.

3. The test trace is same as the ambient noise (the test frequency range: 9kHz~30MHz, 18GHz~40GHz), therefore no data appear in the report.

4. This limit applies for using average detector, if the test result on peak is lower than average limit, then average measurement needn't be performed.



Test Distance:	3M		
Test Standard:	FCC Class B Above 1G 3M	Ant. Polarization:	Vertical
	Radiation PK		
Test item:	Radiation Emission	Test Time:	2019-8-618:51:14
Applicant:	Mitac Digital Technology Company	Power Rating:	AC 120V/60Hz
Product:	Tablet	Temp.(C)/Hum.(%)/Air p.(hpa):	26(°C)/60%/983hpa
Model No.:	N642	Test Engineer:	Chris
Test Mode:	BT3.0-DH5 2441MHz		
Remark:	POE Power		

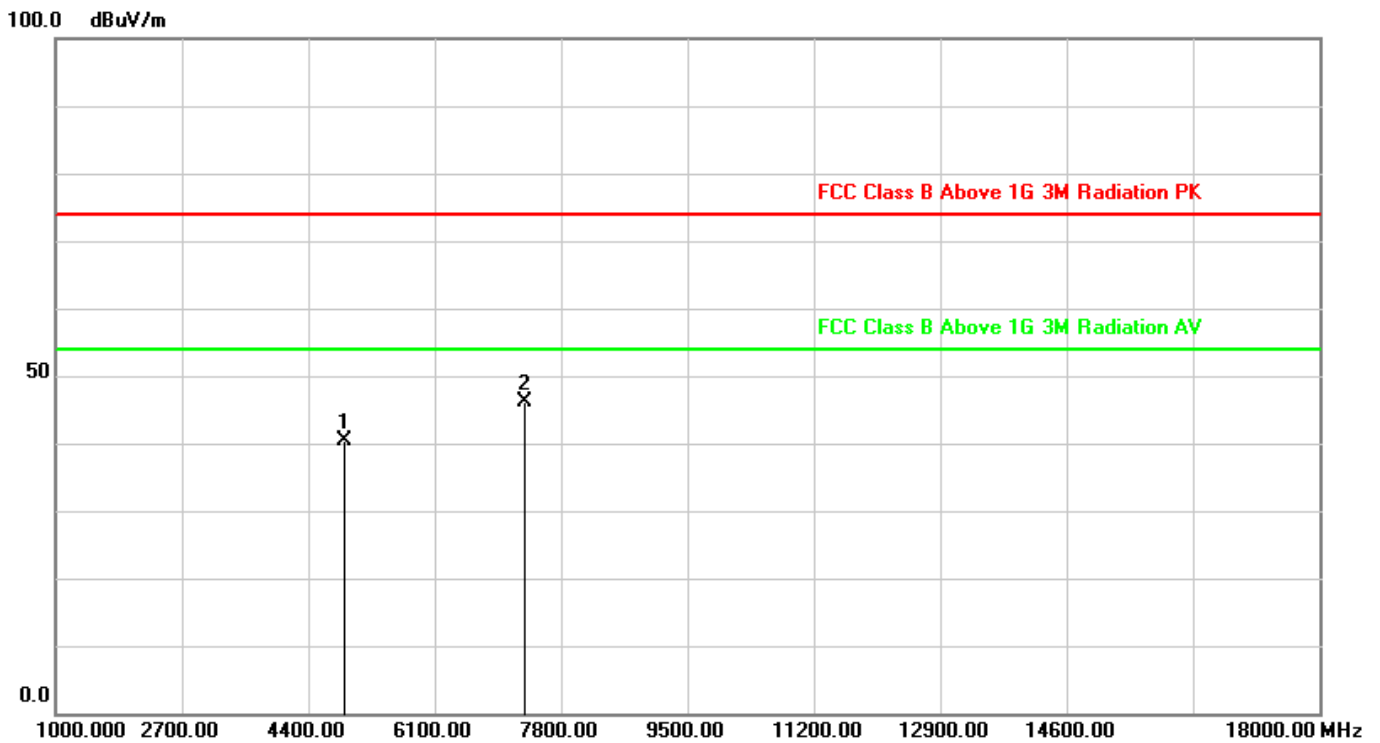

No.	Frequency (MHz)	Factor (dB/m)	Reading (dBuV)	Level (dBuV/m)	Limit (dBuV/m)	Margin (dB)	Det.
1	4882.000	3.44	36.87	40.31	74.00	-33.69	peak
2	7323.000	8.28	37.77	46.05	74.00	-27.95	peak

Note: 1. All Readings below 1GHz are Quasi-Peak, above are performed with peak and/or AVG measurements as necessary.

2. Measurement Level = Reading Level + Correct Factor.

3. The test trace is same as the ambient noise (the test frequency range: 9kHz~30MHz, 18GHz~40GHz), therefore no data appear in the report.

4. This limit applies for using average detector, if the test result on peak is lower than average limit, then average measurement needn't be performed.



Test Distance:	3M		
Test Standard:	FCC Class B Above 1G 3M	Ant. Polarization:	Horizontal
	Radiation PK		
Test item:	Radiation Emission	Test Time:	2019-8-618:54:31
Applicant:	Mitac Digital Technology Company	Power Rating:	AC 120V/60Hz
Product:	Tablet	Temp.(C)/Hum.(%)/Air p.(hpa):	26(°C)/60%/983hpa
Model No.:	N642	Test Engineer:	Chris
Test Mode:	BT3.0-DH5 2480MHz		
Remark:	POE Power		

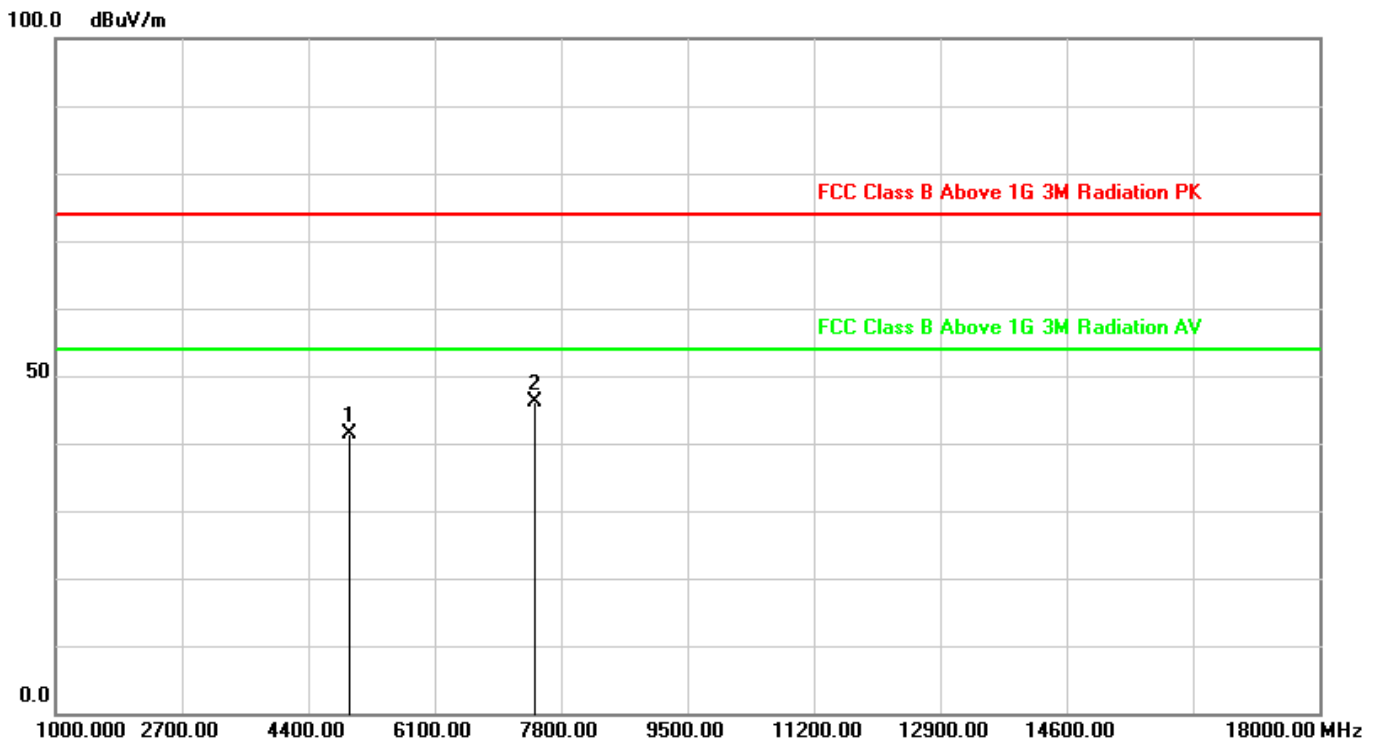

No.	Frequency (MHz)	Factor (dB/m)	Reading (dBuV)	Level (dBuV/m)	Limit (dBuV/m)	Margin (dB)	Det.
1	4960.000	3.59	37.89	41.48	74.00	-32.52	peak
2	7440.000	8.36	37.72	46.08	74.00	-27.92	peak

Note: 1. All Readings below 1GHz are Quasi-Peak, above are performed with peak and/or AVG measurements as necessary.

2. Measurement Level = Reading Level + Correct Factor.

3. The test trace is same as the ambient noise (the test frequency range: 9kHz~30MHz, 18GHz~40GHz), therefore no data appear in the report.

4. This limit applies for using average detector, if the test result on peak is lower than average limit, then average measurement needn't be performed.



Test Distance:	3M		
Test Standard:	FCC Class B Above 1G 3M	Ant. Polarization:	Vertical
	Radiation PK		
Test item:	Radiation Emission	Test Time:	2019-8-618:56:26
Applicant:	Mitac Digital Technology Company	Power Rating:	AC 120V/60Hz
Product:	Tablet	Temp.(C)/Hum.(%)/Air p.(hpa):	26(°C)/60%/983hpa
Model No.:	N642	Test Engineer:	Chris
Test Mode:	BT3.0-DH5 2480MHz		
Remark:	POE Power		

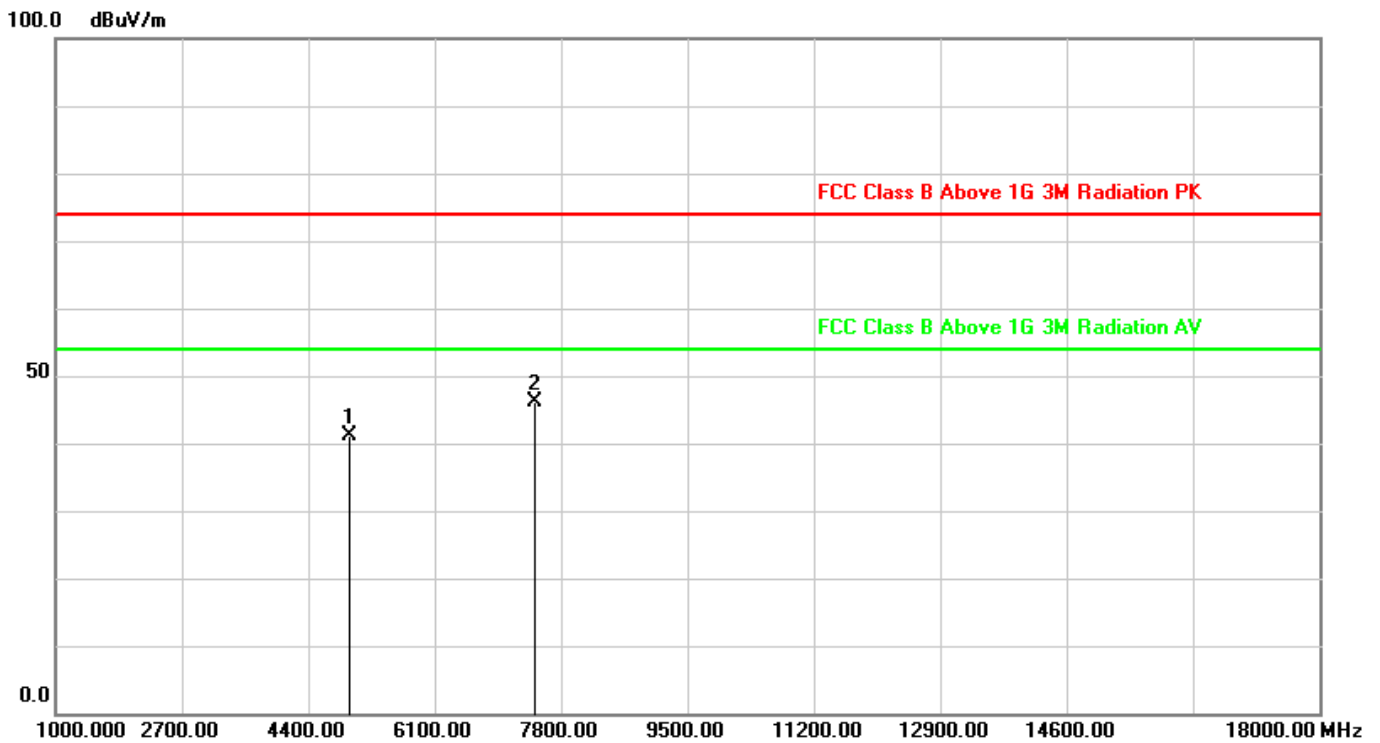

No.	Frequency (MHz)	Factor (dB/m)	Reading (dBuV)	Level (dBuV/m)	Limit (dBuV/m)	Margin (dB)	Det.
1	4960.000	3.59	37.48	41.07	74.00	-32.93	peak
2	7440.000	8.36	37.72	46.08	74.00	-27.92	peak

Note: 1. All Readings below 1GHz are Quasi-Peak, above are performed with peak and/or AVG measurements as necessary.

2. Measurement Level = Reading Level + Correct Factor.

3. The test trace is same as the ambient noise (the test frequency range: 9kHz~30MHz, 18GHz~40GHz), therefore no data appear in the report.

4. This limit applies for using average detector, if the test result on peak is lower than average limit, then average measurement needn't be performed.



Test Distance:	3M		
Test Standard:	FCC Class B Above 1G 3M	Ant. Polarization:	Horizontal
	Radiation PK		
Test item:	Radiation Emission	Test Time:	2019-8-619:01:48
Applicant:	Mitac Digital Technology Company	Power Rating:	AC 120V/60Hz
Product:	Tablet	Temp.(C)/Hum.(%)/Air p.(hpa):	26(°C)/60%/983hpa
Model No.:	N642	Test Engineer:	Chris
Test Mode:	BT3.0-2DH5 2402MHz		
Remark:	POE Power		

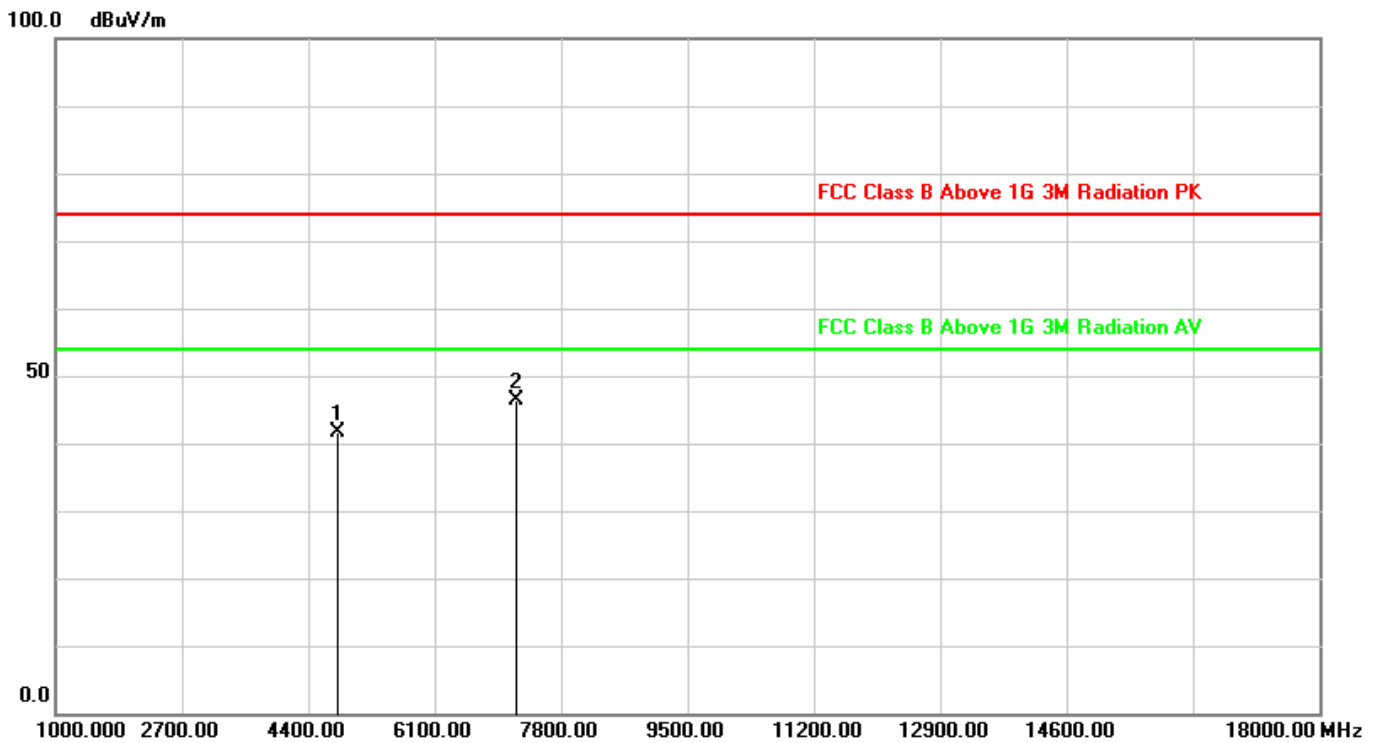

No.	Frequency (MHz)	Factor (dB/m)	Reading (dBuV)	Level (dBuV/m)	Limit (dBuV/m)	Margin (dB)	Det.
1	4804.000	3.28	38.24	41.52	74.00	-32.48	peak
2	7206.000	8.19	38.25	46.44	74.00	-27.56	peak

Note: 1. All Readings below 1GHz are Quasi-Peak, above are performed with peak and/or AVG measurements as necessary.

2. Measurement Level = Reading Level + Correct Factor.

3. The test trace is same as the ambient noise (the test frequency range: 9kHz~30MHz, 18GHz~40GHz), therefore no data appear in the report.

4. This limit applies for using average detector, if the test result on peak is lower than average limit, then average measurement needn't be performed.



Test Distance:	3M		
Test Standard:	FCC Class B Above 1G 3M	Ant. Polarization:	Vertical
	Radiation PK		
Test item:	Radiation Emission	Test Time:	2019-8-619:04:11
Applicant:	Mitac Digital Technology Company	Power Rating:	AC 120V/60Hz
Product:	Tablet	Temp.(C)/Hum.(%)/Air p.(hpa):	26(°C)/60%/983hpa
Model No.:	N642	Test Engineer:	Chris
Test Mode:	BT3.0-2DH5 2402MHz		
Remark:	POE Power		

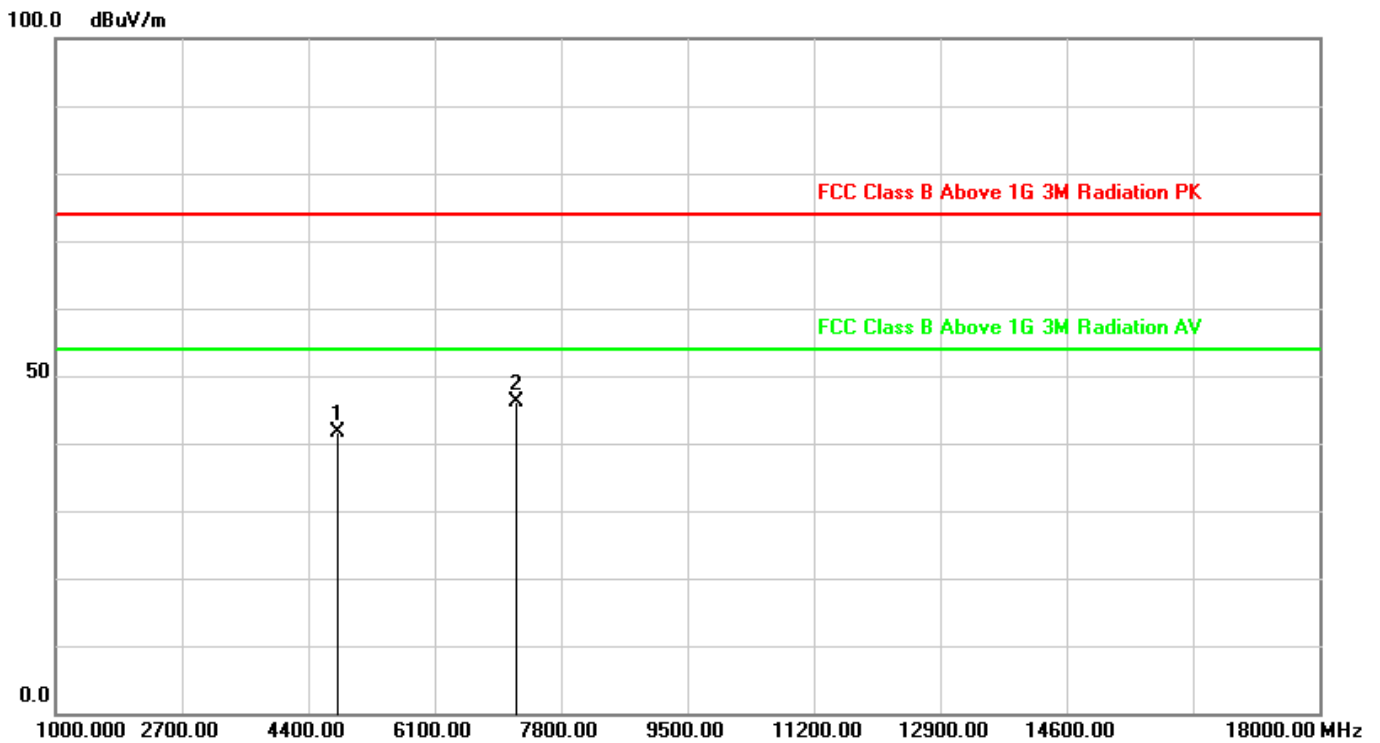

No.	Frequency (MHz)	Factor (dB/m)	Reading (dBuV)	Level (dBuV/m)	Limit (dBuV/m)	Margin (dB)	Det.
1	4804.000	3.28	38.35	41.63	74.00	-32.37	peak
2	7206.000	8.19	37.93	46.12	74.00	-27.88	peak

Note: 1. All Readings below 1GHz are Quasi-Peak, above are performed with peak and/or AVG measurements as necessary.

2. Measurement Level = Reading Level + Correct Factor.

3. The test trace is same as the ambient noise (the test frequency range: 9kHz~30MHz, 18GHz~40GHz), therefore no data appear in the report.

4. This limit applies for using average detector, if the test result on peak is lower than average limit, then average measurement needn't be performed.



Test Distance:	3M		
Test Standard:	FCC Class B Above 1G 3M	Ant. Polarization:	Horizontal
	Radiation PK		
Test item:	Radiation Emission	Test Time:	2019-8-619:08:49
Applicant:	Mitac Digital Technology Company	Power Rating:	AC 120V/60Hz
Product:	Tablet	Temp.(C)/Hum.(%)/Air p.(hpa):	26(°C)/60%/983hpa
Model No.:	N642	Test Engineer:	Chris
Test Mode:	BT3.0-2DH5 2441MHz		
Remark:	POE Power		

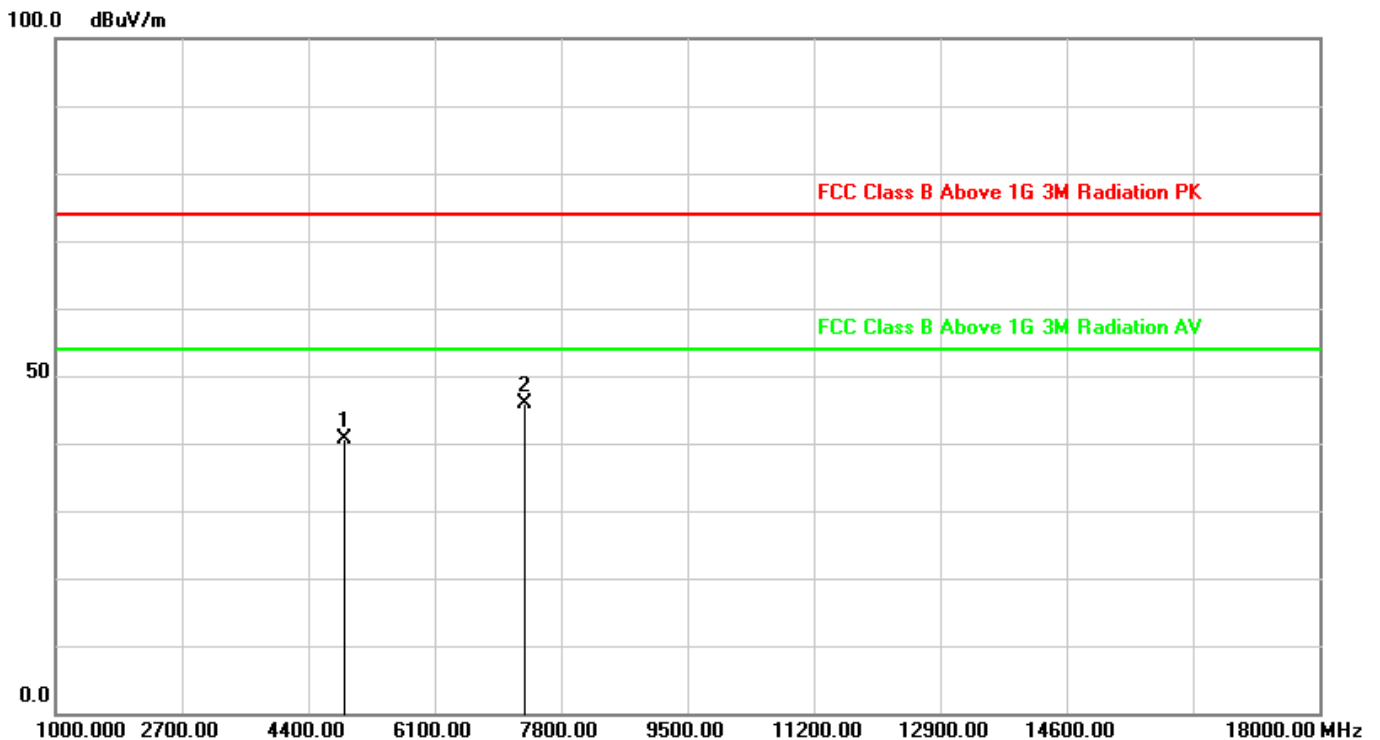

No.	Frequency (MHz)	Factor (dB/m)	Reading (dBuV)	Level (dBuV/m)	Limit (dBuV/m)	Margin (dB)	Det.
1	4882.000	3.44	37.25	40.69	74.00	-33.31	peak
2	7323.000	8.28	37.57	45.85	74.00	-28.15	peak

Note: 1. All Readings below 1GHz are Quasi-Peak, above are performed with peak and/or AVG measurements as necessary.

2. Measurement Level = Reading Level + Correct Factor.

3. The test trace is same as the ambient noise (the test frequency range: 9kHz~30MHz, 18GHz~40GHz), therefore no data appear in the report.

4. This limit applies for using average detector, if the test result on peak is lower than average limit, then average measurement needn't be performed.



Test Distance:	3M		
Test Standard:	FCC Class B Above 1G 3M	Ant. Polarization:	Vertical
	Radiation PK		
Test item:	Radiation Emission	Test Time:	2019-8-619:16:02
Applicant:	Mitac Digital Technology Company	Power Rating:	AC 120V/60Hz
Product:	Tablet	Temp.(C)/Hum.(%)/Air p.(hpa):	26(°C)/60%/983hpa
Model No.:	N642	Test Engineer:	Chris
Test Mode:	BT3.0-2DH5 2441MHz		
Remark:	POE Power		

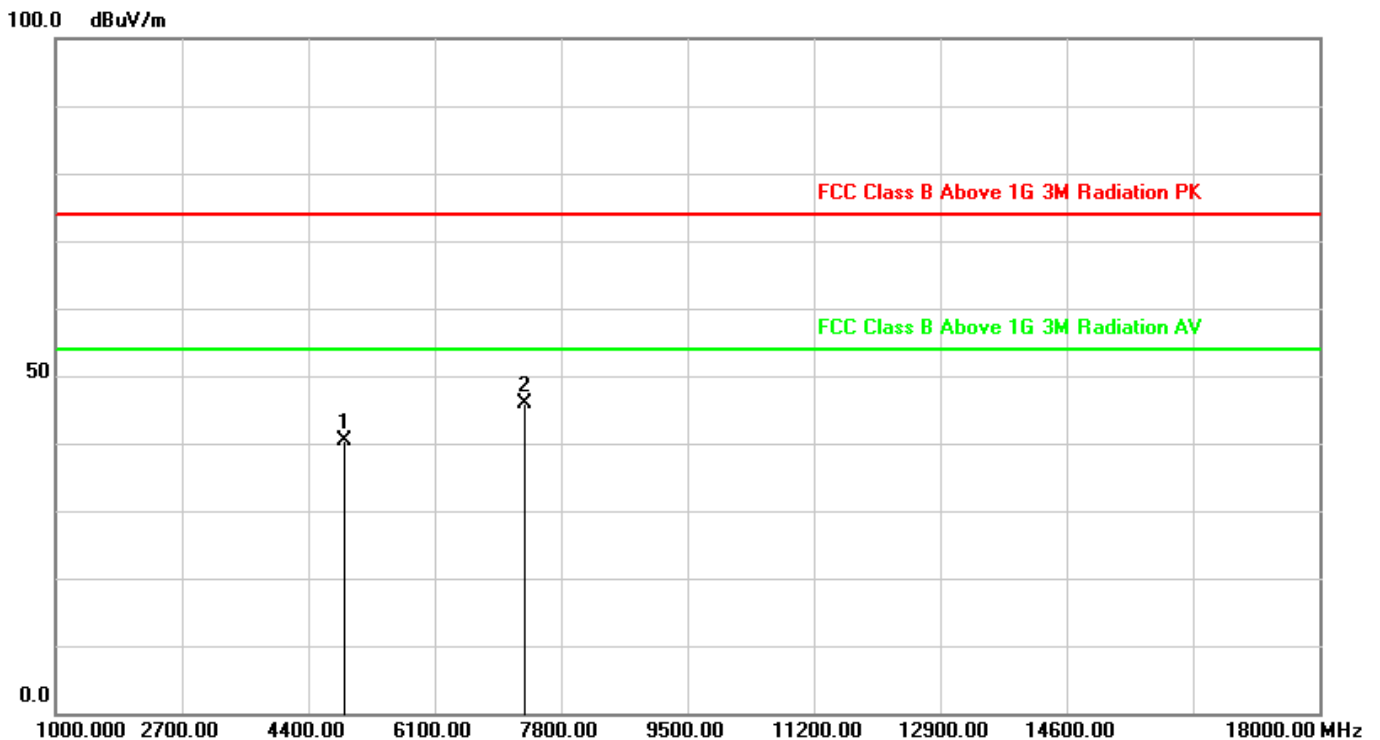

No.	Frequency (MHz)	Factor (dB/m)	Reading (dBuV)	Level (dBuV/m)	Limit (dBuV/m)	Margin (dB)	Det.
1	4882.000	3.44	36.93	40.37	74.00	-33.63	peak
2	7323.000	8.28	37.64	45.92	74.00	-28.08	peak

Note: 1. All Readings below 1GHz are Quasi-Peak, above are performed with peak and/or AVG measurements as necessary.

2. Measurement Level = Reading Level + Correct Factor.

3. The test trace is same as the ambient noise (the test frequency range: 9kHz~30MHz, 18GHz~40GHz), therefore no data appear in the report.

4. This limit applies for using average detector, if the test result on peak is lower than average limit, then average measurement needn't be performed.



Test Distance:	3M		
Test Standard:	FCC Class B Above 1G 3M	Ant. Polarization:	Horizontal
	Radiation PK		
Test item:	Radiation Emission	Test Time:	2019-8-619:18:43
Applicant:	Mitac Digital Technology Company	Power Rating:	AC 120V/60Hz
Product:	Tablet	Temp.(C)/Hum.(/Air p.(hpa):	26(°C)/60%/983hpa
Model No.:	N642	Test Engineer:	Chris
Test Mode:	BT3.0-2DH5 2480MHz		
Remark:	POE Power		

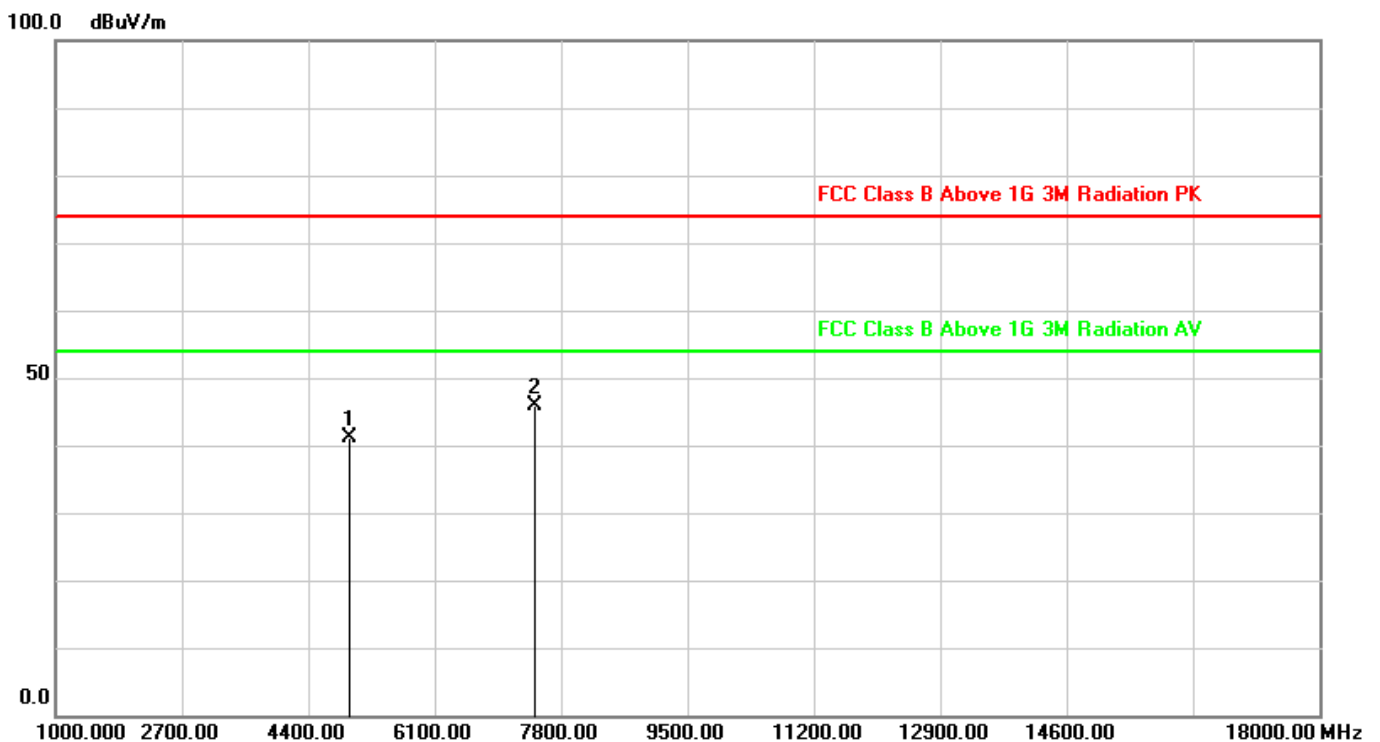

No.	Frequency (MHz)	Factor (dB/m)	Reading (dBuV)	Level (dBuV/m)	Limit (dBuV/m)	Margin (dB)	Det.
1	4960.000	3.59	37.49	41.08	74.00	-32.92	peak
2	7440.000	8.36	37.40	45.76	74.00	-28.24	peak

Note: 1. All Readings below 1GHz are Quasi-Peak, above are performed with peak and/or AVG measurements as necessary.

2. Measurement Level = Reading Level + Correct Factor.

3. The test trace is same as the ambient noise (the test frequency range: 9kHz~30MHz, 18GHz~40GHz), therefore no data appear in the report.

4. This limit applies for using average detector, if the test result on peak is lower than average limit, then average measurement needn't be performed.



Test Distance:	3M		
Test Standard:	FCC Class B Above 1G 3M	Ant. Polarization:	Vertical
	Radiation PK		
Test item:	Radiation Emission	Test Time:	2019-8-619:20:28
Applicant:	Mitac Digital Technology Company	Power Rating:	AC 120V/60Hz
Product:	Tablet	Temp.(C)/Hum.(%)/Air p.(hpa):	26(°C)/60%/983hpa
Model No.:	N642	Test Engineer:	Chris
Test Mode:	BT3.0-2DH5 2480MHz		
Remark:	POE Power		

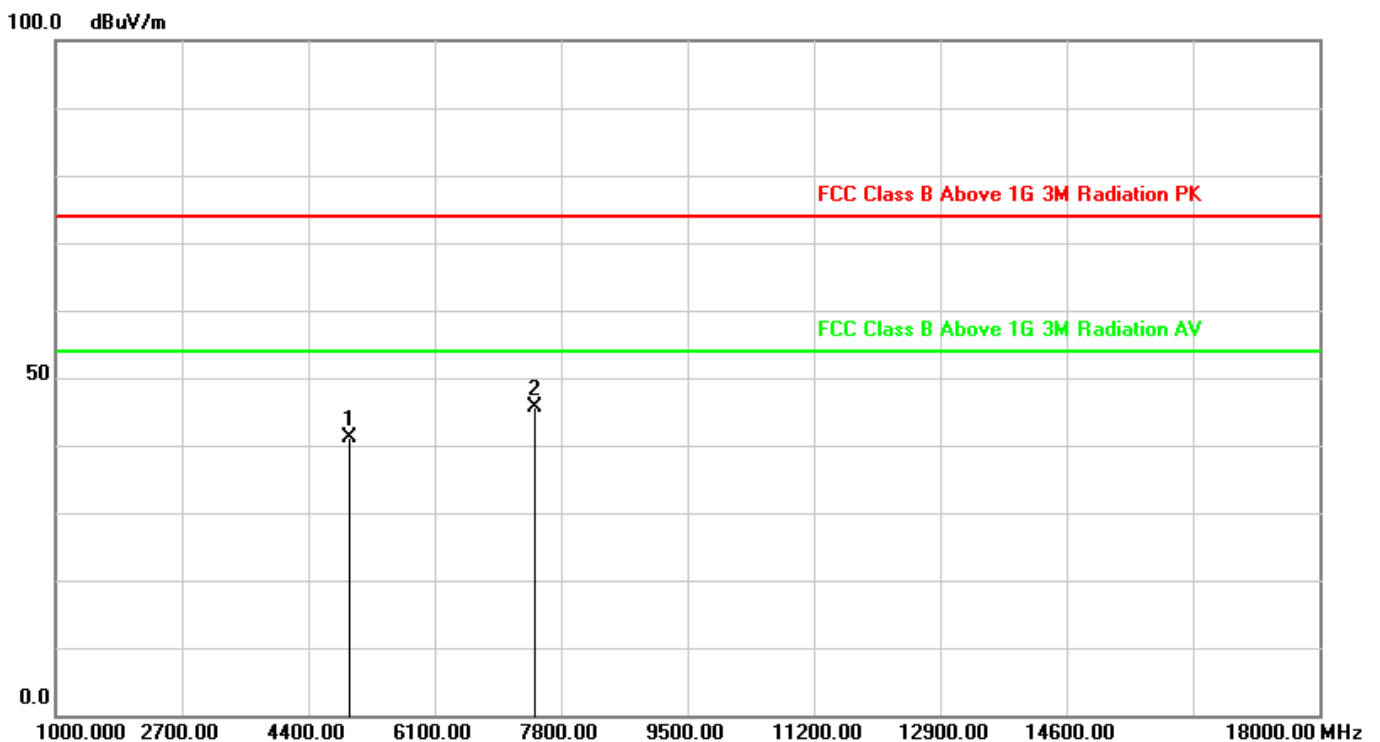

No.	Frequency (MHz)	Factor (dB/m)	Reading (dBuV)	Level (dBuV/m)	Limit (dBuV/m)	Margin (dB)	Det.
1	4960.000	3.59	37.47	41.06	74.00	-32.94	peak
2	7440.000	8.36	37.39	45.75	74.00	-28.25	peak

Note: 1. All Readings below 1GHz are Quasi-Peak, above are performed with peak and/or AVG measurements as necessary.

2. Measurement Level = Reading Level + Correct Factor.

3. The test trace is same as the ambient noise (the test frequency range: 9kHz~30MHz, 18GHz~40GHz), therefore no data appear in the report.

4. This limit applies for using average detector, if the test result on peak is lower than average limit, then average measurement needn't be performed.



Test Distance:	3M		
Test Standard:	FCC Class B Above 1G 3M	Ant. Polarization:	Horizontal
	Radiation PK		
Test item:	Radiation Emission	Test Time:	2019-8-619:24:04
Applicant:	Mitac Digital Technology Company	Power Rating:	AC 120V/60Hz
Product:	Tablet	Temp.(C)/Hum.(%)/Air p.(hpa):	26(°C)/60%/983hpa
Model No.:	N642	Test Engineer:	Chris
Test Mode:	BT3.0-3DH5 2402MHz		
Remark:	POE Power		

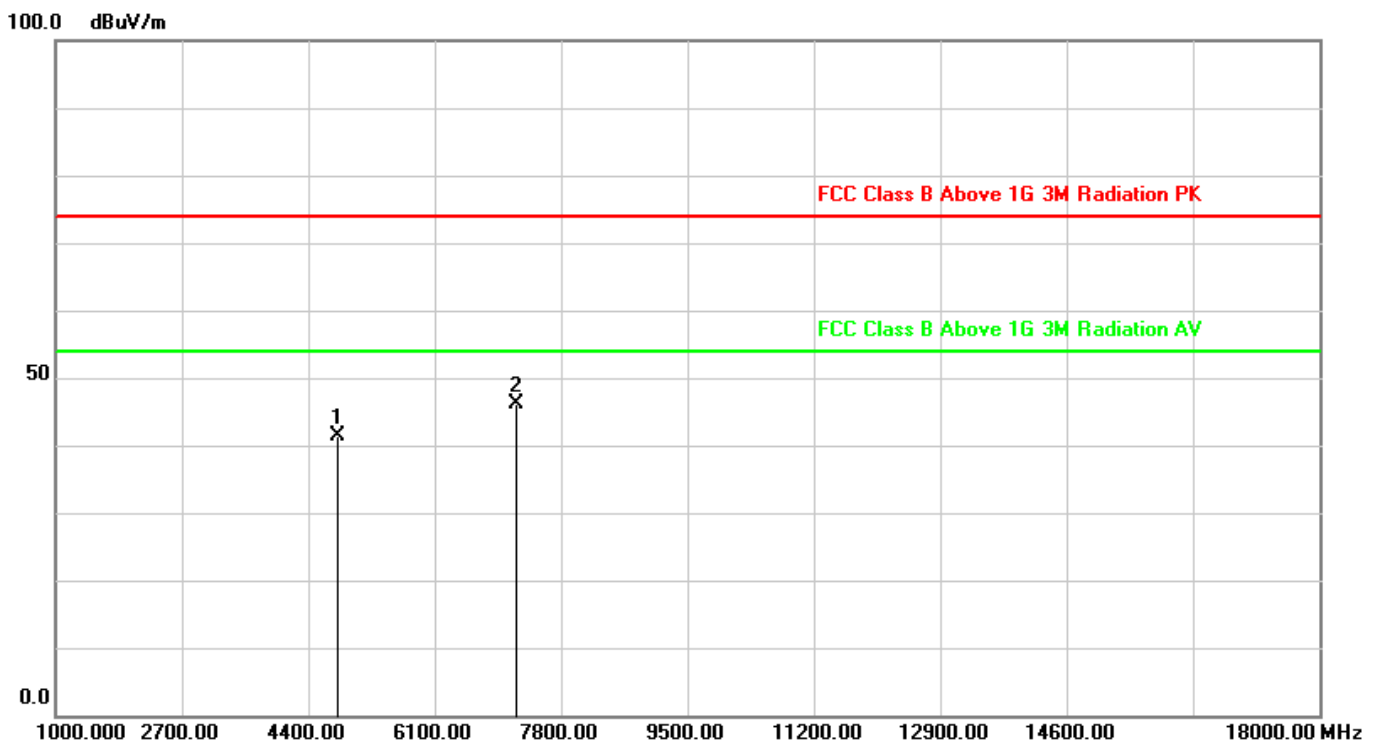

No.	Frequency (MHz)	Factor (dB/m)	Reading (dBuV)	Level (dBuV/m)	Limit (dBuV/m)	Margin (dB)	Det.
1	4804.000	3.28	38.09	41.37	74.00	-32.63	peak
2	7206.000	8.19	37.92	46.11	74.00	-27.89	peak

Note: 1. All Readings below 1GHz are Quasi-Peak, above are performed with peak and/or AVG measurements as necessary.

2. Measurement Level = Reading Level + Correct Factor.

3. The test trace is same as the ambient noise (the test frequency range: 9kHz~30MHz, 18GHz~40GHz), therefore no data appear in the report.

4. This limit applies for using average detector, if the test result on peak is lower than average limit, then average measurement needn't be performed.



Test Distance:	3M		
Test Standard:	FCC Class B Above 1G 3M	Ant. Polarization:	Vertical
	Radiation PK		
Test item:	Radiation Emission	Test Time:	2019-8-619:27:19
Applicant:	Mitac Digital Technology Company	Power Rating:	AC 120V/60Hz
Product:	Tablet	Temp.(C)/Hum.(%)/Air p.(hpa):	26(°C)/60%/983hpa
Model No.:	N642	Test Engineer:	Chris
Test Mode:	BT3.0-3DH5 2402MHz		
Remark:	POE Power		

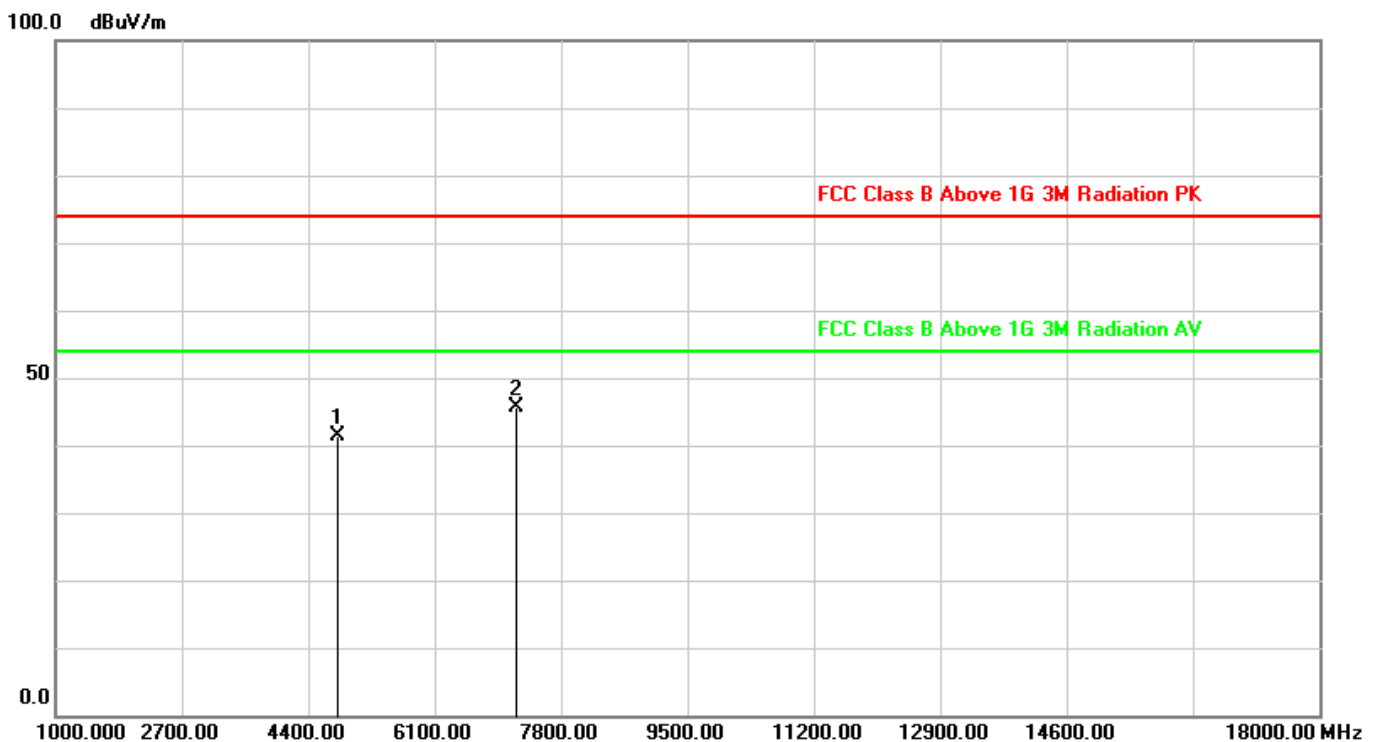

No.	Frequency (MHz)	Factor (dB/m)	Reading (dBuV)	Level (dBuV/m)	Limit (dBuV/m)	Margin (dB)	Det.
1	4804.000	3.28	37.98	41.26	74.00	-32.74	peak
2	7206.000	8.19	37.44	45.63	74.00	-28.37	peak

Note: 1. All Readings below 1GHz are Quasi-Peak, above are performed with peak and/or AVG measurements as necessary.

2. Measurement Level = Reading Level + Correct Factor.

3. The test trace is same as the ambient noise (the test frequency range: 9kHz~30MHz, 18GHz~40GHz), therefore no data appear in the report.

4. This limit applies for using average detector, if the test result on peak is lower than average limit, then average measurement needn't be performed.



Test Distance:	3M		
Test Standard:	FCC Class B Above 1G 3M	Ant. Polarization:	Horizontal
	Radiation PK		
Test item:	Radiation Emission	Test Time:	2019-8-619:30:45
Applicant:	Mitac Digital Technology Company	Power Rating:	AC 120V/60Hz
Product:	Tablet	Temp.(C)/Hum.(%)/Air p.(hpa):	26(°C)/60%/983hpa
Model No.:	N642	Test Engineer:	Chris
Test Mode:	BT3.0-3DH5 2441MHz		
Remark:	POE Power		

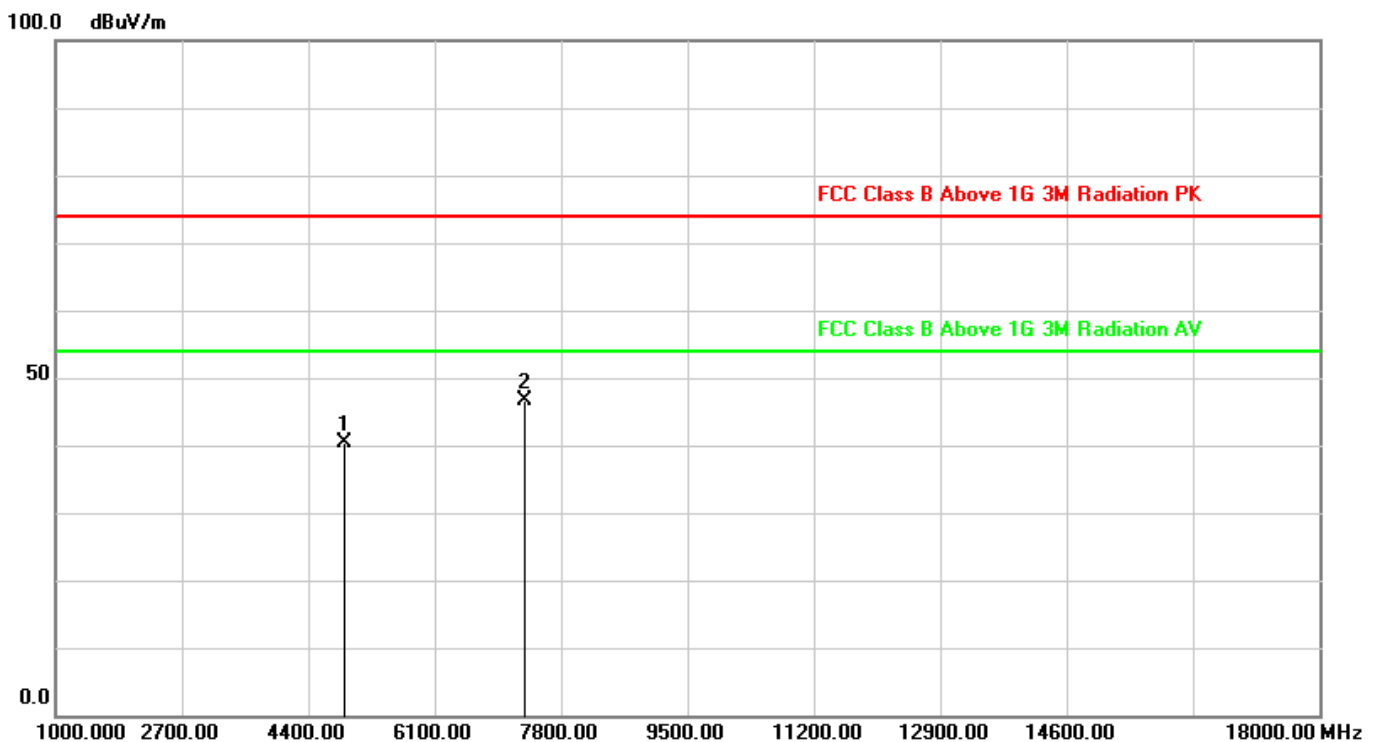

No.	Frequency (MHz)	Factor (dB/m)	Reading (dBuV)	Level (dBuV/m)	Limit (dBuV/m)	Margin (dB)	Det.
1	4882.000	3.44	36.88	40.32	74.00	-33.68	peak
2	7323.000	8.28	38.44	46.72	74.00	-27.28	peak

Note: 1. All Readings below 1GHz are Quasi-Peak, above are performed with peak and/or AVG measurements as necessary.

2. Measurement Level = Reading Level + Correct Factor.

3. The test trace is same as the ambient noise (the test frequency range: 9kHz~30MHz, 18GHz~40GHz), therefore no data appear in the report.

4. This limit applies for using average detector, if the test result on peak is lower than average limit, then average measurement needn't be performed.



Test Distance:	3M		
Test Standard:	FCC Class B Above 1G 3M	Ant. Polarization:	Vertical
	Radiation PK		
Test item:	Radiation Emission	Test Time:	2019-8-619:33:26
Applicant:	Mitac Digital Technology Company	Power Rating:	AC 120V/60Hz
Product:	Tablet	Temp.(C)/Hum.(%)/Air p.(hpa):	26(°C)/60%/983hpa
Model No.:	N642	Test Engineer:	Chris
Test Mode:	BT3.0-3DH5 2441MHz		
Remark:	POE Power		

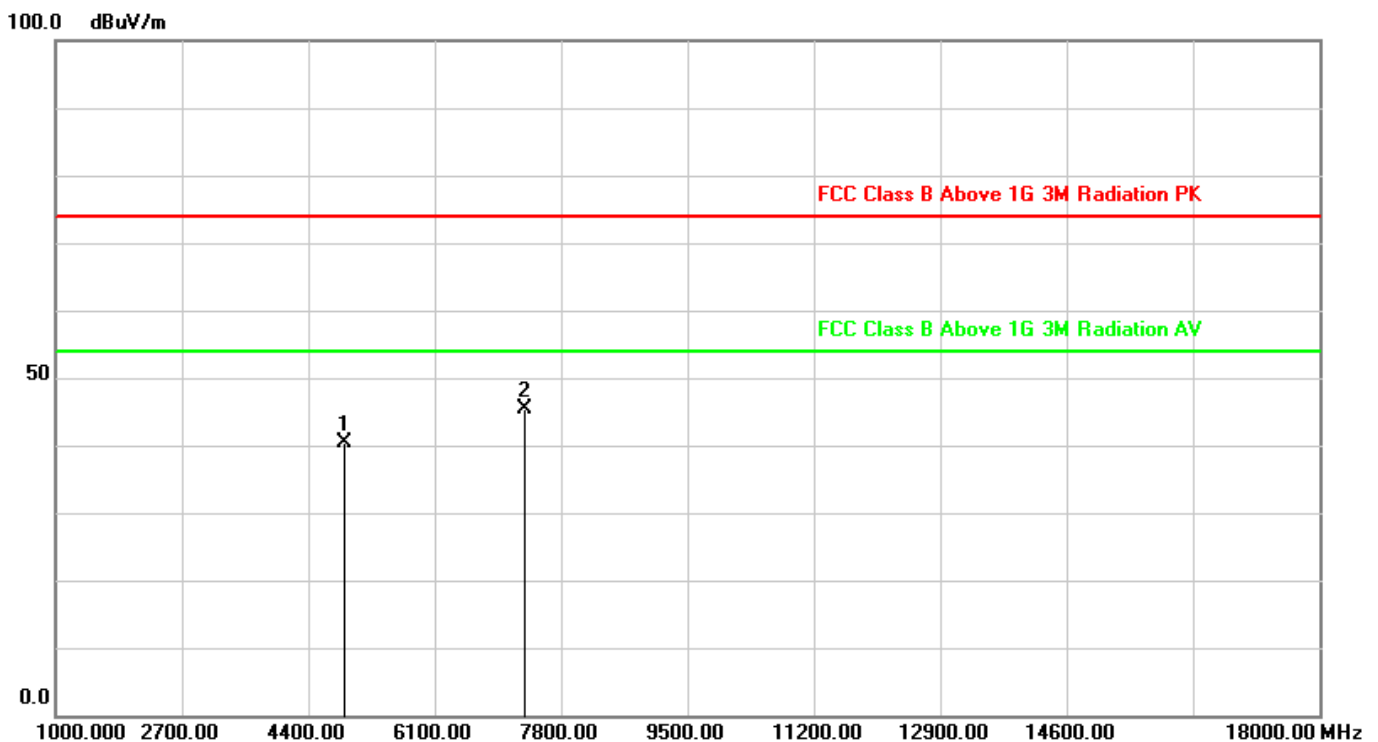

No.	Frequency (MHz)	Factor (dB/m)	Reading (dBuV)	Level (dBuV/m)	Limit (dBuV/m)	Margin (dB)	Det.
1	4882.000	3.44	36.92	40.36	74.00	-33.64	peak
2	7323.000	8.28	37.01	45.29	74.00	-28.71	peak

Note: 1. All Readings below 1GHz are Quasi-Peak, above are performed with peak and/or AVG measurements as necessary.

2. Measurement Level = Reading Level + Correct Factor.

3. The test trace is same as the ambient noise (the test frequency range: 9kHz~30MHz, 18GHz~40GHz), therefore no data appear in the report.

4. This limit applies for using average detector, if the test result on peak is lower than average limit, then average measurement needn't be performed.



Test Distance:	3M		
Test Standard:	FCC Class B Above 1G 3M	Ant. Polarization:	Horizontal
	Radiation PK		
Test item:	Radiation Emission	Test Time:	2019-8-619:42:16
Applicant:	Mitac Digital Technology Company	Power Rating:	AC 120V/60Hz
Product:	Tablet	Temp.(C)/Hum.(/Air p.(hpa):	26(°C)/60%/983hpa
Model No.:	N642	Test Engineer:	Chris
Test Mode:	BT3.0-3DH5 2480MHz		
Remark:	POE Power		

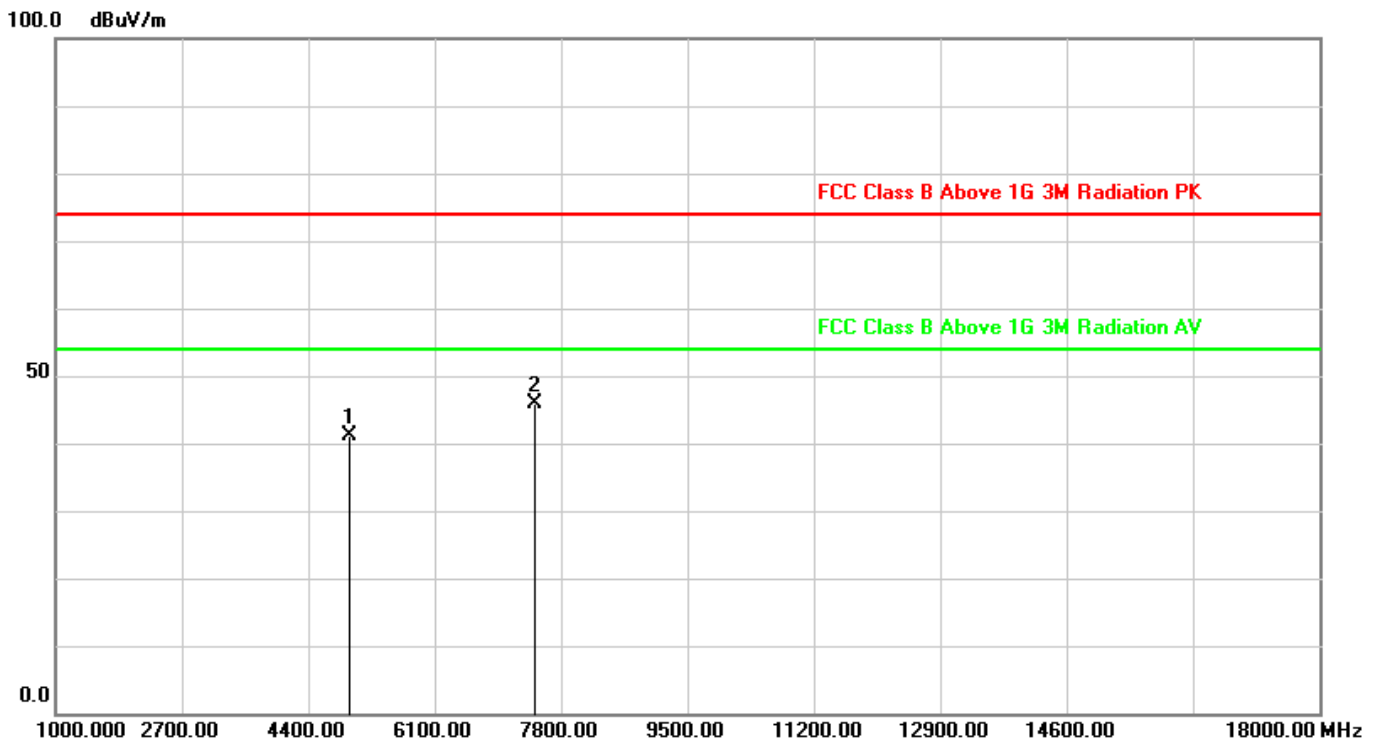

No.	Frequency (MHz)	Factor (dB/m)	Reading (dBuV)	Level (dBuV/m)	Limit (dBuV/m)	Margin (dB)	Det.
1	4960.000	3.59	37.51	41.10	74.00	-32.90	peak
2	7440.000	8.36	37.47	45.83	74.00	-28.17	peak

Note: 1. All Readings below 1GHz are Quasi-Peak, above are performed with peak and/or AVG measurements as necessary.

2. Measurement Level = Reading Level + Correct Factor.

3. The test trace is same as the ambient noise (the test frequency range: 9kHz~30MHz, 18GHz~40GHz), therefore no data appear in the report.

4. This limit applies for using average detector, if the test result on peak is lower than average limit, then average measurement needn't be performed.



Test Distance:	3M		
Test Standard:	FCC Class B Above 1G 3M	Ant. Polarization:	Vertical
	Radiation PK		
Test item:	Radiation Emission	Test Time:	2019-8-619:44:15
Applicant:	Mitac Digital Technology Company	Power Rating:	AC 120V/60Hz
Product:	Tablet	Temp.(C)/Hum.(%)/Air p.(hpa):	26(°C)/60%/983hpa
Model No.:	N642	Test Engineer:	Chris
Test Mode:	BT3.0-3DH5 2480MHz		
Remark:	POE Power		

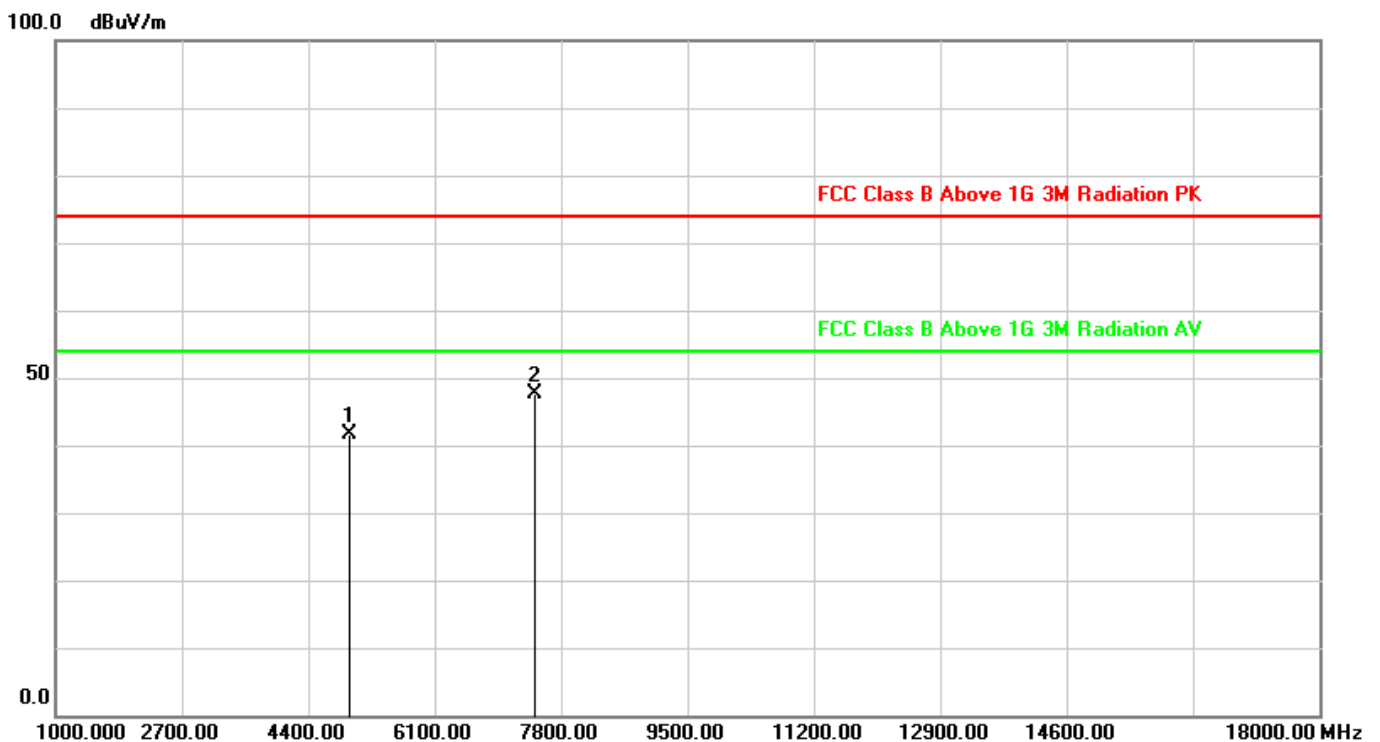

No.	Frequency (MHz)	Factor (dB/m)	Reading (dBuV)	Level (dBuV/m)	Limit (dBuV/m)	Margin (dB)	Det.
1	4960.000	3.59	37.98	41.57	74.00	-32.43	peak
2	7440.000	8.36	39.19	47.55	74.00	-26.45	peak

Note: 1. All Readings below 1GHz are Quasi-Peak, above are performed with peak and/or AVG measurements as necessary.

2. Measurement Level = Reading Level + Correct Factor.

3. The test trace is same as the ambient noise (the test frequency range: 9kHz~30MHz, 18GHz~40GHz), therefore no data appear in the report.

4. This limit applies for using average detector, if the test result on peak is lower than average limit, then average measurement needn't be performed.



5. 20dB Bandwidth Measurement

5.1 Test Limit

Frequency hopping systems shall have hopping channel carrier frequencies separated by a minimum of 25 kHz or the 20 dB bandwidth of the hopping channel, whichever is greater. Alternatively, frequency hopping systems operating in the 2400–2483.5 MHz band may have hopping channel carrier frequencies that are separated by 25 kHz or two-thirds of the 20 dB bandwidth of the hopping channel, whichever is greater, provided the systems operate with an output power no greater than 125mW.

5.2 Test Standard

ANSI C63.10-2013- Section 7.8.7

5.3 Test Setup

1. Set RBW \geq 1% of the 20dB bandwidth
2. VBW \geq 3 \times RBW
3. Span = approximately 2 to 3 times the 20dB bandwidth, centered on a hopping channel
4. Detector = Peak
5. Trace mode = max hold
6. Sweep = auto couple
7. Allow the trace to stabilize
8. Measure the maximum width of the emission that is constrained by the frequencies associated with the two outermost amplitude points (upper and lower frequencies) that are attenuated by 20dB relative to the maximum level measured in the fundamental emission

5.4 Test Setup Layout

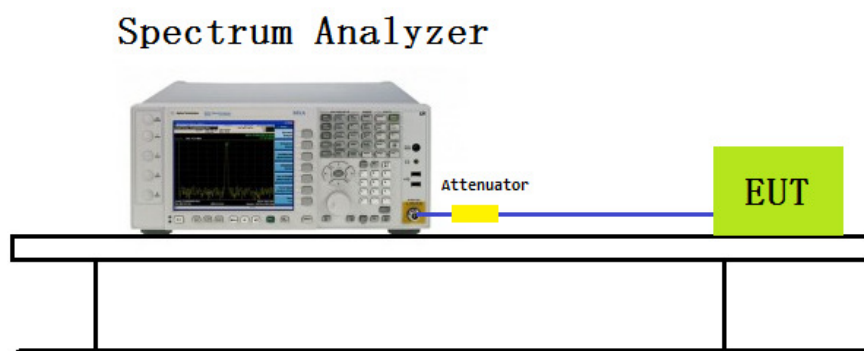



5.5 Test Result

Test Item	20dB Bandwidth Measurement
Test Engineer:	Chris
Test Date	2019-07-26
Test Mode	Transmitting by DH5

Channel No.	Frequency (MHz)	20dB Occupied Bandwidth (kHz)
00	2402	960.58
39	2441	958.19
78	2480	967.53





Test Item	20dB Bandwidth Measurement
Test Engineer:	Chris
Test Date	2019-07-26
Test Mode	Transmitting by 2DH5

Channel No.	Frequency (MHz)	20dB Occupied Bandwidth (kHz)
00	2402	1298
39	2441	1296
78	2480	1301

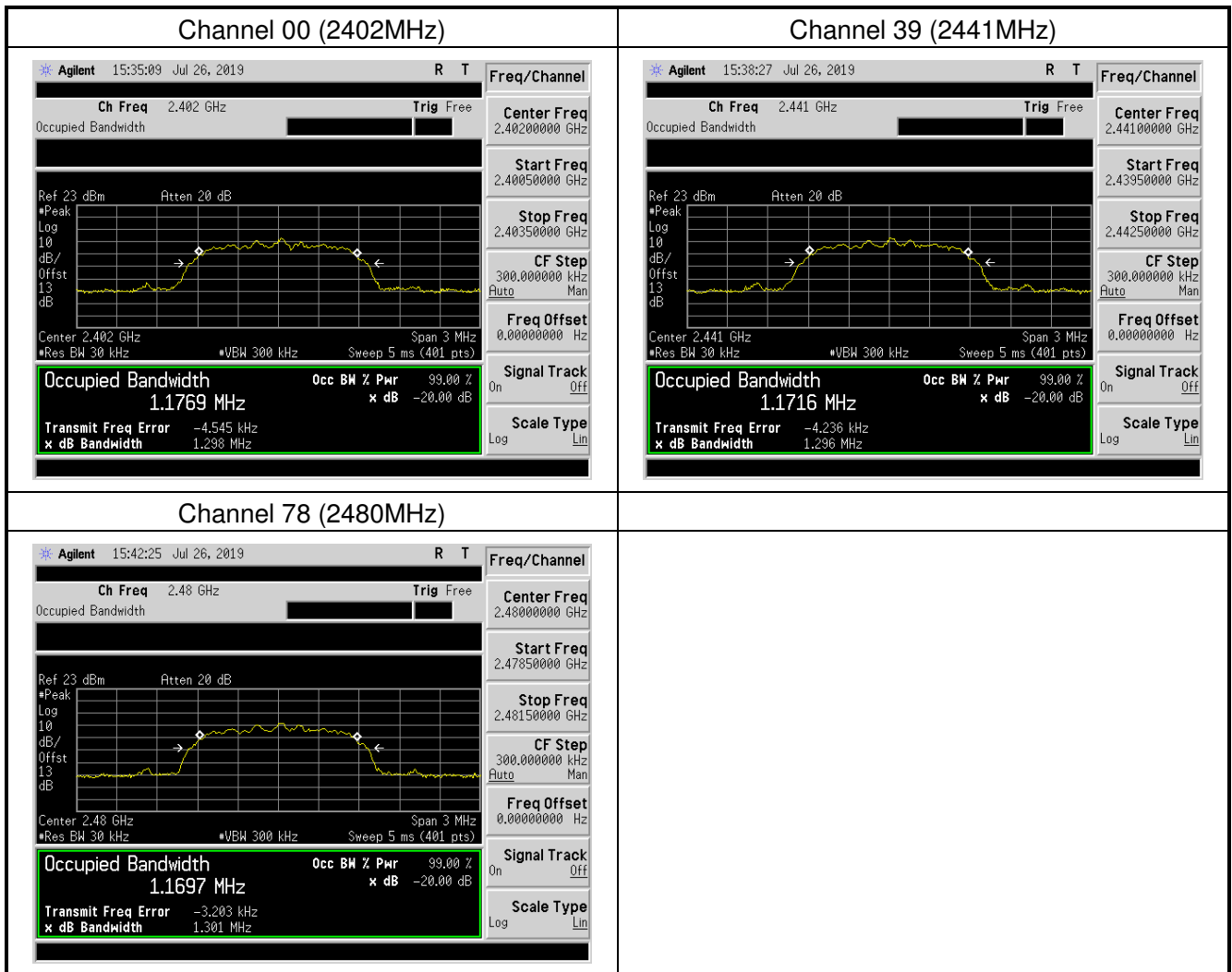



Test Item	20dB Bandwidth Measurement
Test Engineer:	Chris
Test Date	2019-07-26
Test Mode	Transmitting by 3DH5

Channel No.	Frequency (MHz)	20dB Occupied Bandwidth (kHz)
00	2402	1305
39	2441	1310
78	2480	1308

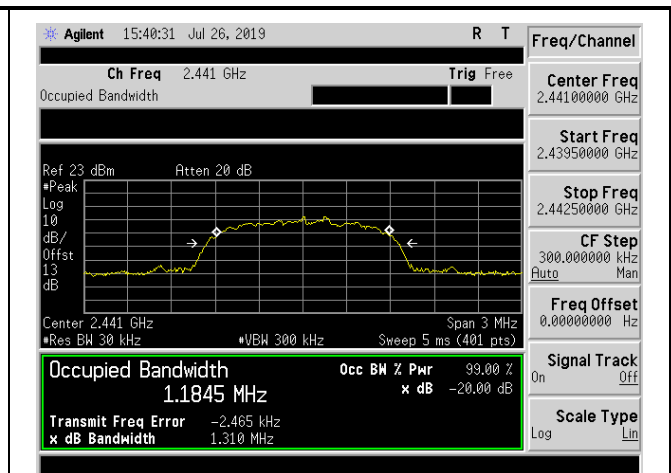
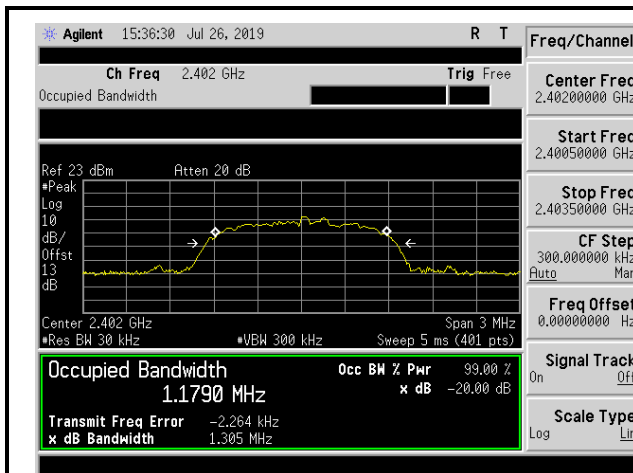

Channel 78 (2480MHz)

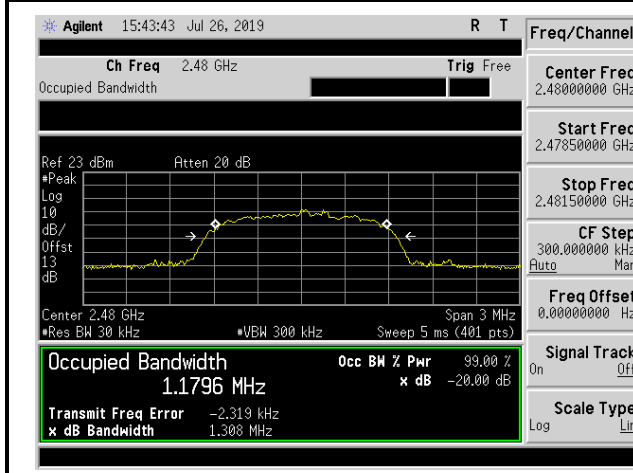



6. Channel Carrier Frequencies Separation Measurement

6.1 Test Limit

Frequency hopping systems shall have hopping channel carrier frequencies separated by a minimum of 25 kHz or the 20 dB bandwidth of the hopping channel, whichever is greater.

6.2 Test Standard

ANSI C63.10-2013- Section 7.8.2

6.3 Test Setup

The EUT shall have its hopping function enabled. Use the following spectrum analyzer settings:

- Span: Wide enough to capture the peaks of two adjacent channels.
- RBW: Start with the RBW set to approximately 30% of the channel spacing; adjust as necessary to best identify the center of each individual channel.
- Video (or average) bandwidth (VBW) \geq RBW
- Sweep: Auto
- Detector function: Peak
- Trace: Max hold
- Allow the trace to stabilize

Use the marker-delta function to determine the separation between the peaks of the adjacent channels. Compliance of an EUT with the appropriate regulatory limit shall be determined. A plot of the data shall be included in the test report.

6.4 Test Setup Layout

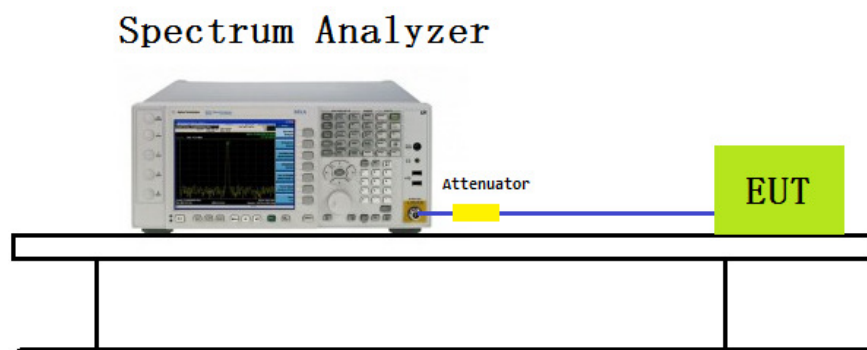



6.5 Test Result

Test Item	Channel Carrier Frequencies Separation Measurement
Test Engineer:	Chris
Test Date	2019-07-26
Test Mode	Transmitting by DH5

Channel No.	Frequency (MHz)	Carrier Frequency Separation (kHz)	Limit (kHz)	Result
40	2442	1005	>25 kHz or 2/3 of 20 dB BW	Pass

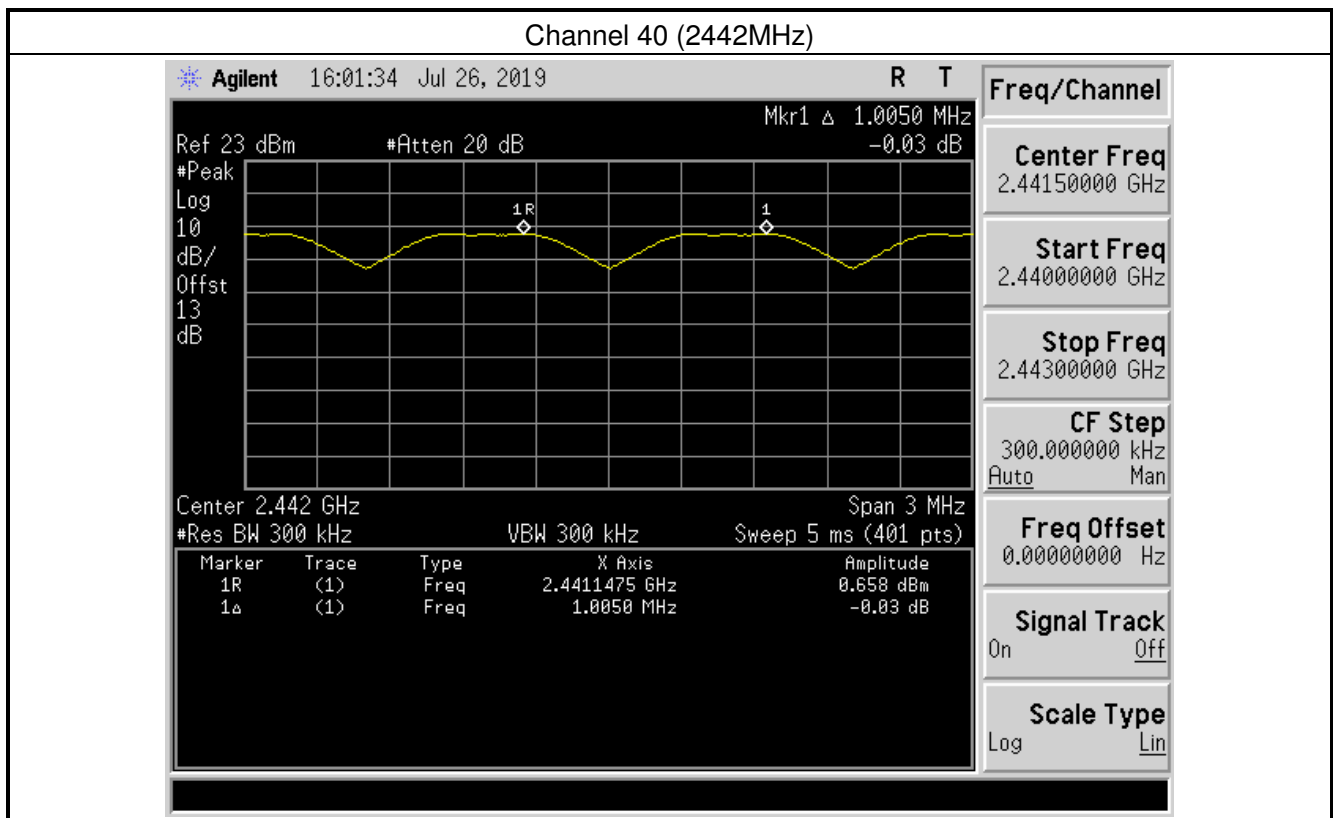



Test Item	Channel Carrier Frequencies Separation Measurement
Test Engineer:	Chris
Test Date	2019-07-26
Test Mode	Transmitting by 2DH5

Channel No.	Frequency (MHz)	Carrier Frequency Separation(kHz)	Limit (kHz)	Result
40	2442	1005	>25 kHz or 2/3 of 20 dB BW	Pass

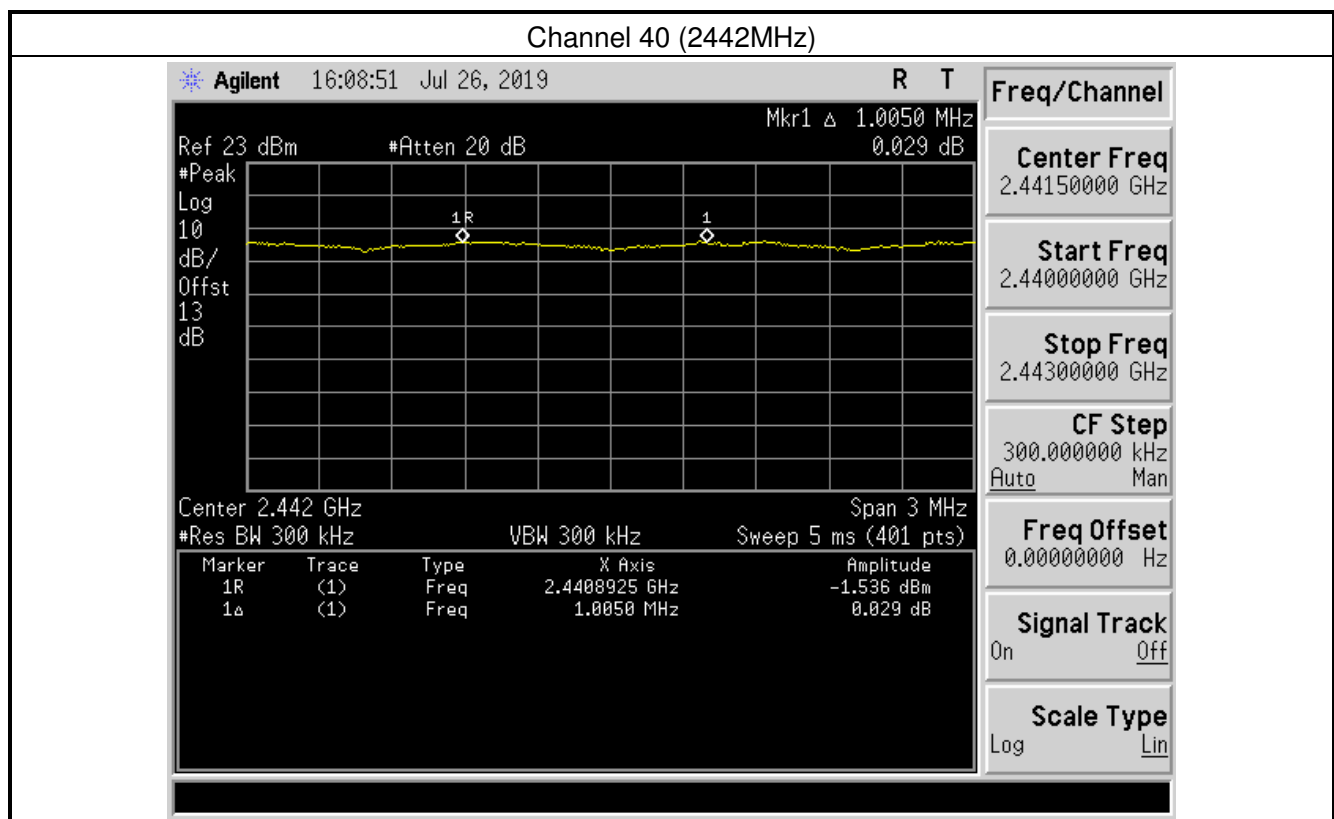



Test Item	Channel Carrier Frequencies Separation Measurement
Test Engineer:	Chris
Test Date	2019-07-26
Test Mode	Transmitting by 3DH5

Channel No.	Frequency (MHz)	Carrier Frequency Separation (kHz)	Limit (kHz)	Result
40	2442	1005	>25 kHz or 2/3 of 20 dB BW	Pass

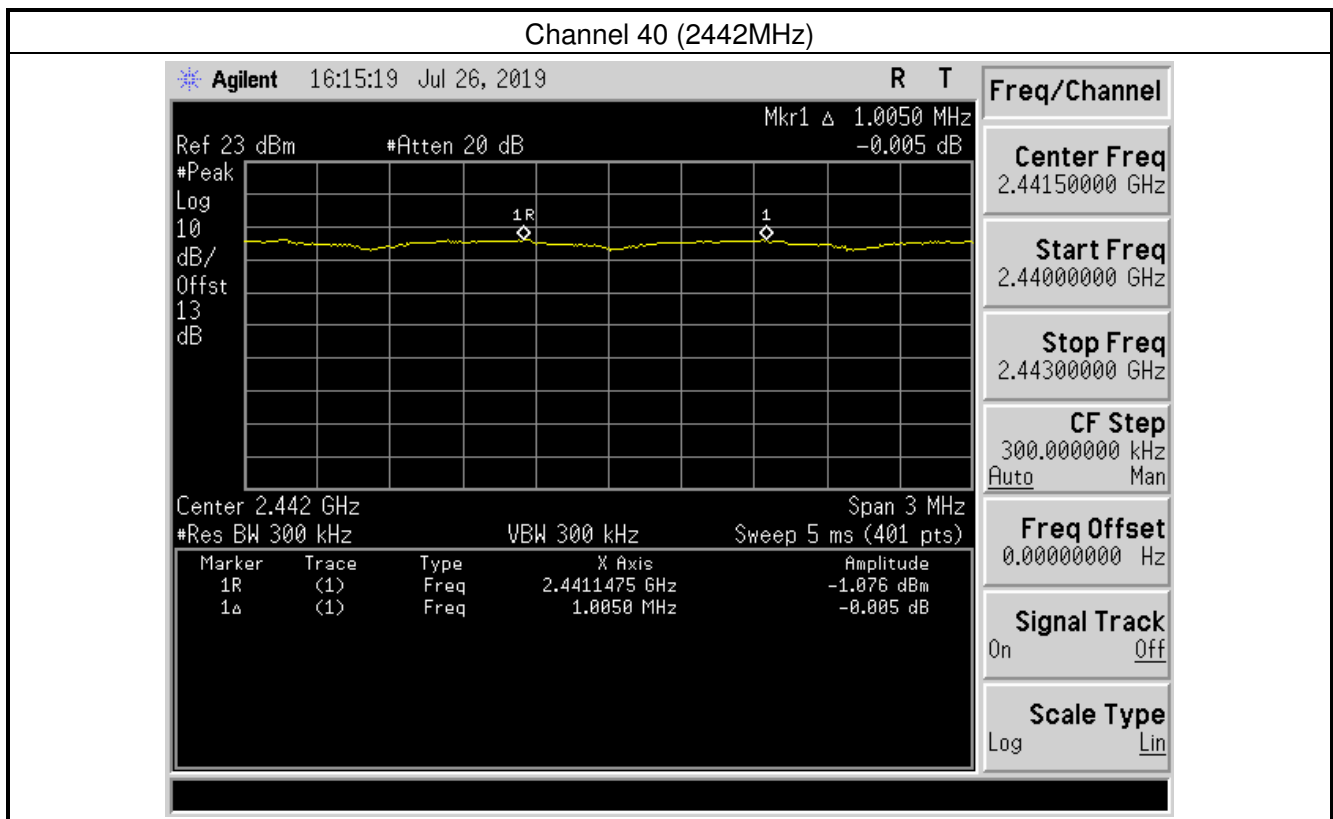



7. Dwell Time Measurement

7.1 Test Limit

The average time of occupancy on any channel shall not be greater than 0.4 seconds within a period of 0.4 seconds multiplied by the number of hopping channels employed.

7.2 Test Standard

ANSI C63.10-2013- Section 7.8.3

7.3 Test Setup

The EUT shall have its hopping function enabled. Use the following spectrum analyzer settings:

- Span: Zero span, centered on a hopping channel.
- RBW shall be \leq channel spacing and where possible RBW should be set $\gg 1 / T$, where T is the expected dwell time per channel.
- Sweep: As necessary to capture the entire dwell time per hopping channel; where possible use a video trigger and trigger delay so that the transmitted signal starts a little to the right of the start of the plot. The trigger level might need slight adjustment to prevent triggering when the system hops on an adjacent channel; a second plot might be needed with a longer sweep time to show two successive hops on a channel.
- Detector function: Peak
- Trace: Max hold

7.4 Test Setup Layout

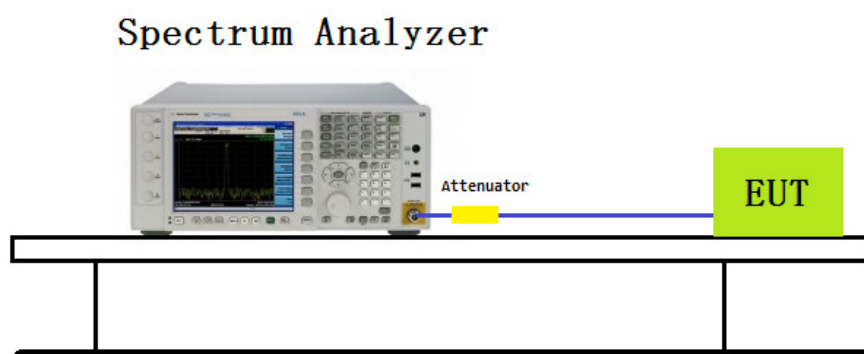



7.5 Test Result

Test Item	Dwell Time Measurement
Test Engineer:	Chris
Test Date	2019-07-26
Test Mode	Transmitting by 3DH1

Channel No.	Frequency (MHz)	Time of Occupancy (ms)	Limit (ms)	Result
39	2441	134.4	< 400	Pass

Test Time Period: $0.4 \times 79 = 31.6$ sec, Hopping Times Within 1sec: $32/40$ msec = 800 hops/sec.

2441MHz, The Maximum Occupancy Time Within 31.6sec: $[(0.42\text{ms} \times 800)/79] \times 31.6 = 134.4$ msec

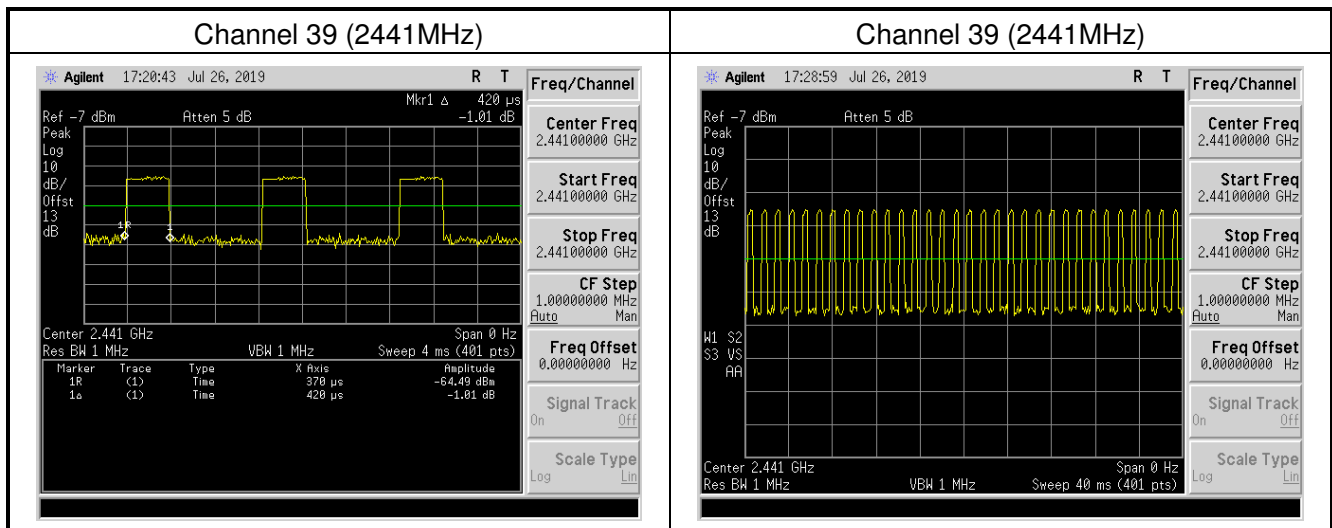



Test Item	Dwell Time Measurement
Test Engineer:	Chris
Test Date	2019-07-26
Test Mode	Transmitting by 3DH3

Channel No.	Frequency (MHz)	Time of Occupancy (ms)	Limit (ms)	Result
39	2441	268.0	< 400	Pass

Test Time Period: $0.4 \times 79 = 31.6$ sec, Hopping Times Within 1sec: $20/50$ msec= 400 hops/sec.

2441MHz, The Maximum Occupancy Time Within 31.6sec: $[(1.675\text{ms} \times 400)/79] \times 31.6 = 268.0$ msec

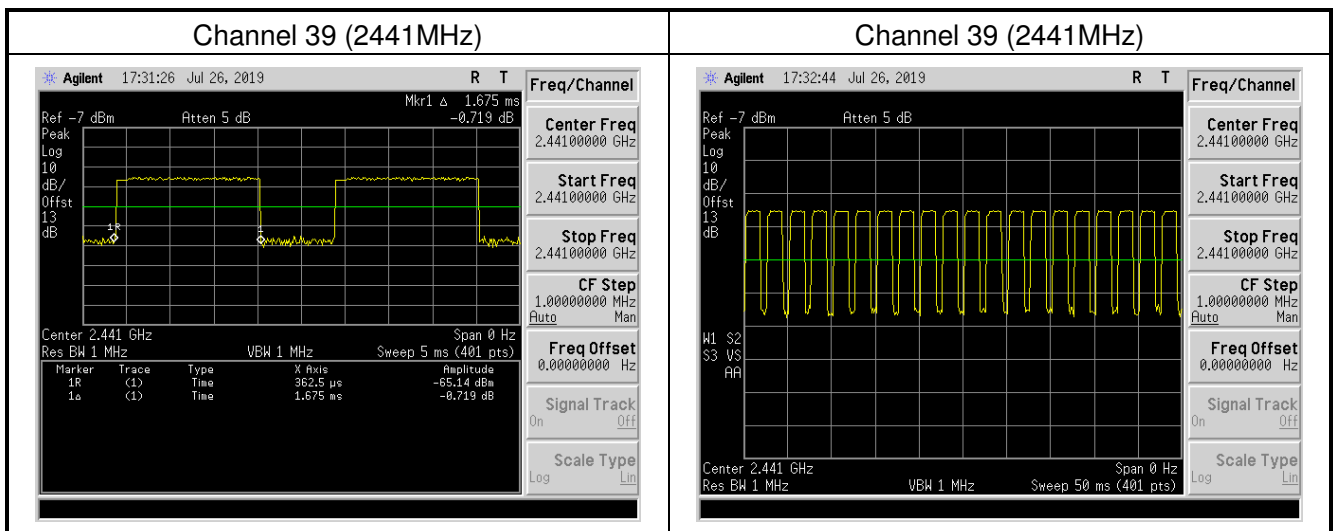



Test Item	Dwell Time Measurement
Test Engineer:	Chris
Test Date	2019-07-26
Test Mode	Transmitting by 3DH5

Channel No.	Frequency (MHz)	Time of Occupancy (ms)	Limit (ms)	Result
39	2441	308.7	< 400	Pass

Test Time Period: $0.4 \times 79 = 31.6$ sec, Hopping Times Within 1sec: $21/80$ msec= 262.5 hops/sec.

2441MHz, The Maximum Occupancy Time Within 31.6sec: $[(2.94\text{ms} \times 262.5)/79] \times 31.6 = 308.7$ msec

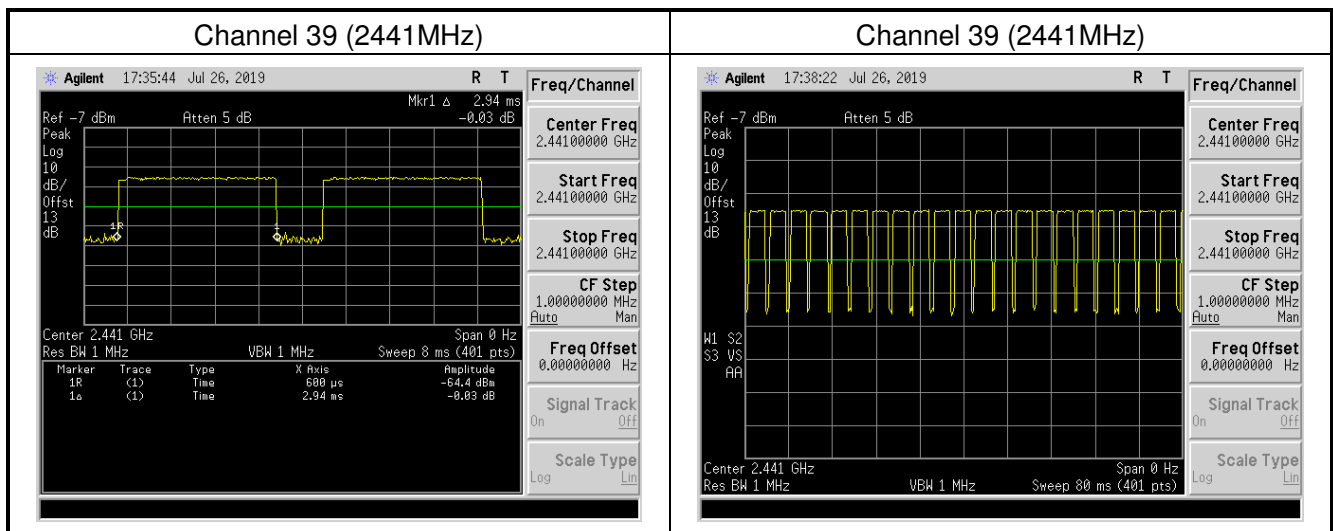



8. Number of Hopping Channels Measurement

8.1 Test Limit

Frequency hopping systems in the 2400 ~ 2483.5 MHz band shall use at least 15 channels.

8.2 Test Standard

ANSI C63.10-2013- Section 7.8.3

8.3 Test Setup

The EUT shall have its hopping function enabled. Use the following spectrum analyzer settings:

- Span: The frequency band of operation. Depending on the number of channels the device supports, it may be necessary to divide the frequency range of operation across multiple spans, to allow the individual channels to be clearly seen.
- RBW: To identify clearly the individual channels, set the RBW to less than 30% of the channel spacing or the 20 dB bandwidth, whichever is smaller.
- VBW \geq RBW
- Sweep: Auto
- Detector function: Peak
- Trace: Max hold
- Allow the trace to stabilize

8.4 Test Setup Layout

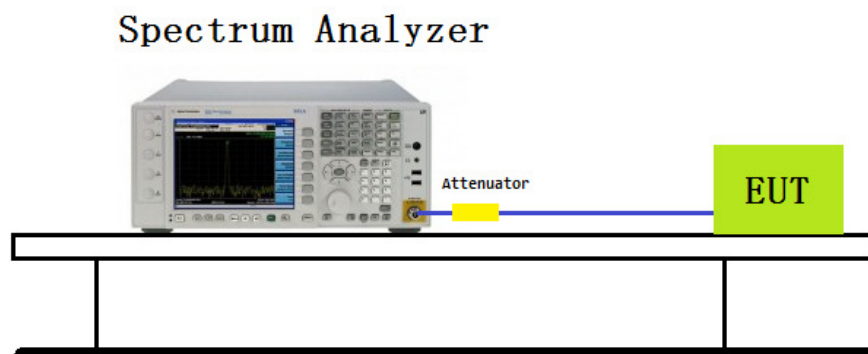



8.5 Test Result

Test Item	Number of Hopping Channels Measurement
Test Engineer:	Chris
Test Date	2019-07-26
Test Mode	Transmitting by DH5

Frequency Band (MHz)	Number of Hopping Frequencies	Limit	Result
2400 - 2483.5	79	>15	Pass

2402 - 2480 MHz

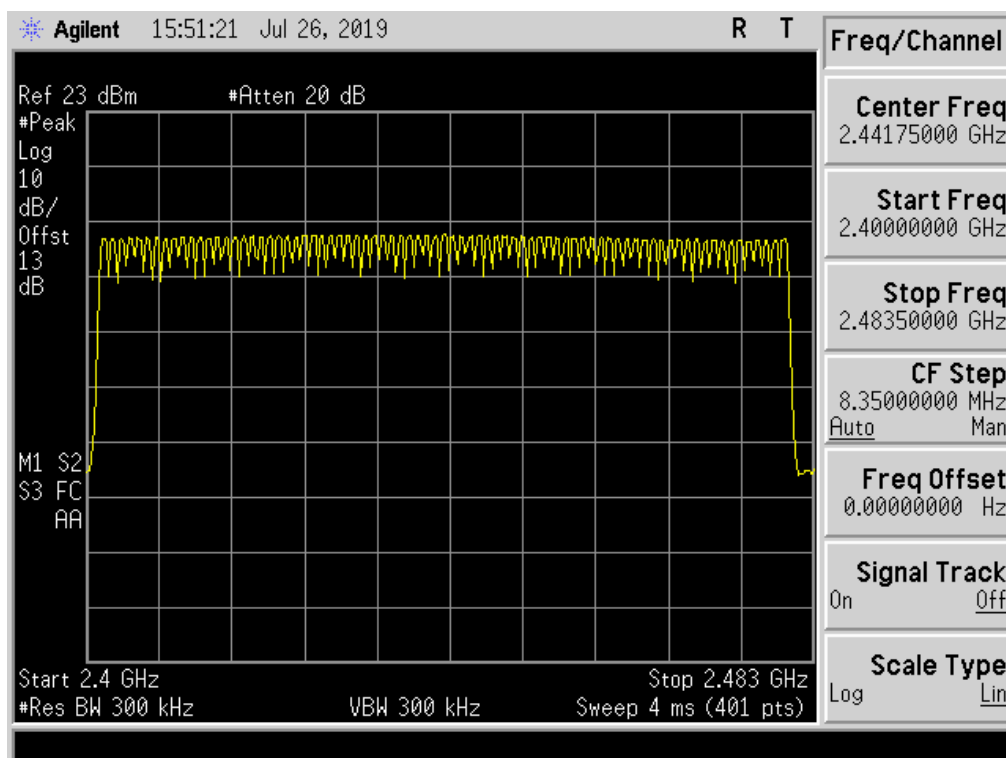



Test Item	Number of Hopping Channels Measurement
Test Engineer:	Chris
Test Date	2019-07-26
Test Mode	Transmitting by 2DH5

Frequency Band (MHz)	Number of Hopping Frequencies	Limit	Result
2400 - 2483.5	79	>15	Pass

2402 - 2480 MHz

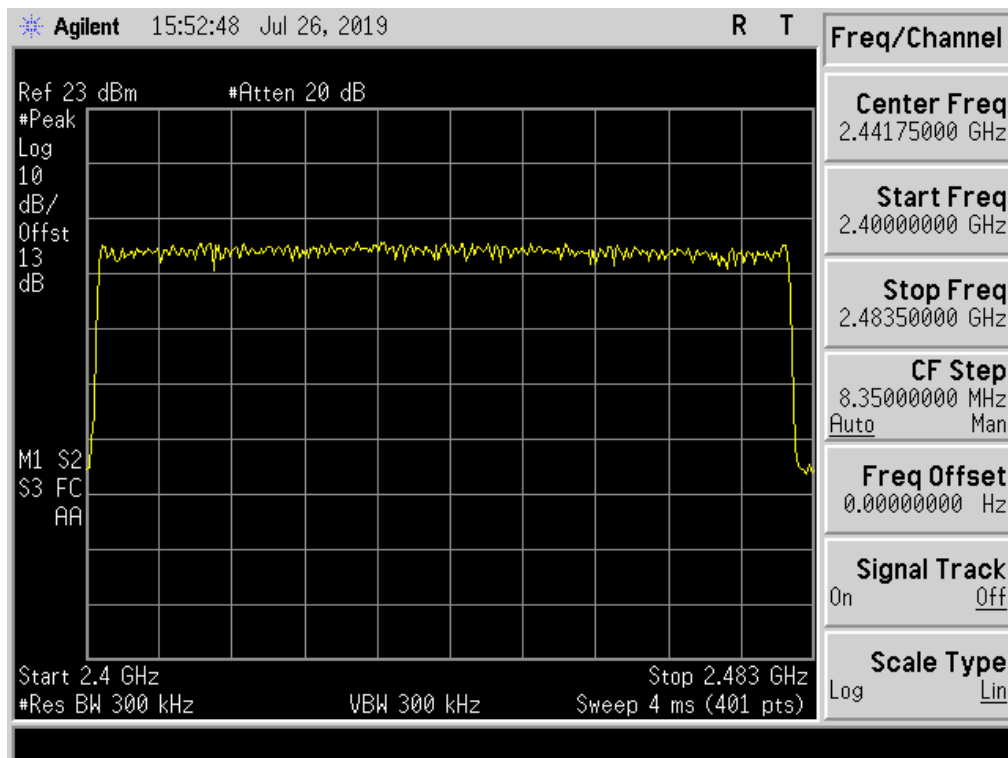



Test Item	Number of Hopping Channels Measurement
Test Engineer:	Chris
Test Date	2019-07-26
Test Mode	Transmitting by 3DH5

Frequency Band (MHz)	Number of Hopping Frequencies	Limit	Result
2400 - 2483.5	79	>15	Pass

2402 - 2480 MHz

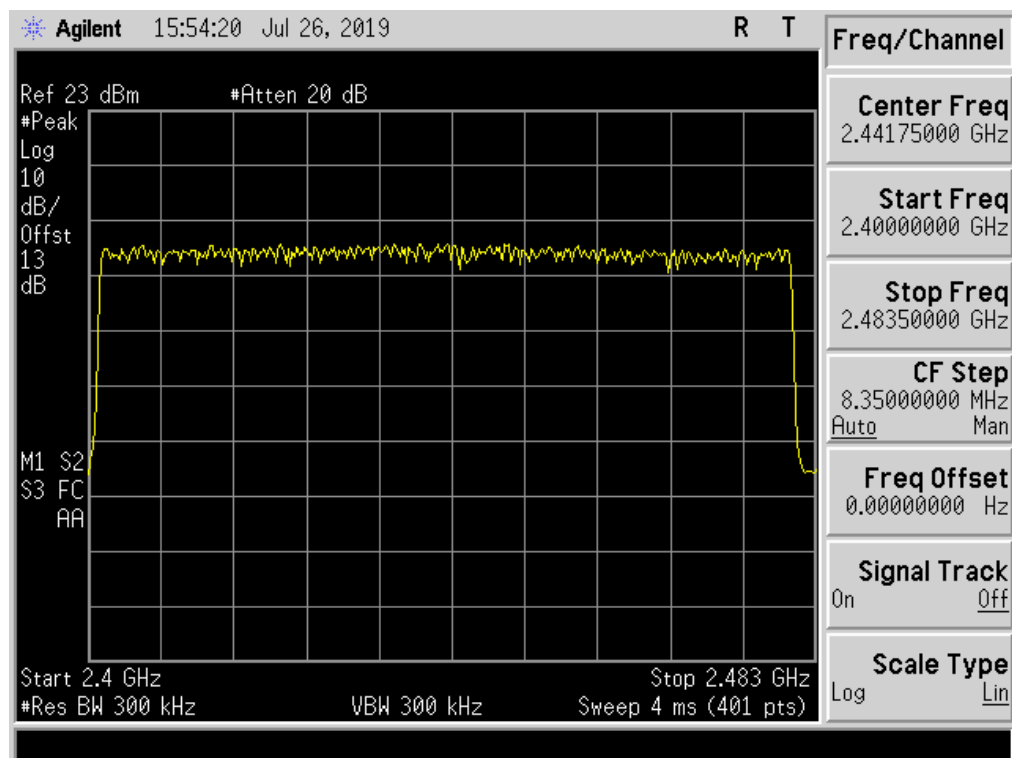



9. Peak Output Power Measurement

9.1 Test Limit

The Maximum Peak Output Power Measurement is 125mW (20.97dBm).

9.2 Test Standard

ANSI C63.10-2013- Section 7.8.5

9.3 Test Setup

Spectrum analyzer method

a) Use the following spectrum analyzer settings:

1) Span: Approximately five times the 20 dB bandwidth, centered on a hopping channel.

2) RBW > 20 dB bandwidth of the emission being measured.

3) VBW \geq RBW.

4) Sweep: Auto.

5) Detector function: Peak.

6) Trace: Max hold.

b) Allow trace to stabilize.

c) Use the marker-to-peak function to set the marker to the peak of the emission.

d) The indicated level is the peak output power, after any corrections for external attenuators and cables.

e) A plot of the test results and setup description shall be included in the test report

Peak power meter method

The antenna port (RF output) of the EUT was connected to the input (RF input) of a power meter. Power was read directly from the meter and cable loss connection was added to the reading to obtain power at the EUT antenna terminal. The EUT Output Power was set to maximum to produce the worse case test result.

9.4 Test Setup Layout

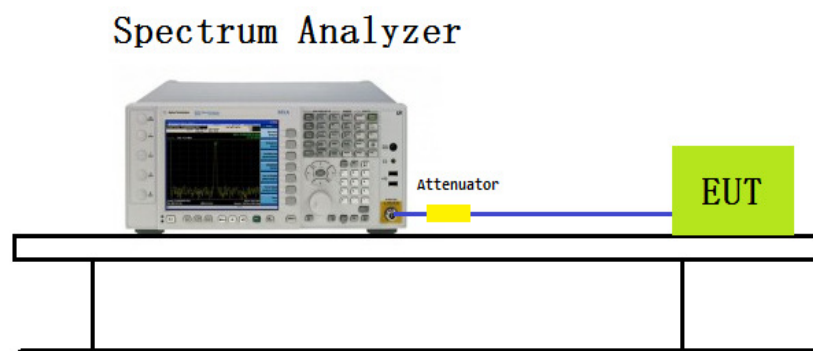



9.5 Test Result

Test Item	Peak Output Power Measurement
Test Engineer:	Chris
Test Date	2019-07-27
Test Mode	Transmitting by DH5

Hopping Channel	Frequency (MHz)	Measurement Power Output (dBm)	Limit (dBm)	Result
Worst	2439	0.600	20.97	Pass
Low	2402	0.020	20.97	Pass
Middle	2441	0.588	20.97	Pass
High	2480	-0.224	20.97	Pass

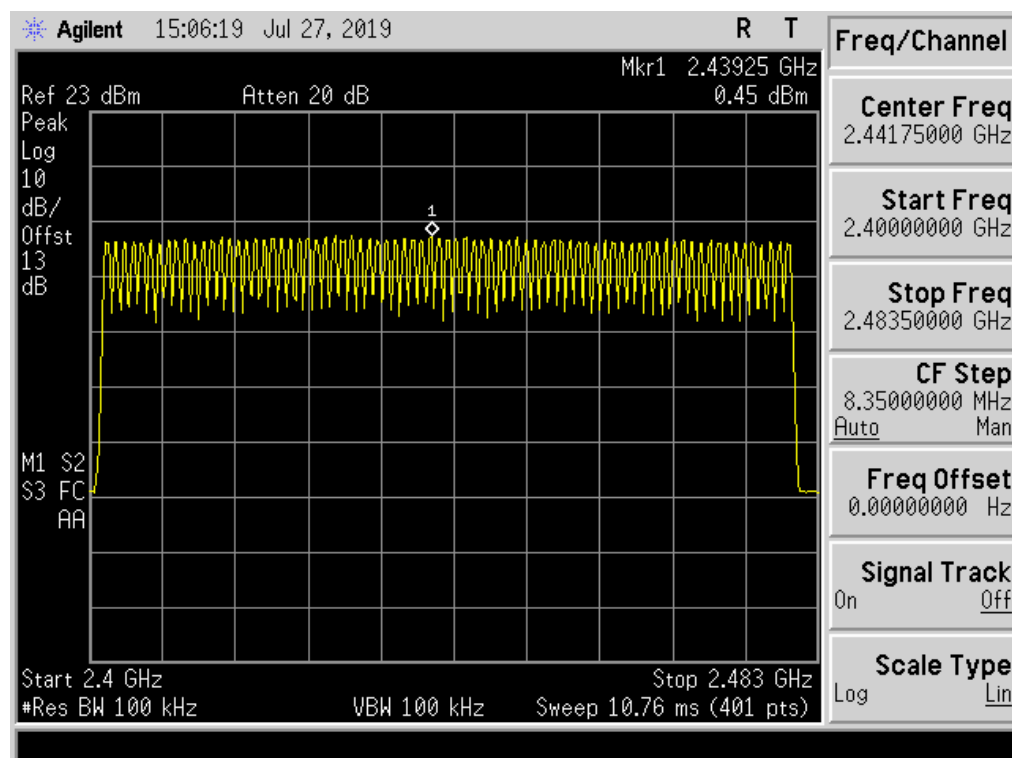

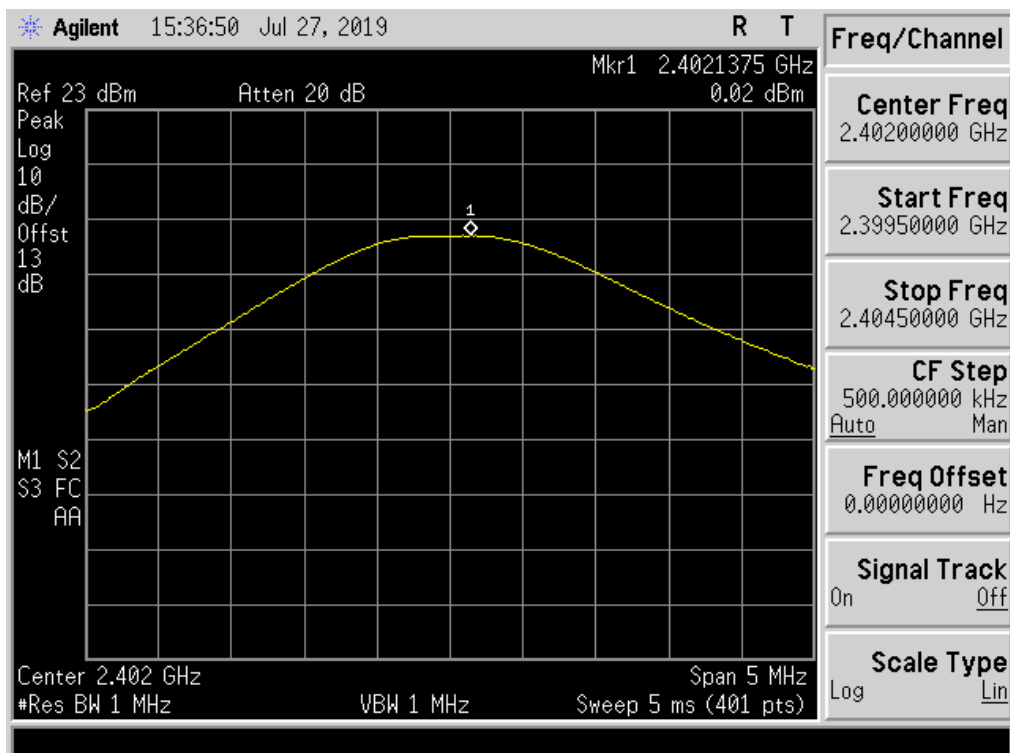
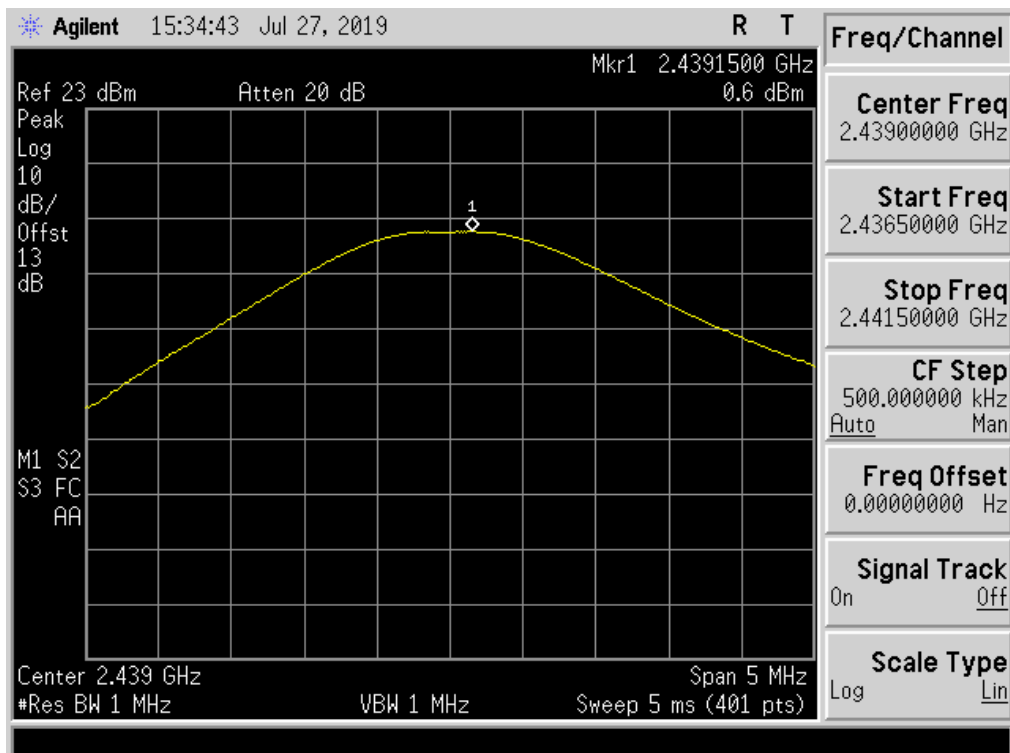

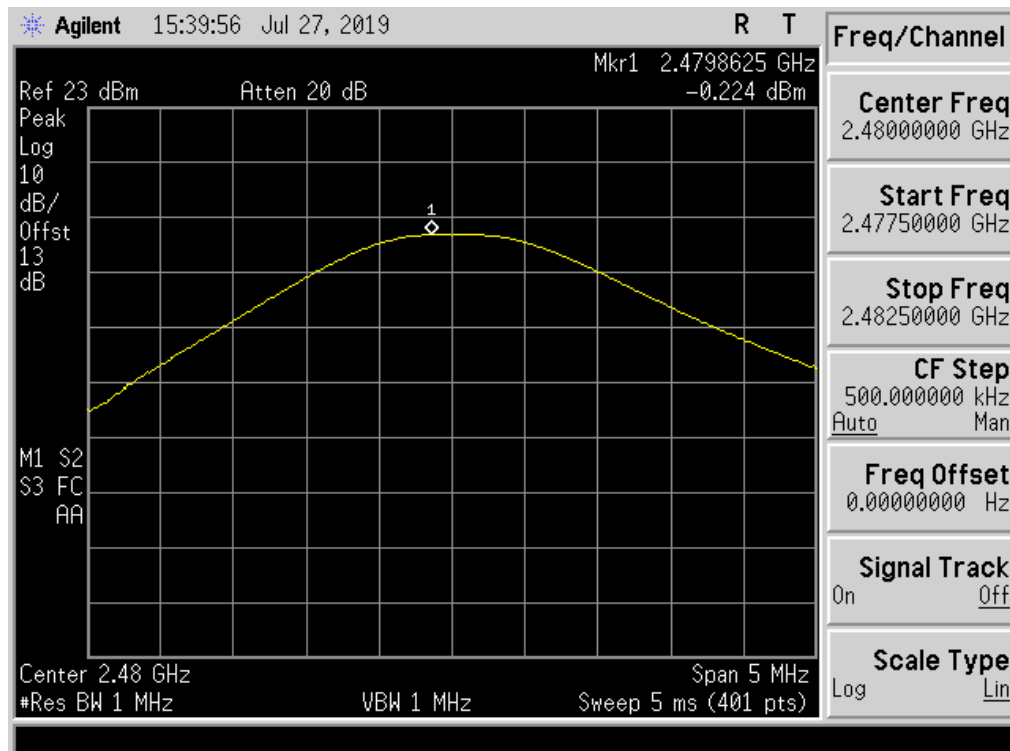
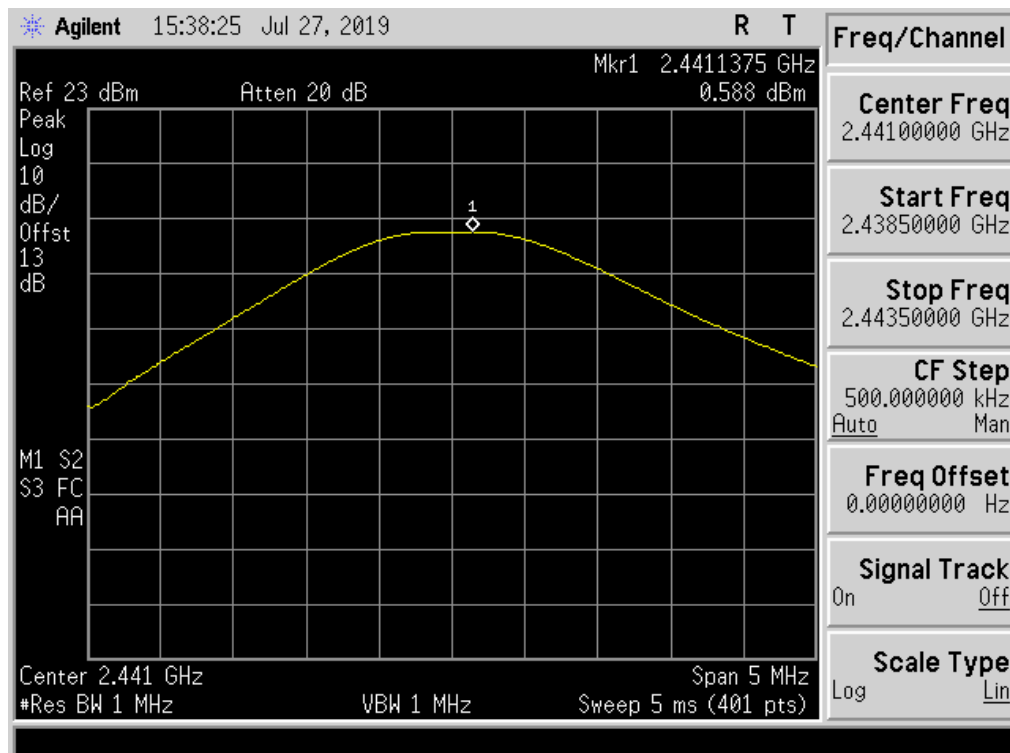



Test Item	Peak Output Power Measurement
Test Engineer:	Chris
Test Date	2019-07-27
Test Mode	Transmitting by 2DH5

Hopping Channel	Frequency (MHz)	Measurement Power Output (dBm)	Limit (dBm)	Result
Worst	2441	0.690	20.97	Pass
Low	2402	0.118	20.97	Pass
Middle	2441	0.690	20.97	Pass
High	2480	-0.093	20.97	Pass

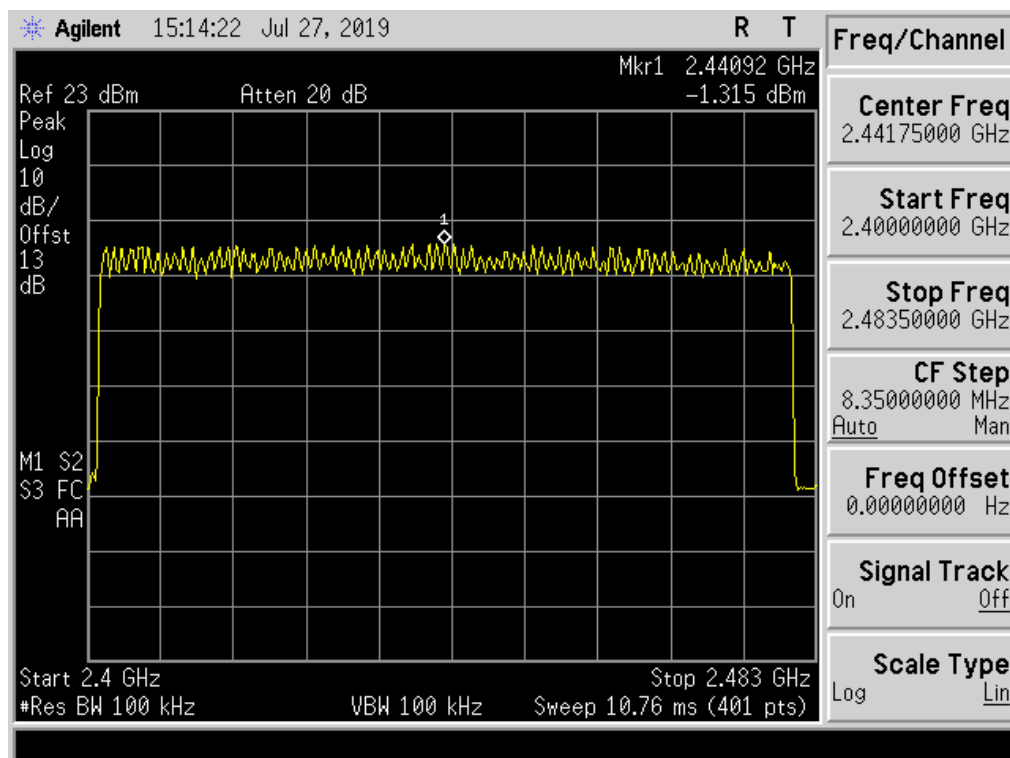

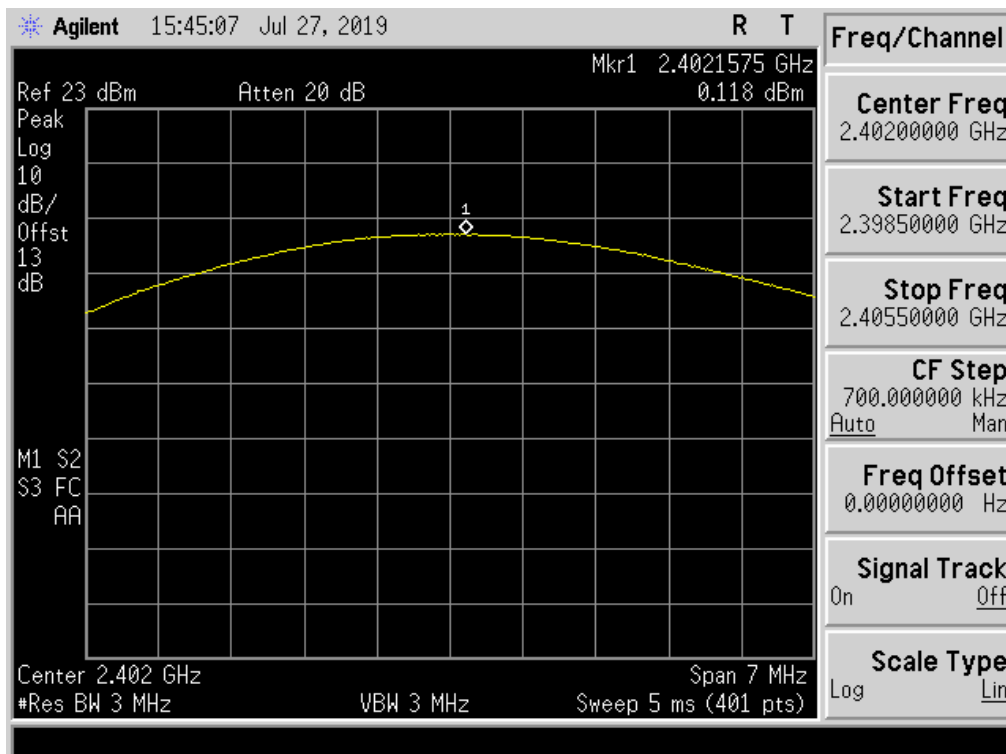
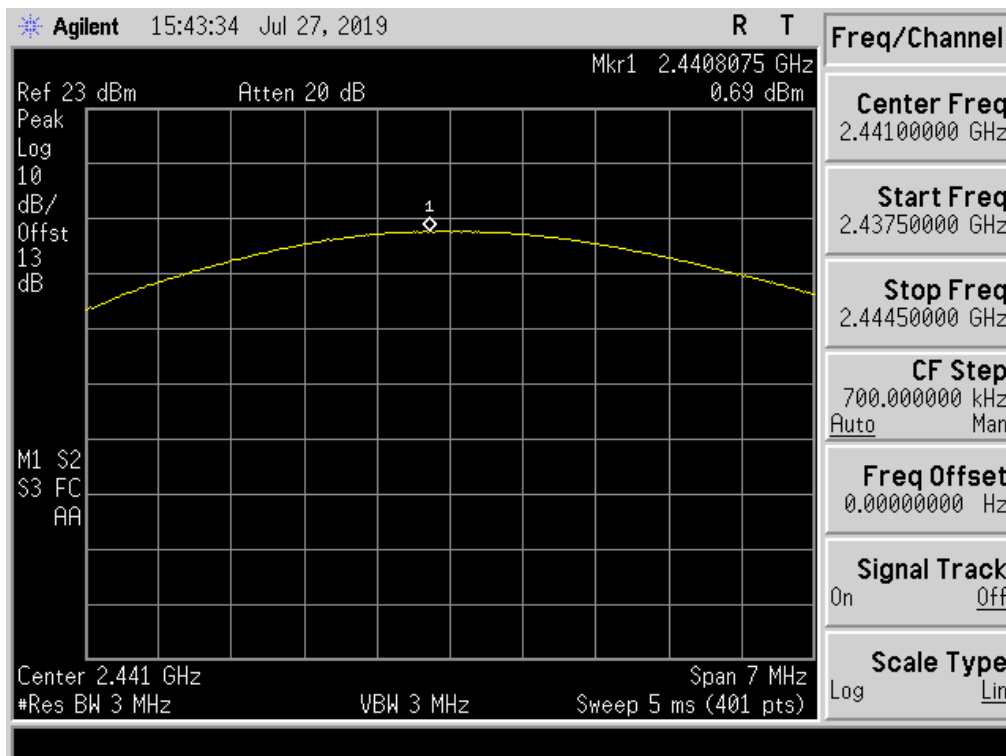

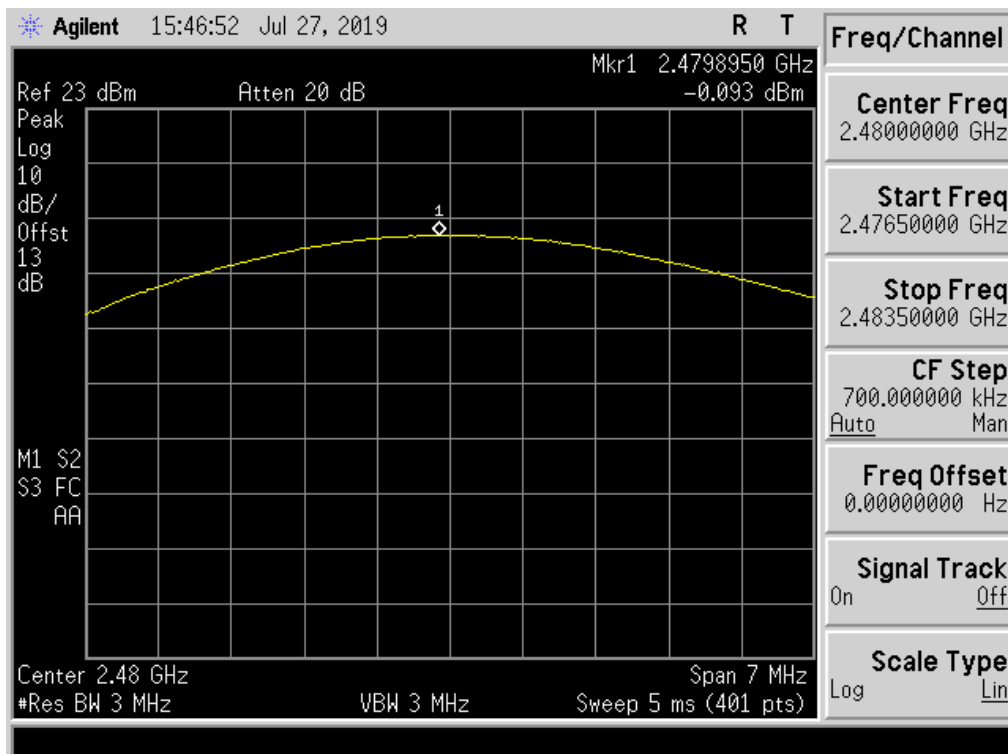
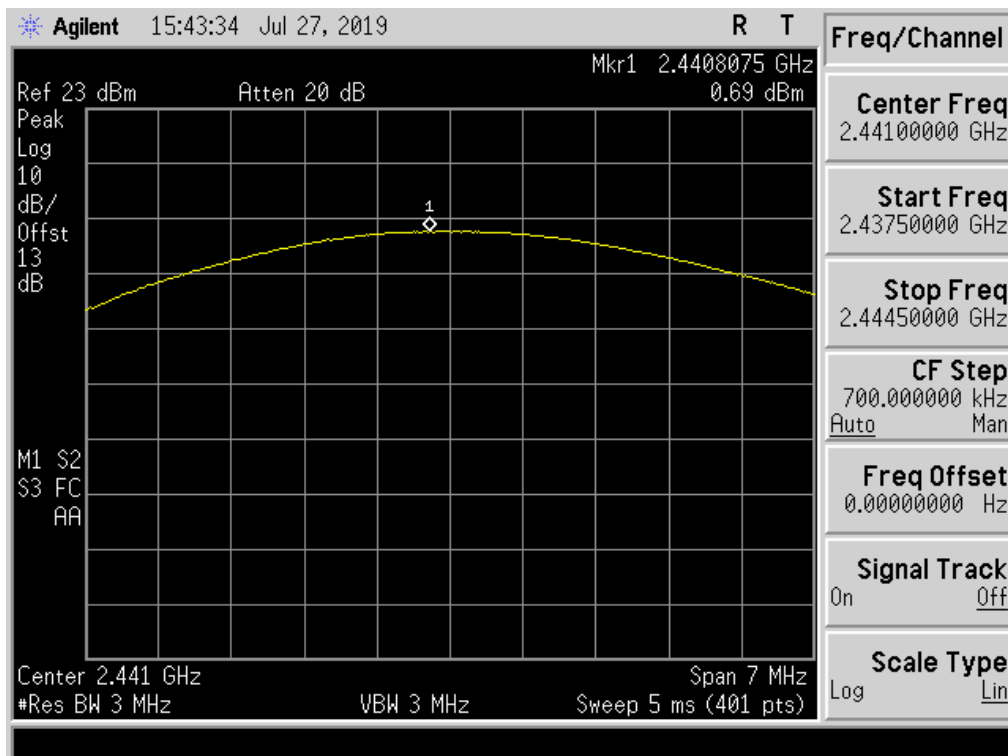



Test Item	Peak Output Power Measurement
Test Engineer:	Chris
Test Date	2019-07-27
Test Mode	Transmitting by 3DH5

Hopping Channel	Frequency (MHz)	Measurement Power Output (dBm)	Limit (dBm)	Result
Worst	2441	1.425	20.97	Pass
Low	2402	0.429	20.97	Pass
Middle	2441	1.425	20.97	Pass
High	2480	0.299	20.97	Pass

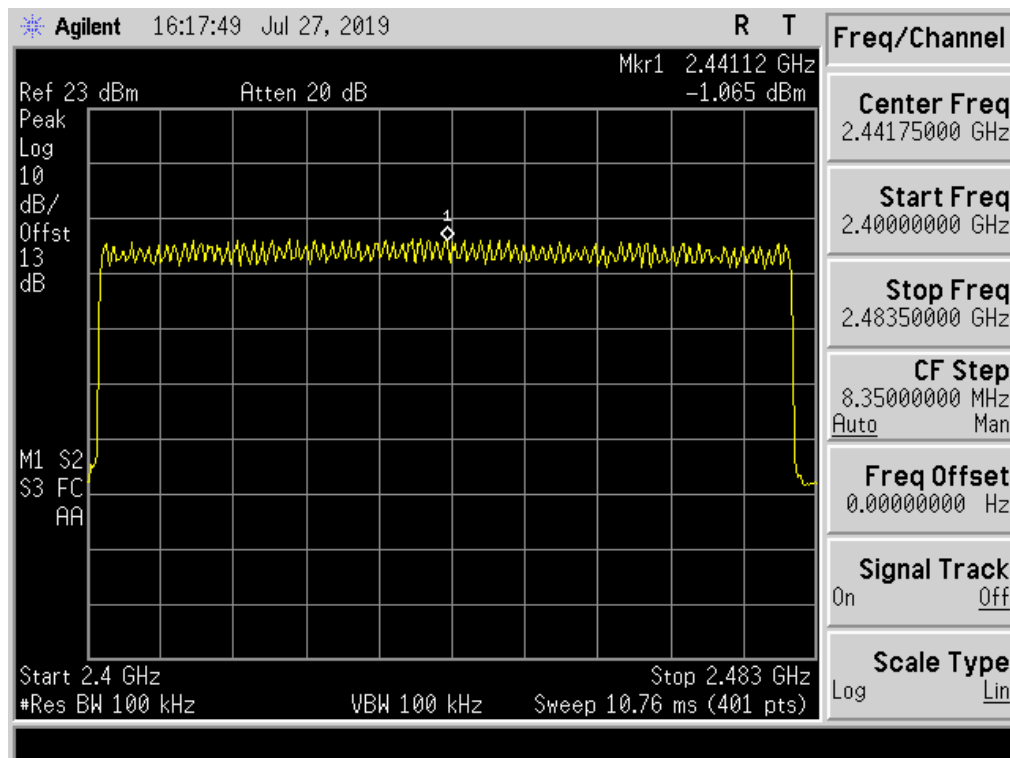

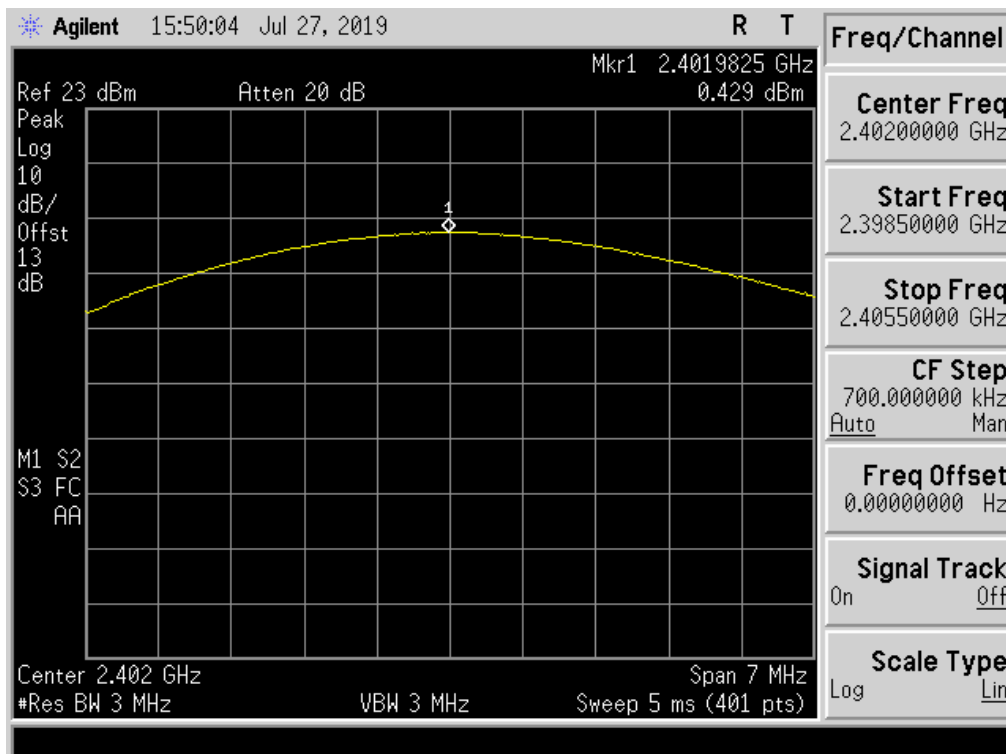
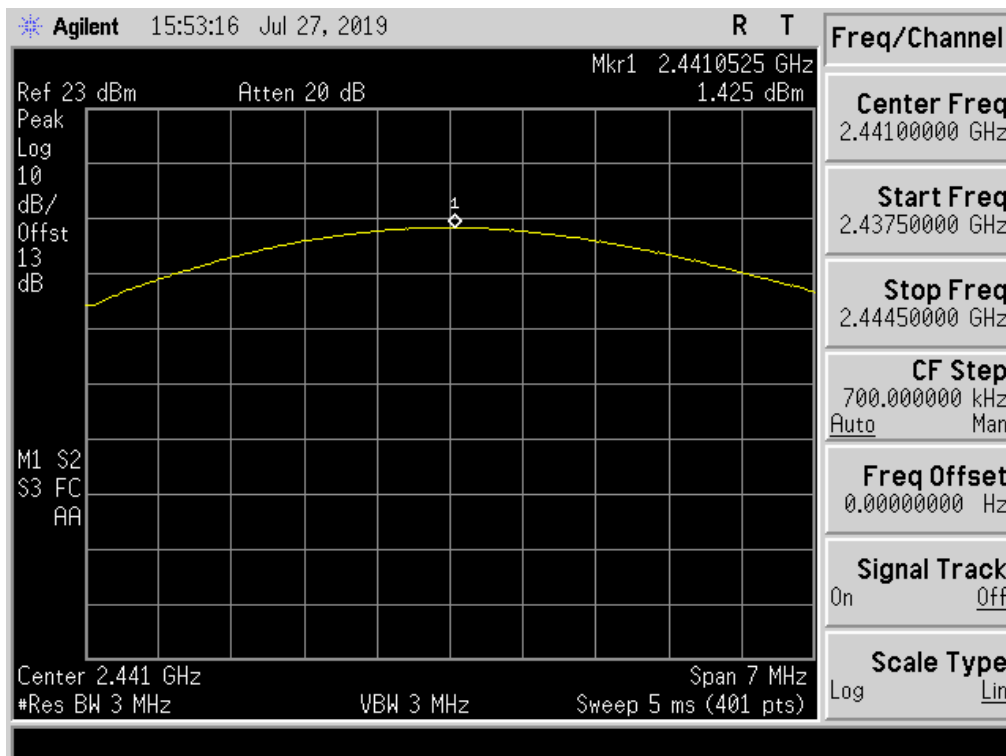

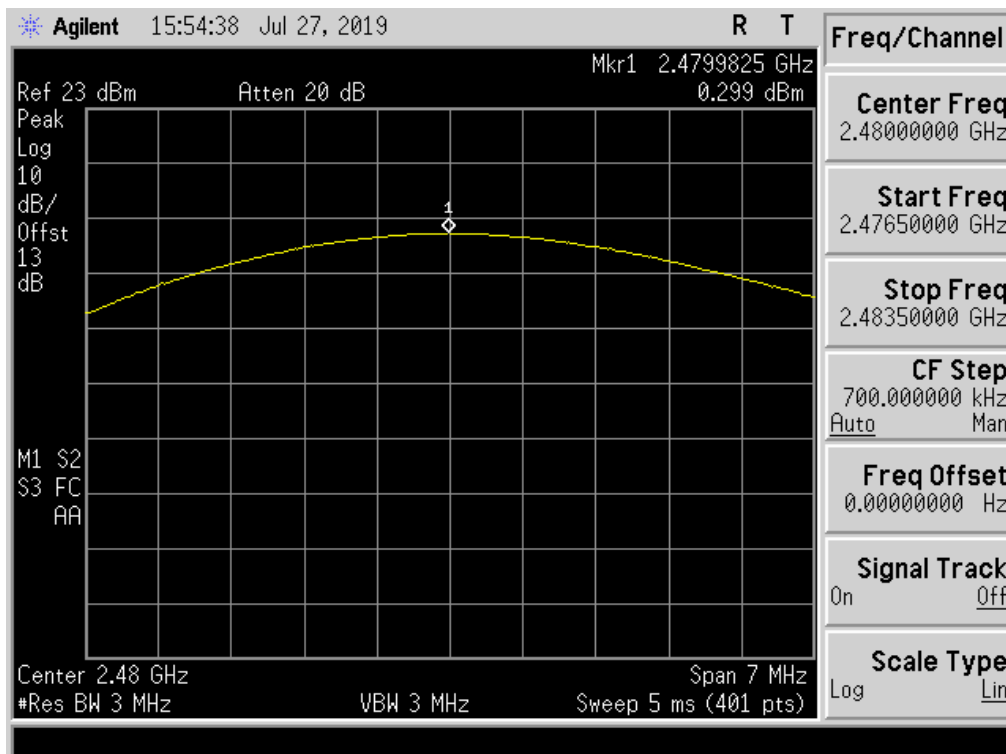
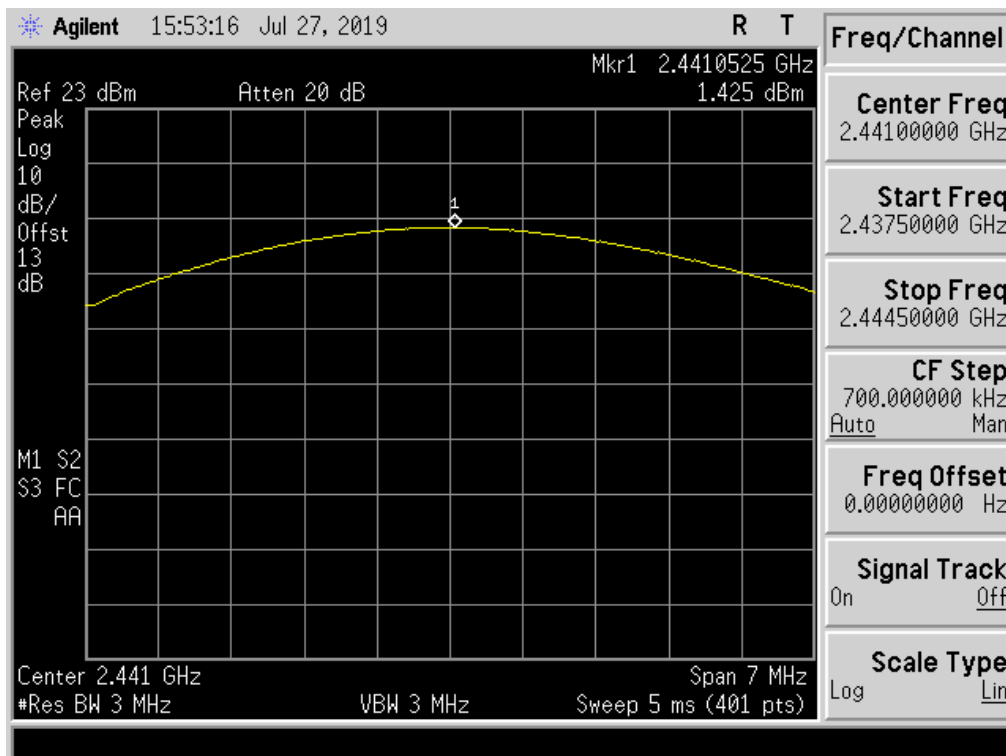



10. Conducted Spurious Emissions Measurement

10.1 Limit

In any 100 kHz bandwidth outside the frequency band in which the spread spectrum or digitally modulated intentional radiator is operating, the radio frequency power that is produced by the intentional radiator shall be at least 20 dB below that in the 100 kHz bandwidth within the band that contains the highest level of the desired power, based on either an RF conducted or a radiated measurement, provided the transmitter demonstrates compliance with the peak conducted or a radiated measurement, provided the transmitter demonstrates compliance with the peak conducted power limits. If the transmitter complies with the conducted power limits based on the use of RMS averaging over a time interval, the attenuation required under this paragraph shall be 30 dB instead of 20 dB. Attenuation below the general limits specified in Section 15.209(a) of FCC part 15 is not required.



10.2 Test Procedure

According to ANSI C63.10: 2013.

Use the following spectrum analyzer settings:

Span = wide enough to capture the peak level of the in-band emission and all spurious emissions (e.g., harmonics) from the lowest frequency generated in the EUT up through the 10th harmonic. Typically, several plots are required to cover this entire span.

RBW = 100 kHz

VBW \cong RBW

Sweep = auto

Detector function = peak

Trace = max hold

Allow the trace to stabilize. Set the marker on the peak of any spurious emission recorded. The level displayed must comply with the limit specified in this section.

10.3 Test Setup

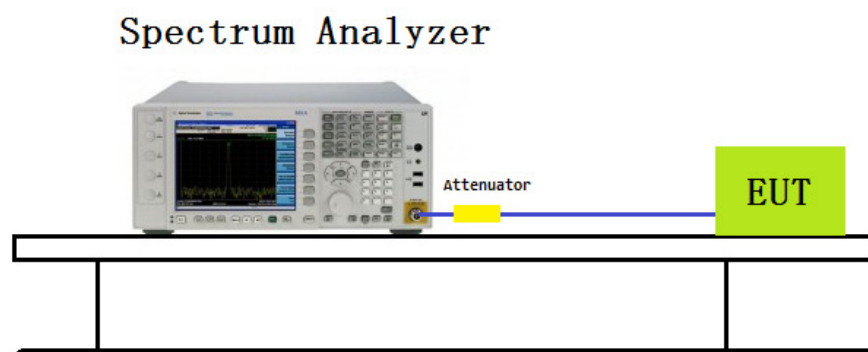



10.4 Test Result

Test Item	Conducted Spurious Emissions Measurement
Test Engineer:	Chris
Test Date	2019-07-26
Test Mode	Transmitting by DH5

Mode 1: Transmit by DH5 (2402MHz)

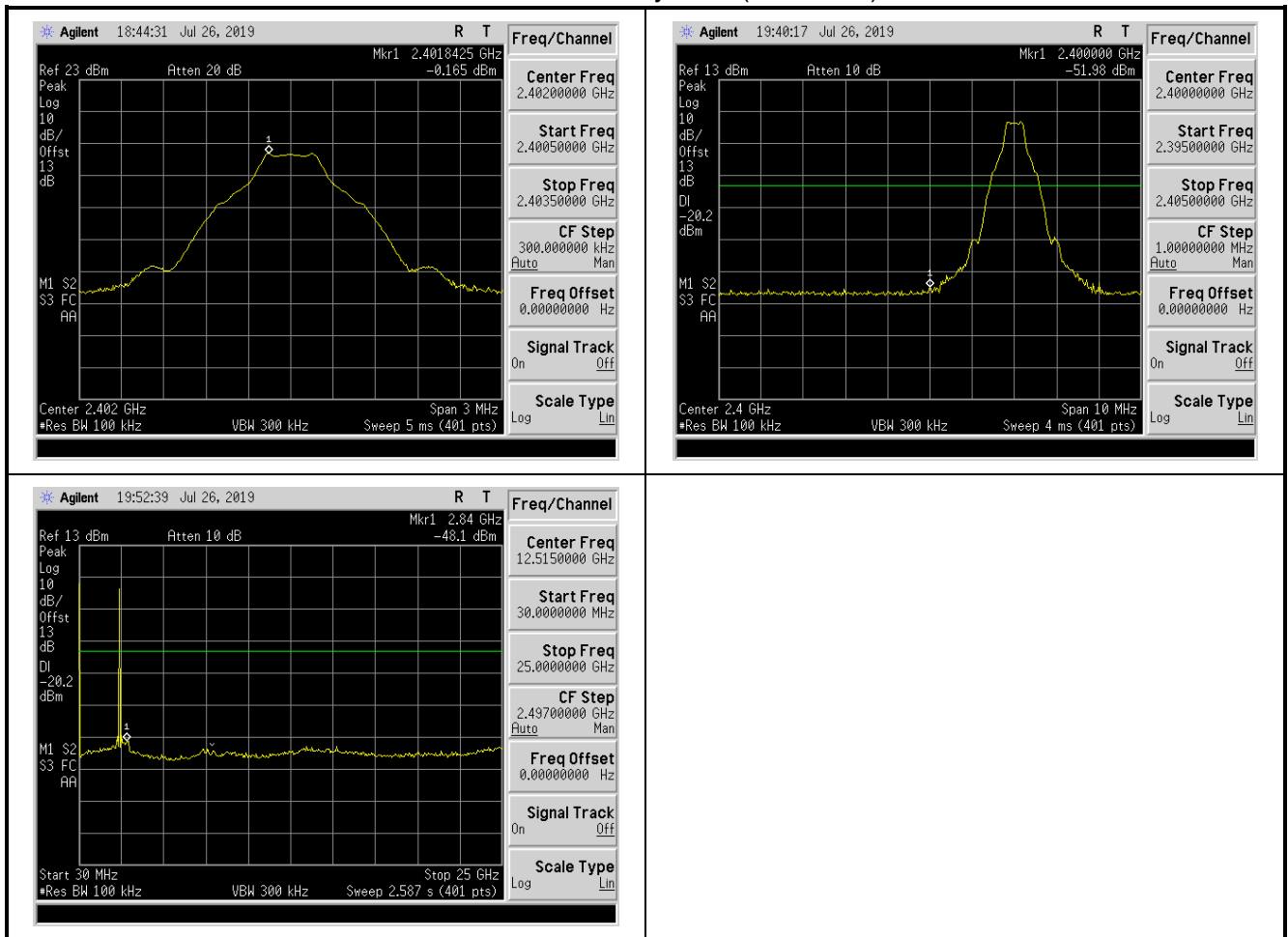



Mode 1: Transmit by DH5 (2441MHz)

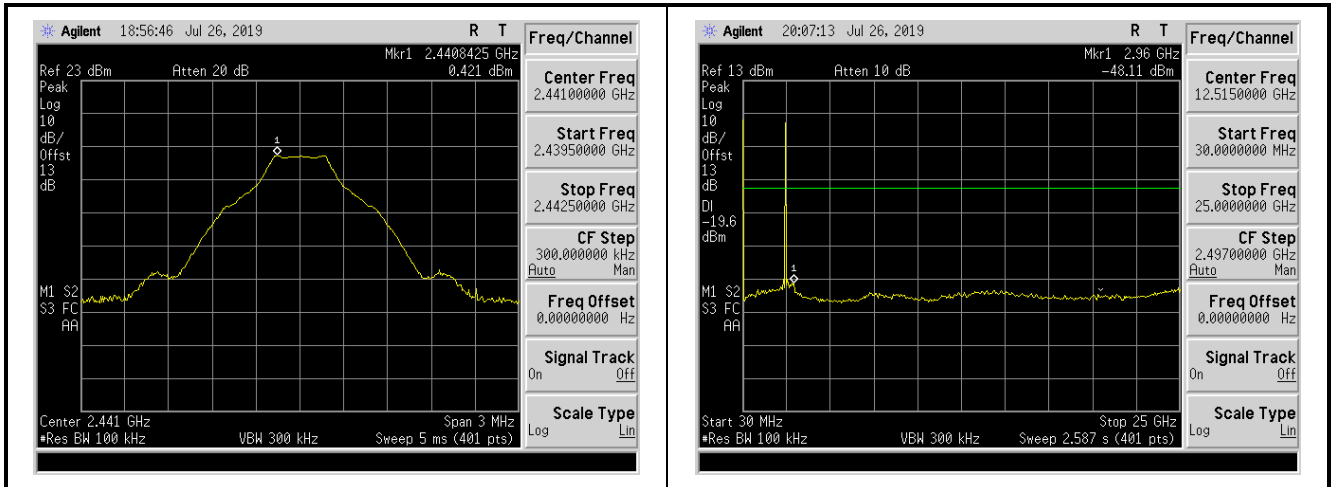

Mode 1: Transmit by DH5 (2480MHz)

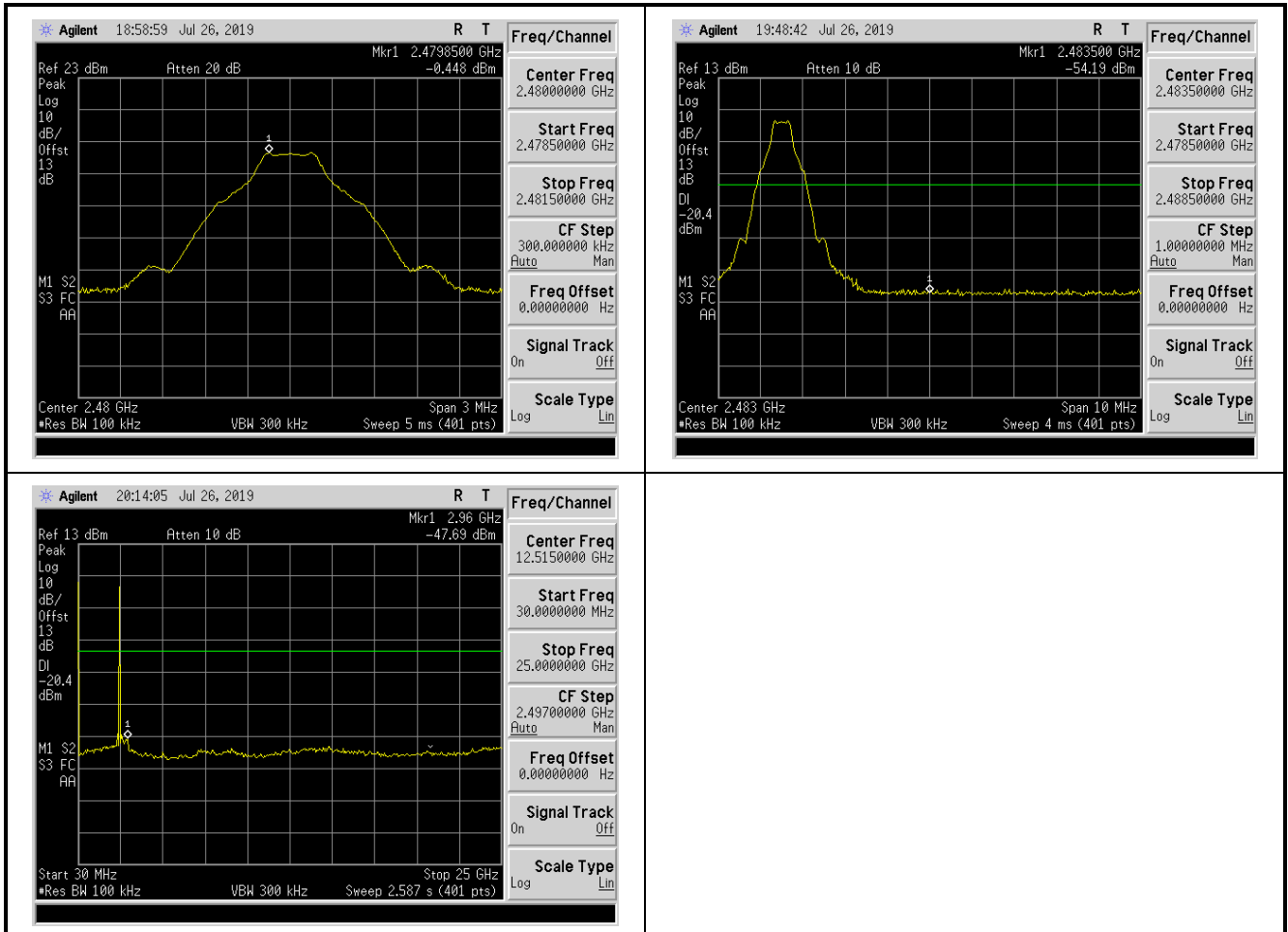



Test Item	Conducted Spurious Emissions Measurement
Test Engineer:	Chris
Test Date	2019-07-26
Test Mode	Transmitting by 2DH5

Mode 2: Transmit by 2DH5 (2402MHz)

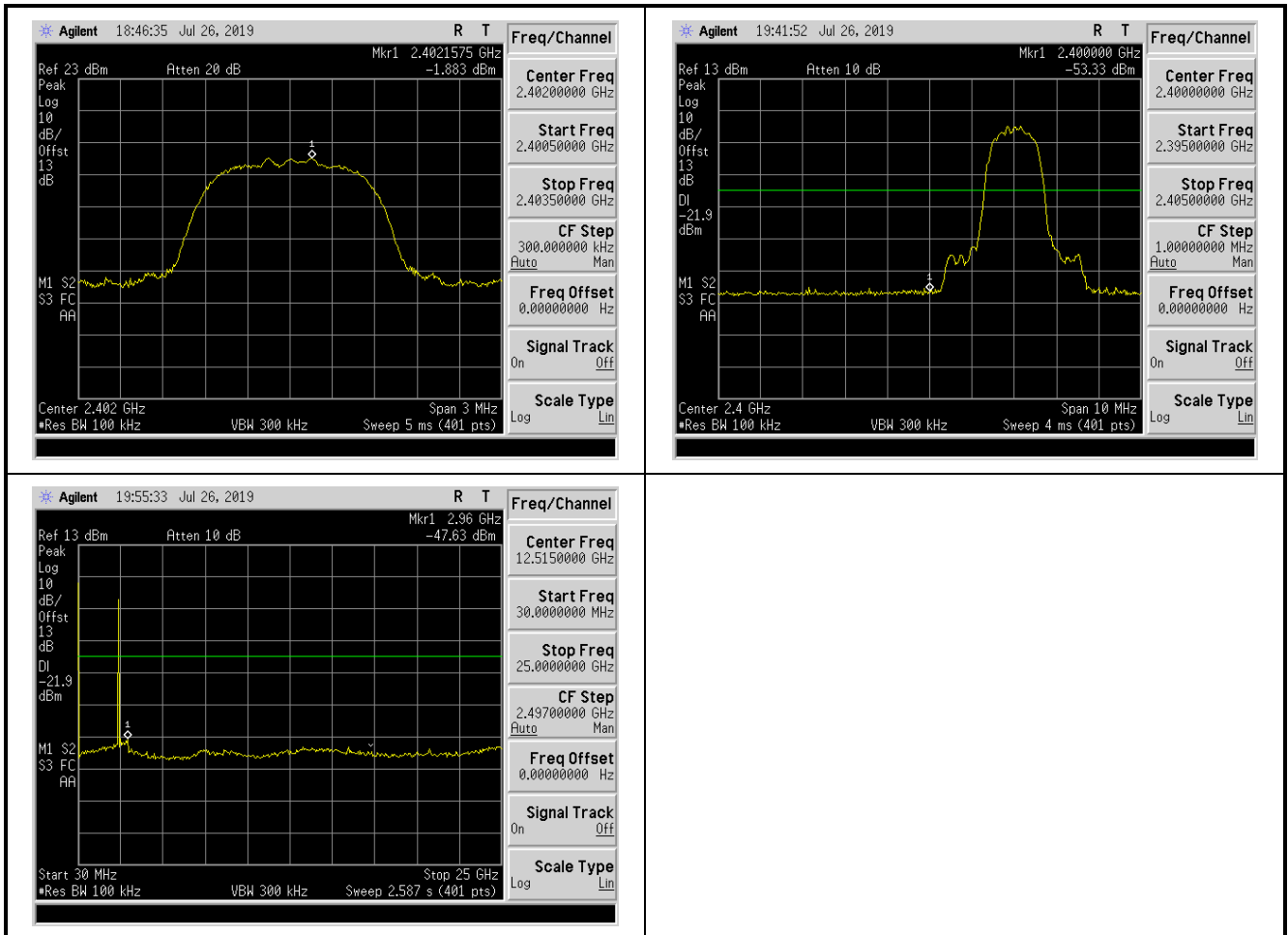



Mode 2: Transmit by 2DH5 (2441MHz)

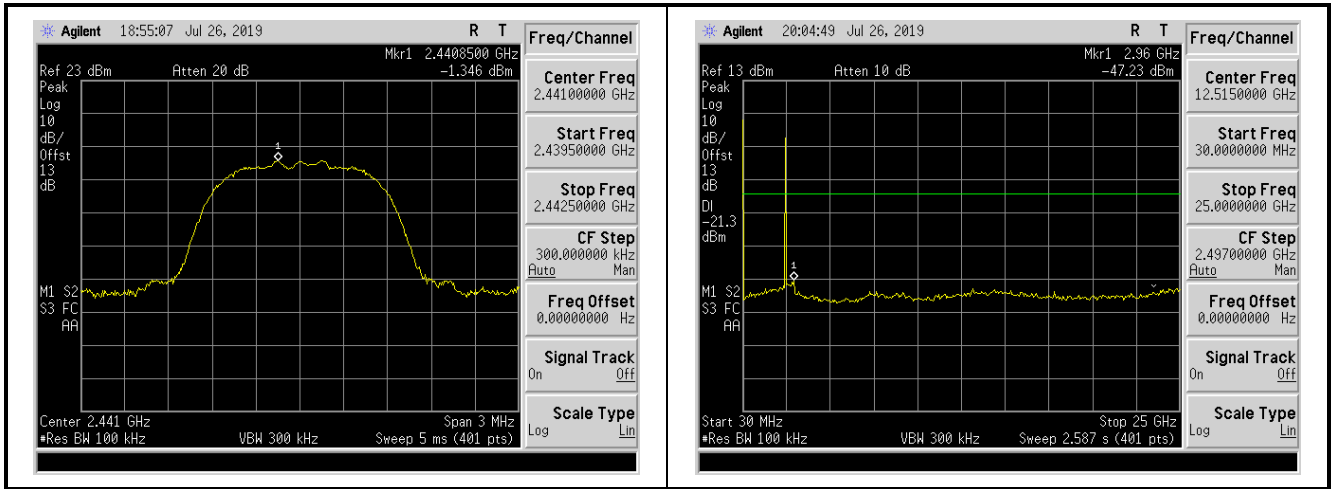

Mode 2: Transmit by 2DH5 (2480MHz)

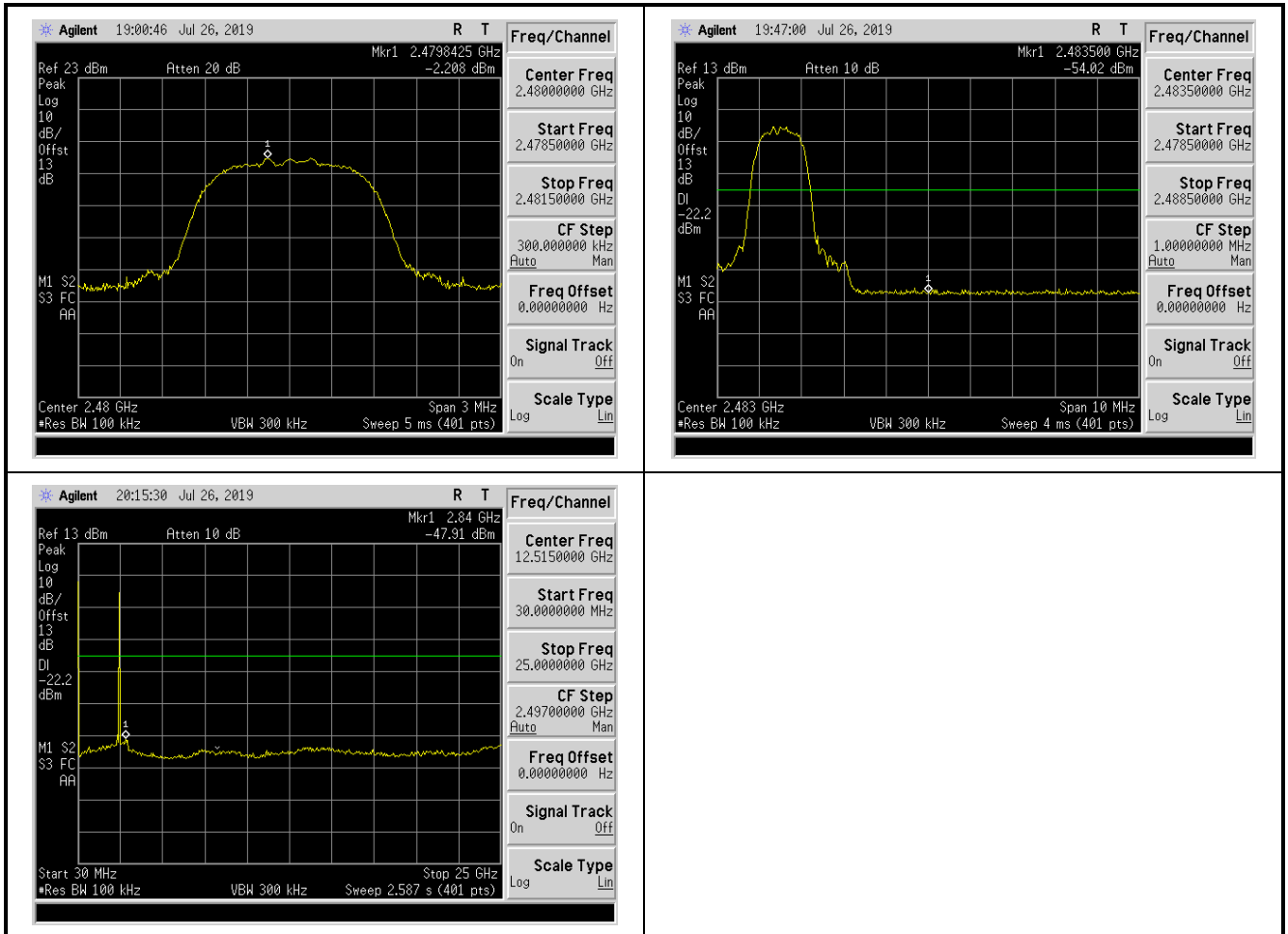



Test Item	Conducted Spurious Emissions Measurement
Test Engineer:	Chris
Test Date	2019-07-26
Test Mode	Transmitting by 3DH5

Mode 3: Transmit by 3DH5 (2402MHz)

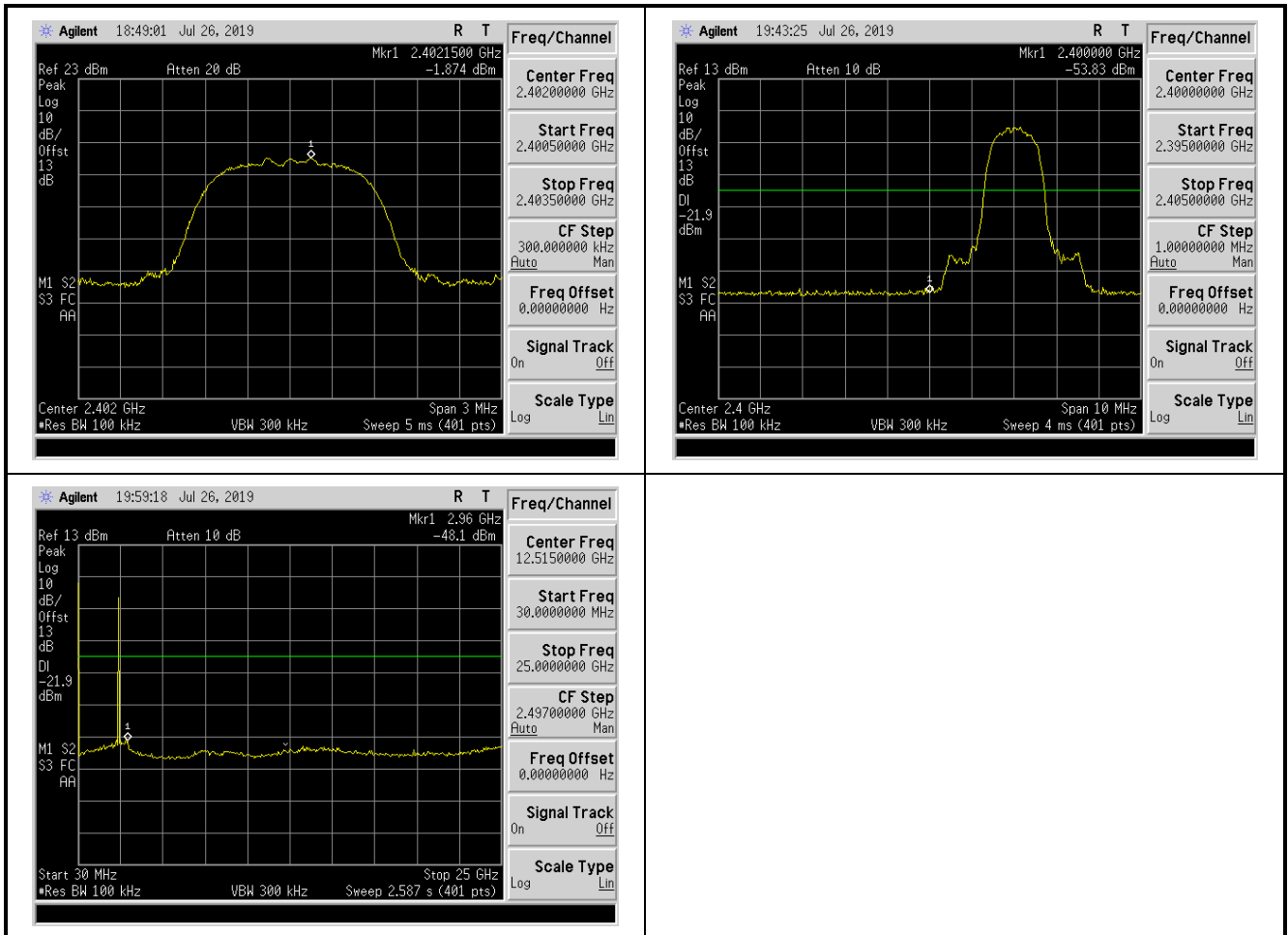



Mode 3: Transmit by 3DH5 (2441MHz)

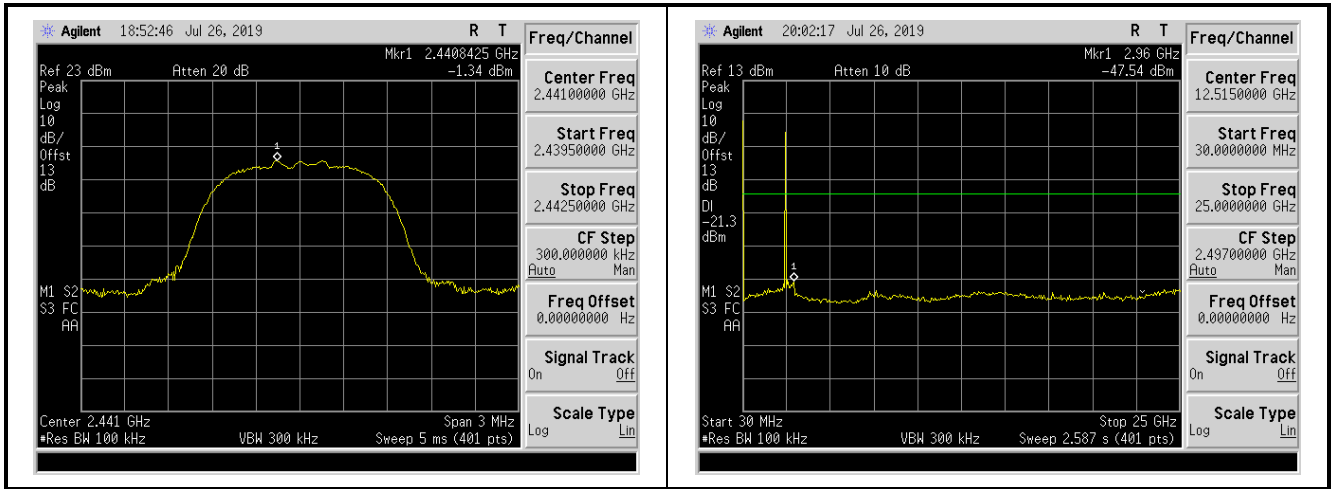

Mode 3: Transmit by 3DH5 (2480MHz)

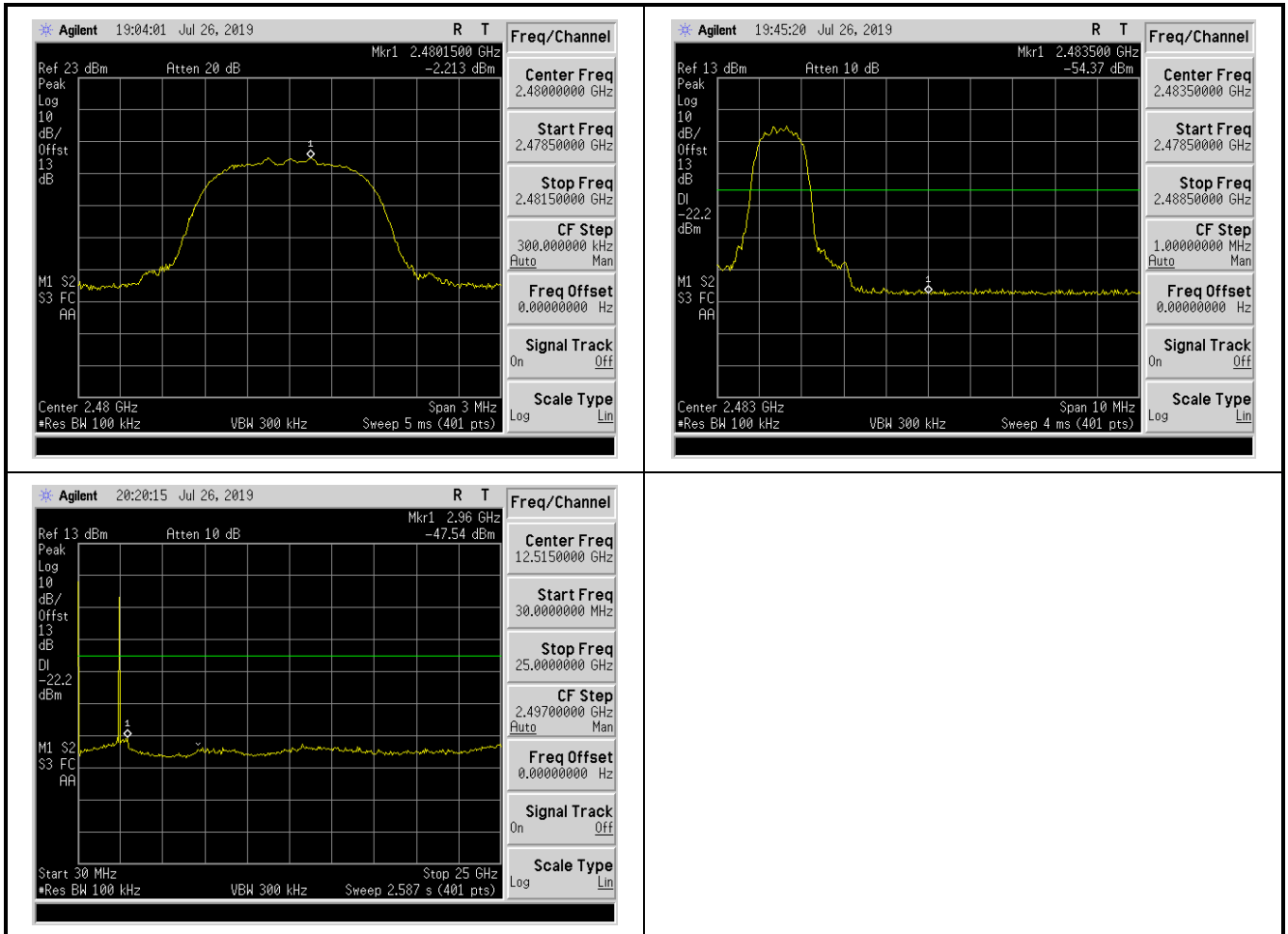



Mode 1: Transmitter at DH5 by Hopping Mode

Low Frequency

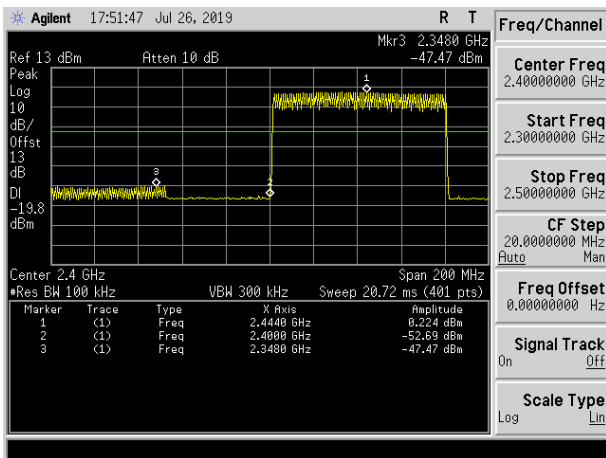

High Frequency

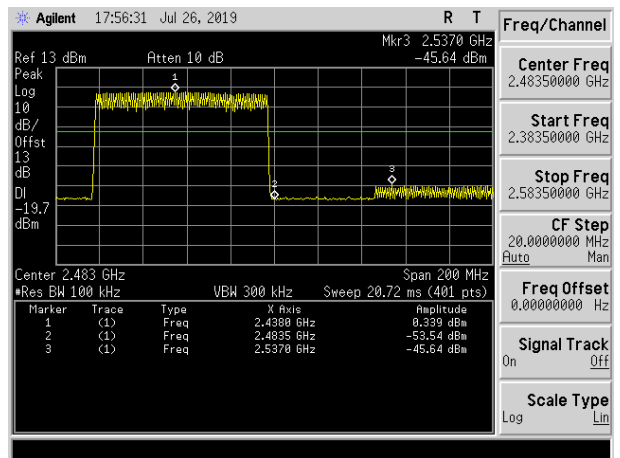

Mode 2: Transmitter at 2DH5 by Hopping Mode

Low Frequency

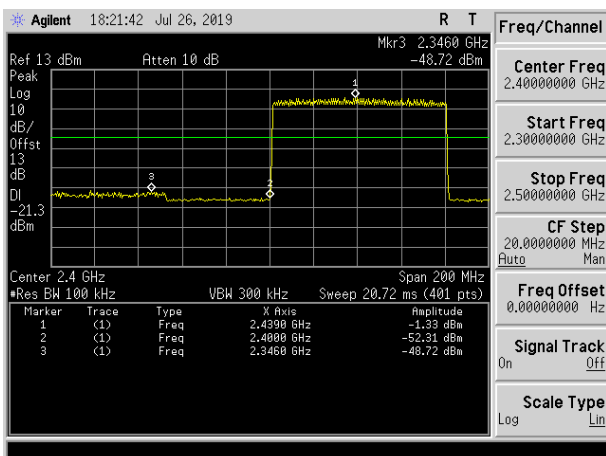

High Frequency

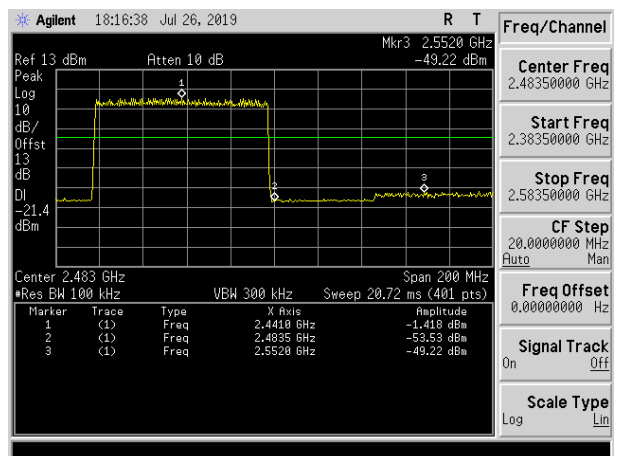



Mode 3: Transmitter at 3DH5 by Hopping Mode

Low Frequency

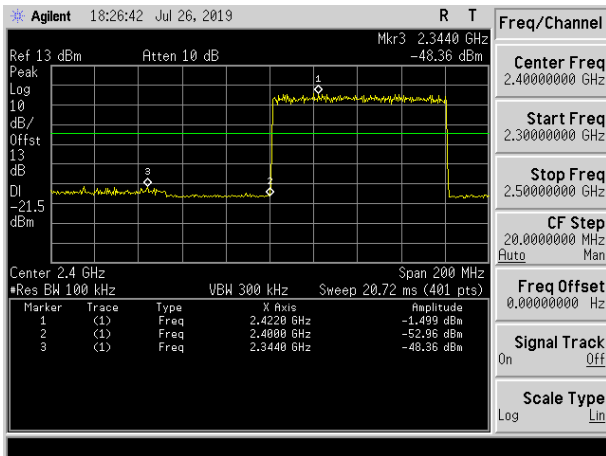

High Frequency

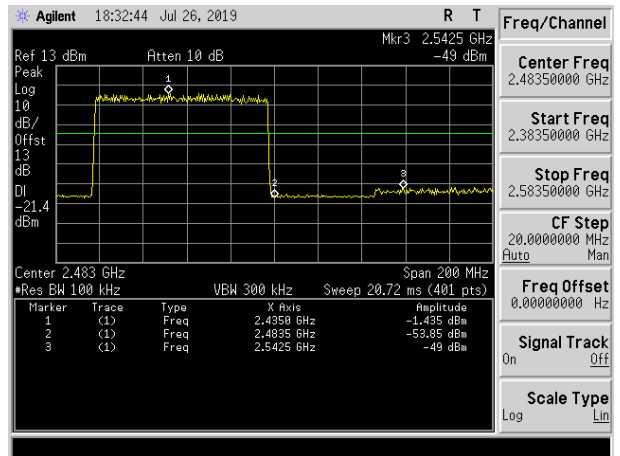



11. Radiated Emission Band Edge Measurement

11.1 Limit

Radiated emissions which fall in the restricted bands, as defined in Section 15.205(a) of FCC part 15, must also comply with the radiated emission limits specified in Section 15.209(a) of FCC part 15.

11.2 Test Procedure

According to ANSI C63.10: 2013.

This test is required for any spurious emission or modulation product that falls in a Restricted Band, as defined in Section 15.205 of FCC part 15. It must be performed with the highest gain of each type of antenna proposed for use with the EUT. Use the following spectrum analyzer settings:

Span = wide enough to fully capture the emission being measured

RBW = 1 MHz for $f \geq 1$ GHz, 100 kHz for $f < 1$ GHz

VBW \geq RBW

Sweep = auto

Detector function = peak

Trace = max hold

Follow the guidelines in ANSI C63.10 with respect to maximizing the emission by rotating the EUT, measuring the emission while the EUT is situated in three orthogonal planes (if appropriate), adjusting the measurement antenna height and polarization, etc. A pre-amp and a high pass filter are required for this test, in order to provide the measuring system with sufficient sensitivity. Allow the trace to stabilize. The peak reading of the emission, after being corrected by the antenna factor, cable loss, pre-amp gain, etc., is the peak field strength, which must comply with the limit specified in Section 15.35(b) of FCC part 15.

Now set the VBW to 10 Hz, while maintaining all of the other instrument settings. This peak level, once corrected, must comply with the limit specified in Section 15.209 of FCC Part 15. If the dwell time per channel of the hopping signal is less than 100 ms, then the reading obtained with the 10 Hz VBW may be further adjusted by a “duty cycle correction factor”, derived from $20\log(\text{dwell time}/100 \text{ ms})$, in an effort to demonstrate compliance with the 15.209 limit of FCC part 15.

If the emission on which a radiated measurement must be made is located at the edge of the authorized band of operation, then the alternative “marker-delta” method may be employed.



11.3 Test Setup

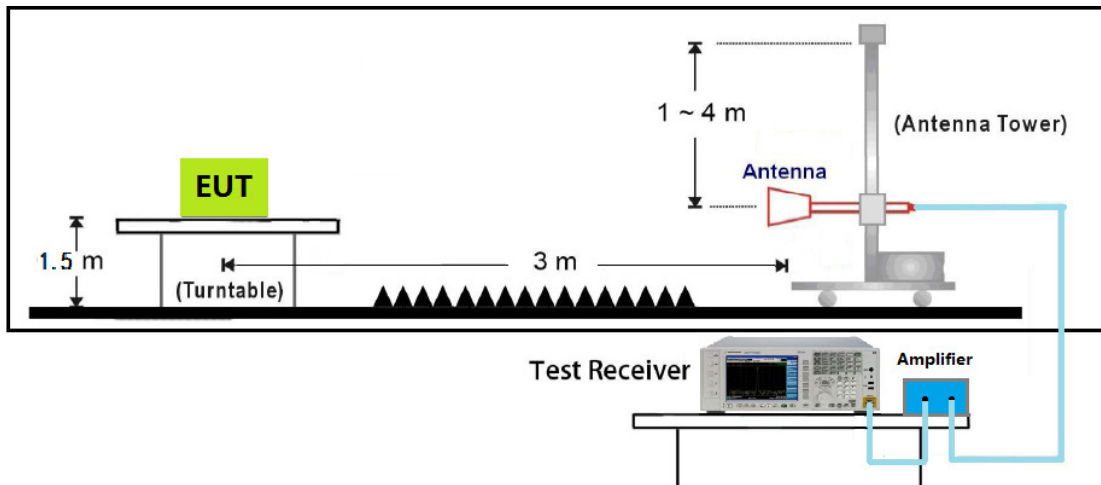



11.4 Test Result

Engineer: Chris	
Site: AC102	Time: 2019/07/30 - 22:53
Limit: FCC_Part15.209_RE(3m)	Margin: 0
Probe: N/A	Polarity: Horizontal
EUT: Tablet	Power: AC 120V/60Hz
Note: BT-DH5 2402MHz	

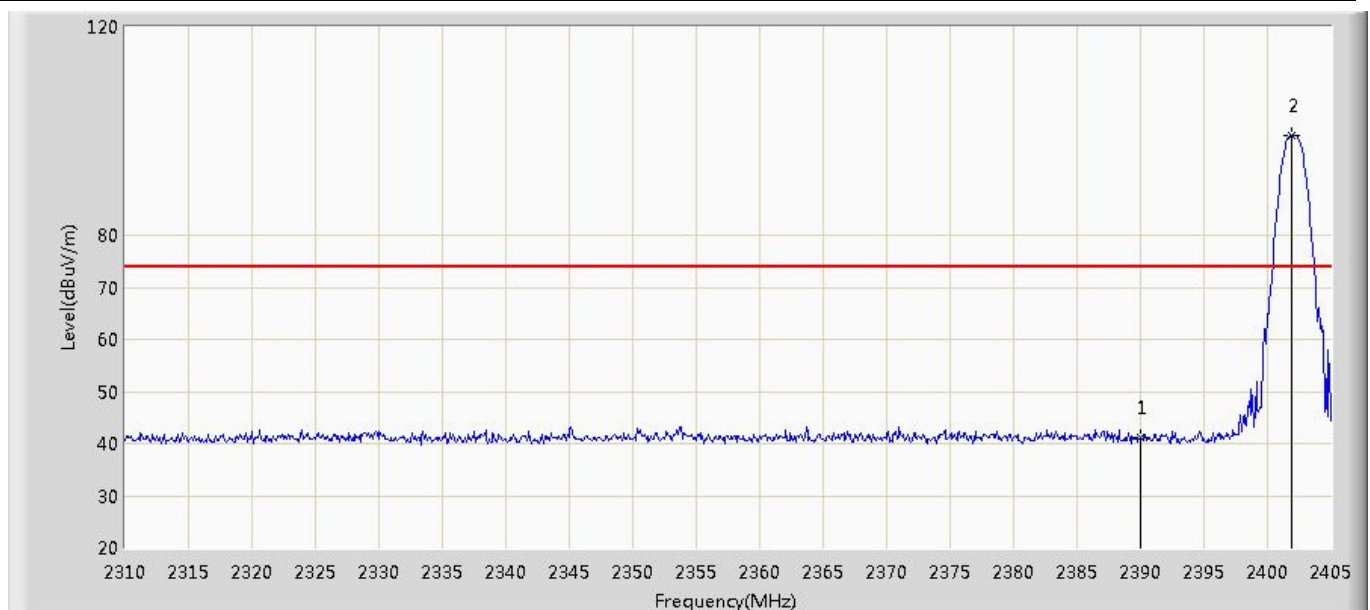

N	Mar	Frequency (MHz)	Measure Level (dBuV/m)	Reading Level (dBuV)	Over Limit (dB)	Limit (dBuV/m)	Factor (dB)	Type
1		2390.000	41.095	42.772	-32.905	74.000	-1.677	PK
2	*	2401.960	99.104	100.737	N/A	N/A	-1.633	PK

Note:

1. All Readings below 1GHz are Quasi-Peak, above are performed with peak and/or average measurements as necessary.
2. " * ", means this data is the worst emission level.
3. Measurement Level = Reading Level + Factor(Probe+Cable-Amp).



Engineer: Chris	
Site: AC102	Time: 2019/07/30 - 22:55
Limit: FCC_Part15.209_RE(3m)	Margin: 0
Probe: N/A	Polarity: Horizontal
EUT: Tablet	Power: AC 120V/60Hz
Note: BT-DH5 2402MHz	

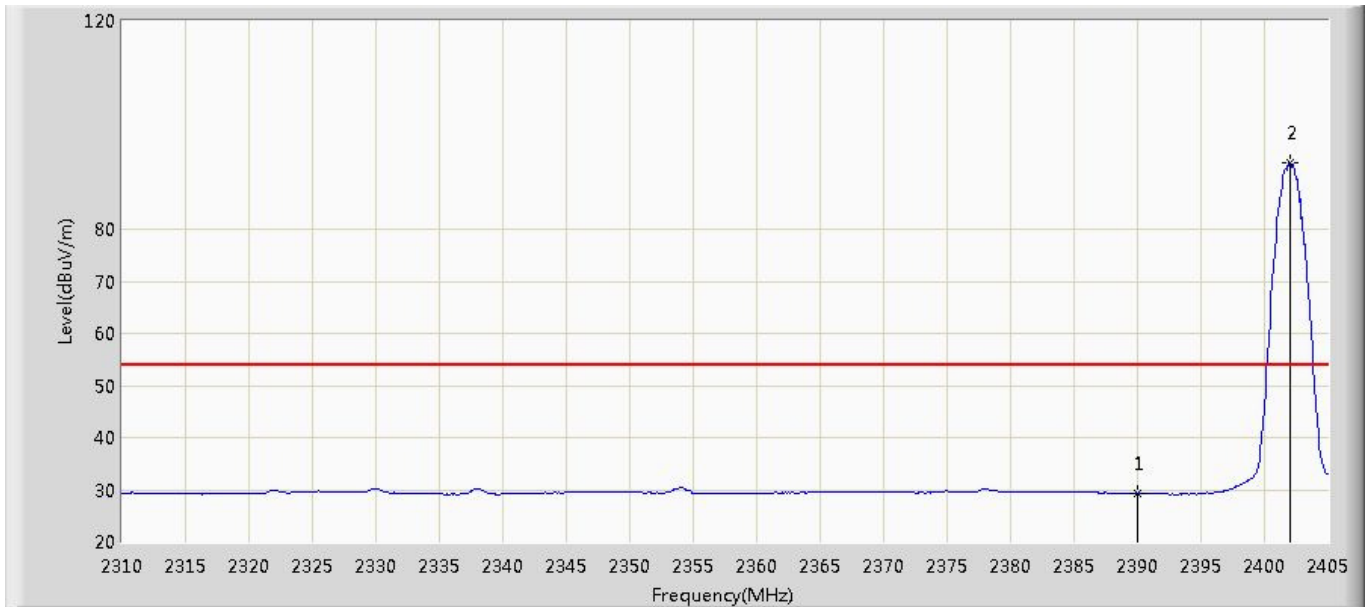

No	Mark	Frequency (MHz)	Measure Level (dBuV/m)	Reading Level (dBuV)	Over Limit (dB)	Limit (dBuV/m)	Factor (dB)	Type
1		2390.000	29.322	30.999	-24.678	54.000	-1.677	AV
2	*	2402.055	92.861	94.494	N/A	N/A	-1.633	AV

Note:

1. All Readings below 1GHz are Quasi-Peak, above are performed with peak and/or average measurements as necessary.
2. " * ", means this data is the worst emission level.
3. Measurement Level = Reading Level + Factor(Probe+Cable-Amp).



Engineer: Chris	
Site: AC102	Time: 2019/07/30 - 22:56
Limit: FCC_Part15.209_RE(3m)	Margin: 0
Probe: N/A	Polarity: Vertical
EUT: Tablet	Power: AC 120V/60Hz
Note: BT-DH5 2402MHz	

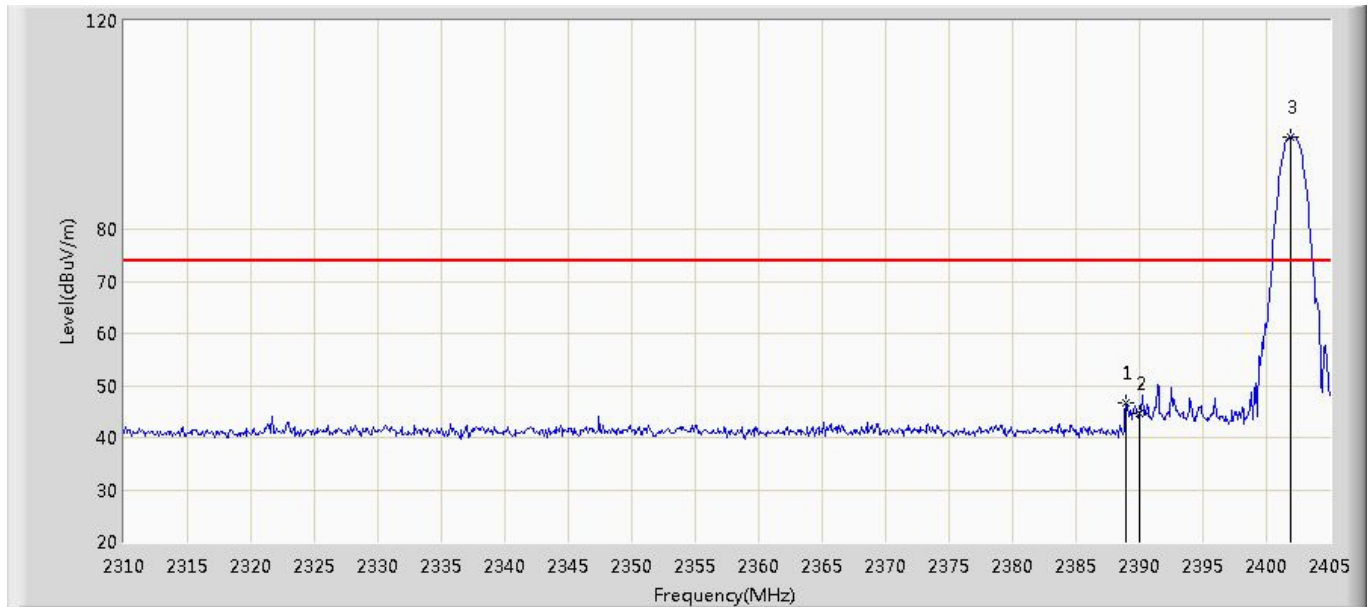

No	Mark	Frequency (MHz)	Measure Level (dBuV/m)	Reading Level (dBuV)	Over Limit (dB)	Limit (dBuV/m)	Factor (dB)	Type
1		2388.945	46.684	48.365	-27.316	74.000	-1.681	PK
2		2390.000	44.767	46.444	-29.233	74.000	-1.677	PK
3	*	2401.960	97.657	99.290	N/A	N/A	-1.633	PK

Note:

1. All Readings below 1GHz are Quasi-Peak, above are performed with peak and/or average measurements as necessary.
2. " * ", means this data is the worst emission level.
3. Measurement Level = Reading Level + Factor(Probe+Cable-Amp).



Engineer: Chris	
Site: AC102	Time: 2019/07/30 - 22:59
Limit: FCC_Part15.209_RE(3m)	Margin: 0
Probe: N/A	Polarity: Vertical
EUT: Tablet	Power: AC 120V/60Hz
Note: BT-DH5 2402MHz	

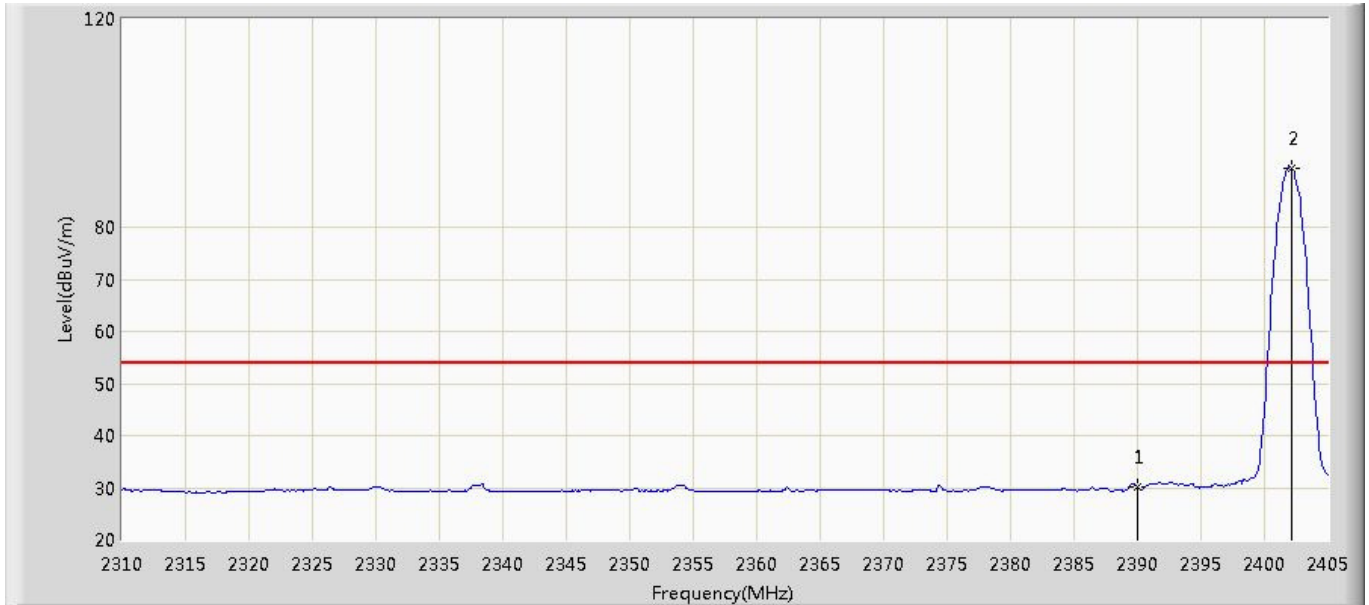

N o	Mar k	Frequency (MHz)	Measure Level (dBuV/m)	Reading Level (dBuV)	Over Limit (dB)	Limit (dBuV/m)	Factor (dB)	Type
1		2390.000	30.100	31.777	-23.900	54.000	-1.677	AV
2	*	2402.150	91.409	93.041	N/A	N/A	-1.632	AV

Note:

1. All Readings below 1GHz are Quasi-Peak, above are performed with peak and/or average measurements as necessary.
2. " * ", means this data is the worst emission level.
3. Measurement Level = Reading Level + Factor(Probe+Cable-Amp).



Engineer: Chris	
Site: AC102	Time: 2019/07/30 - 23:02
Limit: FCC_Part15.209_RE(3m)	Margin: 0
Probe: N/A	Polarity: Horizontal
EUT: Tablet	Power: AC 120V/60Hz
Note: BT-DH5 2480MHz	

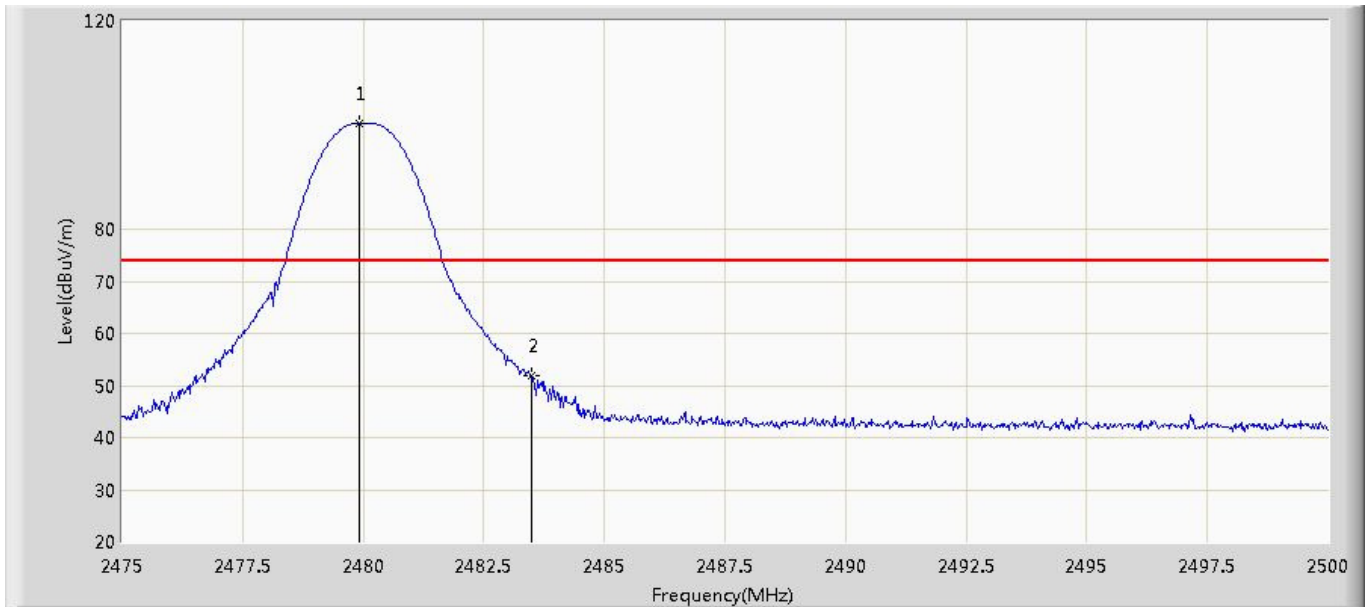

No	Mark	Frequency (MHz)	Measure Level (dBuV/m)	Reading Level (dBuV)	Over Limit (dB)	Limit (dBuV/m)	Factor (dB)	Type
1	*	2479.925	100.291	101.635	N/A	N/A	-1.344	PK
2		2483.500	51.762	53.093	-22.238	74.000	-1.331	PK

Note:

1. All Readings below 1GHz are Quasi-Peak, above are performed with peak and/or average measurements as necessary.
2. " * ", means this data is the worst emission level.
3. Measurement Level = Reading Level + Factor(Probe+Cable-Amp).



Engineer: Chris	
Site: AC102	Time: 2019/07/30 - 23:05
Limit: FCC_Part15.209_RE(3m)	Margin: 0
Probe: N/A	Polarity: Horizontal
EUT: Tablet	Power: AC 120V/60Hz
Note: BT-DH5 2480MHz	

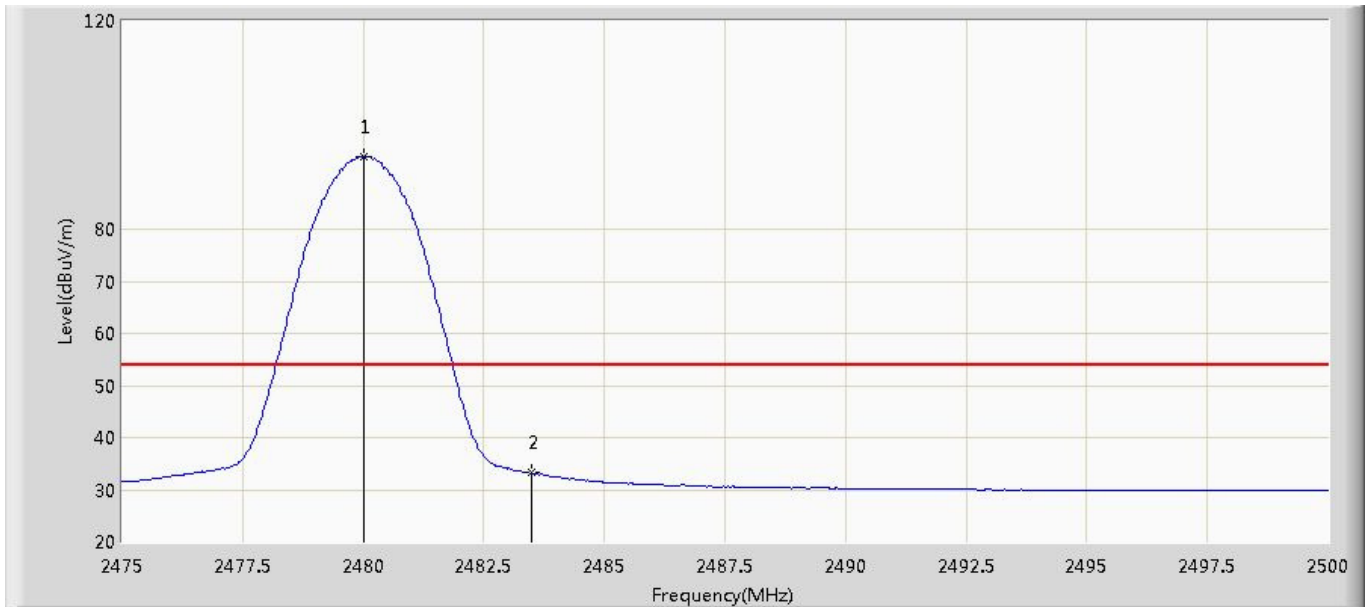

N o	Mar k	Frequency (MHz)	Measure Level (dBuV/m)	Reading Level (dBuV)	Over Limit (dB)	Limit (dBuV/m)	Factor (dB)	Type
1	*	2480.000	93.939	95.283	N/A	N/A	-1.344	AV
2		2483.500	33.193	34.524	-20.807	54.000	-1.331	AV

Note:

1. All Readings below 1GHz are Quasi-Peak, above are performed with peak and/or average measurements as necessary.
2. " * ", means this data is the worst emission level.
3. Measurement Level = Reading Level + Factor(Probe+Cable-Amp).



Engineer: Chris	
Site: AC102	Time: 2019/07/30 - 23:06
Limit: FCC_Part15.209_RE(3m)	Margin: 0
Probe: N/A	Polarity: Vertical
EUT: Tablet	Power: AC 120V/60Hz
Note: BT-DH5 2480MHz	

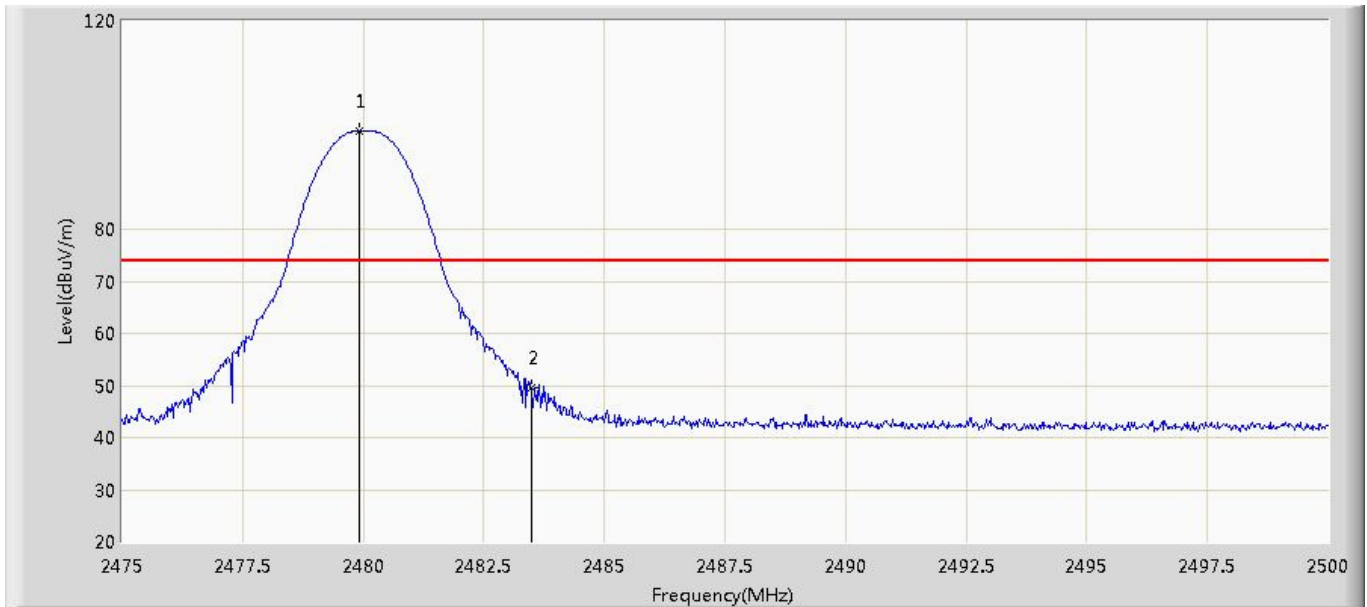

N o	Mar k	Frequency (MHz)	Measure Level (dBuV/m)	Reading Level (dBuV)	Over Limit (dB)	Limit (dBuV/m)	Factor (dB)	Type
1	*	2479.925	98.782	100.126	N/A	N/A	-1.344	PK
2		2483.500	49.425	50.756	-24.575	74.000	-1.331	PK

Note:

1. All Readings below 1GHz are Quasi-Peak, above are performed with peak and/or average measurements as necessary.
2. " * ", means this data is the worst emission level.
3. Measurement Level = Reading Level + Factor(Probe+Cable-Amp).



Engineer: Chris	
Site: AC102	Time: 2019/07/30 - 23:09
Limit: FCC_Part15.209_RE(3m)	Margin: 0
Probe: N/A	Polarity: Vertical
EUT: Tablet	Power: AC 120V/60Hz
Note: BT-DH5 2480MHz	

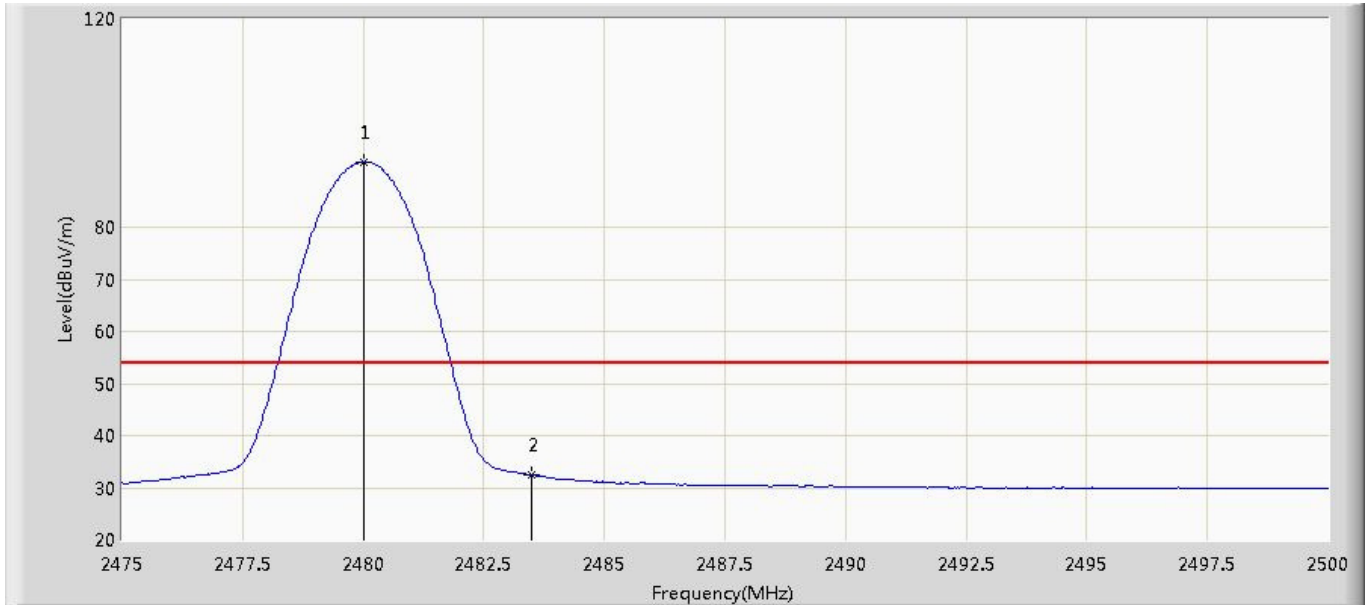

N o	Mar k	Frequency (MHz)	Measure Level (dBuV/m)	Reading Level (dBuV)	Over Limit (dB)	Limit (dBuV/m)	Factor (dB)	Type
1	*	2480.000	92.528	93.872	N/A	N/A	-1.344	AV
2		2483.500	32.439	33.770	-21.561	54.000	-1.331	AV

Note:

1. All Readings below 1GHz are Quasi-Peak, above are performed with peak and/or average measurements as necessary.
2. " * ", means this data is the worst emission level.
3. Measurement Level = Reading Level + Factor(Probe+Cable-Amp).



Engineer: Chris	
Site: AC102	Time: 2019/07/30 - 23:10
Limit: FCC_Part15.209_RE(3m)	Margin: 0
Probe: N/A	Polarity: Horizontal
EUT: Tablet	Power: AC 120V/60Hz
Note: BT-2DH5 2402MHz	

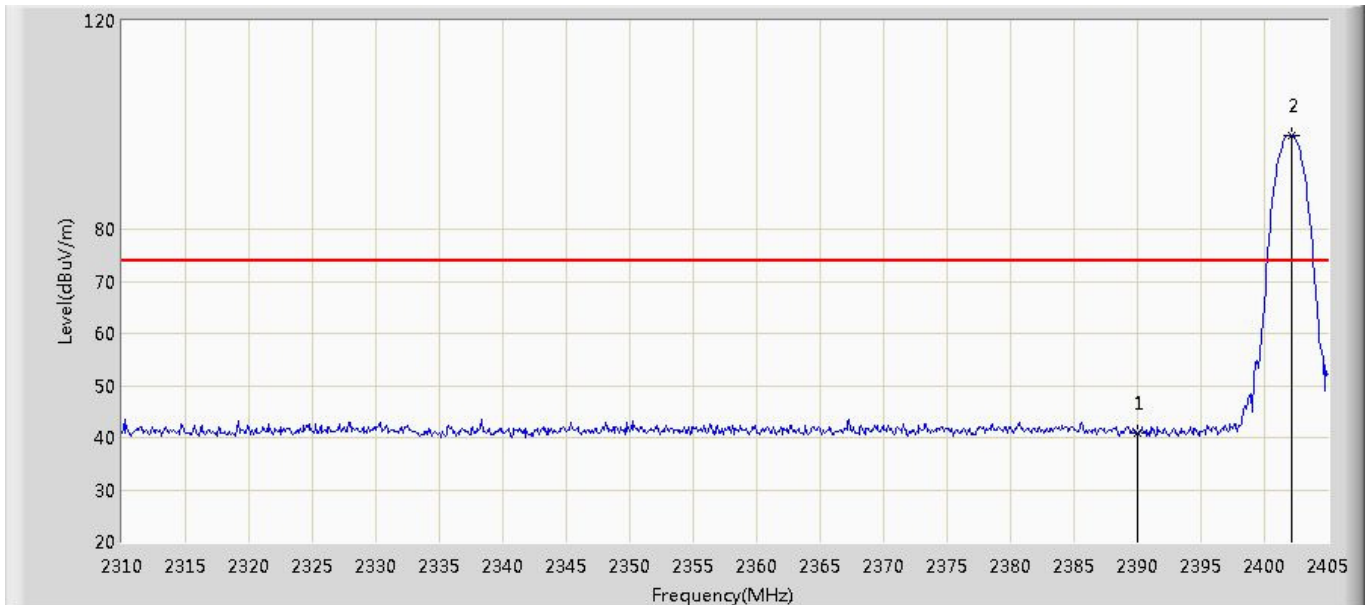

N o	Mar k	Frequency (MHz)	Measure Level (dBuV/m)	Reading Level (dBuV)	Over Limit (dB)	Limit (dBuV/m)	Factor (dB)	Type
1		2390.000	40.731	42.408	-33.269	74.000	-1.677	PK
2	*	2402.150	98.103	99.735	N/A	N/A	-1.632	PK

Note:

1. All Readings below 1GHz are Quasi-Peak, above are performed with peak and/or average measurements as necessary.
2. " * ", means this data is the worst emission level.
3. Measurement Level = Reading Level + Factor(Probe+Cable-Amp).



Engineer: Chris	
Site: AC102	Time: 2019/07/30 - 23:14
Limit: FCC_Part15.209_RE(3m)	Margin: 0
Probe: N/A	Polarity: Horizontal
EUT: Tablet	Power: AC 120V/60Hz
Note: BT-2DH5 2402MHz	

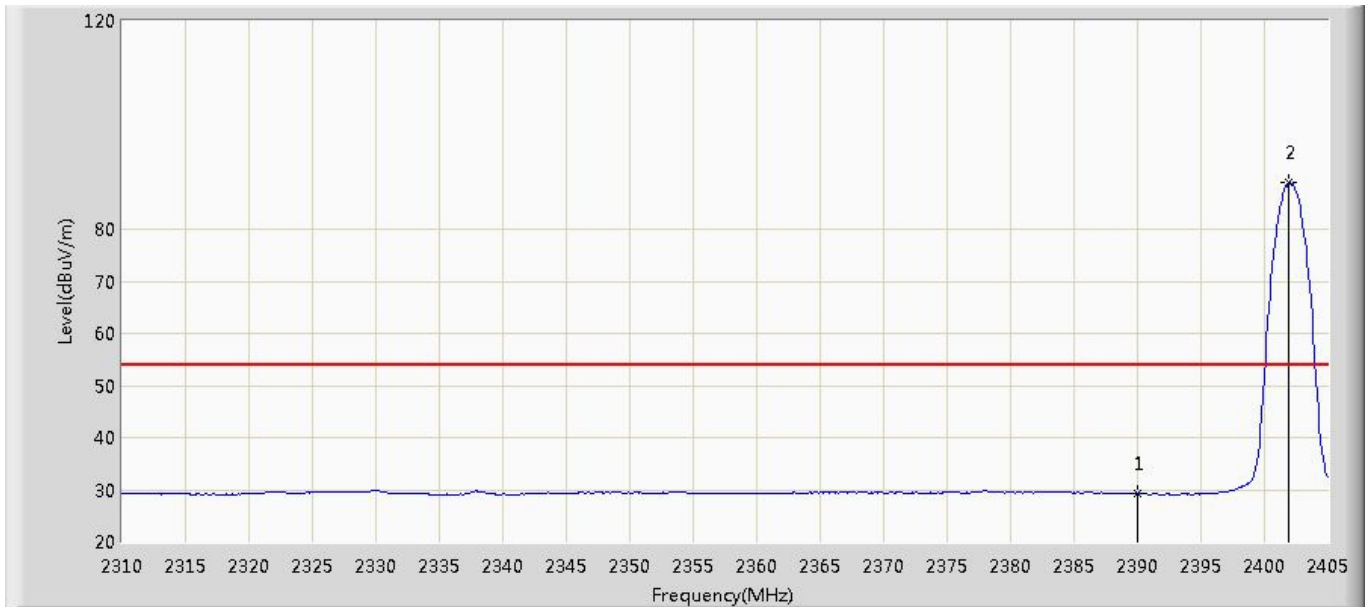

N o	Mar k	Frequency (MHz)	Measure Level (dBuV/m)	Reading Level (dBuV)	Over Limit (dB)	Limit (dBuV/m)	Factor (dB)	Type
1		2390.000	29.223	30.900	-24.777	54.000	-1.677	AV
2	*	2401.960	88.991	90.624	N/A	N/A	-1.633	AV

Note:

1. All Readings below 1GHz are Quasi-Peak, above are performed with peak and/or average measurements as necessary.
2. " * ", means this data is the worst emission level.
3. Measurement Level = Reading Level + Factor(Probe+Cable-Amp).



Engineer: Chris	
Site: AC102	Time: 2019/07/30 - 23:16
Limit: FCC_Part15.209_RE(3m)	Margin: 0
Probe: N/A	Polarity: Vertical
EUT: Tablet	Power: AC 120V/60Hz
Note: BT-2DH5 2402MHz	

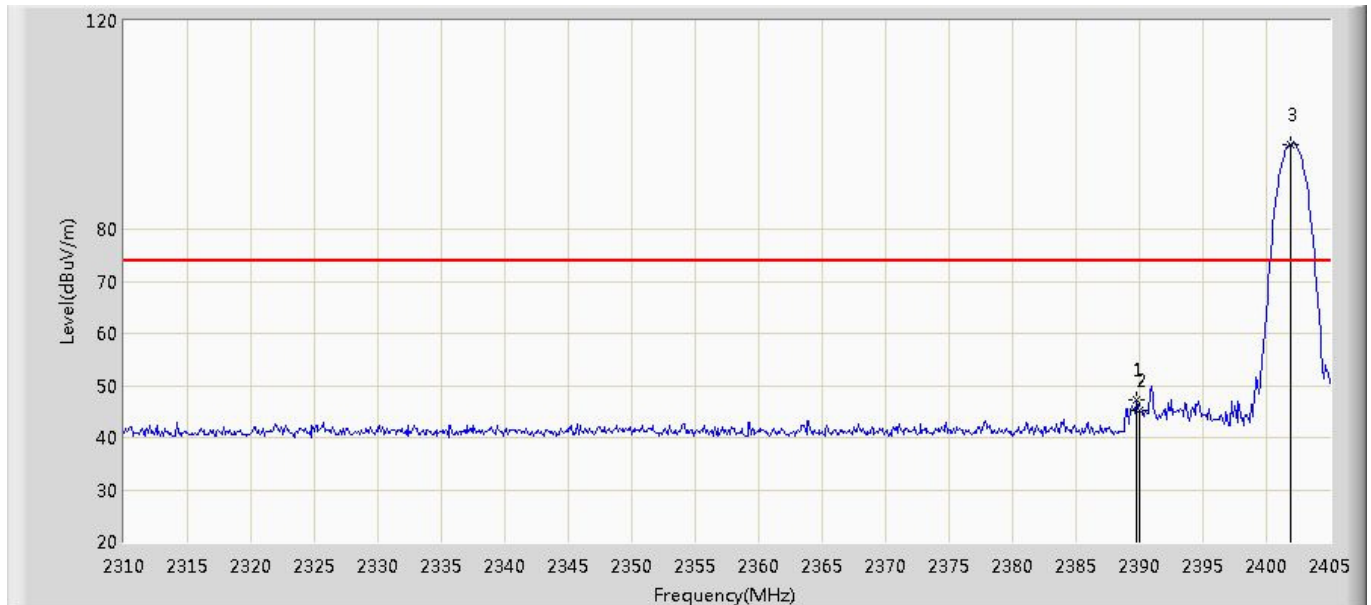

No	Mark	Frequency (MHz)	Measure Level (dBuV/m)	Reading Level (dBuV)	Over Limit (dB)	Limit (dBuV/m)	Factor (dB)	Type
1		2389.705	47.337	49.015	-26.663	74.000	-1.678	PK
2		2390.000	45.170	46.847	-28.830	74.000	-1.677	PK
3	*	2401.960	96.269	97.902	N/A	N/A	-1.633	PK

Note:

1. All Readings below 1GHz are Quasi-Peak, above are performed with peak and/or average measurements as necessary.
2. " * ", means this data is the worst emission level.
3. Measurement Level = Reading Level + Factor(Probe+Cable-Amp).



Engineer: Chris	
Site: AC102	Time: 2019/07/30 - 23:17
Limit: FCC_Part15.209_RE(3m)	Margin: 0
Probe: N/A	Polarity: Vertical
EUT: Tablet	Power: AC 120V/60Hz
Note: BT-2DH5 2402MHz	

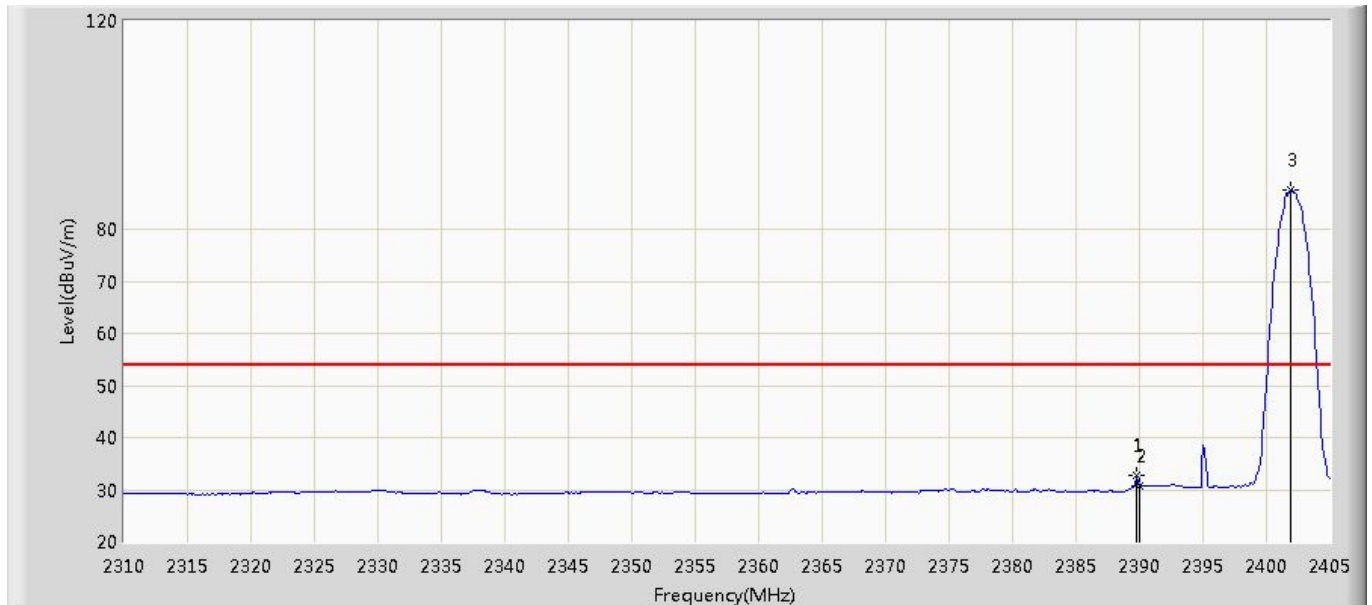

No	Mark	Frequency (MHz)	Measure Level (dBuV/m)	Reading Level (dBuV)	Over Limit (dB)	Limit (dBuV/m)	Factor (dB)	Type
1		2389.800	32.649	34.326	-21.351	54.000	-1.677	AV
2		2390.000	30.791	32.468	-23.209	54.000	-1.677	AV
3	*	2401.960	87.426	89.059	N/A	N/A	-1.633	AV

Note:

1. All Readings below 1GHz are Quasi-Peak, above are performed with peak and/or average measurements as necessary.
2. " * ", means this data is the worst emission level.
3. Measurement Level = Reading Level + Factor(Probe+Cable-Amp).



Engineer: Chris	
Site: AC102	Time: 2019/07/30 - 23:21
Limit: FCC_Part15.209_RE(3m)	Margin: 0
Probe: N/A	Polarity: Horizontal
EUT: Tablet	Power: AC 120V/60Hz
Note: BT-2DH5 2480MHz	

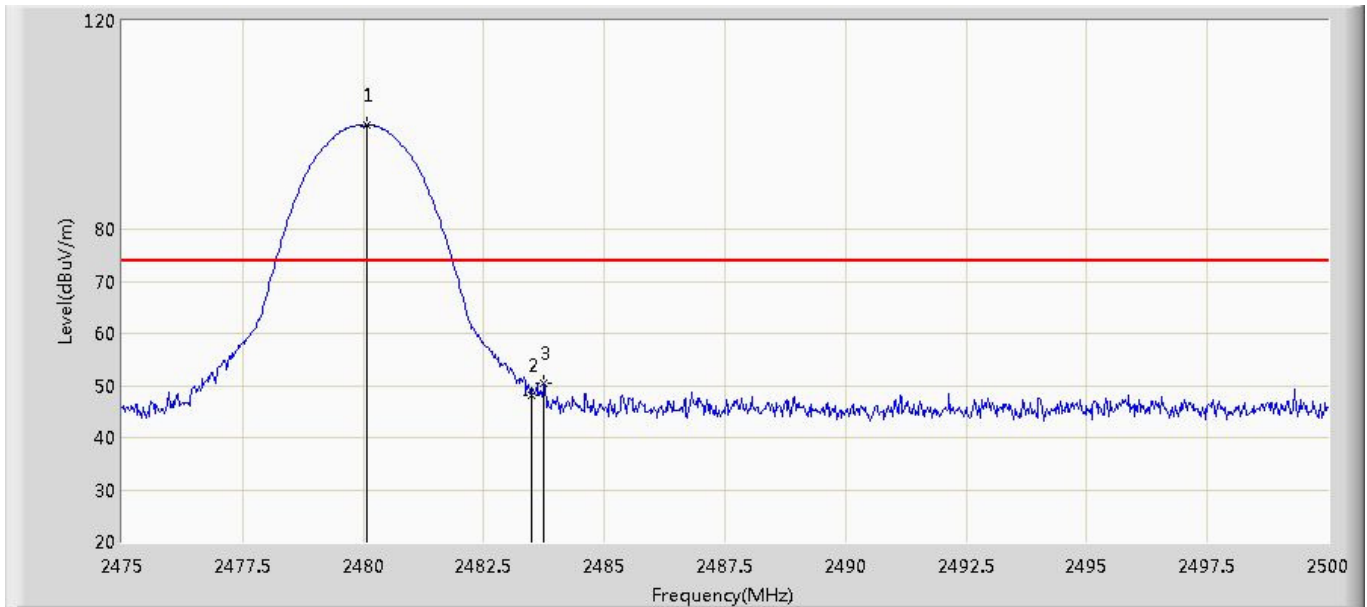

No	Mark	Frequency (MHz)	Measure Level (dBuV/m)	Reading Level (dBuV)	Over Limit (dB)	Limit (dBuV/m)	Factor (dB)	Type
1	*	2480.075	99.904	101.247	N/A	N/A	-1.343	PK
2		2483.500	48.133	49.464	-25.867	74.000	-1.331	PK
3		2483.750	50.303	51.633	-23.697	74.000	-1.330	PK

Note:

1. All Readings below 1GHz are Quasi-Peak, above are performed with peak and/or average measurements as necessary.
2. " * ", means this data is the worst emission level.
3. Measurement Level = Reading Level + Factor(Probe+Cable-Amp).



Engineer: Chris	
Site: AC102	Time: 2019/07/30 - 23:23
Limit: FCC_Part15.209_RE(3m)	Margin: 0
Probe: N/A	Polarity: Horizontal
EUT: Tablet	Power: AC 120V/60Hz
Note: BT-2DH5 2480MHz	

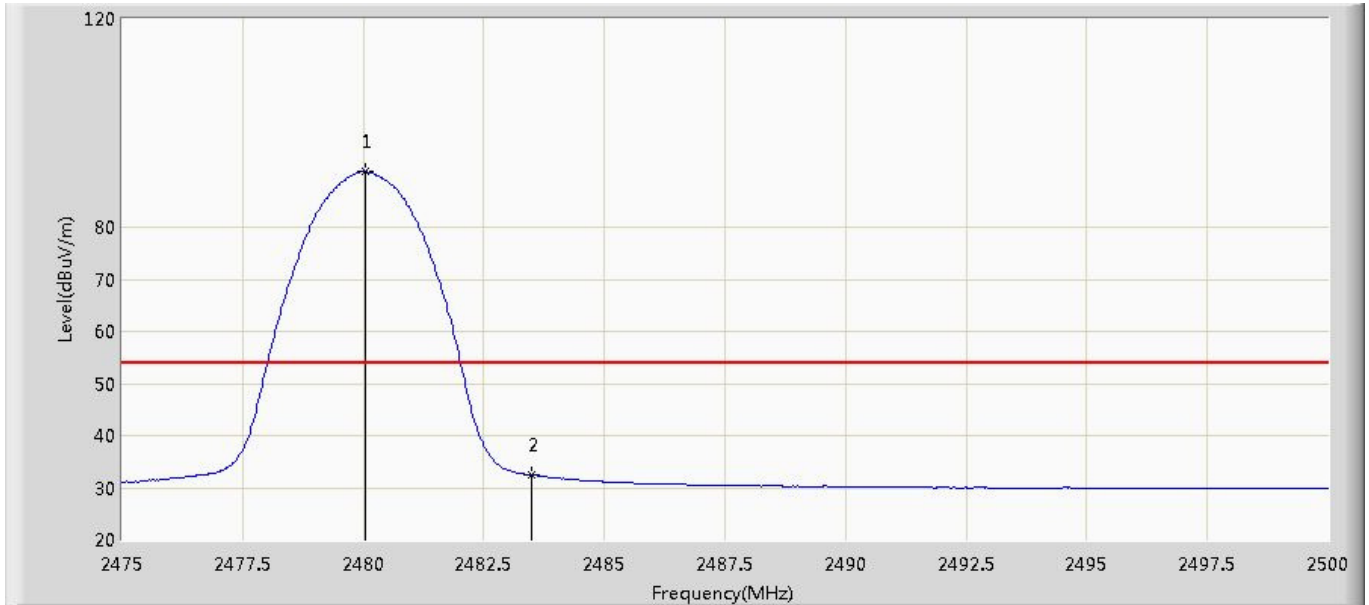

N o	Mar k	Frequency (MHz)	Measure Level (dBuV/m)	Reading Level (dBuV)	Over Limit (dB)	Limit (dBuV/m)	Factor (dB)	Type
1	*	2480.050	90.633	91.976	N/A	N/A	-1.343	AV
2		2483.500	32.430	33.761	-21.570	54.000	-1.331	AV

Note:

1. All Readings below 1GHz are Quasi-Peak, above are performed with peak and/or average measurements as necessary.
2. " * ", means this data is the worst emission level.
3. Measurement Level = Reading Level + Factor(Probe+Cable-Amp).



Engineer: Chris	
Site: AC102	Time: 2019/07/30 - 23:30
Limit: FCC_Part15.209_RE(3m)	Margin: 0
Probe: N/A	Polarity: Vertical
EUT: Tablet	Power: AC 120V/60Hz
Note: BT-2DH5 2480MHz	

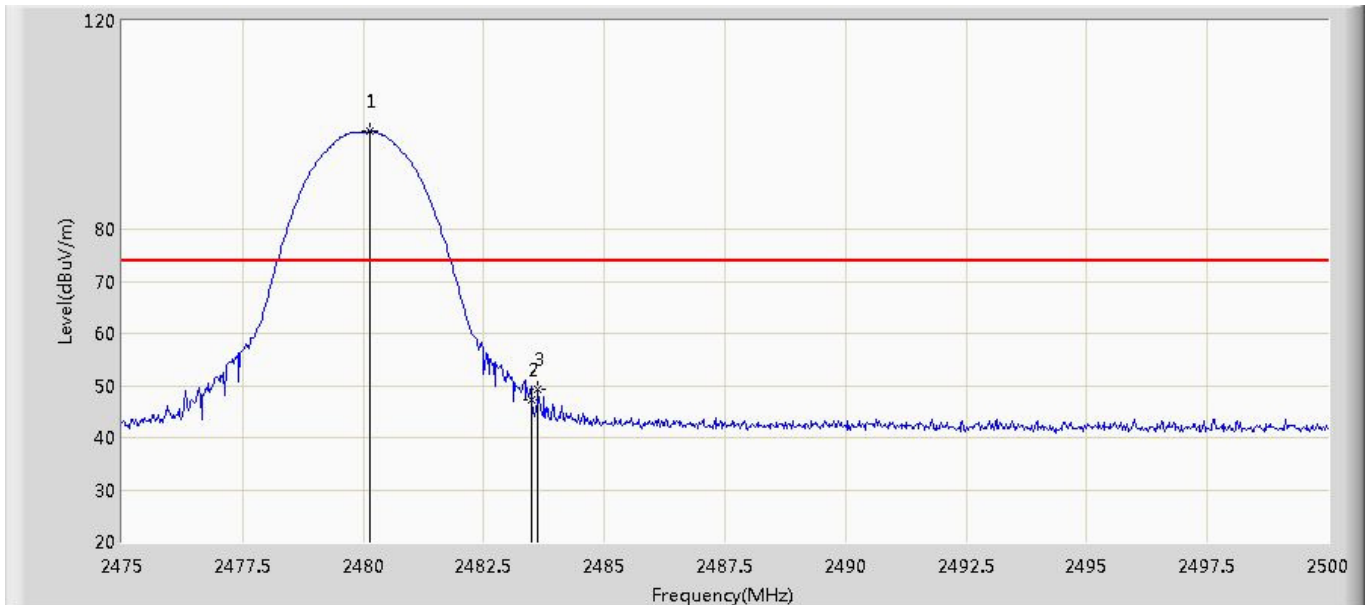

N o	Mar k	Frequency (MHz)	Measure Level (dBuV/m)	Reading Level (dBuV)	Over Limit (dB)	Limit (dBuV/m)	Factor (dB)	Type
1	*	2480.150	98.735	100.078	N/A	N/A	-1.343	PK
2		2483.500	47.373	48.704	-26.627	74.000	-1.331	PK
3		2483.625	49.234	50.564	-24.766	74.000	-1.330	PK

Note:

1. All Readings below 1GHz are Quasi-Peak, above are performed with peak and/or average measurements as necessary.
2. " * ", means this data is the worst emission level.
3. Measurement Level = Reading Level + Factor(Probe+Cable-Amp).



Engineer: Chris	
Site: AC102	Time: 2019/07/30 - 23:32
Limit: FCC_Part15.209_RE(3m)	Margin: 0
Probe: N/A	Polarity: Vertical
EUT: Tablet	Power: AC 120V/60Hz
Note: BT-2DH5 2480MHz	

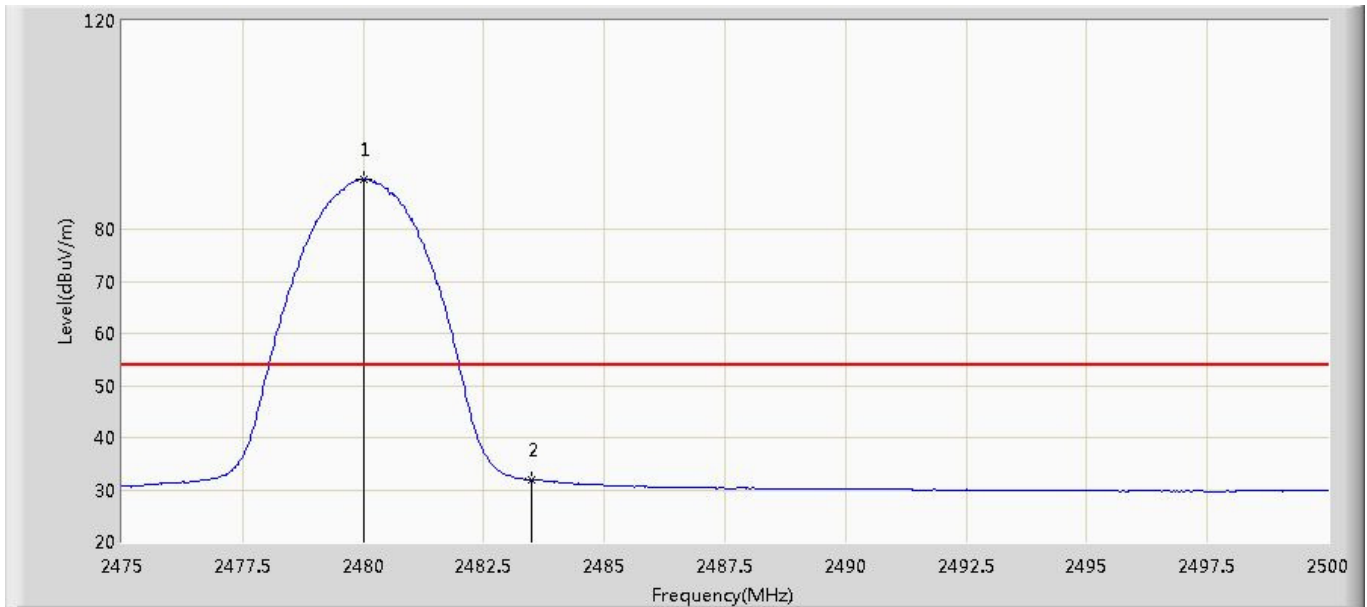

No	Mark	Frequency (MHz)	Measure Level (dBuV/m)	Reading Level (dBuV)	Over Limit (dB)	Limit (dBuV/m)	Factor (dB)	Type
1	*	2480.000	89.577	90.921	N/A	N/A	-1.344	AV
2		2483.500	31.879	33.210	-22.121	54.000	-1.331	AV

Note:

1. All Readings below 1GHz are Quasi-Peak, above are performed with peak and/or average measurements as necessary.
2. " * ", means this data is the worst emission level.
3. Measurement Level = Reading Level + Factor(Probe+Cable-Amp).



Engineer: Chris	
Site: AC102	Time: 2019/07/30 - 23:35
Limit: FCC_Part15.209_RE(3m)	Margin: 0
Probe: N/A	Polarity: Horizontal
EUT: Tablet	Power: AC 120V/60Hz
Note: BT-3DH5 2402MHz	

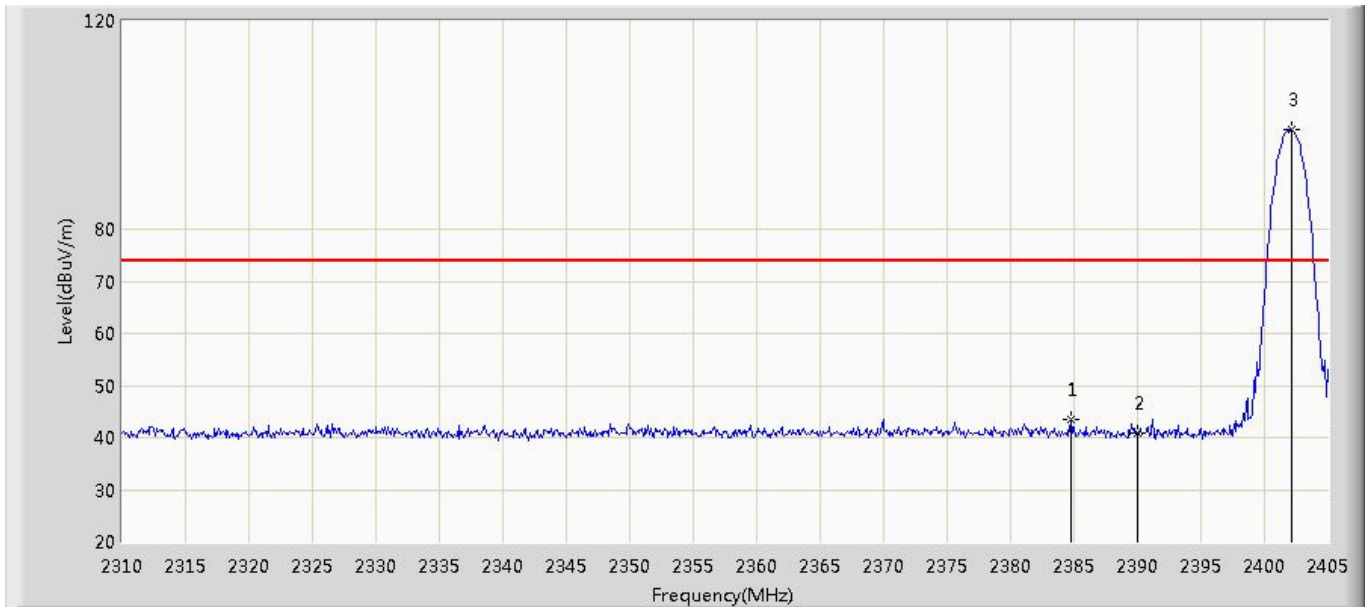

No	Mark	Frequency (MHz)	Measure Level (dBuV/m)	Reading Level (dBuV)	Over Limit (dB)	Limit (dBuV/m)	Factor (dB)	Type
1		2384.765	43.415	45.111	-30.585	74.000	-1.696	PK
2		2390.000	40.787	42.464	-33.213	74.000	-1.677	PK
3	*	2402.150	99.144	100.776	N/A	N/A	-1.632	PK

Note:

1. All Readings below 1GHz are Quasi-Peak, above are performed with peak and/or average measurements as necessary.
2. " * ", means this data is the worst emission level.
3. Measurement Level = Reading Level + Factor(Probe+Cable-Amp).



Engineer: Chris	
Site: AC102	Time: 2019/07/30 - 23:37
Limit: FCC_Part15.209_RE(3m)	Margin: 0
Probe: N/A	Polarity: Horizontal
EUT: Tablet	Power: AC 120V/60Hz
Note: BT-3DH5 2402MHz	

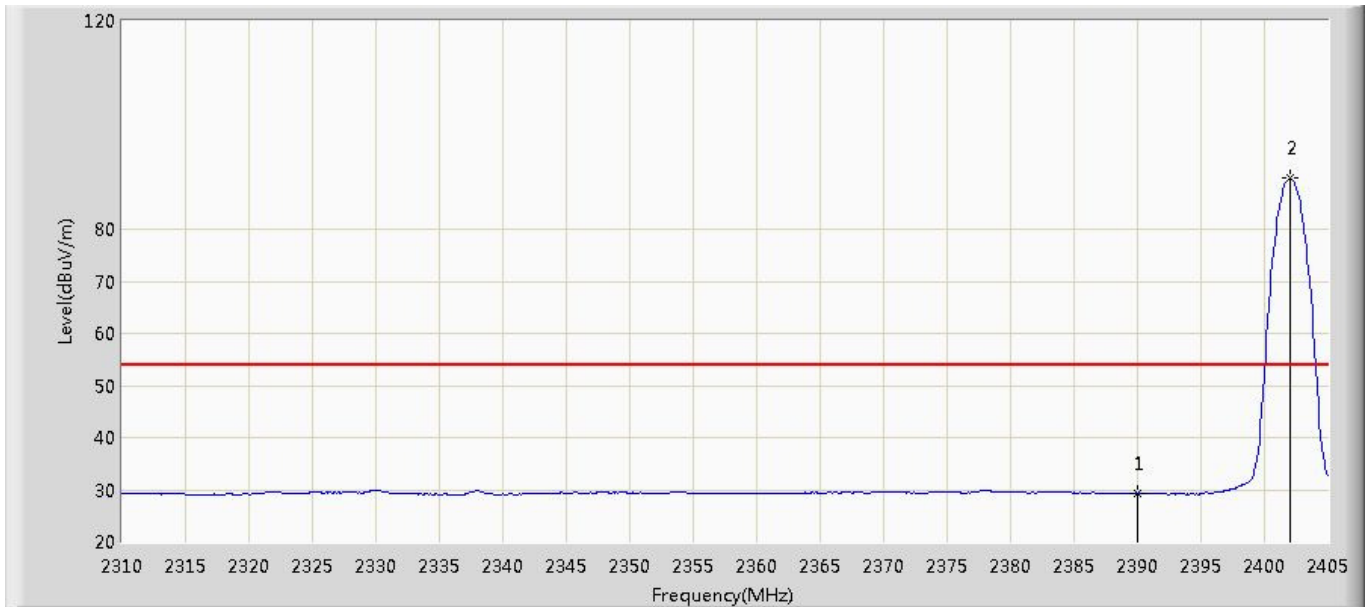

No	Mark	Frequency (MHz)	Measure Level (dBuV/m)	Reading Level (dBuV)	Over Limit (dB)	Limit (dBuV/m)	Factor (dB)	Type
1		2390.000	29.279	30.956	-24.721	54.000	-1.677	AV
2	*	2402.055	89.722	91.355	N/A	N/A	-1.633	AV

Note:

1. All Readings below 1GHz are Quasi-Peak, above are performed with peak and/or average measurements as necessary.
2. " * ", means this data is the worst emission level.
3. Measurement Level = Reading Level + Factor(Probe+Cable-Amp).



Engineer: Chris	
Site: AC102	Time: 2019/07/30 - 23:38
Limit: FCC_Part15.209_RE(3m)	Margin: 0
Probe: N/A	Polarity: Vertical
EUT: Tablet	Power: AC 120V/60Hz
Note: BT-3DH5 2402MHz	

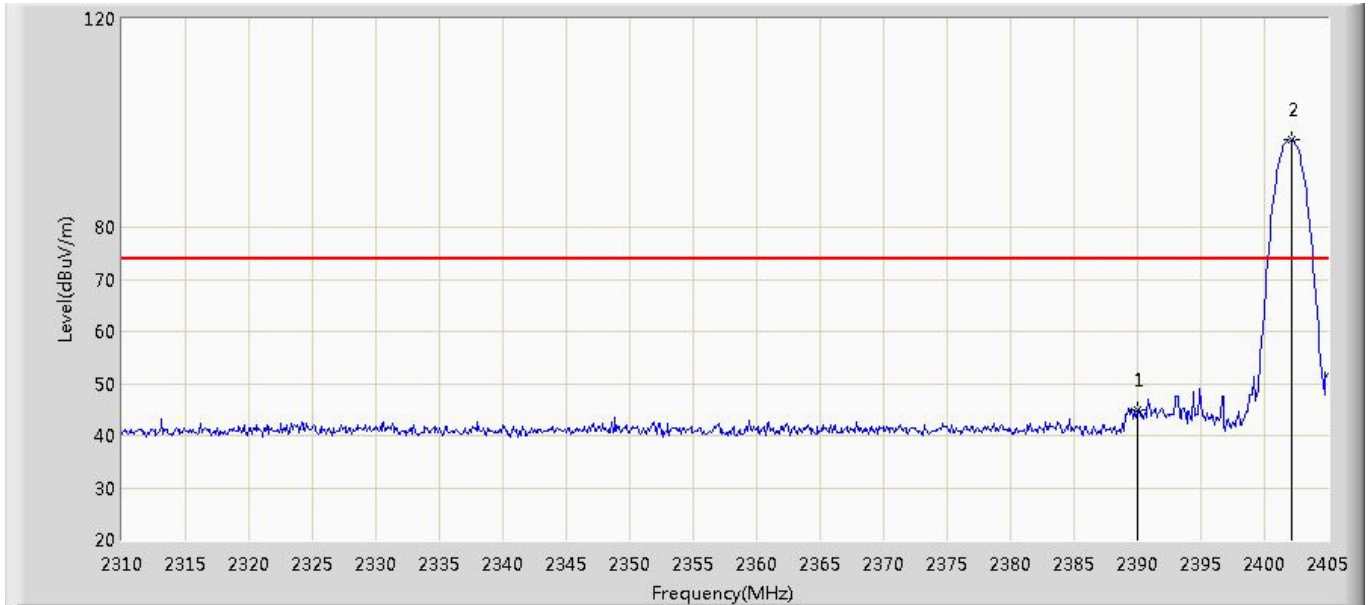

N o	Mar k	Frequency (MHz)	Measure Level (dBuV/m)	Reading Level (dBuV)	Over Limit (dB)	Limit (dBuV/m)	Factor (dB)	Type
1		2390.000	45.018	46.695	-28.982	74.000	-1.677	PK
2	*	2402.150	96.890	98.522	N/A	N/A	-1.632	PK

Note:

1. All Readings below 1GHz are Quasi-Peak, above are performed with peak and/or average measurements as necessary.
2. " * ", means this data is the worst emission level.
3. Measurement Level = Reading Level + Factor(Probe+Cable-Amp).



Engineer: Chris	
Site: AC102	Time: 2019/07/30 - 23:40
Limit: FCC_Part15.209_RE(3m)	Margin: 0
Probe: N/A	Polarity: Vertical
EUT: Tablet	Power: AC 120V/60Hz
Note: BT-3DH5 2402MHz	

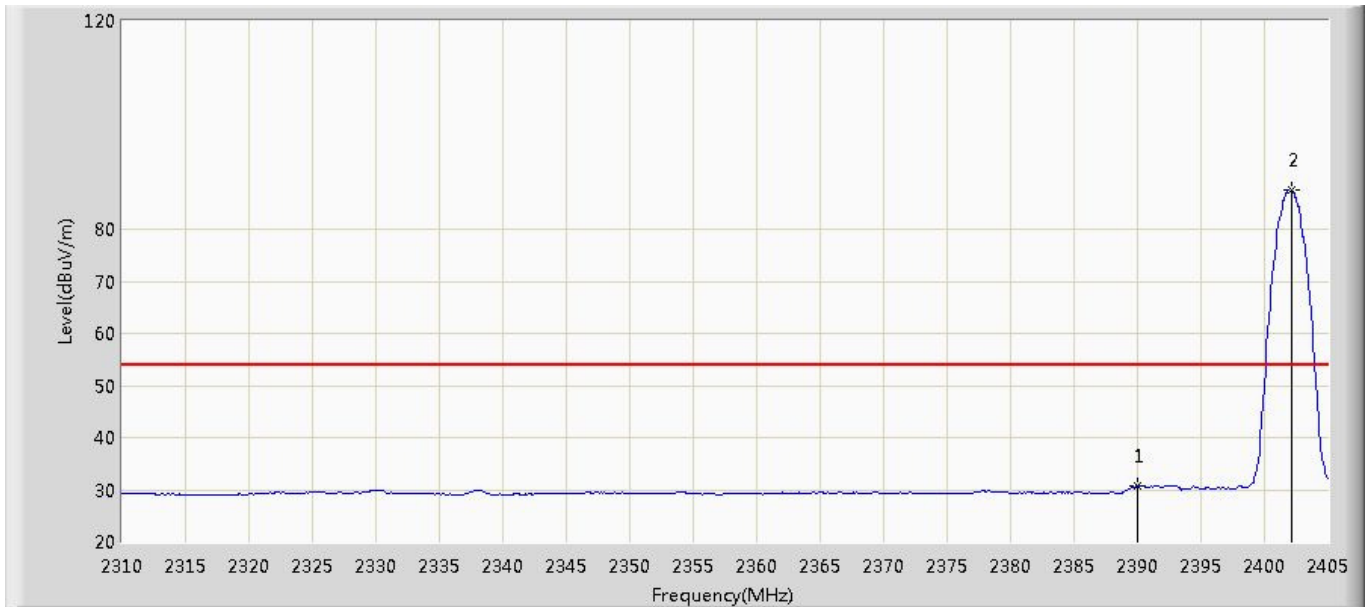

N o	Mar k	Frequency (MHz)	Measure Level (dBuV/m)	Reading Level (dBuV)	Over Limit (dB)	Limit (dBuV/m)	Factor (dB)	Type
1		2390.000	30.781	32.458	-23.219	54.000	-1.677	AV
2	*	2402.150	87.621	89.253	N/A	N/A	-1.632	AV

Note:

1. All Readings below 1GHz are Quasi-Peak, above are performed with peak and/or average measurements as necessary.
2. " * ", means this data is the worst emission level.
3. Measurement Level = Reading Level + Factor(Probe+Cable-Amp).



Engineer: Chris	
Site: AC102	Time: 2019/07/30 - 23:42
Limit: FCC_Part15.209_RE(3m)	Margin: 0
Probe: N/A	Polarity: Horizontal
EUT: Tablet	Power: AC 120V/60Hz
Note: BT-3DH5 2480MHz	

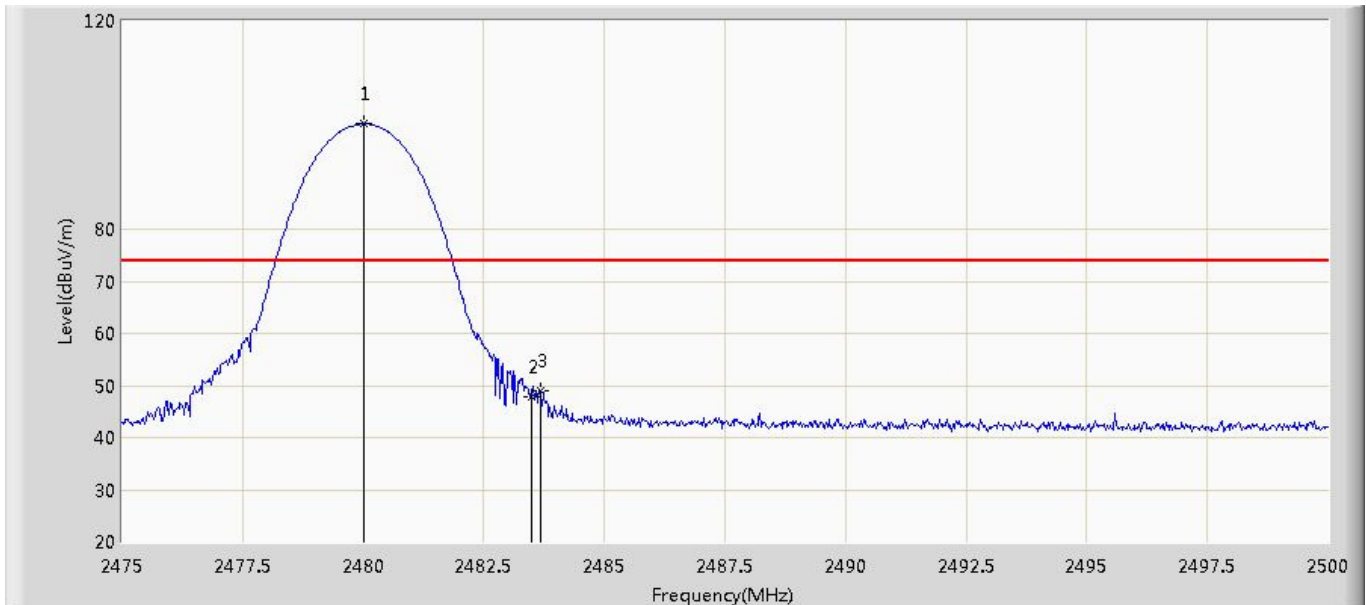

No	Mark	Frequency (MHz)	Measure Level (dBuV/m)	Reading Level (dBuV)	Over Limit (dB)	Limit (dBuV/m)	Factor (dB)	Type
1	*	2480.000	100.217	101.561	N/A	N/A	-1.344	PK
2		2483.500	47.727	49.058	-26.273	74.000	-1.331	PK
3		2483.675	49.008	50.338	-24.992	74.000	-1.330	PK

Note:

1. All Readings below 1GHz are Quasi-Peak, above are performed with peak and/or average measurements as necessary.
2. " * ", means this data is the worst emission level.
3. Measurement Level = Reading Level + Factor(Probe+Cable-Amp).



Engineer: Chris	
Site: AC102	Time: 2019/07/30 - 23:44
Limit: FCC_Part15.209_RE(3m)	Margin: 0
Probe: N/A	Polarity: Horizontal
EUT: Tablet	Power: AC 120V/60Hz
Note: BT-3DH5 2480MHz	

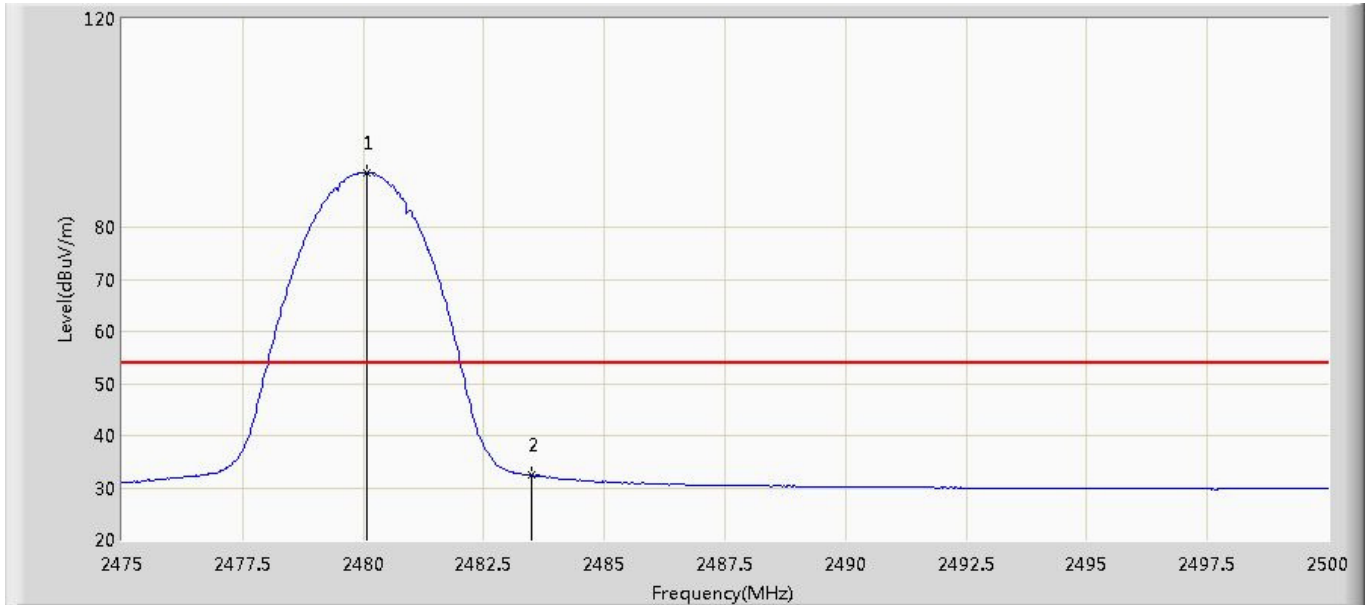

No	Mark	Frequency (MHz)	Measure Level (dBuV/m)	Reading Level (dBuV)	Over Limit (dB)	Limit (dBuV/m)	Factor (dB)	Type
1	*	2480.075	90.477	91.820	N/A	N/A	-1.343	AV
2		2483.500	32.327	33.658	-21.673	54.000	-1.331	AV

Note:

1. All Readings below 1GHz are Quasi-Peak, above are performed with peak and/or average measurements as necessary.
2. " * ", means this data is the worst emission level.
3. Measurement Level = Reading Level + Factor(Probe+Cable-Amp).



Engineer: Chris	
Site: AC102	Time: 2019/07/30 - 23:45
Limit: FCC_Part15.209_RE(3m)	Margin: 0
Probe: N/A	Polarity: Vertical
EUT: Tablet	Power: AC 120V/60Hz
Note: BT-3DH5 2480MHz	

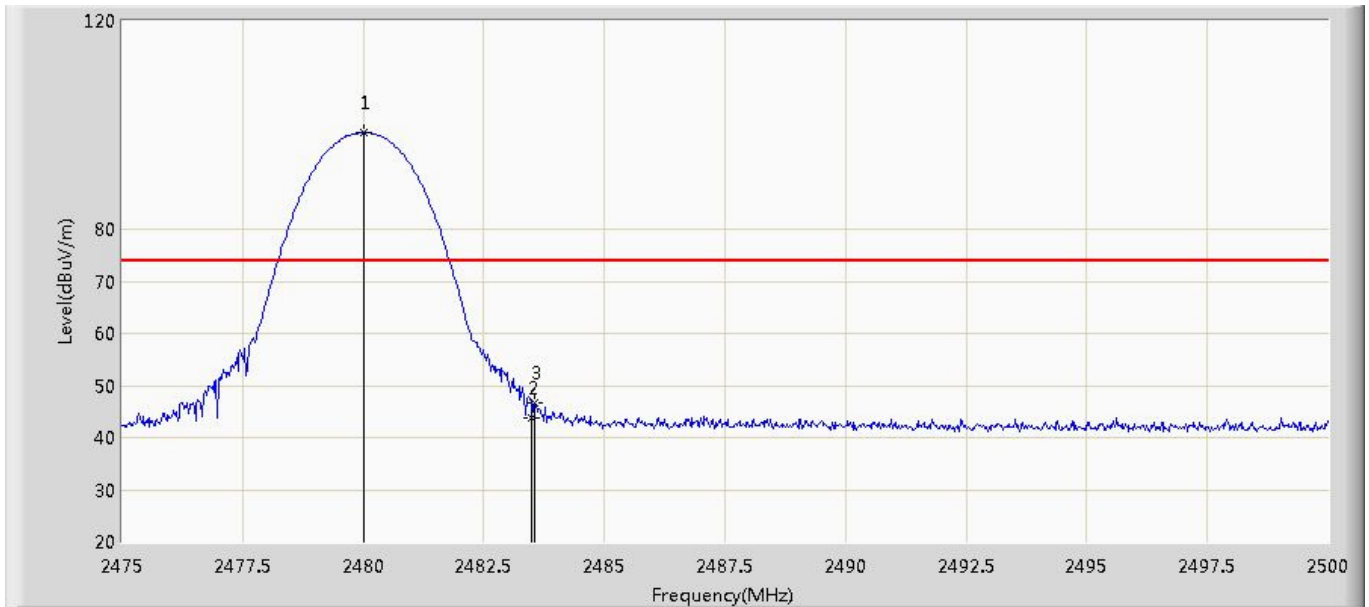

No	Mark	Frequency (MHz)	Measure Level (dBuV/m)	Reading Level (dBuV)	Over Limit (dB)	Limit (dBuV/m)	Factor (dB)	Type
1	*	2480.000	98.600	99.944	N/A	N/A	-1.344	PK
2		2483.500	43.747	45.078	-30.253	74.000	-1.331	PK
3		2483.550	46.568	47.898	-27.432	74.000	-1.330	PK

Note:

1. All Readings below 1GHz are Quasi-Peak, above are performed with peak and/or average measurements as necessary.
2. " * ", means this data is the worst emission level.
3. Measurement Level = Reading Level + Factor(Probe+Cable-Amp).



Engineer: Chris	
Site: AC102	Time: 2019/07/30 - 23:50
Limit: FCC_Part15.209_RE(3m)	Margin: 0
Probe: N/A	Polarity: Vertical
EUT: Tablet	Power: AC 120V/60Hz
Note: BT-3DH5 2480MHz	

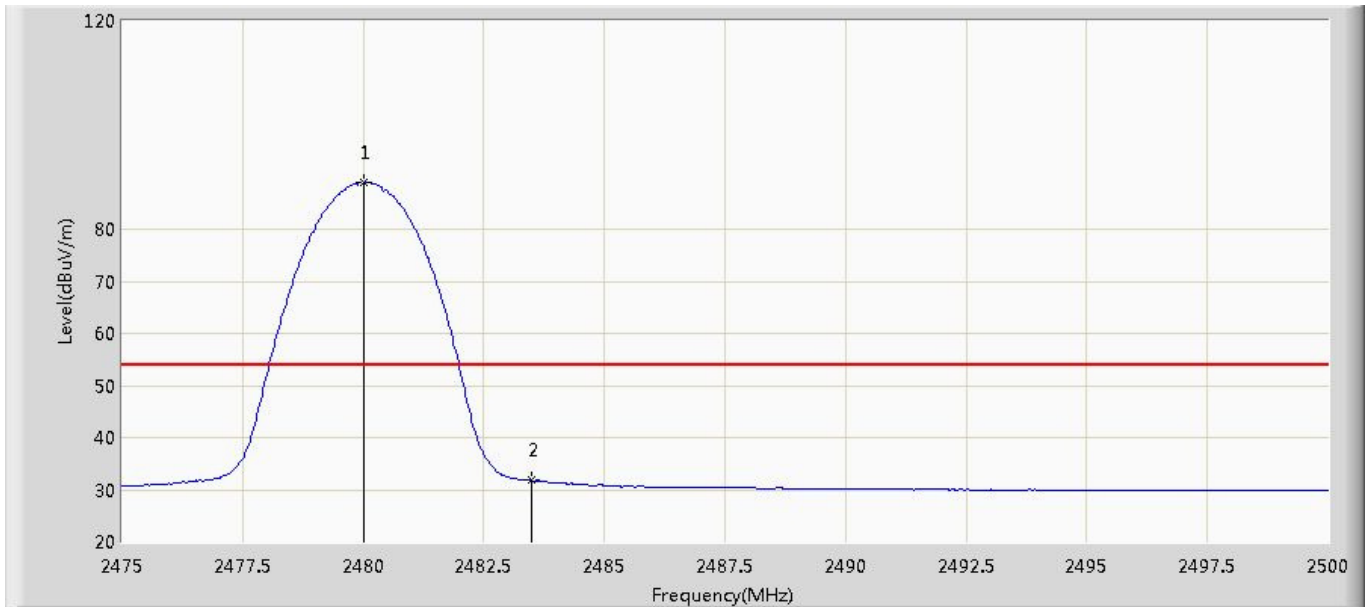

No	Mark	Frequency (MHz)	Measure Level (dBuV/m)	Reading Level (dBuV)	Over Limit (dB)	Limit (dBuV/m)	Factor (dB)	Type
1	*	2480.000	88.993	90.337	N/A	N/A	-1.344	AV
2		2483.500	31.783	33.114	-22.217	54.000	-1.331	AV

Note:

1. All Readings below 1GHz are Quasi-Peak, above are performed with peak and/or average measurements as necessary.
2. " * ", means this data is the worst emission level.
3. Measurement Level = Reading Level + Factor(Probe+Cable-Amp).

***** END OF REPORT *****