



# FCC RF Test Report

**APPLICANT** : MITAC International Corp  
**EQUIPMENT** : Tablet  
**BRAND NAME** : Mio, Mitac, Stryker  
**MODEL NAME** : N450  
**FCC ID** : P4Q-N450W  
**STANDARD** : FCC Part 15 Subpart C §15.247  
**CLASSIFICATION** : (DSS) Spread Spectrum Transmitter

The product was received on Dec. 25, 2015 and testing was completed on Jan. 19, 2016. We, SPORTON INTERNATIONAL INC., would like to declare that the tested sample has been evaluated in accordance with the test procedures and has been in compliance with the applicable technical standards.

The test results in this report apply exclusively to the tested model / sample. Without written approval of SPORTON INTERNATIONAL INC., the test report shall not be reproduced except in full.

Reviewed by: Joseph Lin / Supervisor

Approved by: Jones Tsai / Manager



## **SPORTON INTERNATIONAL INC.**

No. 52, Hwa Ya 1<sup>st</sup> Rd., Hwa Ya Technology Park, Kwei-Shan District, Tao Yuan City, Taiwan, R.O.C.



# TABLE OF CONTENTS

**REVISION HISTORY..... 3**

**SUMMARY OF TEST RESULT ..... 4**

**1 GENERAL DESCRIPTION..... 5**

1.1 Applicant ..... 5

1.2 Manufacturer..... 5

1.3 Product Feature of Equipment Under Test..... 5

1.4 Product Specification of Equipment Under Test..... 6

1.5 Modification of EUT ..... 6

1.6 Testing Location ..... 6

1.7 Applicable Standards..... 7

**2 TEST CONFIGURATION OF EQUIPMENT UNDER TEST..... 8**

2.1 Descriptions of Test Mode ..... 8

2.2 Test Mode..... 9

2.3 Connection Diagram of Test System..... 10

2.4 Support Unit used in test configuration and system ..... 11

2.5 EUT Operation Test Setup ..... 11

2.6 Measurement Results Explanation Example..... 12

**3 TEST RESULT ..... 13**

3.1 Number of Channel Measurement ..... 13

3.2 Hopping Channel Separation Measurement ..... 15

3.3 Dwell Time Measurement..... 22

3.4 20dB and 99% Bandwidth Measurement ..... 25

3.5 Peak Output Power Measurement ..... 38

3.6 Conducted Band Edges Measurement..... 40

3.7 Conducted Spurious Emission Measurement ..... 47

3.8 Radiated Band Edges and Spurious Emission Measurement ..... 57

3.9 AC Conducted Emission Measurement..... 63

3.10 Antenna Requirements..... 67

**4 LIST OF MEASURING EQUIPMENT..... 68**

**5 UNCERTAINTY OF EVALUATION..... 70**

**APPENDIX A. RADIATED SPURIOUS EMISSION**

**APPENDIX B. RADIATED SPURIOUS EMISSION PLOTS**

**APPENDIX C. SETUP PHOTOGRAPHS**



### REVISION HISTORY

REPORT NO.	VERSION	DESCRIPTION	ISSUED DATE
FR5D2503A	Rev. 01	Initial issue of report	Feb. 24, 2016



### SUMMARY OF TEST RESULT

Report Section	FCC Rule	Description	Limit	Result	Remark
3.1	15.247(a)(1)	Number of Channels	≥ 15Chs	Pass	-
3.2	15.247(a)(1)	Hopping Channel Separation	≥ 2/3 of 20dB BW	Pass	-
3.3	15.247(a)(1)	Dwell Time of Each Channel	≤ 0.4sec in 31.6sec period	Pass	-
3.4	15.247(a)(1)	20dB Bandwidth	NA	Pass	-
3.4	-	99% Bandwidth	-	Pass	-
3.5	15.247(b)(1)	Peak Output Power	≤ 125 mW	Pass	-
3.6	15.247(d)	Conducted Band Edges	≤ 20dBc	Pass	-
3.7	15.247(d)	Conducted Spurious Emission	≤ 20dBc	Pass	-
3.8	15.247(d)	Radiated Band Edges and Radiated Spurious Emission	15.209(a) & 15.247(d)	Pass	Under limit 5.25 dB at 38.370 MHz
3.9	15.207	AC Conducted Emission	15.207(a)	Pass	Under limit 7.00 dB at 0.454 MHz
3.10	15.203 & 15.247(b)	Antenna Requirement	N/A	Pass	-



# 1 General Description

## 1.1 Applicant

**MITAC International Corp**

Building B, No. 209, Sec.1, Nan Gang Rd., Nan Gang Dist., Taipei City 11568, Taiwan, R.O.C.

## 1.2 Manufacturer

**MITAC Computer (Kunshan) Co., Ltd.**

No. 269, 2nd Avenue, District A, Comprehensive Free Trade Zone, 300 Kunshan, China

## 1.3 Product Feature of Equipment Under Test

Product Feature	
Equipment	Tablet
Brand Name	Mio, Mitac, Stryker
Model Name	N450
FCC ID	P4Q-N450W
EUT supports Radios application	NFC WLAN 11a/b/g/n HT20/HT40 Bluetooth v4.0 EDR/LE
EUT Stage	Production Unit

**Remark:** The above EUT's information was declared by manufacturer. Please refer to the specifications or user's manual for more detailed description.



### 1.4 Product Specification of Equipment Under Test

Standards-related Product Specification	
<b>Tx/Rx Frequency Range</b>	2402 MHz ~ 2480 MHz
<b>Number of Channels</b>	79
<b>Carrier Frequency of Each Channel</b>	2402+n*1 MHz; n=0~78
<b>Maximum Output Power to Antenna</b>	Bluetooth BR(1Mbps) : 2.20 dBm (0.0017 W) Bluetooth EDR (2Mbps) : -2.70 dBm (0.0005 W) Bluetooth EDR (3Mbps) : -2.66 dBm (0.0005 W)
<b>99% Occupied Bandwidth</b>	Bluetooth BR(1Mbps) : 0.816MHz Bluetooth EDR (2Mbps) : 1.176MHz Bluetooth EDR (3Mbps) : 1.160MHz
<b>Antenna Type</b>	PIFA Antenna type with gain 2.30 dBi
<b>Type of Modulation</b>	Bluetooth BR (1Mbps) : GFSK Bluetooth EDR (2Mbps) : $\pi/4$ -DQPSK Bluetooth EDR (3Mbps) : 8-DPSK

### 1.5 Modification of EUT

No modifications are made to the EUT during all test items.

### 1.6 Testing Location

Sporton Lab is accredited to ISO 17025 by Taiwan Accreditation Foundation (TAF code : 1190) and the FCC designation No. TW1022 under the FCC 2.948(e) by Mutual Recognition Agreement (MRA) in FCC Test.

<b>Test Site</b>	SPORTON INTERNATIONAL INC.		
<b>Test Site Location</b>	No. 52, Hwa Ya 1 <sup>st</sup> Rd., Hwa Ya Technology Park, Kwei-Shan District, Tao Yuan City, Taiwan, R.O.C. TEL: +886-3-327-3456 FAX: +886-3-328-4978		
<b>Test Site No.</b>	<b>Sporton Site No.</b>		
	TH05-HY	CO05-HY	03CH07-HY

**Note:** The test site complies with ANSI C63.4 2014 requirement.



## 1.7 Applicable Standards

According to the specifications of the manufacturer, the EUT must comply with the requirements of the following standards:

- ♦ FCC Part 15 Subpart C §15.247
- ♦ ANSI C63.10-2013

**Remark:**

1. All test items were verified and recorded according to the standards and without any deviation during the test.
2. This EUT has also been tested and complied with the requirements of FCC Part 15, Subpart B, recorded in a separate test report



## 2 Test Configuration of Equipment Under Test

### 2.1 Descriptions of Test Mode

Preliminary tests were performed in different data rates and recorded the RF output power in the following table:

Channel	Frequency	Bluetooth RF Output Power		
		Data Rate / Modulation		
		GFSK	$\pi/4$ -DQPSK	8-DPSK
		1Mbps	2Mbps	3Mbps
Ch00	2402MHz	1.10 dBm	-3.41 dBm	-3.32 dBm
Ch39	2441MHz	1.29 dBm	-3.18 dBm	-3.18 dBm
Ch78	2480MHz	2.20 dBm	-2.70 dBm	-2.66 dBm

**Remark:**

1. All the test data for each data rate were verified, but only the worst case was reported.
  2. The data rate was set in 1Mbps for all the test items due to the highest RF output power.
- a. The EUT has been associated with peripherals and configuration operated in a manner tended to maximize its emission characteristics in a typical application. Frequency range investigated: conduction (150 kHz to 30 MHz), radiation (9 kHz to the 10th harmonic of the highest fundamental frequency or to 40 GHz, whichever is lower). Pre-scanned tests, X, Y, Z in three orthogonal panels, and different data rates were conducted to determine the final configuration (X plane as worst plane) from all possible combinations, and the worst mode of radiated spurious emissions is Bluetooth 1Mbps mode, and recorded in this report.
- b. AC power line Conducted Emission was tested under maximum output power.





## 2.2 Test Mode

The following summary table is showing all test modes to demonstrate in compliance with the standard.

Summary table of Test Cases			
Test Item	Data Rate / Modulation		
	Bluetooth BR 1Mbps GFSK	Bluetooth EDR 2Mbps $\pi/4$ -DQPSK	Bluetooth EDR 3Mbps 8-DPSK
Conducted Test Cases	Mode 1: CH00_2402 MHz	Mode 4: CH00_2402 MHz	Mode 7: CH00_2402 MHz
	Mode 2: CH39_2441 MHz	Mode 5: CH39_2441 MHz	Mode 8: CH39_2441 MHz
	Mode 3: CH78_2480 MHz	Mode 6: CH78_2480 MHz	Mode 9: CH78_2480 MHz
Radiated Test Cases	Bluetooth BR 1Mbps GFSK		
	Mode 1: CH00_2402 MHz Mode 2: CH39_2441 MHz Mode 3: CH78_2480 MHz		
AC Conducted Emission	Mode 1 :WLAN (2.4GHz) Link + Bluetooth Link + Camera (Rear) + USB HDD + Adapter + Micro SD + Micro USB Cable ( Data Link with Notebook) + Battery + Earphone		
<b>Remark:</b> For radiated test cases, the worst mode data rate 1Mbps was reported only, because this data rate has the highest RF output power at preliminary tests, and the conducted spurious emissions and conducted band edge measurement for each data rate are no worse than 1Mbps, and no other significantly frequencies found in conducted spurious emission.			

## 2.3 Connection Diagram of Test System

<Bluetooth Tx Mode>

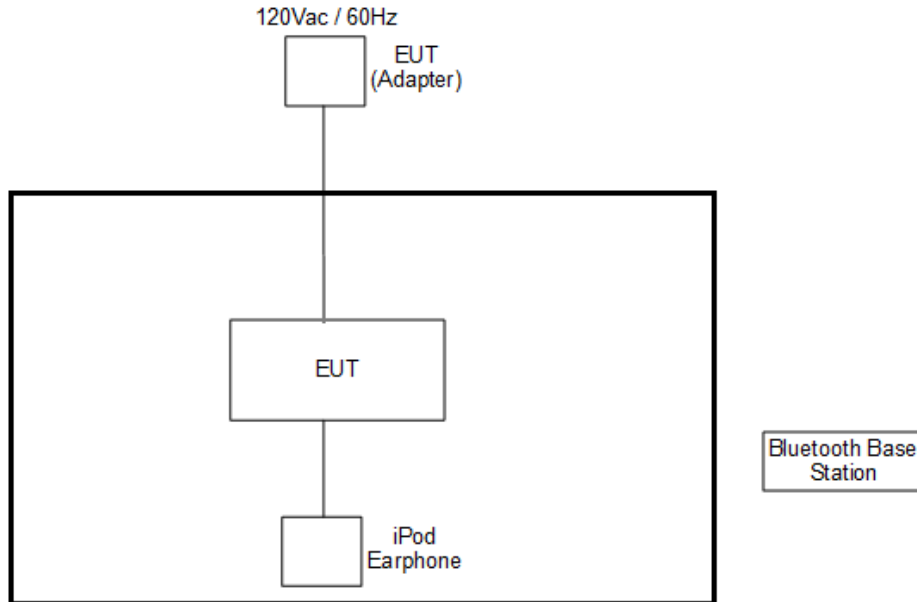

<AC Conducted Emission Mode>

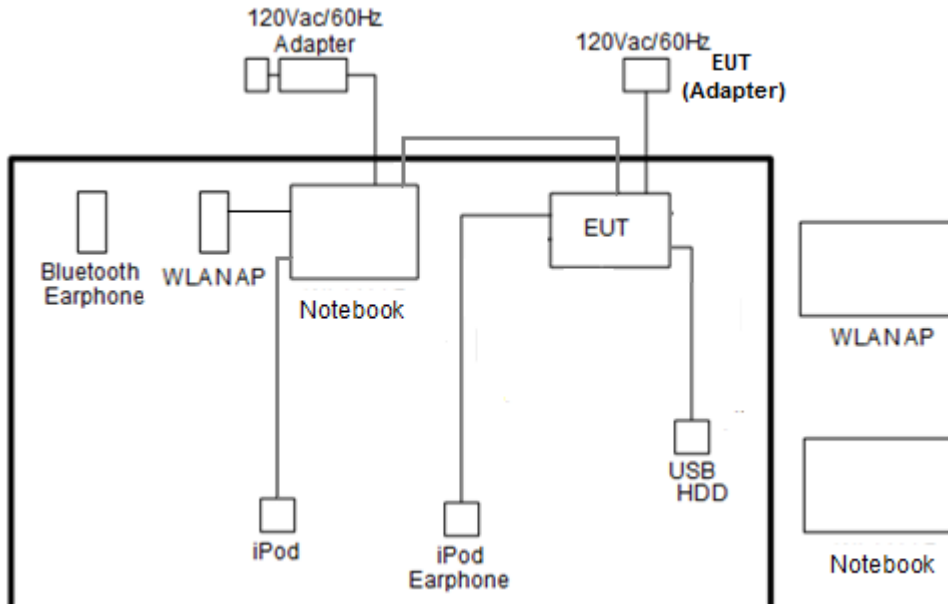



## 2.4 Support Unit used in test configuration and system

Item	Equipment	Trade Name	Model Name	FCC ID	Data Cable	Power Cord
1.	WLAN AP	D-Link	DIR-865L	KA2IR865LA1	N/A	Unshielded, 1.8 m
2.	Bluetooth Base Station	R&S	CBT32	N/A	N/A	Unshielded, 1.8 m
3.	Notebook	DELL	Latitude E6320	FCC DoC/ Contains FCC ID: QDS-BRCM1054	N/A	AC I/P: Unshielded, 1.2 m DC O/P: Shielded, 1.8 m
4.	Notebook	DELL	P20G	FCC DoC/ Contains FCC ID: QDS-BRCM1051	N/A	AC I/P: Unshielded, 1.2 m DC O/P: Shielded, 1.8 m
5.	Bluetooth Earphone	Sony Ericsson	MW600	PY7DDA-2029	N/A	N/A
6.	iPod	Apple	A1285	FCC DoC	Shielded, 1.0 m	N/A
7.	iPod Earphone	Apple	N/A	Verification	Unshielded, 1.0 m	N/A
8.	USB HDD	PQI	H568V	FCC DoC	Shielded, 0.45 m	N/A
9.	SD Card	SanDisk	MicroSD HC	FCC DoC	N/A	N/A

## 2.5 EUT Operation Test Setup

For Bluetooth function, programmed RF utility, “Putty” installed in the notebook make the EUT provide functions like channel selection and power level for continuous transmitting and receiving signals.



## 2.6 Measurement Results Explanation Example

For all conducted test items:

The offset level is set in the spectrum analyzer to compensate the RF cable loss and attenuator factor between EUT conducted output port and spectrum analyzer. With the offset compensation, the spectrum analyzer reading level is exactly the EUT RF output level.

Example:

The spectrum analyzer offset is derived from RF cable loss and attenuator factor.

*Offset = RF cable loss + attenuator factor.*

Following shows an offset computation example with cable loss 4.2 dB and 10dB attenuator.

$$\begin{aligned} \text{Offset(dB)} &= \text{RF cable loss(dB)} + \text{attenuator factor(dB)}. \\ &= 4.2 + 10 = 14.2 \text{ (dB)} \end{aligned}$$

### 3 Test Result

#### 3.1 Number of Channel Measurement

##### 3.1.1 Limits of Number of Hopping Frequency

Frequency hopping systems in the 2400-2483.5 MHz band shall use at least 15 channels.

##### 3.1.2 Measuring Instruments

The measuring equipment is listed in the section 4 of this test report.

##### 3.1.3 Test Procedure

1. The testing follows ANSI C63.10-2013 clause 7.8.3.
2. The RF output of EUT was connected to the spectrum analyzer by RF cable and attenuator. The path loss was compensated to the results for each measurement.
3. Set to the maximum power setting and enable the EUT transmit continuously.
4. Enable the EUT hopping function.
5. Use the following spectrum analyzer settings: Span = the frequency band of operation; RBW = 300kHz; VBW  $\geq$  RBW; Sweep = auto; Detector function = peak; Trace = max hold.
6. The number of hopping frequency used is defined as the number of total channel.
7. Record the measurement data derived from spectrum analyzer.

##### 3.1.4 Test Setup

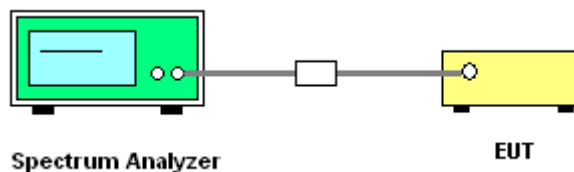

##### 3.1.5 Test Result of Number of Hopping Frequency

<b>Test Mode :</b>	1Mbps	<b>Temperature :</b>	24~26°C
<b>Test Engineer :</b>	Luffy Lin and Osolemio Chang	<b>Relative Humidity :</b>	48~51%
<b>Number of Hopping (Channel)</b>	<b>Adaptive Frequency Hopping (Channel)</b>	<b>Limits (Channel)</b>	<b>Pass/Fail</b>
79	20	> 15	Pass



Number of Hopping Channel Plot on Channel 00 - 78

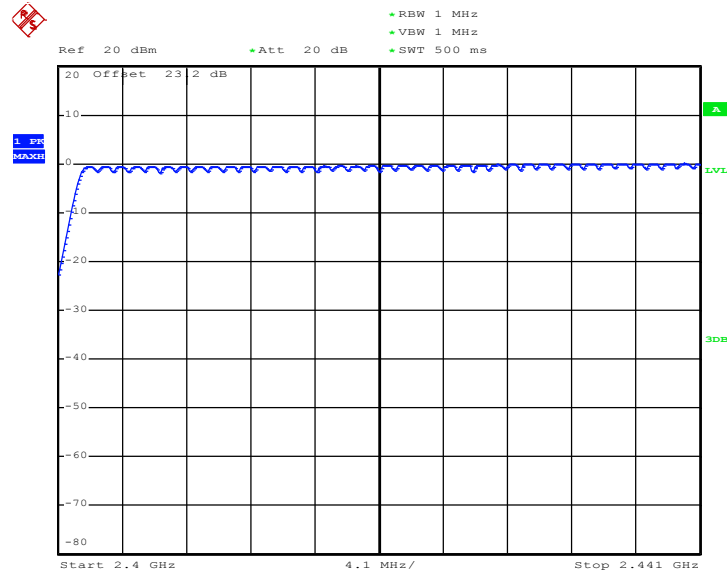

Date: 6.JAN.2016 01:31:50

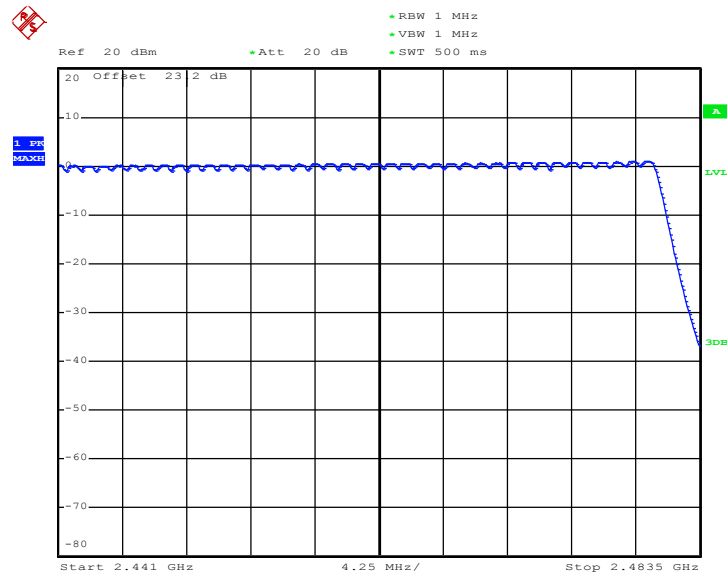

Date: 6.JAN.2016 01:32:24

## 3.2 Hopping Channel Separation Measurement

### 3.2.1 Limit of Hopping Channel Separation

Frequency hopping systems operating in the 2400-2483.5 MHz band may have hopping channel carrier frequencies that are separated by 25 kHz or two-thirds of the 20 dB bandwidth of the hopping channel, whichever is greater.

### 3.2.2 Measuring Instruments

The measuring equipment is listed in the section 4 of this test report.

### 3.2.3 Test Procedures

1. The testing follows ANSI C63.10-2013 clause 7.8.2.
2. The RF output of EUT was connected to the spectrum analyzer by RF cable and attenuator. The path loss was compensated to the results for each measurement.
3. Set to the maximum power setting and enable the EUT transmit continuously.
4. Enable the EUT hopping function.
5. Use the following spectrum analyzer settings:  
Span = wide enough to capture the peaks of two adjacent channels;  
RBW = 300kHz; VBW  $\geq$  RBW; Sweep = auto; Detector function = peak; Trace = max hold.
6. Measure and record the results in the test report.

### 3.2.4 Test Setup





3.2.5 Test Result of Hopping Channel Separation

Test Mode :	1Mbps	Temperature :	24~26°C
Test Engineer :	Luffy Lin and Osolemio Chang	Relative Humidity :	48~51%

Channel	Frequency (MHz)	Frequency Separation (MHz)	(2/3 of 20dB BW) Limits (MHz)	Pass/Fail
00	2402	1.002	0.5699	Pass
39	2441	1.002	0.5591	Pass
78	2480	1.002	0.5699	Pass

Channel Separation Plot on Channel 00 - 01

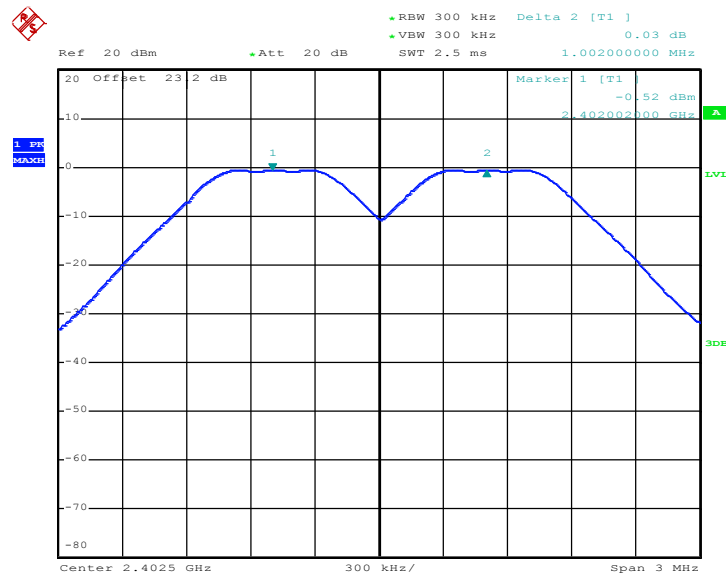

Date: 6.JAN.2016 00:29:39





Channel Separation Plot on Channel 39 - 40

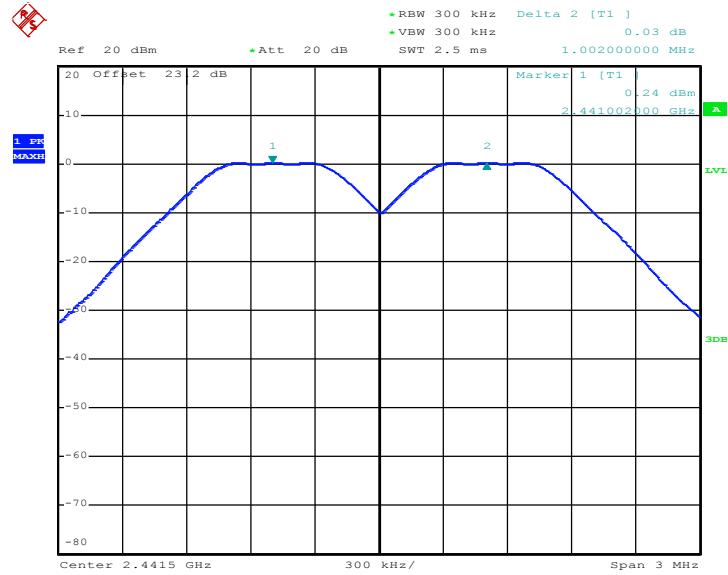

Date: 6.JAN.2016 00:31:04

Channel Separation Plot on Channel 77 - 78

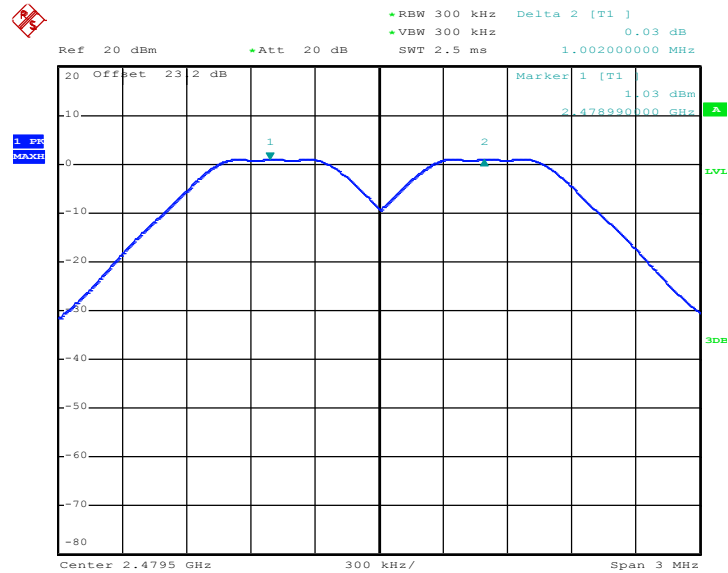

Date: 6.JAN.2016 00:32:26



Test Mode :	2Mbps	Temperature :	24~26°C
Test Engineer :	Luffy Lin and Osolemio Chang	Relative Humidity :	48~51%

Channel	Frequency (MHz)	Frequency Separation (MHz)	(2/3 of 20dB BW) Limits (MHz)	Pass/Fail
00	2402	1.002	0.8400	Pass
39	2441	1.008	0.8400	Pass
78	2480	1.002	0.8400	Pass

Channel Separation Plot on Channel 00 - 01

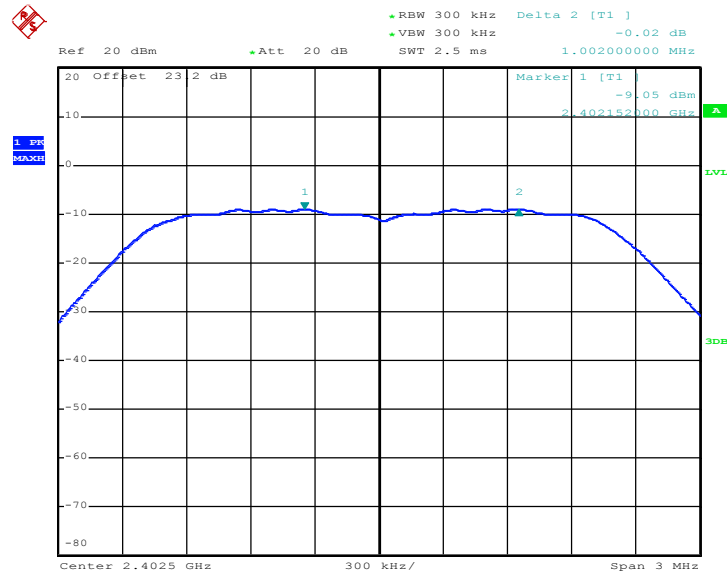

Date: 6.JAN.2016 00:34:11



Channel Separation Plot on Channel 39 - 40

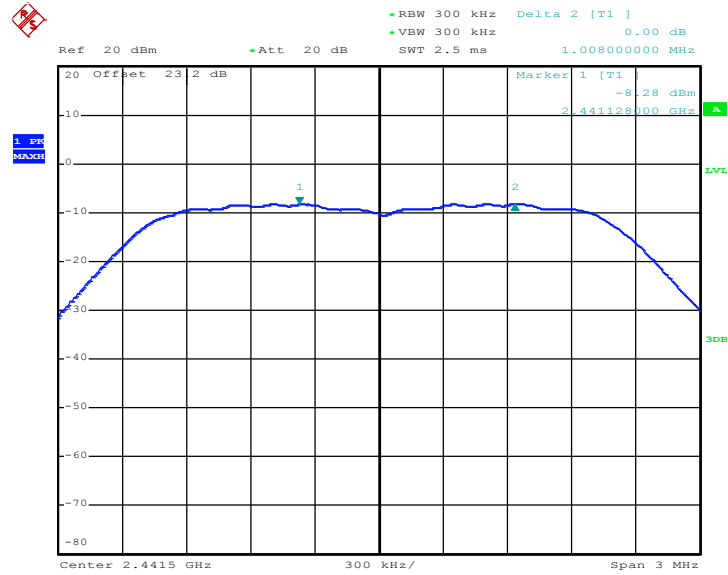

Date: 6.JAN.2016 00:37:14

Channel Separation Plot on Channel 77 - 78

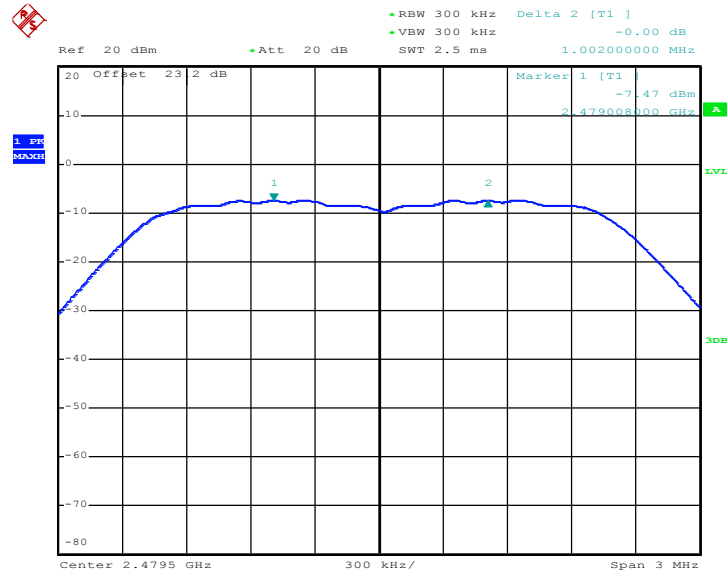

Date: 6.JAN.2016 00:39:01



Test Mode :	3Mbps	Temperature :	24~26°C
Test Engineer :	Luffy Lin and Osolemio Chang	Relative Humidity :	48~51%

Channel	Frequency (MHz)	Frequency Separation (MHz)	(2/3 of 20dB BW) Limits (MHz)	Pass/Fail
00	2402	1.002	0.8160	Pass
39	2441	1.002	0.8200	Pass
78	2480	1.002	0.8300	Pass

Channel Separation Plot on Channel 00 - 01

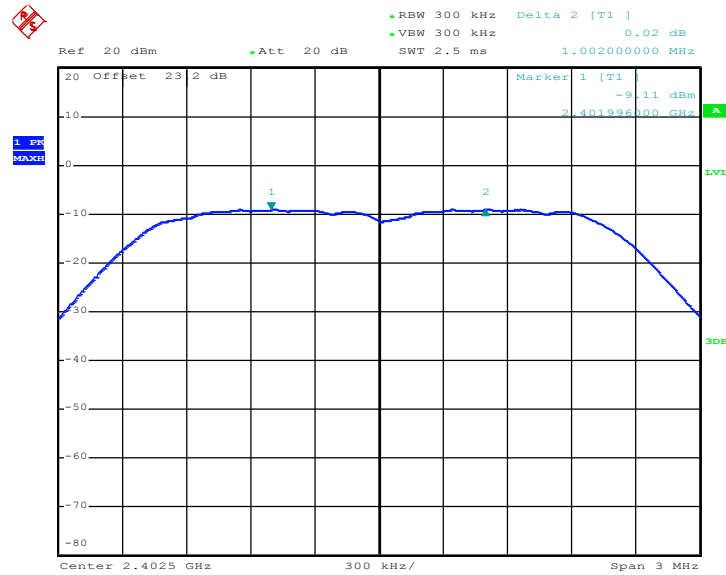

Date: 6.JAN.2016 00:40:48



### Channel Separation Plot on Channel 39 - 40

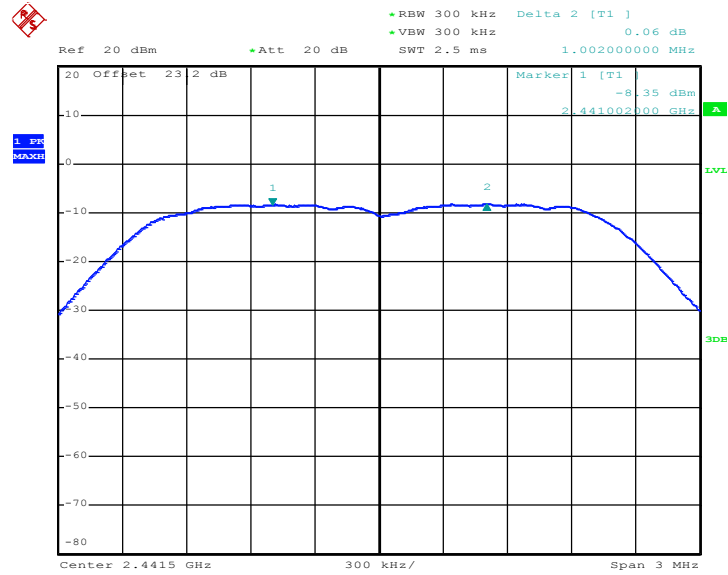

Date: 6.JAN.2016 00:42:43

### Channel Separation Plot on Channel 77 - 78

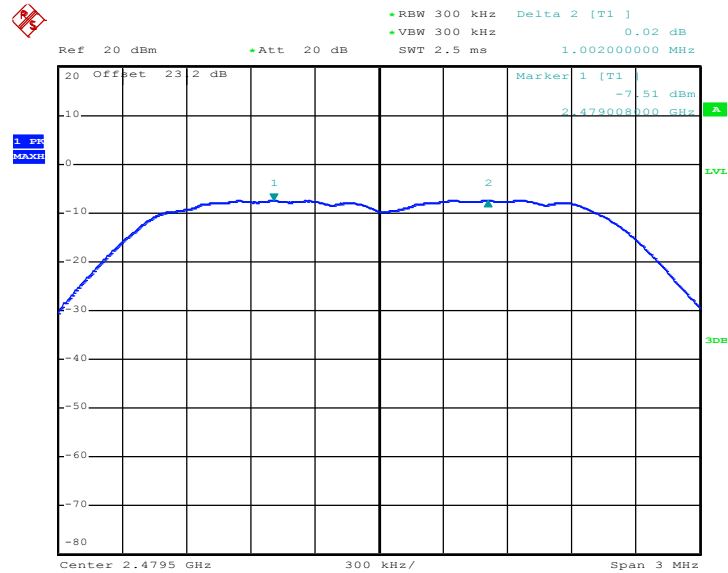

Date: 6.JAN.2016 00:43:51

### 3.3 Dwell Time Measurement

#### 3.3.1 Limit of Dwell Time

The average time of occupancy on any channel shall not be greater than 0.4 seconds within a period of 0.4 seconds multiplied by the number of hopping channels employed.

#### 3.3.2 Measuring Instruments

The measuring equipment is listed in the section 4 of this test report.

#### 3.3.3 Test Procedures

1. The testing follows ANSI C63.10-2013 clause 7.8.4.
2. The RF output of EUT was connected to the spectrum analyzer by RF cable and attenuator. The path loss was compensated to the results for each measurement.
3. Set to the maximum power setting and enable the EUT transmit continuously.
4. Enable the EUT hopping function.
5. Use the following spectrum analyzer settings: Span = zero span, centered on a hopping channel; RBW = 1 MHz; VBW  $\geq$  RBW; Sweep = as necessary to capture the entire dwell time per hopping channel; Detector function = peak; Trace = max hold.
6. Measure and record the results in the test report.

#### 3.3.4 Test Setup





3.3.5 Test Result of Dwell Time

Test Mode :	DH5	Temperature :	24~26°C
Test Engineer :	Luffy Lin and Osolemio Chang	Relative Humidity :	48~51%

Mode	Hopping Channel Number	Hops Over Occupancy Time(hops)	Package Transfer Time (msec)	Dwell Time (sec)	Limits (sec)	Pass/Fail
Normal	79	106.67	2.92	0.31	0.4	Pass
AFH	20	53.34	2.92	0.16	0.4	Pass

Remark:

- In normal mode, hopping rate is 1600 hops/s with 6 slots in 79 hopping channels.  
With channel hopping rate (1600 / 6 / 79) in Occupancy Time Limit (0.4 x 79) (s),  
Hops Over Occupancy Time comes to (1600 / 6 / 79) x (0.4 x 79) = 106.67 hops.
- In AFH mode, hopping rate is 800 hops/s with 6 slots in 20 hopping channels.  
With channel hopping rate (800 / 6 / 20) in Occupancy Time Limit (0.4 x 20) (s),  
Hops Over Occupancy Time comes to (800 / 6 / 20) x (0.4 x 20) = 53.33 hops.
- Dwell Time(s) = Hops Over Occupancy Time (hops) x Package Transfer Time



Package Transfer Time Plot

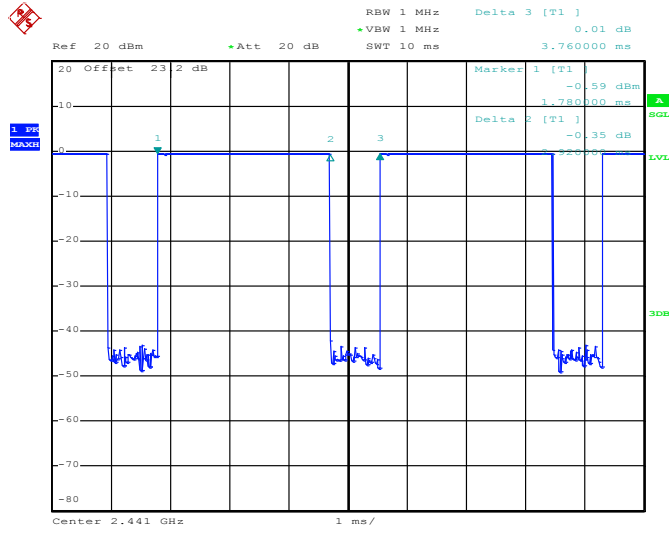

Date: 4.JAN.2016 20:58:16



## 3.4 20dB and 99% Bandwidth Measurement

### 3.4.1 Limit of 20dB and 99% Bandwidth

Reporting only

### 3.4.2 Measuring Instruments

The measuring equipment is listed in the section 4 of this test report.

### 3.4.3 Test Procedures

1. The testing follows ANSI C63.10-2013 clause 6.9.2 and 6.9.3.
2. The RF output of EUT was connected to the spectrum analyzer by RF cable and attenuator. The path loss was compensated to the results for each measurement.
3. Set to the maximum power setting and enable the EUT transmit continuously.
4. Use the following spectrum analyzer settings for 20dB Bandwidth measurement.  
Span = approximately 2 to 5 times the 20 dB bandwidth, centered on a hopping channel;  
RBW  $\geq$  1% of the 20 dB bandwidth; VBW  $\geq$  RBW; Sweep = auto; Detector function = peak;  
Trace = max hold.
5. Use the following spectrum analyzer settings for 99 % Bandwidth measurement.  
Span = approximately 1.5 to 5 times the 99% bandwidth, centered on a hopping channel;  
RBW  $\geq$  1% of the 99% bandwidth; VBW  $\geq$  RBW; Sweep = auto; Detector function = peak;  
Trace = max hold.
6. Measure and record the results in the test report.

### 3.4.4 Test Setup

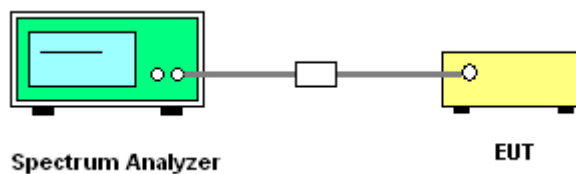



3.4.5 Test Result of 20dB Bandwidth

Test Mode :	1Mbps	Temperature :	24~26°C
Test Engineer :	Luffy Lin and Osolemio Chang	Relative Humidity :	48~51%

Channel	Frequency (MHz)	20dB Bandwidth (MHz)
00	2402	0.855
39	2441	0.839
78	2480	0.855

20 dB Bandwidth Plot on Channel 00

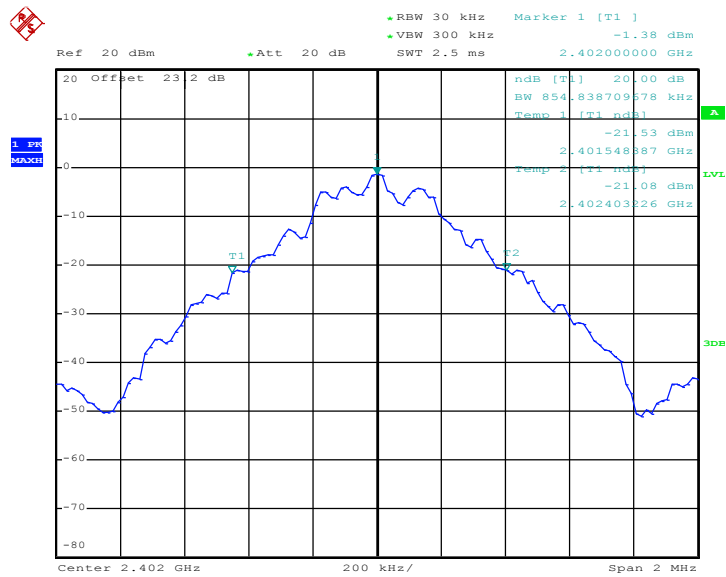

Date: 6.JAN.2016 00:50:12



20 dB Bandwidth Plot on Channel 39

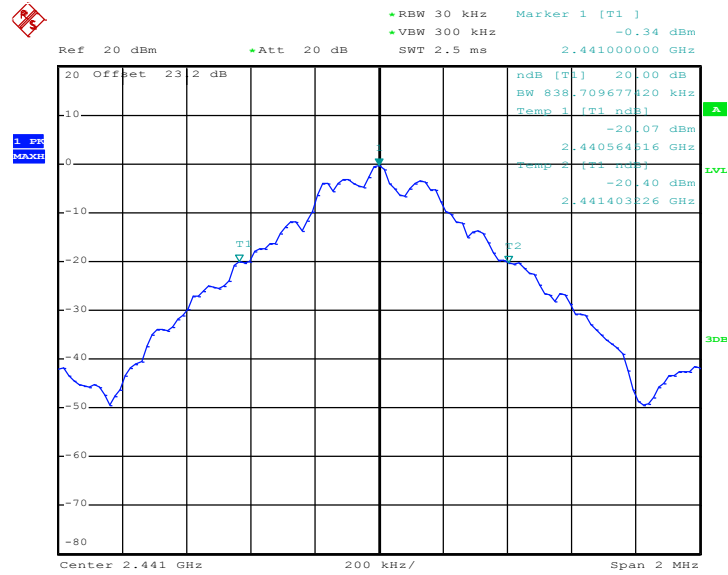

Date: 6.JAN.2016 00:51:49

20 dB Bandwidth Plot on Channel 78

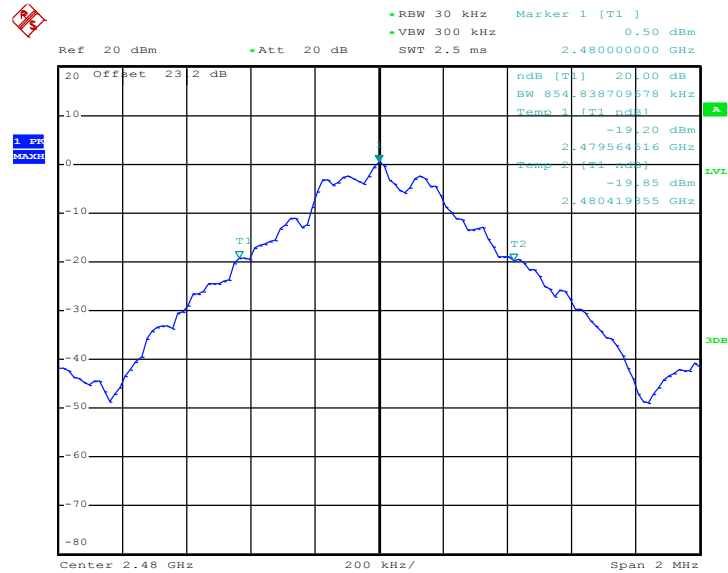

Date: 6.JAN.2016 00:52:23



Test Mode :	2Mbps	Temperature :	24~26°C
Test Engineer :	Luffy Lin and Osolemio Chang	Relative Humidity :	48~51%

Channel	Frequency (MHz)	20dB Bandwidth (MHz)
00	2402	1.260
39	2441	1.260
78	2480	1.260

20 dB Bandwidth Plot on Channel 00

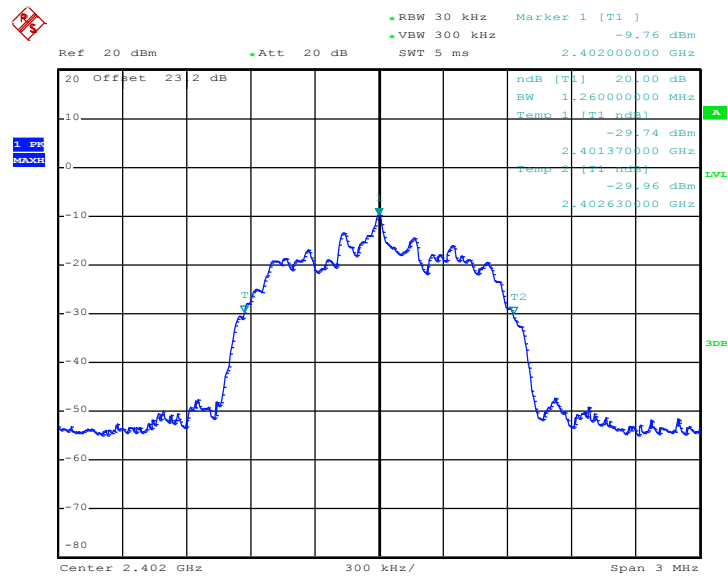

Date: 6.JAN.2016 00:53:23



20 dB Bandwidth Plot on Channel 39

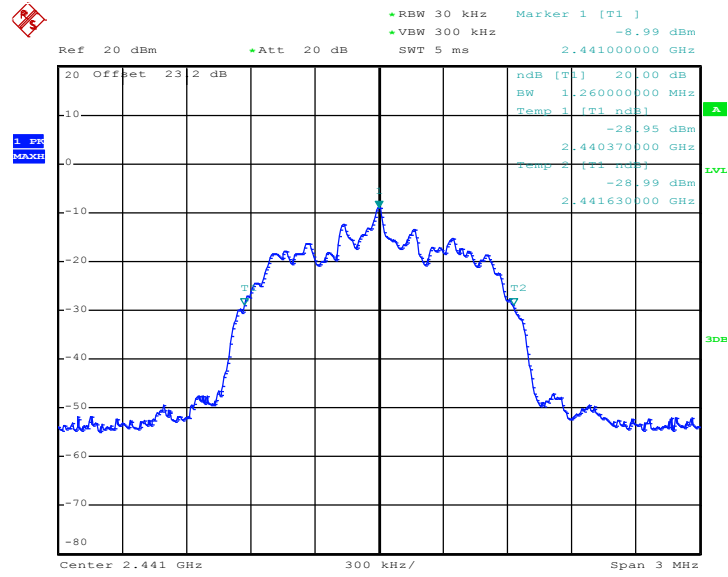

Date: 6.JAN.2016 00:54:04

20 dB Bandwidth Plot on Channel 78

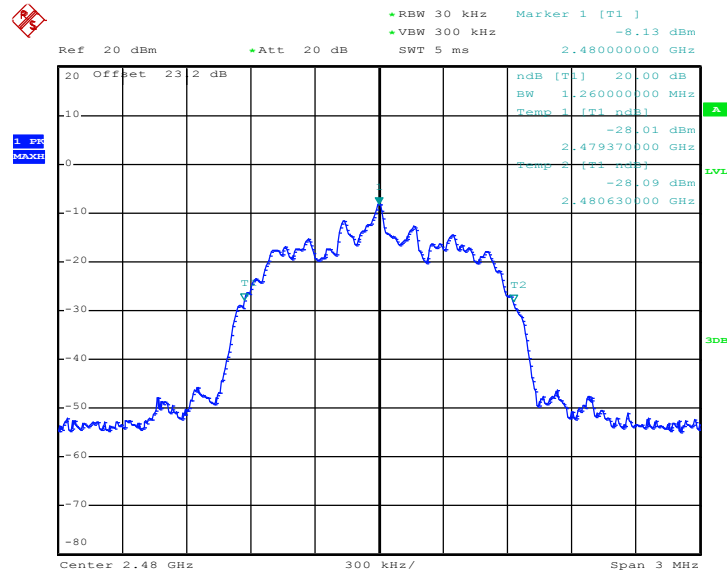

Date: 6.JAN.2016 00:54:43



Test Mode :	3Mbps	Temperature :	24~26°C
Test Engineer :	Luffy Lin and Osolemio Chang	Relative Humidity :	48~51%

Channel	Frequency (MHz)	20dB Bandwidth (MHz)
00	2402	1.224
39	2441	1.230
78	2480	1.245

20 dB Bandwidth Plot on Channel 00

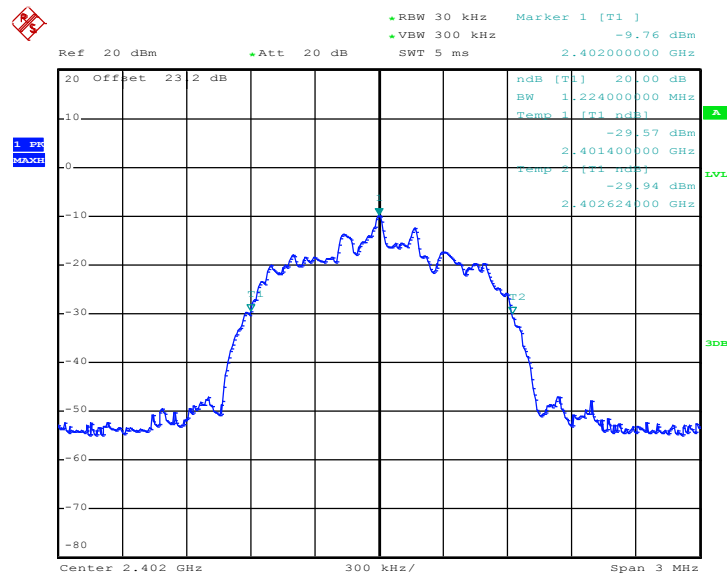

Date: 6.JAN.2016 00:55:22



20 dB Bandwidth Plot on Channel 39

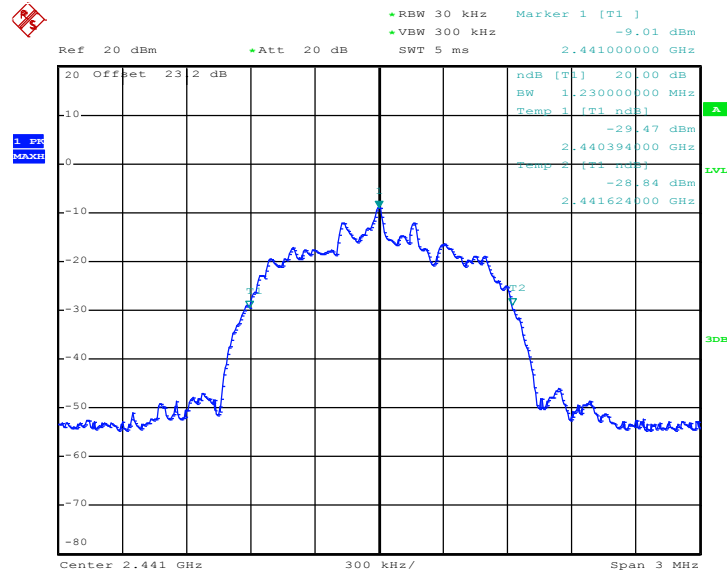

Date: 6.JAN.2016 00:55:55

20 dB Bandwidth Plot on Channel 78

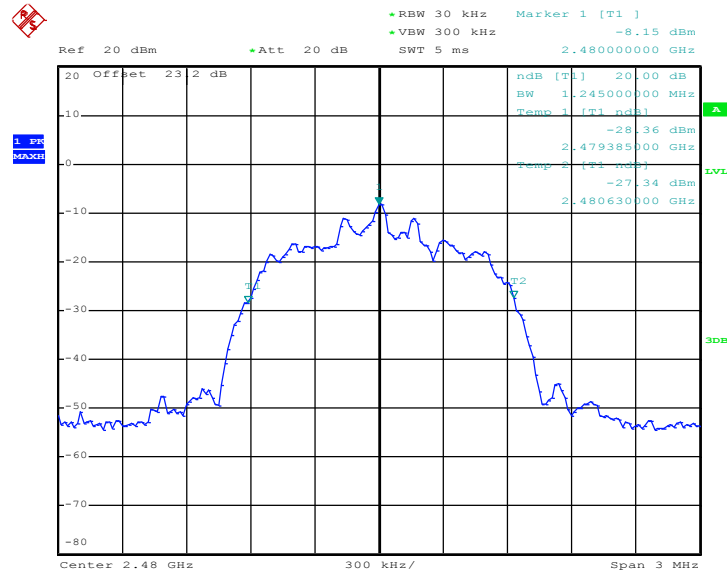

Date: 6.JAN.2016 00:56:57



3.4.6 Test Result of 99% Occupied Bandwidth

Test Mode :	1Mbps	Temperature :	24~26°C
Test Engineer :	Luffy Lin and Osolemio Chang	Relative Humidity :	48~51%

Channel	Frequency (MHz)	99% Occupied Bandwidth (MHz)
00	2402	0.796
39	2441	0.816
78	2480	0.816

99% Occupied Bandwidth Plot on Channel 00

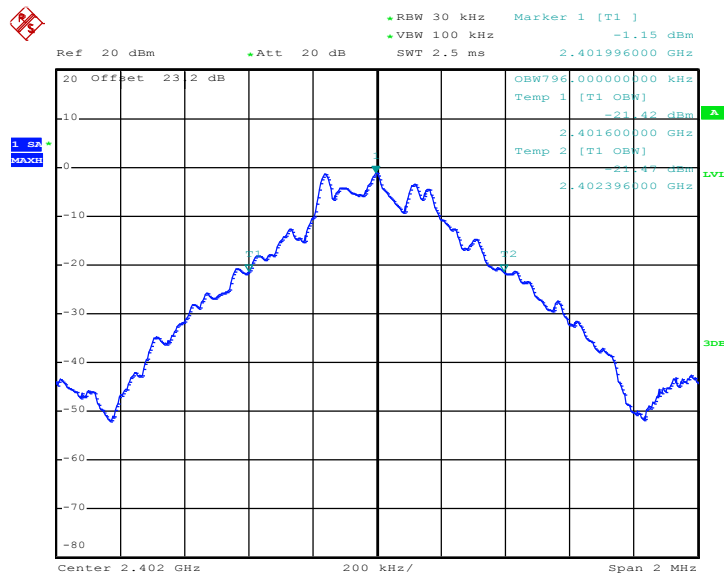

Date: 6.JAN.2016 00:57:50





99% Occupied Bandwidth Plot on Channel 39

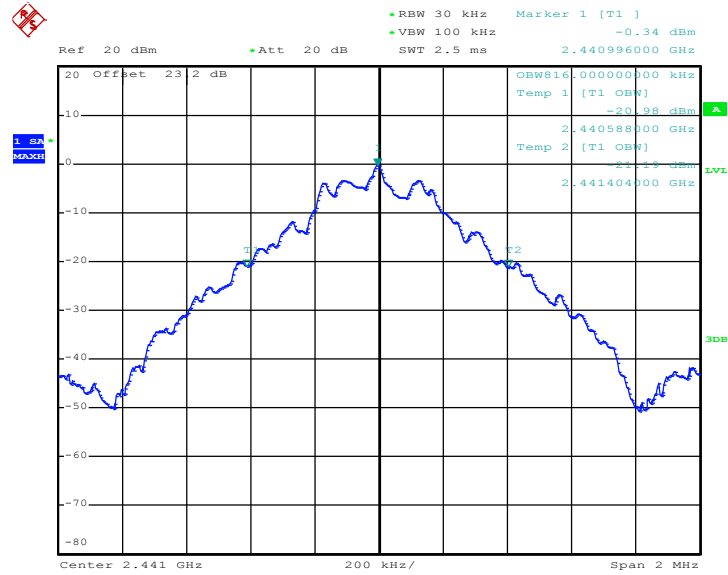

Date: 6.JAN.2016 01:00:17

99% Occupied Bandwidth Plot on Channel 78

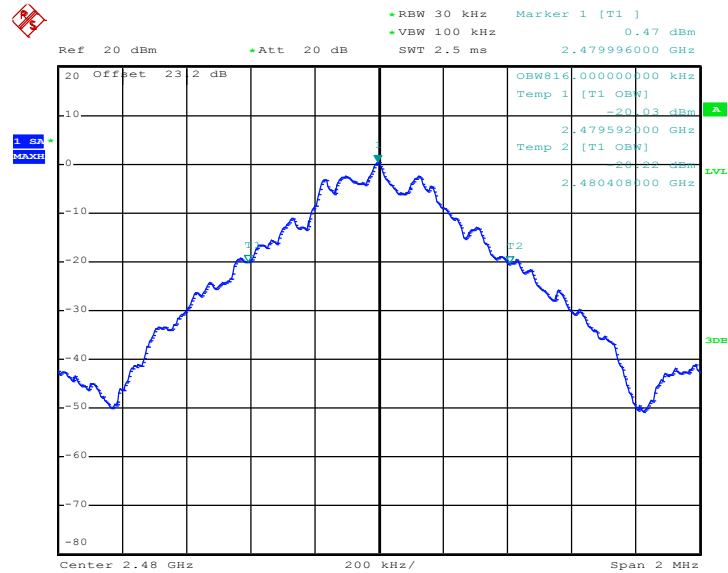

Date: 6.JAN.2016 01:02:09



Test Mode :	2Mbps	Temperature :	24~26°C
Test Engineer :	Luffy Lin and Osolemio Chang	Relative Humidity :	48~51%

Channel	Frequency (MHz)	99% Occupied Bandwidth (MHz)
00	2402	1.168
39	2441	1.176
78	2480	1.172

99% Occupied Bandwidth Plot on Channel 00

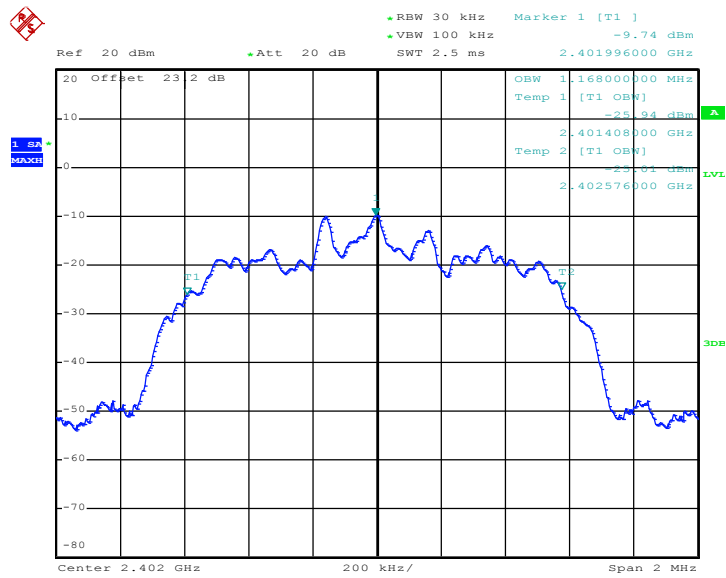

Date: 6.JAN.2016 01:06:31



99% Occupied Bandwidth Plot on Channel 39

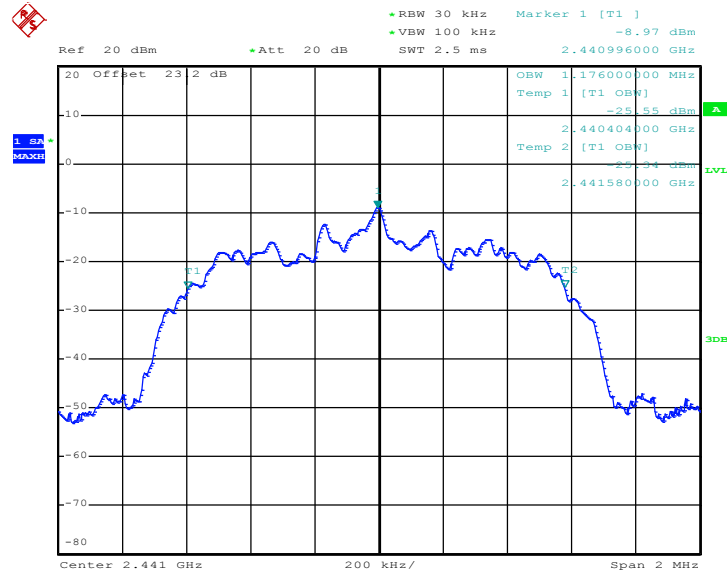

Date: 6.JAN.2016 01:14:39

99% Occupied Bandwidth Plot on Channel 78

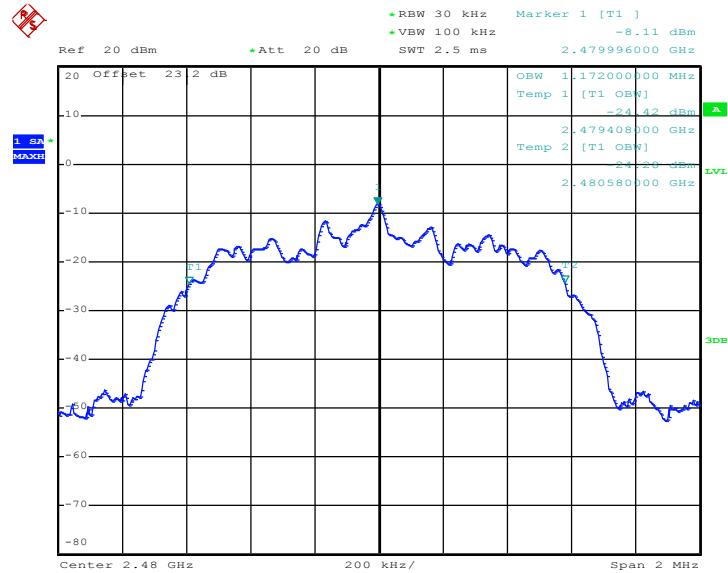

Date: 6.JAN.2016 01:17:59



Test Mode :	3Mbps	Temperature :	24~26°C
Test Engineer :	Luffy Lin and Osolemio Chang	Relative Humidity :	48~51%

Channel	Frequency (MHz)	99% Occupied Bandwidth (MHz)
00	2402	1.160
39	2441	1.160
78	2480	1.156

99% Occupied Bandwidth Plot on Channel 00

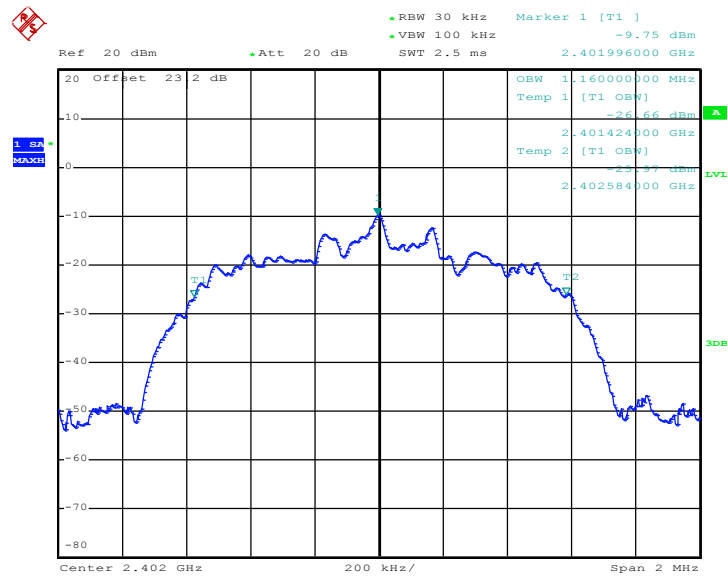

Date: 6.JAN.2016 01:20:27



99% Occupied Bandwidth Plot on Channel 39

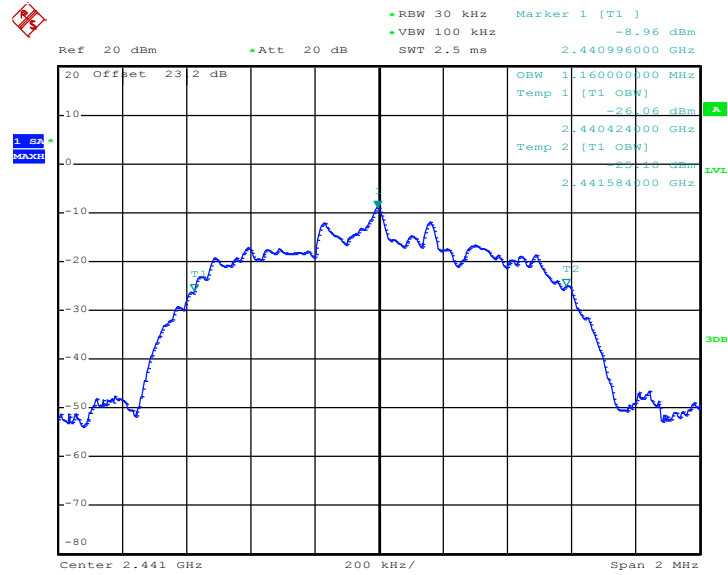

Date: 6.JAN.2016 01:22:08

99% Occupied Bandwidth Plot on Channel 78

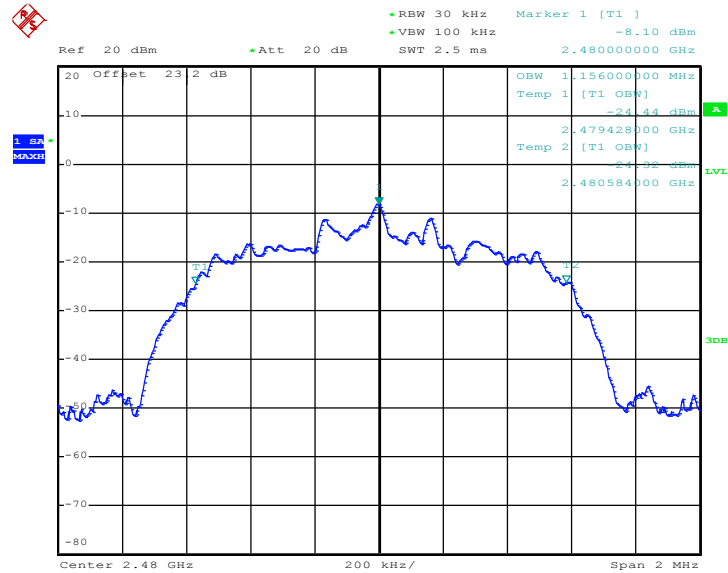

Date: 6.JAN.2016 01:23:40

Note : The occupied channel bandwidth is maintained within the band of operation for all of the modulations.

### 3.5 Peak Output Power Measurement

#### 3.5.1 Limit of Peak Output Power

Section 15.247 (b) The maximum peak conducted output power of the intentional radiator shall not exceed the following: (1) For frequency hopping systems operating in the 2400-2483.5 MHz band employing at least 75 non-overlapping hopping channels, and all frequency hopping systems in the 5725-5850 MHz band: 1 watt. For all other frequency hopping systems in the 2400-2483.5 MHz band 0.125 watts. The power limit for 1Mbps is 1watt, and for 2Mbps, 3Mbps and AFH are 0.125 watts.

#### 3.5.2 Measuring Instruments

The measuring equipment is listed in the section 4 of this test report.

#### 3.5.3 Test Procedures

1. The testing follows ANSI C63.10-2013 clause 7.8.5.
2. The RF output of EUT was connected to the power meter by RF cable and attenuator. The path loss was compensated to the results for each measurement.
3. Set to the maximum power setting and enable the EUT transmit continuously.
4. Measure the conducted output power with cable loss and record the results in the test report.
5. Measure and record the results in the test report.

#### 3.5.4 Test Setup

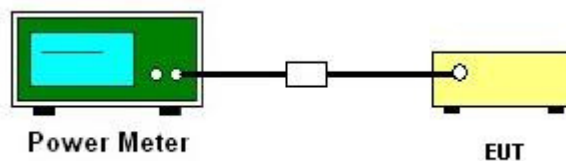



3.5.5 Test Result of Peak Output Power

Test Mode :	1Mbps	Temperature :	24~26°C
Test Engineer :	Luffy Lin and Osolemio Chang	Relative Humidity :	48~51%

Channel	Frequency (MHz)	RF Power (dBm)		
		GFSK	Max. Limits (dBm)	Pass/Fail
		1 Mbps		
00	2402	1.10	20.97	Pass
39	2441	1.29	20.97	Pass
78	2480	2.20	20.97	Pass

Note: For AFH mode using 20 hopping channels, the maximum output power limit is 20.97dBm.

Test Mode :	2Mbps	Temperature :	24~26°C
Test Engineer :	Luffy Lin and Osolemio Chang	Relative Humidity :	48~51%

Channel	Frequency (MHz)	RF Power (dBm)		
		$\pi/4$ -DQPSK	Max. Limits (dBm)	Pass/Fail
		2 Mbps		
00	2402	-3.41	20.97	Pass
39	2441	-3.18	20.97	Pass
78	2480	-2.70	20.97	Pass

Test Mode :	3Mbps	Temperature :	24~26°C
Test Engineer :	Luffy Lin and Osolemio Chang	Relative Humidity :	48~51%

Channel	Frequency (MHz)	RF Power (dBm)		
		8-DPSK	Max. Limits (dBm)	Pass/Fail
		3 Mbps		
00	2402	-3.32	20.97	Pass
39	2441	-3.18	20.97	Pass
78	2480	-2.66	20.97	Pass

## 3.6 Conducted Band Edges Measurement

### 3.6.1 Limit of Band Edges

In any 100 kHz bandwidth outside the intentional radiation frequency band, the radio frequency power shall be at least 20 dB below the highest level of the radiated power. In addition, radiated emissions which fall in the restricted bands must also comply with the radiated emission limits.

### 3.6.2 Measuring Instruments

The measuring equipment is listed in the section 4 of this test report.

### 3.6.3 Test Procedures

1. The testing follows ANSI C63.10-2013 clause 7.8.6.
2. Set to the maximum power setting and enable the EUT transmit continuously.
3. Set RBW = 100kHz, VBW = 300kHz. Band edge emissions must be at least 20 dB down from the highest emission level within the authorized band as measured with a 100kHz RBW. The attenuation shall be 30 dB instead of 20 dB when RMS conducted output power procedure is used.
4. Enable hopping function of the EUT and then repeat step 2. and 3.
5. Measure and record the results in the test report.

### 3.6.4 Test Setup







### 3.6.5 Test Result of Conducted Band Edges

Test Mode :	1Mbps	Temperature :	24~26°C
Test Channel :	00 and 78	Relative Humidity :	48~51%
		Test Engineer :	Luffy Lin and Osolemio Chang

Low Band Edge Plot on Channel 00

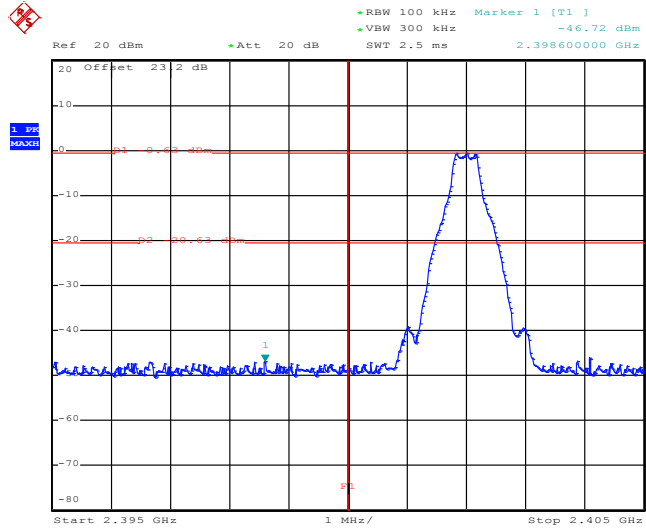

Date: 6.JAN.2016 01:38:52

High Band Edge Plot on Channel 78

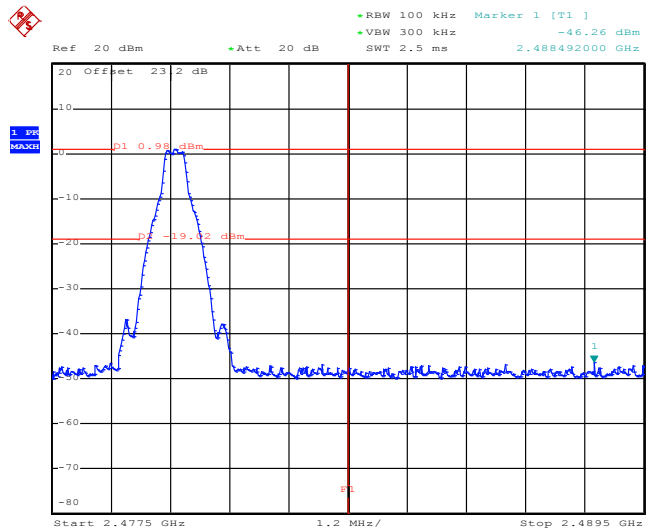

Date: 6.JAN.2016 01:39:16



Test Mode :	2Mbps	Temperature :	24~26°C
Test Channel :	00 and 78	Relative Humidity :	48~51%
		Test Engineer :	Luffy Lin and Osolemio Chang

Low Band Edge Plot on Channel 00

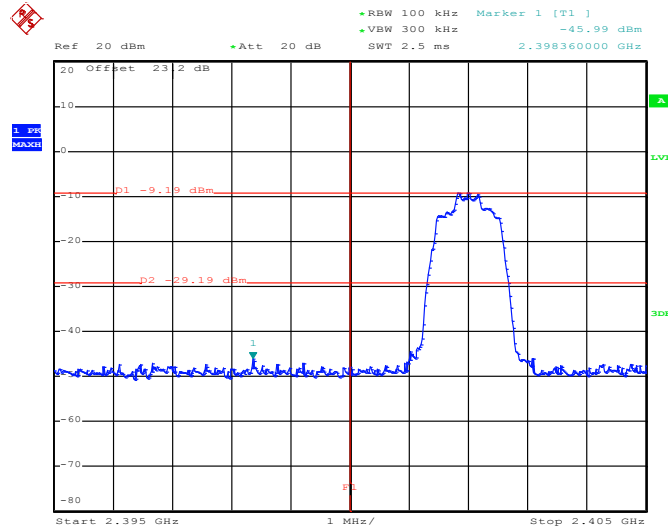

Date: 6.JAN.2016 01:37:56

High Band Edge Plot on Channel 78

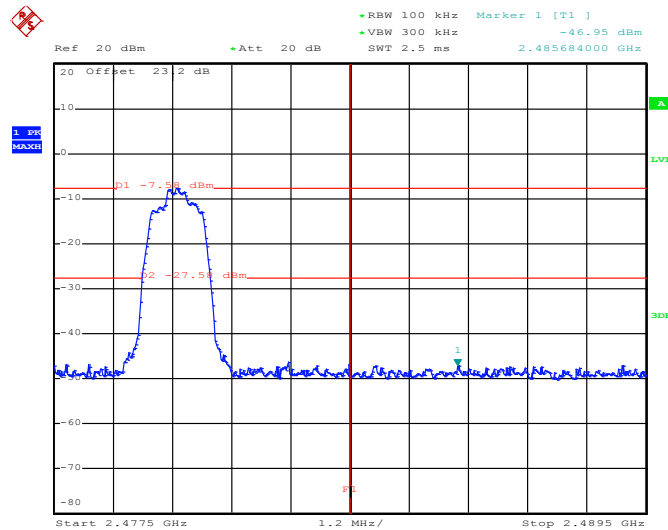

Date: 6.JAN.2016 01:38:23



Test Mode :	3Mbps	Temperature :	24~26°C
Test Channel :	00 and 78	Relative Humidity :	48~51%
		Test Engineer :	Luffy Lin and Osolemio Chang

Low Band Edge Plot on Channel 00

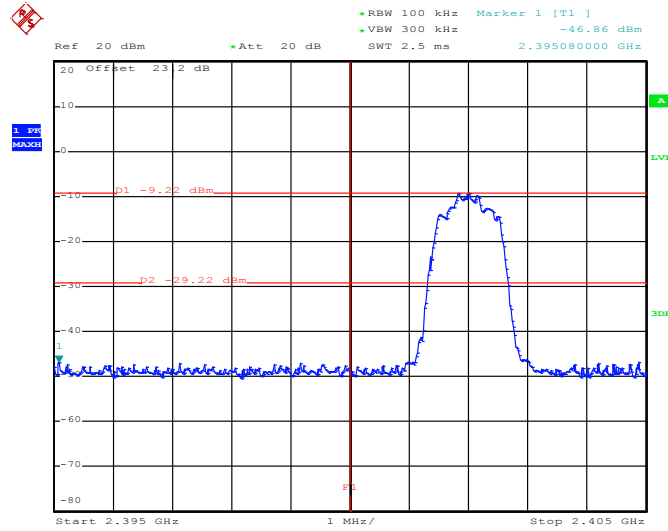

Date: 6.JAN.2016 01:35:31

High Band Edge Plot on Channel 78

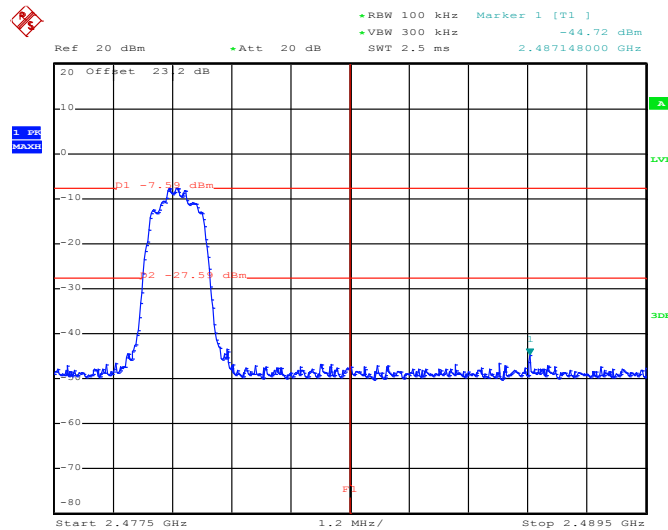

Date: 6.JAN.2016 01:36:39



### 3.6.6 Test Result of Conducted Hopping Mode Band Edges

Test Mode :	1Mbps	Temperature :	24~26°C
Test Engineer :	Luffy Lin and Osolemio Chang	Relative Humidity :	48~51%

1Mbps Hopping Mode Low Band Edge Plot

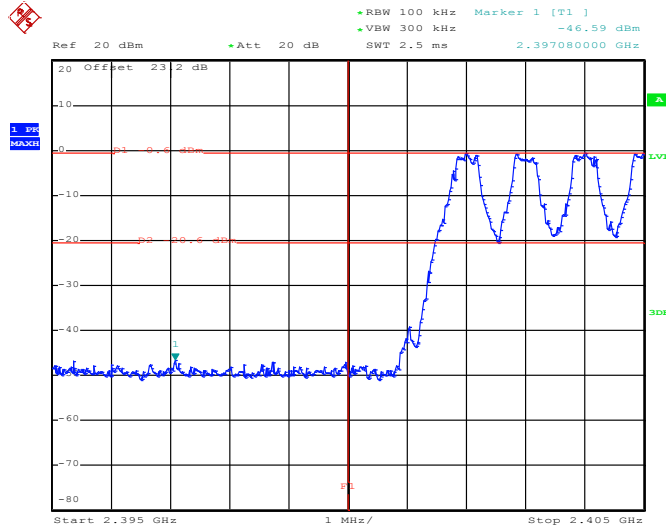

Date: 6.JAN.2016 01:32:53

1Mbps Hopping Mode High Band Edge Plot

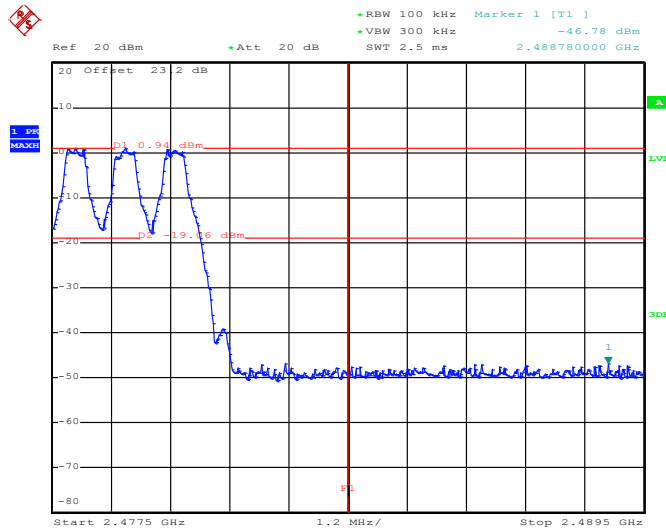

Date: 6.JAN.2016 01:33:07



Test Mode :	2Mbps	Temperature :	24~26°C
Test Engineer :	Luffy Lin and Osolemio Chang	Relative Humidity :	48~51%

2Mbps Hopping Mode Low Band Edge Plot

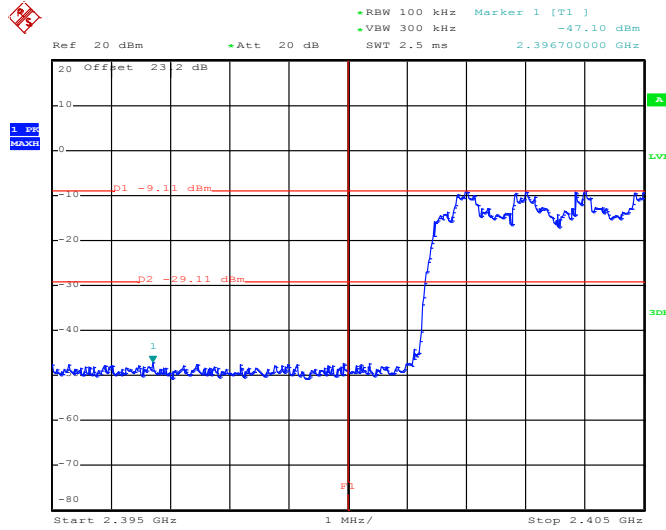

Date: 6.JAN.2016 01:33:35

2Mbps Hopping Mode High Band Edge Plot

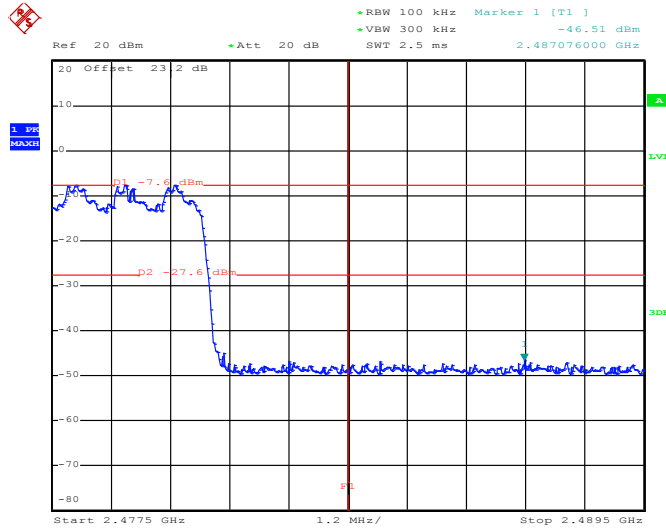

Date: 6.JAN.2016 01:34:05



Test Mode :	3Mbps	Temperature :	24~26°C
Test Engineer :	Luffy Lin and Osolemio Chang	Relative Humidity :	48~51%

3Mbps Hopping Mode Low Band Edge Plot

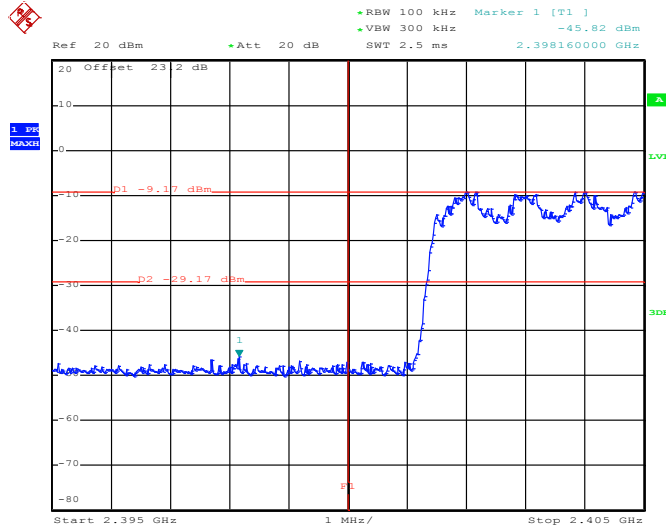

Date: 6.JAN.2016 01:34:49

3Mbps Hopping Mode High Band Edge Plot

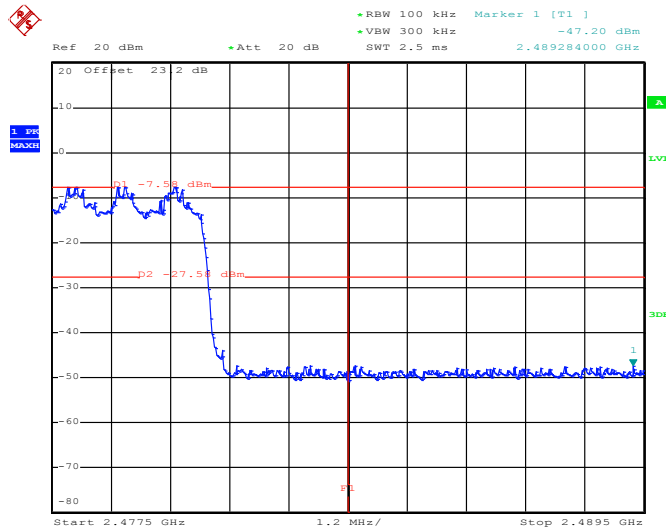

Date: 6.JAN.2016 01:35:05

## 3.7 Conducted Spurious Emission Measurement

### 3.7.1 Limit of Spurious Emission Measurement

In any 100 kHz bandwidth outside the intentional radiation frequency band, the radio frequency power shall be at least 20 dB below the highest level of the radiated power. In addition, radiated emissions which fall in the restricted bands must also comply with the radiated emission limits.

### 3.7.2 Measuring Instruments

The measuring equipment is listed in the section 4 of this test report.

### 3.7.3 Test Procedure

1. The testing follows ANSI C63.10-2013 clause 7.8.8.
2. The RF output of EUT was connected to the spectrum analyzer by RF cable and attenuator. The path loss was compensated to the results for each measurement.
3. Set to the maximum power setting and enable the EUT transmit continuously.
4. Set RBW = 100 kHz, VBW = 300kHz, scan up through 10th harmonic. All harmonics / spurs must be at least 20 dB down from the highest emission level within the authorized band as measured with a 100 kHz RBW.
5. Measure and record the results in the test report.
6. The RF fundamental frequency should be excluded against the limit line in the operating frequency band.

### 3.7.4 Test Setup

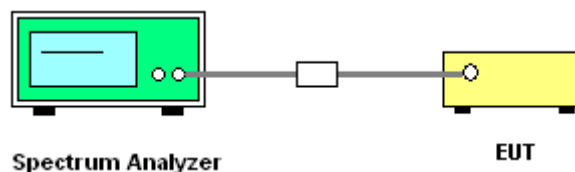



### 3.7.5 Test Result of Conducted Spurious Emission

Test Mode :	1Mbps	Temperature :	24~26°C
Test Channel :	00	Relative Humidity :	48~51%
		Test Engineer :	Luffy Lin and Osolemio Chang

1Mbps CSE Plot on Ch 00 between 30MHz ~ 3 GHz

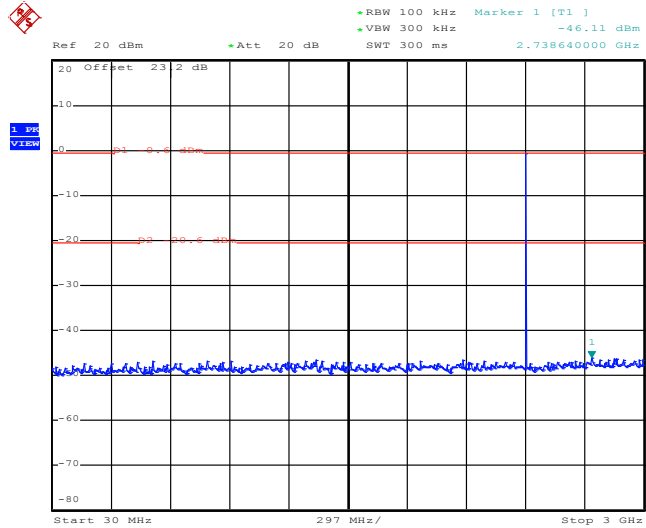

Date: 6.JAN.2016 00:59:08

1Mbps CSE Plot on Ch 00 between 2 GHz ~ 25 GHz

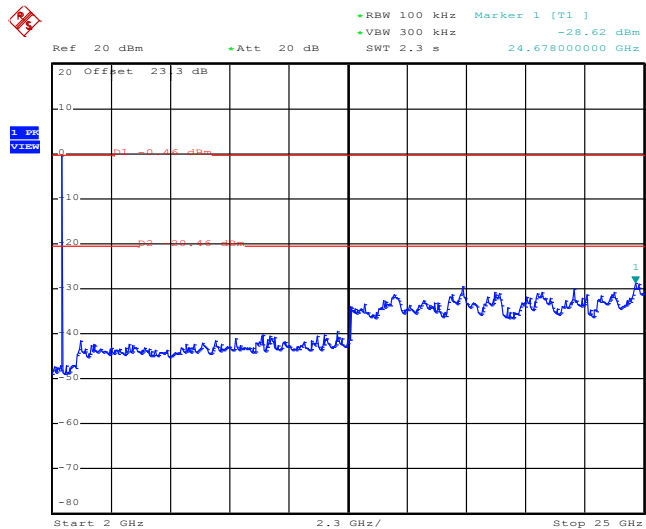

Date: 6.JAN.2016 00:59:29





Test Mode :	1Mbps	Temperature :	24~26°C
Test Channel :	39	Relative Humidity :	48~51%
		Test Engineer :	Luffy Lin and Osolemio Chang

1Mbps CSE Plot on Ch 39 between 30MHz ~ 3 GHz

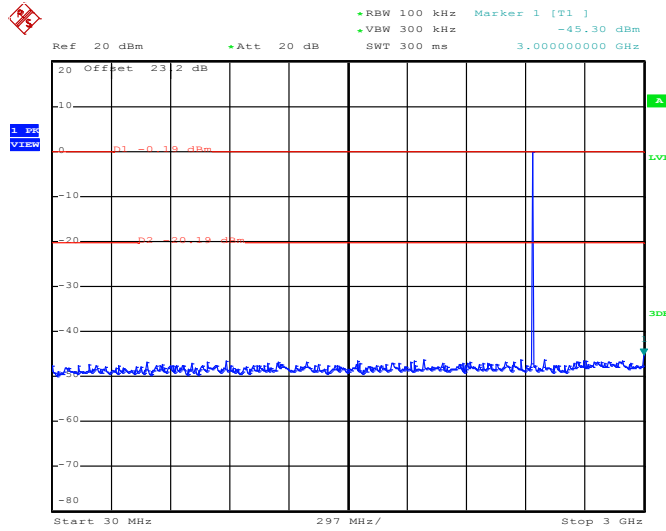

Date: 6.JAN.2016 01:00:43

1Mbps CSE Plot on Ch 39 between 2 GHz ~ 25 GHz

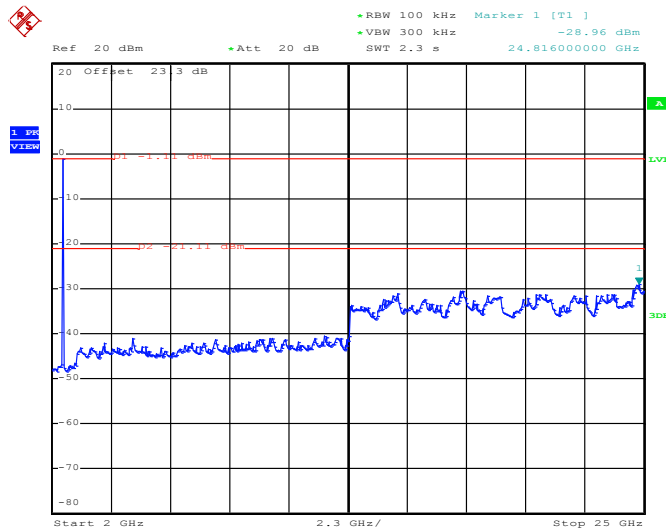

Date: 6.JAN.2016 01:01:04



Test Mode :	1Mbps	Temperature :	24~26°C
Test Channel :	78	Relative Humidity :	48~51%
		Test Engineer :	Luffy Lin and Osolemio Chang

1Mbps CSE Plot on Ch 78 between 30MHz ~ 3 GHz

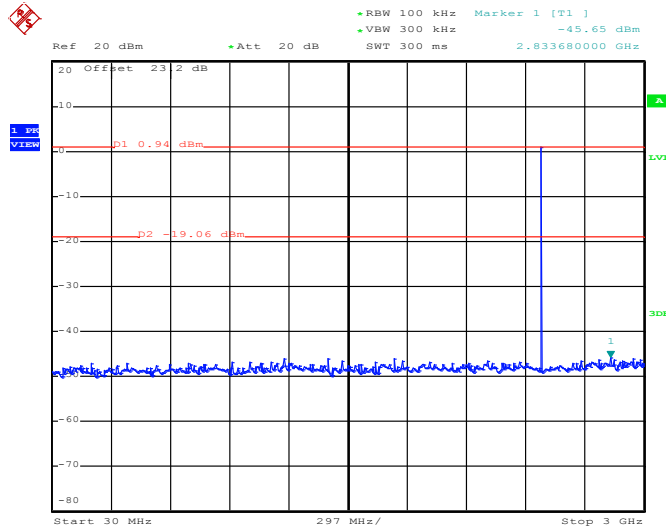

Date: 6.JAN.2016 01:04:43

1Mbps CSE Plot on Ch 78 between 2 GHz ~ 25 GHz

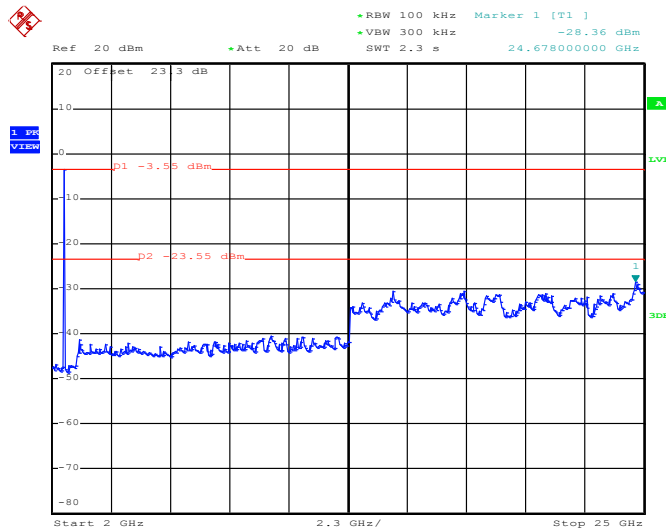

Date: 6.JAN.2016 01:05:05



Test Mode :	2Mbps	Temperature :	24~26°C
Test Channel :	00	Relative Humidity :	48~51%
		Test Engineer :	Luffy Lin and Osolemio Chang

2Mbps CSE Plot on Ch 00 between 30MHz ~ 3 GHz

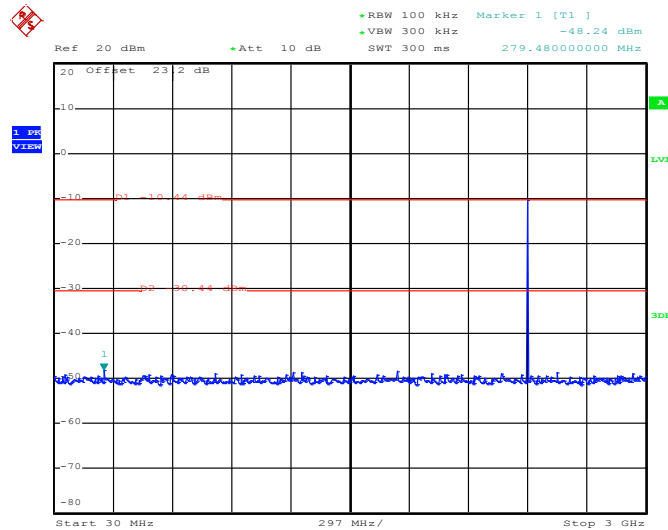

Date: 6.JAN.2016 01:28:22

2Mbps CSE Plot on Ch 00 between 2 GHz ~ 25 GHz

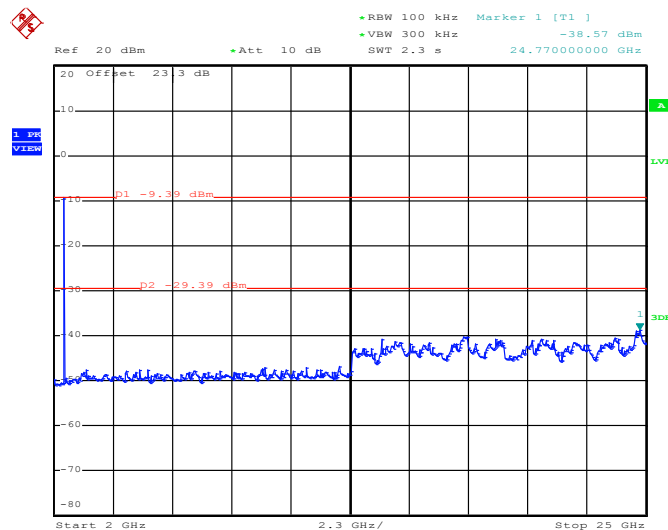

Date: 6.JAN.2016 01:28:43



Test Mode :	2Mbps	Temperature :	24~26°C
Test Channel :	39	Relative Humidity :	48~51%
		Test Engineer :	Luffy Lin and Osolemio Chang

2Mbps CSE Plot on Ch 39 between 30MHz ~ 3 GHz

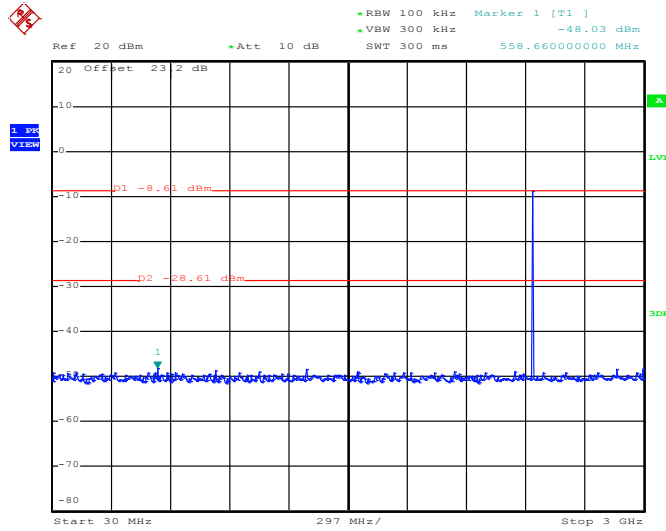

Date: 6.JAN.2016 01:16:43

2Mbps CSE Plot on Ch 39 between 2 GHz ~ 25 GHz

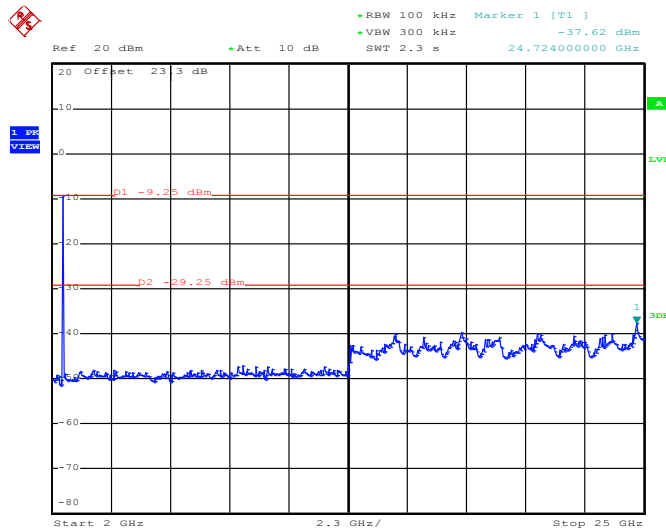

Date: 6.JAN.2016 01:17:05



Test Mode :	2Mbps	Temperature :	24~26°C
Test Channel :	78	Relative Humidity :	48~51%
		Test Engineer :	Luffy Lin and Osolemio Chang

2Mbps CSE Plot on Ch 78 between 30MHz ~ 3 GHz

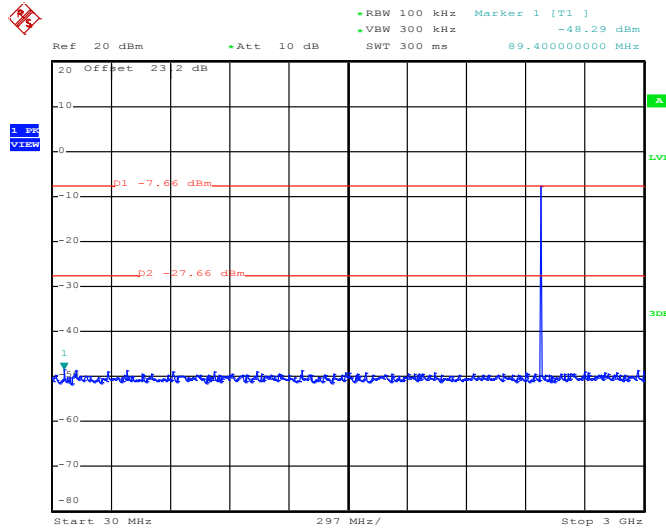

Date: 6.JAN.2016 01:18:23

2Mbps CSE Plot on Ch 78 between 2 GHz ~ 25 GHz

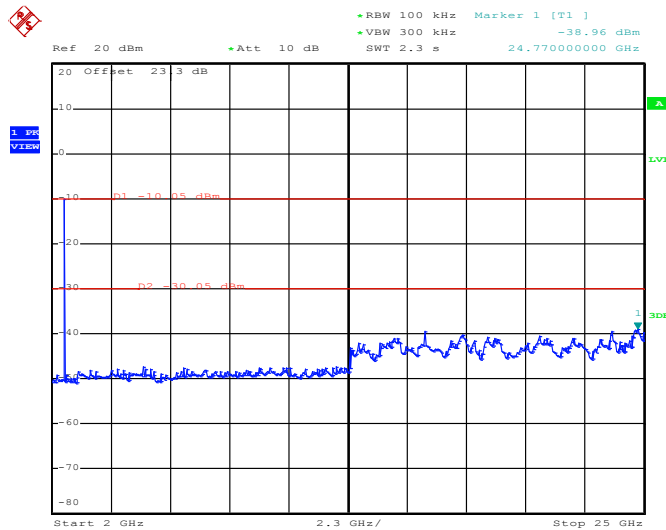

Date: 6.JAN.2016 01:18:45



Test Mode :	3Mbps	Temperature :	24~26°C
Test Channel :	00	Relative Humidity :	48~51%
		Test Engineer :	Luffy Lin and Osolemio Chang

3Mbps CSE Plot on Ch 00 between 30MHz ~ 3 GHz

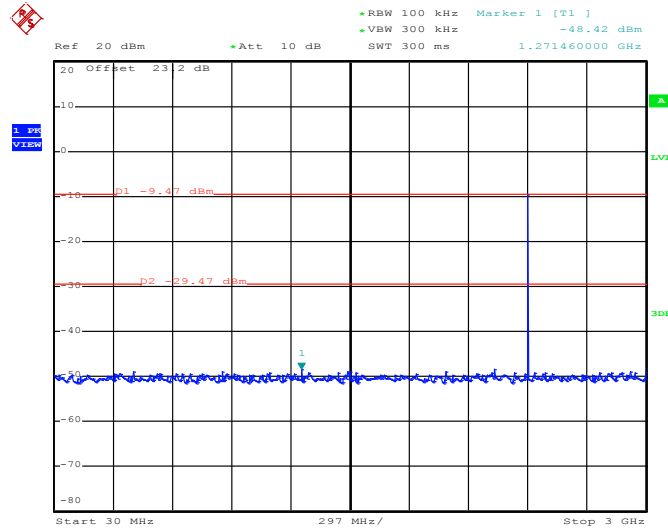

Date: 6.JAN.2016 01:25:00

3Mbps CSE Plot on Ch 00 between 2 GHz ~ 25 GHz

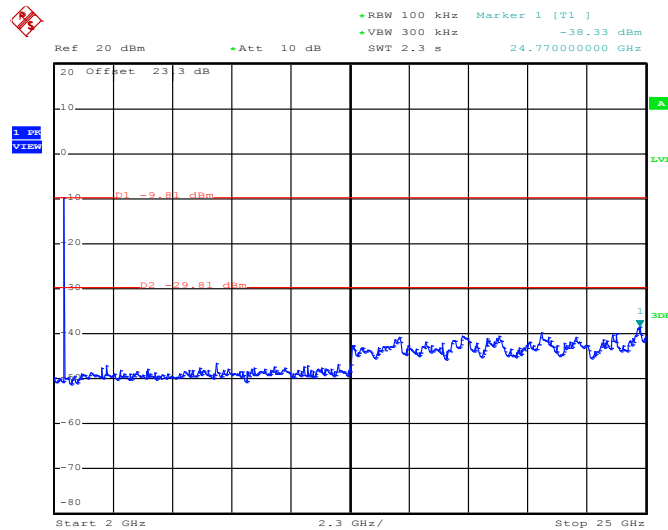

Date: 6.JAN.2016 01:25:21



Test Mode :	3Mbps	Temperature :	24~26°C
Test Channel :	39	Relative Humidity :	48~51%
		Test Engineer :	Luffy Lin and Osolemio Chang

3Mbps CSE Plot on Ch 39 between 30MHz ~ 3 GHz

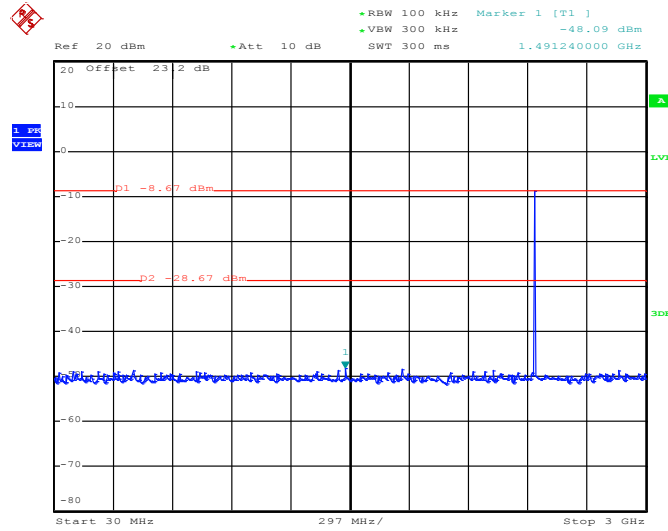

Date: 6.JAN.2016 01:26:19

3Mbps CSE Plot on Ch 39 between 2 GHz ~ 25 GHz

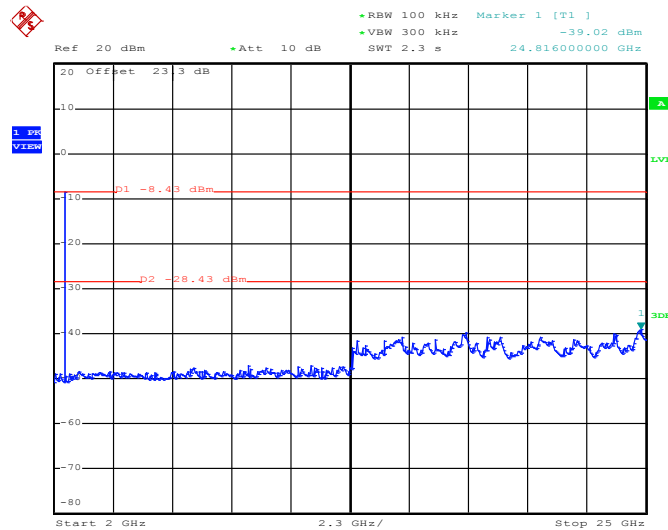

Date: 6.JAN.2016 01:26:41



Test Mode :	3Mbps	Temperature :	24~26°C
Test Channel :	78	Relative Humidity :	48~51%
		Test Engineer :	Luffy Lin and Osolemio Chang

3Mbps CSE Plot on Ch 78 between 30MHz ~ 3 GHz

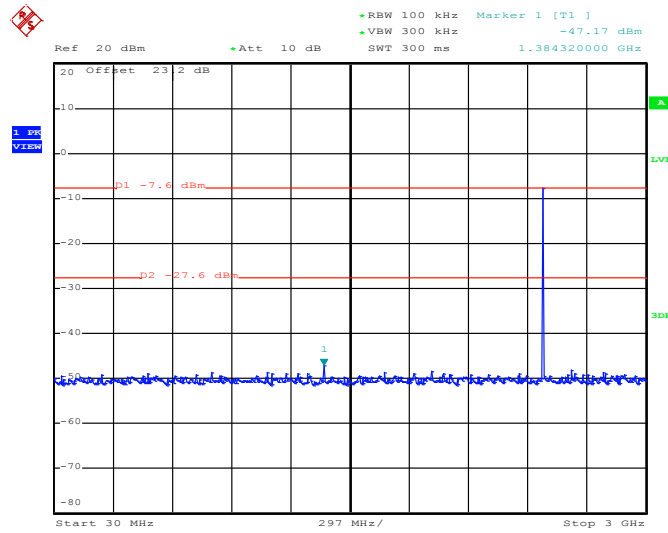

Date: 6.JAN.2016 01:24:06

3Mbps CSE Plot on Ch 78 between 2 GHz ~ 25 GHz

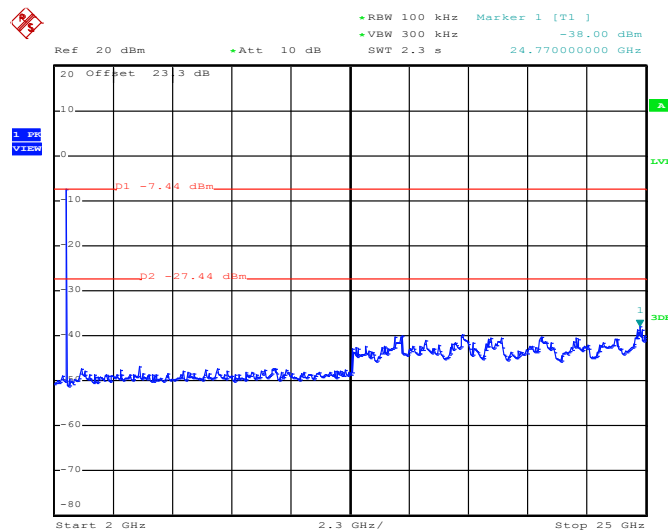

Date: 6.JAN.2016 01:24:28





### 3.8 Radiated Band Edges and Spurious Emission Measurement

#### 3.8.1 Limit of Radiated Band Edges and Spurious Emission

In any 100 kHz bandwidth outside the intentional radiator frequency band, all harmonics/spurious must be at least 20 dB below the highest emission level within the authorized band. In addition, radiated emissions which fall in the restricted bands must also comply with the FCC section 15.209 limits as below.

Frequency (MHz)	Field Strength (microvolts/meter)	Measurement Distance (meters)
0.009 – 0.490	2400/F(kHz)	300
0.490 – 1.705	24000/F(kHz)	30
1.705 – 30.0	30	30
30 – 88	100	3
88 – 216	150	3
216 - 960	200	3
Above 960	500	3

#### 3.8.2 Measuring Instruments

The measuring equipment is listed in the section 4 of this test report.



### 3.8.3 Test Procedures

1. The EUT was placed on a turntable with 0.8 meter for frequency below 1GHz and 1.5 meter for frequency above 1GHz respectively above ground.
2. The EUT was set 3 meters from the interference receiving antenna, which was mounted on the top of a variable height antenna tower.
3. For each suspected emission, the EUT was arranged to its worst case and then tune the Antenna tower (from 1 m to 4 m) and turntable (from 0 degree to 360 degrees) to find the maximum reading. A pre-amp and a high pass filter are used for the test in order to get better signal level to comply with the guidelines.
4. Set to the maximum power setting and enable the EUT transmit continuously.
5. Use the following spectrum analyzer settings:
  - (1) Span shall wide enough to fully capture the emission being measured;
  - (2) Set RBW=100 kHz for  $f < 1 \text{ GHz}$ , RBW=1MHz for  $f > 1\text{GHz}$  ; VBW  $\geq$  RBW; Sweep = auto; Detector function = peak; Trace = max hold for peak
  - (3) For average measurement: use duty cycle correction factor method per 15.35(c).  
Duty cycle = On time/100 milliseconds  
On time =  $N_1 * L_1 + N_2 * L_2 + \dots + N_{n-1} * L_{n-1} + N_n * L_n$   
Where  $N_1$  is number of type 1 pulses,  $L_1$  is length of type 1 pulses, etc.  
Average Emission Level = Peak Emission Level +  $20 * \log(\text{Duty cycle})$
6. Corrected Reading: Antenna Factor + Cable Loss + Read Level - Preamp Factor = Level

Note: The average levels were calculated from the peak level corrected with duty cycle correction factor (-24.70dB) derived from  $20 \log(\text{dwell time}/100\text{ms})$ . This correction is only for signals that hop with the fundamental signal, such as band-edge and harmonic. Other spurious signals that are independent of the hopping signal would not use this correction.

### 3.8.4 Test Setup

For radiated emissions below 30MHz

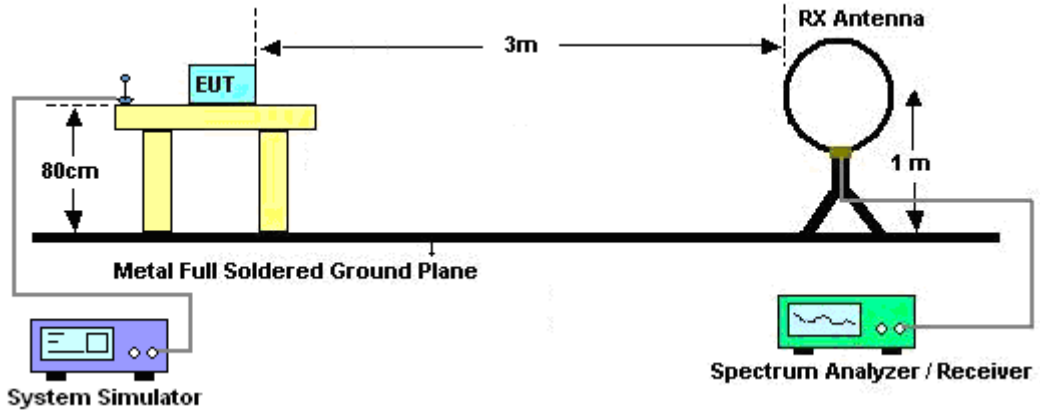

For radiated emissions from 30MHz to 1GHz

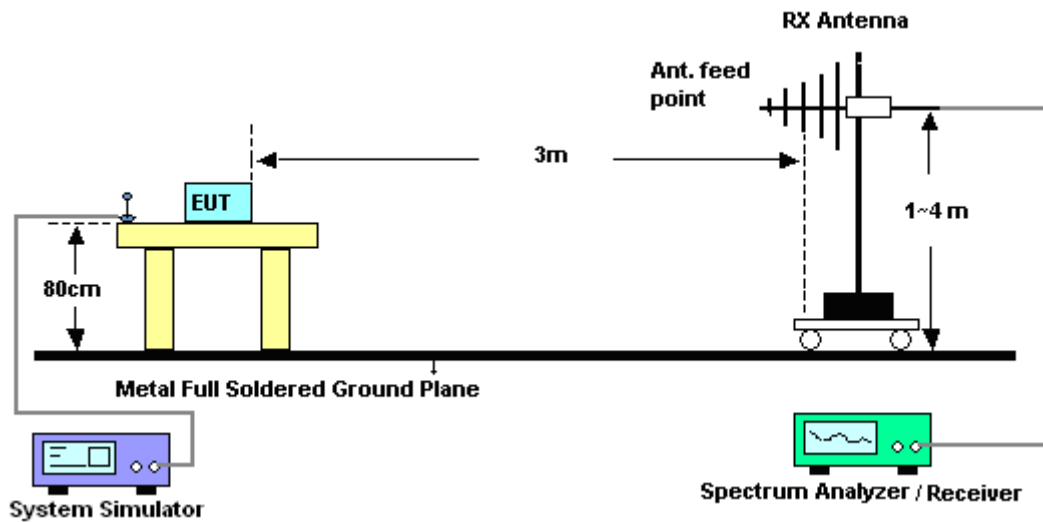

For radiated emissions above 1GHz

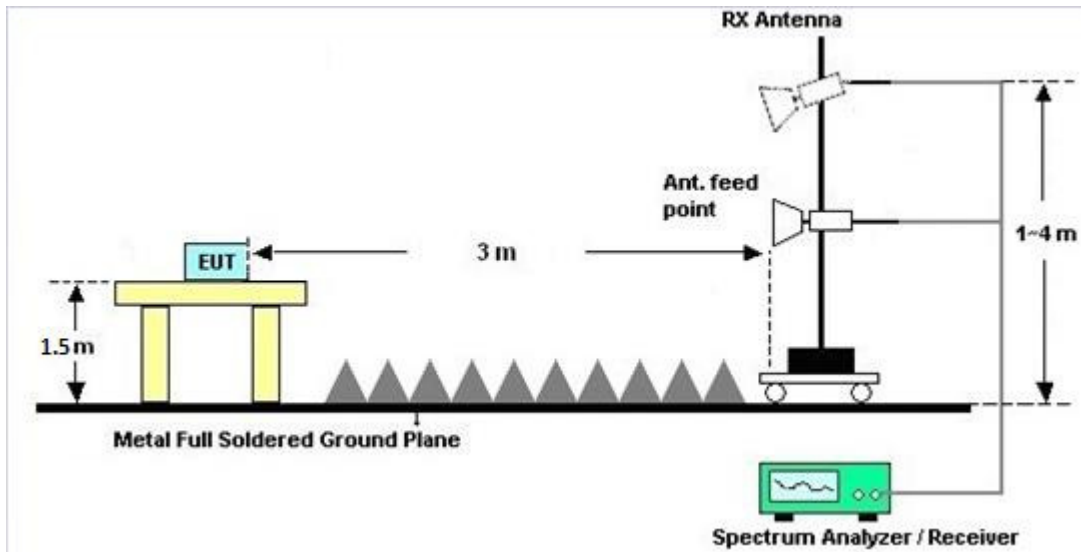

### 3.8.5 Test Results of Radiated Spurious Emissions (9 kHz ~ 30 MHz)

The low frequency, which started from 9 kHz to 30MHz, was pre-scanned and the result which was 20dB lower than the limit line per 15.31(o) was not reported.



### 3.8.6 Duty cycle correction factor for average measurement

DH5 on time (One Pulse) Plot on Channel 39

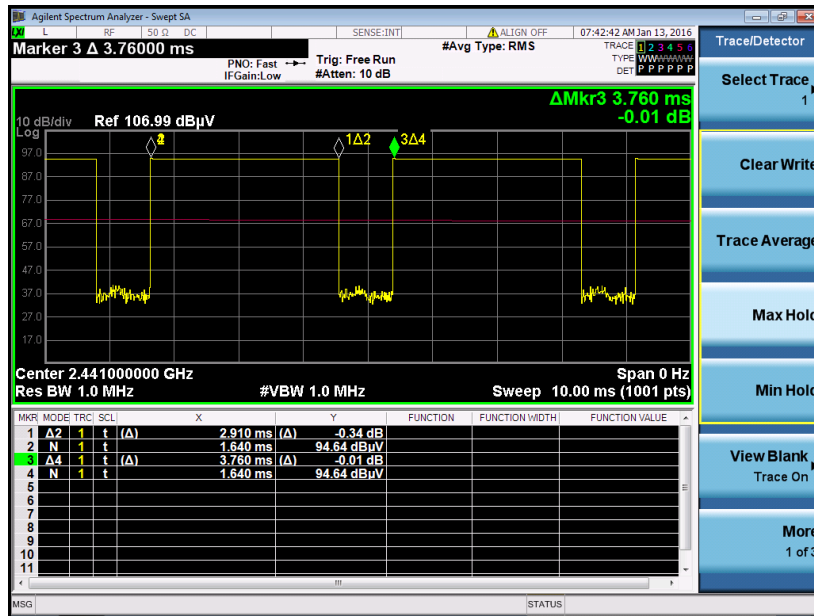

DH5 on time (Count Pulses) Plot on Channel 39

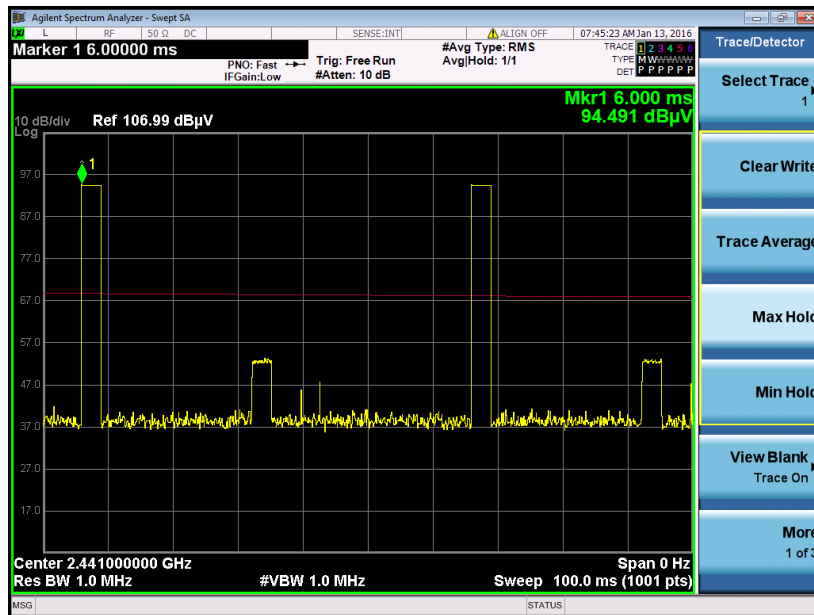

**Note:**

1. Worst case Duty cycle = on time/100 milliseconds =  $2 * 2.91 / 100 = 5.82 \%$
2. Worst case Duty cycle correction factor =  $20 * \log(\text{Duty cycle}) = -24.70 \text{ dB}$
3. DH5 has the highest duty cycle worst case and is reported.



**Duty Cycle Correction Factor Consideration for AFH mode:**

Bluetooth normal hopping rate is 1600Hz and reduced to 800Hz in AFH mode; due to the reduced number of hopping frequencies, with the same packet configuration the dwell time in each channel frequency within 100msec period is longer in AFH mode than normal mode.

In AFH mode, the minimum hopping frequencies are 20, to get the longest dwell time DH5 packet is observed; the period to have DH5 packet completing one hopping sequence is

$$2.91 \text{ ms} \times 20 \text{ channels} = 58.2 \text{ ms}$$

There cannot be 2 complete hopping sequences within 100ms period, considering the random hopping behavior, maximum 2 hops can be possibly observed within the period.  $[100\text{ms} / 57.6\text{ms}] = 2 \text{ hops}$

Thus, the maximum possible ON time:

$$2.91 \text{ ms} \times 2 = 5.82 \text{ ms}$$

Worst case Duty Cycle Correction factor, which is derived from the maximum possible ON time,

$$20 \times \log(5.82 \text{ ms}/100\text{ms}) = -24.70 \text{ dB}$$

**3.8.7 Test Result of Radiated Spurious at Band Edges**

Please refer to Appendix A & B.

**3.8.8 Test Result of Radiated Spurious Emission (30MHz ~ 10<sup>th</sup> Harmonic)**

Please refer to Appendix A & B.



### 3.9 AC Conducted Emission Measurement

#### 3.9.1 Limit of AC Conducted Emission

For equipment that is designed to be connected to the public utility (AC) power line, the radio frequency voltage that is conducted back onto the AC power line on any frequency or frequencies within the band 150 kHz to 30 MHz shall not exceed the limits in the following table.

Frequency of emission (MHz)	Conducted limit (dBµV)	
	Quasi-peak	Average
0.15-0.5	66 to 56*	56 to 46*
0.5-5	56	46
5-30	60	50

\*Decreases with the logarithm of the frequency.

#### 3.9.2 Measuring Instruments

The measuring equipment is listed in the section 4 of this test report.

#### 3.9.3 Test Procedures

1. The EUT was placed 0.4 meter from the conducting wall of the shielding room was kept at least 80 centimeters from any other grounded conducting surface.
2. Connect EUT to the power mains through a line impedance stabilization network (LISN).
3. All the support units are connecting to the other LISN.
4. The LISN provides 50 ohm coupling impedance for the measuring instrument.
5. The FCC states that a 50 ohm, 50 microhenry LISN should be used.
6. Both sides of AC line were checked for maximum conducted interference.
7. The frequency range from 150 kHz to 30 MHz was searched.
8. Set the test-receiver system to Peak Detect Function and specified bandwidth (IF Bandwidth = 9kHz) with Maximum Hold Mode. Then measurement is also conducted by Average Detector and Quasi-Peak Detector Function respectively.

### 3.9.4 Test Setup

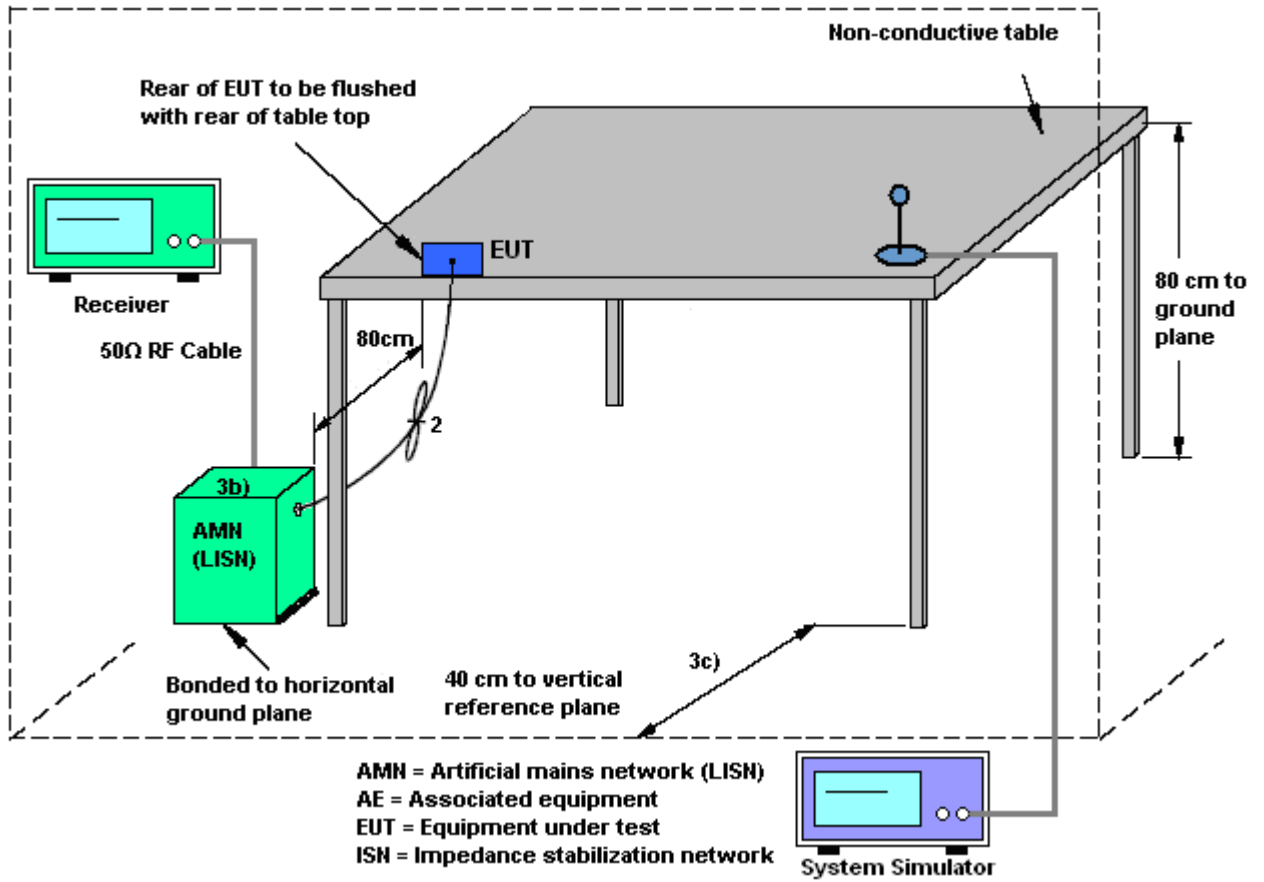



### 3.9.5 Test Result of AC Conducted Emission

Test Mode :	Mode 1	Temperature :	24~25°C
Test Engineer :	Kai Chun Chu	Relative Humidity :	51~52%
Test Voltage :	120Vac / 60Hz	Phase :	Line
Function Type :	WLAN (2.4GHz) Link + Bluetooth Link + Camera (Rear) + USB HDD + Adapter + Micro SD + Micro USB Cable ( Data Link with Notebook) + Battery + Earphone		

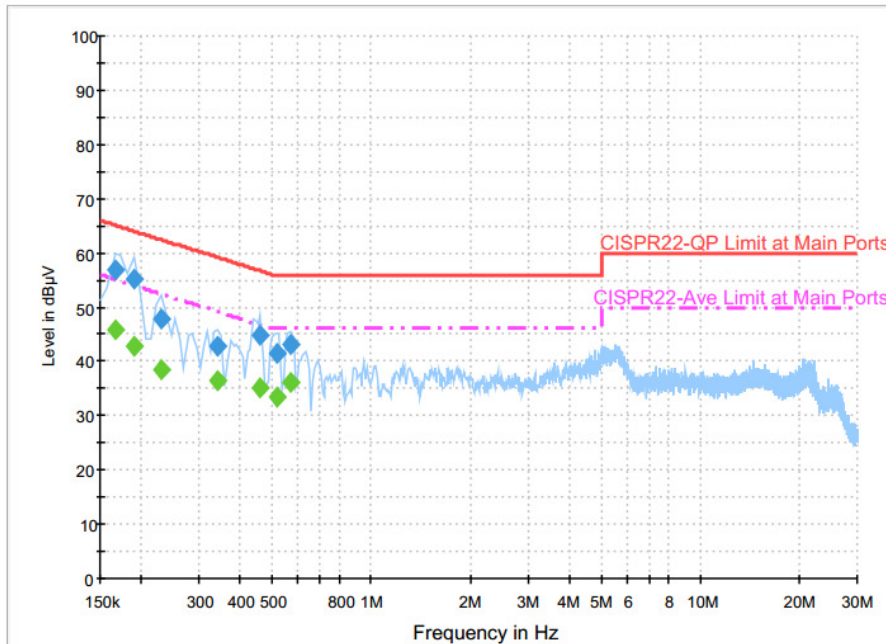

#### Final Result : Quasi-Peak

Frequency (MHz)	Quasi-Peak (dBµV)	Filter	Line	Corr. (dB)	Margin (dB)	Limit (dBµV)
0.166000	56.9	Off	L1	19.6	8.3	65.2
0.190000	55.1	Off	L1	19.6	8.9	64.0
0.230000	48.0	Off	L1	19.6	14.4	62.4
0.342000	42.8	Off	L1	19.6	16.4	59.2
0.462000	44.7	Off	L1	19.6	12.0	56.7
0.518000	41.6	Off	L1	19.6	14.4	56.0
0.566000	43.1	Off	L1	19.6	12.9	56.0

#### Final Result : Average

Frequency (MHz)	Average (dBµV)	Filter	Line	Corr. (dB)	Margin (dB)	Limit (dBµV)
0.166000	45.7	Off	L1	19.6	9.5	55.2
0.190000	42.8	Off	L1	19.6	11.2	54.0
0.230000	38.4	Off	L1	19.6	14.0	52.4
0.342000	36.5	Off	L1	19.6	12.7	49.2
0.462000	35.2	Off	L1	19.6	11.5	46.7
0.518000	33.6	Off	L1	19.6	12.4	46.0
0.566000	36.0	Off	L1	19.6	10.0	46.0



Test Mode :	Mode 1	Temperature :	24~25°C
Test Engineer :	Kai Chun Chu	Relative Humidity :	51~52%
Test Voltage :	120Vac / 60Hz	Phase :	Neutral
Function Type :	WLAN (2.4GHz) Link + Bluetooth Link + Camera (Rear) + USB HDD + Adapter + Micro SD + Micro USB Cable ( Data Link with Notebook) + Battery + Earphone		

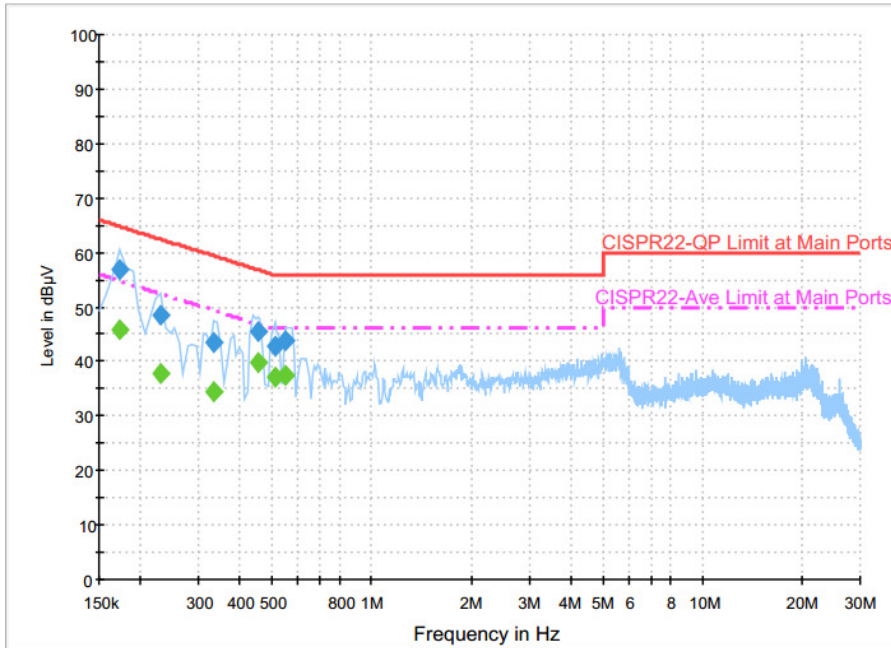

**Final Result : Quasi-Peak**

Frequency (MHz)	Quasi-Peak (dBµV)	Filter	Line	Corr. (dB)	Margin (dB)	Limit (dBµV)
0.174000	56.8	Off	N	19.6	8.0	64.8
0.230000	48.5	Off	N	19.6	13.9	62.4
0.334000	43.5	Off	N	19.6	15.9	59.4
0.454000	45.6	Off	N	19.6	11.2	56.8
0.510000	42.9	Off	N	19.6	13.1	56.0
0.550000	43.9	Off	N	19.6	12.1	56.0

**Final Result : Average**

Frequency (MHz)	Average (dBµV)	Filter	Line	Corr. (dB)	Margin (dB)	Limit (dBµV)
0.174000	45.7	Off	N	19.6	9.1	54.8
0.230000	37.9	Off	N	19.6	14.5	52.4
0.334000	34.5	Off	N	19.6	14.9	49.4
0.454000	39.8	Off	N	19.6	7.0	46.8
0.510000	37.3	Off	N	19.6	8.7	46.0
0.550000	37.4	Off	N	19.6	8.6	46.0



## **3.10 Antenna Requirements**

### **3.10.1 Standard Applicable**

If directional gain of transmitting antennas is greater than 6dBi, the power shall be reduced by the same level in dB comparing to gain minus 6dBi. The use of a permanently attached antenna or of an antenna that uses a unique coupling to the intentional radiator shall be considered sufficient to comply with the FCC rule.

### **3.10.2 Antenna Anti-Replacement Construction**

An embedded-in antenna design is used.

### **3.10.3 Antenna Gain**

The antenna peak gain of EUT is less than 6 dBi. Therefore, it is not necessary to reduce maximum peak output power limit.



## 4 List of Measuring Equipment

Instrument	Manufacturer	Model No.	Serial No.	Characteristics	Calibration Date	Test Date	Due Date	Remark
Power Meter	Agilent	E4416A	GB41292344	300MHz~40GHz	Jan. 14, 2015	Jan. 19, 2016 ~ Jan. 20, 2016	Jan. 13, 2016	Conducted (TH05-HY)
Power Sensor	Agilent	E9327A	US40441548	300MHz~40GHz	Jan. 14, 2015	Jan. 19, 2016 ~ Jan. 20, 2016	Jan. 13, 2016	Conducted (TH05-HY)
Digital Insulation Tester	Yokogawa	MY40-01	88NA2869	125V~1000V	Aug. 28, 2015	Jan. 19, 2016 ~ Jan. 20, 2016	Aug. 27, 2016	Conducted (TH05-HY)
Hygrometer	Testo	608-H2	41410069	N/A	Aug. 27, 2015	Jan. 19, 2016 ~ Jan. 20, 2016	Aug. 26, 2016	Conducted (TH05-HY)
Spectrum Analyzer	Rohde & Schwarz	FSP40	100057	9kHz-40GHz	Nov. 23, 2015	Jan. 19, 2016 ~ Jan. 20, 2016	Nov. 22, 2016	Conducted (TH05-HY)
Bilog Antenna	TESEQ	CBL 6111D	35414	30MHz~1GHz	Nov. 17, 2015	Jan. 05, 2016~ Jan. 13, 2016	Nov. 16, 2016	Radiation (03CH07-HY)
Double Ridge Horn Antenna	ESCO	3117	00075962	1GHz ~ 18GHz	Aug. 21, 2015	Jan. 05, 2016~ Jan. 13, 2016	Aug. 20, 2016	Radiation (03CH07-HY)
Horn Antenna	SCHWARZBECK	BBHA 9170	BBHA9170584	18GHz- 40GHz	Nov. 02, 2015	Jan. 05, 2016~ Jan. 13, 2016	Nov. 01, 2016	Radiation (03CH07-HY)
Hygrometer	Testo	608-H1	34897197	N/A	May. 04, 2015	Jan. 05, 2016~ Jan. 13, 2016	May. 03, 2016	Radiation (03CH07-HY)
Loop Antenna	Rohde & Schwarz	HFH2-Z2	100315	9 kHz~30 MHz	Sep. 02, 2015	Jan. 05, 2016~ Jan. 13, 2016	Sep. 01, 2016	Radiation (03CH07-HY)
Preamplifier	MITEQ	AMF-7D-0010 1800-30-10P	1590075	1GHz ~ 18GHz	Apr. 20, 2015	Jan. 05, 2016~ Jan. 13, 2016	Apr. 19, 2016	Radiation (03CH07-HY)
Preamplifier	Agilent	8449B	3008A02362	1GHz~ 26.5GHz	Oct. 19, 2015	Jan. 05, 2016~ Jan. 13, 2016	Oct. 18, 2016	Radiation (03CH07-HY)
Preamplifier	COM-POWER	PA-103A	161241	10MHz-1000MHz	Mar. 12, 2015	Jan. 05, 2016~ Jan. 13, 2016	Mar. 11, 2016	Radiation (03CH07-HY)
Spectrum Analyzer	Agilent	N9010A	MY53470118	10Hz~44GHz	Mar. 03, 2015	Jan. 05, 2016~ Jan. 13, 2016	Mar. 02, 2016	Radiation (03CH07-HY)
RF Cable	HUBER + SUHNER	SUCOFLEX 104	MY84209521	1GHz~40GHz	Dec. 02, 2015	Jan. 05, 2016~ Jan. 13, 2016	Dec. 01, 2016	Radiation (03CH07-HY)
RF Cable	HUBER + SUHNER	SUCOFLEX 104	MY84209521	9kHz~1GHz	Dec. 02, 2015	Jan. 05, 2016~ Jan. 13, 2016	Dec. 01, 2016	Radiation (03CH07-HY)
Controller	ChainTek	Chaintek 3000	N/A	Control Turn table	N/A	Jan. 05, 2016~ Jan. 13, 2016	N/A	Radiation (03CH07-HY)
Controller	Max-Full	MF7802	MF780208368	Control Ant Mast	N/A	Jan. 05, 2016~ Jan. 13, 2016	N/A	Radiation (03CH07-HY)
Antenna Mast	Max-Full	MFA520BS	N/A	1m~4m	N/A	Jan. 05, 2016~ Jan. 13, 2016	N/A	Radiation (03CH07-HY)
Turn Table	ChainTek	Chaintek 3000	N/A	0~360 degree	N/A	Jan. 05, 2016~ Jan. 13, 2016	N/A	Radiation (03CH07-HY)
EMI Test Receiver	Keysight	N9038A(MXE)	MY54130085	20Hz ~ 8.4GHz	Nov. 04, 2015	Jan. 05, 2016~ Jan. 13, 2016	Nov. 03, 2016	Radiation (03CH07-HY)
Preamplifier	MITEQ	JS44-180040 00-33-8P	1840917	18GHz ~ 40GHz	Jun. 02, 2015	Jan. 05, 2016~ Jan. 13, 2016	Jun. 01, 2016	Radiation (03CH07-HY)



Instrument	Manufacturer	Model No.	Serial No.	Characteristics	Calibration Date	Test Date	Due Date	Remark
AC Power Source	ChainTek	APC-1000W	N/A	N/A	N/A	Jan. 19, 2016	N/A	Conduction (CO05-HY)
EMI Test Receiver	Rohde & Schwarz	ESCI 7	100724	9kHz~7GHz	Aug. 26, 2015	Jan. 19, 2016	Aug. 25, 2016	Conduction (CO05-HY)
Hygrometer	Testo	608-H1	34913912	N/A	Apr. 20, 2015	Jan. 19, 2016	Apr. 19, 2016	Conduction (CO05-HY)
LISN	Rohde & Schwarz	ENV216	100080	9kHz~30MHz	Dec. 02, 2015	Jan. 19, 2016	Dec. 01, 2016	Conduction (CO05-HY)
LISN	Rohde & Schwarz	ENV216	100081	9kHz~30MHz	Dec. 14, 2015	Jan. 19, 2016	Dec. 13, 2016	Conduction (CO05-HY)
LF Cable	HUBER + SUHNER	RG-214/U	LF01	N/A	Jan. 08, 2016	Jan. 19, 2016	Jan. 07, 2017	Conduction (CO05-HY)
Pulse Limiter	Rohde & Schwarz	ESH3-Z2	100851	N/A	Jan. 08, 2016	Jan. 19, 2016	Jan. 07, 2017	Conduction (CO05-HY)



## 5 Uncertainty of Evaluation

### Uncertainty of Conducted Emission Measurement (150 kHz ~ 30 MHz)

Measuring Uncertainty for a Level of Confidence of 95% ( $U = 2Uc(y)$ )	2.70
---	------

### Uncertainty of Radiated Emission Measurement (30 MHz ~ 1000 MHz)

Measuring Uncertainty for a Level of Confidence of 95% ( $U = 2Uc(y)$ )	4.50
---	------



## Appendix A. Radiated Spurious Emission

2.4GHz 2400~2483.5MHz

BT (Band Edge @ 3m)

BT	Note	Frequency	Level	Over Limit	Limit Line	Read Level	Antenna Factor	Cable Loss	Preamp Factor	Ant Pos	Table Pos	Peak Avg.	Pol.	
		( MHz )	( dBμV/m )	( dB )	( dBμV/m )	( dBμV )	( dB/m )	( dB )	( dB )	( cm )	( deg )	(P/A)	(H/V)	
BT CH00 2402MHz		2389.69	47.38	-26.62	74	41.81	32.18	7.75	34.36	100	21	P	H	
		2389.69	22.68	-31.32	54	-	-	-	-	-	-	A	H	
	*	2402.17	98.49	-	-	92.88	32.18	7.75	34.32	100	21	P	H	
	*	2402.17	73.79	-	-	-	-	-	-	-	-	A	H	
													H	
														H
			2375	47.93	-26.07	74	42.45	32.16	7.68	34.36	100	292	P	V
			2375	23.23	-30.77	54	-	-	-	-	-	-	A	V
	*		2401.91	91.21	-	-	85.6	32.18	7.75	34.32	100	292	P	V
	*		2401.91	66.51	-	-	-	-	-	-	-	-	A	V
														V
														V
BT CH 39 2441MHz		2329.95	48.11	-25.89	74	42.86	32.09	7.6	34.44	115	29	P	H	
		2329.95	23.41	-30.59	54	-	-	-	-	-	-	A	H	
	*	2441.29	100.51	-	-	94.67	32.24	7.83	34.23	115	29	P	H	
	*	2441.29	75.81	-	-	-	-	-	-	-	-	A	H	
			2491.83	48.83	-25.17	74	42.77	32.3	7.91	34.15	115	29	P	H
			2491.83	24.13	-29.87	54	-	-	-	-	-	-	A	H
			2345.72	48.49	-25.51	74	43.1	32.11	7.68	34.4	104	294	P	V
			2345.72	23.79	-30.21	54	-	-	-	-	-	-	A	V
	*		2440.91	94.74	-	-	88.9	32.24	7.83	34.23	104	294	P	V
	*		2440.91	70.04	-	-	-	-	-	-	-	-	A	V
			2496.58	47.74	-26.26	74	41.68	32.3	7.91	34.15	104	294	P	V
			2496.58	23.04	-30.96	54	-	-	-	-	-	-	A	V



<b>BT CH 78 2480MHz</b>	*	2480	101.26	-	-	95.26	32.28	7.91	34.19	348	150	P	H
	*	2480	76.56	-	-	-	-	-	-	-	-	A	H
		2484.32	52.31	-21.69	74	46.31	32.28	7.91	34.19	348	150	P	H
		2484.32	27.61	-26.39	54	-	-	-	-	-	-	A	H
													H
													H
	*	2480	97.82	-	-	91.82	32.28	7.91	34.19	260	274	P	V
	*	2480	73.12	-	-	-	-	-	-	-	-	A	V
		2493.28	49.59	-24.41	74	43.53	32.3	7.91	34.15	260	274	P	V
		2493.28	24.89	-29.11	54	-	-	-	-	-	-	A	V
													V
													V
<b>Remark</b>	1. No other spurious found. 2. All results are PASS against Peak and Average limit line.												





2.4GHz 2400~2483.5MHz

BT (Harmonic @ 3m)

BT	Note	Frequency ( MHz )	Level ( dBμV/m )	Over Limit ( dB )	Limit Line ( dBμV/m )	Read Level ( dBμV )	Antenna Factor ( dB/m )	Cable Loss ( dB )	Preamp Factor ( dB )	Ant Pos ( cm )	Table Pos ( deg )	Peak Avg. ( P/A )	Pol. ( H/V )
BT CH 00 2402MHz		4806	41.05	-32.95	74	55.36	34.25	11.11	59.67	100	0	P	H
		4806	16.35	-37.65	54	-	-	-	-	-	-	A	H
													H
													H
		4806	40.69	-33.31	74	55	34.25	11.11	59.67	100	0	P	V
		4806	15.99	-38.01	54	-	-	-	-	-	-	A	V
													V
													V
BT CH 39 2441MHz		4884	41.91	-32.09	74	55.97	34.3	11.21	59.57	100	0	P	H
		4884	17.21	-36.79	54	-	-	-	-	-	-	A	H
		7323	42.41	-31.59	74	50.22	35.6	15.08	58.49	100	0	P	H
		7323	17.71	-36.29	54	-	-	-	-	-	-	A	H
		4884	41.59	-32.41	74	55.65	34.3	11.21	59.57	100	0	P	V
		4884	16.89	-37.11	54	-	-	-	-	-	-	A	V
		7323	41.56	-32.44	74	49.37	35.6	15.08	58.49	100	0	P	V
		7323	16.86	-37.14	54	-	-	-	-	-	-	A	V
BT CH 78 2480MHz		4962	46.63	-27.37	74	60.39	34.37	11.32	59.45	100	0	P	H
		4962	21.93	-32.07	54	-	-	-	-	-	-	A	H
		7440	41.76	-32.24	74	49.67	35.6	15.13	58.64	100	0	P	H
		7440	17.06	-36.94	54	-	-	-	-	-	-	A	H
		4962	45.13	-28.87	74	58.89	34.37	11.32	59.45	100	0	P	V
		4962	20.43	-33.57	54	-	-	-	-	-	-	A	V
		7440	41.24	-32.76	74	49.15	35.6	15.13	58.64	100	0	P	V
		7440	16.54	-37.46	54	-	-	-	-	-	-	A	V
Remark	1. No other spurious found. 2. All results are PASS against Peak and Average limit line.												



Emission below 1GHz

2.4GHz BT (LF)

BT	Note	Frequency	Level	Over	Limit	Read	Antenna	Cable	Preamp	Ant	Table	Peak	Pol.	
		( MHz )	( dBμV/m )	( dB )	( dBμV/m )	( dBμV )	( dB/m )	( dB )	( dB )	( cm )	( deg )	( P/A )	( H/V )	
2.4GHz BT LF		30.27	28.08	-11.92	40	32.11	25.7	1.77	31.5	100	0	P	H	
		163.38	29.59	-13.91	43.5	41.64	16.5	2.61	31.16			P	H	
		251.13	25.87	-20.13	46	35.11	18.8	2.96	31			P	H	
		345.5	30.07	-15.93	46	36.74	20.97	3.39	31.03			P	H	
		575.8	32.21	-13.79	46	33.63	25.27	4.01	30.7			P	H	
		973.4	35.21	-18.79	54	30.03	30.55	4.94	30.31			P	H	
														H
														H
														H
														H
														H
														H
														H
			38.37	34.75	-5.25	40	43.34	20.86	1.77	31.22	100	0	P	V
			162.84	26.14	-17.36	43.5	38.1	16.6	2.61	31.17			P	V
			264.63	24.12	-21.88	46	32.46	19.5	3.16	31			P	V
			345.5	31.58	-14.42	46	38.25	20.97	3.39	31.03			P	V
			575.8	33.14	-12.86	46	34.56	25.27	4.01	30.7			P	V
			989.5	35.57	-18.43	54	30.26	30.52	5.03	30.24			P	V
														V
													V	
													V	
													V	
													V	
													V	
Remark	1. No other spurious found. 2. All results are PASS against limit line.													



**Note symbol**

*	<b>Fundamental Frequency</b> which can be ignored. However, the level of any unwanted emissions shall not exceed the level of the fundamental frequency.
!	Test result is <b>over limit</b> line.
P/A	<b>Peak</b> or <b>Average</b>
H/V	<b>Horizontal</b> or <b>Vertical</b>



A calculation example for radiated spurious emission is shown as below:

WIFI	Note	Frequency	Level	Over	Limit	Read	Antenna	Cable	Preamp	Ant	Table	Peak	Pol.
Ant.				Limit	Line	Level	Factor	Loss	Factor	Pos	Pos	Avg.	
1+2		( MHz )	( dBμV/m )	( dB )	( dBμV/m )	( dBμV )	( dB/m )	( dB )	( dB )	( cm )	( deg )	( P/A )	( H/V )
802.11b		2390	55.45	-18.55	74	54.51	32.22	4.58	35.86	103	308	P	H
CH 01													
2412MHz		2390	43.54	-10.46	54	42.6	32.22	4.58	35.86	103	308	A	H

- Level(dBμV/m) =  
Antenna Factor(dB/m) + Cable Loss(dB) + Read Level(dBμV) - Preamp Factor(dB)
- Over Limit(dB) = Level(dBμV/m) – Limit Line(dBμV/m)

**For Peak Limit @ 2390MHz:**

- Level(dBμV/m)  
= Antenna Factor(dB/m) + Cable Loss(dB) + Read Level(dBμV) - Preamp Factor(dB)  
= 32.22(dB/m) + 4.58(dB) + 54.51(dBμV) – 35.86 (dB)  
= 55.45 (dBμV/m)
- Over Limit(dB)  
= Level(dBμV/m) – Limit Line(dBμV/m)  
= 55.45(dBμV/m) – 74(dBμV/m)  
= -18.55(dB)

**For Average Limit @ 2390MHz:**

- Level(dBμV/m)  
= Antenna Factor(dB/m) + Cable Loss(dB) + Read Level(dBμV) - Preamp Factor(dB)  
= 32.22(dB/m) + 4.58(dB) + 42.6(dBμV) – 35.86 (dB)  
= 43.54 (dBμV/m)
- Over Limit(dB)  
= Level(dBμV/m) – Limit Line(dBμV/m)  
= 43.54(dBμV/m) – 54(dBμV/m)  
= -10.46(dB)

**Both peak and average measured complies with the limit line, so test result is “PASS”.**



## Appendix B. Radiated Spurious Emission Plots

2.4GHz 2400~2483.5MHz

BT (Band Edge @ 3m)

BT	2.4GHz 2400~2483.5MHz Band Edge @ 3m	
ANT	BT CH00 2402MHz	
1	Horizontal	Vertical
Peak	<p>Site : 03CH07-HY            Condition : FCC CLASS-B 3m HF-ANT_130829 HORIZONTAL            RBW:1000.000kHz VBW:3000.000kHz SWT:Auto            Detector : Peak</p>	<p>Site : 03CH07-HY            Condition : FCC CLASS-B 3m HF-ANT_130829 VERTICAL            RBW:1000.000kHz VBW:3000.000kHz SWT:Auto            Detector : Peak</p>

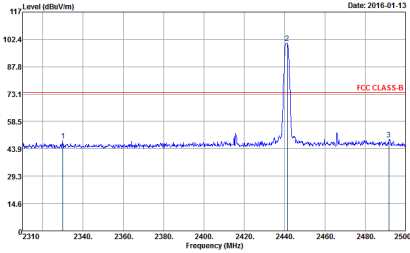
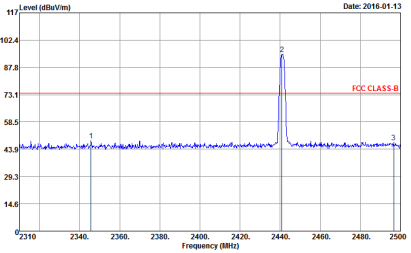

BT	2.4GHz 2400~2483.5MHz Band Edge @ 3m	
ANT	BT CH39 2441MHz - L	
1	Horizontal	Vertical
Peak	 <p data-bbox="347 904 592 949">Site : 03CH07-HY Condition : FCC CLASS-B 3m HF-ANT_130829 HORIZONTAL RBW:1000.000kHz VBW:3000.000kHz SWT:Auto Detector : Peak</p>	 <p data-bbox="946 904 1190 949">Site : 03CH07-HY Condition : FCC CLASS-B 3m HF-ANT_130829 VERTICAL RBW:1000.000kHz VBW:3000.000kHz SWT:Auto Detector : Peak</p>

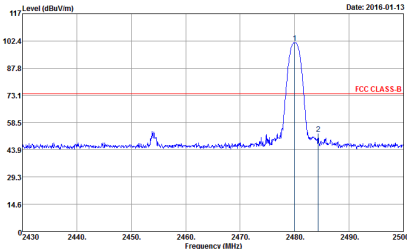
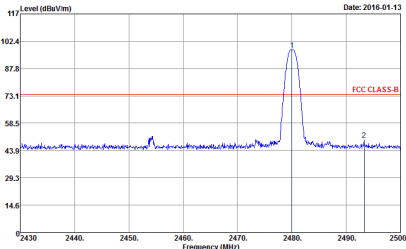

BT	2.4GHz 2400~2483.5MHz Band Edge @ 3m	
ANT	BT CH78 2480MHz	
1	Horizontal	Vertical
Peak	 <p data-bbox="347 904 592 949">Site : 03CH07.HY Condition : FCC CLASS-B 3m HF-ANT_130829 HORIZONTAL RBW:1000.000kHz VBW:3000.000kHz SW1:Auto Detector : Peak</p>	 <p data-bbox="903 904 1147 949">Site : 03CH07.HY Condition : FCC CLASS-B 3m HF-ANT_130829 VERTICAL RBW:1000.000kHz VBW:3000.000kHz SW1:Auto Detector : Peak</p>



2.4GHz 2400~2483.5MHz

BT (Harmonic @ 3m)

BT	2.4GHz 2400~2483.5MHz Harmonic @ 3m	
ANT	BT CH00 2402MHz	
1	Horizontal	Vertical
Peak Avg.	<p>Site : 03CH07HY Condition : FCC CLASS-B 3m SHF-EHF_131029 HORIZONTAL Detector : Peak</p>	<p>Site : 03CH07HY Condition : FCC CLASS-B 3m SHF-EHF_131029 VERTICAL Detector : Peak</p>





BT	2.4GHz 2400~2483.5MHz Harmonic @ 3m	
ANT	BT CH39 2441MHz	
1	Horizontal	Vertical
<p><b>Peak</b> <b>Avg.</b></p>	<p>Site : 03CH074Y Condition : FCC CLASS-B 3m SHF-EHF_131029 HORIZONTAL Detector : Peak</p>	<p>Site : 03CH074Y Condition : FCC CLASS-B 3m SHF-EHF_131029 VERTICAL Detector : Peak</p>

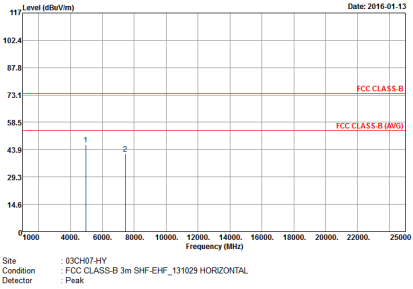
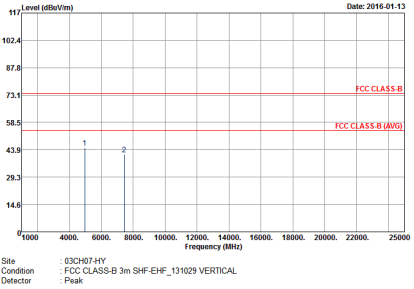

BT	2.4GHz 2400~2483.5MHz Harmonic @ 3m	
ANT	BT CH78 2480MHz	
1	Horizontal	Vertical
<p>Peak Avg.</p>	 <p>Site : 03CH074HY Condition : FCC CLASS-B 3m SHF-EHF_131029 HORIZONTAL Detector : Peak</p>	 <p>Site : 03CH074HY Condition : FCC CLASS-B 3m SHF-EHF_131029 VERTICAL Detector : Peak</p>



**Emission below 1GHz**

**2.4GHz BT (LF)**

BT	2.4GHz 2400~2483.5MHz	
ANT	BT LF	
1	Horizontal	Vertical
<p><b>QP / Peak</b></p>	<p>Site : 03CH07HY Condition : FCC CLASS:B 3m LF_ANT_35414(6) HORIZONTAL Detector : Peak</p>	<p>Site : 03CH07HY Condition : FCC CLASS:B 3m LF_ANT_35414(6) VERTICAL Detector : Peak</p>