

DFS TEST REPORT

REPORT NO.: RF140312C10-2

MODEL NO.: N435

FCC ID: P4Q-N435WIFI

RECEIVED: Mar. 12, 2014

TESTED: Jul. 07, 2014

ISSUED: Jul. 09, 2014

APPLICANT: MiTAC International Corp.

ADDRESS: Building B, No. 209, Sec. 1, Nan Gang Rd.,
Nan Gang Dist., Taipei 11568, Taiwan, R.O.C.

ISSUED BY: Bureau Veritas Consumer Products Services
(H.K.) Ltd., Taoyuan Branch

TEST LOCATION: No. 47, 14th Ling, Chia Pau Vil., Lin Kou Dist.,
New Taipei City, Taiwan (R.O.C.)

TEST LOCATION: No. 19, Hwa Ya 2nd Rd, Wen Hwa Tsuen, Kwei
Shan Hsiang, Taoyuan Hsien 333, Taiwan,
R.O.C.

This report should not be used by the client to claim product certification, approval, or endorsement by TAF or any government agencies.



This report is for your exclusive use. Any copying or replication of this report to or for any other person or entity, or use of our name or trademark, is permitted only with our prior written permission. This report sets forth our findings solely with respect to the test samples identified herein. The results set forth in this report are not indicative or representative of the quality or characteristics of the lot from which a test sample was taken or any similar or identical product unless specifically and expressly noted. Our report includes all of the tests requested by you and the results thereof based upon the information that you provided to us. You have 60 days from date of issuance of this report to notify us of any material error or omission caused by our negligence, provided, however, that such notice shall be in writing and shall specifically address the issue you wish to raise. A failure to raise such issue within the prescribed time shall constitute your unqualified acceptance of the completeness of this report, the tests conducted and the correctness of the report contents. Unless specific mention, the uncertainty of measurement has been explicitly taken into account to declare the compliance or non-compliance to the specification.

Table of Contents

| | |
|---|----|
| RELEASE CONTROL RECORD | 3 |
| 1. CERTIFICATION | 4 |
| 2. EUT INFORMATION | 5 |
| 2.1 OPERATING FREQUENCY BANDS AND MODE OF EUT | 5 |
| 2.2 EUT SOFTWARE AND FIRMWARE VERSION | 5 |
| 2.3 DESCRIPTION OF AVAILABLE ANTENNAS TO THE EUT | 5 |
| 2.4 EUT MAXIMUM CONDUCTED POWER | 6 |
| 2.5 EUT MAXIMUM E.I.R.P. POWER | 7 |
| 2.6 TRANSMIT POWER CONTROL (TPC) | 8 |
| 2.7 STATEMENT OF MAUNFACTURER | 8 |
| 3. U-NII DFS RULE REQUIREMENTS | 9 |
| 3.1 WORKING MODES AND REQUIRED TEST ITEMS | 9 |
| 3.2 TEST LIMITS AND RADAR SIGNAL PARAMETERS | 10 |
| 4. TEST & SUPPORT EQUIPMENT LIST | 12 |
| 4.1 TEST INSTRUMENTS | 12 |
| 4.2 DESCRIPTION OF SUPPORT UNITS | 12 |
| 5. TEST PROCEDURE | 13 |
| 5.1 ADT DFS MEASUREMENT SYSTEM | 13 |
| 5.2 CALIBRATION OF DFS DETECTION THRESHOLD LEVEL | 14 |
| 5.3 DEVIATION FROM TEST STANDARD | 15 |
| 5.4 RADIATED TEST SETUP CONFIGURATION | 15 |
| 5.4.1 CLIENT WITHOUT RADAR DETECTION MODE | 15 |
| 6. TEST RESULTS | 16 |
| 6.1 SUMMARY OF TEST RESULT | 16 |
| 6.2 TEST RESULTS | 17 |
| 6.2.1 TEST MODE: DEVICE OPERATING IN CLIENT WITHOUT RADAR DETECTION MODE | 17 |
| 6.2.2 CHANNEL CLOSING TRANSMISSION AND CHANNEL MOVE TIME | 18 |
| 6.2.3 NON-OCCUPANCY PERIOD | 20 |
| 6.2.4 NON-ASSOCIATED TEST | 22 |
| 6.2.5 NON- CO-CHANNEL TEST | 22 |
| 7. TESTING LABORATORIES INFORMATION | 23 |



RELEASE CONTROL RECORD

| ISSUE NO. | REASON FOR CHANGE | DATE ISSUED |
|---------------|-------------------|---------------|
| RF140312C10-2 | Original release | Jul. 09, 2014 |



1. CERTIFICATION

PRODUCT: Tablet PC
MODEL: N435
BRAND: Mio, Mitac, Code, Janam, Stryker
APPLICANT: MiTAC International Corp.
TESTED: Jul. 07, 2014
TEST SAMPLE: PRODUCTION UNIT
STANDARDS: **FCC Part 15, Subpart E (Section 15.407)**
FCC 06-96

The above equipment (Model: N435) has been tested by **Bureau Veritas Consumer Products Services (H.K.) Ltd., Taoyuan Branch**, and found compliance with the requirement of the above standards. The test record, data evaluation & Equipment Under Test (EUT) configurations represented herein are true and accurate accounts of the measurements of the sample's EMC characteristics under the conditions specified in this report.

PREPARED BY :  , **DATE** : Jul. 09, 2014
Pettie Chen / Senior Specialist

APPROVED BY :  , **DATE** : Jul. 09, 2014
Ken Liu / Senior Manager

2. EUT INFORMATION

2.1 OPERATING FREQUENCY BANDS AND MODE OF EUT

Table 1: Operating Frequency Bands And Mode Of Eut

| OPERATIONAL MODE | OPERATING FREQUENCY RANGE | |
|--|---------------------------|--------------|
| | 5250~5350MHz | 5470~5725MHz |
| Client without radar detection and ad hoc function | ✓ | ✓ |

Note: The EUT doesn't operate in 5600 ~ 5650MHz via software controls.

2.2 EUT SOFTWARE AND FIRMWARE VERSION

Table 2: The EUT Software/Firmware Version

| NO. | PRODUCT | MODEL NO. | SOFTWARE/FIRMWARE VERSION |
|-----|-----------|-----------|--|
| 1 | Tablet PC | N435 | With CCX/Without CCX Baseband Version: 22.90 Kernel Version: 3.4.48-00452-gcc195a8 buildmach@fx8120-server #1 Wed May 7 04:15:22 CST 2014 |

2.3 DESCRIPTION OF AVAILABLE ANTENNAS TO THE EUT

Table 3: Antenna List

| ANT NO. | ANTENNA TYPE | OPERATION FREQUENCY RANGE (MHz) | MAX. GAIN (dBi) |
|---------|--------------|---------------------------------|-----------------|
| 1 | PCB | 5250-5350 MHz | 2.9 |
| 1 | PCB | 5470-5725 MHz | 3.8 |

2.4 EUT MAXIMUM CONDUCTED POWER

Table 4: The Measured Conducted Output Power

802.11a

| ANT NO. | FREQUENCY BAND (MHz) | MAX. POWER | |
|---------|----------------------|-------------------|------------------|
| | | OUTPUT POWER(dBm) | OUTPUT POWER(mW) |
| 1 | 5250~5350 | 13.96 | 24.89 |
| 1 | 5470~5725 | 16.19 | 41.59 |

802.11n HT20

| ANT NO. | FREQUENCY BAND (MHz) | MAX. POWER | |
|---------|----------------------|-------------------|------------------|
| | | OUTPUT POWER(dBm) | OUTPUT POWER(mW) |
| 1 | 5250~5350 | 14.17 | 26.12 |
| 1 | 5470~5725 | 16.05 | 40.27 |

802.11n HT40

| ANT NO. | FREQUENCY BAND (MHz) | MAX. POWER | |
|---------|----------------------|-------------------|------------------|
| | | OUTPUT POWER(dBm) | OUTPUT POWER(mW) |
| 1 | 5250~5350 | 15.76 | 37.67 |
| 1 | 5470~5725 | 12.48 | 17.70 |

2.5 EUT MAXIMUM E.I.R.P. POWER

Table 5: The EIRP Output Power List

802.11a

| ANT NO. | FREQUENCY BAND (MHz) | MAX. POWER | |
|---------|----------------------|-------------------|------------------|
| | | OUTPUT POWER(dBm) | OUTPUT POWER(mW) |
| 1 | 5250~5350 | 16.86 | 48.53 |
| 1 | 5470~5725 | 19.99 | 99.77 |

802.11n HT20

| ANT NO. | FREQUENCY BAND (MHz) | MAX. POWER | |
|---------|----------------------|-------------------|------------------|
| | | OUTPUT POWER(dBm) | OUTPUT POWER(mW) |
| 1 | 5250~5350 | 17.07 | 50.93 |
| 1 | 5470~5725 | 19.85 | 96.61 |

802.11n HT40

| ANT NO. | FREQUENCY BAND (MHz) | MAX. POWER | |
|---------|----------------------|-------------------|------------------|
| | | OUTPUT POWER(dBm) | OUTPUT POWER(mW) |
| 1 | 5250~5350 | 18.66 | 73.45 |
| 1 | 5470~5725 | 16.28 | 42.46 |

2.6 TRANSMIT POWER CONTROL (TPC)

U-NII devices operating in the 5.25-5.35 GHz band and the 5.47-5.725 GHz band shall employ a TPC mechanism. The U-NII device is required to have the capability to operate at least 6 dB below the mean EIRP value of 30 dBm. A TPC mechanism is not required for systems with an e.i.r.p. of less than 500 mW.

Maximum EIRP of this device is 99.77mW which less than 500mW, therefore it's not require TPC function.

2.7 STATEMENT OF MAUNFACTURER

Manufacturer statement confirming that information regarding the parameters of the detected Radar Waveforms is not available to the end user. **And the device doesn't have Ad Hoc mode on DFS frequency band.**

3. U-NII DFS RULE REQUIREMENTS

3.1 WORKING MODES AND REQUIRED TEST ITEMS

The manufacturer shall state whether the EUT is capable of operating as a Master and/or a Client. If the EUT is capable of operating in more than one operating mode then each operating mode shall be tested separately. See tables 6 and 7 for the applicability of DFS requirements for each of the operational modes.

Table 6: Applicability of DFS requirements prior to use a channel

| Requirement | Operational Mode | | |
|---------------------------------|------------------|--------------------------------|-----------------------------|
| | Master | Client without radar detection | Client with radar detection |
| Non-Occupancy Period | ✓ | Not required | ✓ |
| DFS Detection Threshold | ✓ | Not required | ✓ |
| Channel Availability Check Time | ✓ | Not required | Not required |
| Uniform Spreading | ✓ | Not required | Not required |
| U-NII Detection Bandwidth | ✓ | Not required | ✓ |

Table 7: Applicability of DFS requirements during normal operation

| Requirement | Operational Mode | | |
|-----------------------------------|------------------|--------------------------------|-----------------------------|
| | Master | Client without radar detection | Client with radar detection |
| DFS Detection Threshold | ✓ | Not required | ✓ |
| Channel Closing Transmission Time | ✓ | ✓ | ✓ |
| Channel Move Time | ✓ | ✓ | ✓ |
| U-NII Detection Bandwidth | ✓ | Not required | ✓ |

3.2 TEST LIMITS AND RADAR SIGNAL PARAMETERS

DETECTION THRESHOLD VALUES

Table 8: DFS Detection Thresholds for Master Devices and Client Devices With Radar Detection.

| Maximum Transmit Power | Value (See Notes 1 and 2) |
|------------------------|------------------------------|
| ≥ 200 milliwatt | -64 dBm |
| < 200 milliwatt | -62 dBm |

Note 1: This is the level at the input of the receiver assuming a 0 dBi receive antenna.
 Note 2: Throughout these test procedures an additional 1 dB has been added to the amplitude of the test transmission waveforms to account for variations in measurement equipment. This will ensure that the test signal is at or above the detection threshold level to trigger a DFS response.

Table 9: DFS Response Requirement Values

| Parameter | Value |
|-----------------------------------|---|
| Non-occupancy period | Minimum 30 minutes |
| Channel Availability Check Time | 60 seconds |
| Channel Move Time | 10 seconds See Note 1. |
| Channel Closing Transmission Time | 200 milliseconds + an aggregate of 60 milliseconds over remaining 10 second period. See Notes 1 and 2. |
| U-NII Detection Bandwidth | Minimum 80% of the UNII 99% transmission power bandwidth. See Note 3. |

Note 1: The instant that the Channel Move Time and the Channel Closing Transmission Time begins is as follows:

- For the Short Pulse Radar Test Signals this instant is the end of the Burst.
- For the Frequency Hopping radar Test Signal, this instant is the end of the last radar Burst generated.
- For the Long Pulse Radar Test Signal this instant is the end of the 12 second period defining the Radar Waveform.

Note 2: The Channel Closing Transmission Time is comprised of 200 milliseconds starting at the beginning of the Channel Move Time plus any additional intermittent control signals required to facilitate a Channel move (an aggregate of 60 milliseconds) during the remainder of the 10 second period. The aggregate duration of control signals will not count quiet periods in between transmissions.

Note 3: During the U-NII Detection Bandwidth detection test, radar type 1 is used and for each frequency step the minimum percentage of detection is 90 percent. Measurements are performed with no data traffic.

PARAMETERS OF DFS TEST SIGNALS

Step intervals of 0.1 microsecond for Pulse Width, 1 microsecond for PRI, 1 MHz for chirp width and 1 for the number of pulses will be utilized for the random determination of specific test waveforms.

Table 10: Short Pulse Radar Test Waveforms.

| Radar Type | Pulse Width (µsec) | PRI (µsec) | Number of Pulses | Minimum Percentage of Successful Detection | Minimum Number of Trials |
|-----------------------------|--------------------|------------|------------------|--|--------------------------|
| 1 | 1 | 1428 | 18 | 60% | 30 |
| 2 | 1-5 | 150-230 | 23-29 | 60% | 30 |
| 3 | 6-10 | 200-500 | 16-18 | 60% | 30 |
| 4 | 11-20 | 200-500 | 12-16 | 60% | 30 |
| Aggregate (Radar Types 1-4) | | | | 80% | 120 |

Table 11: Long Pulse Radar Test Waveform

| Radar Type | Pulse Width (µsec) | Chirp Width (MHz) | PRI (µsec) | Number of Pulses per Burst | Number of Bursts | Minimum Percentage of Successful Detection | Minimum Number of Trials |
|------------|--------------------|-------------------|------------|----------------------------|------------------|--|--------------------------|
| 5 | 50-100 | 5-20 | 1000-2000 | 1-3 | 8-20 | 80% | 30 |

Table 12: Frequency Hopping Radar Test Waveform

| Radar Type | Pulse Width (µsec) | PRI (µsec) | Pulses per Hop | Hopping Rate (kHz) | Hopping Sequence Length (msec) | Minimum Percentage of Successful Detection | Minimum Number of Trials |
|------------|--------------------|------------|----------------|--------------------|--------------------------------|--|--------------------------|
| 6 | 1 | 333 | 9 | 0.333 | 300 | 70% | 30 |

4. TEST & SUPPORT EQUIPMENT LIST

4.1 TEST INSTRUMENTS

Table 13: Test Instruments List

| DESCRIPTION & MANUFACTURER | MODEL NO. | BRAND | CALIBRATED UNTIL |
|----------------------------|-----------|-----------|------------------|
| R&S Spectrum analyzer | FSP40 | R&S | 2015/03/02 |
| Signal generator | 8645A | Agilent | 2015/06/23 |
| Oscilloscope | TDS 5104 | Tektronix | 2015/03/19 |

4.2 DESCRIPTION OF SUPPORT UNITS

Table 14: Support Unit Information

| NO. | PRODUCT | BRAND | MODEL NO. | FCC ID | SPEC. |
|-----|---------|--------|-----------|-----------------|--|
| 1 | Router | D-Link | DIR-868L | RRK2012060056-1 | 5G Ant gain : 3.428dB Maximum EIRP : 27.64dBm |

NOTE: This device was functioned as a Master Slave device during the DFS test.

Table 15: Software/Firmware Information

| NO. | PRODUCT | MODEL NO. | SOFTWARE/FIRMWARE VERSION |
|-----|---------|-----------|---------------------------|
| 1. | Router | DIR-868L | 1.00 |

5. TEST PROCEDURE

5.1 ADT DFS MEASUREMENT SYSTEM

A complete ADT DFS Measurement System consists of two subsystems: (1) the Radar Signal Generating Subsystem and (2) the Traffic Monitoring Subsystem. The control PC is necessary for generating the Radar waveforms in Table 10, 11 and 12. The traffic monitoring subsystem is specified to the type of unit under test (UUT).

Radiated setup configuration of ADT DFS Measurement System

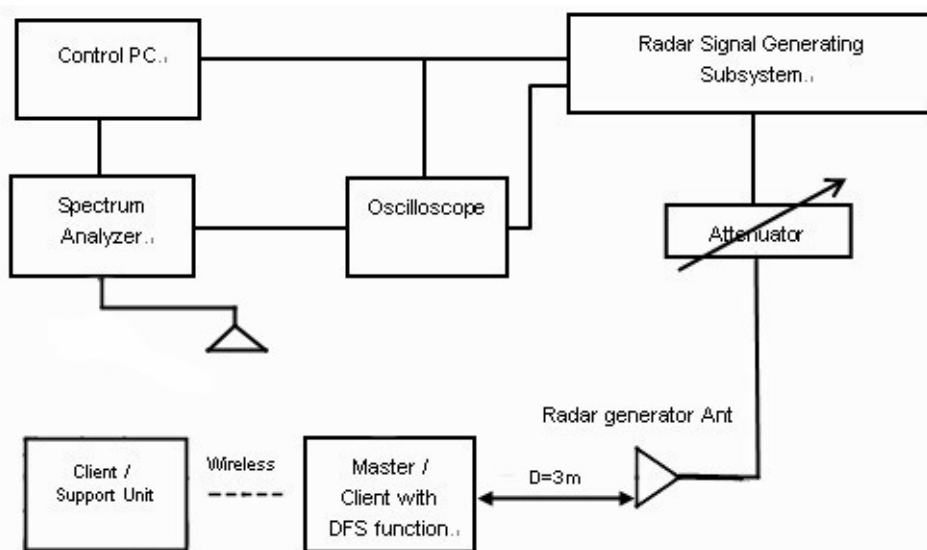

The test transmission will always be from the Master Device to the Client Device. While the Client device is set up to associate with the Master device and play the MPEG file (6 $\frac{1}{2}$ Magic Hours) from Master device, the designated MPEG test file and instructions are located at:

<http://ntiacsd.ntia.doc.gov/dfs/>.

5.2 CALIBRATION OF DFS DETECTION THRESHOLD LEVEL

The measured channel is 5500MHz and 5510MHz. The radar signal was the same as transmitted channels, and injected into the antenna of AP (master) or Client Device with Radar Detection, measured the channel closing transmission time and channel move time. The calibrated detection threshold level is set to -64dBm. The tested level is lower than required level hence it provides margin to the limit.

Radiated setup configuration of Calibration of DFS Detection Threshold Level

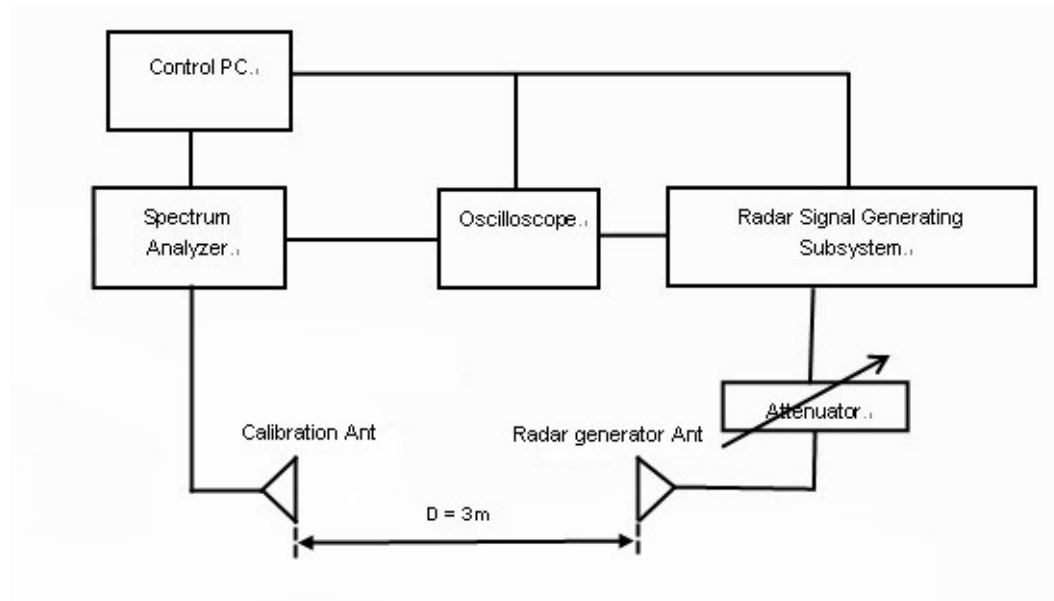

5.3 DEVIATION FROM TEST STANDARD

No deviation.

5.4 RADIATED TEST SETUP CONFIGURATION

5.4.1 CLIENT WITHOUT RADAR DETECTION MODE

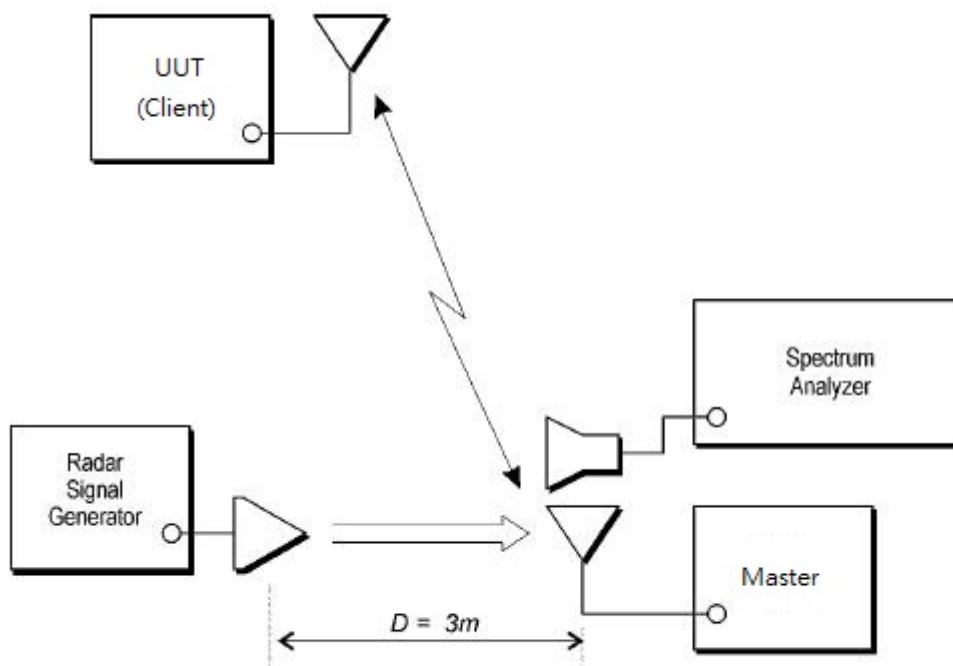

The UUT is a U-NII Device operating in Client mode without radar detection. The radar test signals are injected into the Master Device.

6. TEST RESULTS

6.1 SUMMARY OF TEST RESULT

| Clause | Test Parameter | Remarks | Pass/Fail |
|--------|-----------------------------------|----------------|-----------|
| 15.407 | DFS Detection Threshold | Not Applicable | NA |
| 15.407 | Channel Availability Check Time | Not Applicable | NA |
| 15.407 | Channel Move Time | Applicable | Pass |
| 15.407 | Channel Closing Transmission Time | Applicable | Pass |
| 15.407 | Non- Occupancy Period | Applicable | Pass |
| 15.407 | Uniform Spreading | Not Applicable | NA |
| 15.407 | U-NII Detection Bandwidth | Not Applicable | NA |
| 15.407 | Non-associated test | Applicable | Pass |
| 15.407 | Non-Co-Channel test | Applicable | Pass |

6.2 TEST RESULTS

6.2.1 TEST MODE: DEVICE OPERATING IN CLIENT WITHOUT RADAR DETECTION MODE

Client with injection at the Master. (The radar test signals are injected into the Master Device)

DFS DETECTION THRESHOLD

For a detection threshold level of -64dBm, the required signal strength at EUT antenna location is -64 dBm. The tested level is lower than required level hence it provides margin to the limit.

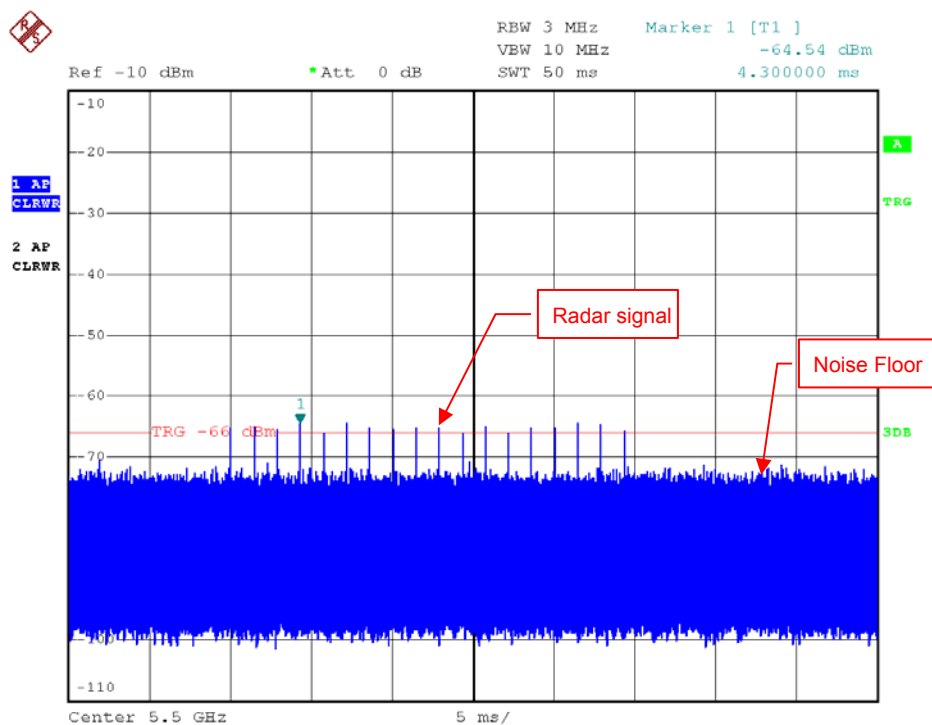

Radar Signal 1

6.2.2 CHANNEL CLOSING TRANSMISSION AND CHANNEL MOVE TIME

RADAR SIGNAL 1

802.11a 20MHz

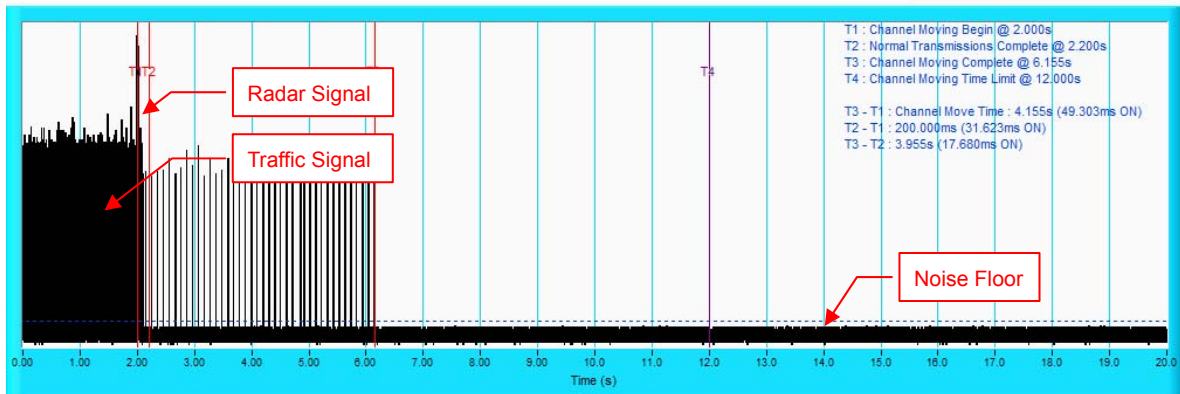

NOTE: T1 denotes the start of Channel Move Time upon the end of the last Radar burst. T2 denotes the data transmission time of 200ms from T1. T3 denotes the end of Channel Move Time. T4 denotes the 10 second from T1 to observe the aggregate duration of transmissions.

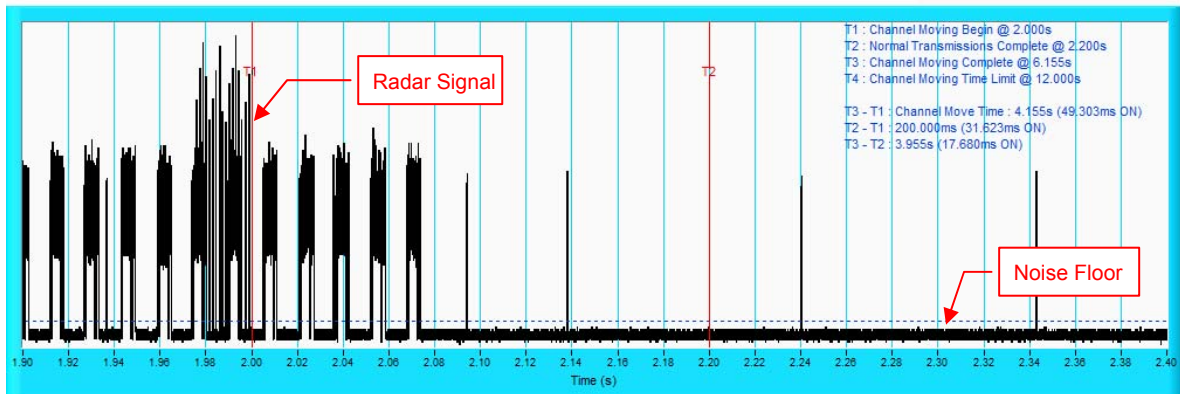

NOTE: An expanded plot for the device vacates the channel in the required 500ms.

RADAR SIGNAL 1

802.11n 40MHz

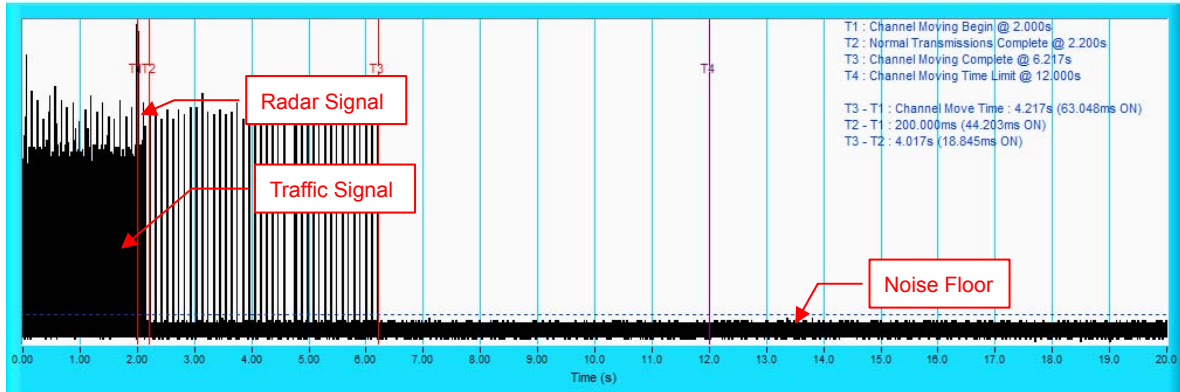

NOTE: T1 denotes the start of Channel Move Time upon the end of the last Radar burst. T2 denotes the data transmission time of 200ms from T1. T3 denotes the end of Channel Move Time. T4 denotes the 10 second from T1 to observe the aggregate duration of transmissions.

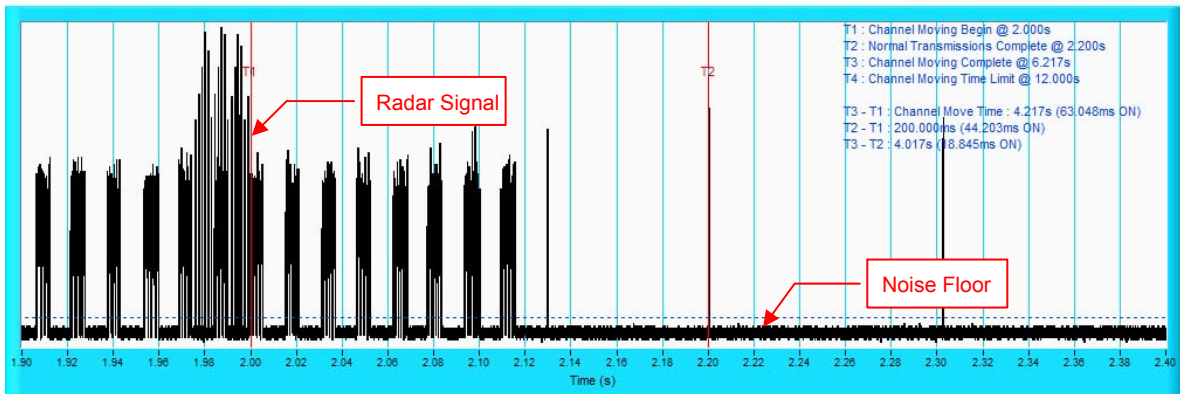

NOTE: An expanded plot for the device vacates the channel in the required 500ms.

6.2.3 NON-OCCUPANCY PERIOD

Associate test:

During the 30 minutes observation time, UUT did not make any transmissions on a channel after a radar signal was detected on that channel by either the Channel Availability Check or the In-Service Monitoring.

1) EUT (Client) links with master on 5500MHz.

Waveform of EUT links up with Master

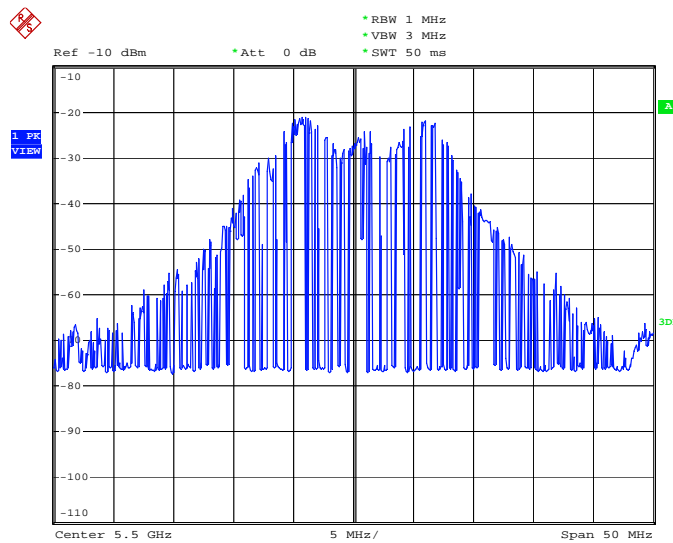

2) Client plays specified files via master.

Waveform of transmission

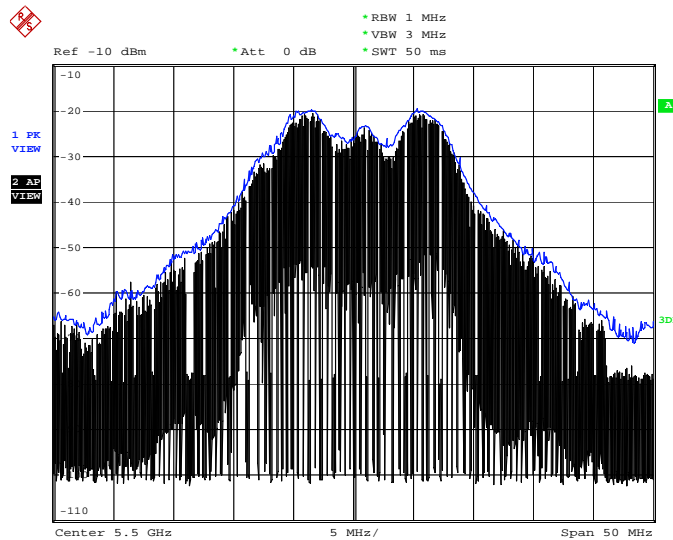

3) Radar signal 1 is applied to the Master device and WiFi traffic signal stop immediately.

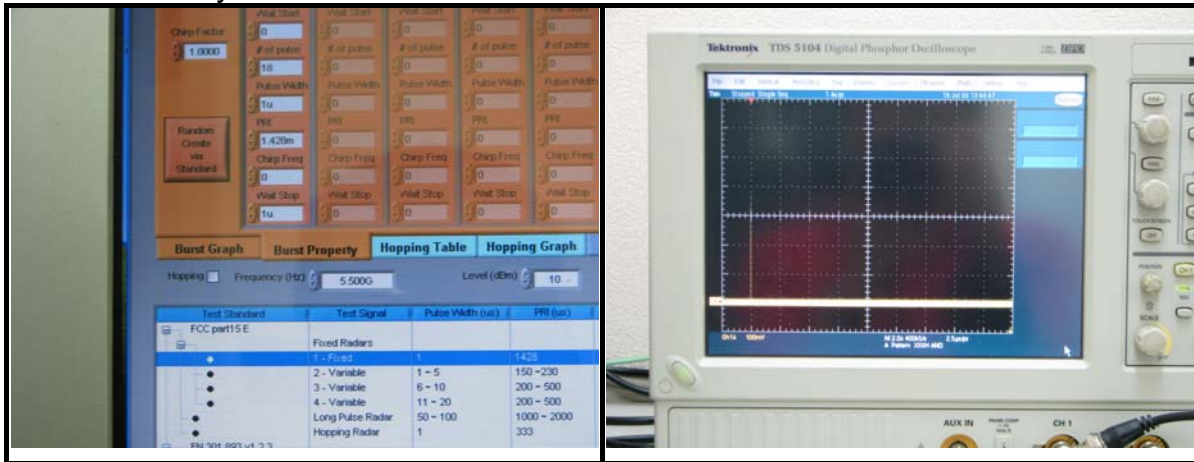

4) 5500MHz has been monitored in 30 minutes period. In this period, no any transmission occurs.

Plot of 30minutes period

802.11n 20MHz

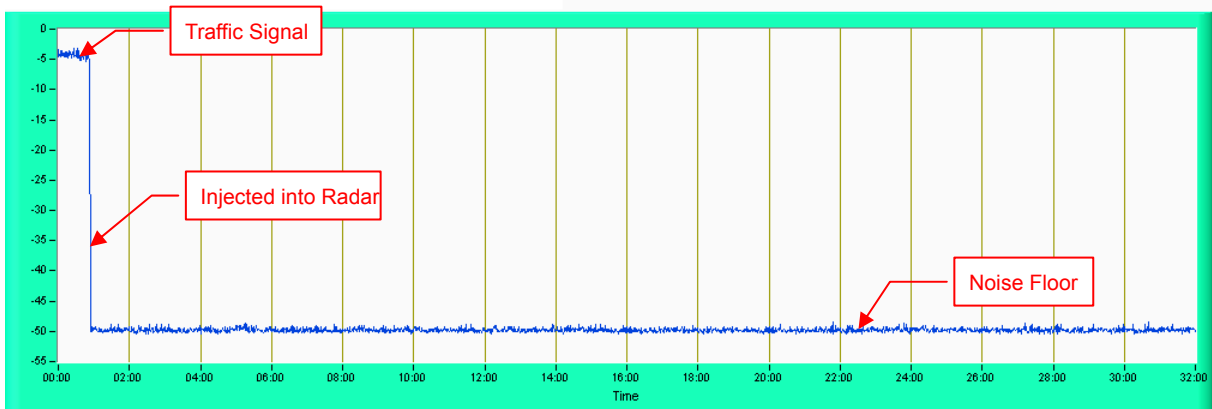

NOTE: Test setup are shown on Test set up photo.pdf

6.2.4 NON-ASSOCIATED TEST

Master was off.

During the 30 minutes observation time, The UUT did not make any transmissions in the DFS band after UUT power up.

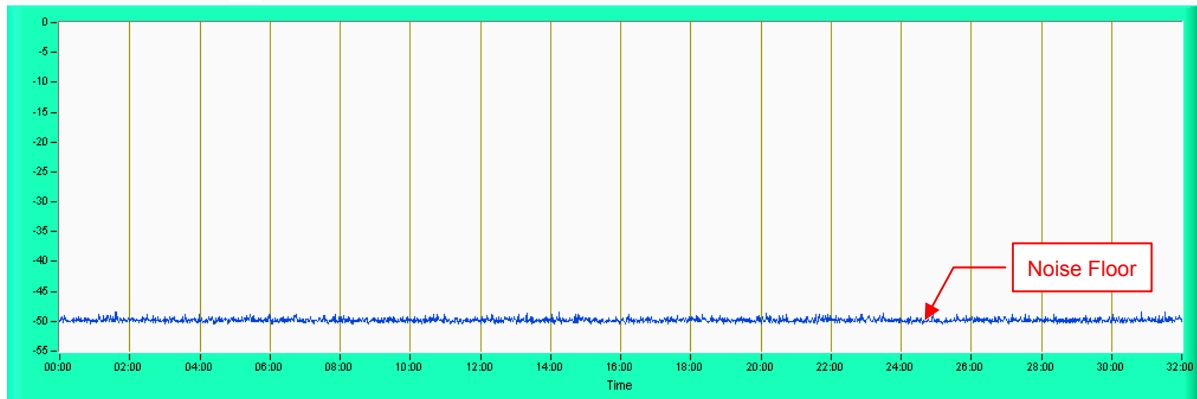

6.2.5 NON- CO-CHANNEL TEST

The UUT was investigated after radar was detected the channel and made sure no co-channel operation with radars.

7. TESTING LABORATORIES INFORMATION

We, Bureau Veritas Consumer Products Services (H.K.) Ltd., Taoyuan Branch, were founded in 1988 to provide our best service in EMC, Radio, Telecom and Safety consultation. Our laboratories are accredited and approved according to ISO/IEC 17025.

If you have any comments, please feel free to contact us at the following:

Linko EMC/RF Lab:

Tel: 886-2-26052180

Fax: 886-2-26051924

Hsin Chu EMC/RF Lab:

Tel: 886-3-5935343

Fax: 886-3-5935342

Hwa Ya EMC/RF/Safety Telecom Lab:

Tel: 886-3-3183232

Fax: 886-3-3270892

Email: service.adt@tw.bureauveritas.com

Web Site: www.bureauveritas-adt.com

The address and road map of all our labs can be found in our web site also.

---END---