

PRINTED SCALE: 2:1



Cyclo505



Model: N429
Input: 5V 1A (max)
FCC ID: P4Q-N429 IC: 2420C-N429



Designed in Belgium
Assembled in China

FRONT COVER

Plastic Color:
White

Painting:
White Painting as Donbon
PX-1 735-645

LOGO:
Front Silk Print Pantone Cool Gray 7C

DECORATION REAR

Plastic Color:
Pantone Process Black C

Texture:
Non Texture (Polished Surface)

Painting:
Donbon AU-2 735-406-1 / Rb28 735-494

Logo:
Silk Print Pantone Cool Gray 9C

ENGRAVED ICON SCALE: 2:1



DECORATION FRONT

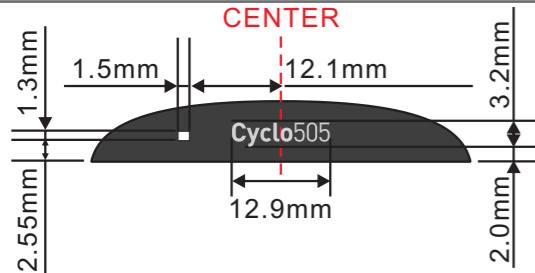

Back Print : Pantone Process Black C
LED White Area : Non Print (1.5mm x 1.3mm)
LOGO: Back Silk Print Pantone 877C (Silver)

TOUCH PANEL

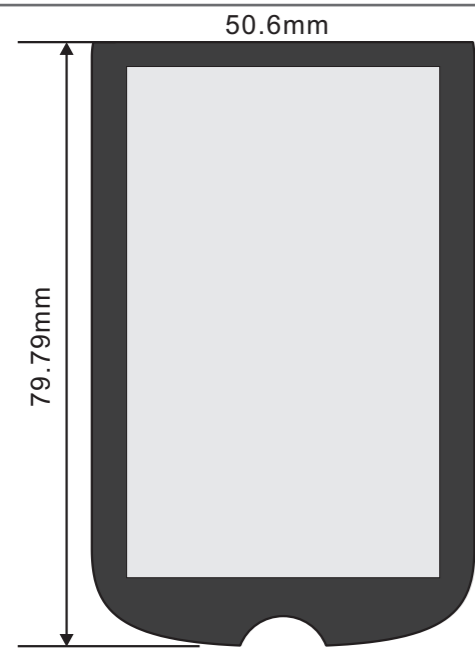

BLACK AREA:
Back Print Pantone Black C

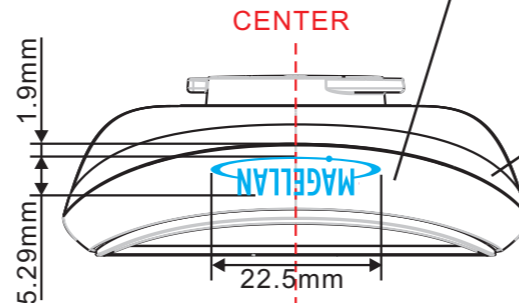

REAR COVER

Material:
Black Plastic

Texture:
MT11010

RATING LABEL

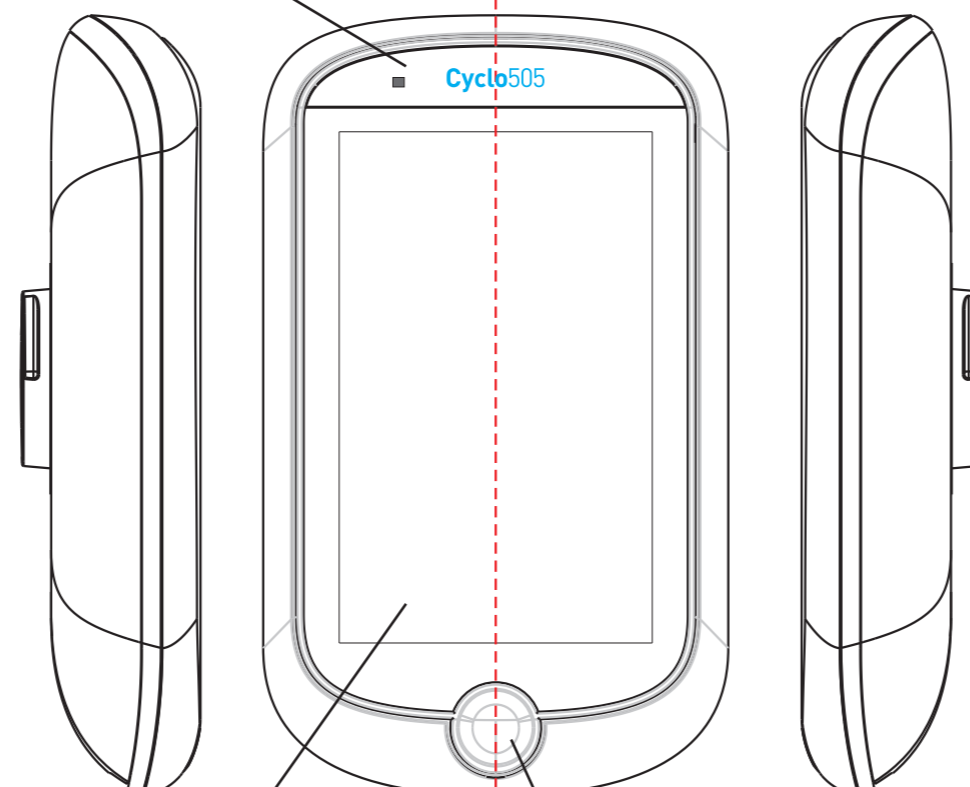
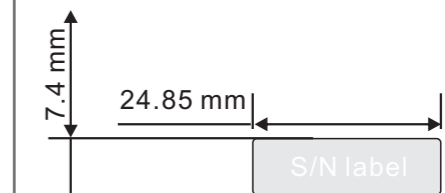

Front Button Material:
Double Injection Rubber
Rubber Color:
Pantone Process Black C

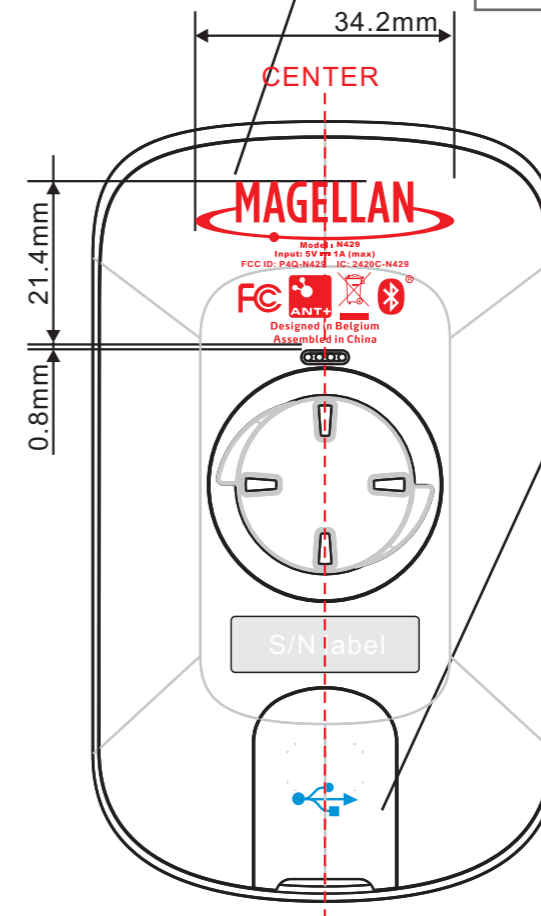

USB COVER

Material:
Pantone Process Black C
Rubber

Texture:
MPT-EDM-10 (Fine Texture)

USB Icon:
Engraved 0.3mm

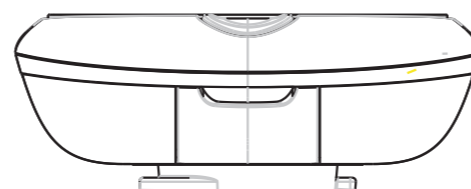

ITEM	PART NAME	PART NO.	QTY/SET	MATERIAL(SPEC)	REMARK
MATERIAL(SPEC)		QUANTITY/SET		MiTAC International Corp.	
		1 PC.		DESCRIPTION	
FINISH		DRAWN		Magellen NA Cyclo 505	
		郭瑞元 Ray.Kuo		SCALE 1:1	
		02/27/2014		DRAWING NO. VERSION. R01	
		ISSUED		UNIT mm	
		郭瑞元 Ray.Kuo		FILE NAME	
		02/27/2014		MODEL NO.	
		CHECKED			
		APPROVED			
SELECT	TOL.	1	2	3	4
~8	0.03	0.05	0.10	0.20	
8~25	0.05	0.08	0.20	0.30	
25~80	0.08	0.12	0.30	0.40	
80~250	0.12	0.20	0.40	0.50	
250~	0.20	0.30	0.50	0.60	