



FCC TEST REPORT

for

47 CFR Part 22H, 24E

Equipment : PDA phone
Trade Name : MiTAC
Model No. : A702
FCC ID : P4Q-MIOA702
Tx Frequency Range : GSM850 : 824~849 MHz
PCS1900 : 1850~1910 MHz
Max. ERP/EIRP Power : GSM850(GSM) : 0.42 W
GSM850(EDGE) : 0.10 W
PCS1900(GSM) : 0.24 W
PCS1900(EDGE) : 0.26 W
Emission Designator : GSM : 300KGXW
EDGE : 300KG7W
Applicant : **MiTAC International Corp.**
No. 1, Yen-Fa 2nd Rd., Hsin-Chu Science Based
Industrial Park, Hsin-Chu Hsien, Taiwan, R.O.C.

- The test result refers exclusively to the test presented test model / sample.
- Without written approval of SPORTON International Inc., the test report shall not be reproduced except in full.
- **Certificate or Test Report must not be used by the applicant to claim the product in this test report endorsement by NVLAP or any agency of U.S. government.**
- The data shown in this test report were carried out on May 26, 2007 at **Sporton International Inc. LAB.**
- Report No.: FG742004-01, Report Version: Rev. 01.

Roy Wu
Deputy Manager

SPORTON International Inc.

6F, No.106, Sec. 1, Hsin Tai Wu Rd., Hsi Chih, Taipei Hsien, Taiwan, R.O.C.



Table of Contents

History of this test report.....ii

1. General Information 1

 1.1. Applicant1

 1.2. Manufacturer1

 1.3. Basic Description of Equipment under Test.....1

 1.4. Feature of Equipment under Test2

 1.5. Report Date.....2

2 Test Configuration of Equipment under Test3

 2.1 Test Manner3

 2.2 Test Mode3

 2.3 Connection Diagram of Test System3

 2.4 Ancillary Equipment List.....4

3. General Information of Test Site5

 3.1 Test Voltage5

 3.2 Test in Compliance with5

 3.3 Frequency Range Investigated5

 3.4 Test Distance5

4. Test Data and Test Result.....6

 4.1 List of Measurements and Examinations6

 4.2 RF Output Power7

 4.3 ERP / EIRP Measurement8

 4.4 Occupied Bandwidth and Band Edge Measurement12

 4.5 Conducted Emission25

 4.6 Field Strength of Spurious Radiation35

 4.7 Frequency Stability (Temperature Variation)77

 4.8 Frequency Stability (Voltage Variation).....79

5 List of Measurement Equipments80

6 Uncertainty Evaluation.....81

- Appendix A - External Photographs**
- Appendix B - Internal Photographs**
- Appendix C - Setup Photographs**



1. General Information

1.1. Applicant

MiTAC International Corp.

No. 1, Yen-Fa 2nd Rd., Hsin-Chu Science Based Industrial Park, Hsin-Chu Hsien, Taiwan, R.O.C.

1.2 Manufacturer

Mitac computer (Kunshan) CO., Ltd.

No. 269, 2nd Road , Export Processing Zone, Changjiang South Road, KunShan,JiangSu prov.China

1.3 Basic Description of Equipment under Test

Equipment : PDA phone
Trade Name : MiTAC
Model No. : A702
FCC ID : P4Q-MIOA702
Power Supply Type : Switching, From Battery 3.7V
AC Power Cord : AC 120V, Wall-mount, 1.5 meter, 2 pin
Adapter : PHIHONG, PSB05R-050Q
Battery : Welldone, E4MT211303B12
Earphone : BIMOS, 70425-02



1.4 Feature of Equipment under Test

DUT Type :	PDA phone
Trade Name :	MiTAC
Model Name :	A702
FCC ID :	P4Q-MIOA702
Tx Frequency :	GSM850 : 824 ~ 849 MHz PCS1900 : 1850 ~ 1910 MHz WLAN / Bluetooth : 2400 ~ 2483.5
Rx Frequency :	GSM850 : 869 ~ 894 MHz PCS1900 : 1930 ~ 1990 MHz WLAN / Bluetooth : 2400 ~ 2483.5
Maximum Output Power to Antenna :	GSM850(GSM) : 32.80 dBm GSM850(EDGE) : 26.11 dBm PCS1900(GSM) : 30.81 dBm PCS1900(EDGE) : 23.72 dBm Bluetooth : -0.47 dBm 802.11b : 13.92 dBm ; 802.11g : 18.42 dBm
Maximum ERP/EIRP :	GSM850(GSM) : 0.42 W (26.27 dBm) GSM850(EDGE) : 0.10 W (20.04 dBm) PCS1900(GSM) : 0.24 W (23.72 dBm) PCS1900(EDGE) : 0.26 W (24.10 dBm)
Antenna Type :	Fixed Internal
Type of Antenna Connector	N/A
Antenna Gain	WLAN : -3.5 dBi Bluetooth : -3.5 dBi
HW Version	R02
SW Version	R30
Power Rating (DC/AC , Voltage and Current of RF element or PA) :	DC 3.7V / 1130 mA
Digital Modulation Emission :	GSM : GMSK EDGE : 8PSK WLAN : DSSS / OFDM Bluetooth : GFSK
Type of Emission :	GSM : 300KGXW EDGE : 300KG7W
Device Power Class :	GSM850 : 4 PCS1900 : 1
DUT Stage :	Production Unit

1.5 Report Date

EUT Received : Apr. 26, 2007

Report Date : Jun. 05, 2007

2 Test Configuration of Equipment under Test

2.1 Test Manner

- a. The spurious emission measurements were carried out in semi-anechoic chamber with 3-meter test range.
- b. During all testings, EUT is in link mode with base station emulator at maximum power level.
- c. Frequency range investigated: radiated emission 30 MHz to 9000 MHz for GSM850; 30MHz to 19000 MHz for PCS1900.

2.2 Test Mode

Application	GSM850	PCS1900
Radiated Emission	<input checked="" type="checkbox"/> Mode 1: GSM Link <input checked="" type="checkbox"/> Mode 2: EDGE Link <input checked="" type="checkbox"/> Mode 5: GSM Link + WLAN Link	<input checked="" type="checkbox"/> Mode 3: GSM Link <input checked="" type="checkbox"/> Mode 4: EDGE Link
Conducted Measurement	<input checked="" type="checkbox"/> Mode 1: GSM Link <input checked="" type="checkbox"/> Mode 2: EDGE Link	<input checked="" type="checkbox"/> Mode 3: GSM Link <input checked="" type="checkbox"/> Mode 4: EDGE Link

2.3 Connection Diagram of Test System

Mode 1-4

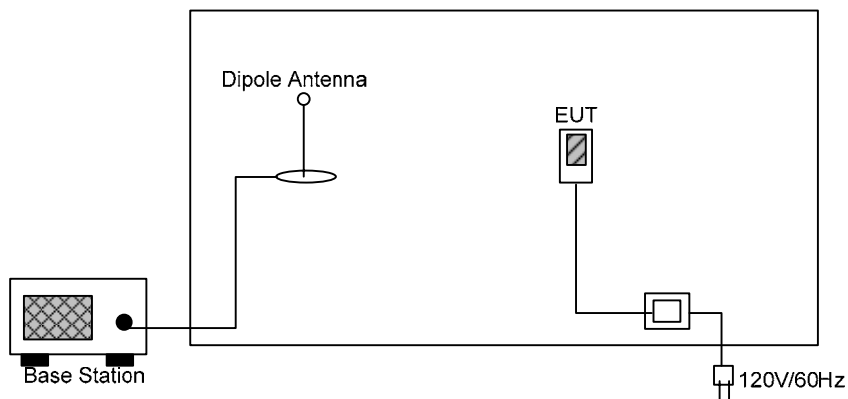

Mode 5

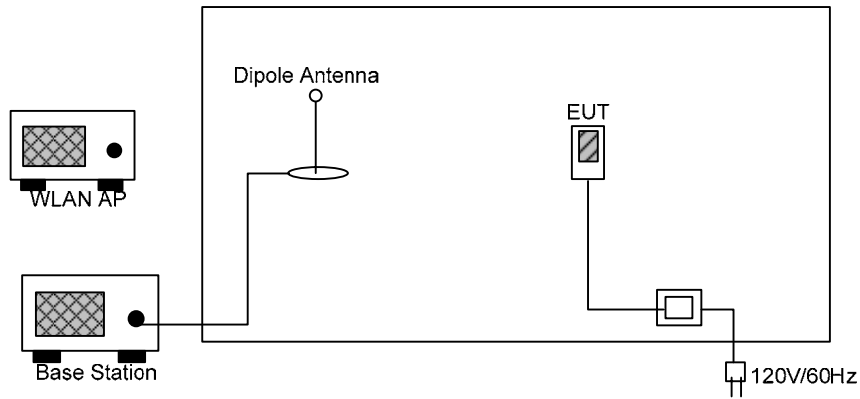

2.4 Ancillary Equipment List

Item	Equipment	Model No.	Serial No.
1.	Base Station(R&S)	CMU200	106656
2.	WLAN AP (SMC)	SMC-100	N/A



3. General Information of Test Site

Test Site Location : No. 52, Hwa Ya 1st Rd., Hwa Ya Technology Park,
Kwei-Shan Hsiang, Tao Yuan Hsien, Taiwan, R.O.C.
TEL : 886-3-327-3456
FAX : 886-3-318-0055
Test Site No : TH02-HY, 03CH06-HY

The chamber meets the characteristics of ANSI C63.4-2003. This site is on file with the FCC.

3.1 Test Voltage

120V/ 60Hz

3.2 Test in Compliance with

47 CFR Part 22H, 24E, Part 2

3.3 Frequency Range Investigated

- a. Radiation: from 30MHz to 9000MHz for GSM850.
- b. Radiation: from 30 MHz to 19000 MHz for PCS1900.

3.4 Test Distance

The test distance of radiated emission from antenna to EUT is 3 m.



4. Test Data and Test Result

4.1 List of Measurements and Examinations

FCC Rule	DESCRIPTION OF TEST	Result	Section
§2.1046	RF Output Power	Passed	4.2
§ 22.913 §24.232	ERP / EIRP	Passed	4.3
§2.1049, § 22.917, § 24.238(b)	Occupied Bandwidth & Band Edge Measurement	Passed	4.4
§2.1051	Conducted Emission	Passed	4.5
§2.1053	Field Strength of Spurious Radiation	Passed	4.6
§2.1055, § 22.355, §24.235	Frequency Stability vs. Temperature	Passed	4.7
§2.1055, §22.355, §24.235	Frequency Stability vs. Voltage	Passed	4.8

4.2 RF Output Power

4.2.1 Measurement Instruments :

As described in chapter 5 of this test report.

4.2.2 Test Procedure :

1. The transmitter output was connected to power meter and base station through power divider.
2. Set EUT at PCL=5 for GSM850 and/or PCL=0 for PCS1900 maximum power through base station.
3. Select lowest, middle, and highest channels for each band.

4.2.3 Test Setup Layout :

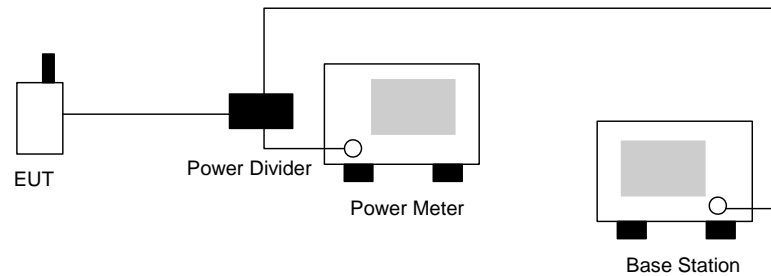

4.2.4 Test Result :

Bands	Channel	Frequency (MHz)	Conducted Power (dBm)	Conducted Power (Watts)
GSM850 (GSM)	128	824.2 (Low)	32.61	1.824
	189	836.4 (Mid)	32.78	1.897
	251	848.8 (High)	32.80	1.905
GSM850 (EDGE)	128	824.2 (Low)	26.09	0.406
	189	836.4 (Mid)	26.10	0.407
	251	848.8 (High)	26.11	0.408
PCS1900 (GSM)	512	1850.2 (Low)	30.81	1.205
	661	1880.0 (Mid)	30.61	1.151
	810	1909.8 (High)	29.88	0.973
PCS1900 (EDGE)	512	1850.2 (Low)	23.66	0.232
	661	1880.0 (Mid)	23.72	0.236
	810	1909.8 (High)	23.63	0.231



4.3 ERP / EIRP Measurement

Equivalent isotropic radiated power measurements by substitution method according to ANSI/TIA/EIA-603-C.

4.3.1 Measurement Instruments

As described in chapter 5 of this test report.

4.3.2 Test Procedure

1. The EUT was placed on a rotatable table with 1.0 meter height in an fully anechoic chamber.
2. The EUT was set 1.2 meters from the receiving antenna which was mounted on the antenna tower.
3. The table was rotated 360 degrees to determine the position of the highest radiated power.
4. The height of the receiving antenna is also kept at 1.0M height.
5. Taking the record of maximum ERP/EIRP.
6. A dipole antenna was substituted in place of the EUT and was driven by a signal generator.
7. The conducted power at the terminal of the dipole antenna is measured.
8. Repeat step 3 to step 5 to get the maximum ERP/EIRP of the substitution antenna.
9. $ERP/EIRP = P_s + E_t - E_s + G_s = P_s + R_t - R_s + G_s$

P_s (dBm) : Input power to substitution antenna.

G_s (dBi or dBd) : Substitution antenna Gain.

$E_t = R_t + AF$

$E_s = R_s + AF$

AF (dB/m) : Receive antenna factor

R_t : The highest received signal in Spectrum Analyzer for EUT.

R_s : The highest received signal in spectrum analyzer for substitution antenna.

4.3.3 Test Setup Layout of ERP/EIRP

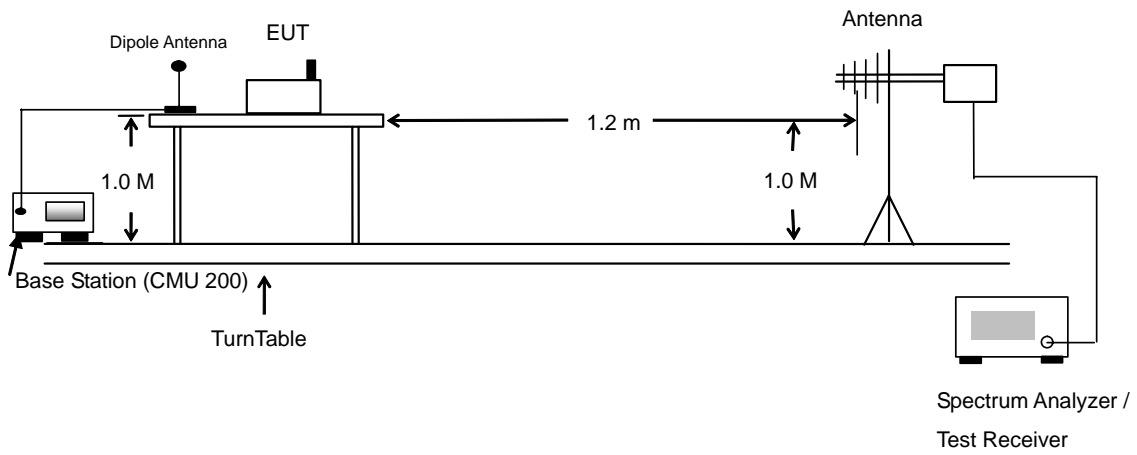



4.3.4 Test Result

GSM850 (GSM) Radiated Power ERP						
Horizontal Polarization						
Frequency (MHz)	Rt (dBm)	Rs (dBm)	Ps (dBm)	Gs (dBd)	ERP (dBm)	ERP (W)
824.20	-22.29	-48.12	0.00	-1.08	24.75	0.30
836.40	-21.60	-48.28	0.00	-0.93	25.75	0.38
848.80	-21.32	-48.35	0.00	-0.76	26.27	0.42
Vertical Polarization						
Frequency (MHz)	Rt (dBm)	Rs (dBm)	Ps (dBm)	Gs (dBd)	ERP (dBm)	ERP (W)
824.20	-38.01	-47.97	0.00	-1.08	8.88	0.01
836.40	-37.38	-48.01	0.00	-0.93	9.70	0.01
848.80	-37.22	-48.05	0.00	-0.76	10.07	0.01

PCS1900 (GSM) Radiated Power EIRP						
Horizontal Polarization						
Frequency (MHz)	Rt (dBm)	Rs (dBm)	Ps (dBm)	Gs (dBi)	EIRP (dBm)	EIRP (W)
1850.20	-30.12	-51.88	0.00	1.96	23.72	0.24
1880.00	-32.30	-52.99	0.00	2.00	22.69	0.19
1909.80	-34.13	-54.28	0.00	1.98	22.13	0.16
Vertical Polarization						
Frequency (MHz)	Rt (dBm)	Rs (dBm)	Ps (dBm)	Gs (dBi)	EIRP (dBm)	EIRP (W)
1850.20	-30.82	-52.13	0.00	1.96	23.27	0.21
1880.00	-33.42	-53.17	0.00	2.00	21.75	0.15
1909.80	-35.22	-54.13	0.00	1.98	20.89	0.12



GSM850 (EDGE) Radiated Power ERP						
Horizontal Polarization						
Frequency (MHz)	Rt (dBm)	Rs (dBm)	Ps (dBm)	Gs (dBd)	ERP (dBm)	ERP (W)
824.20	-27.43	-48.12	0.00	-1.08	19.61	0.09
836.40	-27.44	-48.28	0.00	-0.93	19.91	0.10
848.80	-27.55	-48.35	0.00	-0.76	20.04	0.10
Vertical Polarization						
Frequency (MHz)	Rt (dBm)	Rs (dBm)	Ps (dBm)	Gs (dBd)	ERP (dBm)	ERP (W)
824.20	-42.70	-47.97	0.00	-1.08	4.19	0.00
836.40	-42.30	-48.01	0.00	-0.93	4.78	0.00
848.80	-42.97	-48.05	0.00	-0.76	4.32	0.00

PCS1900 (EDGE) Radiated Power EIRP						
Horizontal Polarization						
Frequency (MHz)	Rt (dBm)	Rs (dBm)	Ps (dBm)	Gs (dBi)	EIRP (dBm)	EIRP (W)
1850.20	-29.74	-51.88	0.00	1.96	24.10	0.26
1880.00	-31.63	-52.99	0.00	2.00	23.36	0.22
1909.80	-33.14	-54.28	0.00	1.98	23.12	0.21
Vertical Polarization						
Frequency (MHz)	Rt (dBm)	Rs (dBm)	Ps (dBm)	Gs (dBi)	EIRP (dBm)	EIRP (W)
1850.20	-30.22	-52.13	0.00	1.96	23.87	0.24
1880.00	-32.53	-53.17	0.00	2.00	22.64	0.18
1909.80	-34.22	-54.13	0.00	1.98	21.89	0.15

4.4 Occupied Bandwidth and Band Edge Measurement

4.4.1 Measurement Instruments

As described in chapter 5 of this test report.

4.4.2 Test Procedure

1. The EUT was connected to Spectrum Analyzer and Base Station via power divider.
2. The 99% occupied bandwidth of middle channel for the highest and lowest RF powers were measured.
3. The bandedge of low and high channels for the highest RF powers within the transmitting frequency band were measured. Setting RBW as roughly $BW/100$.

4.4.3 Test Setup Layout

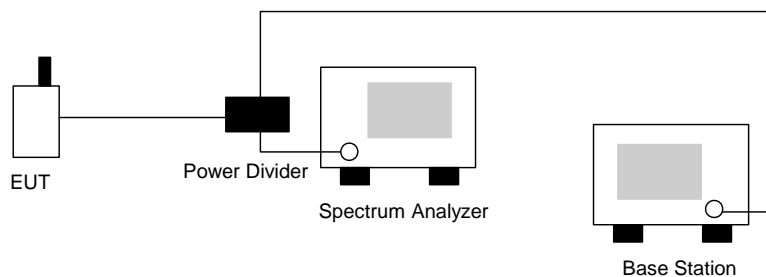



4.4.4 Test Result

- Mode 1
- Test Mode : GSM850 (GSM) CH128 Lower Band Edge
- Power State : High

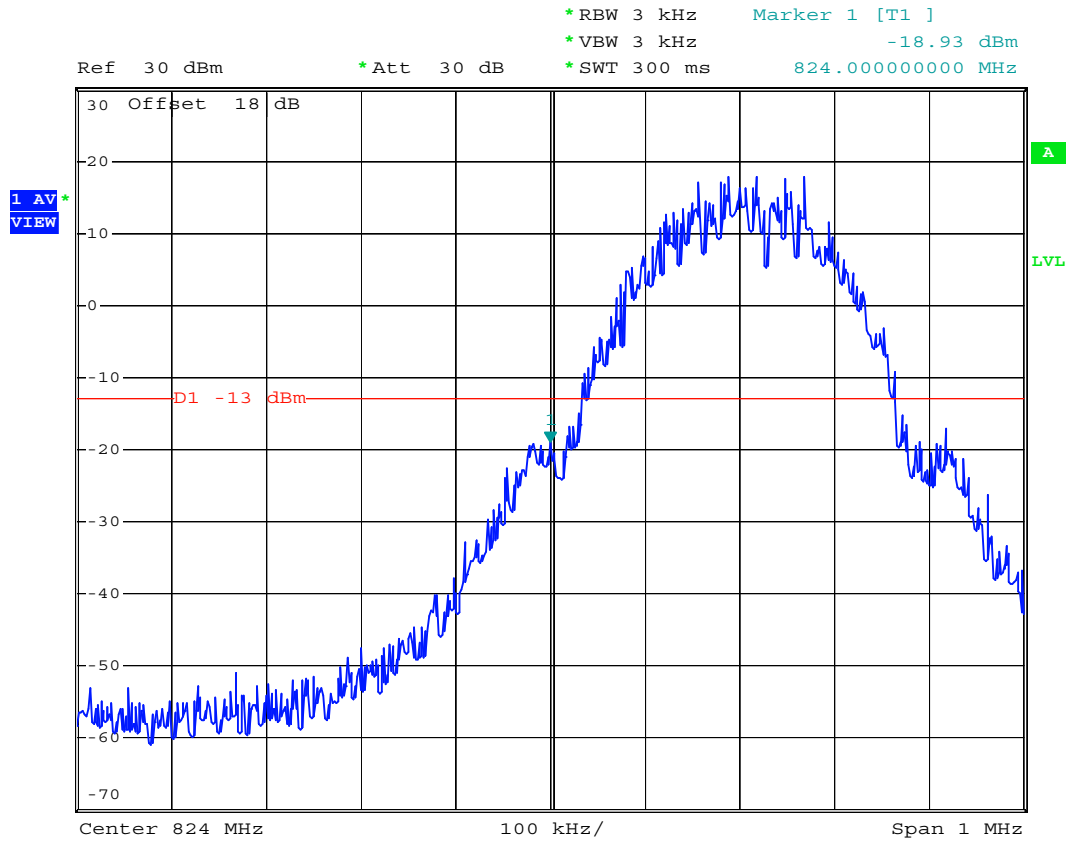

Date: 12.MAY.2007 14:23:30



- Test Mode : GSM850 (GSM) CH251 Higher Band Edge
- Power State : High

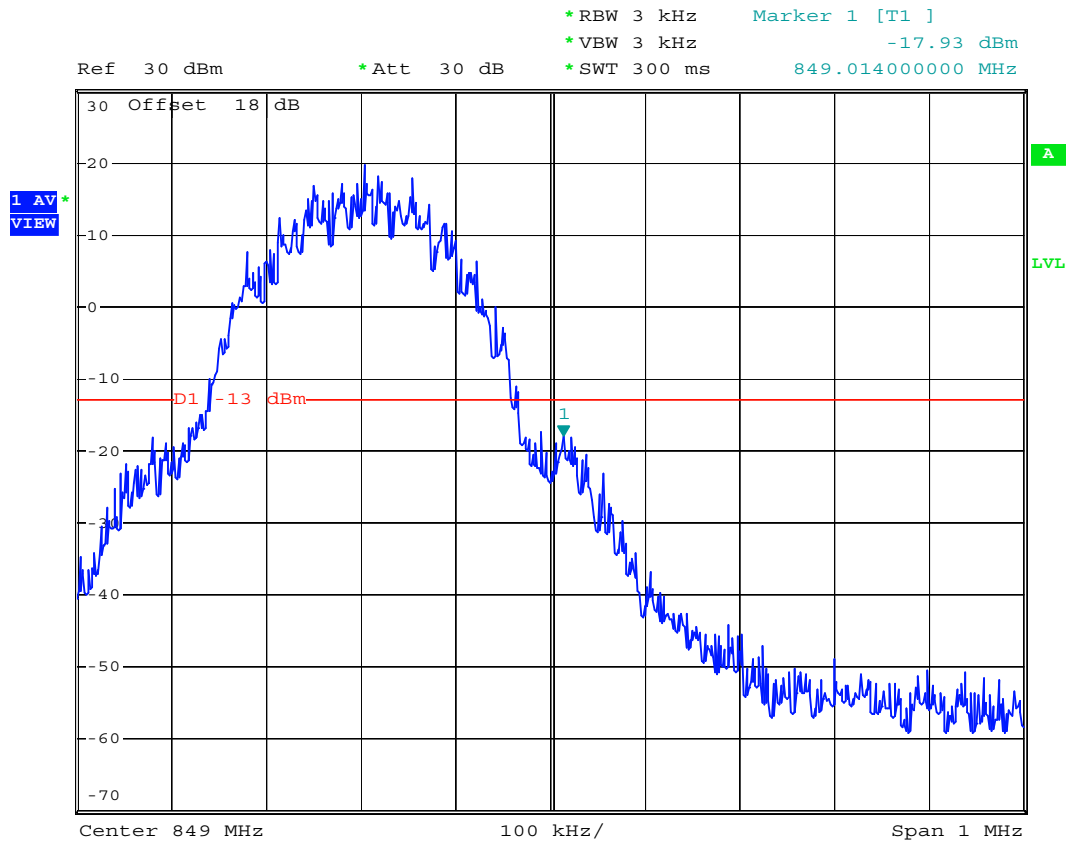

Date: 12.MAY.2007 14:28:48



- Mode 2
- Test Mode : GSM850 (EDGE) CH128 Lower Band Edge
- Power State : High

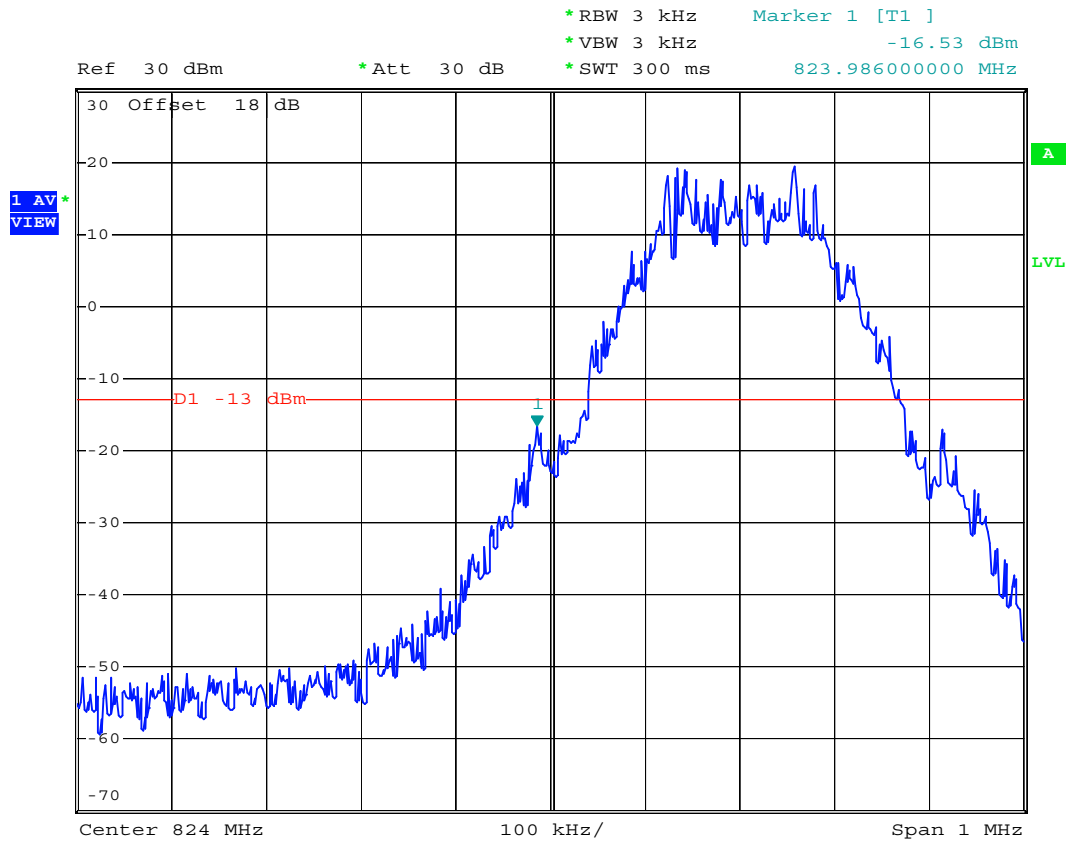

Date: 12.MAY.2007 16:08:21



- Test Mode : GSM850 (EDGE) CH251 Higher Band Edge
- Power State : High



Date: 12.MAY.2007 16:04:32



- Mode 3
- Test Mode : PCS1900 (GSM) CH512 Lower Band Edge
- Power State : High

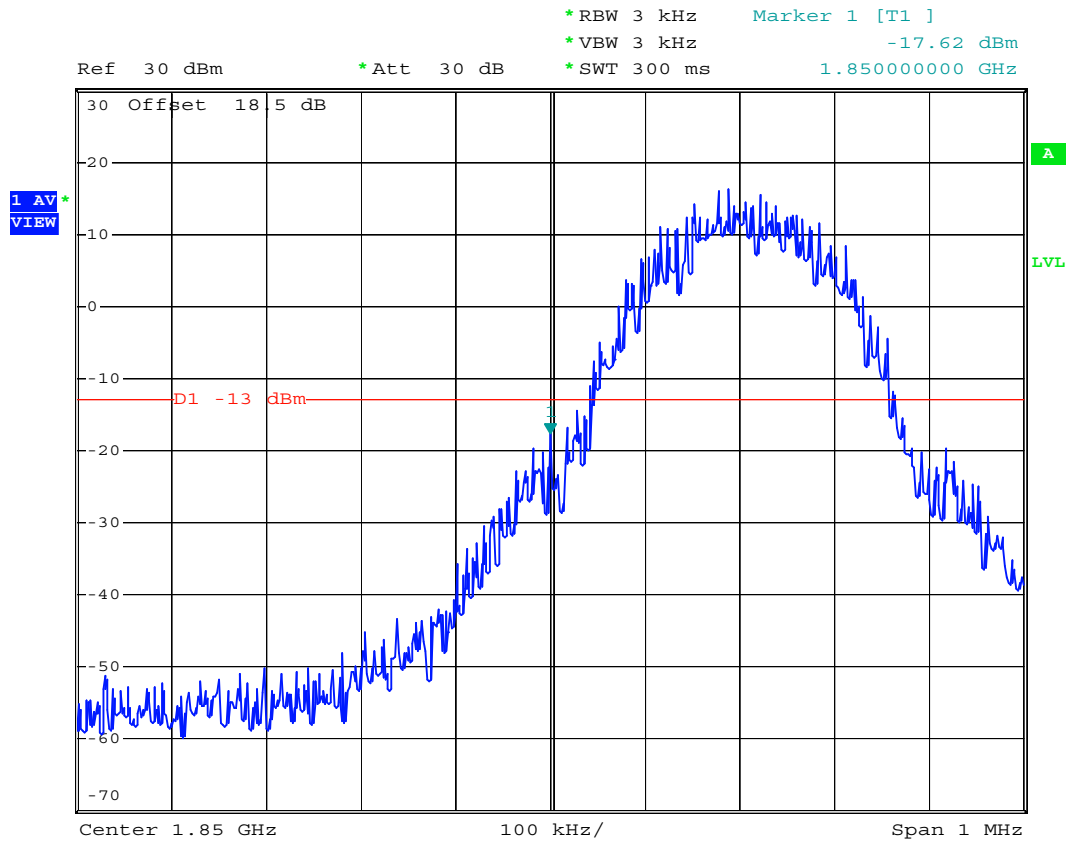

Date: 12.MAY.2007 15:20:59



- Test Mode : PCS1900 (GSM) CH661 99% Occupied Bandwidth
- Power State : Low

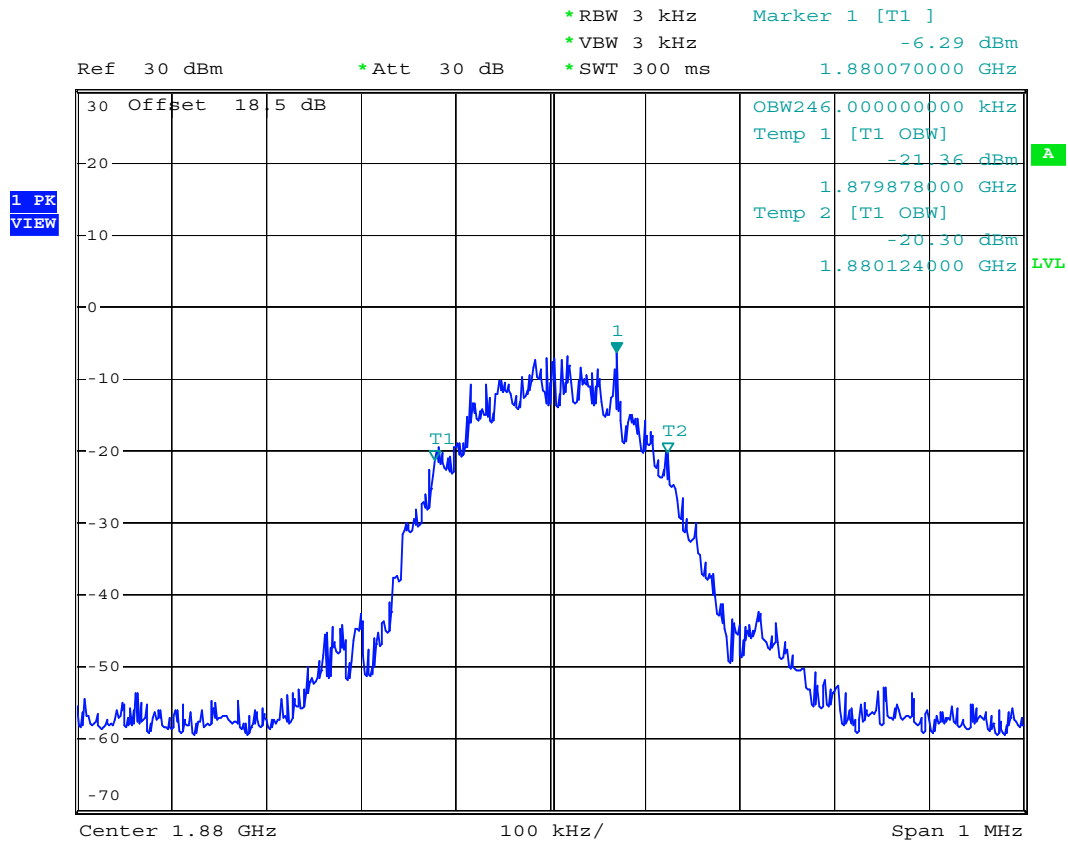

Date: 12.MAY.2007 15:30:07



- Test Mode : PCS1900 (GSM) CH661 99% Occupied Bandwidth
- Power State : High

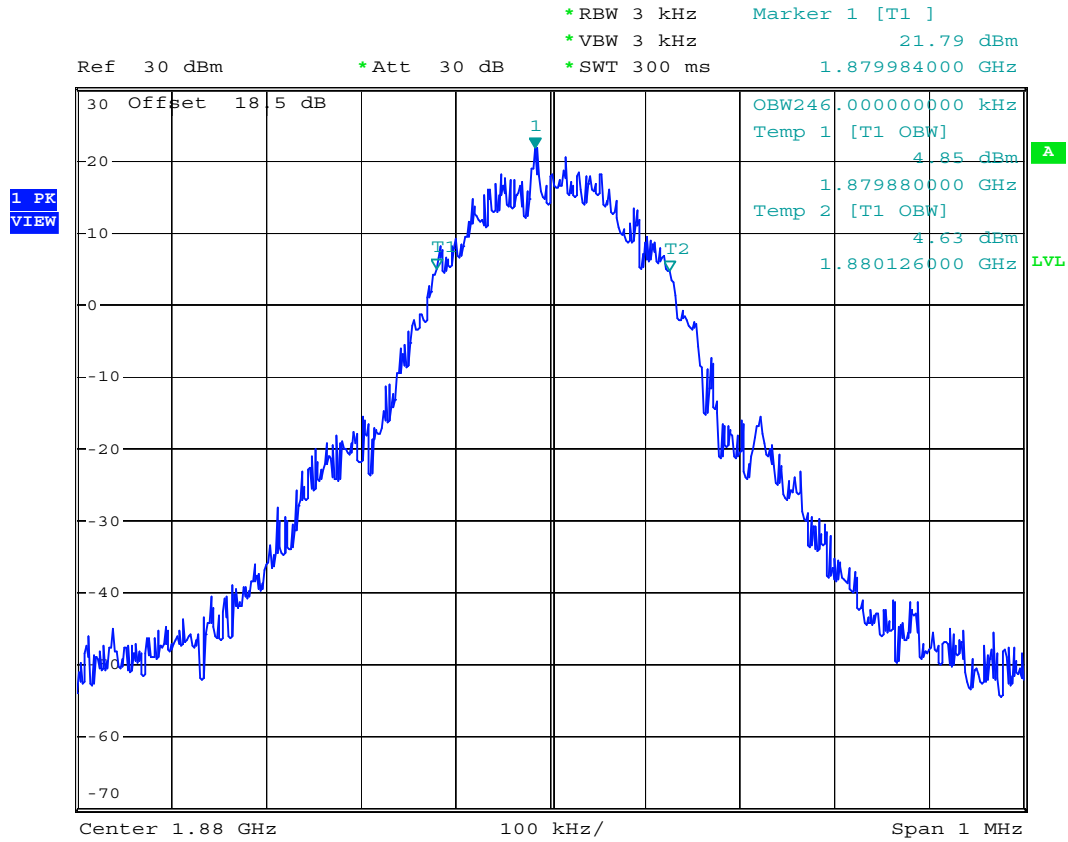

Date: 12.MAY.2007 15:23:47



- Test Mode : PCS1900 (GSM) CH810 Higher Band Edge
- Power State : High

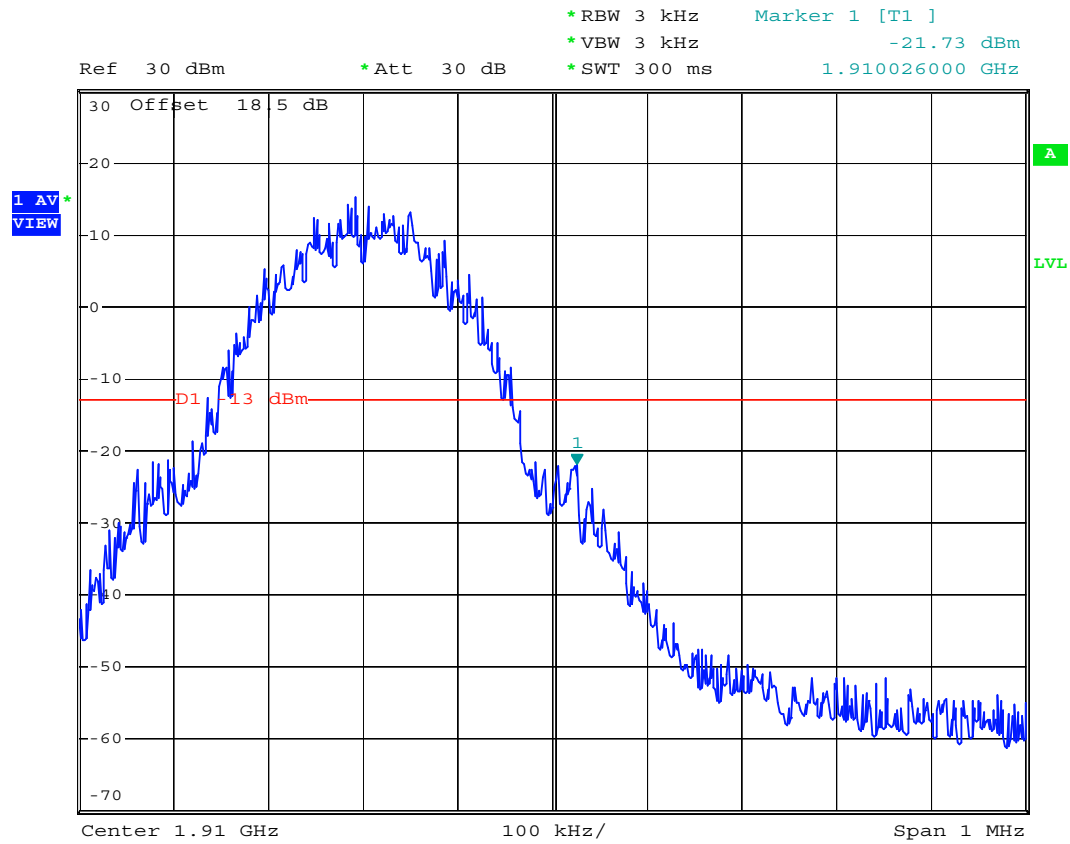

Date: 12.MAY.2007 15:22:52



- Test Mode : PCS1900(EDGE) CH810 Higher Band Edge
- Power State : High

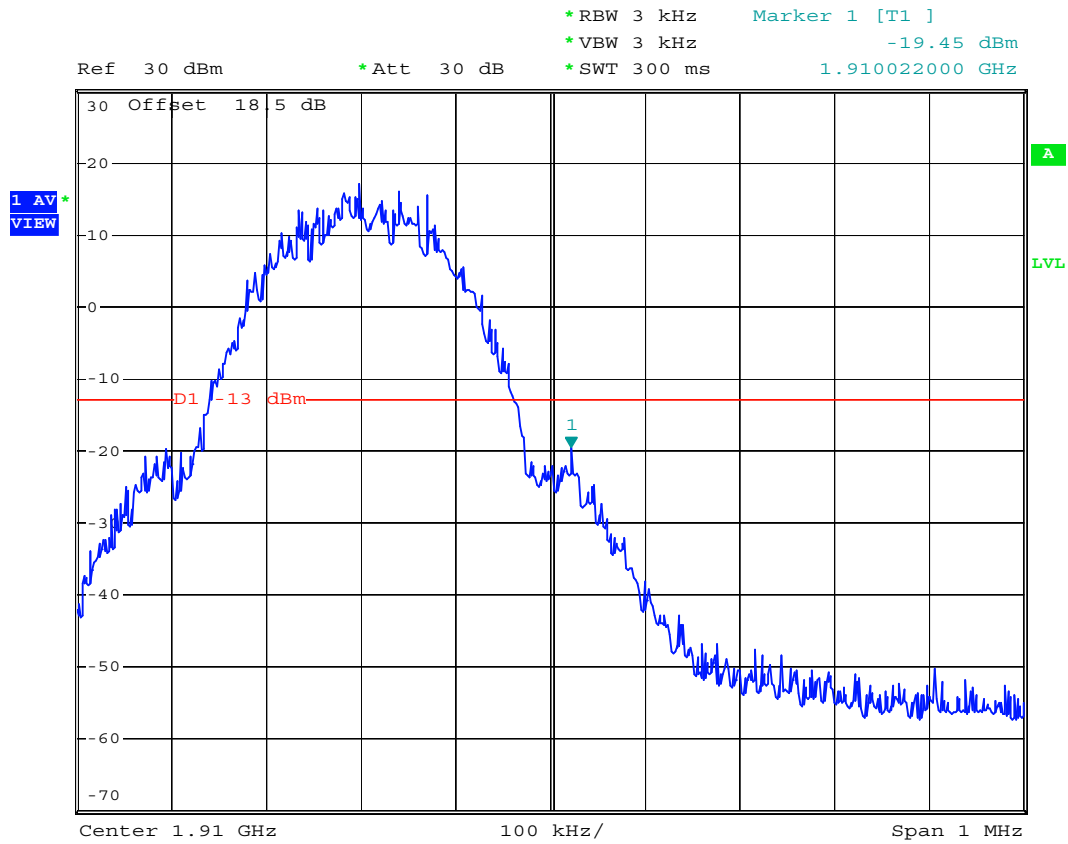

Date: 12.MAY.2007 15:49:38

4.5 Conducted Emission

4.5.1 Measurement Instruments

As described in chapter 5 of this test report.

4.5.2 Test Procedure

1. The EUT was connected to Spectrum Analyzer and Base Station via power divider.
2. The middle channel for the highest RF power within the transmitting frequency was measured.
3. The conducted spurious emission for the whole frequency range was taken.

4.5.3 Test Setup Layout

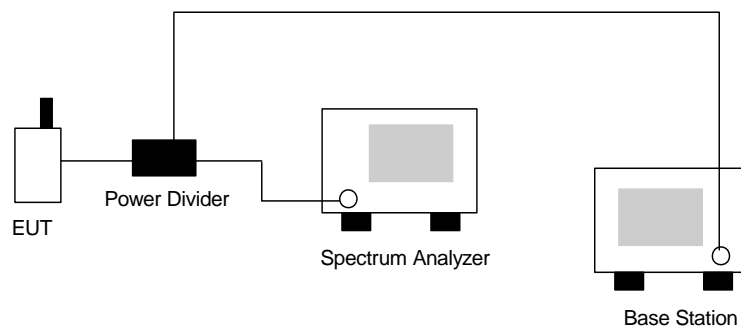



4.5.4 Test Result

- Mode 1
- Test Mode : GSM850 (GSM) CH189
- Frequency Range : 30M-1G

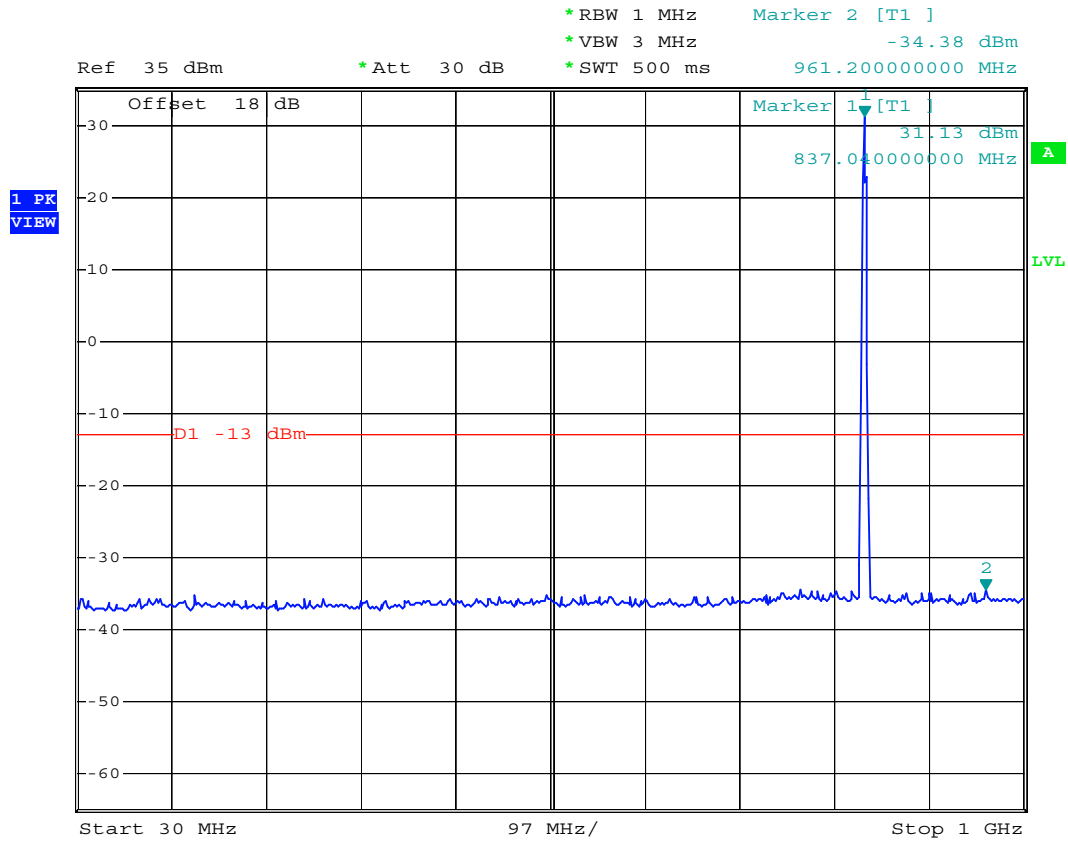

Date: 12.MAY.2007 15:05:38



- Test Mode : GSM850 (GSM) CH189
- Frequency Range : 1G-3G

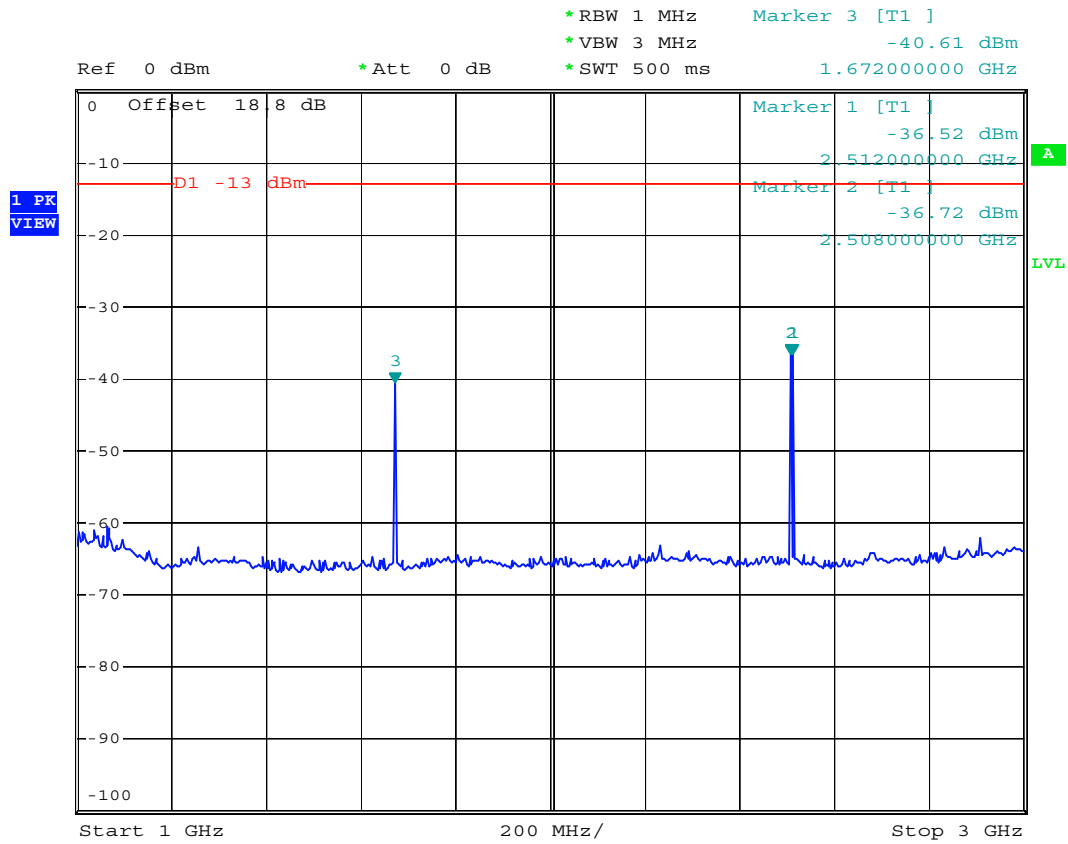

Date: 12.MAY.2007 15:07:12



- Test Mode : GSM850 (GSM) CH189
- Frequency Range : 3G-7G

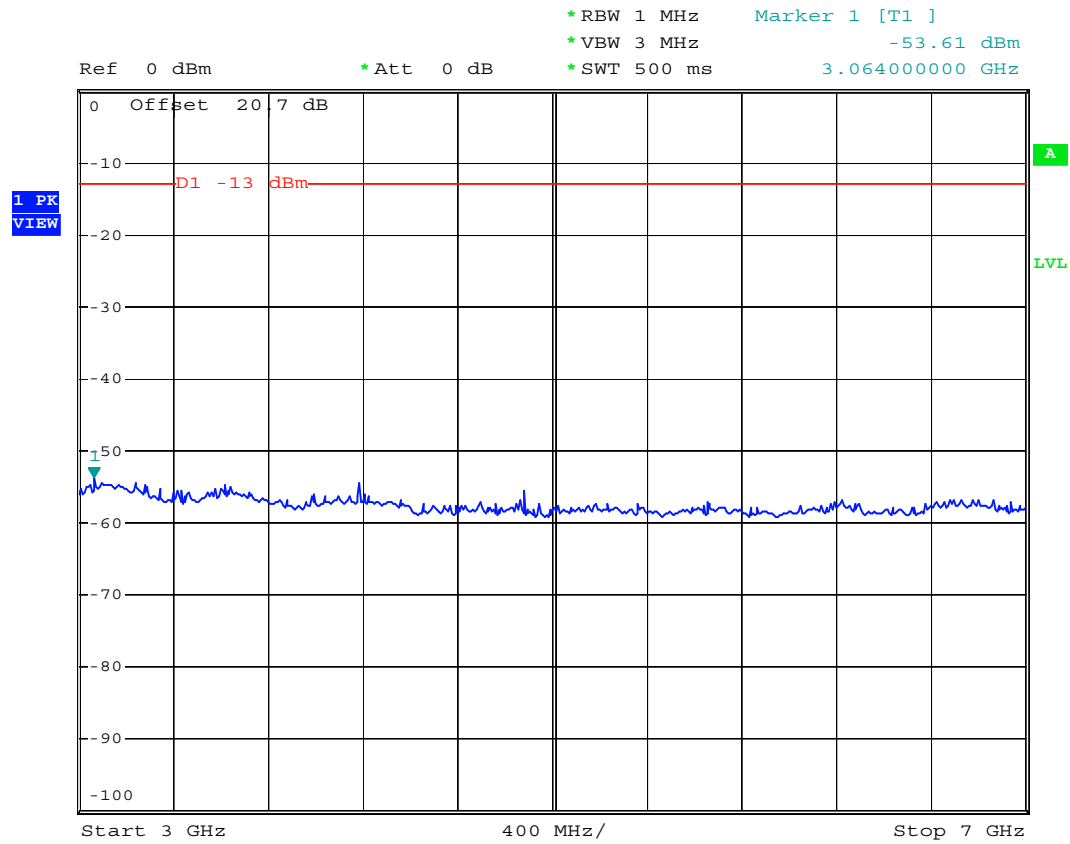

Date: 12.MAY.2007 15:08:24



- Test Mode : GSM850 (GSM) CH189
- Frequency Range : 7G-9G

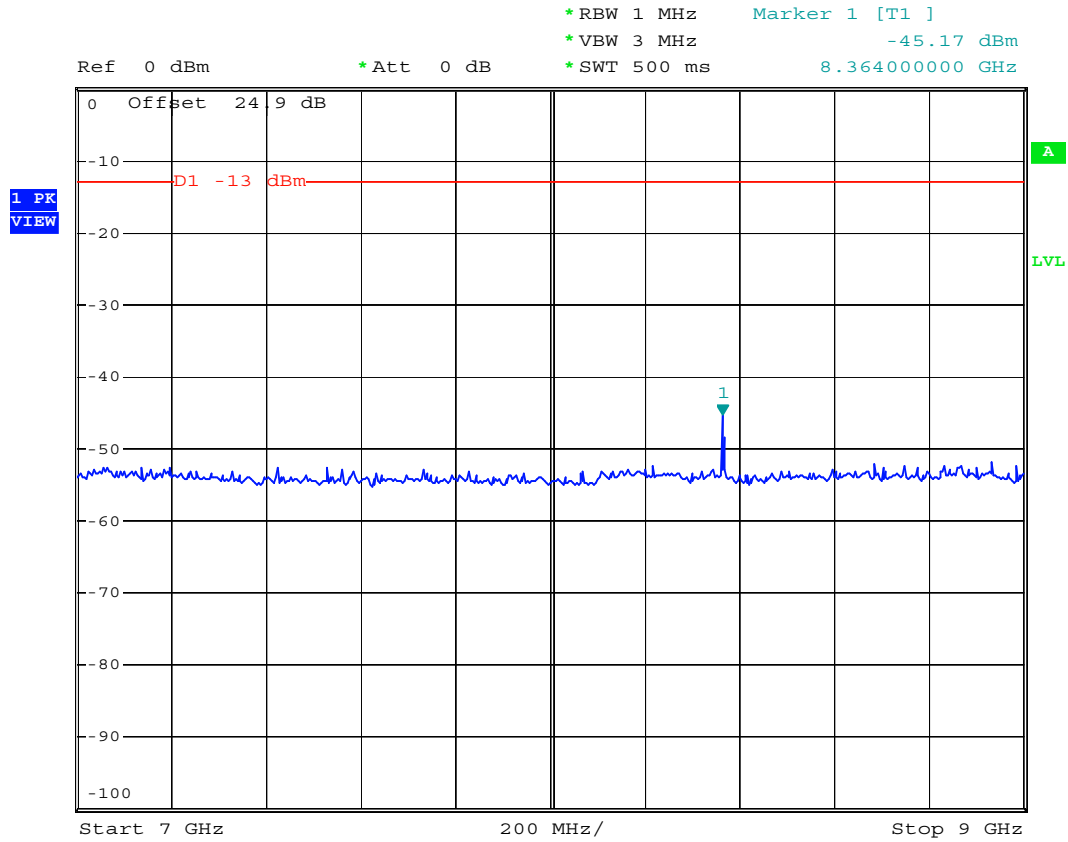

Date: 12.MAY.2007 15:09:03



- Mode 3
- Test Mode : PCS1900 (GSM) CH661
- Frequency Range : 30M-1G

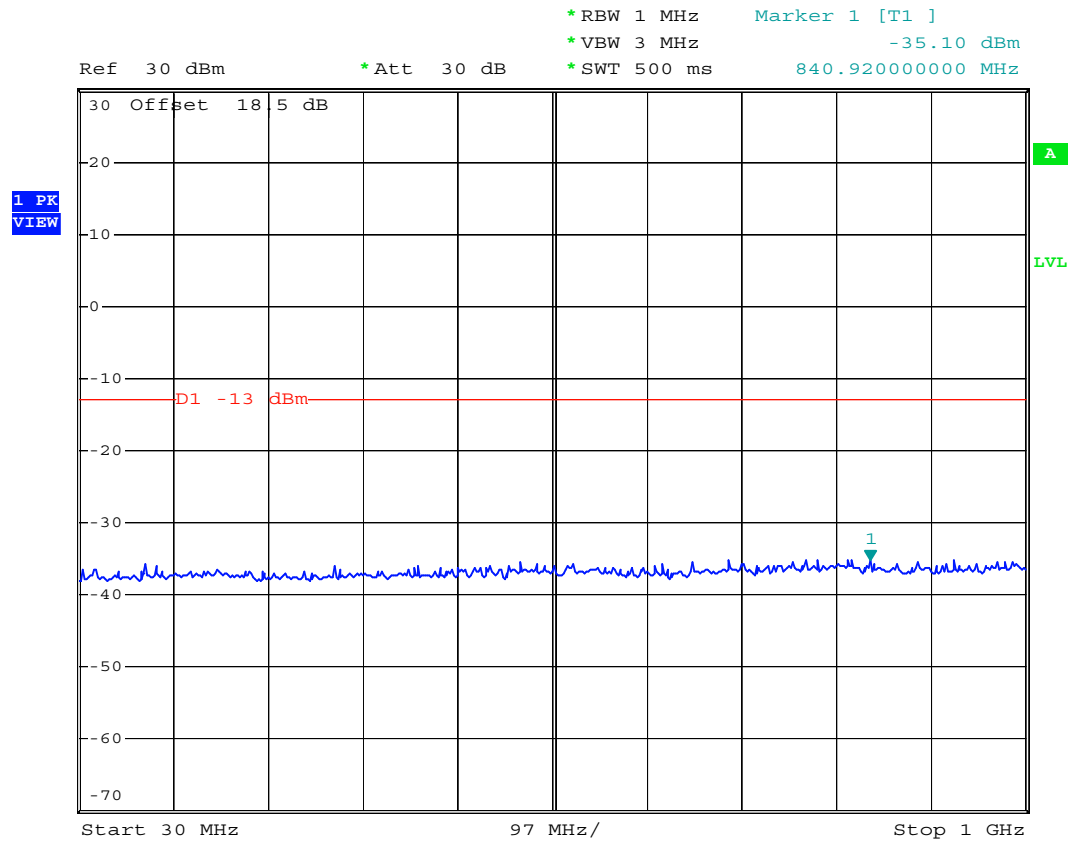

Date: 12.MAY.2007 15:35:01



- Test Mode : PCS1900 (GSM) CH661
- Frequency Range : 1G-3G

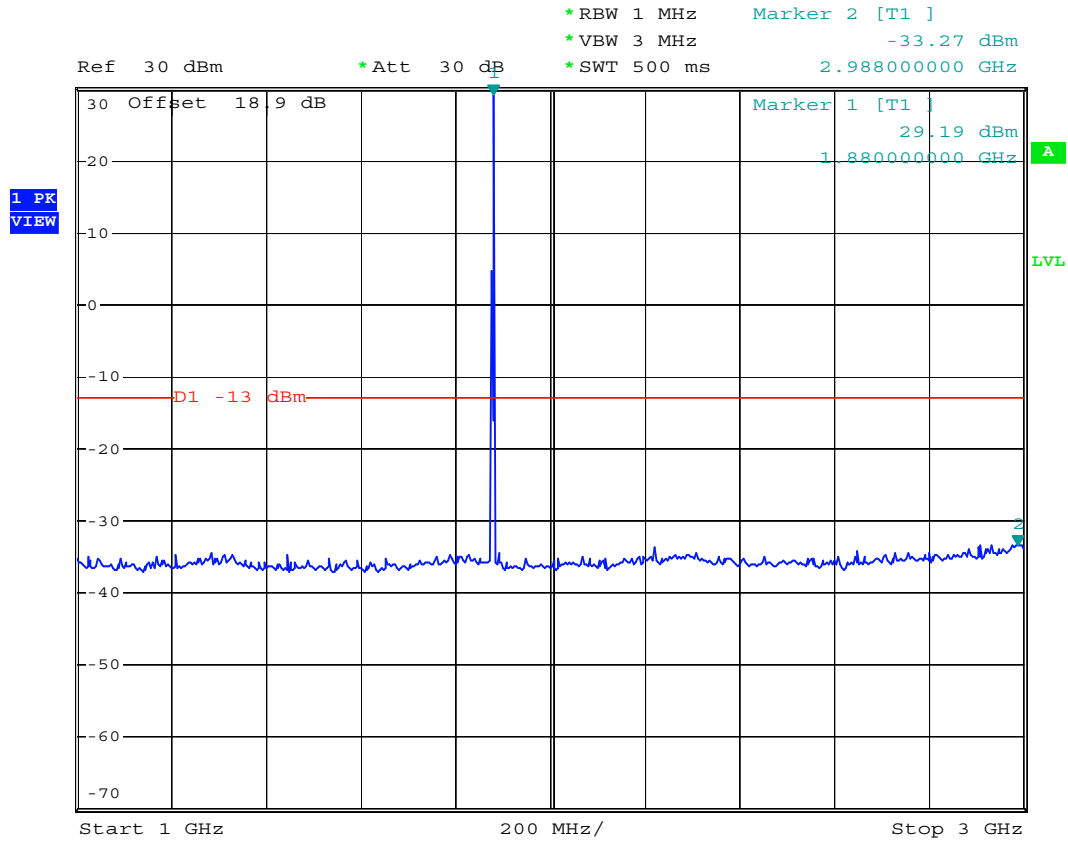

Date: 12.MAY.2007 15:33:35



- Test Mode : PCS1900 (GSM) CH661
- Frequency Range : 3G-7G

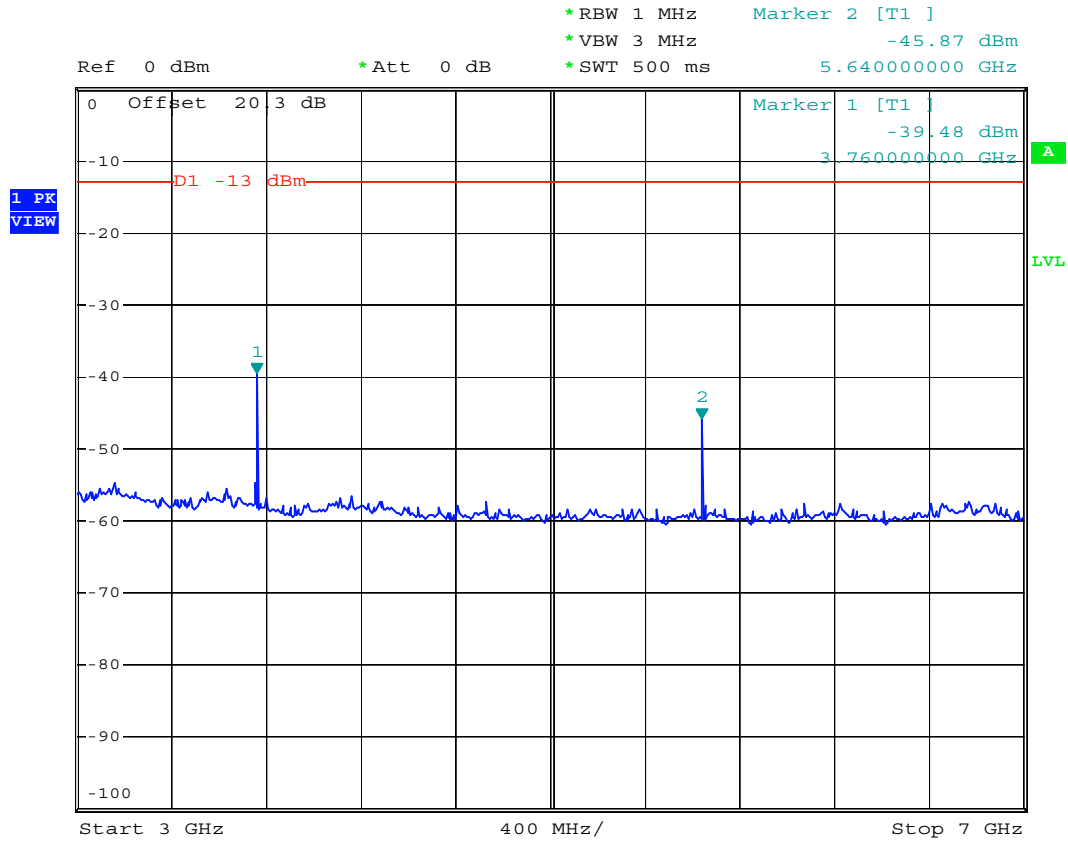

Date: 12.MAY.2007 15:36:15



- Test Mode : PCS1900 (GSM) CH661
- Frequency Range : 7G-13.6G

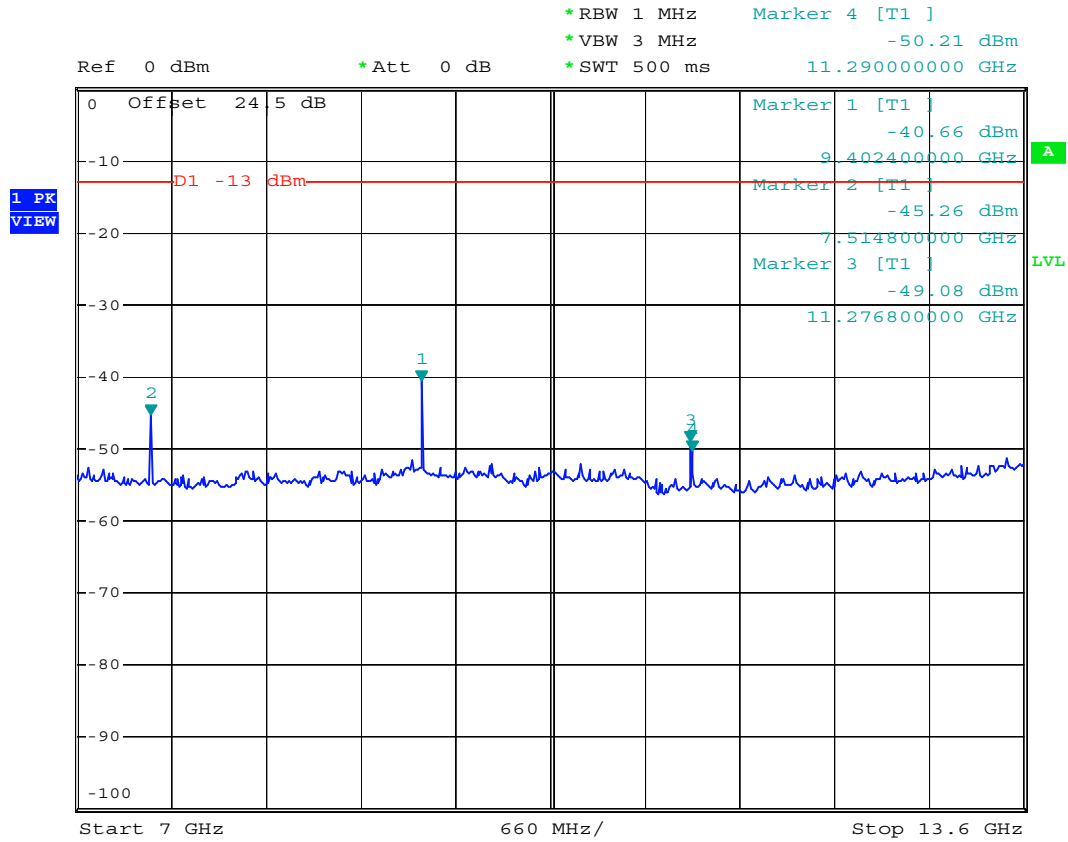

Date: 12.MAY.2007 15:37:35



- Test Mode : PCS1900 (GSM) CH661
- Frequency Range : 13.6G-19.1G

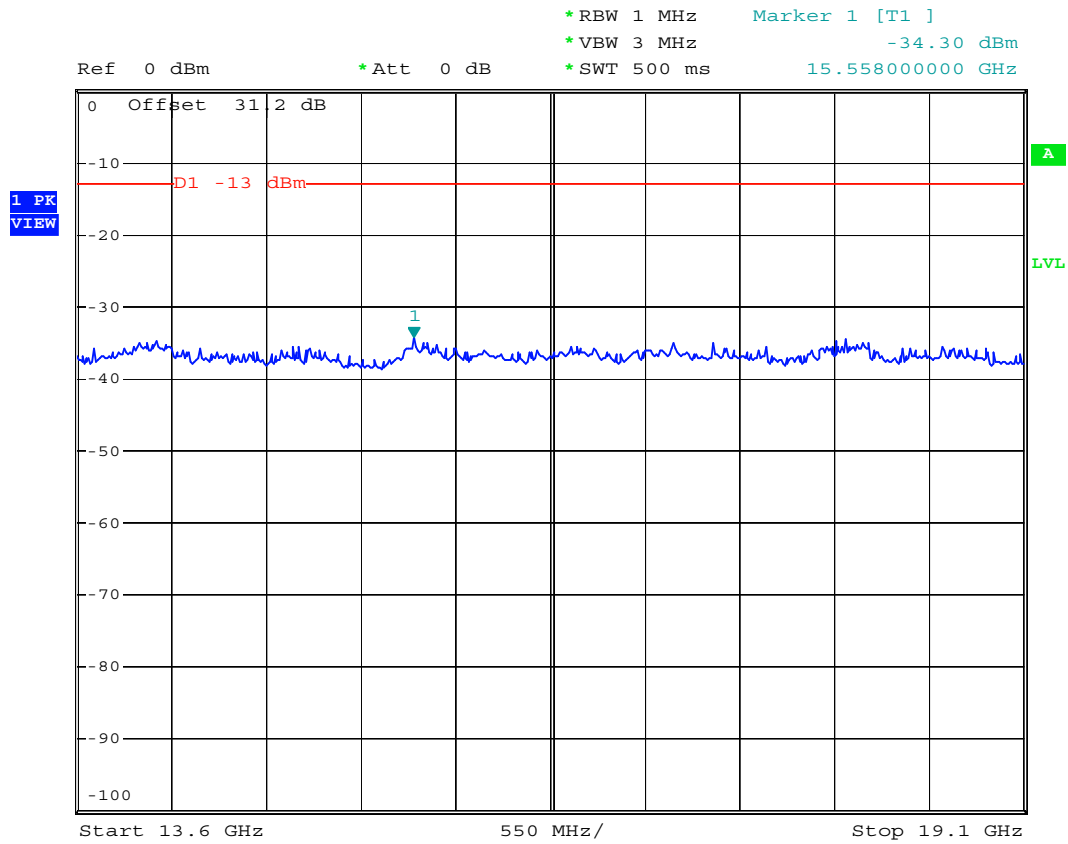

Date: 12.MAY.2007 15:38:22

4.6 Field Strength of Spurious Radiation

Equivalent isotropic radiated Power Measurements by substitution method according to ANSI/TIA/EIA-603-C.

4.6.1 Measurement Instruments

As described in chapter 5 of this test report.

4.6.2 Test Procedure

1. The EUT was placed on a rotatable wooden table with 0.8 meter about ground.
2. The EUT was set 3 meters from the receiving antenna which was mounted on the antenna tower.
3. The table was rotated 360 degrees to determine the position of the highest spurious emission.
4. The height of the receiving antenna is varied between one meter and four meters to reach the maximum spurious emission for both horizontal and vertical polarizations.
5. Taking the record of maximum spurious emission.
6. A Horn antenna was substituted in place of the EUT and was driven by a signal generator.
7. Tune the output power of signal generator to the same emission level with EUT maximum spurious emission.
8. Taking the record of output power at antenna port.
9. Repeat step 7 to step 8 for another polarization.
10. Emission level (dBm) = output power + substitution Gain.

4.6.3 Test Setup Layout

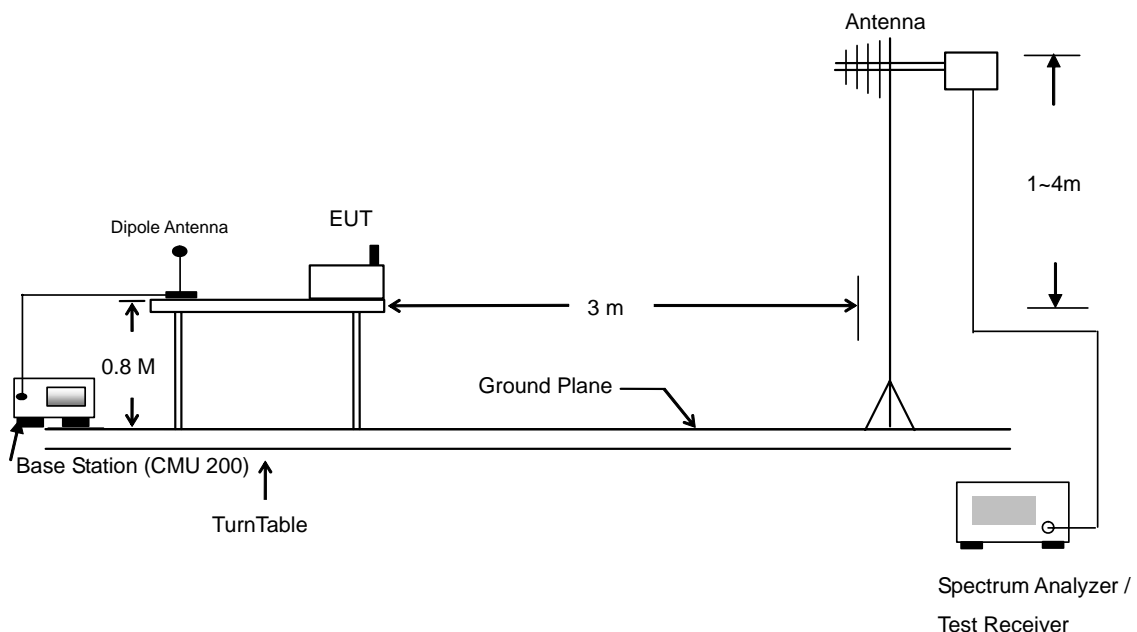



4.6.4 Test Result

- Test Mode : Mode 1

GSM850 (GSM) Radiated Spurious ERP							
H Polarization				V Polarization			
Frequency (MHz)	ERP (dBm)	Limit (dBm)	Margin (dB)	Frequency (MHz)	ERP (dBm)	Limit (dBm)	Margin (dB)
91.290	-55.910	-13	-42.91	65.640	-52.000	-13	-39.00
137.730	-50.350	-13	-37.35	137.190	-50.350	-13	-37.35
162.840	-51.180	-13	-38.18	170.940	-50.060	-13	-37.06
810.300	-57.630	-13	-44.63	301.400	-64.390	-13	-51.39
1674.000	-38.590	-13	-25.59	1674.000	-46.820	-13	-33.82
2508.000	-40.150	-13	-27.15	2508.000	-38.680	-13	-25.68
4178.000	-52.990	-13	-39.99				

- Test Mode : Mode 2

GSM850 (EDGE) Radiated Spurious ERP							
H Polarization				V Polarization			
Frequency (MHz)	ERP (dBm)	Limit (dBm)	Margin (dB)	Frequency (MHz)	ERP (dBm)	Limit (dBm)	Margin (dB)
81.030	-52.930	-13	-39.93	64.830	-51.320	-13	-38.32
138.540	-49.380	-13	-36.38	136.380	-49.620	-13	-36.62
170.940	-49.060	-13	-36.06	168.240	-46.970	-13	-33.97
901.300	-55.970	-13	-42.97	638.800	-60.080	-13	-47.08
1674.000	-40.840	-13	-27.84	1674.000	-46.200	-13	-33.20
2508.000	-39.720	-13	-26.72	2508.000	-41.580	-13	-28.58
4178.000	-53.400	-13	-40.40	3344.000	-56.100	-13	-43.10
				5018.000	-52.860	-13	-39.86
				5854.000	-54.100	-13	-41.10



- Test Mode : Mode 3

PCS1900 (GSM) Radiated Spurious EIRP							
H Polarization				V Polarization			
Frequency (MHz)	EIRP (dBm)	Limit (dBm)	Margin (dB)	Frequency (MHz)	EIRP (dBm)	Limit (dBm)	Margin (dB)
88.590	-49.170	-13	-36.17	86.430	-45.500	-13	-32.50
141.240	-46.550	-13	-33.55	138.540	-47.430	-13	-34.43
166.890	-46.400	-13	-33.40	167.430	-45.870	-13	-32.87
301.400	-61.060	-13	-48.06	301.400	-60.930	-13	-47.93
318.900	-60.540	-13	-47.54	455.400	-63.530	-13	-50.53
444.900	-65.180	-13	-52.18	983.900	-61.630	-13	-48.63
3758.000	-46.660	-13	-33.66	3758.000	-42.840	-13	-29.84
5638.000	-52.160	-13	-39.16	5638.000	-51.550	-13	-38.55
11278.000	-40.590	-13	-27.59				

- Test Mode : Mode 4

PCS1900 (EDGE) Radiated Spurious EIRP							
H Polarization				V Polarization			
Frequency (MHz)	EIRP (dBm)	Limit (dBm)	Margin (dB)	Frequency (MHz)	EIRP (dBm)	Limit (dBm)	Margin (dB)
87.780	-50.010	-13	-37.01	64.830	-48.040	-13	-35.04
138.540	-46.710	-13	-33.71	137.730	-47.820	-13	-34.82
167.430	-46.590	-13	-33.59	173.640	-45.790	-13	-32.79
320.300	-61.130	-13	-48.13	301.400	-62.010	-13	-49.01
444.900	-65.710	-13	-52.71	462.400	-64.930	-13	-51.93
983.900	-63.980	-13	-50.98	939.800	-61.410	-13	-48.41
3758.000	-44.540	-13	-31.54	3758.000	-40.500	-13	-27.50
5638.000	-48.870	-13	-35.87	5638.000	-46.360	-13	-33.36
11278.000	-39.420	-13	-26.42	11278.000	-42.710	-13	-29.71



- Test Mode : Mode 5

GSM850 (GSM) with WLAN Co-location Radiated Spurious ERP							
H Polarization				V Polarization			
Frequency (MHz)	ERP (dBm)	Limit (dBm)	Margin (dB)	Frequency (MHz)	ERP (dBm)	Limit (dBm)	Margin (dB)
62.940	-58.330	-13	-45.33	79.680	-49.380	-13	-36.38
79.140	-52.310	-13	-39.31	195.780	-49.890	-13	-36.89
192.540	-55.770	-13	-42.77	218.730	-50.350	-13	-37.35
357.400	-60.150	-13	-47.15	901.300	-61.500	-13	-48.50
1674.000	-35.690	-13	-22.69	1674.000	-49.740	-13	-36.74
2508.000	-37.700	-13	-24.70	2508.000	-39.240	-13	-26.24
				3344.000	-55.750	-13	-42.75



4.6.5 Test Data
4.6.5.1 Mode 1
Horizontal Polarization

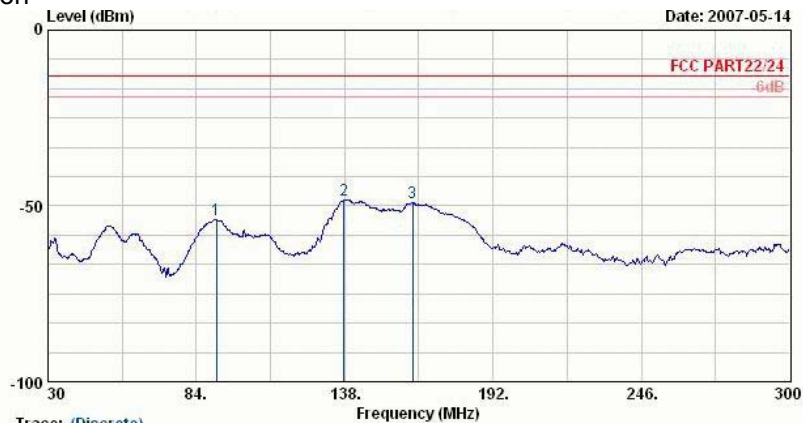

Trace: (Discrete)
Site : 03CH06-HY
Condition : LF-SPURIOUS HORIZONTAL
EUT : PDA Phone
Power : 120Vac/60Hz
Model : FG742004-01
Memo : CSM850 Link;Ch189+Adaptor+Earphone
Plane : E2

Table with 8 columns: Freq (MHz), Level (dBm), Over Limit (dB), Limit Line (dBm), Read Level (dBm), Factor (dB), Remark. It contains three rows of peak data.

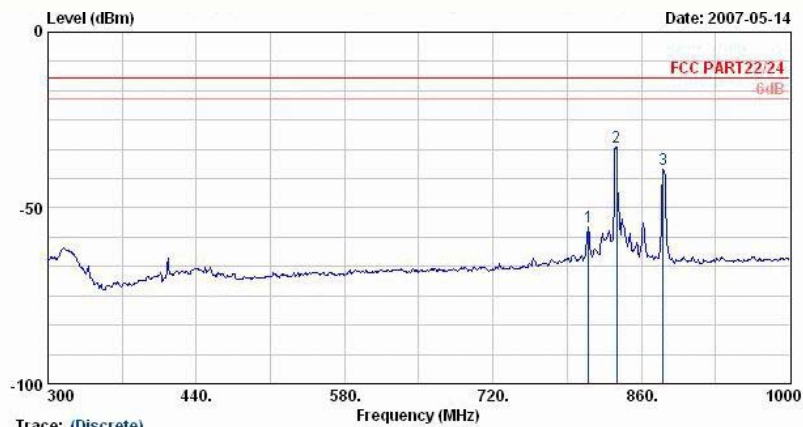

Trace: (Discrete)
Site : 03CH06-HY
Condition : LF-SPURIOUS HORIZONTAL
EUT : PDA Phone
Power : 120Vac/60Hz
Model : FG742004-01
Memo : CSM850 Link;Ch189+Adaptor+Earphone
Plane : E2

Table with 8 columns: Freq (MHz), Level (dBm), Over Limit (dB), Limit Line (dBm), Read Level (dBm), Factor (dB), Remark. It contains three rows of peak data.

Remark:
1. #2: MS Signal
2. #3: BS Signal

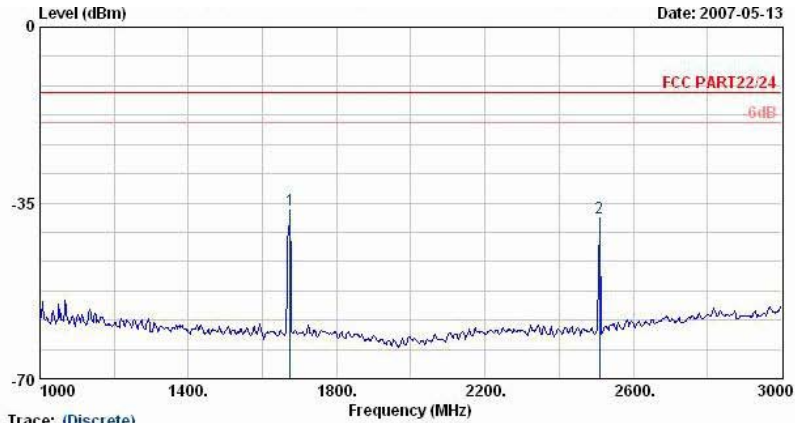

Trace: (Discrete)
 Site : D3CH06-HY
 Condition : HF-SPURIOUS HORIZONTAL
 EUT : PDA Phone
 Power : 120Vac/60Hz
 Model : FG742004-01
 Memo : GSM850 Link;Ch189+Adaptor+Earphone
 Plane : E2

	Freq	Level	Over	Limit	Read	Factor	Remark
	MHz	dBm	dB	dBm	dBm	dB	
1 @	1674.00	-36.44	-23.44	-13.00	-36.66	0.22	Peak
2	2508.00	-38.00	-25.00	-13.00	-39.20	1.20	Peak

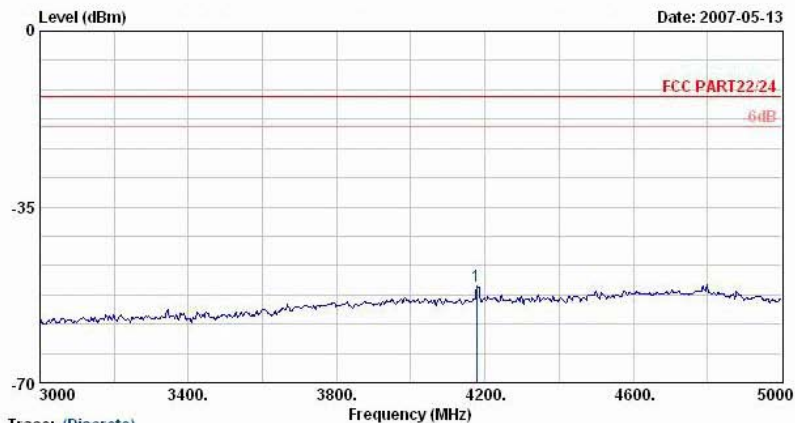

Trace: (Discrete)
 Site : D3CH06-HY
 Condition : HF-SPURIOUS HORIZONTAL
 EUT : PDA Phone
 Power : 120Vac/60Hz
 Model : FG742004-01
 Memo : GSM850 Link;Ch189+Adaptor+Earphone
 Plane : E2

	Freq	Level	Over	Limit	Read	Factor	Remark
	MHz	dBm	dB	dBm	dBm	dB	
1	4178.00	-50.84	-37.84	-13.00	-60.63	9.79	Peak

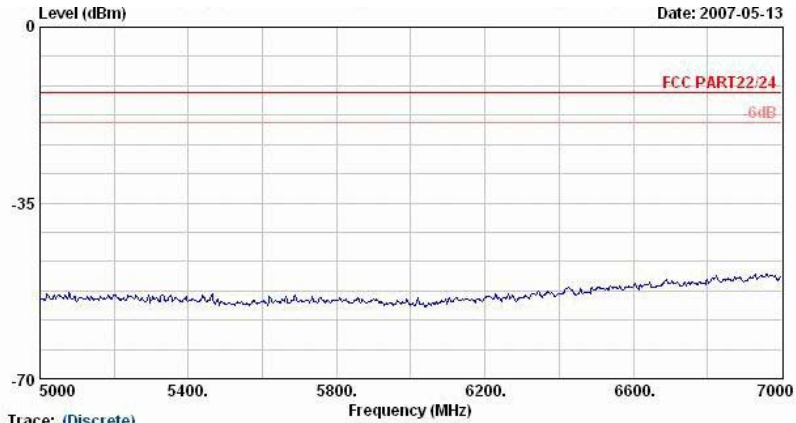

Trace: (Discrete)
Site : D3CH06-HY
Condition : HF-SPORTIOUS HORIZONTAL
EUT : PDA Phone
Power : 120Vac/60Hz
Model : FG742004-01
Memo : GSM850 Link;Ch189+Adaptor+Earphone
Plane : E2

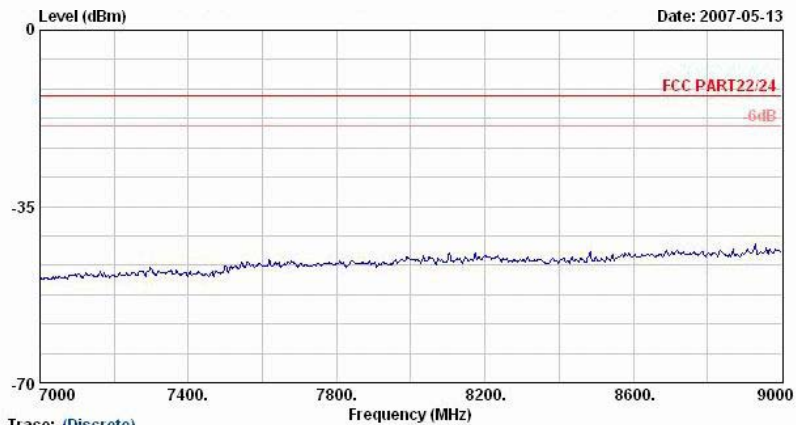

Trace: (Discrete)
Site : D3CH06-HY
Condition : HF-SPORTIOUS HORIZONTAL
EUT : PDA Phone
Power : 120Vac/60Hz
Model : FG742004-01
Memo : GSM850 Link;Ch189+Adaptor+Earphone
Plane : E2



Vertical Polarization

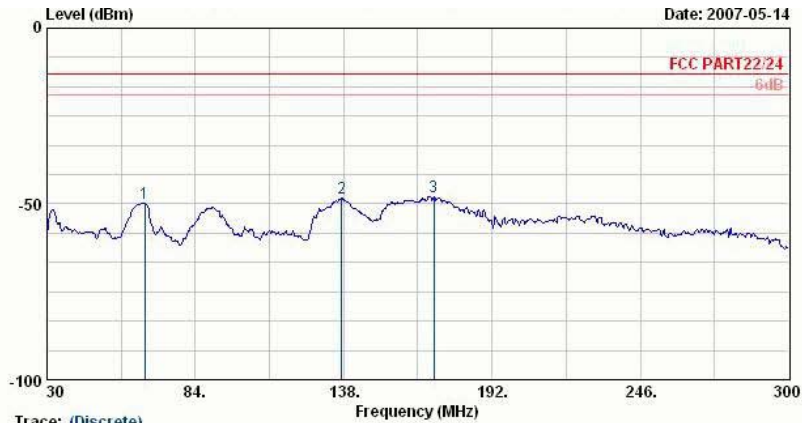

Trace: (Discrete)
 Site : D3CH06-HY
 Condition : LF-SPURIOUS VERTICAL
 EUT : PDA Phone
 Power : 120Vac/60Hz
 Model : FG742004-01
 Memo : GSM850 Link;Ch189+Adaptor+Earphone
 Plane : E2

	Freq MHz	Level dBm	Over Limit dB	Limit Line dBm	Read Level dBm	Factor dB	Remark
1	65.64	-49.85	-36.85	-13.00	-37.27	-12.58	Peak
2	137.19	-48.20	-35.20	-13.00	-40.17	-8.03	Peak
3	170.94	-47.91	-34.91	-13.00	-39.59	-8.33	Peak

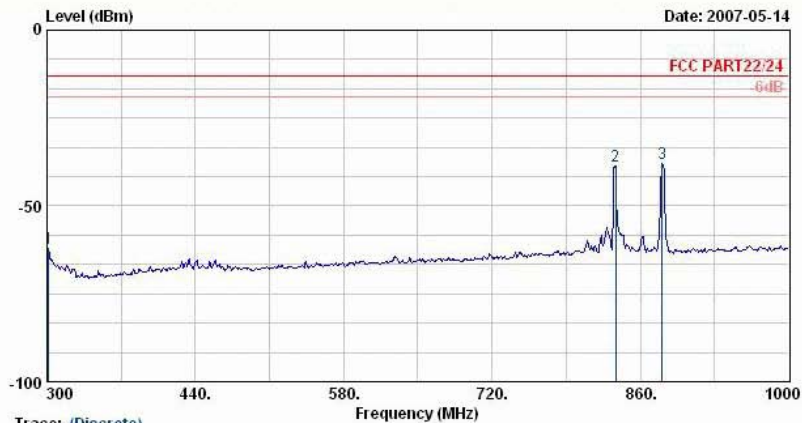

Trace: (Discrete)
 Site : D3CH06-HY
 Condition : LF-SPURIOUS VERTICAL
 EUT : PDA Phone
 Power : 120Vac/60Hz
 Model : FG742004-01
 Memo : GSM850 Link;Ch189+Adaptor+Earphone
 Plane : E2

	Freq MHz	Level dBm	Over Limit dB	Limit Line dBm	Read Level dBm	Factor dB	Remark
1	301.40	-62.24	-49.24	-13.00	-55.82	-6.42	Peak
2	836.90	-38.55			-39.91	1.36	Peak
3	880.30	-38.06			-39.77	1.71	Peak

Remark:

1. #2: MS Signal
2. #3: BS Signal

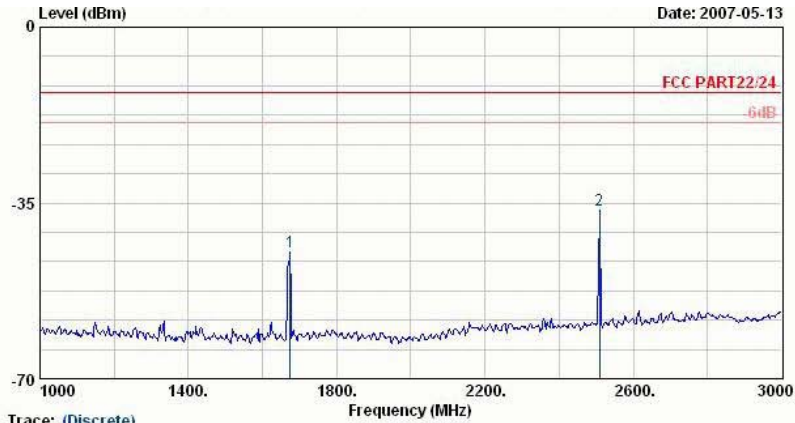

Trace: (Discrete)

Site : D3CH06-HY
 Condition : HF-SPORTIOUS VERTICAL
 EUT : PDA Phone
 Power : 120Vac/60Hz
 Model : FG742004-01
 Memo : GSM850 Link;Ch189+Adaptor+Earphone
 Plane : E2

	Freq	Level	Over	Limit	Read	Factor	Remark
	MHz	dBm	dB	dBm	dBm	dB	
1	1674.00	-44.67	-31.67	-13.00	-44.19	-0.48	Peak
2 @	2508.00	-36.53	-23.53	-13.00	-38.80	2.27	Peak

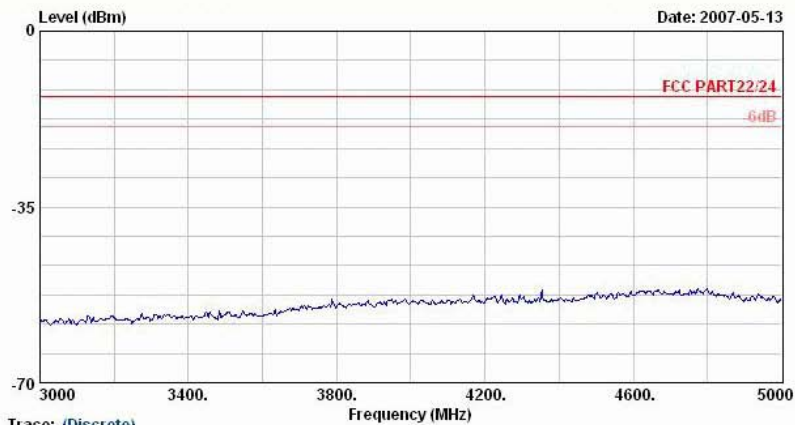

Trace: (Discrete)

Site : D3CH06-HY
 Condition : HF-SPORTIOUS VERTICAL
 EUT : PDA Phone
 Power : 120Vac/60Hz
 Model : FG742004-01
 Memo : GSM850 Link;Ch189+Adaptor+Earphone
 Plane : E2

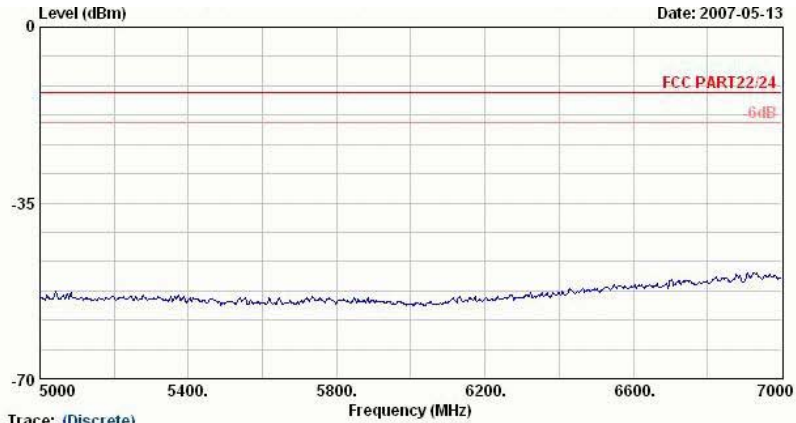

Trace: (Discrete)
Site : D3CH06-HY
Condition : HF-SPURIOUS VERTICAL
EUT : PDA Phone
Power : 120Vac/60Hz
Model : FG742004-01
Memo : GSM850 Link;Ch189+Adaptor+Earphone
Plane : E2

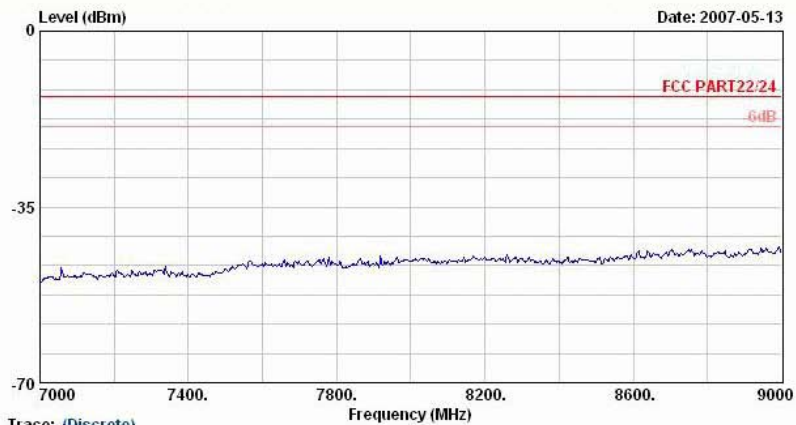

Trace: (Discrete)
Site : D3CH06-HY
Condition : HF-SPURIOUS VERTICAL
EUT : PDA Phone
Power : 120Vac/60Hz
Model : FG742004-01
Memo : GSM850 Link;Ch189+Adaptor+Earphone
Plane : E2

Remark : There is no more obvious emission except the listings above.



4.6.5.2 Mode 2
Horizontal Polarization

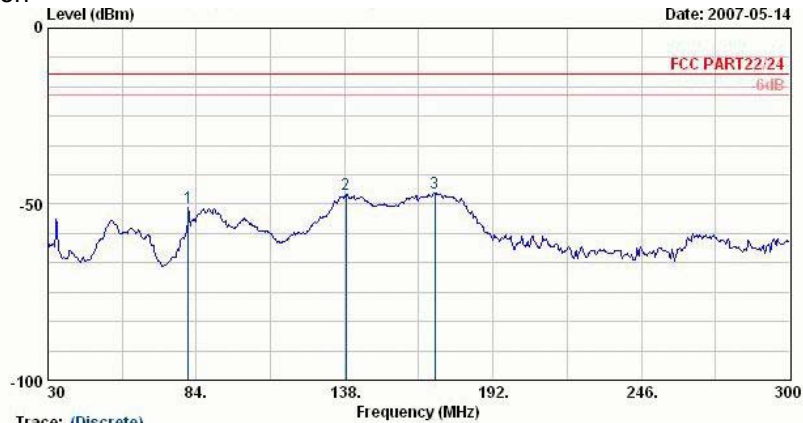

Trace: (Discrete)

Site : 03CH06-HY
 Condition : LF-SPURIOUS HORIZONTAL
 EUT : PDA Phone
 Power : 120Vac/60Hz
 Model : FG742004-01
 Memo : EDGE Link;Ch189+Adaptor+Earphone
 Plane : E2

	Freq	Level	Over	Limit	Read	Factor	Remark
	MHz	dBm	dB	dBm	dBm	dB	
1 @	81.03	-50.78	-37.78	-13.00	-38.47	-12.31	Peak
2 @	138.54	-47.23	-34.23	-13.00	-34.55	-12.69	Peak
3 @	170.94	-46.91	-33.91	-13.00	-33.86	-13.06	Peak

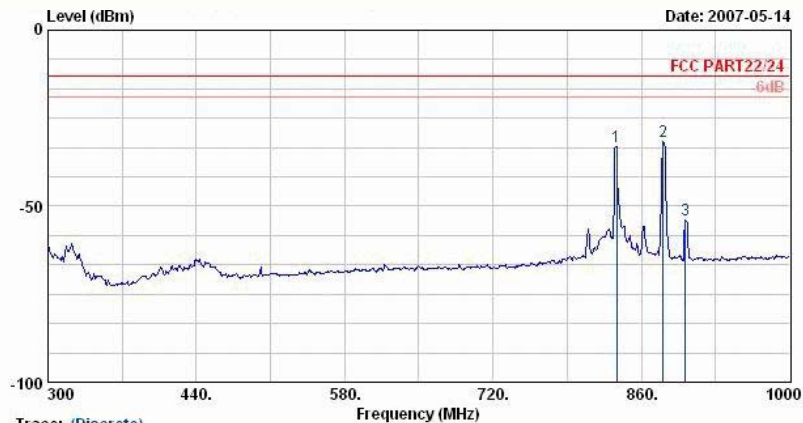

Trace: (Discrete)

Site : 03CH06-HY
 Condition : LF-SPURIOUS HORIZONTAL
 EUT : PDA Phone
 Power : 120Vac/60Hz
 Model : FG742004-01
 Memo : EDGE Link;Ch189+Adaptor+Earphone
 Plane : E2

	Freq	Level	Over	Limit	Read	Factor	Remark
	MHz	dBm	dB	dBm	dBm	dB	
1 @	836.90	-33.03			-31.69	-1.33	Peak
2 @	880.30	-31.53			-30.62	-0.91	Peak
3 @	901.30	-53.82	-40.82	-13.00	-53.11	-0.72	Peak

Remark:

- 1. #1: MS Signal
- 2. #2: BS Signal

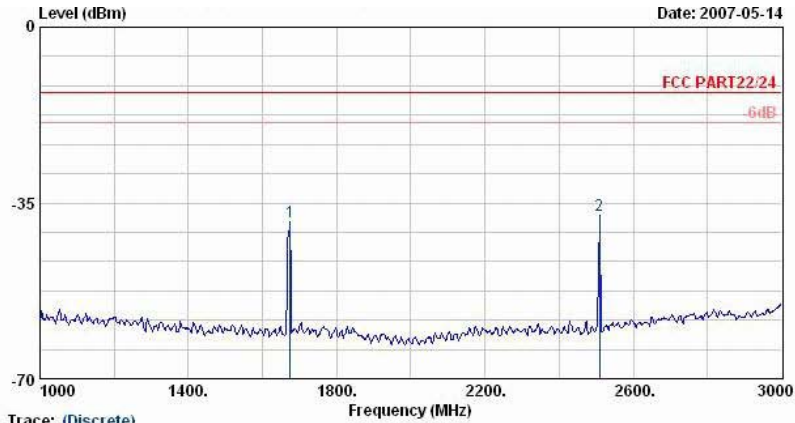

Trace: (Discrete)
 Site : D3CH06-HY
 Condition : HF-SPURIOUS HORIZONTAL
 EUT : PDA Phone
 Power : 120Vac/60Hz
 Model : FG742004-01
 Memo : EDGE Link;Ch189+Adaptor+Earphone
 Plane : E2

	Freq	Level	Over	Limit	Read	Factor	Remark
	MHz	dBm	dB	dBm	dBm	dB	
1 @	1674.00	-38.69	-25.69	-13.00	-38.91	0.22	Peak
2 @	2508.00	-37.57	-24.57	-13.00	-38.77	1.20	Peak

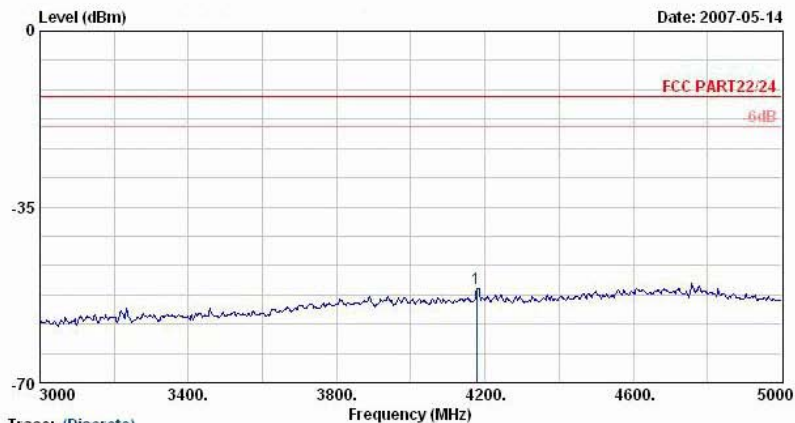

Trace: (Discrete)
 Site : D3CH06-HY
 Condition : HF-SPURIOUS HORIZONTAL
 EUT : PDA Phone
 Power : 120Vac/60Hz
 Model : FG742004-01
 Memo : EDGE Link;Ch189+Adaptor+Earphone
 Plane : E2

	Freq	Level	Over	Limit	Read	Factor	Remark
	MHz	dBm	dB	dBm	dBm	dB	
1 @	4178.00	-51.25	-38.25	-13.00	-61.03	9.79	Peak

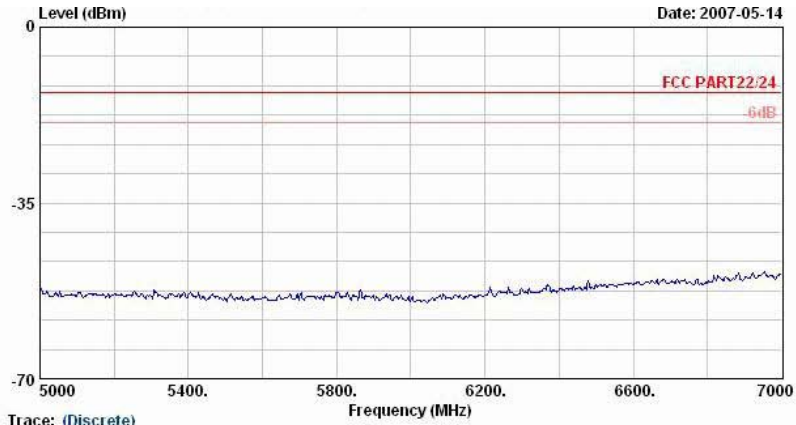

Trace: (Discrete)
Site : D3CH06-HY
Condition : HF-SPURIOUS HORIZONTAL
EUT : PDA Phone
Power : 120Vac/60Hz
Model : FG742004-01
Memo : EDGE Link;Ch1 89+Adaptor+Earphone
Plane : E2

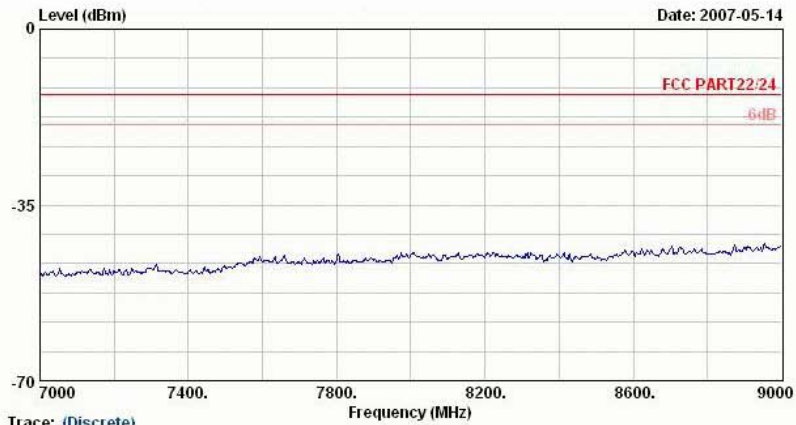

Trace: (Discrete)
Site : D3CH06-HY
Condition : HF-SPURIOUS HORIZONTAL
EUT : PDA Phone
Power : 120Vac/60Hz
Model : FG742004-01
Memo : EDGE Link;Ch1 89+Adaptor+Earphone
Plane : E2



Vertical Polarization

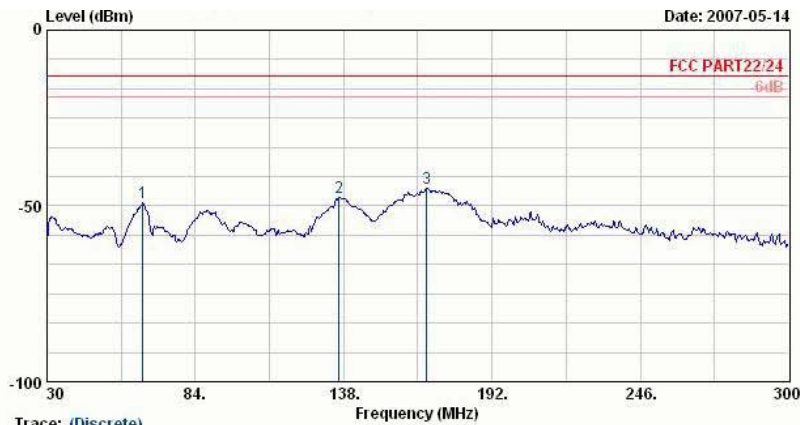

Trace: (Discrete)
 Site : D3CH06-HY
 Condition : LF-SPURIOUS VERTICAL
 EUT : PDA Phone
 Power : 120Vac/60Hz
 Model : FG742004-01
 Memo : EDGE Link;Ch189+Adaptor+Earphone
 Plane : E2

	Freq	Level	Over	Limit	Read	Factor	Remark
	MHz	dBm	dB	dBm	dBm	dB	
1 @	64.83	-49.17	-36.17	-13.00	-36.45	-12.72	Peak
2 @	136.38	-47.47	-34.47	-13.00	-39.45	-8.02	Peak
3 @	168.24	-44.82	-31.82	-13.00	-36.51	-8.31	Peak

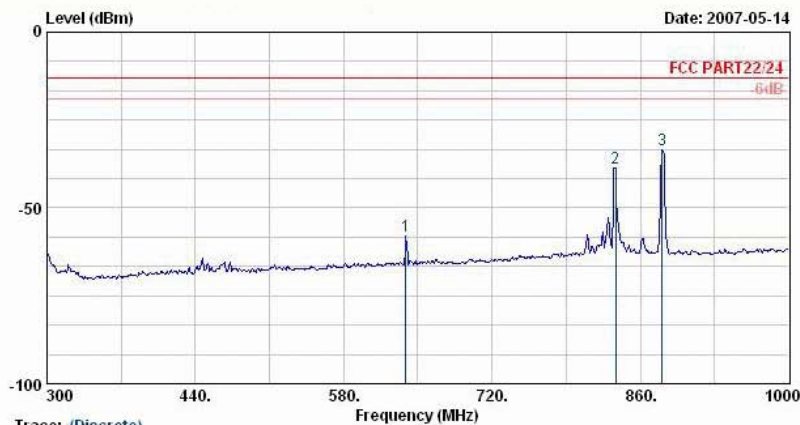

Trace: (Discrete)
 Site : D3CH06-HY
 Condition : LF-SPURIOUS VERTICAL
 EUT : PDA Phone
 Power : 120Vac/60Hz
 Model : FG742004-01
 Memo : EDGE Link;Ch189+Adaptor+Earphone
 Plane : E2

	Freq	Level	Over	Limit	Read	Factor	Remark
	MHz	dBm	dB	dBm	dBm	dB	
1 @	638.80	-57.93	-44.93	-13.00	-56.58	-1.35	Peak
2 @	836.90	-38.77			-40.13	1.36	Peak
3 @	880.30	-33.33			-35.04	1.71	Peak

Remark:

1. #2: MS Signal
2. #3: BS Signal

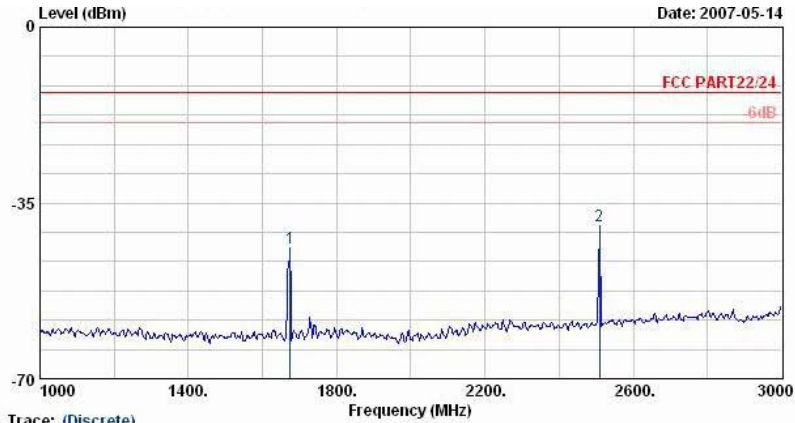

Trace: (Discrete)
 Site : D3CH06-HY
 Condition : HF-SPURIOUS VERTICAL
 EUT : PDA Phone
 Power : 120Vac/60Hz
 Model : FG742004-01
 Memo : EDGE Link;Ch189+Adaptor+Earphone
 Plane : E2

	Freq	Level	Over	Limit	Read	Factor	Remark
	MHz	dBm	dB	dBm	dBm	dB	
1 @	1674.00	-44.05	-31.05	-13.00	-43.57	-0.48	Peak
2 @	2508.00	-39.43	-26.43	-13.00	-41.70	2.27	Peak

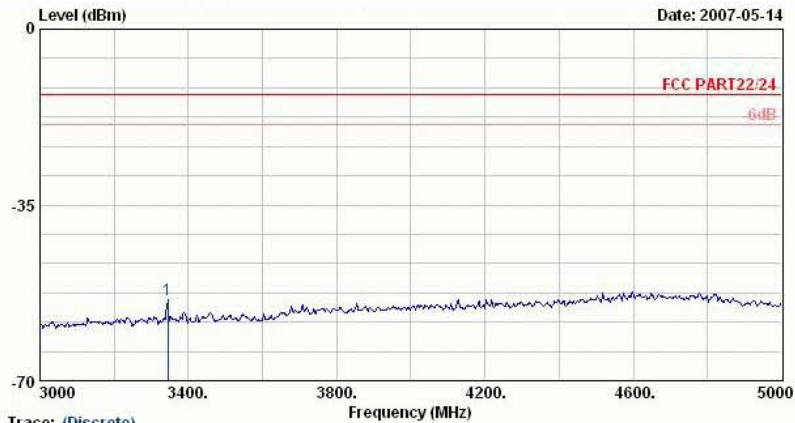

Trace: (Discrete)
 Site : D3CH06-HY
 Condition : HF-SPURIOUS VERTICAL
 EUT : PDA Phone
 Power : 120Vac/60Hz
 Model : FG742004-01
 Memo : EDGE Link;Ch189+Adaptor+Earphone
 Plane : E2

	Freq	Level	Over	Limit	Read	Factor	Remark
	MHz	dBm	dB	dBm	dBm	dB	
1 @	3344.00	-53.95	-40.95	-13.00	-58.42	4.47	Peak

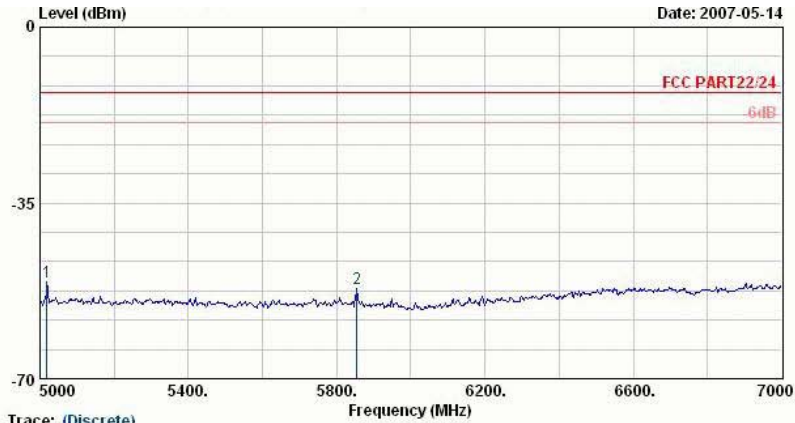

Trace: (Discrete)
 Site : D3CH06-HY
 Condition : HF-SPURIOUS VERTICAL
 EUT : PDA Phone
 Power : 120Vac/60Hz
 Model : FG742004-01
 Memo : EDGE Link;Ch189+Adaptor+Earphone
 Plane : E2

	Freq	Level	Over	Limit	Read	Factor	Remark
	MHz	dBm	dB	dBm	dBm	dB	
1 @	5018.00	-50.71	-37.71	-13.00	-59.55	8.85	Peak
2 @	5854.00	-51.95	-38.95	-13.00	-60.76	8.81	Peak

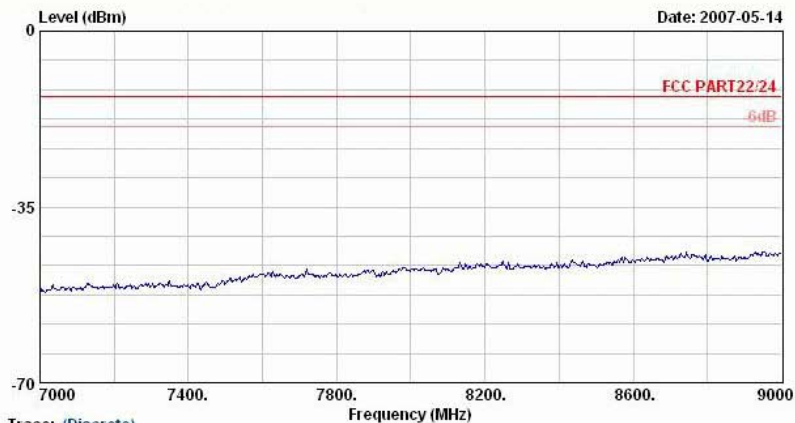

Trace: (Discrete)
 Site : D3CH06-HY
 Condition : HF-SPURIOUS VERTICAL
 EUT : PDA Phone
 Power : 120Vac/60Hz
 Model : FG742004-01
 Memo : EDGE Link;Ch189+Adaptor+Earphone
 Plane : E2

Remark : There is no more obvious emission except the listings above.



4.6.5.3 Mode 3
Horizontal Polarization

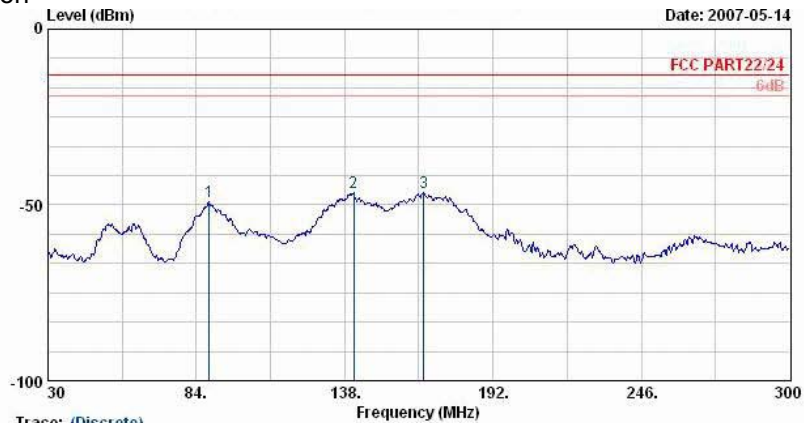

Trace: (Discrete)
 Site : 03CH06-HY
 Condition : LF-SPURIOUS HORIZONTAL
 EUT : PDA Phone
 Power : 120Vac/60Hz
 Model : FG742004-01
 Memo : PCS1900 Link;Ch661+Adaptor+Earphone
 Plane : E2

	Freq MHz	Level dBm	Over Limit dB	Limit Line dBm	Read Level dBm	Factor dB	Remark
1	88.59	-49.17	-36.17	-13.00	-36.88	-12.28	Peak
2	141.24	-46.55	-33.55	-13.00	-33.83	-12.72	Peak
3 @	166.89	-46.40	-33.40	-13.00	-33.39	-13.01	Peak

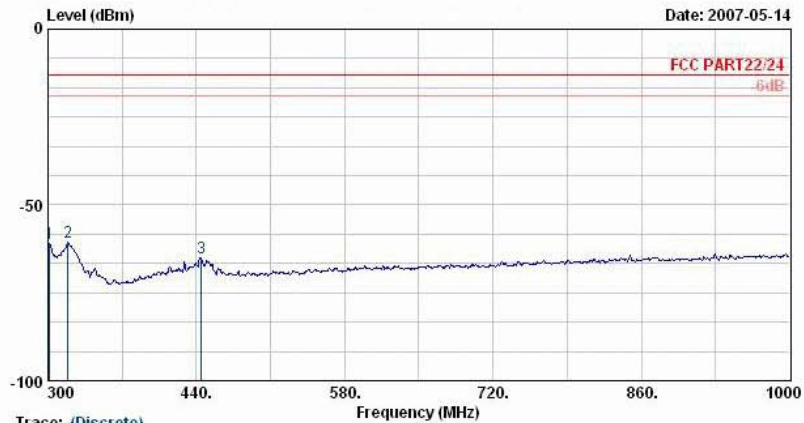

Trace: (Discrete)
 Site : 03CH06-HY
 Condition : LF-SPURIOUS HORIZONTAL
 EUT : PDA Phone
 Power : 120Vac/60Hz
 Model : FG742004-01
 Memo : PCS1900 Link;Ch661+Adaptor+Earphone
 Plane : E2

	Freq MHz	Level dBm	Over Limit dB	Limit Line dBm	Read Level dBm	Factor dB	Remark
1	301.40	-61.06	-48.06	-13.00	-51.18	-9.88	Peak
2	318.90	-60.54	-47.54	-13.00	-51.27	-9.28	Peak
3	444.90	-65.18	-52.18	-13.00	-59.31	-5.87	Peak

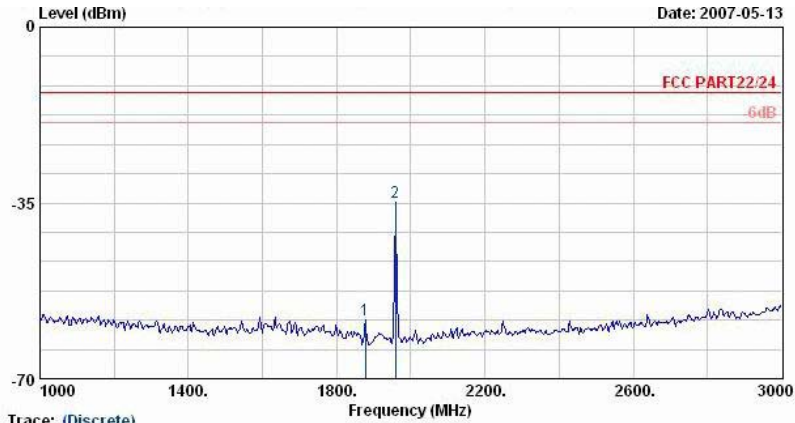

Trace: (Discrete)

Site : D3CH06-HY
 Condition : HF-SPURIOUS HORIZONTAL
 EUT : PDA Phone
 Power : 120Vac/60Hz
 Model : FG742004-01
 Memo : PCS1900 Link;Ch661+Adaptor+Earphone
 Plane : E2

	Freq	Level	Over	Limit	Read	Factor	Remark
	MHz	dBm	dB	dBm	dBm	dB	
1	1878.00	-58.42			-57.91	-0.51	Peak
2 @	1958.00	-34.82			-33.71	-1.11	Peak

Remark:

- #1: MS Signal
- #2: BS Signal

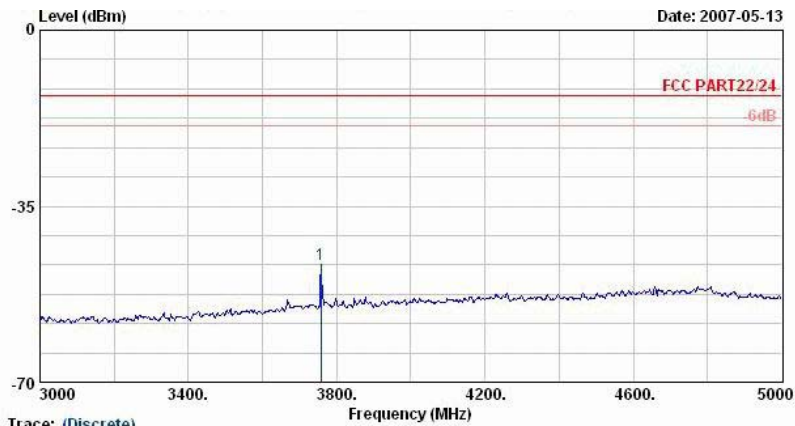

Trace: (Discrete)

Site : D3CH06-HY
 Condition : HF-SPURIOUS HORIZONTAL
 EUT : PDA Phone
 Power : 120Vac/60Hz
 Model : FG742004-01
 Memo : PCS1900 Link;Ch661+Adaptor+Earphone
 Plane : E2

	Freq	Level	Over	Limit	Read	Factor	Remark
	MHz	dBm	dB	dBm	dBm	dB	
1	3758.00	-46.66	-33.66	-13.00	-54.58	7.92	Peak

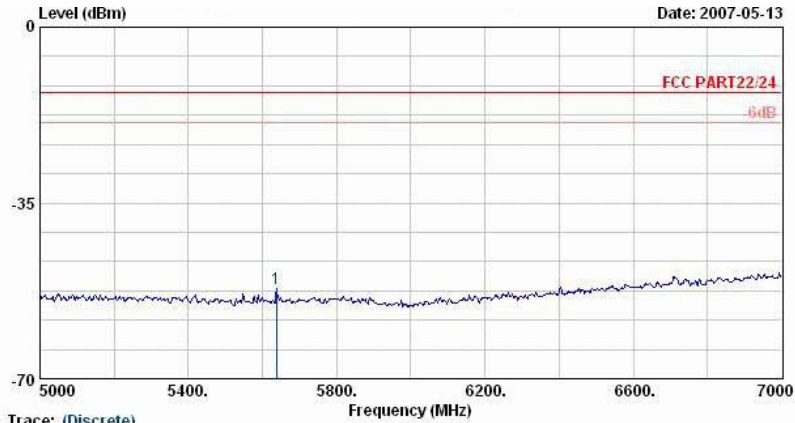

Trace: (Discrete)

Site : D3CH06-HY
 Condition : HF-SPURIOUS HORIZONTAL
 EUT : PDA Phone
 Power : 120Vac/60Hz
 Model : FG742004-01
 Memo : PCS1900 Link;Ch661+Adaptor+Earphone
 Plane : E2

	Freq	Level	Over	Limit	Read	Factor	Remark
	MHz	dBm	dB	dBm	dBm	dB	
1	5638.00	-52.16	-39.16	-13.00	-62.12	9.97	Peak

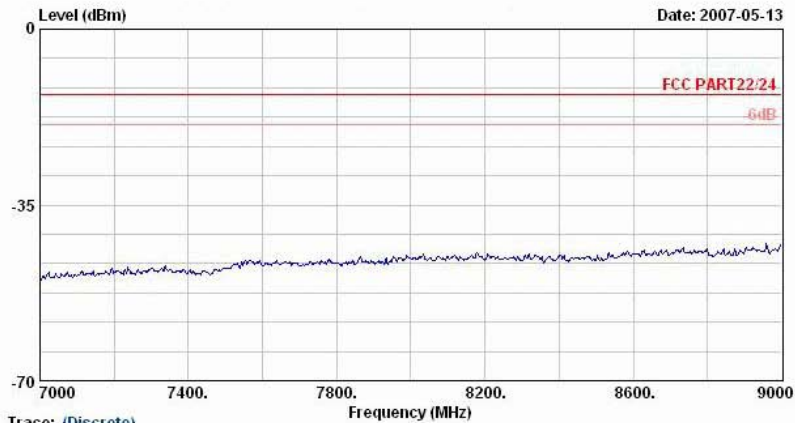

Trace: (Discrete)

Site : D3CH06-HY
 Condition : HF-SPURIOUS HORIZONTAL
 EUT : PDA Phone
 Power : 120Vac/60Hz
 Model : FG742004-01
 Memo : PCS1900 Link;Ch661+Adaptor+Earphone
 Plane : E2

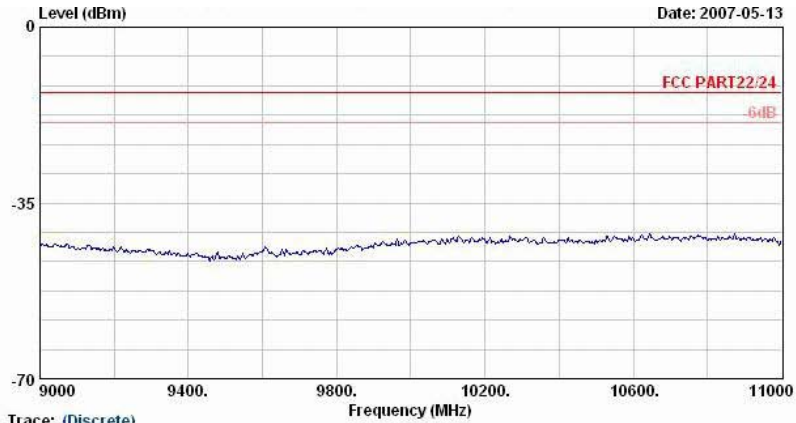

Trace: (Discrete)
 Site : D3CH06-HY
 Condition : HF-SPURIOUS HORIZONTAL
 EUT : PDA Phone
 Power : 120Vac/60Hz
 Model : FG742004-01
 Memo : PCS1900 Link;Ch661+Adaptor+Earphone
 Plane : E2

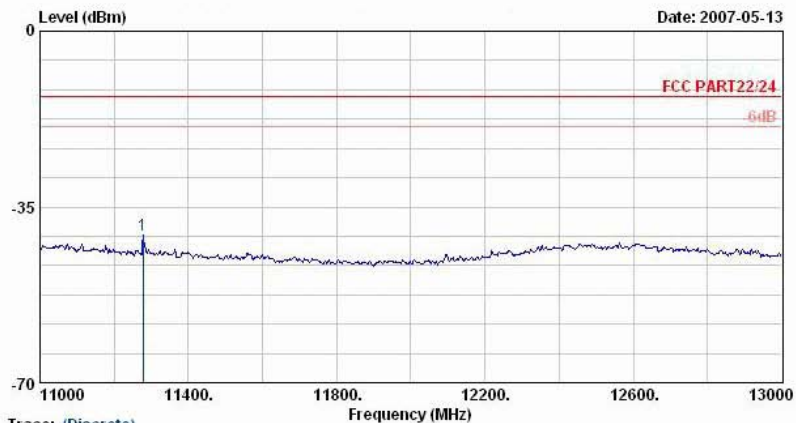

Trace: (Discrete)
 Site : D3CH06-HY
 Condition : HF-SPURIOUS HORIZONTAL
 EUT : PDA Phone
 Power : 120Vac/60Hz
 Model : FG742004-01
 Memo : PCS1900 Link;Ch661+Adaptor+Earphone
 Plane : E2

	Freq	Level	Over	Limit	Read		
	MHz	dBm	Limit	Line	Level	Factor	Remark
			dB	dBm	dBm	dB	
1 @	11278.00	-40.59	-27.59	-13.00	-60.89	20.30	Peak

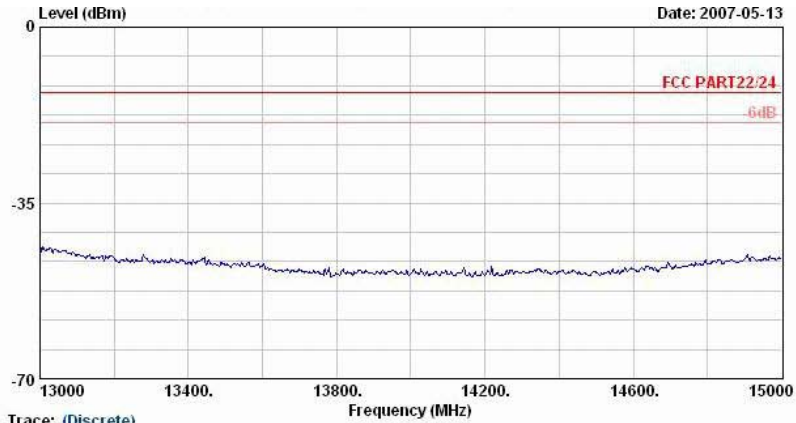

Site : D3CH06-HY
Condition : HF-SPORTIOUS HORIZONTAL
EUT : PDA Phone
Power : 120Vac/60Hz
Model : FG742004-01
Memo : PCS1900 Link;Ch661+Adaptor+Earphone
Plane : E2

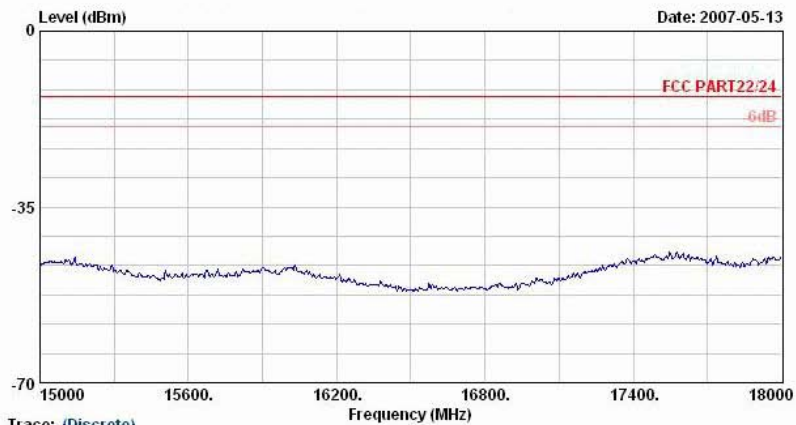

Site : D3CH06-HY
Condition : HF-SPORTIOUS HORIZONTAL
EUT : PDA Phone
Power : 120Vac/60Hz
Model : FG742004-01
Memo : PCS1900 Link;Ch661+Adaptor+Earphone
Plane : E2



Vertical Polarization

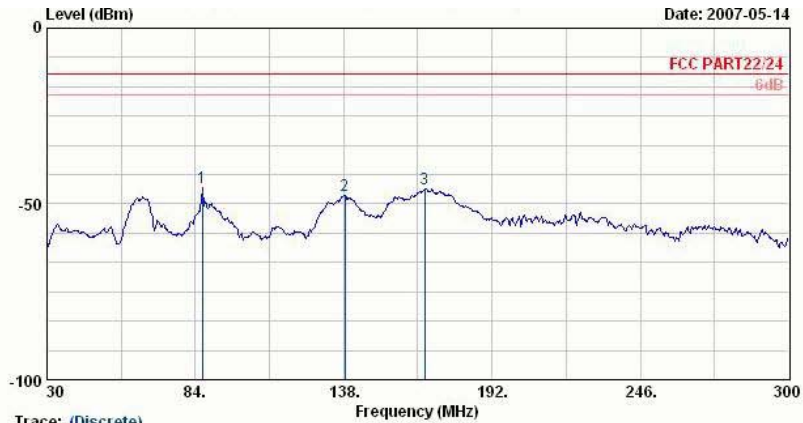

Trace: (Discrete)
 Site : D3CH06-HY
 Condition : LF-SPURIOUS VERTICAL
 EUT : PDA Phone
 Power : 120Vac/60Hz
 Model : FG742004-01
 Memo : PCS1900 Link;Ch661+Adaptor+Earphone
 Plane : E2

	Freq MHz	Level dBm	Over Limit dB	Limit Line dBm	Read Level dBm	Factor dB	Remark
1 @	86.43	-45.50	-32.50	-13.00	-35.86	-9.65	Peak
2	138.54	-47.43	-34.43	-13.00	-39.39	-8.04	Peak
3 @	167.43	-45.87	-32.87	-13.00	-37.57	-8.30	Peak

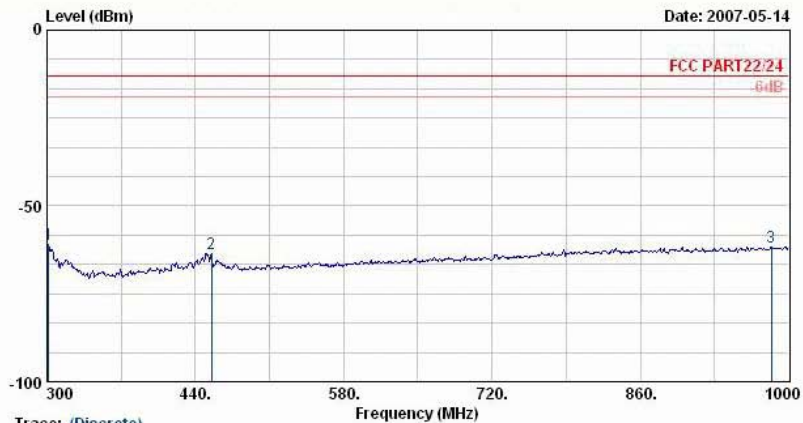

Trace: (Discrete)
 Site : D3CH06-HY
 Condition : LF-SPURIOUS VERTICAL
 EUT : PDA Phone
 Power : 120Vac/60Hz
 Model : FG742004-01
 Memo : PCS1900 Link;Ch661+Adaptor+Earphone
 Plane : E2

	Freq MHz	Level dBm	Over Limit dB	Limit Line dBm	Read Level dBm	Factor dB	Remark
1	301.40	-60.93	-47.93	-13.00	-54.51	-6.42	Peak
2	455.40	-63.53	-50.53	-13.00	-59.87	-3.66	Peak
3	983.90	-61.63	-48.63	-13.00	-64.16	2.53	Peak

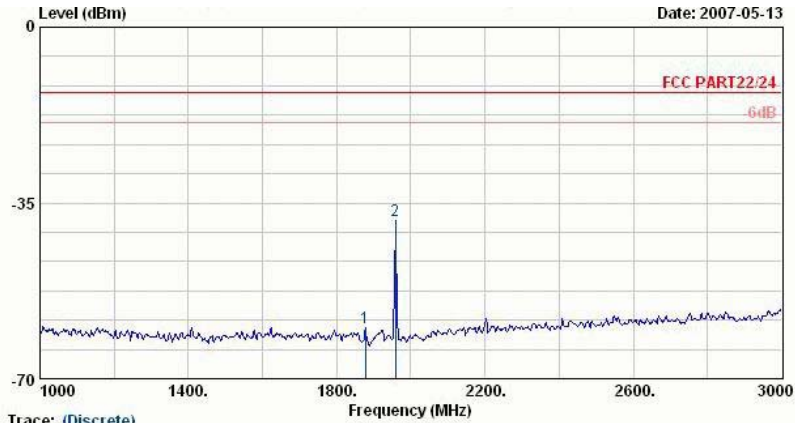

Trace: (Discrete)
 Site : D3CH06-HY
 Condition : HF-SPURIOUS VERTICAL
 EUT : PDA Phone
 Power : 120Vac/60Hz
 Model : FG742004-01
 Memo : PCS1900 Link;Ch661+Adaptor+Earphone
 Plane : E2

	Freq	Level	Over	Limit	Read	Factor	Remark
	MHz	dBm	dB	dBm	dBm	dB	
1	1878.00	-59.77			-59.37	-0.40	Peak
2 @	1958.00	-38.50			-37.91	-0.60	Peak

Remark:

- #1: MS Signal
- #2: BS Signal

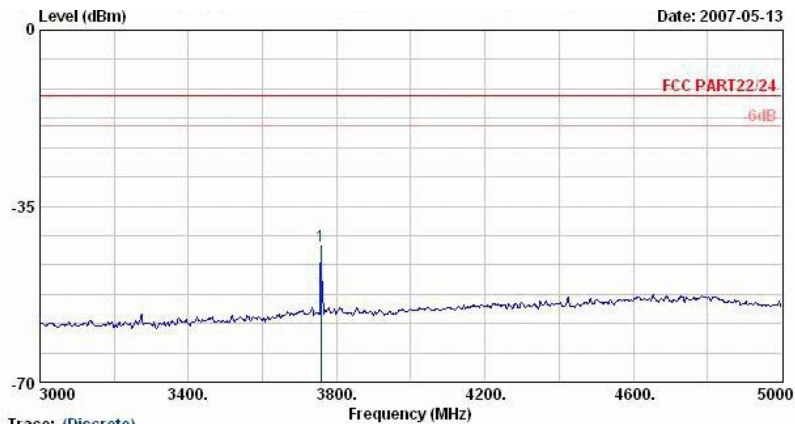

Trace: (Discrete)
 Site : D3CH06-HY
 Condition : HF-SPURIOUS VERTICAL
 EUT : PDA Phone
 Power : 120Vac/60Hz
 Model : FG742004-01
 Memo : PCS1900 Link;Ch661+Adaptor+Earphone
 Plane : E2

	Freq	Level	Over	Limit	Read	Factor	Remark
	MHz	dBm	dB	dBm	dBm	dB	
1 @	3758.00	-42.84	-29.84	-13.00	-49.47	6.64	Peak

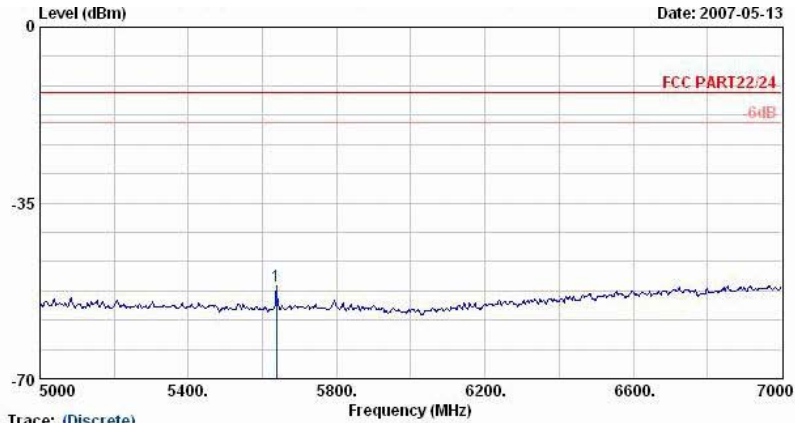

Trace: (Discrete)
 Site : D3CH06-HY
 Condition : HF-SPORTIOUS VERTICAL
 EUT : PDA Phone
 Power : 120Vac/60Hz
 Model : FG742004-01
 Memo : PCS1900 Link;Ch661+Adaptor+Earphone
 Plane : E2

	Freq	Level	Over	Limit	Read	Factor	Remark
	MHz	dBm	dB	dBm	dBm	dB	
1	5638.00	-51.55	-38.55	-13.00	-60.21	8.65	Peak

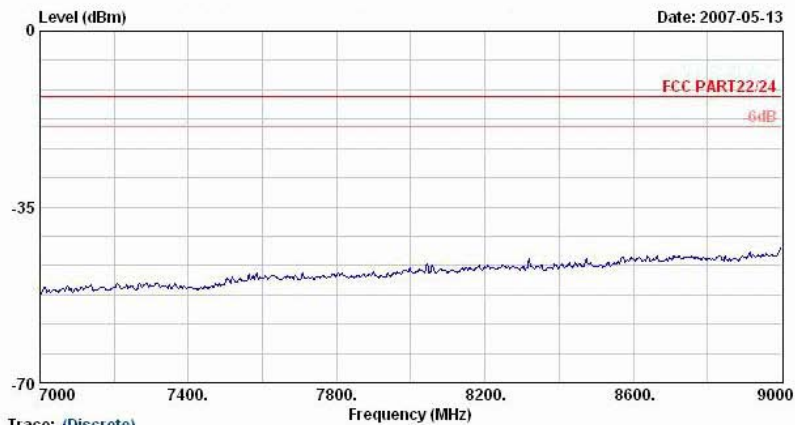

Trace: (Discrete)
 Site : D3CH06-HY
 Condition : HF-SPORTIOUS VERTICAL
 EUT : PDA Phone
 Power : 120Vac/60Hz
 Model : FG742004-01
 Memo : PCS1900 Link;Ch661+Adaptor+Earphone
 Plane : E2

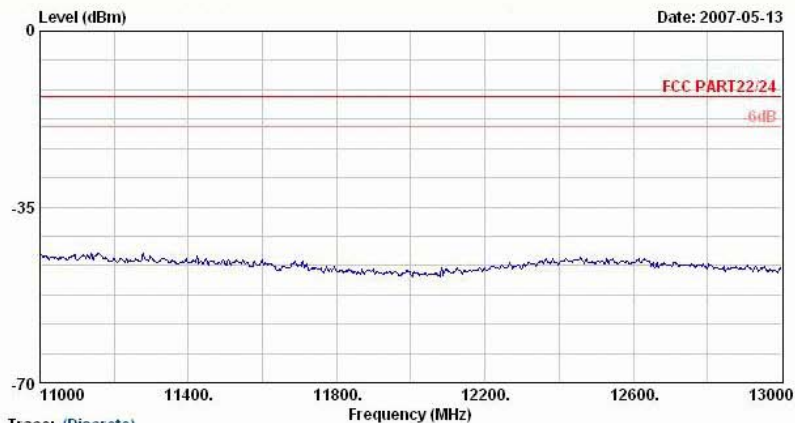
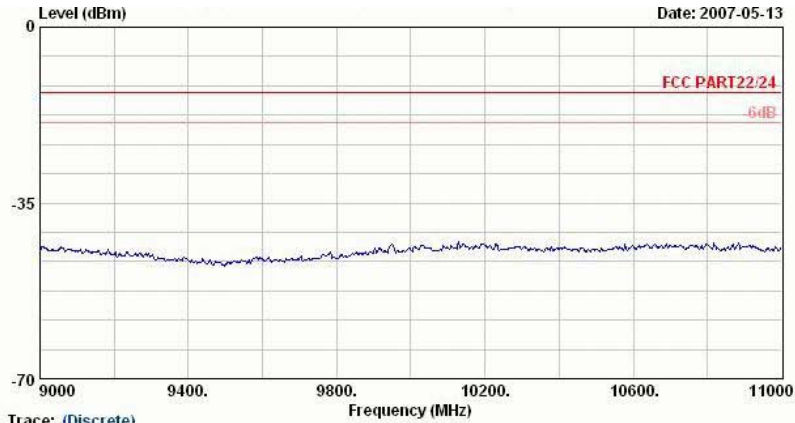

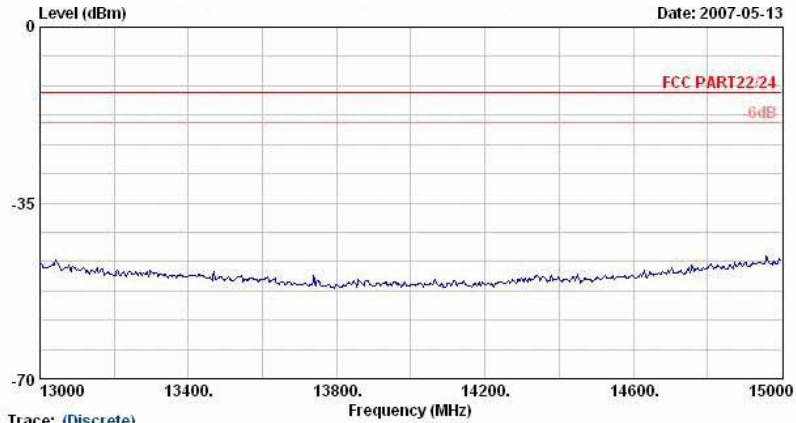

Trace: (Discrete)
Site : D3CH06-HY
Condition : HF-SPURIOUS VERTICAL
EUT : PDA Phone
Power : 120Vac/60Hz
Model : FG742004-01
Memo : PCS1900 Link;Ch661+Adaptor+Earphone
Plane : E2

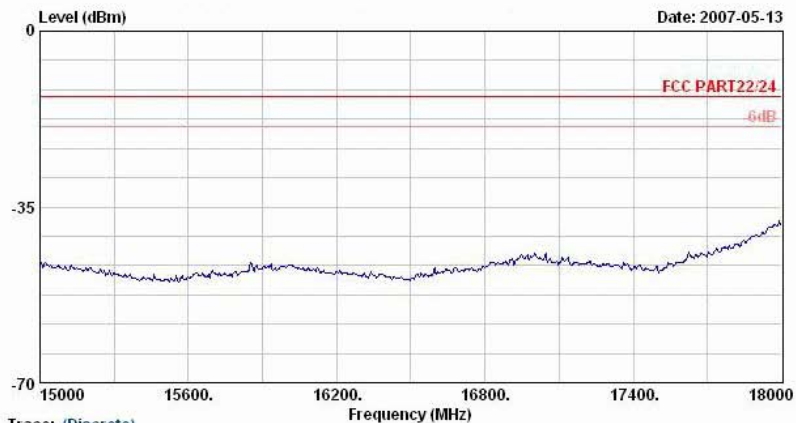

Trace: (Discrete)
Site : D3CH06-HY
Condition : HF-SPURIOUS VERTICAL
EUT : PDA Phone
Power : 120Vac/60Hz
Model : FG742004-01
Memo : PCS1900 Link;Ch661+Adaptor+Earphone
Plane : E2

Remark : There is no more obvious emission except the listings above.



4.6.5.4 Mode 4
Horizontal Polarization

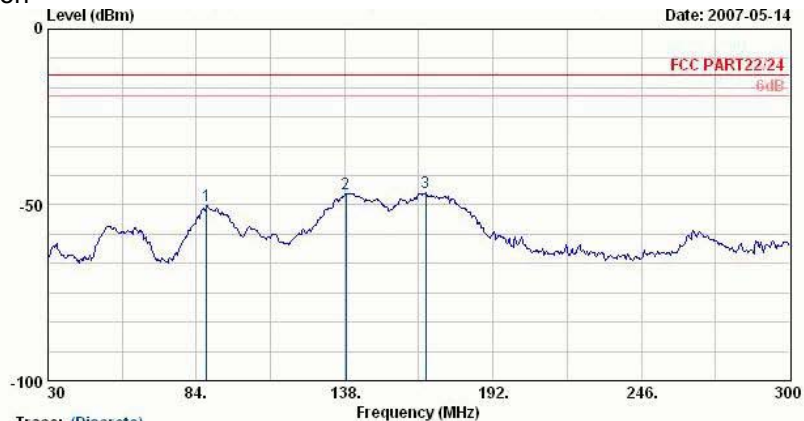

Trace: (Discrete)
 Site : 03CH06-HY
 Condition : LF-SPURIOUS HORIZONTAL
 EUT : PDA Phone
 Power : 120Vac/60Hz
 Model : FG742004-01
 Memo : EDGE Link;Ch661+Adaptor+Earphone
 Plane : E2

	Freq MHz	Level dBm	Over Limit dB	Limit Line dBm	Read Level dBm	Factor dB	Remark
1	87.78	-50.01	-37.01	-13.00	-37.72	-12.28	Peak
2	138.54	-46.71	-33.71	-13.00	-34.02	-12.69	Peak
3 @	167.43	-46.59	-33.59	-13.00	-33.57	-13.02	Peak

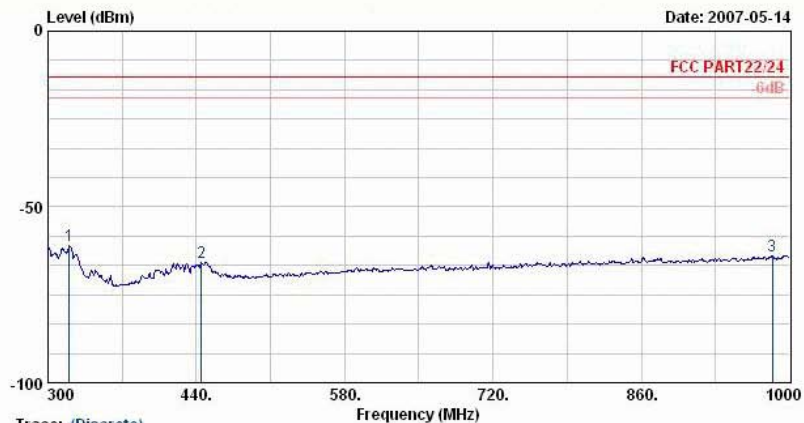

Trace: (Discrete)
 Site : 03CH06-HY
 Condition : LF-SPURIOUS HORIZONTAL
 EUT : PDA Phone
 Power : 120Vac/60Hz
 Model : FG742004-01
 Memo : EDGE Link;Ch661+Adaptor+Earphone
 Plane : E2

	Freq MHz	Level dBm	Over Limit dB	Limit Line dBm	Read Level dBm	Factor dB	Remark
1	320.30	-61.13	-48.13	-13.00	-51.89	-9.24	Peak
2	444.90	-65.71	-52.71	-13.00	-59.83	-5.87	Peak
3	983.90	-63.98	-50.98	-13.00	-64.06	0.08	Peak

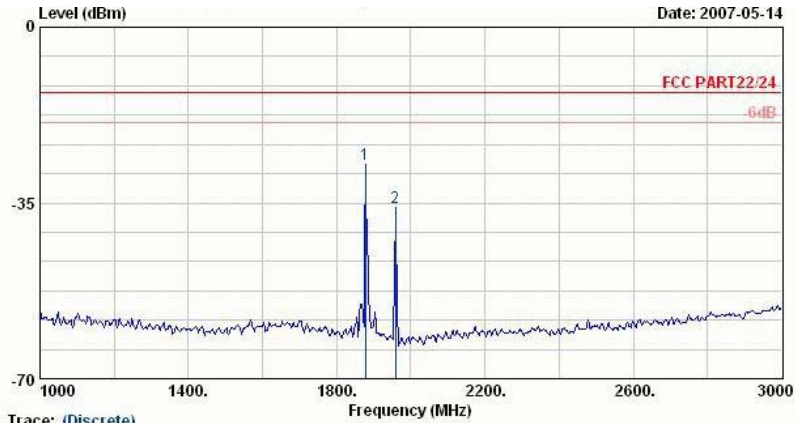

Date: 2007-05-14

Trace: (Discrete)
 Site : D3CH06-HY
 Condition : HF-SPURIOUS HORIZONTAL
 EUT : PDA Phone
 Power : 120Vac/60Hz
 Model : FG742004-01
 Memo : EDGE Link;Ch661+Adaptor+Earphone
 Plane : E2

	Freq	Level	Over	Limit	Read	Factor	Remark
	MHz	dBm	dB	dBm	dBm	dB	
1 @	1878.00	-27.23			-26.72	-0.51	Peak
2 @	1958.00	-35.99			-34.88	-1.11	Peak

Remark:

- #1: MS Signal
- #2: BS Signal

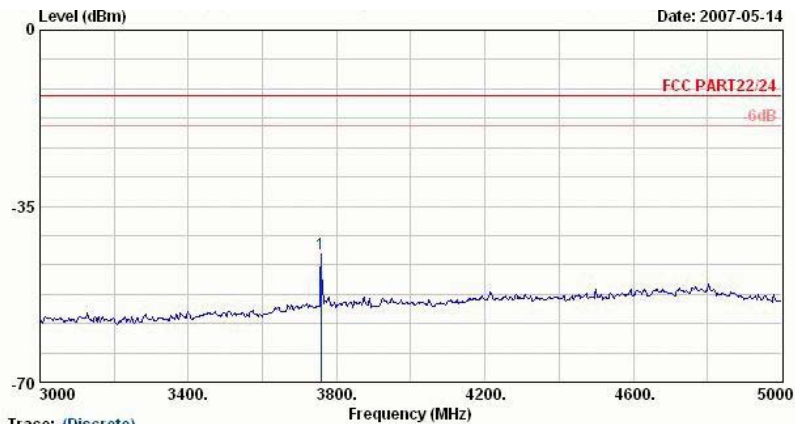

Date: 2007-05-14

Trace: (Discrete)
 Site : D3CH06-HY
 Condition : HF-SPURIOUS HORIZONTAL
 EUT : PDA Phone
 Power : 120Vac/60Hz
 Model : FG742004-01
 Memo : EDGE Link;Ch661+Adaptor+Earphone
 Plane : E2

	Freq	Level	Over	Limit	Read	Factor	Remark
	MHz	dBm	dB	dBm	dBm	dB	
1 @	3758.00	-44.54	-31.54	-13.00	-52.46	7.92	Peak

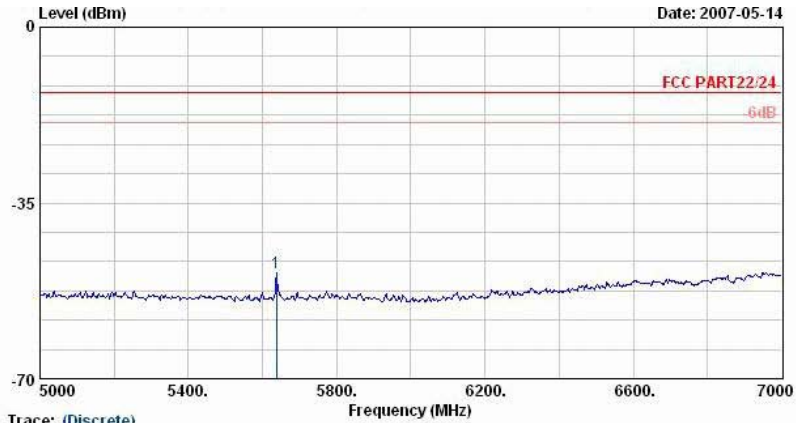

Trace: (Discrete)
 Site : D3CH06-HY
 Condition : HF-SPURIOUS HORIZONTAL
 EUT : PDA Phone
 Power : 120Vac/60Hz
 Model : FG742004-01
 Memo : EDGE Link;Ch661+Adaptor+Earphone
 Plane : E2

	Freq	Level	Over	Limit	Read	Factor	Remark
	MHz	dBm	dB	dBm	dBm	dB	
1	5638.00	-48.87	-35.87	-13.00	-58.83	9.97	Peak

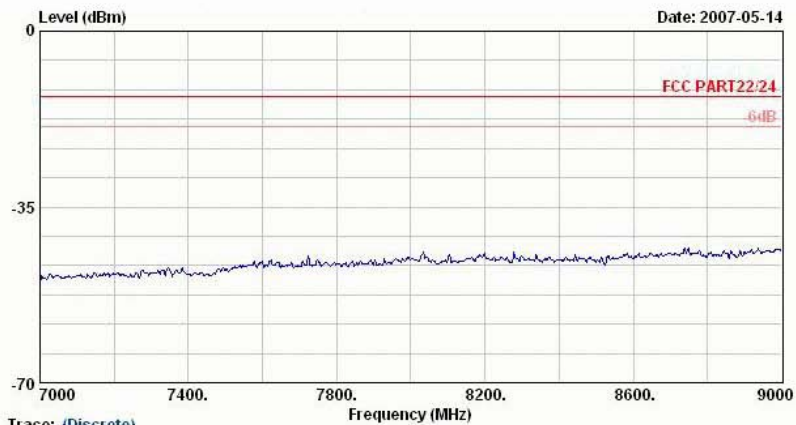

Trace: (Discrete)
 Site : D3CH06-HY
 Condition : HF-SPURIOUS HORIZONTAL
 EUT : PDA Phone
 Power : 120Vac/60Hz
 Model : FG742004-01
 Memo : EDGE Link;Ch661+Adaptor+Earphone
 Plane : E2

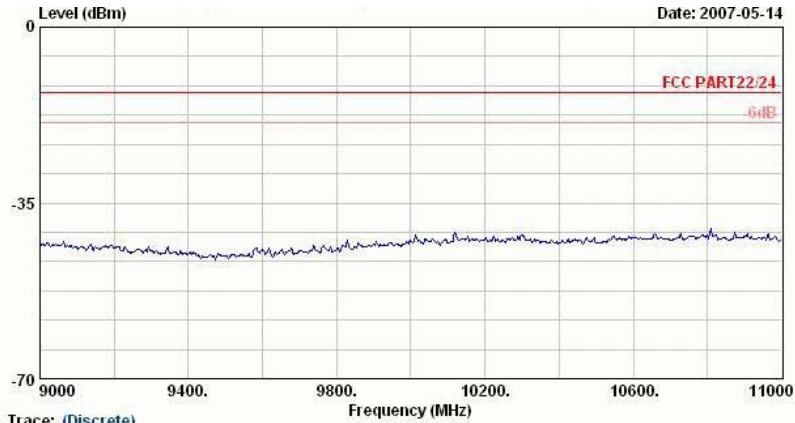

Site : D3CH06-HY
 Condition : HF-SPURIOUS HORIZONTAL
 EUT : PDA Phone
 Power : 120Vac/60Hz
 Model : FG742004-01
 Memo : EDGE Link;Ch661+Adaptor+Earphone
 Plane : E2

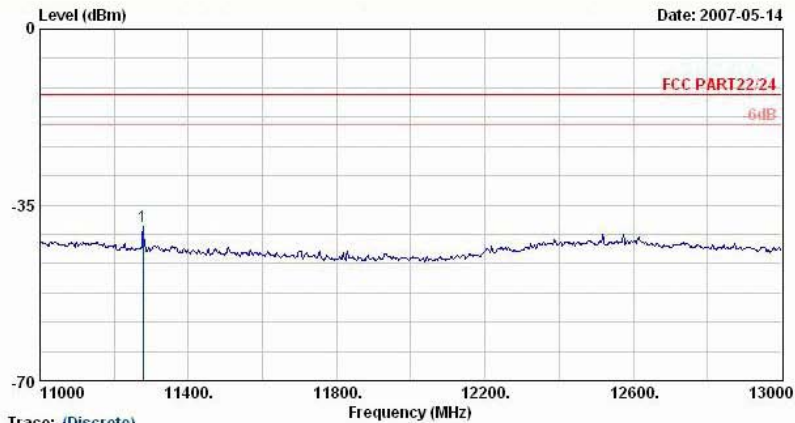

Site : D3CH06-HY
 Condition : HF-SPURIOUS HORIZONTAL
 EUT : PDA Phone
 Power : 120Vac/60Hz
 Model : FG742004-01
 Memo : EDGE Link;Ch661+Adaptor+Earphone
 Plane : E2

	Freq	Level	Over	Limit	Read		
	MHz	dBm	Limit	Line	Level	Factor	Remark
			dB	dBm	dBm	dB	
1 @	11278.00	-39.42	-26.42	-13.00	-59.72	20.30	Peak

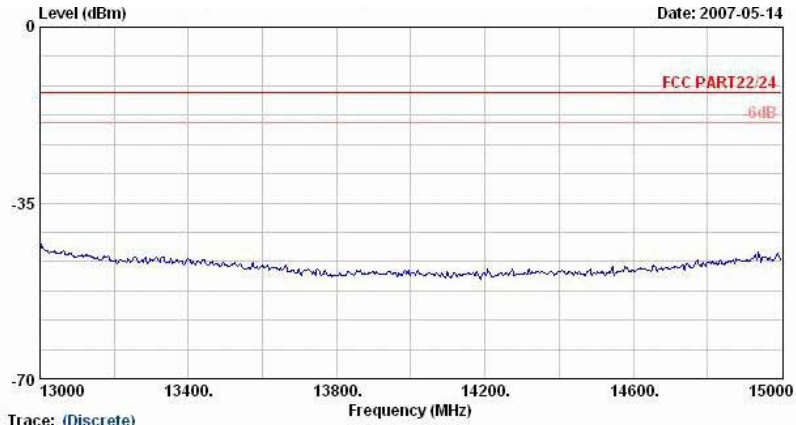

Trace: (Discrete)
Site : D3CH06-HY
Condition : HF-SPORTIOUS HORIZONTAL
EUT : PDA Phone
Power : 120Vac/60Hz
Model : FG742004-01
Memo : EDGE Link;Ch661+Adaptor+Earphone
Plane : E2

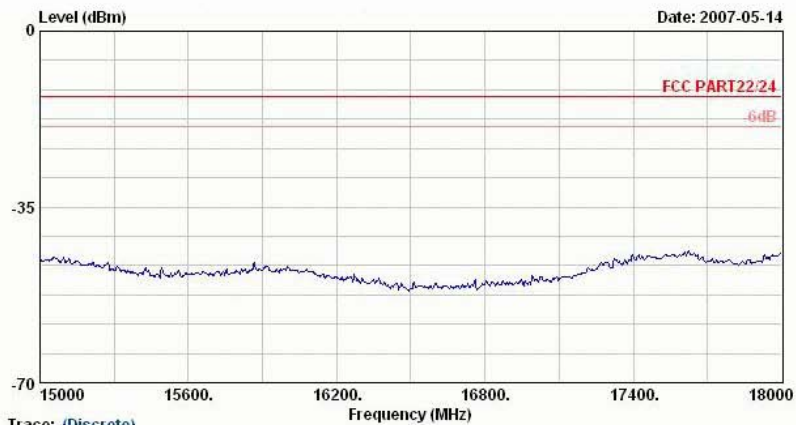

Trace: (Discrete)
Site : D3CH06-HY
Condition : HF-SPORTIOUS HORIZONTAL
EUT : PDA Phone
Power : 120Vac/60Hz
Model : FG742004-01
Memo : EDGE Link;Ch661+Adaptor+Earphone
Plane : E2



Vertical Polarization

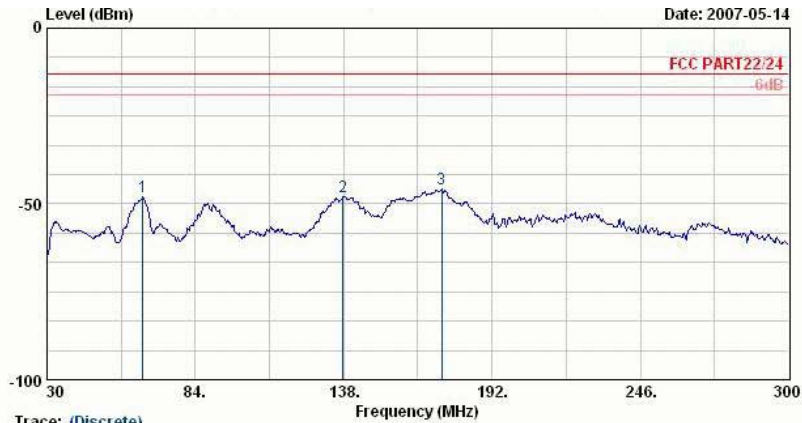

Trace: (Discrete)
 Site : D3CH06-HY
 Condition : LF-SPURIOUS VERTICAL
 EUT : PDA Phone
 Power : 120Vac/60Hz
 Model : FG742004-01
 Memo : EDGE Link;Ch661+Adaptor+Earphone
 Plane : E2

	Freq MHz	Level dBm	Over Limit dB	Limit Line dBm	Read Level dBm	Factor dB	Remark
1	64.83	-48.04	-35.04	-13.00	-35.31	-12.72	Peak
2	137.73	-47.82	-34.82	-13.00	-39.79	-8.03	Peak
3 @	173.64	-45.79	-32.79	-13.00	-37.44	-8.35	Peak

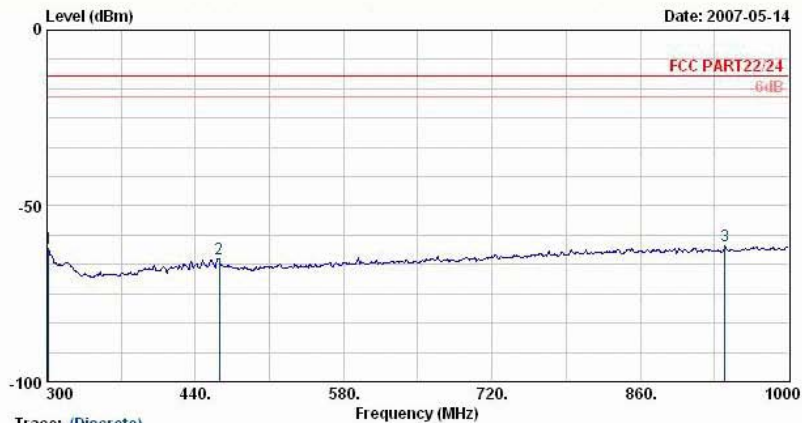

Trace: (Discrete)
 Site : D3CH06-HY
 Condition : LF-SPURIOUS VERTICAL
 EUT : PDA Phone
 Power : 120Vac/60Hz
 Model : FG742004-01
 Memo : EDGE Link;Ch661+Adaptor+Earphone
 Plane : E2

	Freq MHz	Level dBm	Over Limit dB	Limit Line dBm	Read Level dBm	Factor dB	Remark
1	301.40	-62.01	-49.01	-13.00	-55.59	-6.42	Peak
2	462.40	-64.93	-51.93	-13.00	-61.36	-3.58	Peak
3	939.80	-61.41	-48.41	-13.00	-63.59	2.18	Peak

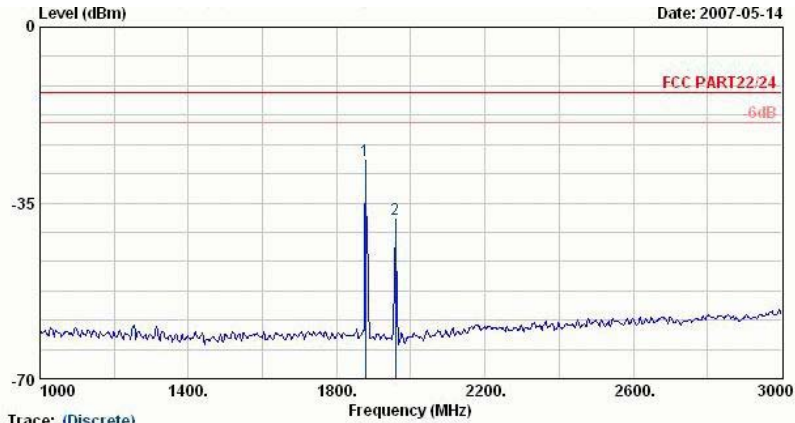

Trace: (Discrete)
 Site : D3CH06-HY
 Condition : HF-SPURIOUS VERTICAL
 EUT : PDA Phone
 Power : 120Vac/60Hz
 Model : FG742004-01
 Memo : EDGE Link;Ch661+Adaptor+Earphone
 Plane : E2

	Freq	Level	Over	Limit	Read	Factor	Remark
	MHz	dBm	dB	dBm	dBm	dB	
1 @	1878.00	-26.46			-26.06	-0.40	Peak
2 @	1958.00	-38.24			-37.64	-0.60	Peak

Remark:

- #1: MS Signal
- #2: BS Signal

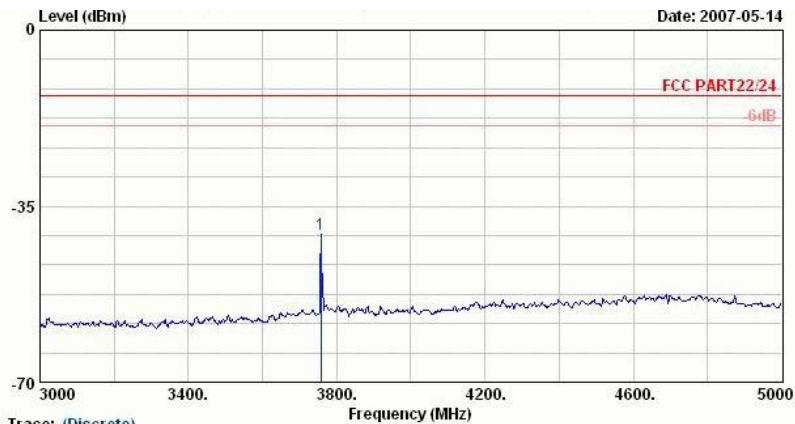

Trace: (Discrete)
 Site : D3CH06-HY
 Condition : HF-SPURIOUS VERTICAL
 EUT : PDA Phone
 Power : 120Vac/60Hz
 Model : FG742004-01
 Memo : EDGE Link;Ch661+Adaptor+Earphone
 Plane : E2

	Freq	Level	Over	Limit	Read	Factor	Remark
	MHz	dBm	dB	dBm	dBm	dB	
1 @	3758.00	-40.50	-27.50	-13.00	-47.14	6.64	Peak

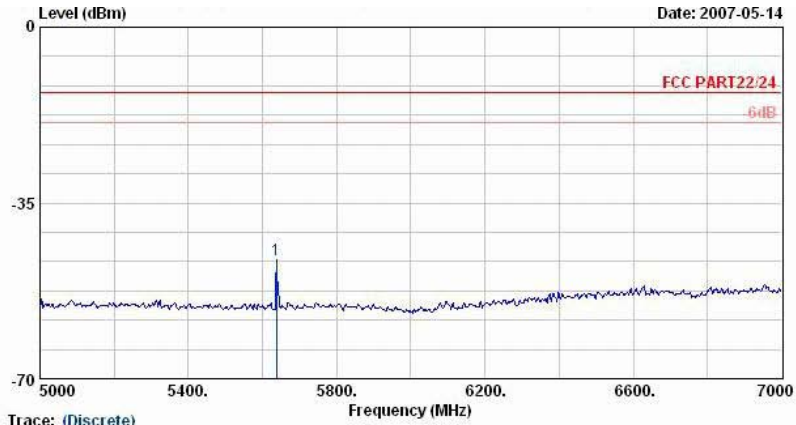

Trace: (Discrete)

Site : D3CH06-HY
 Condition : HF-SPURIOUS VERTICAL
 EUT : PDA Phone
 Power : 120Vac/60Hz
 Model : FG742004-01
 Memo : EDGE Link;Ch661+Adaptor+Earphone
 Plane : E2

	Freq	Level	Over	Limit	Read	Factor	Remark
	MHz	dBm	dB	dBm	dBm	dB	
1 @	5638.00	-46.36	-33.36	-13.00	-55.01	8.65	Peak

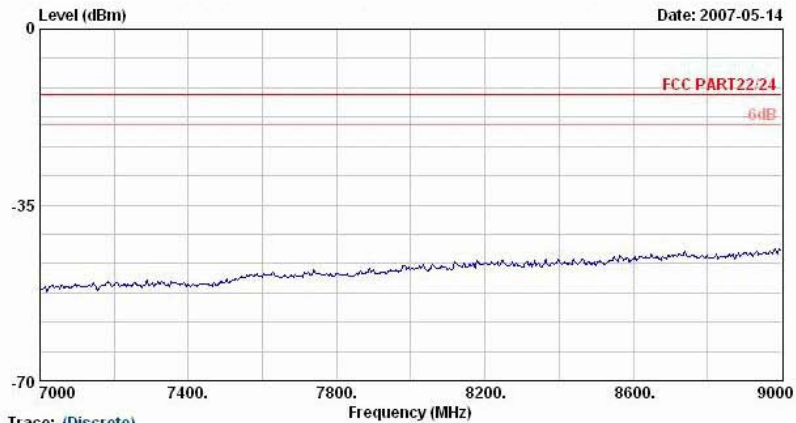

Trace: (Discrete)

Site : D3CH06-HY
 Condition : HF-SPURIOUS VERTICAL
 EUT : PDA Phone
 Power : 120Vac/60Hz
 Model : FG742004-01
 Memo : EDGE Link;Ch661+Adaptor+Earphone
 Plane : E2

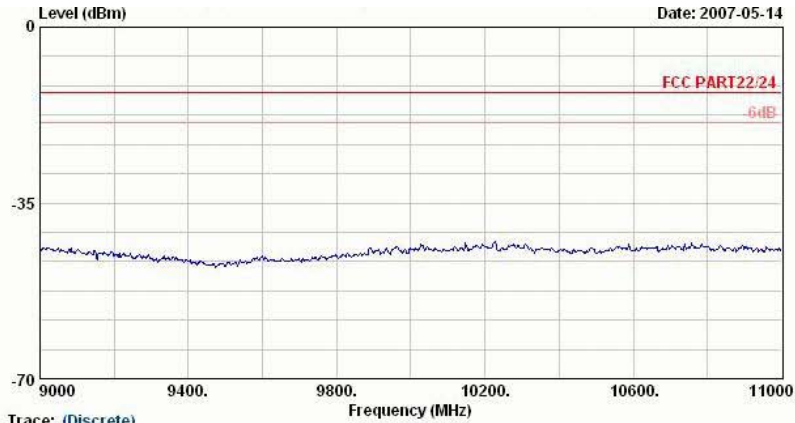

Site : D3CH06-HY
 Condition : HF-SPURIOUS VERTICAL
 EUT : PDA Phone
 Power : 120Vac/60Hz
 Model : FG742004-01
 Memo : EDGE Link;Ch661+Adaptor+Earphone
 Plane : E2

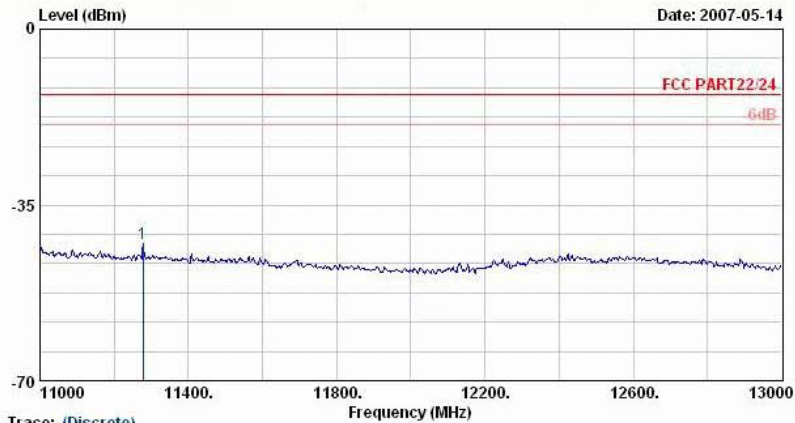

Site : D3CH06-HY
 Condition : HF-SPURIOUS VERTICAL
 EUT : PDA Phone
 Power : 120Vac/60Hz
 Model : FG742004-01
 Memo : EDGE Link;Ch661+Adaptor+Earphone
 Plane : E2

	Freq	Level	Over	Limit	Read		
	MHz	dBm	Limit	Line	Level	Factor	Remark
			dB	dBm	dBm	dB	
1 @	11278.00	-42.71	-29.71	-13.00	-61.59	18.87	Peak

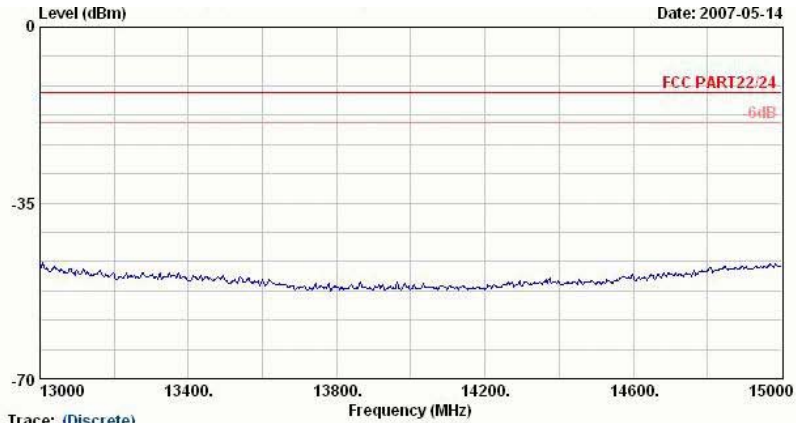

Trace: (Discrete)
Site : D3CH06-HY
Condition : HF-SPURIOUS VERTICAL
EUT : PDA Phone
Power : 120Vac/60Hz
Model : FG742004-01
Memo : EDGE Link;Ch661+Adaptor+Earphone
Plane : E2

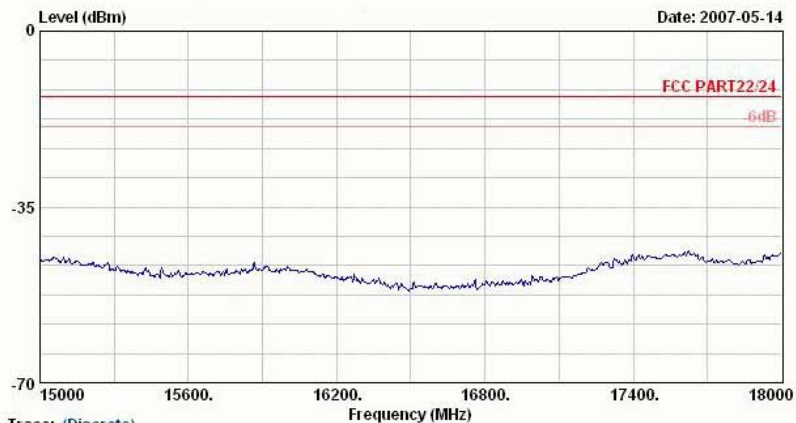

Trace: (Discrete)
Site : D3CH06-HY
Condition : HF-SPURIOUS VERTICAL
EUT : PDA Phone
Power : 120Vac/60Hz
Model : FG742004-01
Memo : EDGE Link;Ch661+Adaptor+Earphone
Plane : E2

Remark : There is no more obvious emission except the listings above.



4.6.5.5 Mode 5
Horizontal Polarization

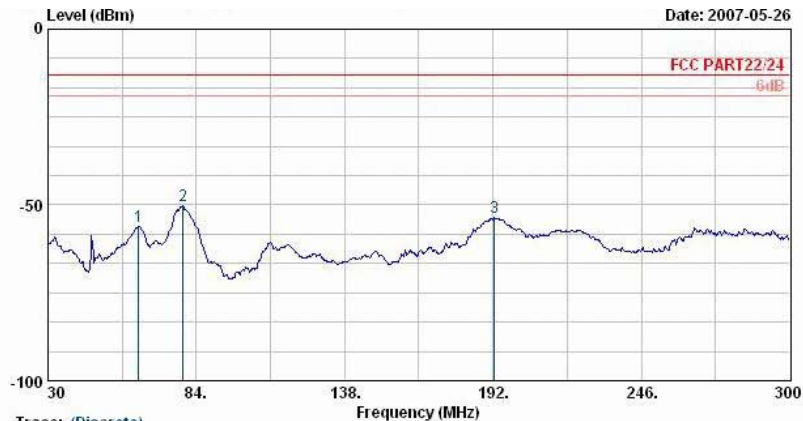

Trace: (Discrete)
 Site : 03CH06-HY
 Condition : LF-SPURIOUS HORIZONTAL
 EUT : PDA Phone
 Power : 120Vac/60Hz
 Model : FG742004-01
 Memo : GSM 850 Link;Ch189 + WLAN 11g Tx_Ch01
 Memo : + Adaptor + Earphone
 Plane : E2

	Freq	Level	Over	Limit	Read	Factor	Remark
	MHz	dBm	dB	dBm	dBm	dB	
1	62.94	-56.18	-43.18	-13.00	-43.80	-12.38	Peak
2	79.14	-50.16	-37.16	-13.00	-37.84	-12.32	Peak
3	192.54	-53.62	-40.62	-13.00	-40.31	-13.31	Peak



Trace: (Discrete)
 Site : 03CH06-HY
 Condition : LF-SPURIOUS HORIZONTAL
 EUT : PDA Phone
 Power : 120Vac/60Hz
 Model : FG742004-01
 Memo : GSM 850 Link;Ch189 + WLAN 11g Tx_Ch01
 Memo : + Adaptor + Earphone
 Plane : E2

	Freq	Level	Over	Limit	Read	Factor	Remark
	MHz	dBm	dB	dBm	dBm	dB	
1	357.40	-58.00	-45.00	-13.00	-50.07	-7.94	Peak
2 @	836.90	-36.97			-35.63	-1.33	Peak
3 @	880.30	-36.27			-35.36	-0.91	Peak

Remark:

- 1. #2: MS Signal
- 2. #3: BS Signal

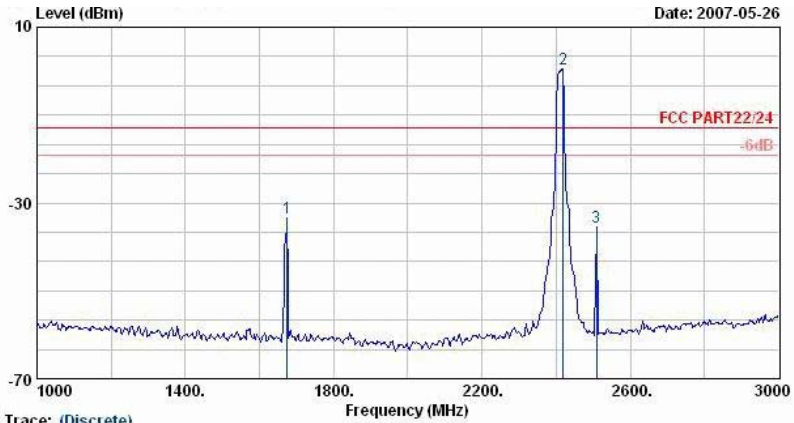

Trace: (Discrete)
 Site : D3CH06-HY
 Condition : HF-SPURIOUS HORIZONTAL
 EUT : PDA Phone
 Power : 120Vac/60Hz
 Model : FG742004-01
 Memo : GSM 850 Link;Ch189 + WLAN 11g Tx_Ch01
 Memo : + Adaptor + Earphone
 Plane : E2

	Freq	Level	Over	Limit	Read		
	MHz	dBm	dB	dBm	dBm	dB	Remark
1 @	1674.00	-33.54	-20.54	-13.00	-33.76	0.22	Peak
2 @	2418.00	0.60			-0.40	1.00	Peak
3 @	2508.00	-35.55	-22.55	-13.00	-36.75	1.20	Peak

Remark:
 1. #2: WLAN Signal

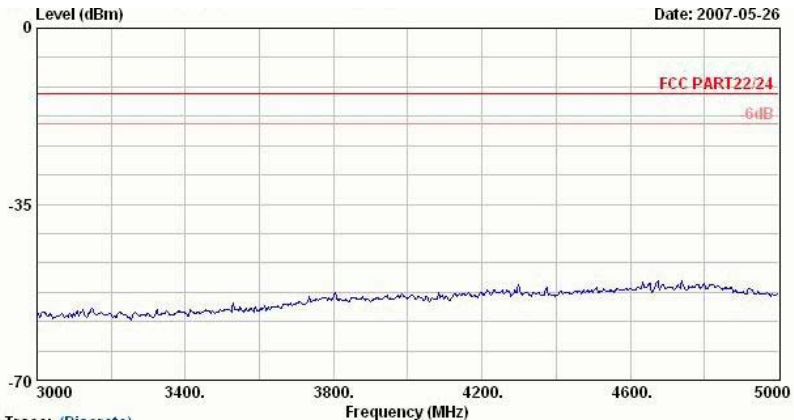

Trace: (Discrete)
 Site : D3CH06-HY
 Condition : HF-SPURIOUS HORIZONTAL
 EUT : PDA Phone
 Power : 120Vac/60Hz
 Model : FG742004-01
 Memo : GSM 850 Link;Ch189 + WLAN 11g Tx_Ch01
 Memo : + Adaptor + Earphone
 Plane : E2

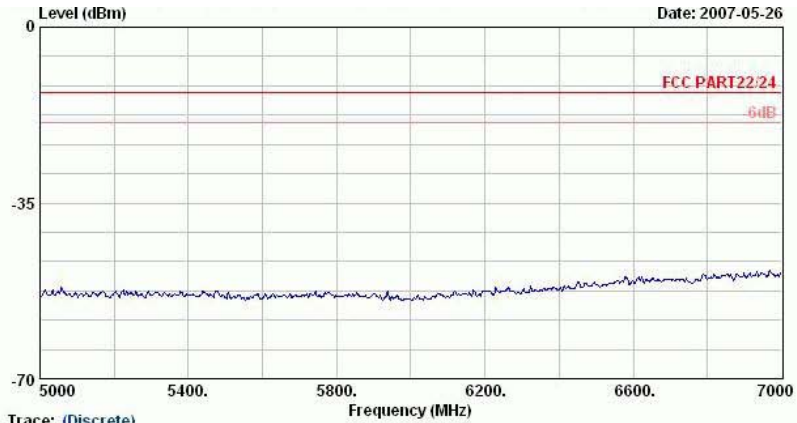

Trace: (Discrete)

Site : D3CH06-HY
Condition : HF-SPURIOUS HORIZONTAL
EUT : PDA Phone
Power : 120Vac/60Hz
Model : FG742004-01
Memo : GSM 850 Link;Ch189 + WLAN 11g Tx_Ch01
Memo : + Adaptor + Earphone
Plane : E2

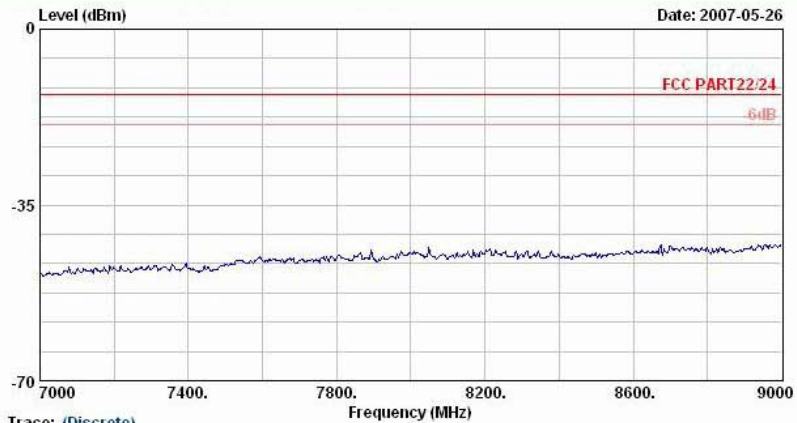

Trace: (Discrete)

Site : D3CH06-HY
Condition : HF-SPURIOUS HORIZONTAL
EUT : PDA Phone
Power : 120Vac/60Hz
Model : FG742004-01
Memo : GSM 850 Link;Ch189 + WLAN 11g Tx_Ch01
Memo : + Adaptor + Earphone
Plane : E2



Vertical Polarization

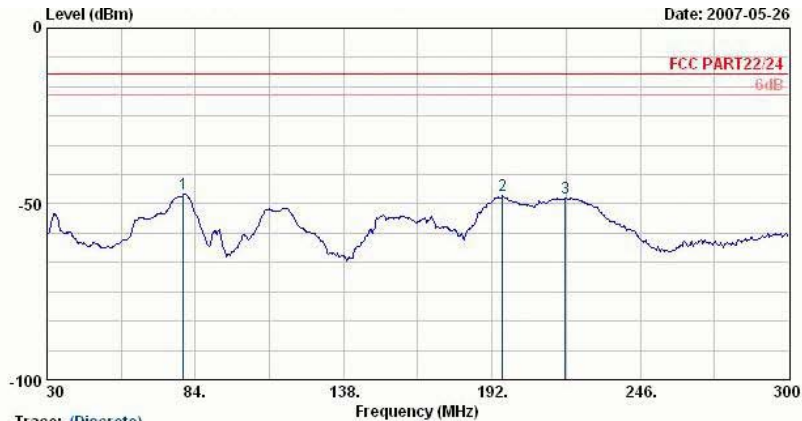

Site : D3CH06-HY
 Condition : LF-SPURIOUS VERTICAL
 EUT : PDA Phone
 Power : 120Vac/60Hz
 Model : FG742004-01
 Memo : GSM 850 Link;Ch189 + WLAN 11g Tx_Ch01
 + Adaptor + Earphone
 Plane : E2

Trace: (Discrete)

	Freq	Level	Over	Limit	Read	Factor	Remark
	MHz	dBm	dB	dBm	dBm	dB	
1 @	79.68	-47.23	-34.23	-13.00	-36.60	-10.63	Peak
2	195.78	-47.74	-34.74	-13.00	-39.19	-8.56	Peak
3	218.73	-48.20	-35.20	-13.00	-40.02	-8.18	Peak

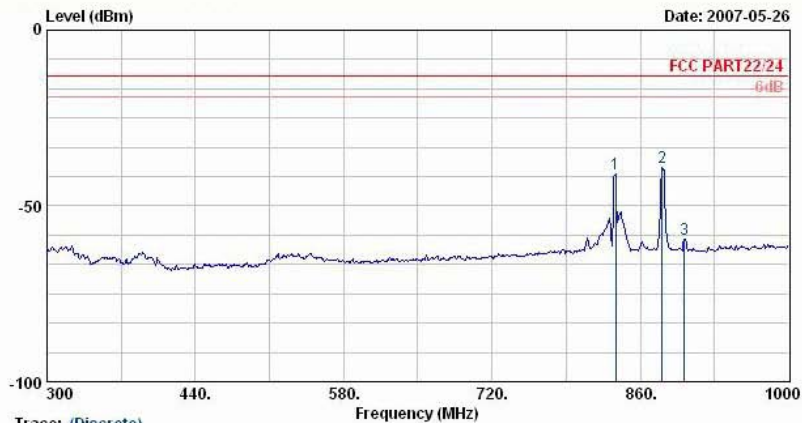

Site : D3CH06-HY
 Condition : LF-SPURIOUS VERTICAL
 EUT : PDA Phone
 Power : 120Vac/60Hz
 Model : FG742004-01
 Memo : GSM 850 Link;Ch189 + WLAN 11g Tx_Ch01
 + Adaptor + Earphone
 Plane : E2

Trace: (Discrete)

	Freq	Level	Over	Limit	Read	Factor	Remark
	MHz	dBm	dB	dBm	dBm	dB	
1 @	836.90	-41.08			-42.44	1.36	Peak
2 @	880.30	-39.04			-40.75	1.71	Peak
3	901.30	-59.35	-46.35	-13.00	-61.22	1.87	Peak

Remark:

- #1: MS Signal
- #2: BS Signal

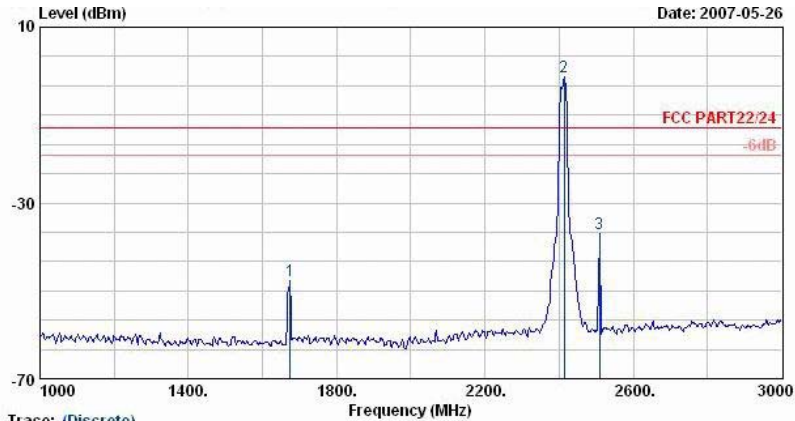

Trace: (Discrete)
 Site : D3CH06-HY
 Condition : HF-SPURIOUS VERTICAL
 EUT : PDA Phone
 Power : 120Vac/60Hz
 Model : FG742004-01
 Memo : GSM 850 Link;Ch189 + WLAN 11g Tx_Ch01
 Memo : + Adaptor + Earphone
 Plane : E2

	Freq	Level	Over	Limit	Read	Factor	Remark
	MHz	dBm	dB	dBm	dBm	dB	
1	1674.00	-47.59	-34.59	-13.00	-47.11	-0.48	Peak
2 @	2414.00	-1.33			-3.20	1.87	Peak
3 @	2508.00	-37.09	-24.09	-13.00	-39.36	2.27	Peak

Remark:
 1. #2: WLAN Signal

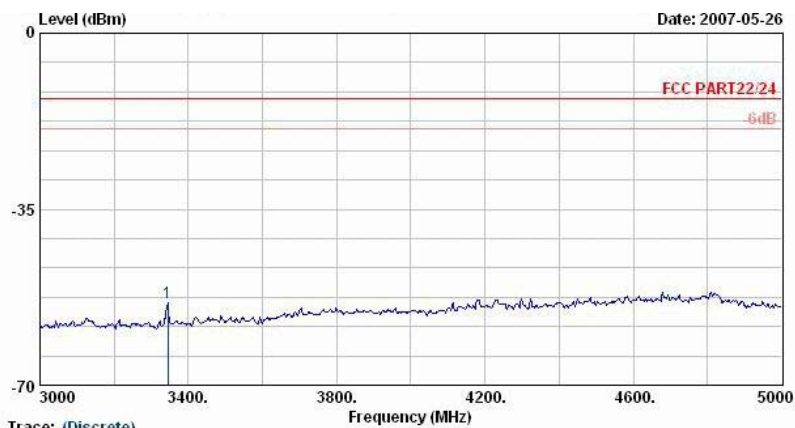

Trace: (Discrete)
 Site : D3CH06-HY
 Condition : HF-SPURIOUS VERTICAL
 EUT : PDA Phone
 Power : 120Vac/60Hz
 Model : FG742004-01
 Memo : GSM 850 Link;Ch189 + WLAN 11g Tx_Ch01
 Memo : + Adaptor + Earphone
 Plane : E2

	Freq	Level	Over	Limit	Read	Factor	Remark
	MHz	dBm	dB	dBm	dBm	dB	
1	3344.00	-53.60	-40.60	-13.00	-58.06	4.47	Peak

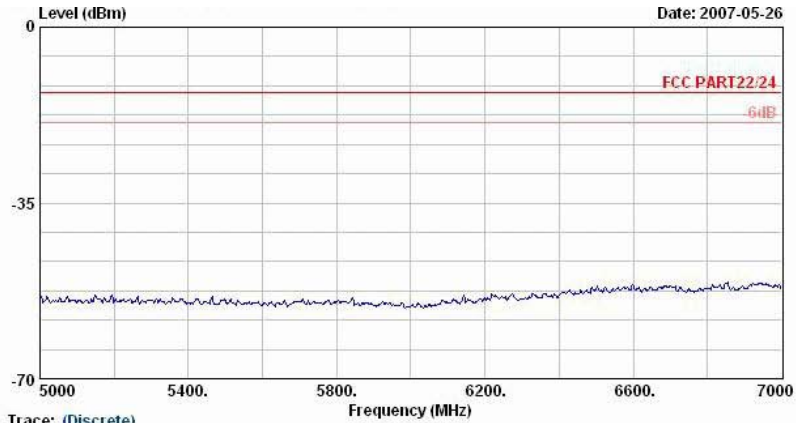

Trace: (Discrete)

Site : D3CH06-HY

Condition : HF-SPURIOUS VERTICAL

EUT : PDA Phone

Power : 120Vac/60Hz

Model : FG742004-01

Memo : GSM 850 Link;Ch189 + WLAN 11g Tx_Ch01

Memo : + Adaptor + Earphone

Plane : E2

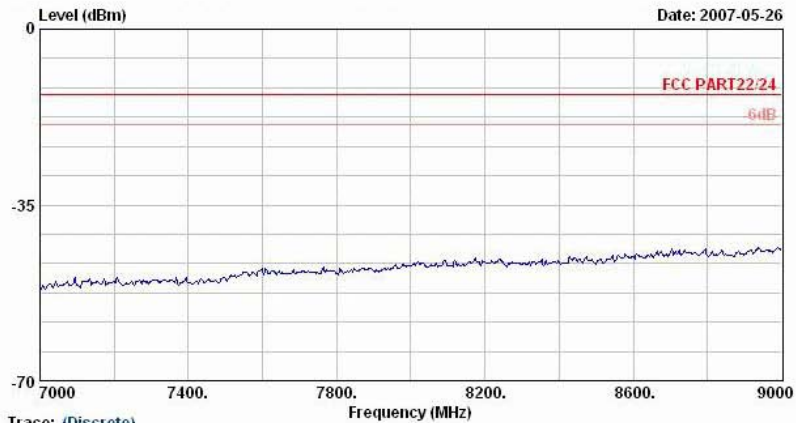

Trace: (Discrete)

Site : D3CH06-HY

Condition : HF-SPURIOUS VERTICAL

EUT : PDA Phone

Power : 120Vac/60Hz

Model : FG742004-01

Memo : GSM 850 Link;Ch189 + WLAN 11g Tx_Ch01

Memo : + Adaptor + Earphone

Plane : E2

Remark : There is no more obvious emission except the listings above.

4.7 Frequency Stability (Temperature Variation)

4.7.1 Measurement Instrument

As described in chapter 5 of this test report.

4.7.2 Test Procedure

1. The EUT and test equipment were set up as shown on the following section.
2. With all power removed, the temperature was decreased to -30°C and permitted to stabilize for three hours. Power was applied and the maximum change in frequency was noted within one minute.
3. With power OFF, the temperature was raised in 10°C steps. The sample was permitted to stabilize at each step for at least one-half hour. Power was applied and the maximum frequency change was noted within one minute.
4. The temperature tests were performed for the worst case.
5. Test data was recorded.

4.7.3 Test Setup Layout

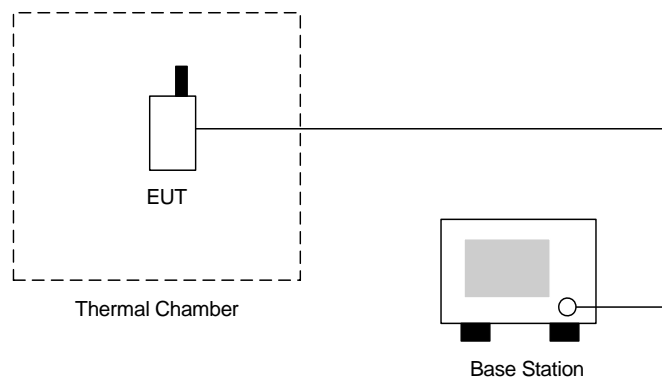



4.7.4 Test Result

- Test Mode : GSM850 (GSM) CH189

Temperature()	Change (Hz)	Change (ppm)	Limit (ppm)	Result
-30	NA	NA	2.5	Passed
-20	51	0.03		
-10	42	0.02		
0	37	0.02		
10	16	0.01		
20	-10	-0.01		
30	-14	-0.01		
40	16	0.01		
50	21	0.01		

Remark : The DUT can not be turned on at -30 .

- Test Mode : PCS1900 (GSM) CH661

Temperature()	Change (Hz)	Change (ppm)	Limit (ppm)	Result
-30	NA	NA	2.5	Passed
-20	47	0.02		
-10	35	0.02		
0	10	0.01		
10	-8	0.00		
20	12	0.01		
30	14	0.01		
40	16	0.01		
50	-8	0.00		

Remark : The DUT can not be turned on at -30 .

4.8 Frequency Stability (Voltage Variation)

4.8.1 Measurement Instrument

As described in chapter 5 of this test report.

4.8.2 Test Procedure

1. The EUT was placed in a temperature chamber at $25\pm 5^{\circ}\text{C}$ and connected as the following section.
2. The power supply voltage to the EUT was varied from BEP to 115% of the nominal value measured at the input to the EUT.
3. The variation in frequency was measured for the worst case.

4.8.3 Test Setup Layout

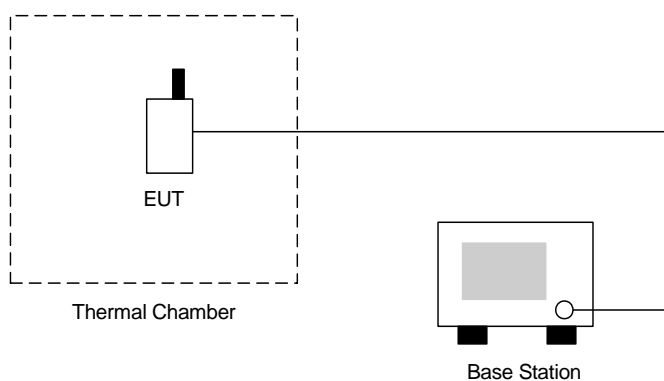

4.8.4 Test Result

- Test Mode : GSM850 (GSM) CH189

Voltage(Volt)	Change (Hz)	Change (ppm)	Limit (ppm)	Result
3.7	-18.0	-0.01	2.5	Passed
BEP	21.0	0.01		
4.2	9.0	0.00		

Remark:

1. Normal Voltage=3.7V.
2. Battery End Point (BEP)=3.2 V.

- Test Mode : PCS1900 (GSM) CH661

Voltage(Volt)	Change (Hz)	Change (ppm)	Limit (ppm)	Result
3.7	10.0	0.01	2.5	Passed
BEP	-15.0	-0.01		
4.2	16.0	0.01		

Remark:

1. Normal Voltage=3.7V.
2. Battery End Point (BEP)=3.2 V.



5 List of Measurement Equipments

Instrument	Manufacturer	Model No.	Serial No.	Characteristics	Calibration Date	Due Date	Remark
Spectrum analyzer	Agilent	E4408B	MY44211030	9KHz-26.5GHz	Oct. 05, 2006	Oct. 04, 2007	Radiation (03CH06-HY)
EMI Test Receiver	R&S	ESCS30	100356	9KHz-2.75GHz	Jul. 13, 2006	Jul. 12, 2007	Radiation (03CH06-HY)
Bilog Antenna	SCHAFFNER	CBL6112B	2885	30MHz -2GHz	Nov. 20, 2006	Nov. 19, 2007	Radiation (03CH06-HY)
Double Ridge Horn Antenna	Com-Power	AH118	10094	1G~18G	Dec. 26, 2006	Dec. 25, 2007	Radiation (03CH06-HY)
SHF-EHF Horn	SCHWARZBECK	BBHA 9170	9170-249	14G - 40G	Nov. 20, 2006	Nov. 19, 2008	Radiation (03CH06-HY)
Pre Amplifier	Agilent	8449B	3008A01917	1G - 26.5G	Nov. 15, 2006	Nov. 14, 2007	Radiation (03CH06-HY)
Pre Amplifier	Mini Circuits	ZKL-2	D092004-1	10~2500MHz	Nov. 15, 2006	Nov. 14, 2007	Radiation (03CH06-HY)
Base Station Simulator	R & S	CMU200	106656	WCDMA	Nov. 20, 2006	Nov. 19, 2007	Radiation (03CH06-HY)
Controller	INN-CO	CO2000	N/A	N/A	N/A	N/A	Radiation (03CH06-HY)
Turn Table	INN-CO	DS2000	420/650/00	0 ~ 360 degree	N/A	N/A	Radiation (03CH06-HY)
Antenna Mast	INN-CO	MM3000	114/8000604/L	1 m - 4 m	N/A	N/A	Radiation (03CH06-HY)
Thermal Chamber	Tenyi technology	TTH-D35P	TBN-930701	N/A	Jul. 24, 2006	Jul. 23, 2007	TH02-HY
Spectrum	R&S	FSP40	100055	9KHz~40GHz	Jun. 23, 2006	Jun. 22, 2007	TH02-HY
Bluetooth Test	ANRITSU	MT8852A	6K00003939	N/A	N/A	N/A	TH02-HY
POWER DIVIDER	ARRA	5200-1	3871	N/A	Oct. 07, 2006	Oct. 06, 2007	TH02-HY
DC POWER SUPPLY	TOPWARD	3303D	740889	N/A	May 25, 2005	May 24, 2009	TH02-HY
Power Meter	Agilent	E4416A	GB41292344	N/A	Feb. 08, 2007	Feb. 07, 2008	TH02-HY
Power Sensor	Agilent	E9327A	US40441548	N/A	Feb. 08, 2007	Feb. 07, 2008	TH02-HY



6 Uncertainty Evaluation

Uncertainty of Radiated Emission Measurement (30MHz ~ 1000MHz)

Contribution	Uncertainty of x_i		$u(x_i)$
	dB	Probability Distribution	
Receiver reading	0.41	Normal(k=2)	0.21
Antenna factor calibration	0.83	Normal(k=2)	0.42
Cable loss calibration	0.25	Normal(k=2)	0.13
Pre Amplifier Gain calibration	0.27	Normal(k=2)	0.14
RCV/SPA specification	2.50	Rectangular	0.72
Antenna Factor Interpolation for Frequency	1.00	Rectangular	0.29
Site imperfection	1.43	Rectangular	0.83
Mismatch	+0.39/-0.41	U-shaped	0.28
combined standard uncertainty Uc(y)	1.27		
Measuring uncertainty for a level of confidence of 95% U=2Uc(y)	2.54		

Uncertainty of Radiated Emission Measurement (1GHz ~ 40GHz)

Contribution	Uncertainty of x_i		$u(x_i)$	C_i	$C_i * u(x_i)$
	dB	Probability Distribution			
Receiver reading	±0.10	Normal(k=1)	0.10	1	0.10
Antenna factor calibration	±1.70	Normal(k=2)	0.85	1	0.85
Cable loss calibration	±0.50	Normal(k=2)	0.25	1	0.25
Receiver Correction	±2.00	Rectangular	1.15	1	1.15
Antenna Factor Directional	±1.50	Rectangular	0.87	1	0.87
Site imperfection	±2.80	Triangular	1.14	1	1.14
Mismatch Receiver VSWR $\Gamma_1 = 0.197$ Antenna VSWR $\Gamma_2 = 0.194$ Uncertainty = $20 \log(1 - \Gamma_1 * \Gamma_2 * \Gamma_3)$	+0.34/-0.35	U-shaped	0.244	1	0.244
Combined standard uncertainty Uc(y)	2.36				
Measuring uncertainty for a level of confidence of 95% U=2Ue(y)	4.72				

END OF TEST REPORT