

The Address Book can store up to 200 addresses. When you select Address Book you are given five options: **Previous Destinations** lets you select from a list of the last 50 destinations you routed to; **List Addresses** displays a list of all of the addresses you have stored in your Address Book; **Favorites** gives you a shortened list of entries from your Address Book marked as Favorites; **Create New Entry** lets you add a new address to your Address Book; and **Trip Planner** (indicated by the Trip button) lets you create a multi-destination trip from entries.

7.5.1 Previous Destinations

From the Destination screen, select **Address Book** then, select **Previous Destinations**.

Use the Navigation key to scroll the list up or down (if necessary) and select the desired previous destination.

Chapter 7: Selecting Destinations

Select **Route**.

Select the desired Route Method.

The Magellan CrossoverGPS 3150 will calculate

the route. When the calculations are

complete, the Map screen will be displayed.

7.5.1.1 Saving a Previous Destination to the Address Book From the Destination screen, select **Address Book**, then select **Previous Destinations**.



Use the Navigation key to scroll the list up or down (if necessary) and select the desired previous destination.

Select **Edit**.

The top line (Name) and the bottom line (Information) can be edited. The address cannot be changed. Select the line you want to modify. Use the keypad to enter the desired text and select **OK**.

When you have finished making changes, select **Save**, then press **ESCAPE**.

Chapter 7: Selecting Destinations

7.5.1.2 Deleting A Previous Destination From the Destination screen, select **Address Book** then, select **Previous Destinations**.

Use the Navigation key to scroll the list up or down (if necessary) and select the desired previous destination.

Select **Delete**.

A dialog box will appear to confirm your selection.

Select **Yes**.

The Previous Destination is

deleted from the list.

7.5.2 Favorites

You can add address book entries to your Favorites list by selecting the Favorites box at the bottom of the Edit Address Book screen. Only address book entries can be saved as Favorites, Previous Destinations must be saved to the Address Book first, and can then be designated as a favorite. The Favorites list is a shorter list of those address book entries that you travel to often.

From the Destination screen, select **Address Book**, then select **Favorites**.

Use the Navigation key to scroll the list up or down (if necessary) and select the destination from the list of addresses.

Select **Route**. Select the desired Route Method. The Magellan CrossoverGPS 3150 will calculate the route. When the calculations

complete, the Map screen will

Chapter 7: Selecting

7.5.2.1 Editing a Favorite

screen, select **Address**
Book

Use the Navigation key to scroll the list up or down (if necessary) and select the desired favorite.

Select **Edit**.

The top line (Name) and the bottom line (Information) can be edited. The address cannot be changed. Select the line you want to modify. Use the keypad to enter the desired text and select **OK**.

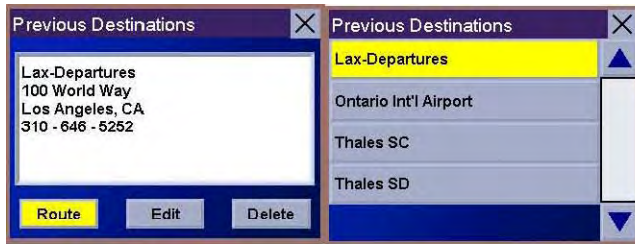

are



be displayed.

Destinations

From the Destination screen, select **Favorites** then, select **Favorites**.

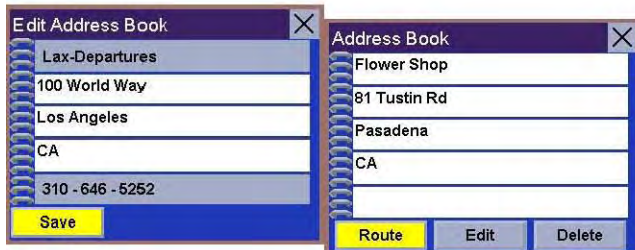

When you have finished making changes, select **Save** and then, press **ESCAPE**.

7.5.2.2 Deleting A Favorite

From the Destination screen, select **Address Book** then, select **Favorites**.

Use the Navigation key to scroll the list up or down (if necessary) and select the desired favorite.

Select **Delete**.

A dialog box will appear to confirm your selection.

Select **Yes**.

The entry is deleted from the list.

Chapter 7: Selecting Destinations

7.5.3 List Addresses

List Addresses shows all entries stored in your address

book. It does not include previous destinations but does include those entries designated as Favorites.

From the Destination screen, select **Address Book**

then, select **List Addresses**.

Use the Navigation key to scroll the list up or down (if

necessary) and select the destination from the list of addresses.

Select **Route**.

Select the desired Route Method.

The Magellan CrossoverGPS 3150 will calculate the route. When the calculations are

complete, the Map screen will be displayed.

7.5.3.1 Editing an Address From the Destination screen, select **Address Book** then, select **List Addresses**.

Use the Navigation key to scroll the list up or down (if necessary) and select the desired address.

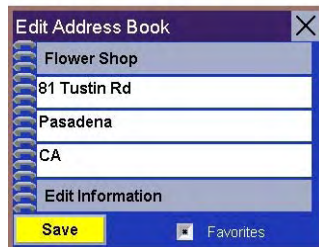
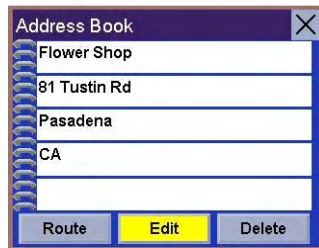

Select **Edit**.

The top line (Name) and the bottom line (Information) can be edited. The address cannot be changed. Select the line you want to modify. Use the keypad to enter the desired text and select **OK**. You can also designate the address as a favorite by checking the box at the bottom of the screen.

When you have finished making changes, select **Save** and then, press **ESCAPE**.

Chapter 7: Selecting Destinations

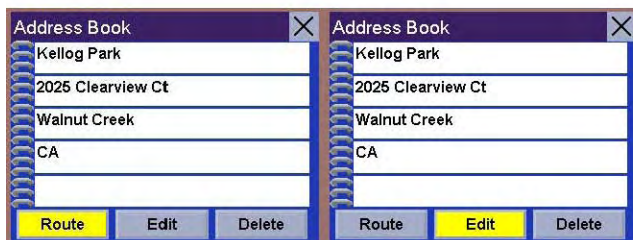
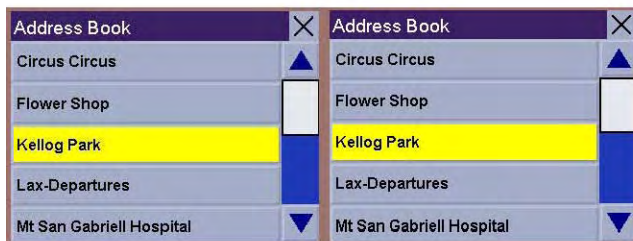
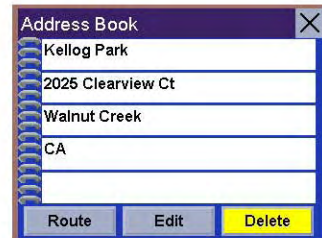
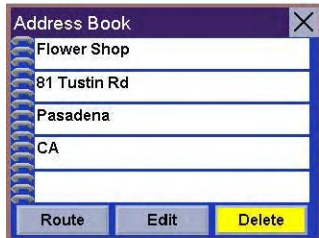
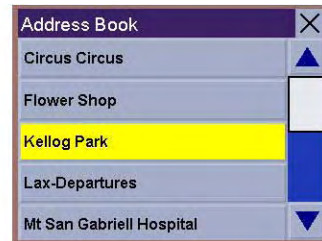
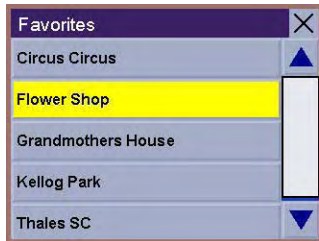

7.5.3.2 Deleting an Address From the Destination screen, select **Address Book** then, select **List Addresses**.

Use the Navigation key to scroll the list up or down (if necessary) and select the desired address.

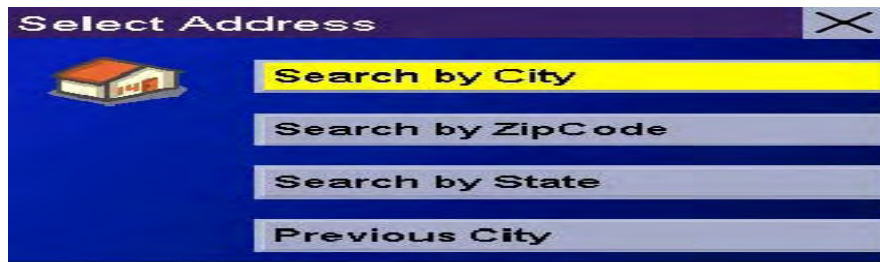

Select **Delete**.

A dialog box will appear to confirm your selection. Select **Yes**.

The address is deleted from the list and you are returned to the Address Book screen.

7.5.4 Create New Entry

Use Create New Entry to add entries to your address book. These entries can then be designated as Favorites to include in the Favorites list.

7.5.4.1 Search by City

From the Destination screen, select **Address Book** then, select **Create New Entry**. Select **Search by City**.

Text Characters” on page 13). Select **OK**.

Use the Navigation key to scroll the list up or down (if necessary) and select the desired city.

Chapter 7: Selecting Destinations

Enter the street name (see “Help with Address Entry” on page 15). Select **OK**.

Use the Navigation key to scroll the list up or down (if necessary) and select the desired street.

Enter the street address. The acceptable range of numbers is displayed at the top of the screen. Select **Done**.

The top line (Name) and the bottom line (Information) can be edited. The address cannot be changed. Select the line you want to modify. Use the keypad to enter the desired text and select **OK**. You can also designate the address as a favorite by checking the box at the bottom of the screen.

When you have finished making changes, select **Save** and then, press **ESCAPE**.

7.5.4.2 Search by Zip Code

numbers is displayed at the top of the screen. Select **Done**.

The top line (Name) and the bottom line (Information) can be edited. The address cannot be changed. Select the line you want to modify. Use the keypad to enter the desired text and select **OK**. You can also designate the address as a favorite by checking the box at the bottom of the screen.

When you have finished making changes, select **Save** and then, press **ESCAPE**.

7.5.4.3 Search by State

From the Destination screen, select **Address Book** then, select **Create New Entry**. Select **Search by State**.

7.5.4.2 Search by Zip Code

From the Destination screen, select **Address Book** then, select **Create New Entry**. Select **Search by Zip Code**.

Enter the zip code and select **OK**, then select the city.

Chapter 7: Selecting Destinations

Enter the street name (see “Help with Address Entry” on page 15). Select **OK**.

Use the Navigation key to scroll the list up or down (if necessary) and select the desired street.

Enter the street address. The

Use the keypad to enter the first few characters for the state and select **OK**. Select the state.

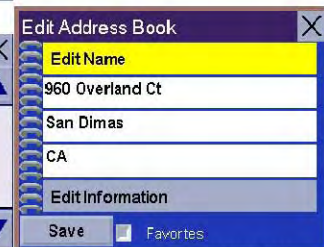
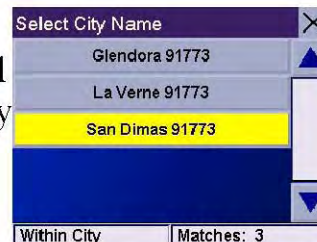
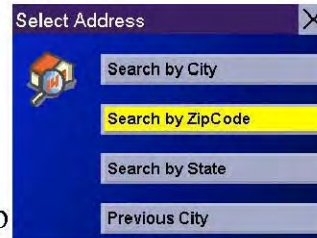
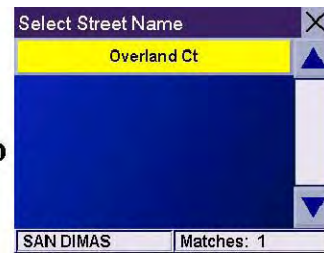

Chapter 7: Selecting Destinations

Enter the street name (see “Help with Address Entry” on page 15). Select **OK**.

Use the Navigation key to scroll the list up or down (if necessary) and select the desired street.

Use the Navigation key to scroll the list up or down and select the desired city. (These are all of the cities in your loaded database that have the street name you selected.)

Enter the street address. The acceptable range of numbers is displayed at the top of the screen. Select **Done**.

The top line (Name) and the bottom line (Information) can be edited. The address cannot be changed. Select the line you want to modify. Use the keypad to enter the desired text and select **OK**. You can also designate the address as a favorite by checking the box at the bottom of the screen.

necessary) and select the desired street.

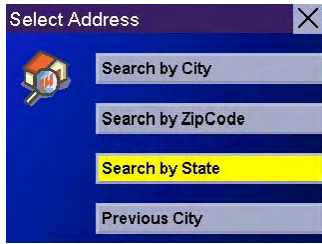

When you have finished making changes, select **Save** and then, press **ESCAPE**.

7.5.4.4 Previous City

From the Destination screen, select **Address Book**, then select **Create New Entry**. Select **Previous City**.



Chapter 7: Selecting Destinations

Use the Navigation key to scroll the list up or down (if necessary) and select the desired city.

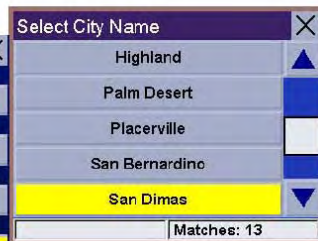
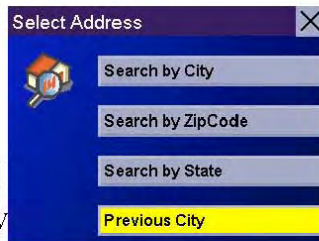

Enter the street name (see “Help with Address Entry” on page 15). Select **OK**.

Use the Navigation key to scroll the list up or down (if necessary) and select the desired street.



Enter the street address. The acceptable range of numbers is displayed at the top of the screen. Select **Done**.

The top line (Name) and the bottom line (Information) can be edited. The address cannot be changed. Select the line you want to modify. Use the

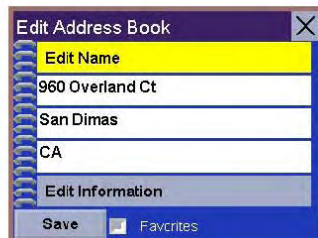

keypad to enter the desired text and select **OK**. You can also designate the address as a favorite by checking the box at the bottom of the screen.

When you have finished making changes, select **Save** and then, press **ESCAPE**.

7.5.5 Trip Planner

Using the Trip Planner, you can enter multiple

destinations for your “trip” and route to each one of them in order. Additionally, using the Trip Planner you can optimize your trip and route to arrive at your destinations in the most efficient

manner.

7.5.5.1 NeW

From the Destination screen, select **Address Book,**

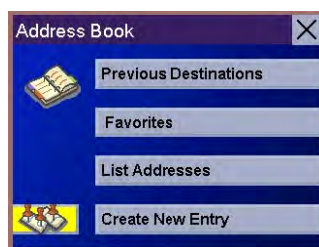

then select **Trip** (Trip button).

Chapter 7:

Selecting

Destinations

Select

New.

Use the

keypad to enter a name for the new trip and select **OK**

From the

pop-up menu, select **Add**.

From the Select Trip Planner Address screen, select the method for adding a destination to your trip: **Map** (Map button) will add a destination by selecting a point on the map; **Select Address** will add a destination by creating a new address; **Address Book** will add a destination from a previous destination, Address Book, or favorites; **Dining, ATM, Gas...** will add a destination from the POI database; and **Intersection** will add a destination of two intersecting streets.

Continue adding destinations. When you are finished, select **Save**.

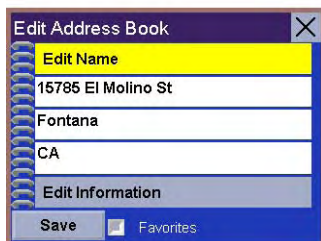
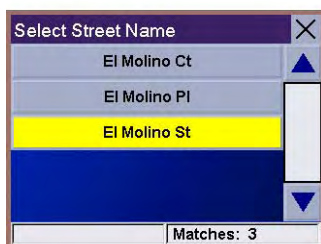
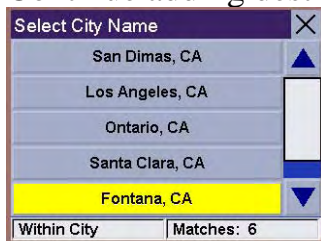

Chapter 7: Selecting Destinations

7.5.5.2

Optimizing a Trip

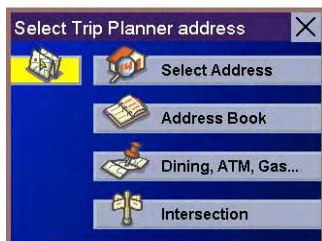

With Route Optimization, you can sort the destinations in your trip from closest to farthest.

From the Trip Planner screen, select **Edit**.

Select the

t

rip to optimize.

Select **Optimize**.

The destinations are sorted from closest to farthest from you current location.

Select **Save**.

Chapter 7: Selecting Destinations

7.5.5.3 Guide

Me

From the Destination screen, select **Address Book**. then select the **Trip**

(Trip button). Select **GuideMe**. Select the Trip. Select the first destination in

the list you wish to route to. Select the desired Route Method. Note:

Selecting the second destination in the list will exclude the first destination, selecting the third destination in the list will exclude the first and second destinations, and so on.

The Magellan Maestro 4000/4040/4050 will calculate the route. When the calculations are complete, the Map screen will be displayed.

7.5.5.4 Edit

Destinations within a trip can be moved up or down, deleted, or added to. From the Trip Planner screen, select **Edit**.



Chapter 7: Selecting Destinations

Select the trip to edit.



Select the destination you wish to delete, and select **Delete** from the pop-up menu.



Select the destination you wish to change, and select



Move Up from the pop-up menu.

When you have finished, select **Save** and you are returned to the **Trip Planner** screen.

7.5.5.5 Delete and Rename

From the Trip Planner screen, select **Delete, Rename**.

Chapter 7: Selecting Destinations

Select **Delete**.

Select the trip you wish to delete.

A dialog box will appear to confirm your selection. Select **Yes**.

The trip has been deleted.

Select **Rename**.

Select the trip to be renamed.

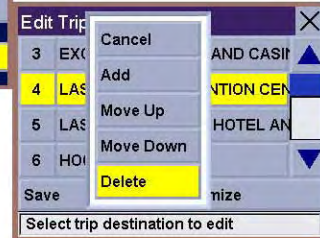
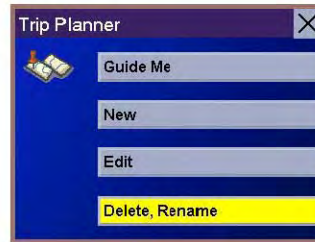

7.5.5.5 Delete and Rename

Select **Yes**.

The trip has been deleted.

Select **Rename**.

Select the trip to be renamed.

The trip has been renamed.

7.6 Selecting a Point of Interest as a Destination



Chapter 7: Selecting Destinations

Use the backspace key to delete the old name; then, enter the new name for the trip. When you have finished, select **OK**.

The trip has been renamed.

7.6 Selecting a Point of Interest as a Destination

Spell Name – page 46

Select Category – page 47

Custom POIs – page 49

Dining, ATM, Gas...

Points of Interest (or POIs) are commercial or recreational locations, landmarks, or services that are preloaded into the Magellan CrossoverGPS 3150 database. There are over six million POI's in the database, which range from restaurants, parks, gas stations, and banks, to schools and police stations, and more. The purpose of the POI database (accessed through the Dining, ATM, Gas... menu option) is to provide you with a list of popular destinations without having to enter the address manually in order to route to them.

Chapter 7: Selecting Destinations

7.6.1 Spell Name

If you know the name of the POI you are looking for, find it using the **Spell Name** feature.

From the Destination screen, select **Dining, ATM, Gas..**, then select **Spell Name**.

Enter the name of the POI.

7.6.1.1 Nearest

Selecting Nearest will list the POIs matching the name you entered from closest to farthest from your current position. Select **Nearest**.

Use the Navigation key to scroll the list up or down (if necessary) and select the desired POI.

Select the desired Route Method.

The Magellan CrossoverGPS 3150 will calculate the route. When the calculations are complete, the Map screen will be displayed.

7.6.1.2 List By City

Selecting List by City will list the POIs matching the name you entered within a selected city sorted by distance from the city center. Select **List by City**.

Enter the city name (see “Help with Address Entry” on page 15). Select **OK**.

Use the Navigation key to scroll the list up or down (if necessary) and select the desired city.

Chapter 7: Selecting Destinations

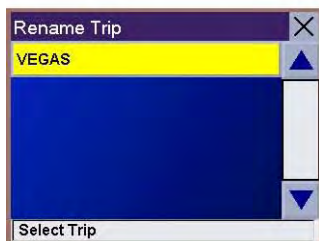
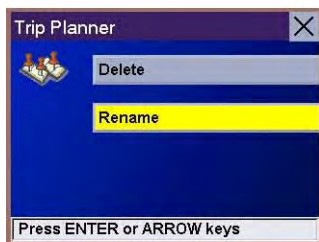
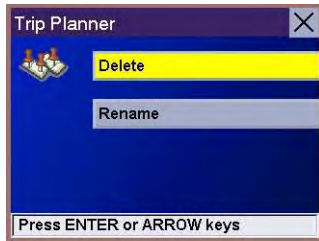

Use the Navigation key to scroll the list up or down (if necessary) and select the desired POI.

Select the desired Route Method.

The Magellan CrossoverGPS 3150 will calculate the route. When the calculations are complete, the Map screen will be displayed.

7.6.1.3 Select Category

Selecting Select Category enables you to narrow the list of POIs by selecting the category of the name you spelled. Select **Select Category**.

Use the Navigation key to scroll the list up or down and select the desired POI category.

Use the Navigation key to scroll the list up or down (if necessary) and select the desired POI.

Select the desired Route Method.

The Magellan CrossoverGPS 3150 will calculate the route. When the calculations are complete, the Map screen will be displayed.

7.6.2 Select Category

If you do not know the name of the POI you are looking for, but know the category (restaurant, bank, gas station, etc.), you can find it using Select Category.

From the Destination screen, select **Dining, ATM, Gas...**, then select **Select Category**.

Select the POI category.

Chapter 7: Selecting Destinations

7.6.2.1 Nearest

Selecting Nearest will list the POIs in the category selected from closest to farthest from your current position. Select **Nearest**.

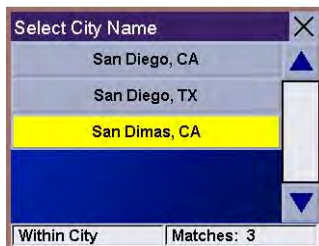

A list of all the POI's in the selected category nearest to your current position is displayed. Select the POI from the list.

Select the desired Route Method.

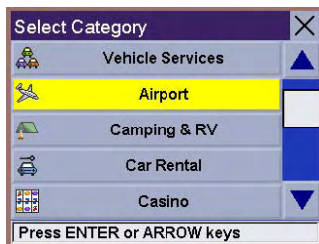

The Magellan CrossoverGPS 3150 will calculate the route. When the calculations are complete, the Map screen will be displayed.

7.6.2.2 List by City

Selecting List by City will list the POIs in the category selected within a specified city. Select **List by City**.

Enter the name of the city you wish to search from. When you are finished, select **OK**.

Use the Navigation key to scroll the list up or down (if necessary) and select the desired city.

Use the Navigation key to scroll the list up or down (if necessary) and select the desired POI.

Select the desired Route Method.

The Magellan CrossoverGPS 3150 will calculate the route. When the calculations are complete, the Map screen will be displayed.

7.6.2.3 Spell Name

Selecting Spell Name will list the POIs in the category selected, matching the name you entered. Select **Spell Name**.



Chapter 7: Selecting Destinations

Enter the name of the POI. When you are finished, select **OK**.

Select Nearest to list the POIs matching the characters entered that are nearest to your current position.

Select List by City to list the POIs matching the characters entered that are nearest to a particular city. Enter the name of the city. When you are finished, select OK. Select the city from the list.

Use the Navigation key to scroll the list up or down (if necessary) and select the desired POI.

Select the desired Route Method.

The Magellan CrossoverGPS 3150 will calculate the route. When the calculations are complete, the Map screen will be displayed.

7.6.2.4 Cuisine Type

When selecting restaurants, you are presented with an additional method for finding POIs. Select Cuisine Type. Use the Navigation key to select the type of restaurant you prefer.

Use the Navigation key to scroll the list up or down (if necessary) and select the desired POI.

Select the desired Route Method.

The Magellan CrossoverGPS 3150 will calculate the route. When the calculations are complete, the Map screen will be displayed.

7.6.3 Custom POIs

Please refer to page 112 for information on creating and loading Custom POIs. From the Destination screen, select **Dining, ATM, Gas...**, then select **Custom POIs**.

Chapter 7: Selecting Destinations

Select the category.

If the POI list has more than 15 returns, you can further narrow the search by selecting either Nearest or Spell Name. Select the desired POI from the list.

Select **Route** to go to the selected Address, or select **Cancel** to return to the Select Custom POI menu.

Select the desired Route Method.

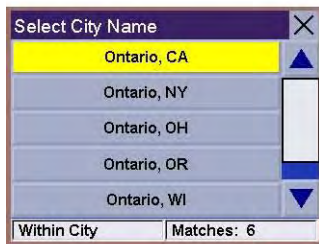

The Magellan CrossoverGPS 3150 will calculate the route. When the calculations are complete, the Mapscreen will be displayed.

Chapter 7: Selecting Destinations

7.7 Selecting an Intersection as a Destination



Search by City – page 51

Search by Zip Code – page 52

Search by State – page 52

Previous City – page 53

An intersection of two streets can be used as a destination. The search for the intersection can be done whether or not you know the city. If you know the city, you can start there; if you are unsure of the city, you can start with the state.

7.7.1 Search by City From the Destination screen, select **Intersection** then, select **Search by City**.

Enter the first few characters of the city name (see “Inputting Text Characters” on page 13). Select **OK**.

Spell POI Name

← LOS_

A	B	C	D	E	F	G	H
I	J	K	L	M	N	O	P
Q	R	S	T	U	V	W	X
123	OK	More	Y	Z			

Airport

34 mi Airport
 1 World Way
 Los Angeles, CA
 310 - 646 - 5252

Los Angeles Int'l Airport

Los Angeles Int'l-Departures

AIRPORT Matches: 5

Cuisine Type

Bistro

Bohemian

Brewpub

British Isles

Cajun/Caribbean

Press ENTER or ARROW keys

Restaurant

4.2 mi Restaurant
 2917 W Eastland Center Dr
 West Coxsackie, NY
 626 - 858 - 0054

Brewpub

Bj's Restaurant&Brewery

RESTAURANT Matches: 1

Select category

Thales Offices

Press ENTER or ARROW keys

Select Custom POI

Thales (San Dimas)

Thales (Santa Clara)

Press ENTER or ARROW keys

Route To This Address

Thales (San Dimas)
 Thales Offices

Route Cancel

Use the Navigation key to scroll the list up or down (if necessary) and select the desired city.

Enter the first street name (see “Help with Address Entry” on page 15).
Select **OK**.

Use the Navigation key to scroll the list up or down and select the first street from the list.

Chapter 7: Selecting Destinations

Enter the second street name and select **OK**.

Use the Navigation key to scroll the list up or down (if necessary) and select the second street from the list. Select the desired Route Method. The Magellan CrossoverGPS 3150 will calculate the route. When the calculations are

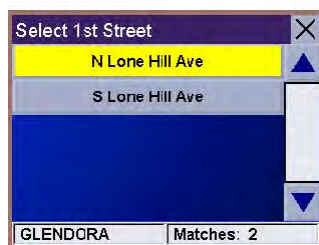
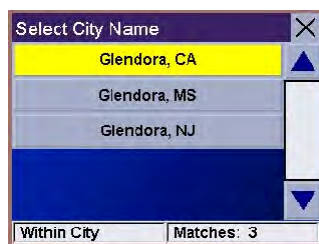

complete, the Map screen will be displayed.

7.7.2 Search by Zip Code

From the Destination screen, select **Intersection** then, select **Search by zip**

Code. Enter the zip code and select **OK**, then select the city.

Enter the first street name (see “Help with Address Entry” on page 15).

Select **OK**.

Use the Navigation key to scroll the list up or down and select the first

street
from the list.

Enter the second street and select **OK**.

Use the Navigation key to scroll the list up or down (if necessary) and select

the second
street from the list.

Select the desired Route Method.

The Magellan CrossoverGPS 3150 will calculate the route. When the calculations are

complete, the Map screen will be displayed.

7.7.3 Search by State From the Destination screen, select **Intersection** then, select **Search by State**.

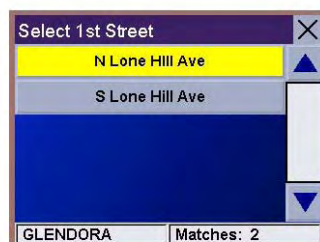
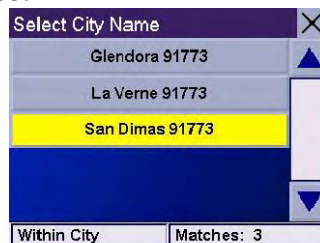

Chapter 7: Selecting Destinations Enter the first

few characters for the state and select **OK**. Use the Navigation key to scroll the list up or down (if necessary) and select the state from the list.

Enter the first street name (see “Help with Address Entry” on page 15).

Select **OK**.

Use the Navigation key to scroll the list up or down (if necessary) and select

the first street from the list.

Enter the second street and select **OK**.

Use the Navigation key to scroll the list up or down (if necessary) and select

the second street from the list. Select the desired Route Method. The Magellan CrossoverGPS 3150 will calculate the route. When the calculation

is

complete, the Map screen will be displayed.

7.7.4 Previous City

From the Destination screen, select **Intersection** then, select **Previous City**. Use the Navigation key to scroll the list up or down (if necessary) and select the desired city.

Enter the first street name (see “Help with Address Entry” on page 15). Select **OK**.

Use the Navigation key to scroll the list up or down (if necessary) and select the first street from the list.

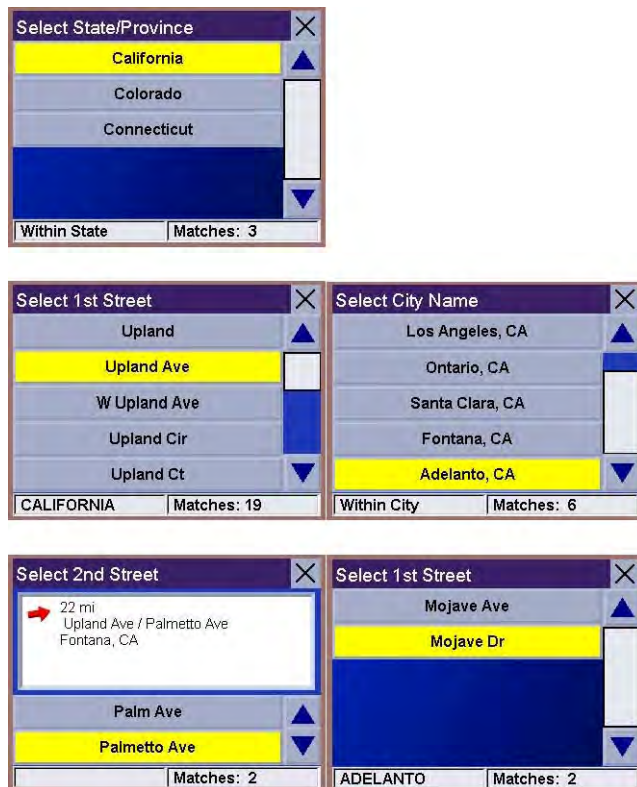

Chapter 7: Selecting Destinations

Enter the second street and select **OK**.

Use the Navigation key to scroll the list up or down (if necessary) and select the second street from the list. Select the desired Route Method. The Magellan CrossoverGPS 3150 will calculate the route. When the calculations are

complete, the Map screen will be displayed.

Chapter 8: Navigation Options

Navigation Options are only available when you are in Navigation Mode. When going to the Main Menu from the Music Player or from the Photo Viewer, this option will be grayed out. To access these features, press the **MENU** key on the Magellan CrossoverGPS 3150 and select **Navigation Options**.

8.1 Configuration

Configuration enables you to customize the advanced navigation features of the Magellan CrossoverGPS 3150. Select **Configuration**.

8.1.1 POI Selection

From the POI Selection menu, you can choose which icons to display on the Map screen. We recommend being selective about which icons you choose to display in order to prevent your map screen from being cluttered. For a list of POI Categories, see “POI Categories” on page

117.

Select POI Selection.



Select **Mark All** to display all POI icons on the Map screen.

Select **Clear All** if you wish not to have any POI icons displayed on the Map screen.

You can also select individual icons to display or hide on the Map screen.

When you have

finished, select **Save** to save your selection and return to the

Configuration

menu.

8.1.2 Custom POIs

The Custom POI menu enables you to select POIs previously loaded into your Magellan CrossoverGPS 3150 using the Magellan Maestro POI

Manager software (see page 112). The following instructions are assuming that you have loaded one or more custom POIs into your Magellan CrossoverGPS 3150.

Select **Custom POIs**.

Chapter 8: Navigation Options

Select **Select a POI File**.



Use the Navigation key to scroll the list up or down (if necessary) and select a POI file. With the file selected, you are returned to the Custom POIs menu.

Select **Display Categories**.

The categories you created are displayed in the same way as the built-in POIs.

Select **Mark All** to display all POI icons on the Map screen. Select **Clear All** if you wish not to have any POI icons displayed on the Map screen. You can also select individual icons to display or hide on the Map screen.

When you have finished, select **Save** to return to the Configuration menu

You can also be alerted when you approach a custom POI. The Set Alarm function works for Custom POIs only and only if the POI has been selected to show on the Map screen. Select **Set Alarms**.

Again, you can select all, none, or individual POIs to have an alert set. Select **Mark All** to set an alert for all custom POI icons on the Map screen. Select **Clear All** if you wish not to have any alerts set for custom POI icons displayed on the Map screen. You can also select individual categories to have an alert set.

When you have finished, select **Save** to return to the Custom POIs menu.

With the POI alerts set, you can now choose at what point you will be alerted. Select **Alert Parameters**.

Chapter 8: Navigation Options

Select the POI category to customize.

The Detection Angle is set to alert you when you are within so many degrees of the POI.

Select **Detection Angle**.

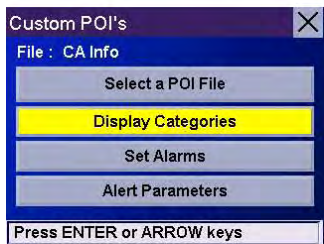
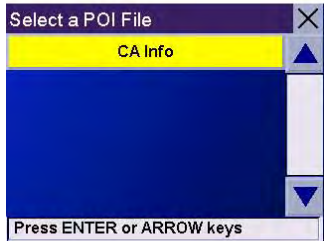

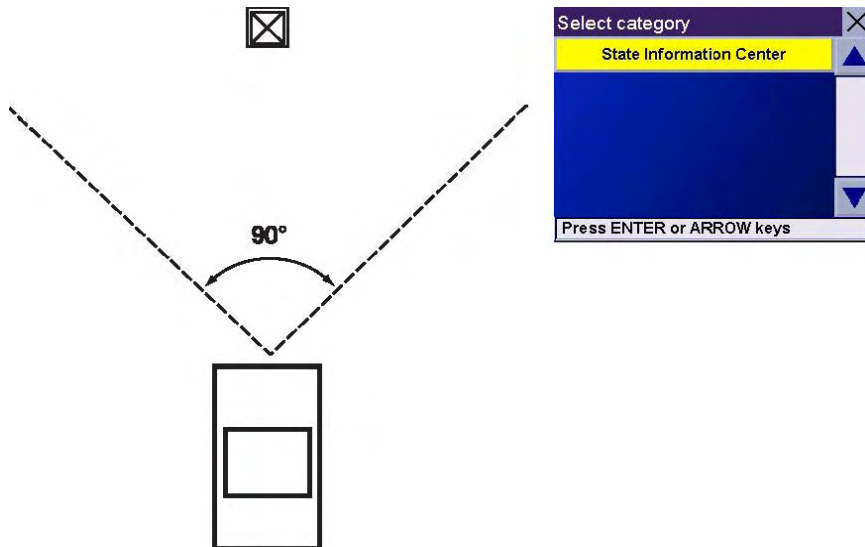

Use the numeric keypad to enter the number of degrees in which to set the alert. When you have finished, select **OK**.

Chapter 8: Navigation Options

The First Warning is set to alert you when you are within a certain number of feet from the POI. Select **First Warning**.

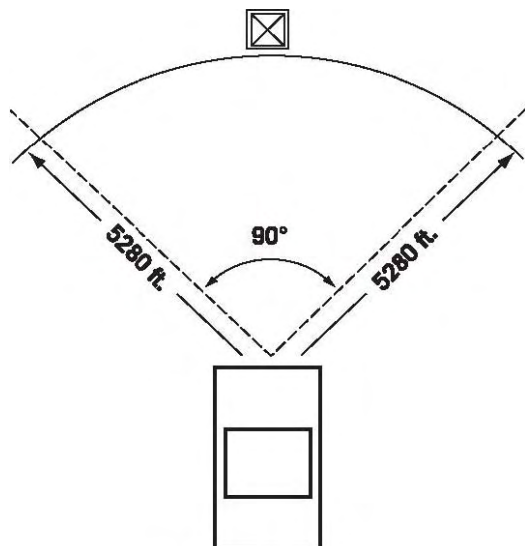

Use the numeric keypad to enter the number of feet in which to alert you. When you have finished, select **OK**.

Chapter 8: Navigation Options

The Last Warning is set as a final alert when you are within a certain number of feet from the POI.

Select **Last Warning**.

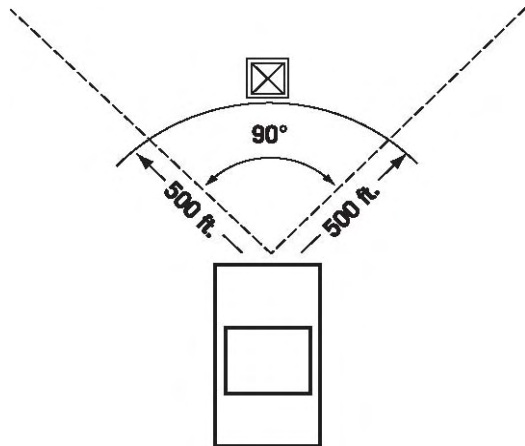

Use the numeric keypad to enter the number of feet in which to alert you.
When you have finished, select **OK**.

When you have set the parameters as you like, select **Save**.

Chapter 8: Navigation Options

8.1.3 Map Options

Map Options enable you to determine the behavior of the Map while you are driving.

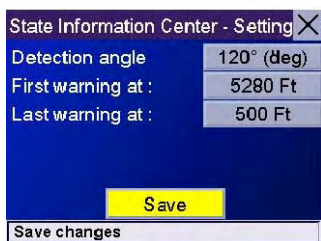
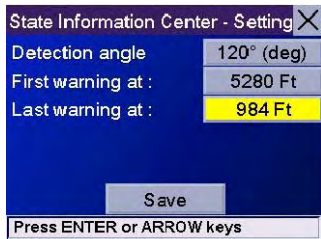

Select Map Options.

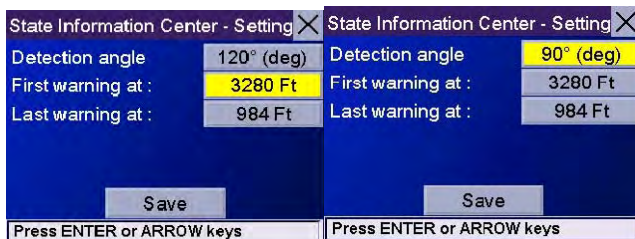

With **Scrolling** enabled, the vehicle position icon will always remain in the same position with the map scrolling, or moving as while the vehicle is in motion. With **Scrolling** disabled, the vehicle position icon will move forward slightly; then, the map will scroll down. Having **Scrolling** disabled allows for a faster display.

Heading Up sets the map display so that the direction of travel is always at the top of the screen. **North Up** sets the map display so that North is always at the top of the screen. North Up is only available in 2D Map mode.

Select **Miles** or **Kilometers** as the unit of measure for distance.

When you have finished, select **Save**.

8.1.4 TrueView Options

TrueView options enable you to control how and when the TrueView screen

is displayed. Select

TrueView Options.

Select Split TrueView to enable the TrueView/Map Screen mode. See “TrueView Screen” on page 19.

Select Disable TrueView if you do not want the TrueView screen to appear

during routing.

Select Manual TrueView to show the TrueView screen only by pressing the

View key.

Select Auto TrueView to have the TrueView screen appear automatically when the next maneuver is approaching.

When you have finished, select **Save**.

8.1.5 Select Map Color Select **Select Map Color**. With **Automatic Night Mode** enabled, the Magellan CrossoverGPS 3150 will switch between a Day screen and a Night screen based on sunrise and sunset times for your current location. Select **Day Screen** to choose a color scheme for the map while you are driving during the day.

Select **Night Screen** to select a color scheme for driving at night. When you have finished, select **Save**.

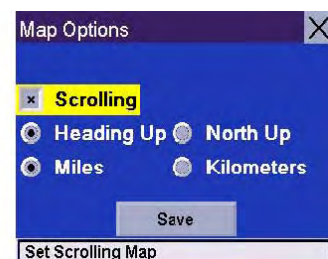
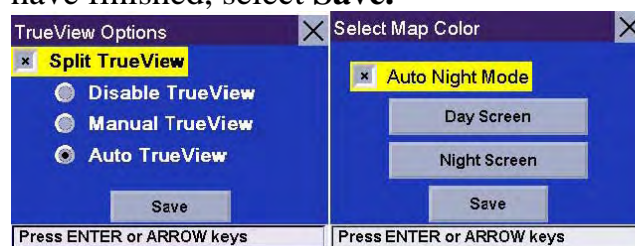

Chapter 8: Navigation Options

Select from nine available color schemes:

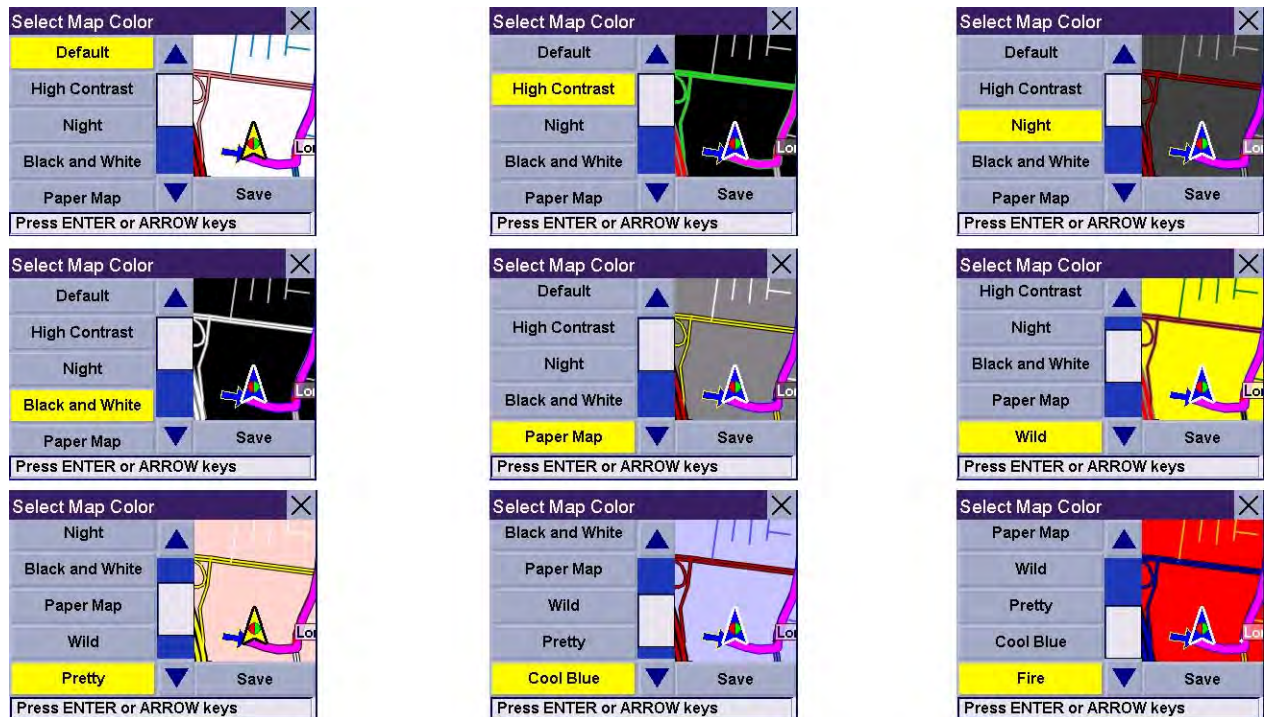

When you have finished, select **Save** and you will be returned to the Select Map Color menu.

8.1.6 Route Preferences

Route Preferences enable you to set parameters for the Magellan CrossoverGPS 3150 to follow when calculating a route. Select **Route Preferences**.

Automatic Re-Route will cause the Magellan CrossoverGPS 3150 to try up to three times to automatically re-route to the destination when it has detected that the vehicle has derterrd from the calculated route.

When you have finished, select **Save**.

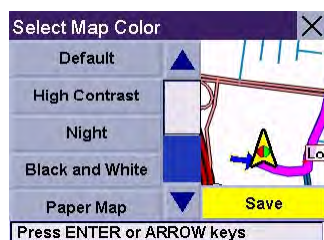

Chapter 8: Navigation Options

8.1.7 Detour Options

The Magellan CrossoverGPS 3150 comes equipped with SmartDetour. If you are driving on the freeway with SmartDetour enabled and your speed drops below 15 MPH, you may press the detour icon on the Map screen in order for the Magellan CrossoverGPS 3150 to calculate an alternate route around traffic.

Select **Detour Options**.

Select the distance of the detour. You can select from a preset distance of three miles, five miles, or 10 miles.

You can also select a custom distance. Select **Custom**, and then select the button to the right to enter a custom distance.

Enter the number of miles and select **OK**.

Next, select the amount of time the Magellan CrossoverGPS 3150 will wait before alerting you. Select the **Time** button.

Enter the number of minutes and select **OK**.

Enable Automatic Detour is selected by default as shown by the checkbox mark. To disable automatic detour, deselect **Enable Automatic Detour**.

When you have finished, select **Save**.

Chapter 8: Navigation Options

When you encounter traffic, and the set time has elapsed, the Detour icon will flash on the Map

screen. Touch the icon on the screen to have the Magellan CrossoverGPS 3150 calculate the detour. You can choose to ignore the Detour alert; and after one minute it will stop flashing until the set time has elapsed again when it will alert you once more.

8.1.8 Menu Colors



You can change the color of the menu screens by selecting one of four color schemes.

Select **Menu Colors**.

Select the desired color scheme.

When you have finished, select **Save**.



8.1.9 Tone Options

As you approach a maneuver, an audible alert sound **S** to let you know to make the maneuver.

Select **Tone Options**.

Select either **Bell**, **Chime**, or **Beep**.

When you have finished, select **t**

Save.

8.1.10 GPS Options

the ability to speed up signal acquisition time.

8.1.10.1 GPS Status

The GPS Status screen is available by pressing the GPS Signal icon on the Map screen (see “Map Screen” on page 17) as well as through the GPS Options menu. GPS Status monitors the satellite signal. For more information on the GPS Status screens refer to “GPS Status Screen” on page 120.

Chapter 8: Navigation Options

8.1.10.2 Set GPS Position

Set GPS Position enables you to manually set the location of the Current Position icon. If you have travelled a long distance with the Magellan CrossoverGPS 3150 off, it may take some time for the Magellan CrossoverGPS 3150 to reacquire a satellite signal. By manually setting the position of the Magellan CrossoverGPS 3150, you are telling the

Magellan CrossoverGPS 3150 where you are and will speed up the satellite signal acquisition. Make sure you first select the country you are in by pressing the Globe button on the Destination screen (see “Country Selection (Globe Button)” on page 25). Select **Set GPS Position**.

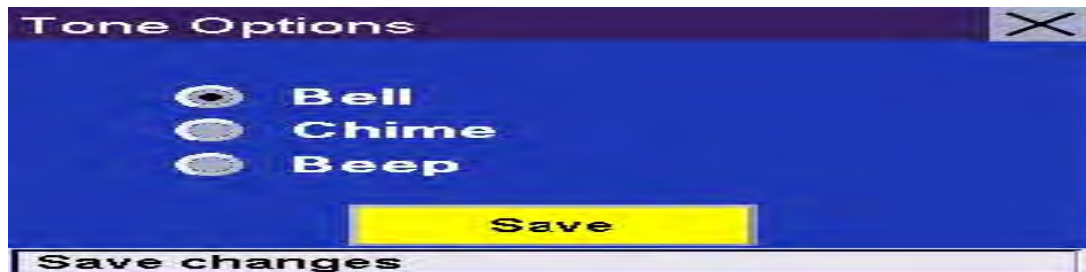

Enter the first few characters of the city name (see “Inputting Text Characters” on page 13). Select **OK**. Use the Navigation key to scroll the list up or down (if necessary) and select the desired city.

Enter the street name (see “Help with Address Entry”

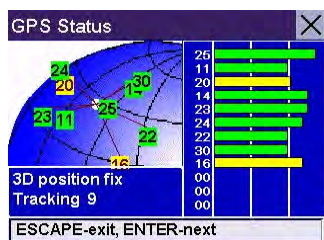

on page 15). Select **OK**. Use the Navigation key to scroll the list up or down (if necessary) and select the desired street.

Enter the street address. The acceptable range of numbers is displayed at the top of the screen. If you do not know the exact address, just select **Done** and the Magellan CrossoverGPS 3150 will use the lowest number in the range. Select **Done** to continue. You will be returned to the Configuration menu.

Go to the Map screen. Your current position is now set to the address you entered.

8.1.11 Simulator Mode

In Simulator Mode, you can demonstrate the capabilities of the Magellan Maestro 3100/3140 without actually driving. In order

for the simulation to work, you must set a route first.

Select **Simulator Mode**.

Select **Simulate** to begin the simulation.

Set the speed variance of the simulation: x1 will “drive” at normal speed using known speed limits;
x1.5 will “drive” at one and a half times normal speed;
x2 will “drive” at two times normal speed.

Return to the Map screen to view the simulation.

To disable Simulator Mode, select **Stop**, or when the power is turned off the Simulator will stop.

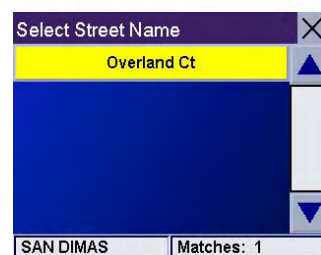
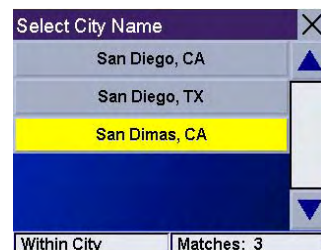

Chapter 8: Navigation Options

8.1.12 Automatic Volume

The Magellan CrossoverGPS 3150 can be set to automatically increase the volume when the vehicle exceeds 45 MPH in order to compensate for road noise.

Select **Automatic Volume**.

Select the number increment by which to increase the volume.

Select **Enable**.

When you have finished, select **Save**.

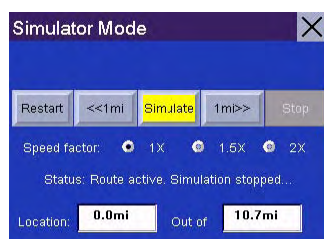

8.1.13 Backup and Restore

The Magellan CrossoverGPS 3150 has the capability to back up your information (Address Book, Previous Destinations, etc.) to an optional memory card.

8.1.13.1 Backup

Select **Backup and Restore** then, select **Backup**.

If you do not have a card inserted, you will be prompted to insert a card.

Make sure the card is unlocked to allow data to be

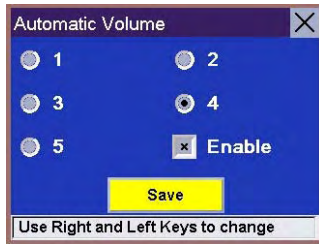

copied to it. Insert a card
and reselect **Backup**.

A dialog box will appear asking you to confirm your selection. Select **Yes**.

The files are copied to the memory card.

8.1.13.2 Restore

To restore the files to the hard disk, select **Backup and Restore** then, select **Restore**.

If you do not have a card inserted, you will be prompted to insert a card. Insert a card and reselect **Restore**.

A dialog box will appear asking you to confirm your selection. Select **Yes**. The files are copied to the hard disk.

Chapter 8: Navigation Options

8.1.14 Map Information

Product Information displays information about the map and database installed in your Magellan CrossoverGPS 3150. This information aids our Technical Support Representative in finding a solution to whatever problem you may have.

8.2 Trip Computer

The Trip Computer is a valuable tool for recording the mileage and time spent driving while on business or vacation. The information for the trip can be saved and viewed at any time, providing you easy access to information on your current trip, as well as previous trips.

To access these features, press the **MENU** key on the Magellan CrossoverGPS 3150 and select **Navigation Options**.

Select **Trip Computer**.

8.2.1 Current Trip

When you begin a new trip and you need to record the information, access the Trip Computer. There you can save the information displayed for the current trip (if needed) and reset the Trip Computer to zero in preparation for your new trip. Select **Trip Computer Select Current** from the list of saved Trip Reports.

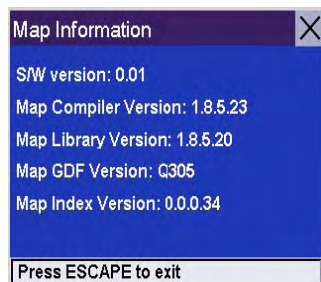

Chapter 8: Navigation Options

The Trip Computer is always in a “Running” state. The information for the current trip is displayed.



8.2.1.1 Stopping or Starting

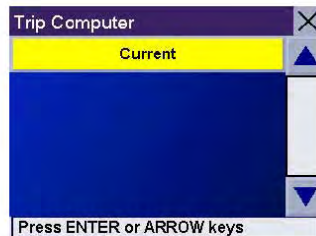

the Trip Computer

At any time the Trip Computer can be stopped and started. If the Trip Computer is currently running, select **Stop**. The Trip Computer will stop recording until restarted or reset.

While the Trip Computer is in a “Stopped” state, select **Start** to continue recording the current trip or select reset to begin a new trip.

8.2.1.2 Saving the Current Trip Report

When you have finished with your trip, you can save the information for later viewing. Select **Save** at any time.

Use the keypad to enter a name for the Trip Report and select **OK** when you are finished.

Chapter 8: Navigation Options



8.2.1.3

Resetting the Trip Computer

Before

starting a new trip that you want to record, you need to reset the Trip Computer first. Select Reset and the information will be set to zero. The Trip

Computer will remain in a

“Running” state.

8.2.1.4 Viewing a Saved Trip Report

From the Trip Computer screen, select the Trip Report you wish to view.

The saved Trip Report is displayed. Press the **ESCAPE** key when you are finished to view the trip and return

to the Trip Computer screen.

8.2.1.5 Deleting a Trip Report

Select the

Trip Report to be deleted.

Select **Delete**.

Chapter 10: System Settings

10.3.2 Change Password

Select **Change Password**. Use the keypad to enter the desired password.

When you have finished, select **OK**.

Re-enter the password to confirm. Use the keypad to re-enter the password exactly as you entered it the first time. When you

have finished, select **OK**.

Select **OK** to activate the password. To return to the System Settings menu without setting the password, select **ESC**.

Once the password is enabled, you will be required to enter it when the Magellan CrossoverGPS 3150 is turned on or when it wakes up from “sleep” mode.

10.3.3 Delete Password

Select **Delete Password** and use the keyboard to enter the password.

A dialog box will appear asking you to confirm your selection. Select **Yes**.

10.4 Language

To change the language for the menu text and voice prompts for navigation, select **Language**.

Select the desired language. A dialog box will appear asking you to confirm your selection. Select **Yes**.

The Magellan CrossoverGPS 3150 will restart itself with the new language enabled.

Chapter 11: System Status

The System Status menu give you further options to check the performance of your Magellan CrossoverGPS 3150.

11.1 Product Information

Select Product Information to show the current application software versions. Also, the current hardware and firmware versions will be displayed.

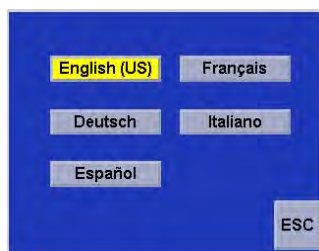

11.2 User Storage

the memory card if it is installed..

11.3 Diagnostics

Diagnostics enables you to test elements of the Magellan 3100/3140

11.3.1 Audio Test

The Audio Test will check the performance of the built-in speaker.

11.3.2 Touchscreen Test

The Touchscreen test will enable you to recalibrate the touchscreen should it not be tracking properly.

11.3.3 Keypad Test

The Keypad test will determine if the buttons on the Magellan CrossoverGPS 3150 are functioning.

11.3.4 Video Test

The Video test will test to determine if the screen is displaying colors properly.

11.2 User Storage

Select **User Storage** to display the available space of the memory card if it is installed..

11.3 Diagnostics

Diagnostics enables you to test elements of the Magellan 4000/4040/4050

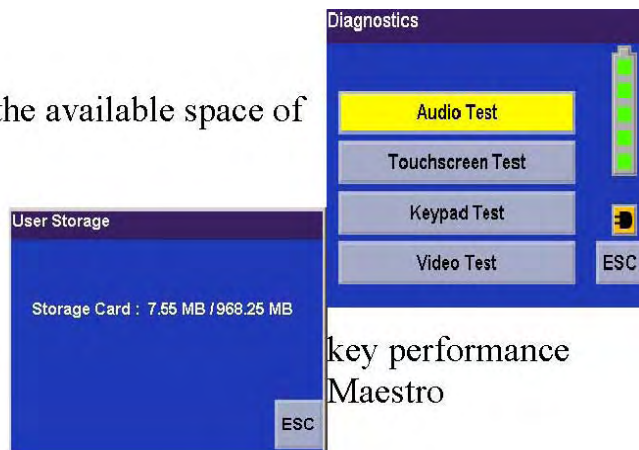

key performance
Maestro

Chapter 11: System Status

11.4 Contact Us

If you experience problems using your Magellan CrossoverGPS 3150, you can contact us at the numbers displayed.

The Magellan Maestro Tools application enables you to create custom POI's and load them onto your Magellan CrossoverGPS 3150. Additionally, you can load pictures and music onto an SD or MMC card (sold separately) to view or play anytime. See "Using Removable Memory Cards" on page 9.

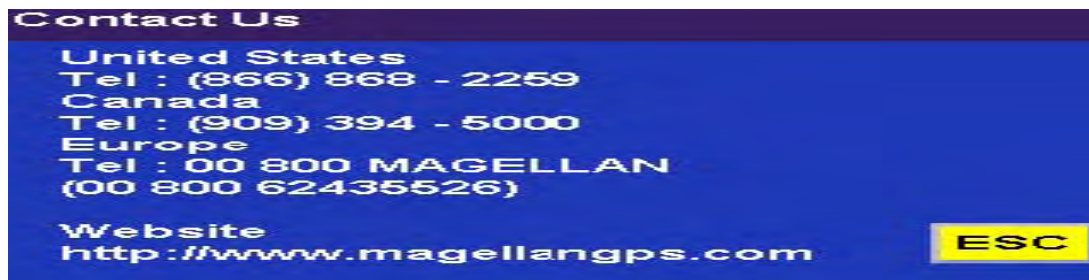

12.1 Installing the Software

Insert the Magellan Maestro Tools PC Application CD into your PC's CD drive.

The setup application will begin automatically. If it does not, browse your computer's CD drive and double-click on the setup.exe file.

Select a default language for the Application.

The Welcome screen will appear to begin the installation process.

Choose a destination for the application. Select **Next** to use the default location, or select **Browse** to choose a custom destination. Next, choose a Program Folder to place the application icons.

The Magellan Maestro Tools software will be installed. After it has finished installing, a dialog box pertaining to Microsoft Digital Signatures may appear, select **OK**

When it has finished, you can have the installer launch the application automatically, or deselect to exit without launching the application. Select **Finish**.

The Magellan Maestro Music Manager enables you to transfer song files in MP3 or WMA format from your computer to an optional memory card (see "Using Removable Memory Cards" on page 9) installed in your Magellan CrossoverGPS 3150. The amount of music you can load depends on the size of the card.

Insert the memory card into the memory card slot as show on page 9. Turn on your Magellan CrossoverGPS 3150 by pressing and holding the Power button for approximately 2-3 seconds if in sleep mode. (Ten seconds if not in sleep mode.) When the Warning screen appears, insert the small end of the USB cable into the USB port on your Magellan CrossoverGPS 3150 and the large end into an available USB port on your computer.

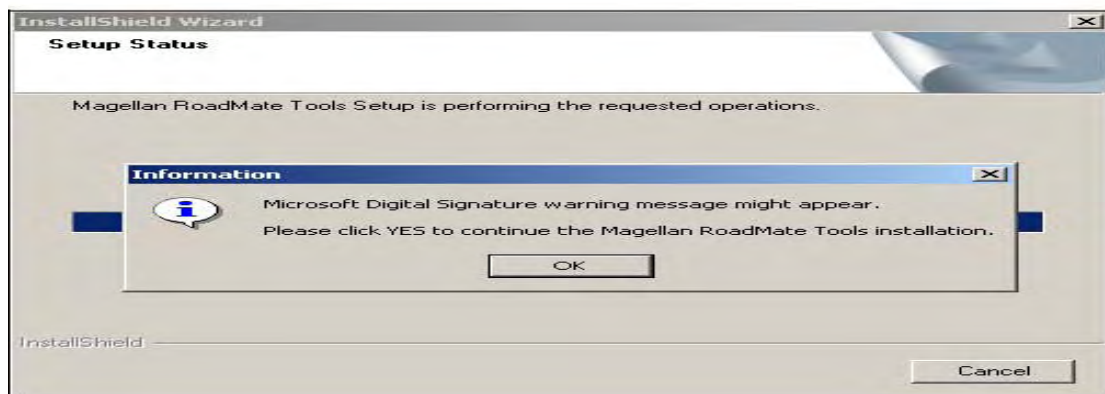
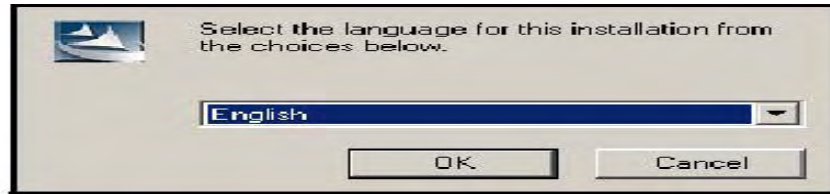

ro Tools screen, click on **Music**.

The left side of the window shows the contents of your computer and the right side of the window shows the contents of the memory card installed in your Magellan CrossoverGPS 3150.

Locate the song files you wish to load. When you have selected a file, the **Transfer** arrow will turn green. Click on the **Transfer** arrow to copy the file(s) to the memory card.

In the same way, if you have loaded song files onto a memory card from another computer, you can copy the files from the memory card to your computer.

When you have finished copying files, remove the USB cable from the Magellan CrossoverGPS 3150.

Chapter 17: Magellan Maestro POI Manager

The Magellan Maestro POI Manager enables you to transfer custom points of interest files from your computer to your Magellan CrossoverGPS 3150.

Before we add any custom POI's to the Magellan CrossoverGPS 3150, you should understand how the POI Manager plots POIs.

17.1 Latitude

90° (North Pole)

Latitude can be expressed by dividing Earth into horizontal segments totalling 180 degrees. Starting at the Equator, or zero degrees Latitude, lines (or Parallels) are drawn in 10-degree increments 90 degrees to the north and 90 degrees to the south. If your location is below the Equator,

30°

you are at a South Latitude.

20° 10° 0° 0° 10° 20° 30° 40°

17.2 Longitude

Conversely, longitude lines can be expressed by dividing Earth into vertical segments totalling 360 degrees. Starting at the Prime Meridian (which is The Royal Observatory in Greenwich, England), or zero degrees Longitude, lines are drawn in 10-degree increments 180 degrees to the West and 180 degrees to the East. If your location is on the western hemisphere, you

are at a West Longitude.

Additionally, to narrow down your location

further, each 10-degree segment

is divided into 60 smaller segments called

minutes and, still further, each

minute is divided into 60 segments called

seconds.

To express this in coordinates, the city of

Los Angeles is located at 34°

(degrees) 03' (minutes) and 08 (seconds)

North of the Equator, and 118°
 (degrees) 14' (minutes) and 42 (seconds)
 West of the Prime Meridian.

17.3 Altitude

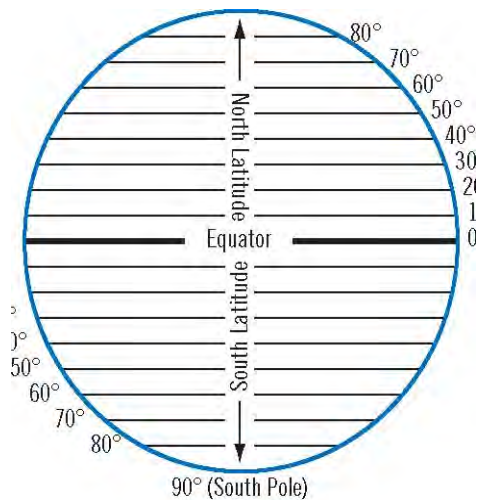

Each location can also have an Altitude. Altitude is expressed by how far the point is above or below the level of the ocean, or 100' Above Sea Level. For example, Los Angeles, California is about 300 80' Above feet above sea level. Death Valley, California is about 270 feet below sea

level. 60' Above

40' Above 20' Above Sea Level 0' 20' Below 40' Below 60' Below 80' Below

100' Below

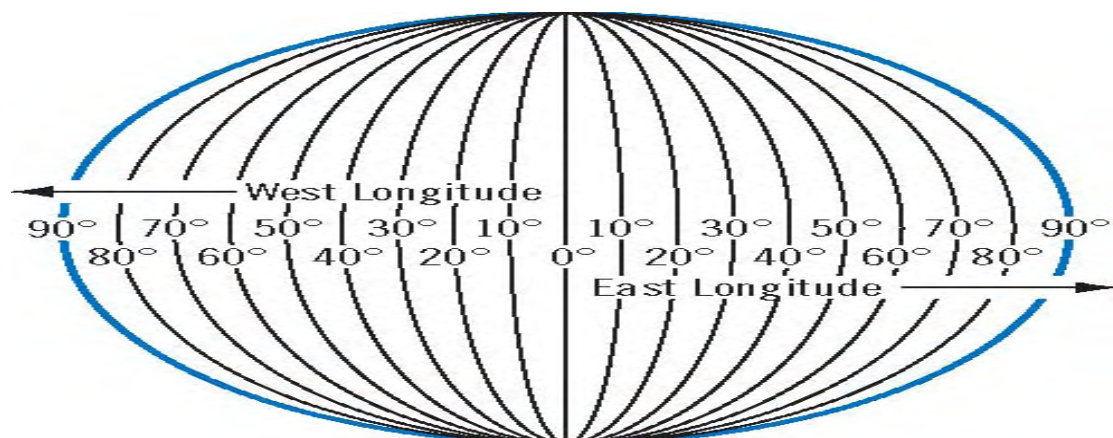

Turn on your Magellan CrossoverGPS 3150 by pressing and holding the Power button for approximately 2-3 seconds, 10 seconds if not in sleep

mode (see “Top View” on page 6). When the Warning screen appears, insert the small end of the USB cable into the USB port on your Magellan CrossoverGPS 3150, and the large end into an available USB port on your computer.

Launch the Magellan Maestro Tools application. From the Magellan Maestro Tools screen, click on **POI**.

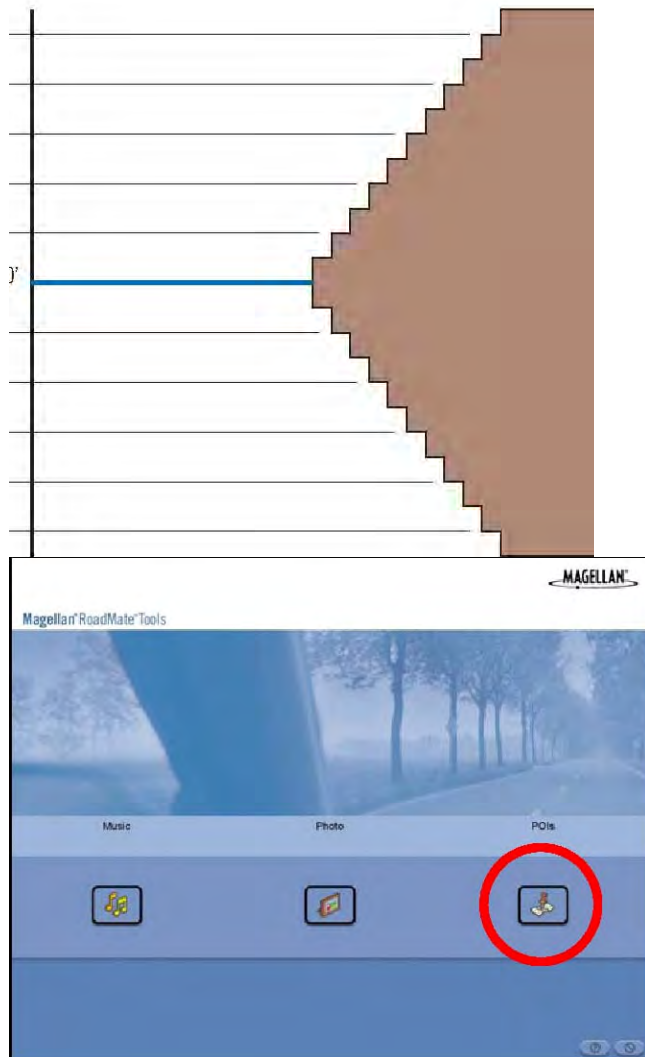

The left side of the window shows the contents of your computer and the right side of the window shows the contents of the Magellan CrossoverGPS 3150.

17.4 Opening a POI File

When you start the POI Manager the contents of your “My POI’s” folder will be displayed. This is the default location for storing custom POI files.

Chapter 17: Magellan Maestro POI Manager

Locate the POI files you wish to load. When you have selected a file, the Copy To Unit arrow will turn green. Click on the arrow to copy the file to your Magellan CrossoverGPS 3150.

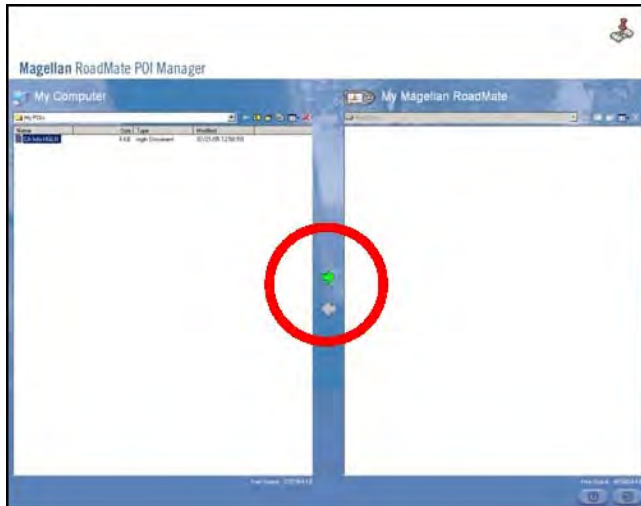

When you have finished copying files, remove the USB cable from the Magellan CrossoverGPS 3150.

17.5 Creating a New POI File

There are two ways to create a POI file. You can either add POI's individually, or you can import a character delimited file containing the information need to plot the POI's. To plot a POI, each item must have a name, longitude, and latitude. Longitude and latitude must be in decimal format.

17.6 Adding Individual POI's

Click on the **New POI File** Button to launch the POI Editor.

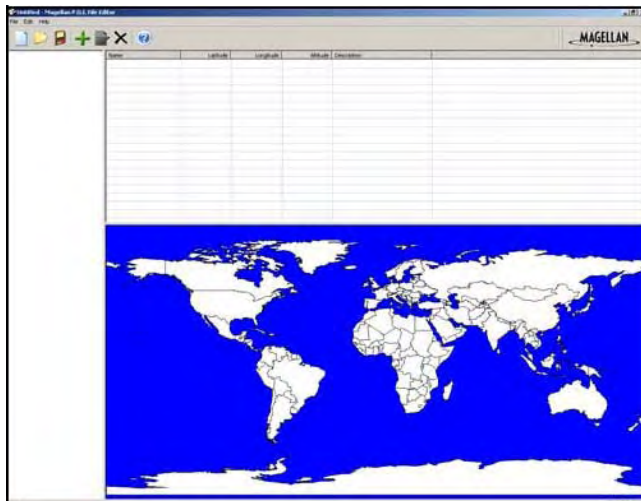

Click on the **Add** button



Enter the Name, the Latitude, and the Longitude. The Altitude and Description fields are optional.

Chapter 17: Magellan Maestro POI Manager

Select the Category field and select **New**. A dialog box will appear to create a new POI category. Enter the Name and assign an Image (icon) for the POI. The Description field is optional.

The Alert feature is an audible alarm that lets you know when you are within a certain distance from the POI. You can set an initial reminder (Distance 1), a secondary reminder (Distance 2).

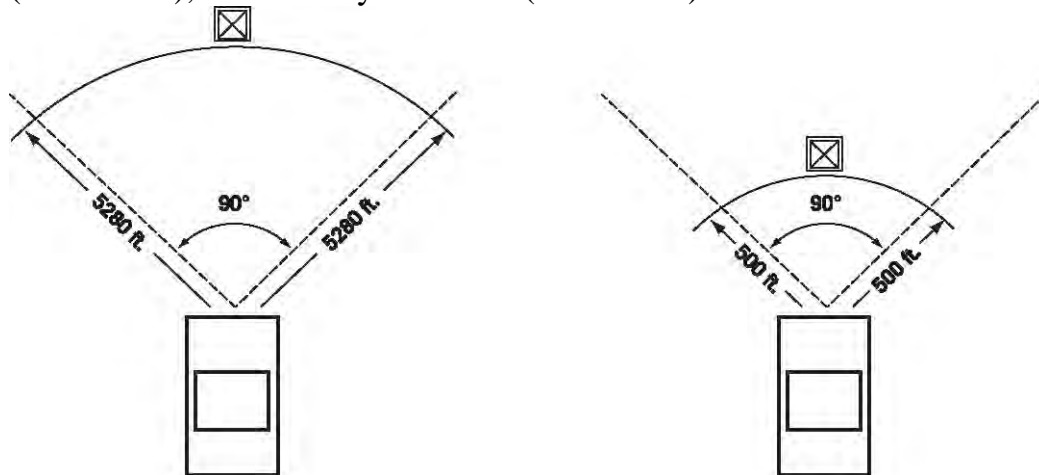

Distance 1 Distance 2

Select your preferred unit or measure (Meters or Feet).

The Detection angle sets the range of alert in degrees from the POI.

Select Activate alert for this category to enable the alert settings. When you have finished, select **OK**.

17.7 Importing a Data File

The POI Manager software supports ASCII file format (.ASC,.CSV,.TXT); GPS Exchange file format (.GPS,.XML); Magellan Waypoint file format (.WPT,.RTE); and Garmin PCX5 Waypoint file format (.WPT,.RTE).

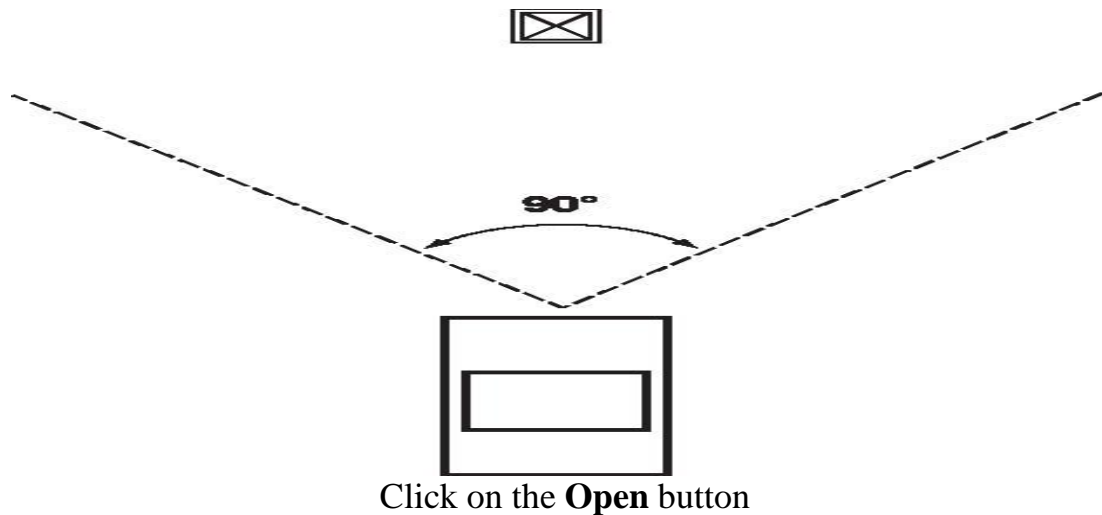

Select the file you wish to import and click **Open**.

Start by choosing which line in the data file to start importing data. If your data file has a header row, this row will generate an error so you should start at line two or below.

Next, choose how the data is separated and click on **Next**.

You now need to define the data columns. Click on the pull down menu and assign a field name to the appropriate column.

Click on **Finish**.

Click on The **Save POI file** button. Assign a name to your file and click on **Save**.

Close the POI File Editor. Select the POI file you just created and click on the transfer button (right arrow) to upload the file

to your Magellan CrossoverGPS 3150.

See page 55 for information on accessing custom POIs on your

Magellan

Maestro 3100/3140.

Appendix POI Categories

The Magellan CrossoverGPS 3150 POI database has 37 different categories. The icons will appear on the Map screen (if enabled):



Restaurant Fast food, diners, and food marts Bank/ATM Most financial services Gas Station Most fuel services Roadside Assistance Towing companies Hospital/Polyclinic Most medical services Vehicle Services Repair shops, tire stores, and oil changes Airport International and Municipal airports

Camping & RV Campgrounds, camping areas, and RV parks Car Rental Car rental companies Casino Gambling venues City Center The geographical center of a selected city Clothing Clothing retail stores Convention Center Major Convention Centers Education Schools, Colleges, and other learning

institutions Emergency Services Police, Fire, and Emergency Rooms
Entertainment Movie theaters, live performance venues Golf Course
Grocery Store Hair & Beauty Health Care Home & Garden Hotel or Motel
Marina Misc. Services Nightlife Open Parking Area



Parks Professional Services

Public Buildings Rest Area Shopping Ski Resorts Sports & Recreation
Tourist Attraction Transportation Winery Worship Private and public
courses Major chains and local markets Salons and beauty parlors Doctors'
offices and pharmacies Nurseries and do-it-yourself centers Most overnight
stay locations Docks and harbors Other services not categorized Dance halls,
pubs, nightclubs Parking lots and garages

Appendix

County, regional, and local parks Business office locations
Libraries, museums, and government

buildings Rest stops along major highways Malls and other retail stores
Most major ski resorts Stadiums, parks, lakes Places most visited by
tourists Bus and train stations Vinyards and tasting locations Churches,
temples, mosques

**When selecting restaurants, you can further
narrow the search by cuisine type such as French,
Italian, Greek, Mexican, etc.
Appendix**

Specifications

**Dimensions: 3.8" x 4.8" x 1.4" 9.6cm x 12.2cm x 3.5cm Weight: 8.64 oz.
245 g Display: 3.5" color touch screen display, 2.11" x 2.81" (53.64mm x
71.52mm) Screen Resolution: 320 x 240 QVGA; 64,000 colors Accepted
Card Media: Secure Digital (SD) or Multimedia Card (MMC) Audio:
Integrated Speaker with integrated stereo headphone jack GPS
Antenna: Integrated with optional external antenna connection Battery:
2100mA LI-ION USB Interface: 1.0 Operating Temperature: 32°F to
104°F 0°C to +40°C Storage Temperature: -4°F to 158°F -20°C to
+70°C Humidity: 50% ± 20% ambient room**

PC Requirements

- **IBM Compatible PC, Pentium or higher**
- **Microsoft ® Windows® 2000 or XP**
- **128 MB RAM**
- **CD Drive for Software Installation**
- **DVD Drive for Map Upgrades**

USB Port

Appendix

GPS Status Screen

GPS STATUS Screen Structure-first page

CH PRN AZ EL SNR U/N

01 d1 d2 d3 d4 c1 02 d1 d2 d3 d4 c1 03 d1 d2 d3 d4 c1 04 d1 d2 d3 d4 c1
05 d1 d2 d3 d4 c1 06 d1 d2 d3 d4 c1 07 d1 d2 d3 d4 c1 08 d1 d2 d3 d4 c1
09 d1 d2 d3 d4 c1 10 d1 d2 d3 d4 c1 11 d1 d2 d3 d4 c1 12 d1 d2 d3 d4 c1
13 d1 d2 d3 d4 c1 14 d1 d2 d3 d4 c1

It is ordered by the channel number from 1 to 12.

Where:

d1: Satellite PRN number, with “e” or “E” to the right means got ephemeris data, “v” or “V” to the right means got verified

ephemeris data (double check). “E” or “V” also means got satellite time

for this channel.

d2: Azimuth, in degrees

d3: Elevation angle, in degrees

d4: SNR (signal to noise ratio), it is ratio-Hz, not dB unit

c1: U – Used for position fix, U – Not used for position fix

Bad fix code

0 PVT_OK :good fix 2 ILLEGAL_ALT: illegal altitude < -10km or > 17.5km 4 POSITION_JUMP: too big position jump between two epoch (300 miles) 5 ILLEGAL_VELOCITY_OR_ALT: max velocity 951mile 7 TOO_BIG_ACCELERATION max 15m around 1.5g 8 TOO_SMALL_ALTITUDE -10000 m 9 TOO_BIG_ALTITUDE 17,500 m 10 TOO_BIG_PDOP max PDOP 50 11 SATS_BELOW_MASK_ANGLE satellite elevation angle is below mask angle 16 ILL_DEFINED_3D_MATRIX 3X3 matrix can not be inverted in 3D fix

Appendix

17 ILL_DEFINED_2D_MATRIX 2X2 matrix can not be inverted in 2D fix 20 NO_SAT_TIME no satellite time 23 NOT_ENOUGH_SATS no enough satellite for 2D or 3D fix 24 CANNOT_SELECT_FIX_TYPE 30 VELOCITY_2D_ONLY 2 satellite fix only for velocity, no position fix 31 BAD_VELOCITY_PDOP 50 too big pdop for velocity 32 TOO_MANY_SATS_FOR_2D_VEL there are 4 or more satellites, but 2D fix provided 51 WRONG_NUMSAT number of satellite for fix > 12 or less 2 56 LOOP_3D_NOT_CONVERGING 3D initial fix is not convergent 57 MILLISECOND_ERROR millisecond jump happened 58 LOOP_2D_NOT_CONVERGING 2D initial fix is not convergent 59 BAD_RANGE_CHITEST; range post-fix residuals chi-test failed 60 BAD_DOPPLER_CHITEST doppler post-fix residuals chi-test failed 61

OSC_DRIFT_ERR too much clock drift 60HZ for XO, 7.5HZ for TCXO
62 BAD_DOPPLER_ERR too big Doppler errors 4m/s
63 BIG_RANGE_RESID 110m/40m depend on virtual ttagl/ DGPS factors
64 BIG_DOPPLER_RESID 0.7m/s
65 HUGE_RANGE_RESID 10km normal for postfit residuals for range
66 HUGE_DOPPLER_RESID 100m/s normal for postfit residuals for doppler
Usually, Bad code is 20 and 23. If fix is good, it would be 0.

GPS STATUS Screen Structure - second page

Heading XXX (degree) Speeding XX.X (meter per second)

Current Lat: DDD.DDDDD W/E (current latitude, degree)

Current Long: DDD.DDDDD N/S (current longitude, degree)

Current altitude XXXX (altitude in mean sea level meter) TTF

XXXXs (Time-To-First-Fix in second)

#Satellite (U/T) XX/XX (the number of satellite used and tracked)

PDOP XX.X (Position Dilution Of Precision)

VDOP XX.X (Vertical Dilution of Precision)

TDOP XX.X (Time Dilution of Precision)

HDOP XX.X (Horizontal Dilution of Precision)

FOMS P/V/H (Figures Of Merits for position, velocity and heading in mapp matching)

UTC TIME MM/DD/YY HH:MM:SS(UTC time without local zone) Appendix Typical

GPS STATUS Screen Display First Page CH

**PRN AZ EL SNR U/N 01 27V 311 54 334 U 02
03E 078 29 135 U 03 13e 079 81 204 U 04 20e 175
06 90 N 05 31v 119 34 179 U 06 01V 120 53 316 U
07 28V 220 13 152 U 08 08V 282 29 182 U 09 02V
046 27 173 N 10 84 255 12 0 N 11 10 325 06 47 N
12 72 105 13 34 N 13 134 255 12 50 N 14 122 105**

13 63 N Second Page Heading 0 Speed 0.0 m/s

Current Lat: 34.10939 N Current

Long:117.82599 W GPS Version: Current

altitude 255 TTFF 116s #Satellite (U/T) 11/12

PDOP 2.3 VDOP 1.7 TTFF 0.0 HDOP 1.3 FOMS

P/V/H 2 UTC TIME 08/16/2004 22:56:53

Appendix Frequently Asked Questions

Why is my street not showing up on the map?

The Magellan CrossoverGPS 3150 uses the most current available map data. Chances are, your street is in a new housing development or the street is new. Map updates may be made available once per year.

I know there is a gas station on this street corner, why is there not icon for it on the map?

Check your POI settings and make sure you have the necessary POI checked to make it visible on the map. See “POI Selection” on page 55.

The Magellan CrossoverGPS 3150 uses the latest POI data available. Chances are the POI you are looking for is relatively new and has not been added to the database. If this is not the case, it may have been overlooked or changed since the POI database was created. You can add custom POIs to your Magellan CrossoverGPS 3150 to make up for those you route to often. See “Chapter 17: Magellan Maestro POI Manager” on page 112., and “Custom POIs” on page 55.

The GPS signal is weak. What's going on?

You may be driving through an area that has tall buildings or trees, or a canyon, or a tunnel. These conditions may interfere with satellite signals. Wait a few moments and the signal should get better as more satellites are acquired. If the problem persists, there may be a problem with the antenna. Contact Technical Support.

Why is an address I know I routed to not in the Previous Destinations list?

The Previous Destinations list stores the last 50 places you routed to. When you get to number 51, the first destination on the list is removed and each successive destination is moved up.

Can I play MP3's and Route at the same time?

No

Can I import a play list from Windows Media Player?

No. The Music Player does not support playlists from other applications.

Can I use any third party SD/MMC card with the Magellan CrossoverGPS 3150

The Magellan CrossoverGPS 3150 is compatible with most major brands of SD/MMC card.