



America

---

**Choose certainty.  
Add value.**

## Report On

Application for Grant of Equipment Authorization of the  
AnyDATA  
ACT233L 4G Vehicle Tracker with Hotspot

FCC CFR 47 Part 2, Part 22 and 24  
IC RSS-Gen and RSS-132 and RSS-133

**Report No. SC1304495E**

**May 2013**





**REPORT ON** Radio Testing of the  
AnyDATA  
4G Vehicle Tracker with Hotspot

**TEST REPORT NUMBER** SC1304495E

**PREPARED FOR** AnyDATA  
5 Oldfield  
Irvine, CA 92618

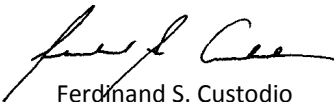
**CONTACT PERSON** Kevin Kim  
Principal Engineer  
(949) 900-6040 X306  
kevinkim@anydata.com

**PREPARED BY**   
Ferdinand S. Custodio  
**Name**  
Authorized Signatory  
Title: EMC/Wireless Test Engineer

**APPROVED BY**   
Chip R. Fleury  
**Name**  
Authorized Signatory

**DATED** May 20, 2012



**Revision History**

SC1304495E AnyDATA ACT233L 4G Vehicle Tracker with Hotspot					
DATE	OLD REVISION	NEW REVISION	REASON	PAGES AFFECTED	APPROVED BY
05/20/13	Initial Release				Ferdinand Custodio



## CONTENTS

Section	Page No
<b>1</b>	<b>REPORT SUMMARY ..... 5</b>
1.1	Introduction ..... 6
1.2	Brief Summary Of Results ..... 7
1.3	Product Information ..... 8
1.4	EUT Test Configuration ..... 10
1.5	Deviations From The Standard ..... 12
1.6	Modification Record ..... 12
1.7	Test Methodology ..... 12
1.8	Test Facility ..... 12
1.9	Sample Calculations ..... 13
<b>2</b>	<b>TEST DETAILS ..... 14</b>
2.1	Transmitter Conducted Output Power ..... 15
2.2	Effective Radiated Power ..... 17
2.3	Equivalent Isotropic Radiated Power ..... 19
2.4	Occupied Bandwidth ..... 21
2.5	Peak-Average Ratio ..... 29
2.6	Band Edge/Conducted Spurious Emissions ..... 33
2.7	Field Strength Of Spurious Radiation ..... 44
2.8	Frequency Stability ..... 51
2.9	Receiver Spurious Emissions ..... 55
2.10	Power Line Conducted Emissions ..... 58
<b>3</b>	<b>TEST EQUIPMENT USED ..... 59</b>
3.1	Test Equipment Used ..... 60
3.2	Measurement Uncertainty ..... 61
<b>4</b>	<b>DIAGRAM OF TEST SETUP ..... 62</b>
4.1	Test Setup Diagram ..... 63
<b>5</b>	<b>ACCREDITATION, DISCLAIMERS AND COPYRIGHT ..... 68</b>
5.1	Accreditation, Disclaimers and Copyright ..... 69



## **SECTION 1**

### **REPORT SUMMARY**

Radio Testing of the  
AnyDATA  
4G Vehicle Tracker with Hotspot



## 1.1 INTRODUCTION

The information contained in this report is intended to show verification of the AnyDATA 4G Vehicle Tracker with Hotspot to the requirements of the following:

- FCC CFR 47 Part 2, Part 22 and 24
- IC RSS-Gen and RSS-132 and RSS-133.

Objective	To perform Radio Testing to determine the Equipment Under Test's (EUT's) compliance with the Test Specification, for the series of tests carried out.
Manufacturer	AnyDATA
Model Number(s)	ACT233L
FCC ID Number	P4M-ACT233
IC Number	4594B-ACT233
Serial Number(s)	20130418001833 (CDMA 2000) and 20130418001829 (1xEV-DO)
Number of Samples Tested	2
Test Specification/Issue/Date	<ul style="list-style-type: none"><li>• FCC CFR 47 Part 2, Part 22 and 24 (October 1, 2012).</li><li>• RSS-132 - Cellular Telephones Employing New Technologies Operating in the Bands 824-849 MHz and 869-894 MHz (Issue 3, January 2013).</li><li>• RSS-133 – 2 GHz Personal Communications Services (Issue 6, January 2013).</li><li>• RSS-Gen - General Requirements and Information for the Certification of Radio Apparatus (Issue 3, December 2010).</li></ul>
Start of Test	April 29, 2013
Finish of Test	May 20, 2013
Name of Engineer(s)	Ferdie Custodio
Related Document(s)	<ul style="list-style-type: none"><li>• ANSI/TIA-603-C-2004 – Land Mobile FM or PM – Communications Equipment – Measurement and Performance Standards.</li><li>• KDB971168 (D01 Power Meas License Digital Systems v01) Procedures for Compliance Measurement of the Fundamental Emission Power of Licensed Wideband (&gt; 1 MHz) Digital Transmission Systems</li><li>• 412172 D01 Determining ERP and EIRP v01 (Guidelines for Determining the Effective Radiated Power (ERP) and Equivalent Isotropically Radiated Power (EIRP) of a RF Transmitting System.</li><li>• Supporting documents for EUT certification are separate exhibits.</li></ul>



## 1.2 BRIEF SUMMARY OF RESULTS

A brief summary of the tests carried out in accordance with FCC CFR 47 Part 2, Part 22 and 24 with cross-reference to the corresponding IC RSS standard is shown below.

Section	FCC Part Sections(s)	RSS Section(s)	Test Description	Result
2.1	2.1046	RSS-132(5.4),RSS-133(6.4)	Transmitter Conducted Output Power	Compliant
2.2	22.913(a)(2), 2.1046	RSS-132(5.4),SRSP-503(5.1.3)	Effective Radiated Power	Compliant
2.3	24.232(c),2.1046	RSS-133(6.4),SRSP-510(5.1.2)	Equivalent Isotropic Radiated Power	Compliant
2.4	2.1049,22.917(b), 24.238(b)	RSS-Gen(4.6.1)	Occupied Bandwidth	Compliant
2.5	24.232(d)	RRSS-133(6.4)	Peak-Average Ratio	Compliant
2.6	2.1051,22.917(a), 24.238(a)	RSS-132(5.5),RSS-133(6.5)	Band Edge/Conducted Spurious Emissions	Compliant
2.7	2.1053,22.917(a), 24.238(a)	RSS-132(5.5),RSS-133(6.5)	Field Strength Of Spurious Radiation	Compliant
2.8	2.1055,22.355,24.235	RSS-132(5.3),RSS-133(6.3)	Frequency Stability	Compliant
2.9		RSS-132(5.6),RSS-133(6.6)	Receiver Spurious Emissions	Compliant
2.10		RSS-Gen 7.2.4	Power Line Conducted Emission	N/A

N/A -EUT is for vehicular use only

### 1.3 PRODUCT INFORMATION

#### 1.3.1 EUT General Description

The Equipment Under Test (EUT) was an AnyDATA ACT233L 4G Vehicle Tracker with Hotspot as shown in the photograph below. The EUT connects to a vehicle's OBD2 port; it enables remote functions and vehicle tracking through a Smartphone app.







**1.3.2 EUT General Description**

EUT Description	ACT233L 4G Vehicle Tracker with Hotspot
Model Number(s)	ACT233L
Rated Voltage	13.5 VDC Nominal voltage.
Mode Verified	800/1900 CDMA2000 1xRTT and 1xEV-DO Release 0 Revision A
Capability	800/1900 CDMA2000 1xRTT and 1xEV-DO Release 0 Revision A, Band 4 and 13 LTE, 802.11 b/g/n WLAN, BT and Part 15.231 Transmitter
Primary Unit (EUT)	<input checked="" type="checkbox"/> Production <input type="checkbox"/> Pre-Production <input type="checkbox"/> Engineering
Antenna Type	Integral. custom PIFA type for main antenna and integral custom ILA type for diversity antenna
Antenna Gain	CELL (824-849 MHz) = -4 dBi PCS (1850-1910 MHz) = -3.5 to -5 dBi

**1.3.3 Transmit Frequency Table**

Mode	Tx Frequency (MHz)	Emission Designator	ERP(Part 22)/EIRP(Part 24)	
			Max. Power (dBm)	Max. Power (W)
CDMA2000 Cell Band	824.7-848.31	1M38F9W	18.83	0.076
1xEV-DO Cell Band	824.7-848.31	1M34F9W	18.77	0.075
CDMA2000 Cell Band	1851.25-1908.75	1M38F9W	20.95	0.124
1xEV-DO Cell Band	1851.25-1908.75	1M34F9W	19.28	0.085

**1.4 EUT TEST CONFIGURATION**

**1.4.1 Test Configuration Description**

Test Configuration	Description
A	Conducted antenna port measurement
B	Radiated test setup. EUT transmitting through integral antenna.

**Note:** Antenna port is for service function only.

**1.4.2 EUT Exercise Software**

EUT is controlled by a CMW 500 Wideband Radio Communication Tester. Client provided CMW 500 test profiles for each Band.

**1.4.3 Support Equipment and I/O cables**

Manufacturer	Equipment/Cable	Description
Sony	Support Laptop	Model PCG-3131L SN27545537 3001106
Rongchun	USB cable	0.9m, high speed USB, Type A to Micro-B connector, style 2725, USB Revision 2.0

**1.4.4 Worst Case Configuration**

Worst-case configuration used in this test report per Transmitter Conducted Output Power (Section 2.1 of this test report). This is for single channel verification, otherwise all three channels (Low, Mid and High) are verified:

Mode	Cellular	PCS
CDMA 1xRTT	Channel 1013	Channel 1175
1xEV-DO Release 0	Channel 1013	Channel 1175

- CDMA2000 1xRTT signalling configuration is SO2 (Loopback), Radio Configuration (Forward/Reverse) of 1/1 O-QPSK. Expected Power Mode at Max. Power.
- CDMA2000 1xEvDO signalling configuration is NR (Network Release) Release 0 and A. Application is Forward Test (FTAP). Expected Power Mode at Max. Power.

EUT is a mobile device. For radiated measurements X, Y and Z orientations were verified. Worst case position is "X".



1.4.5 Simplified Test Configuration Diagram

**Radiated Test Configuration/Conducted Emissions Test Configuration**

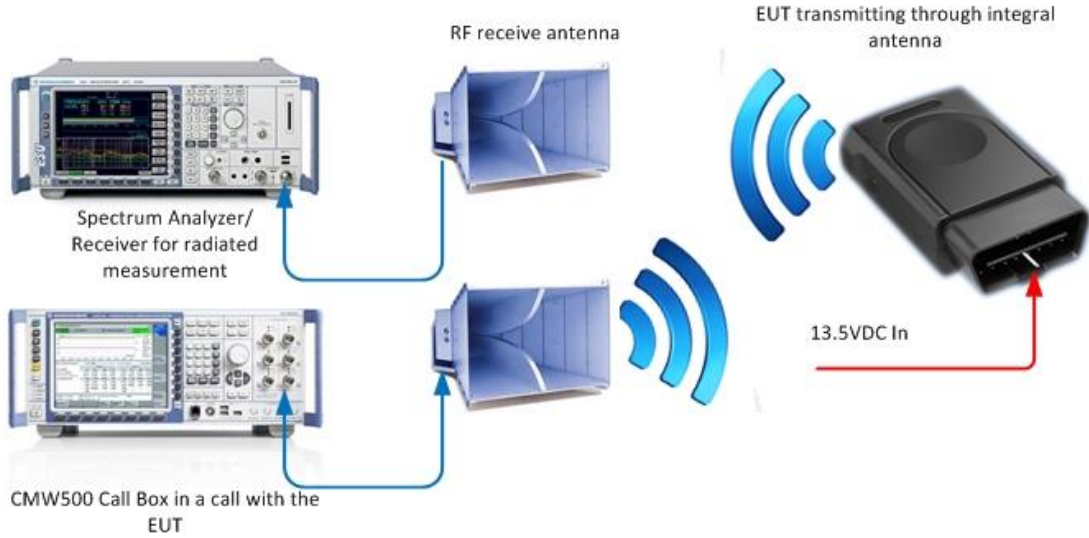

**Conducted (Antenna Port) Test Configuration**

**For Illustration Purpose Only**  
 Image presented may not represent the actual EUT or support equipment

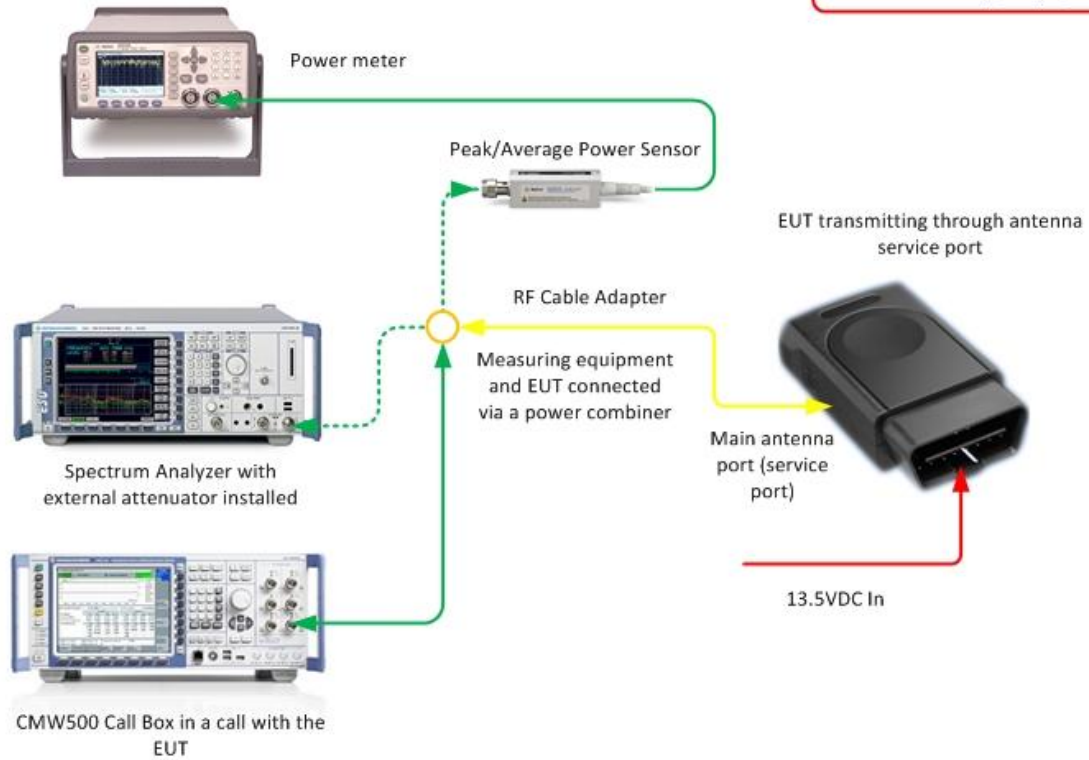



**1.5 DEVIATIONS FROM THE STANDARD**

No deviations from the applicable test standards or test plan were made during testing.

**1.6 MODIFICATION RECORD**

Description of Modification	Modification Fitted By	Date Modification Fitted
Serial Number 20130418001833 and 20130418001829		
N/A		

The table above details modifications made to the EUT during the test programme. The modifications incorporated during each test (if relevant) are recorded on the appropriate test pages.

**1.7 TEST METHODOLOGY**

All measurements contained in this report were conducted with ANSI C63.4-2009, American National Standard for Methods of Measurement of Radio-Noise Emissions from Low-Voltage Electrical and Electronic Equipment in the range of 9 kHz to 40 GHz.

For conducted (if applicable) and radiated emissions the equipment under test (EUT) was configured to measure its highest possible emission level. This level was based on the maximized cable configuration from exploratory testing per ANSI C63.4-2009. The test modes were adapted according to the Operating Instructions provided by the manufacturer/client.

**1.8 TEST FACILITY**

**1.8.1 FCC – Registration No.: US5296**

TUV SUD America Inc. (San Diego), is an accredited test facility with the site description report on file and has met all the requirements specified in §2.498 of the FCC rules. The acceptance letter from the FCC is maintained in our files and the Registration is US5296.

**1.8.2 Industry Canada (IC) Registration No.: 3067A**

The 10m Semi-anechoic chamber of TUV SUD America Inc. (San Diego), has been registered by Certification and Engineering Bureau of Industry Canada for radio equipment testing with Registration No. 3067A.



**1.9 SAMPLE CALCULATIONS**

**1.9.1 CDMA Emission Designator**

Emission Designator = 1M30F9W  
 F = Frequency Modulation  
 9= Composite Digital Info  
 W = Combination (Audio/Data)

**1.9.2 Spurious Radiated Emission (below 1GHz)**

Measuring equipment raw measurement (dBµV/m) @ 30 MHz		24.4
Correction Factor (dB)	Asset# 1066 (cable)	0.3
	Asset# 1172 (cable)	0.3
	Asset# 1016 (preamplifier)	-30.7
	Asset# 1175(cable)	0.3
	Asset# 1002 (antenna)	17.2
Reported QuasiPeak Final Measurement (dBµV/m) @ 30MHz		<b>11.8</b>

**1.9.3 Spurious Radiated Emission – Substitution Method**

Example = 84dBµV/m @ 1413 MHz (numerical sample only)

The field strength reading of 84dBµV/m @ 1413 MHz (2<sup>nd</sup> Harmonic of 706.5 MHz) is the maximized measurement when the EUT is on the turntable measured at 3 meters. The gain of the substituted antenna is 7.8dBi while the transmit cable loss is 1.0 dB (cable between signal generator and the substituted antenna). The signal generator level is adjusted until the 84dBµV/m level at the receiving end is replicated (identical test setup, i.e. same antenna, cable/s and preamp). If the adjusted signal generator level is -18dBm, then we have the following for both EIRP and ERP as required:

$$\begin{aligned}
 P_{EIRP} &= -18 \text{ dBm} + 7.8 \text{ dBi} - 1\text{dB} \\
 &= 11.2 \text{ dBm} \\
 P_{ERP} &= P_{EIRP} - 2.15 \text{ dB} \\
 &= 11.2 \text{ dBm} - 2.15 \text{ dB} \\
 &= 9.05 \text{ dBm}
 \end{aligned}$$



## **SECTION 2**

### **TEST DETAILS**

Radio Testing of the  
AnyDATA  
4G Vehicle Tracker with Hotspot



## **2.1 TRANSMITTER CONDUCTED OUTPUT POWER**

### **2.1.1 Specification Reference**

Part 2.1046 (a) and (c)

### **2.1.2 Standard Applicable**

(a) For transmitters other than single sideband, independent sideband and controlled carrier radiotelephone, power output shall be measured at the RF output terminals when the transmitter is adjusted in accordance with the tune-up procedure to give the values of current and voltage on the circuit elements specified in § 2.1033(c)(8). The electrical characteristics of the radio frequency load attached to the output terminals when this test is made shall be stated.

(c) For measurements conducted pursuant to paragraphs (a) and (b) of this section, all calculations and methods used by the applicant for determining carrier power or peak envelope power, as appropriate, on the basis of measured power in the radio frequency load attached to the transmitter output terminals shall be shown. Under the test conditions specified, no components of the emission spectrum shall exceed the limits specified in the applicable rule parts as necessary for meeting occupied bandwidth or emission limitations.

### **2.1.3 Equipment Under Test and Modification State**

Serial No: 20130418001833 and 20130418001829 / Test Configuration A

### **2.1.4 Date of Test/Initial of test personnel who performed the test**

May 10, 2013/FSC

### **2.1.5 Test Equipment Used**

The major items of test equipment used for the above tests are identified in Section 3.1.

### **2.1.6 Environmental Conditions**

Ambient Temperature	25.3°C
Relative Humidity	42.9%
ATM Pressure	99.3 kPa

### **2.1.7 Additional Observations**

- This is a conducted test using an average power meter.
- A 27.6dB power meter offset was used for the power splitter, external attenuator and cable used.

### **2.1.8 Test Results**

See attached table.



		CDMA2000	1xEV-DO	
	Channel	SO 2 RC1/1 O-QPSK	Release 0 (dBm)	Release A (dBm)
Cellular	1013	24.98	24.92	24.36
	384	24.86	24.85	24.32
	777	24.82	24.79	24.58
PCS	25	24.45	22.78	22.36
	600	24.58	24.11	23.05
	1175	24.61	23.17	22.72





## **2.2 EFFECTIVE RADIATED POWER**

### **2.2.1 Specification Reference**

Part 22 Subpart H §22.913(a)(2)

### **2.2.2 Standard Applicable**

The ERP of mobile transmitters and auxiliary test transmitters must not exceed 7 Watts.

### **2.2.3 Equipment Under Test and Modification State**

Serial No: 20130418001833 and 20130418001829

### **2.2.4 Date of Test/Initial of test personnel who performed the test**

May 20, 2013/FSC

### **2.2.5 Additional Observations**

- ERP was calculated as per Section 1.3.2 of KDB412172 D01 (Determining ERP and EIRP v01).
- Calculation formula in logarithmic terms:

$$\text{ERP} = P_T + G_T - L_C - 2.15\text{dB}$$

Where:

$P_T$  = transmitter conducted output power dBm (Section 2.1 of this test report)

$G_T$  = gain of the transmitting antenna, in dBi (EIRP: the -2.15 in the formula is to convert EIRP to ERP);

$L_C$  = signal attenuation in the connecting cable between the transmitter and antenna, in dB (EUT uses integral antenna, this value is negligible).

### **2.2.6 Test Results**

See attached table.



CDMA2000						
Frequency (MHz)	Conducted Power (dBm)	Antenna Gain (dBi)	ERP (dBm)	ERP (Watts)	ERP Limit (dBm)	Margin (dB)
824.70	24.98	-4	18.83	0.076	38.45	19.62
836.52	24.86	-4	18.71	0.074	38.45	19.74
848.31	24.82	-4	18.67	0.074	38.45	19.78

1xEV-DO						
Frequency (MHz)	Conducted Power (dBm)	Antenna Gain (dBi)	ERP (dBm)	ERP (Watts)	ERP Limit (dBm)	Margin (dB)
824.70	24.92	-4	18.77	0.075	38.45	19.68
836.52	24.85	-4	18.70	0.074	38.45	19.75
848.31	24.79	-4	18.64	0.073	38.45	19.81



## **2.3 EQUIVALENT ISOTROPIC RADIATED POWER**

### **2.3.1 Specification Reference**

Part 24 Subpart E §24.234(c)

### **2.3.2 Standard Applicable**

Mobile and portable stations are limited to 2 watts EIRP and the equipment must employ a means for limiting power to the minimum necessary for successful communications.

### **2.3.3 Equipment Under Test and Modification State**

Serial No: 20130418001833 and 20130418001829

### **2.3.4 Date of Test/Initial of test personnel who performed the test**

May 20, 2013/FSC

### **2.3.5 Additional Observations**

- EIRP was calculated as per Section 1.3.2 of KDB412172 D01 (Determining ERP and EIRP v01).
- Calculation formula in logarithmic terms:

$$\text{EIRP} = P_T + G_T - L_C$$

Where:

$P_T$  = transmitter conducted output power dBm (Section 2.1 of this test report)

$G_T$  = gain of the transmitting antenna, in dBi (EIRP);

$L_C$  = signal attenuation in the connecting cable between the transmitter and antenna, in dB (EUT uses integral antenna, this value is negligible).

### **2.3.6 Test Results**

See attached table.



CDMA2000						
Frequency (MHz)	Conducted Power (dBm)	Antenna Gain (dBi)	ERP (dBm)	ERP (Watts)	EIRP Limit (dBm)	Margin (dB)
1851.25	24.45	-3.5	20.95	0.124	33	12.05
1880.00	24.58	-5	19.58	0.091	33	13.42
1908.75	24.61	-4.5	20.11	0.103	33	12.89

1xEV-DO						
Frequency (MHz)	Conducted Power (dBm)	Antenna Gain (dBi)	ERP (dBm)	ERP (Watts)	EIRP Limit (dBm)	Margin (dB)
1851.25	22.78	-3.5	19.28	0.085	33	13.72
1880.00	24.11	-5	19.11	0.081	33	13.89
1908.75	23.17	-4.5	18.67	0.074	33	14.33



## **2.4 OCCUPIED BANDWIDTH**

### **2.4.1 Specification Reference**

Part 22 Subpart H §22.917(b) and Part 24 Subpart E §24.238(b)

### **2.4.2 Standard Applicable**

The emission bandwidth is defined as the width of the signal between two points, one below the carrier center frequency and one above the carrier center frequency, outside of which all emissions are attenuated at least 26 dB below the transmitter power.

### **2.4.3 Equipment Under Test and Modification State**

Serial No: 20130418001833 and 20130418001829 / Test Configuration B

### **2.4.4 Date of Test/Initial of test personnel who performed the test**

May 14, 2013/FSC

### **2.4.5 Test Equipment Used**

The major items of test equipment used for the above tests are identified in Section 3.1.

### **2.4.6 Environmental Conditions**

Ambient Temperature	25.8°C
Relative Humidity	41.7%
ATM Pressure	99.1 kPa

### **2.4.7 Additional Observations**

- This is a conducted test. Both 26dB bandwidth and 99% bandwidth presented.
- All channels for emission bandwidth verification verified.
- The RBW is set to 1% of the span while the VBW is 3X RBW.
- Only worst case configuration presented (see Section 1.4.4 of this test report for details).
- The SA built-in emission bandwidth measurement feature is utilized. The power level setting is set to 99% while "x dB" is set to -26.

### **2.4.8 Test Results**

See attached table and plots.



Mode	Band	Channel	Frequency (MHz)	OBW (MHz)	-26dB BW (MHz)
CDMA2000	Cell Band	1013	824.70	1.3829	1.582
		384	836.52	1.3708	1.580
		777	848.31	1.3782	1.587
	PCS Band	25	1851.25	1.3738	1.596
		600	1880.00	1.3799	1.594
		1175	1908.75	1.3838	1.616
1xEV-DO	Cell Band	1013	824.70	1.3426	1.594
		384	836.52	1.3404	1.597
		777	848.31	1.3439	1.3398
	PCS Band	25	1851.25	1.3398	1.548
		600	1880.00	1.3409	1.558
		1175	1908.75	1.3328	1.573



**CDMA2000 Cell Band Low Channel -26dB BW/99% OBW**

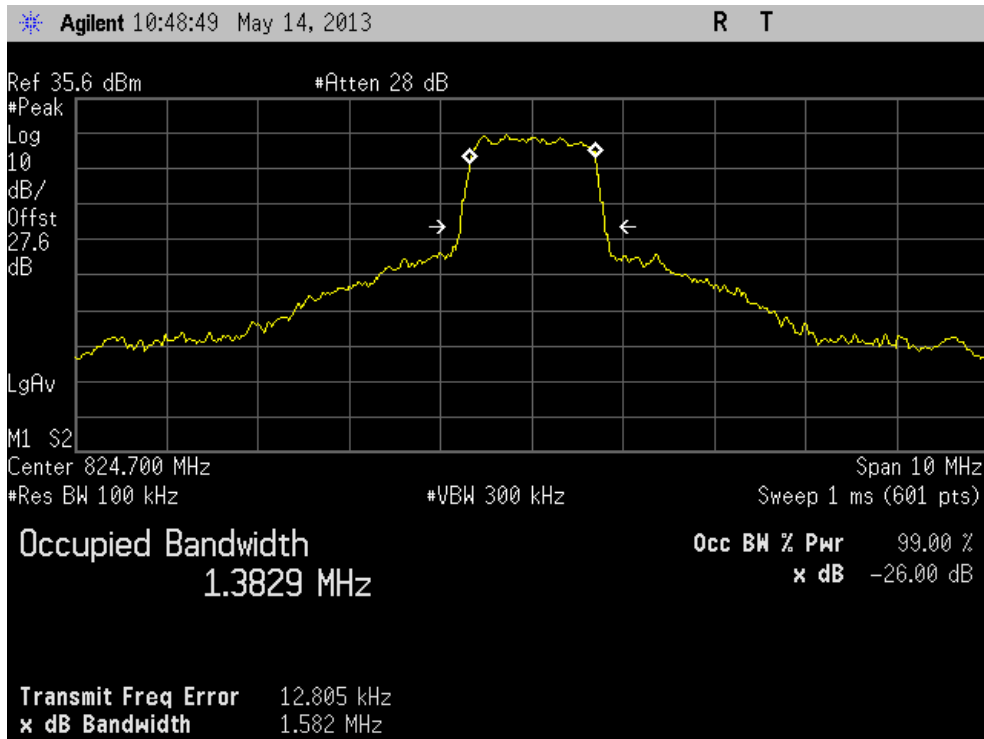

**CDMA2000 Cell Band Mid Channel -26dB BW/99% OBW**

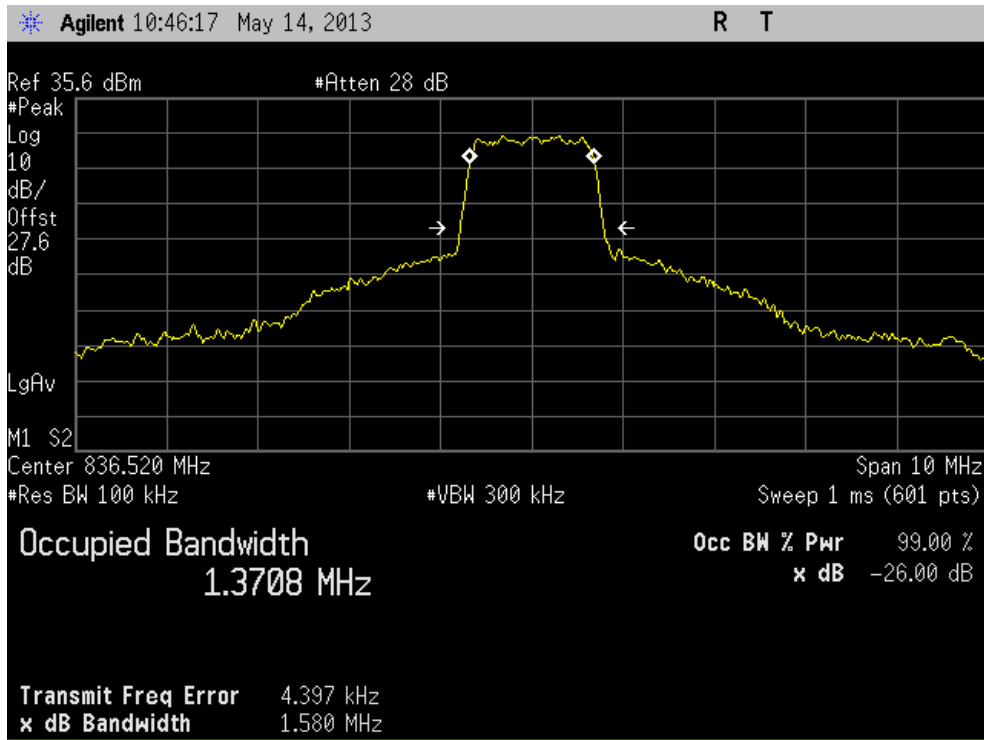

**CDMA2000 Cell Band High Channel -26dB BW/99% OBW**

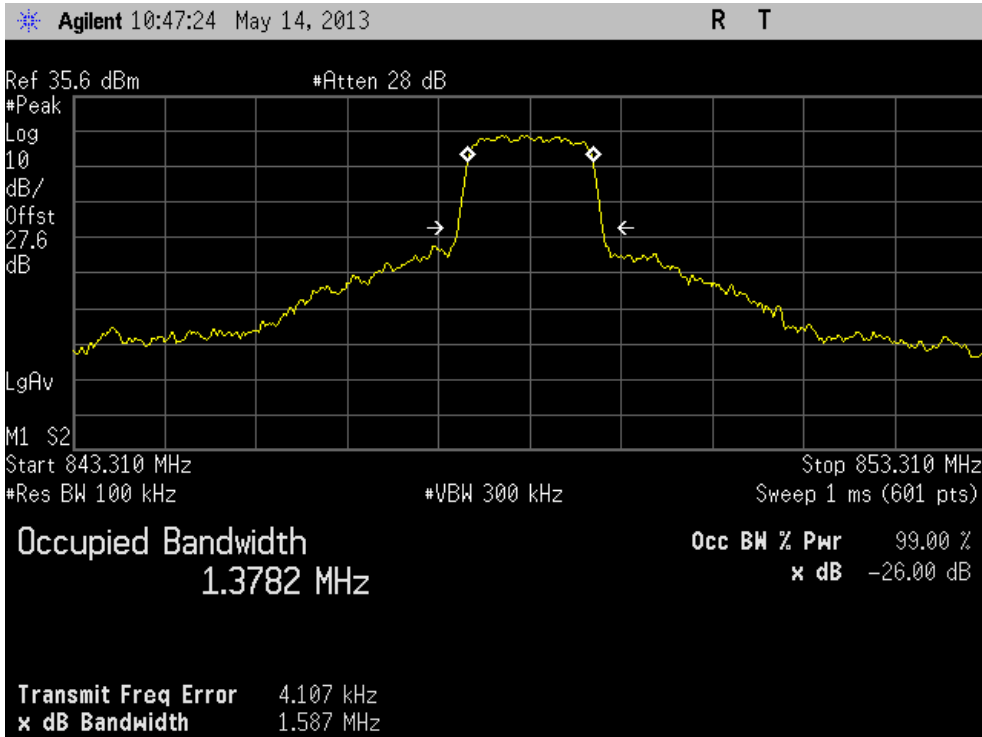

**CDMA2000 PCS Band Low Channel -26dB BW/99% OBW**

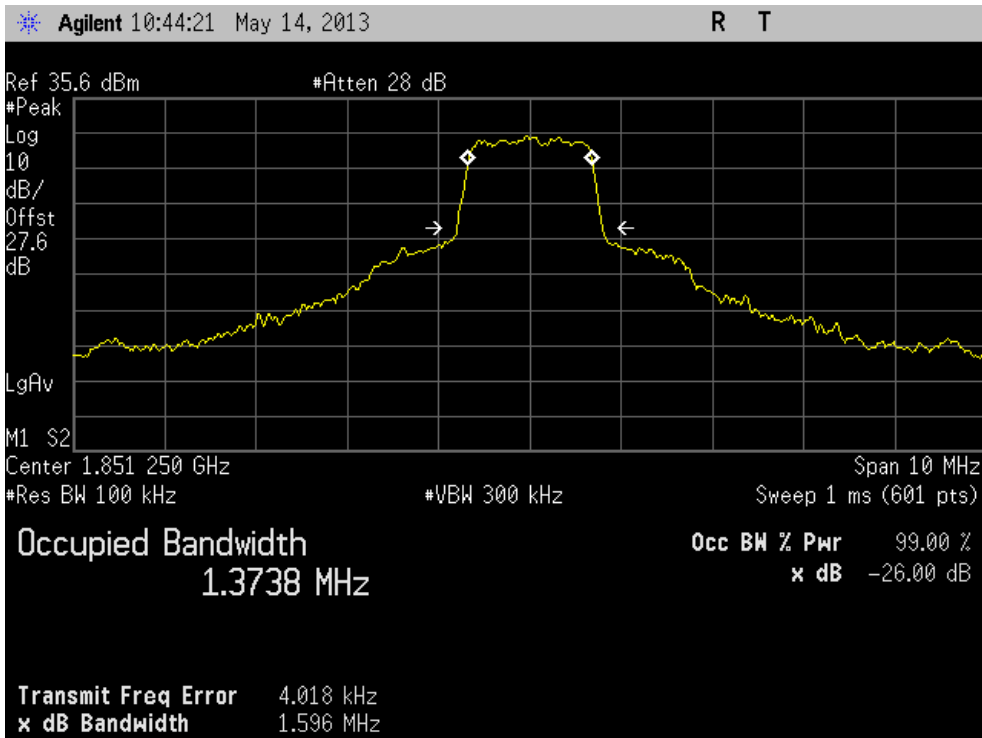



**CDMA2000 PCS Band Mid Channel -26dB BW/99% OBW**

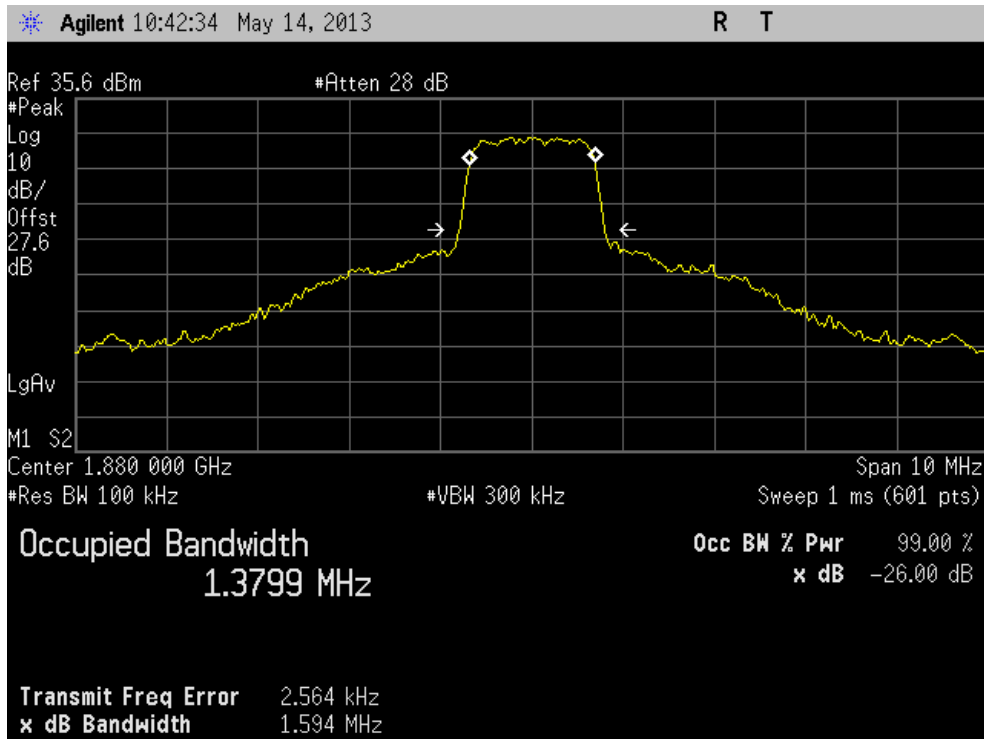

**CDMA2000 PCS Band High Channel -26dB BW/99% OBW**

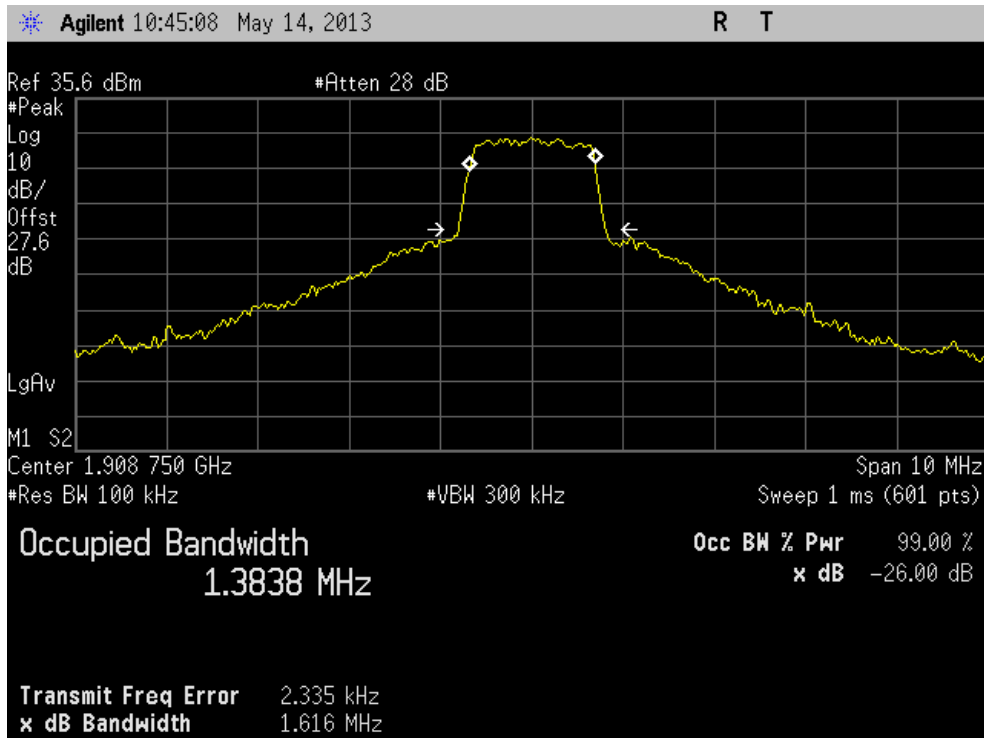

**1xEV-DO Cell Band Low Channel -26dB BW/99% OBW**

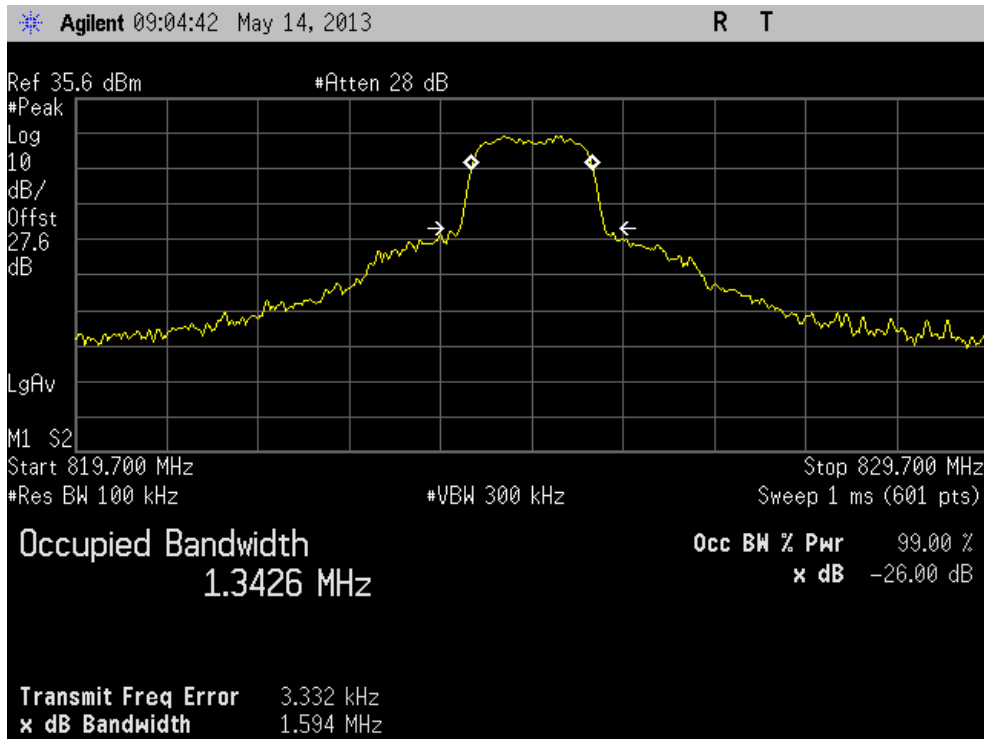

**1xEV-DO Cell Band Mid Channel -26dB BW/99% OBW**

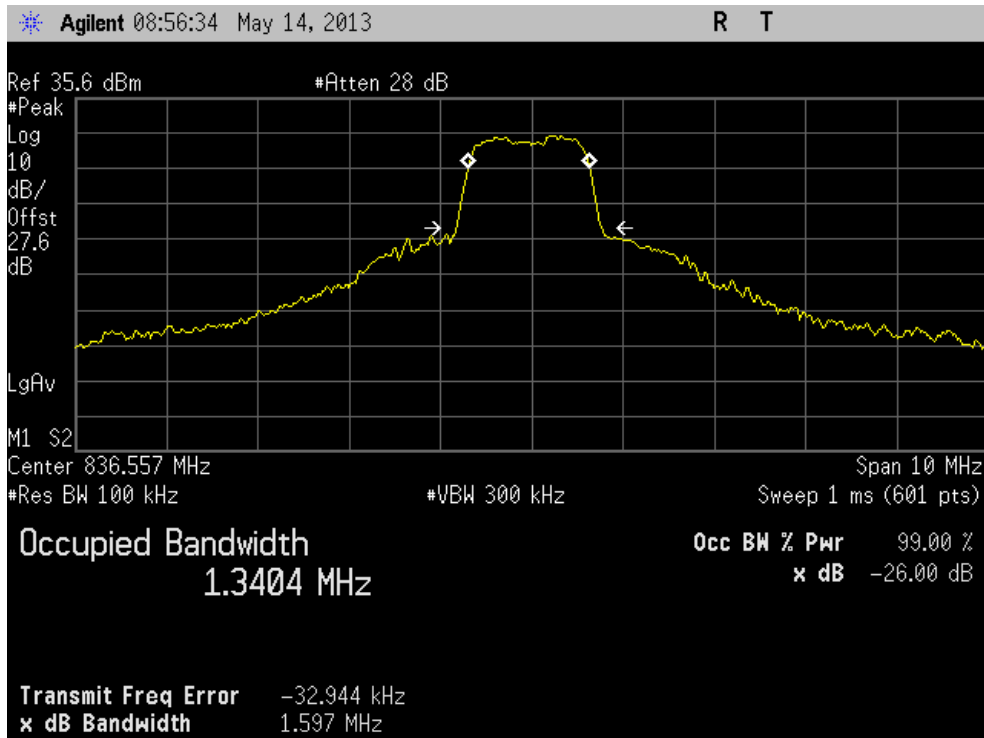

**1xEV-DO Cell Band High Channel -26dB BW/99% OBW**

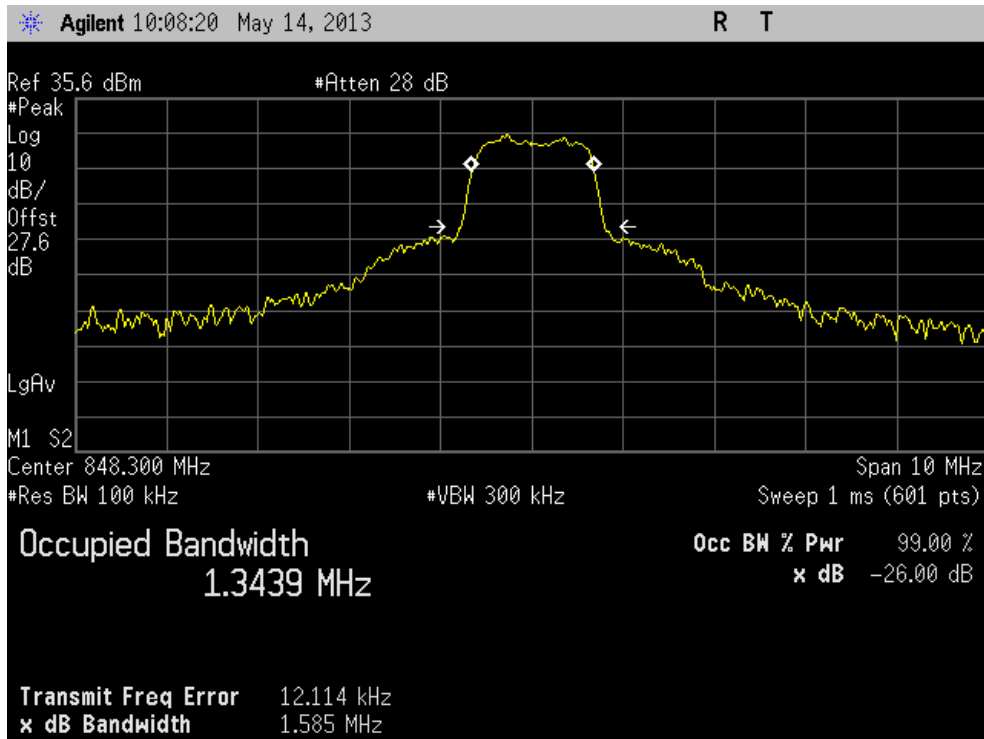

**1xEV-DO PCS Band Low Channel -26dB BW/99% OBW**

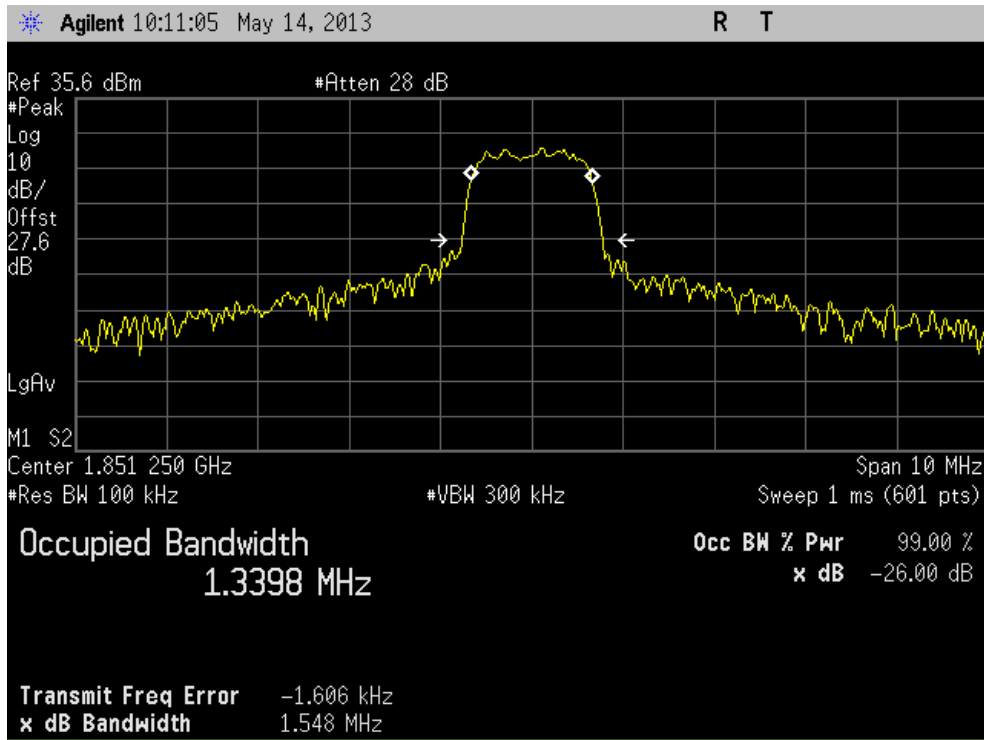

**1xEV-DO PCS Band Mid Channel -26dB BW/99% OBW**

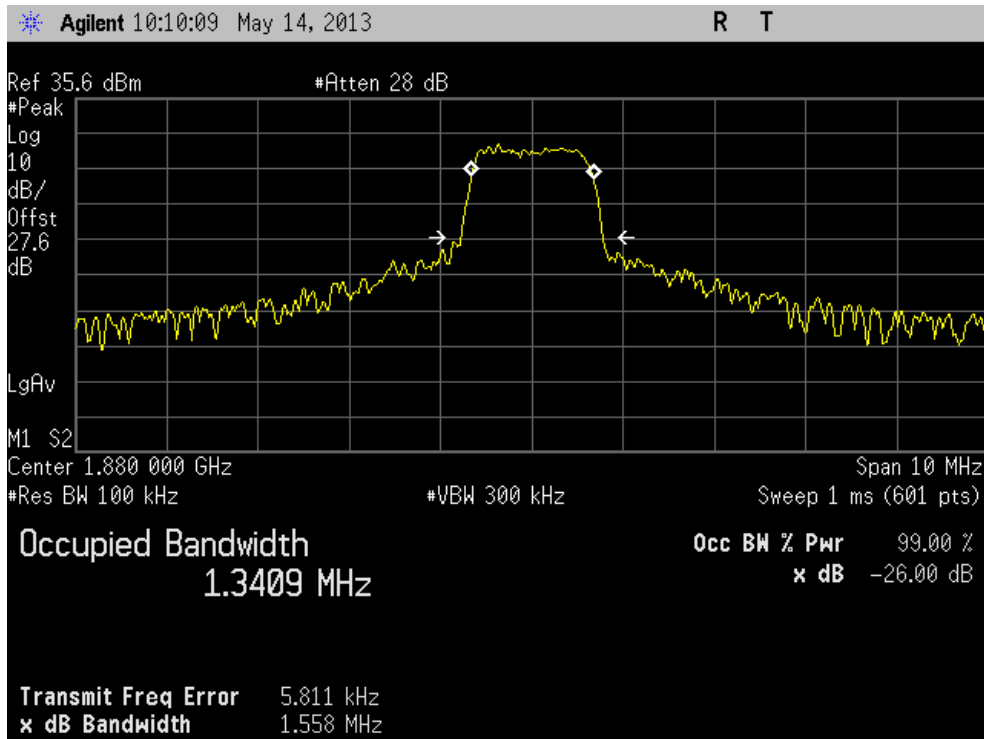

**1xEV-DO PCS Band High Channel -26dB BW/99% OBW**

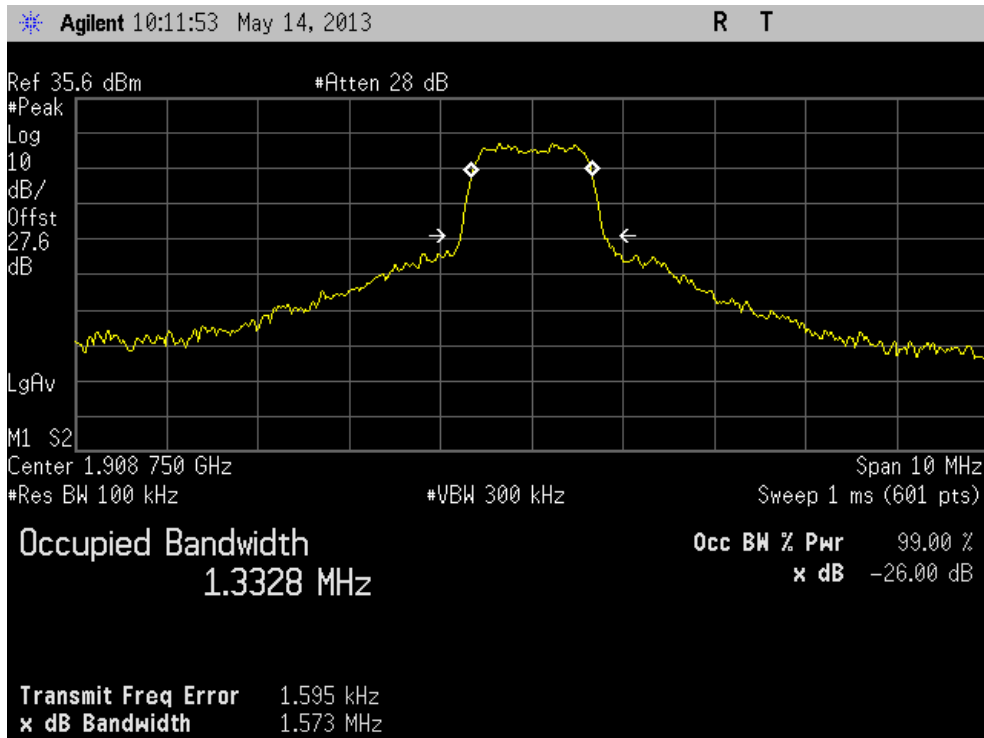



## **2.5 PEAK-AVERAGE RATIO**

### **2.5.1 Specification Reference**

Part 24 Subpart E §24.232(d)

### **2.5.2 Standard Applicable**

Power measurements for transmissions by stations authorized under this section may be made either in accordance with a Commission-approved average power technique or in compliance with paragraph (e) of this section. In both instances, equipment employed must be authorized in accordance with the provisions of §24.51. In measuring transmissions in this band using an average power technique, the peak-to-average ratio (PAR) of the transmission may not exceed 13 dB

### **2.5.3 Equipment Under Test and Modification State**

Serial No: 20130418001833 and 20130418001829 / Test Configuration B

### **2.5.4 Date of Test/Initial of test personnel who performed the test**

May 14, 2013/FSC

### **2.5.5 Test Equipment Used**

The major items of test equipment used for the above tests are identified in Section 3.1.

### **2.5.6 Environmental Conditions**

Ambient Temperature	25.8°C
Relative Humidity	41.7%
ATM Pressure	99.1 kPa

### **2.5.7 Additional Observations**

- This is a conducted test. Test procedure is per Section 6.0 of KDB971168 (D01 Power Meas License Digital Systems v01). Appropriate offset (line losses) applied.
- Measurement was done using the Spectrum Analyzer's Complementary Cumulative Distribution Function (CCDF) measurement profile. The built-in function is used to determine the largest deviation between the average and the peak power of the EUT in a given bandwidth (crest factor or peak-to-average ratio) The CCDF curve shows how much time the peak waveform spends at or above a given average power level. The percent of time the signals spends at or above the level defines the probability for that particular power level.
- All channels based from worst case configuration were verified.
- There are no measured PAR levels greater than 13dB. EUT complies.

### **2.5.8 Test Results**

See attached plots.

**CDMA2000-1xRTT PCS Band Low Channel -PAR**

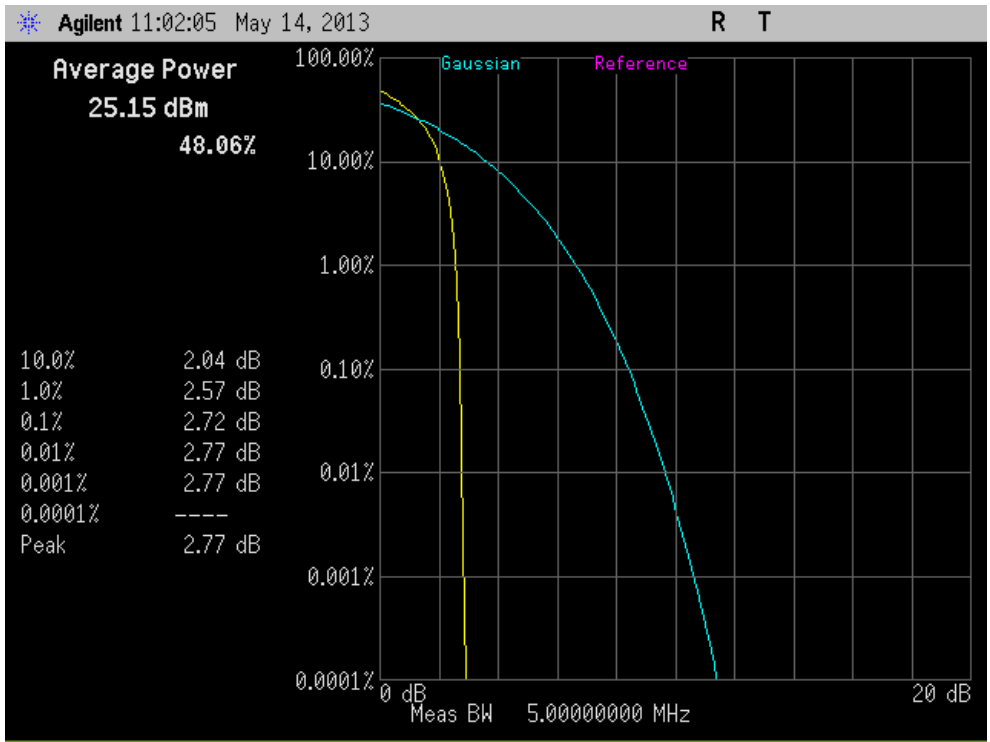

**CDMA2000-1xRTT PCS Band Mid Channel -PAR**

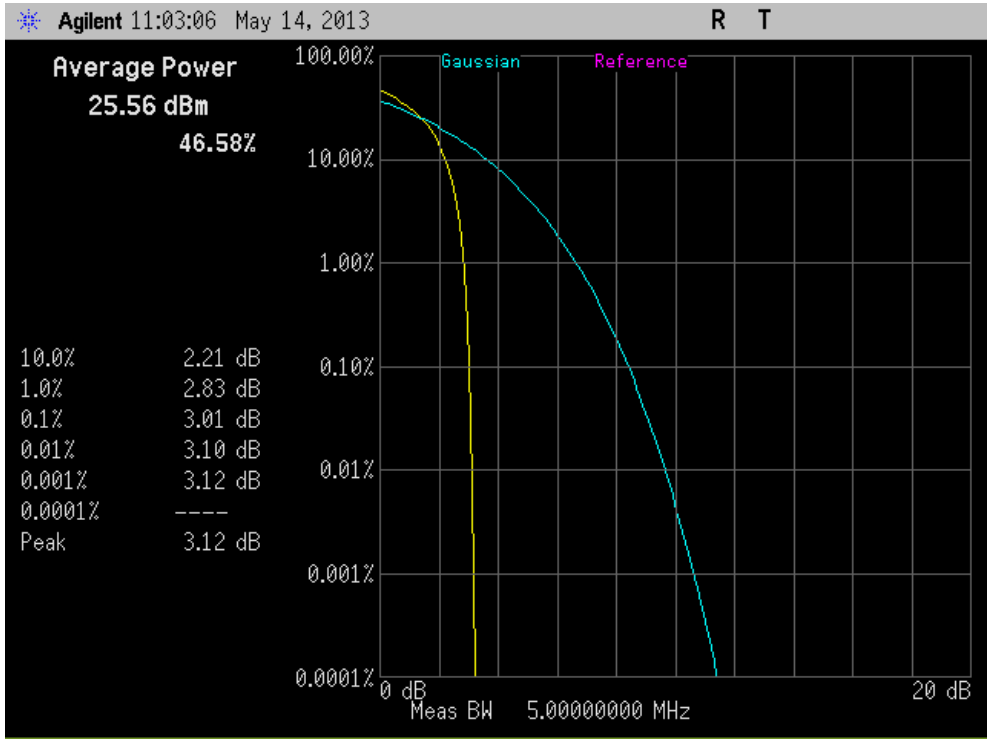

**CDMA2000-1xRTT PCS Band High Channel -PAR**

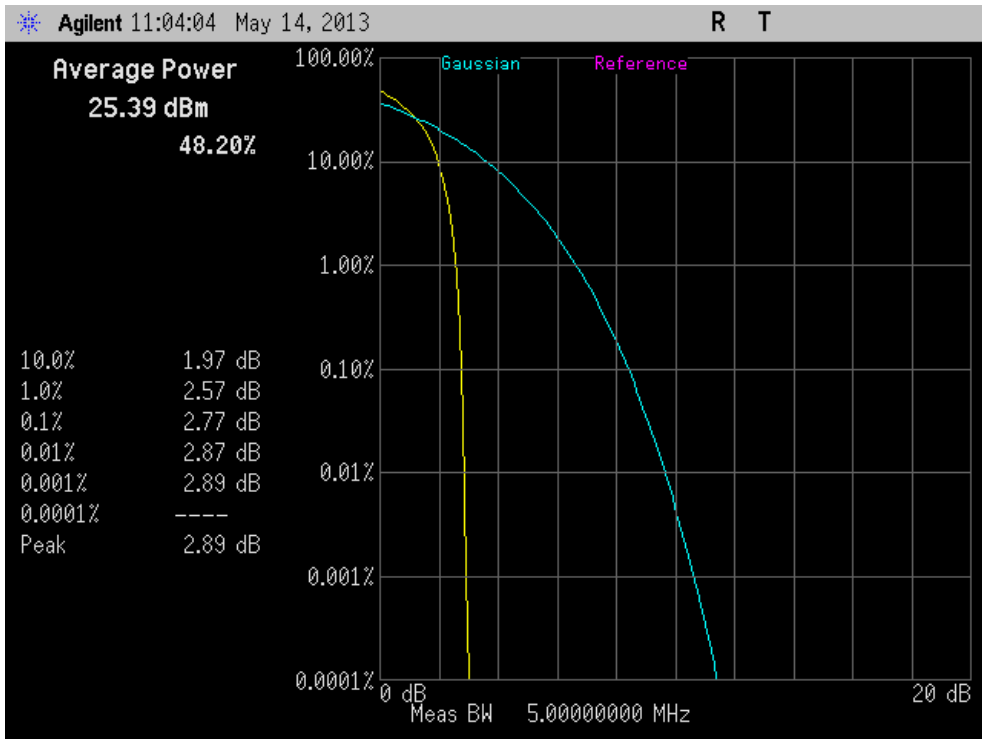

**1xEV-DO PCS Band Low Channel -PAR**





**1xEV-DO PCS Band Mid Channel -PAR**

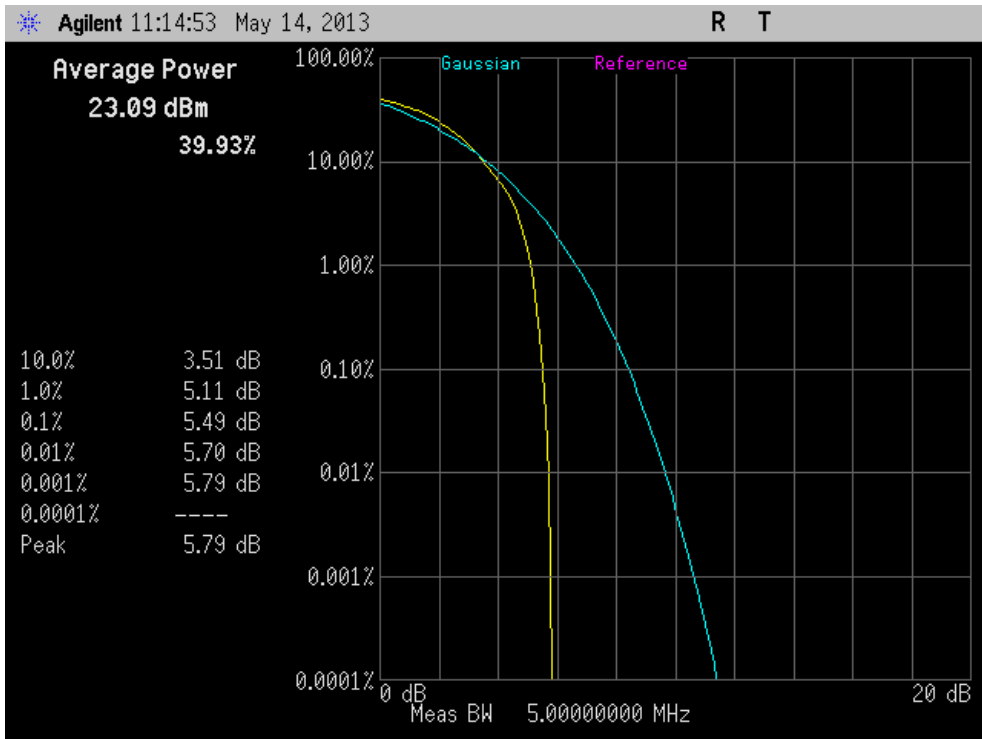

**1xEV-DO PCS Band High Channel -PAR**

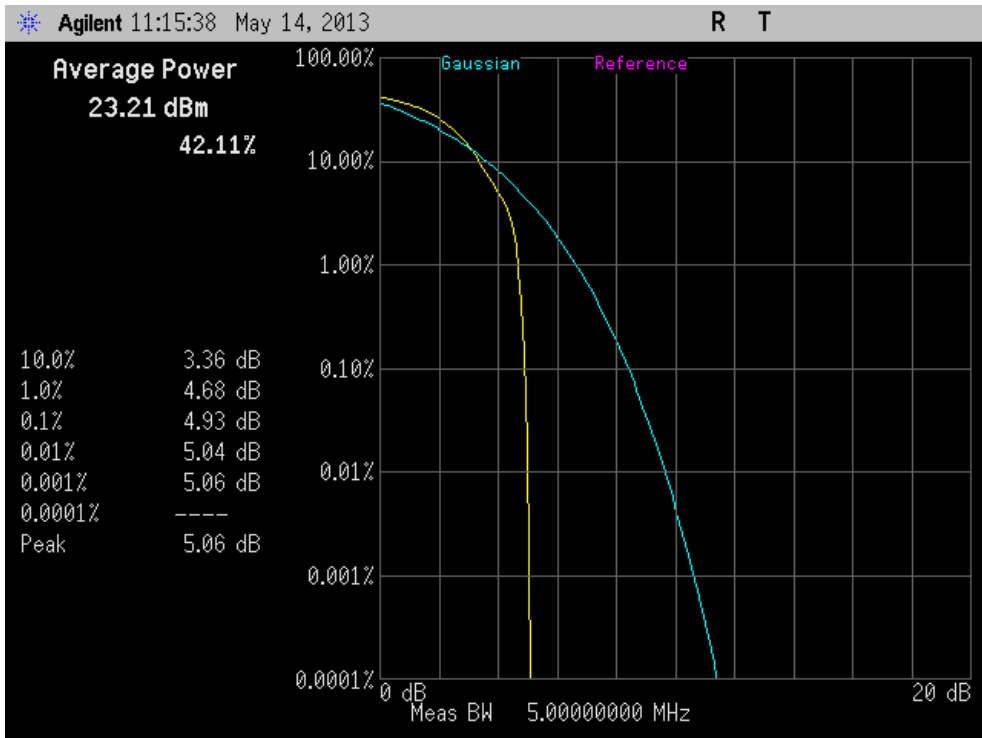





## **2.6 BAND EDGE/CONDUCTED SPURIOUS EMISSIONS**

### **2.6.1 Specification Reference**

Part 22 Subpart H §22.917(a) and Part 24 Subpart E §24.238(a)

### **2.6.2 Standard Applicable**

Out of band emissions. The power of any emission outside of the authorized operating frequency ranges must be attenuated below the transmitting power (P) by a factor of at least  $43 + 10 \log(P)$  dB.

### **2.6.3 Equipment Under Test and Modification State**

Serial No: 20130418001833 and 20130418001829 / Test Configuration B

### **2.6.4 Date of Test/Initial of test personnel who performed the test**

May 14 and 16, 2013/FSC

### **2.6.5 Test Equipment Used**

The major items of test equipment used for the above tests are identified in Section 3.1.

### **2.6.6 Environmental Conditions**

Ambient Temperature	23.0-25.8°C
Relative Humidity	41.7-49.3%
ATM Pressure	99.0-99.1 kPa

### **2.6.7 Additional Observations**

- This is a conducted test.
- The 27.6dB offset is from the power splitter, external attenuator and cable used.
- For PCS band edge measurements, set RBW to 1% of the span or greater.
- Band power was integrated over 1% of EBW for cellular band edge measurements.
- For both band edge and out of band emissions, set the limit to -13dBm.
- Only worst case configuration for all technologies presented in this test report.

### **2.6.8 Test Results**

See attached plots.



**CDMA2000 Cell Band Edge @ 824MHz**

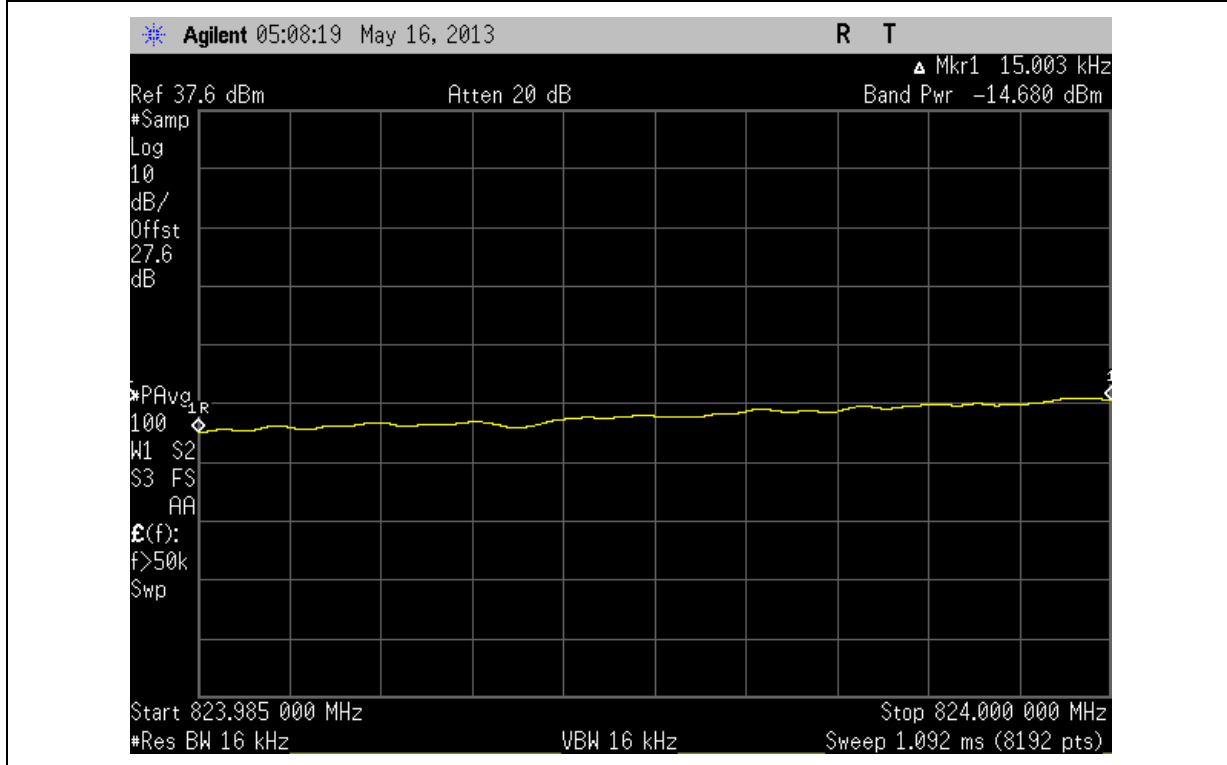

**CDMA2000 Cell Band Edge @ 849MHz**

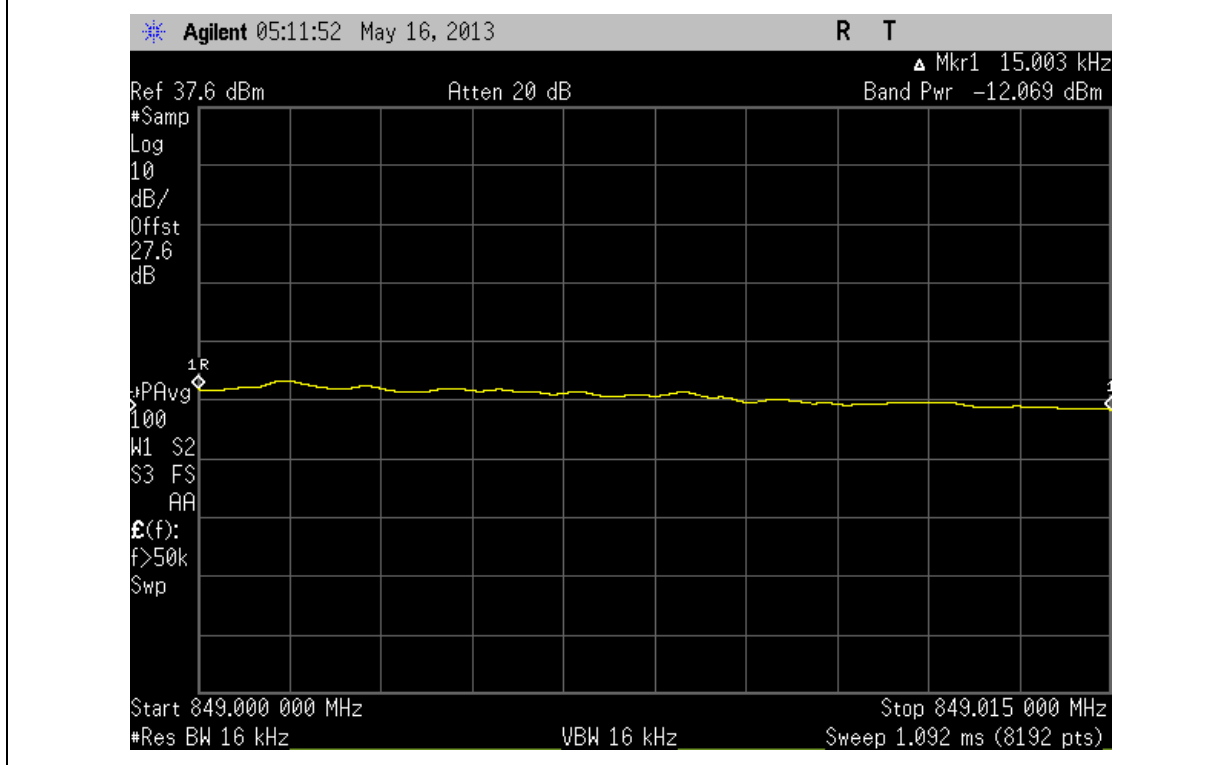

**CDMA2000 Cell Low Channel 30MHz to 20GHz Conducted Spurious Plot**

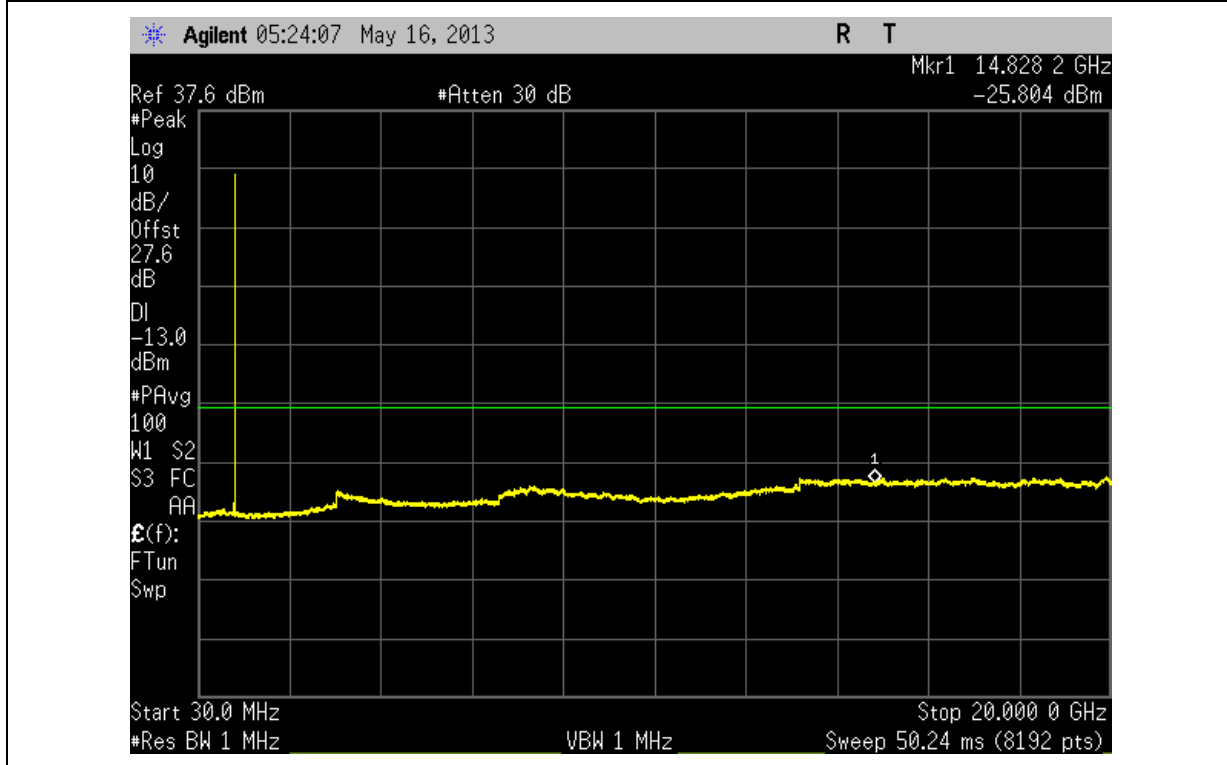

**CDMA2000 Cell Mid Channel 30MHz to 20GHz Conducted Spurious Plot**

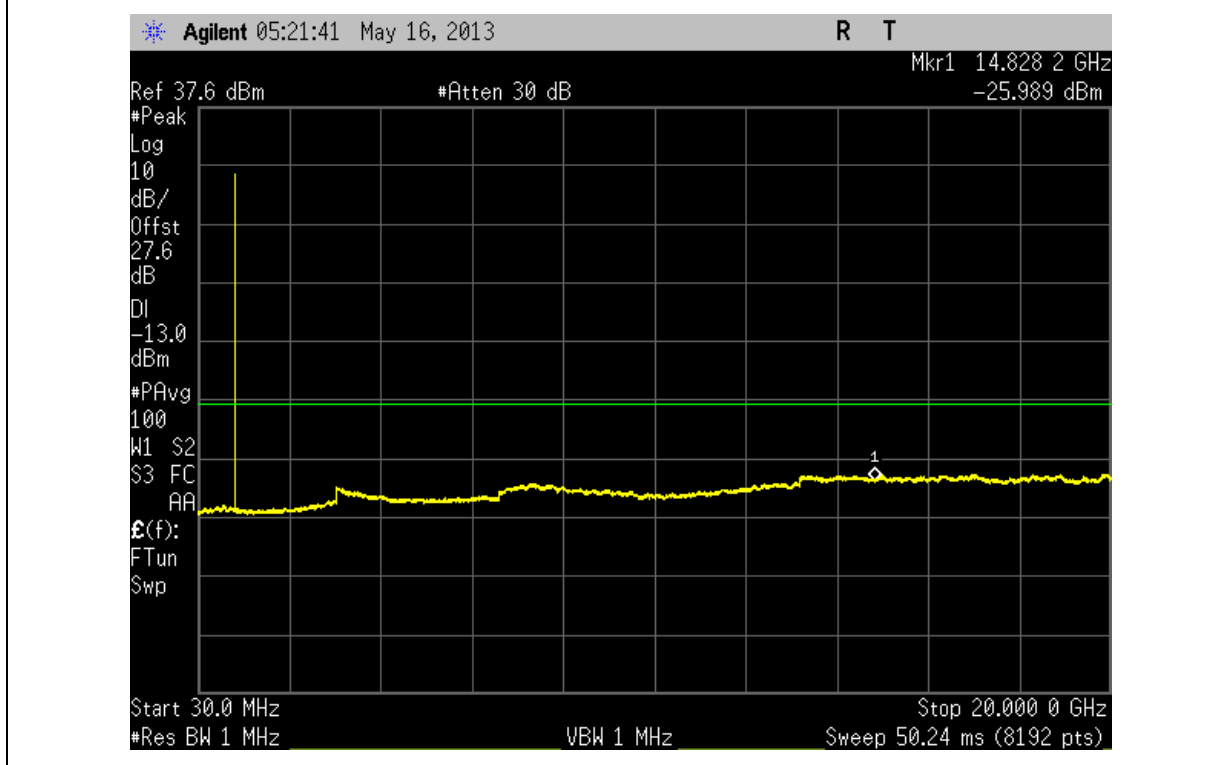

**CDMA2000 Cell High Channel 30MHz to 20GHz Conducted Spurious Plot**

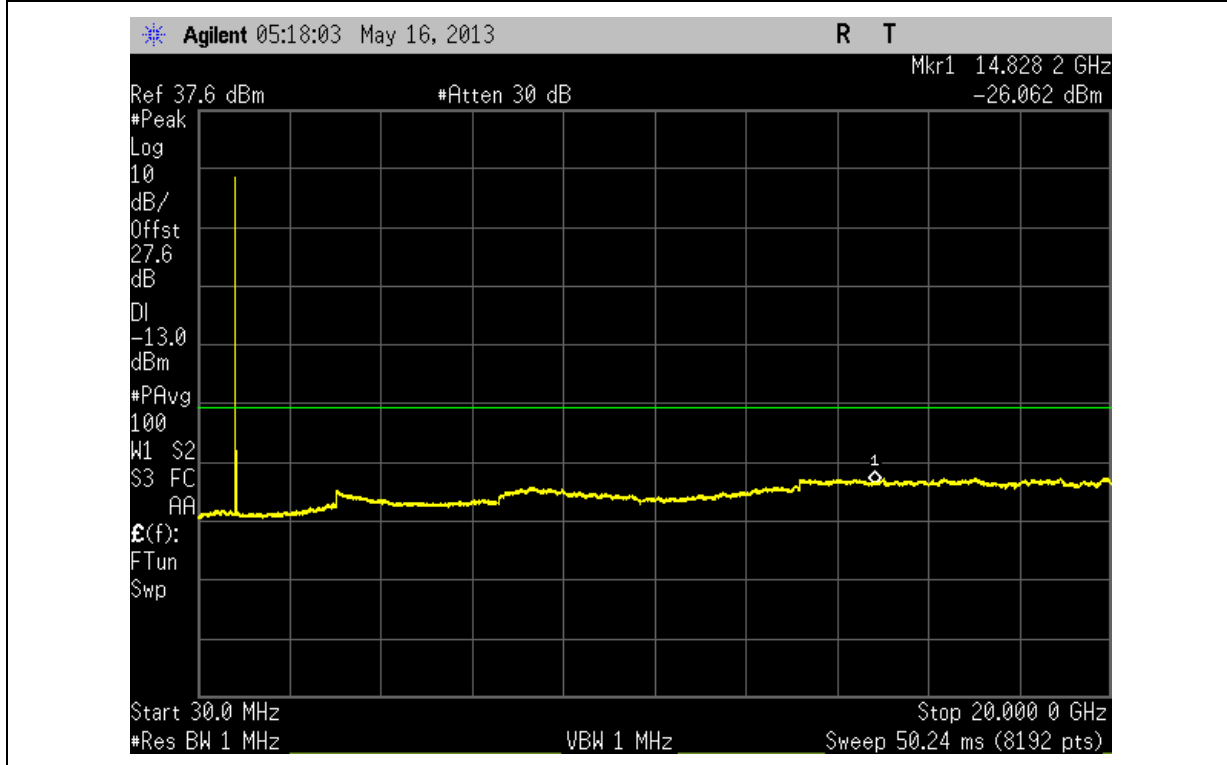

**CDMA2000 PCS Band Edge @ 1850MHz**

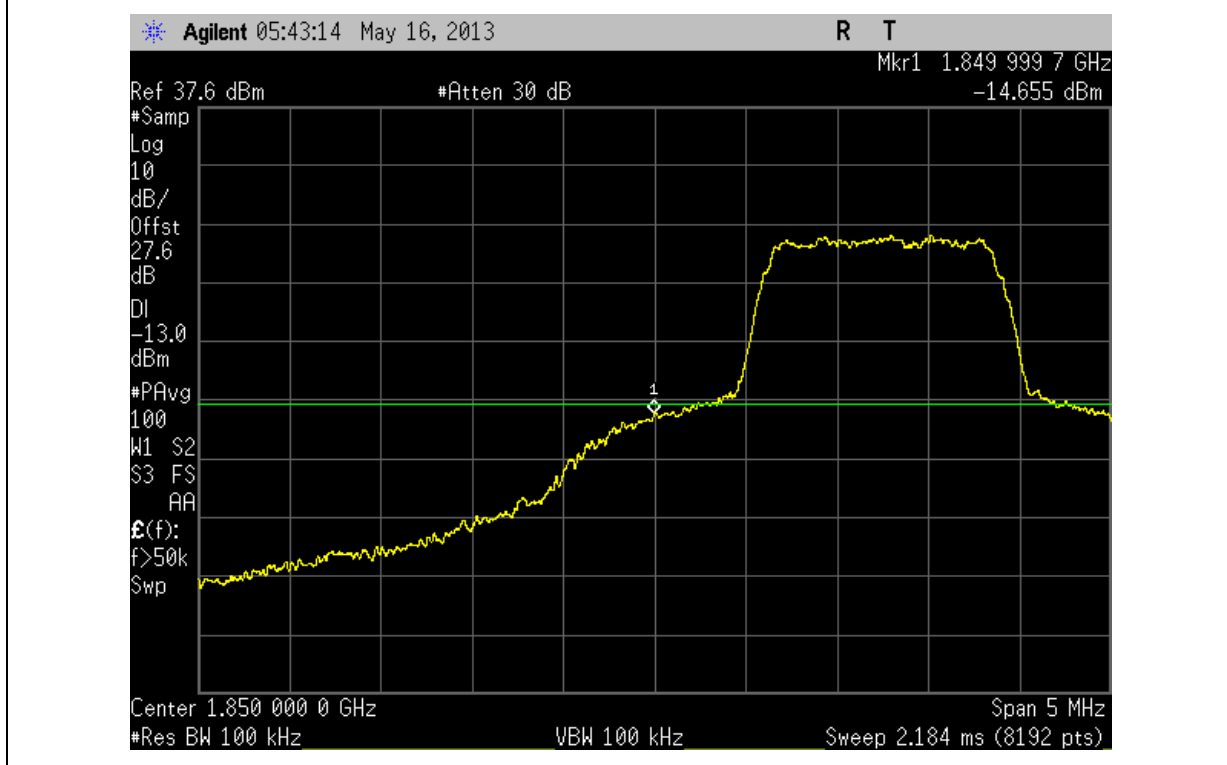

CDMA2000 PCS Band Edge @ 1910MHz

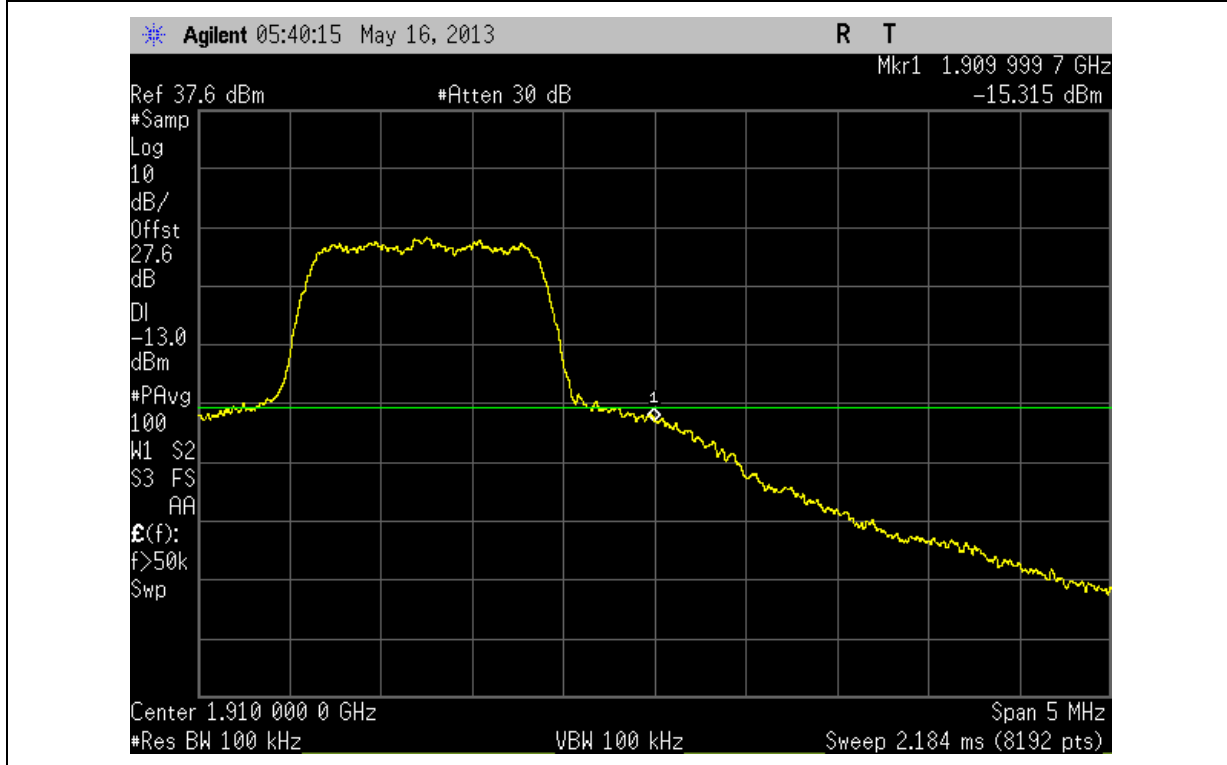

CDMA2000 PCS Low Channel 30MHz to 20GHz Conducted Spurious Plot

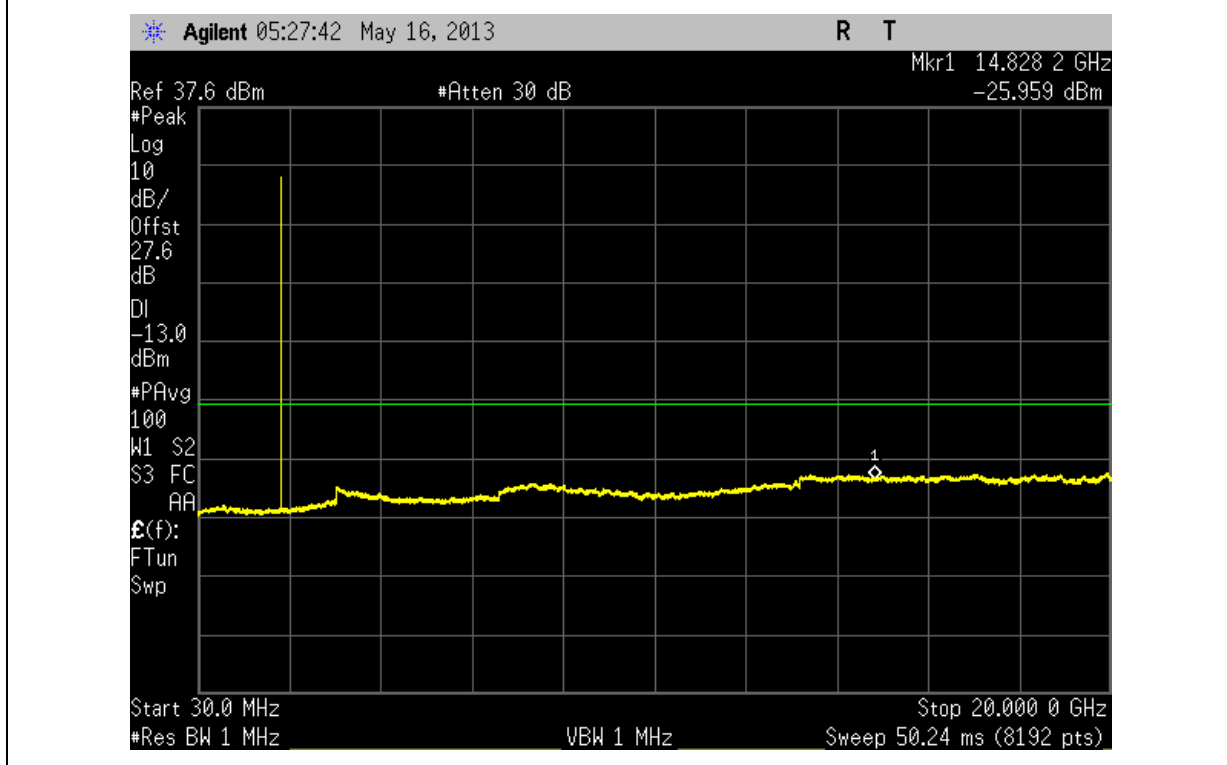

**CDMA2000 PCS Mid Channel 30MHz to 20GHz Conducted Spurious Plot**

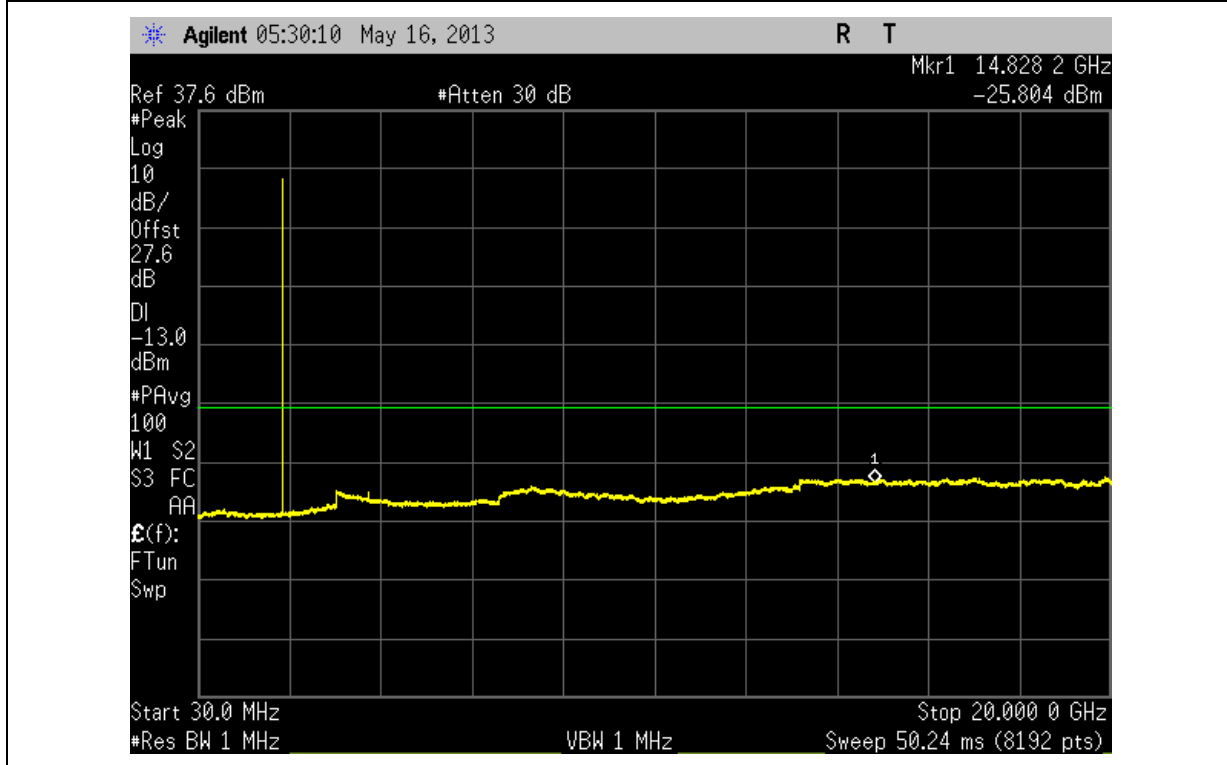

**CDMA2000 PCS High Channel 30MHz to 20GHz Conducted Spurious Plot**

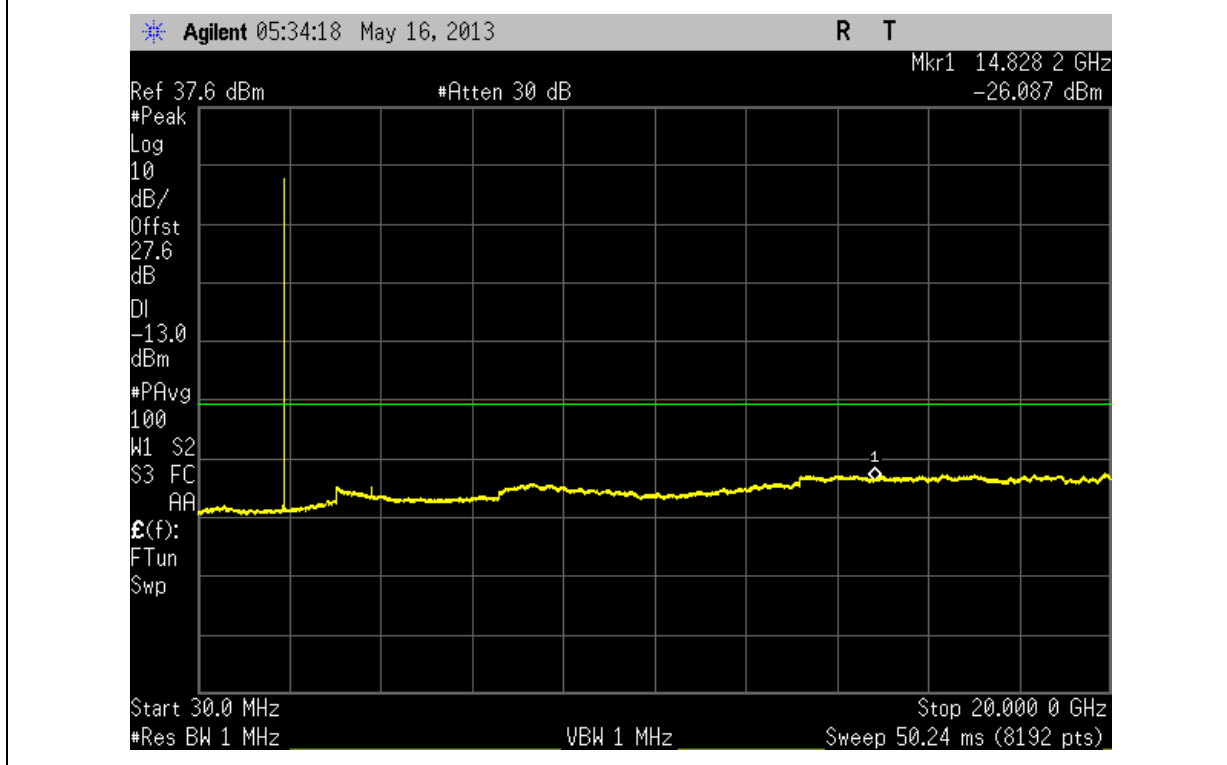



1xEV-DO Cell Band Edge @ 824MHz

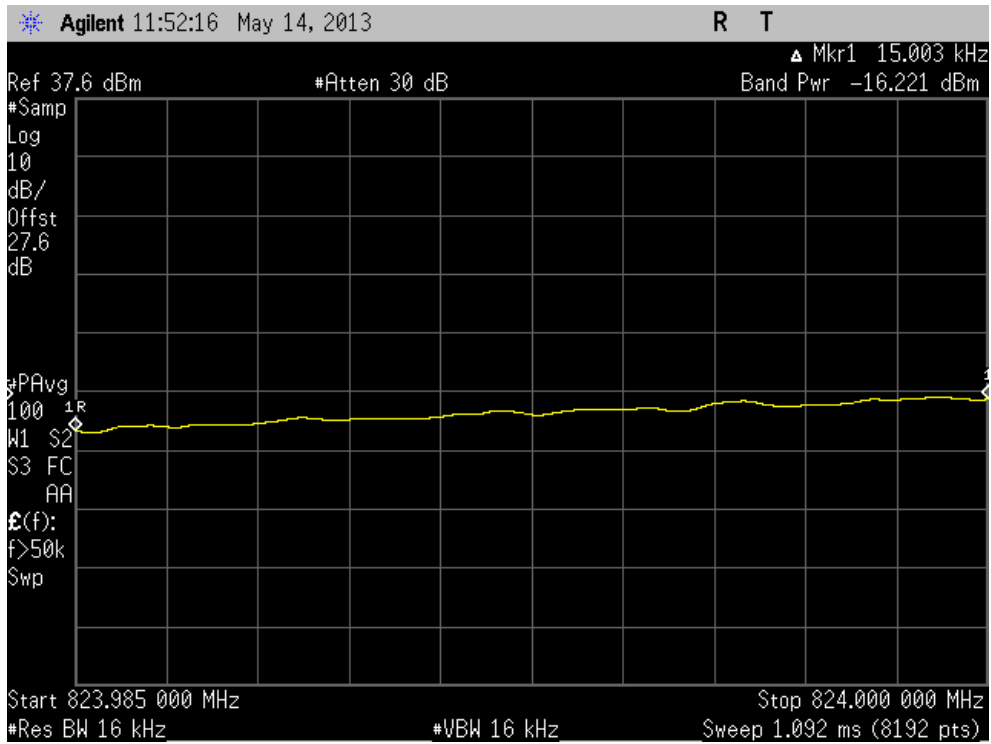

1xEvDO Cell Band Edge @ 849MHz

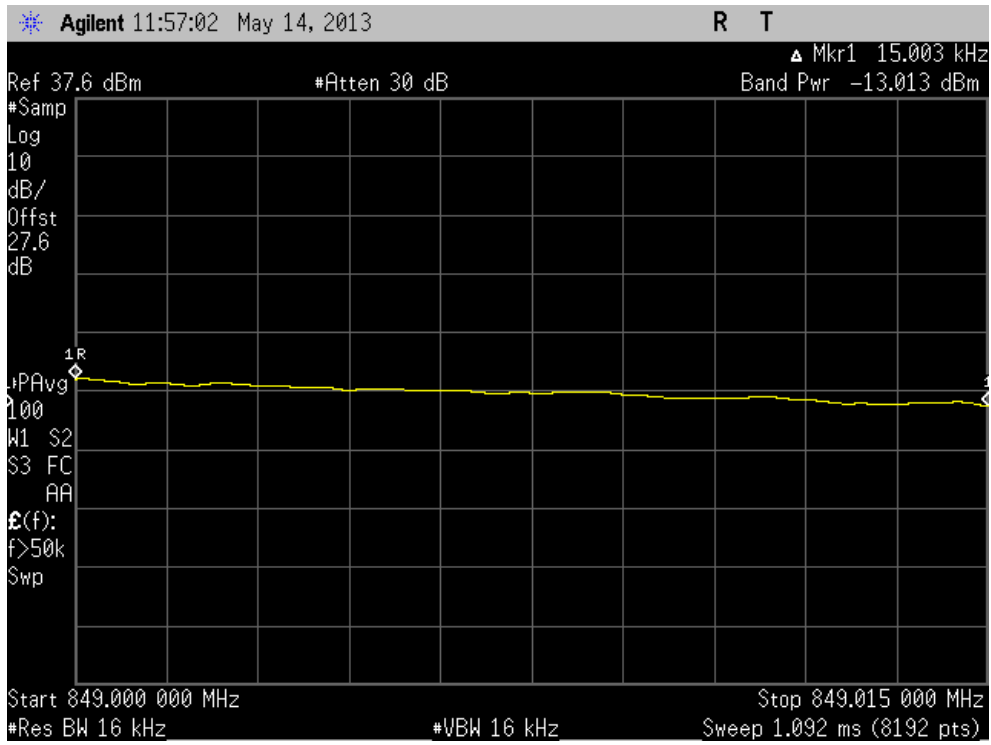



**1xEV-DO Cell Low Channel 30MHz to 20GHz Conducted Spurious Plot**

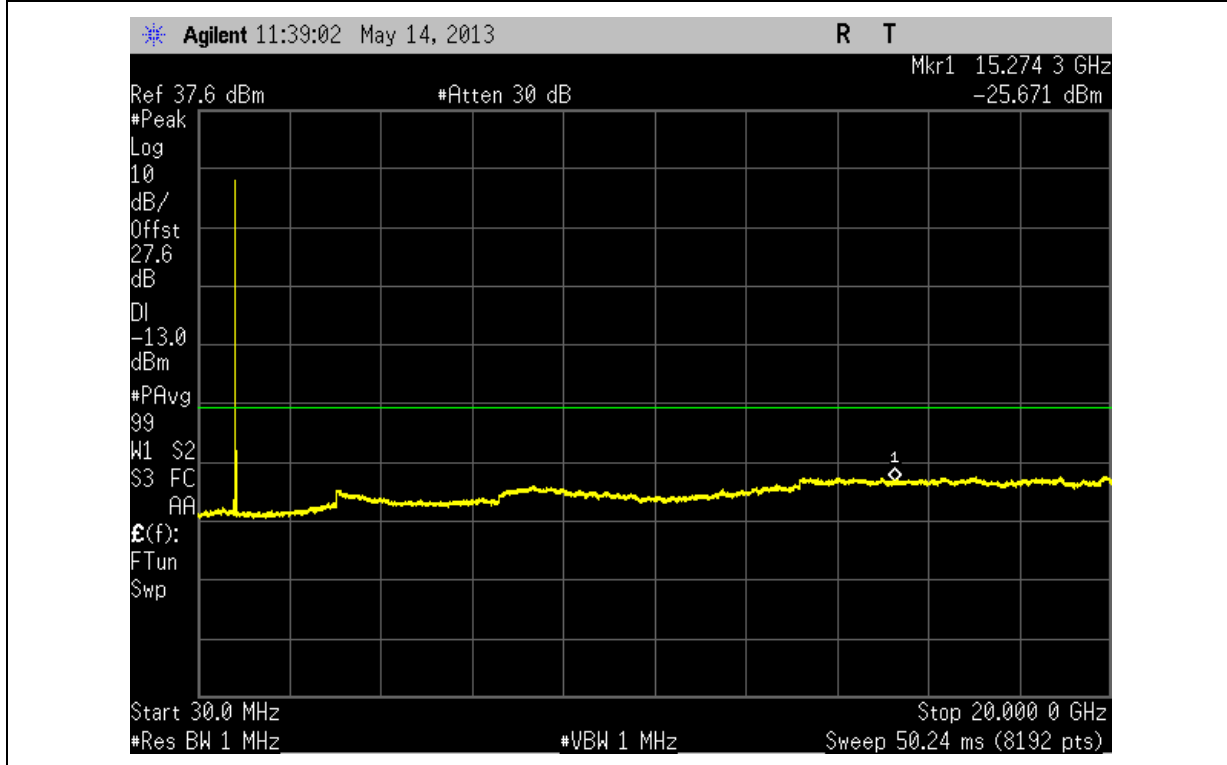

**1xEV-DO Cell Mid Channel 30MHz to 20GHz Conducted Spurious Plot**

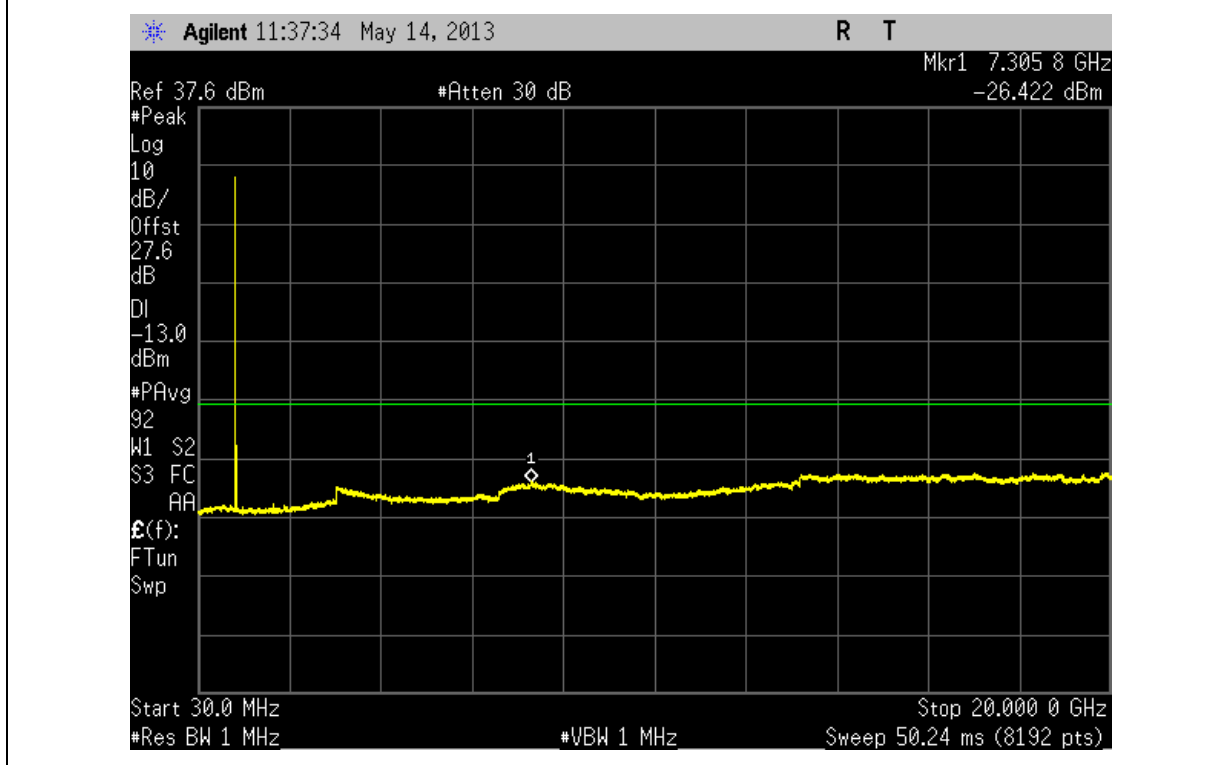





**1xEV-DO Cell High Channel 30MHz to 20GHz Conducted Spurious Plot**

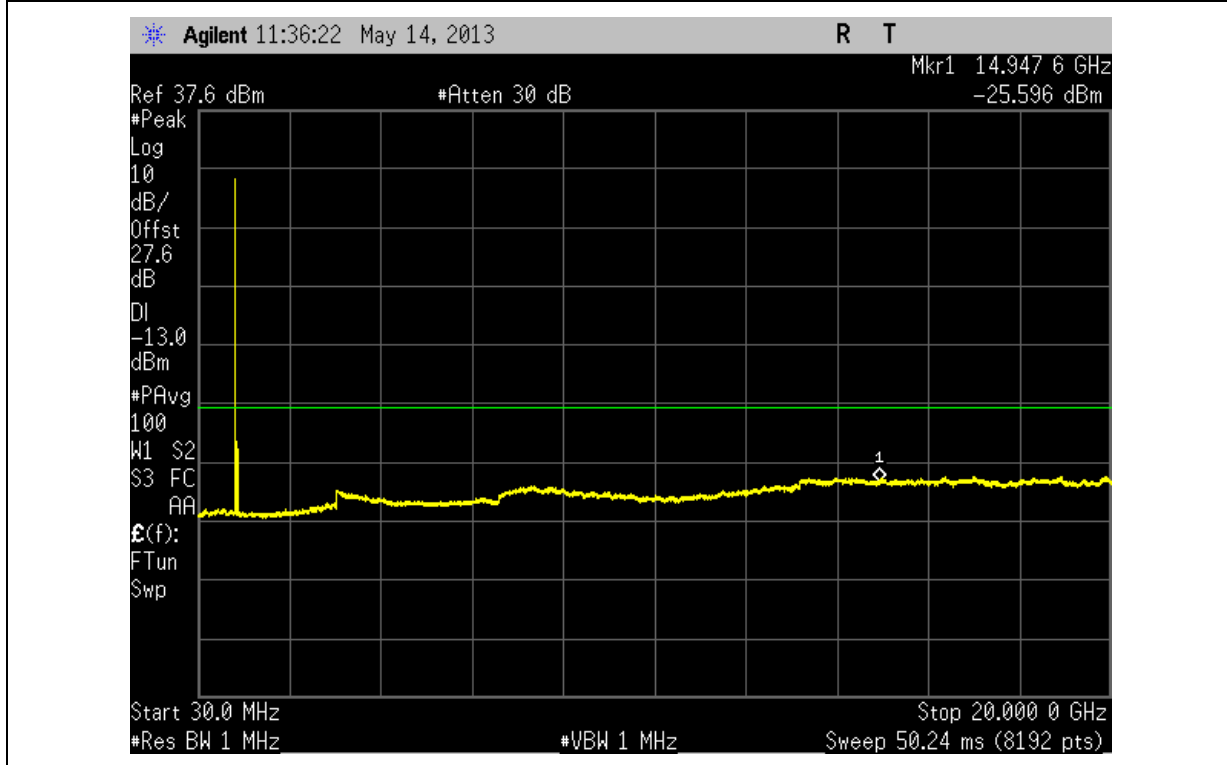

**1xEV-DO PCS Band Edge @ 1850MHz**

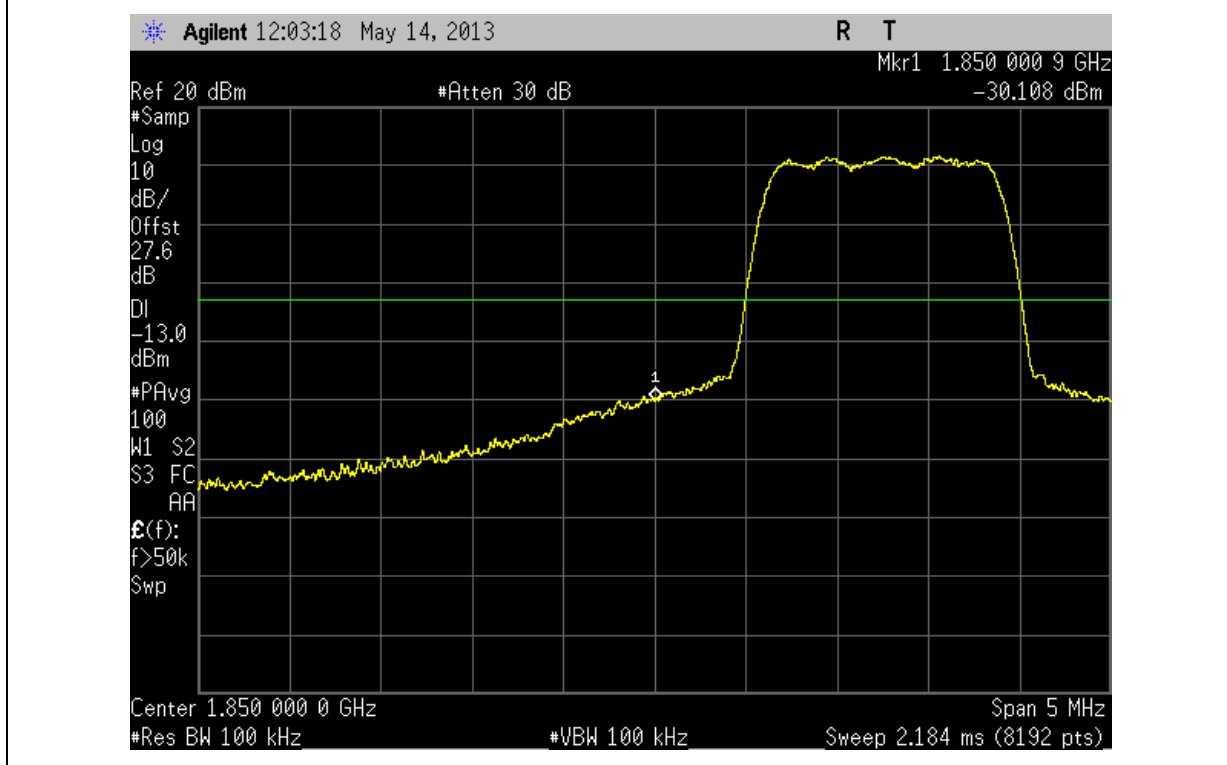

**1xEV-DO PCS Band Edge @ 1910MHz**

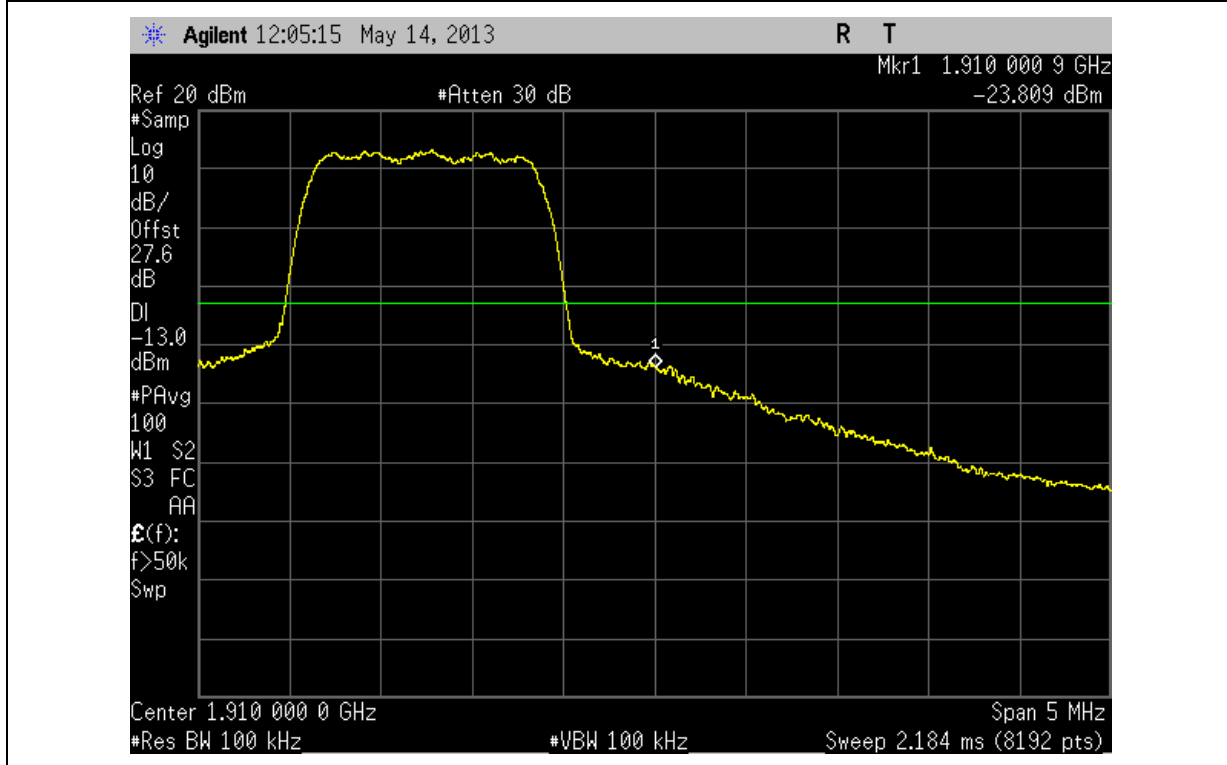

**1xEV-DO PCS Low Channel 30MHz to 20GHz Conducted Spurious Plot**

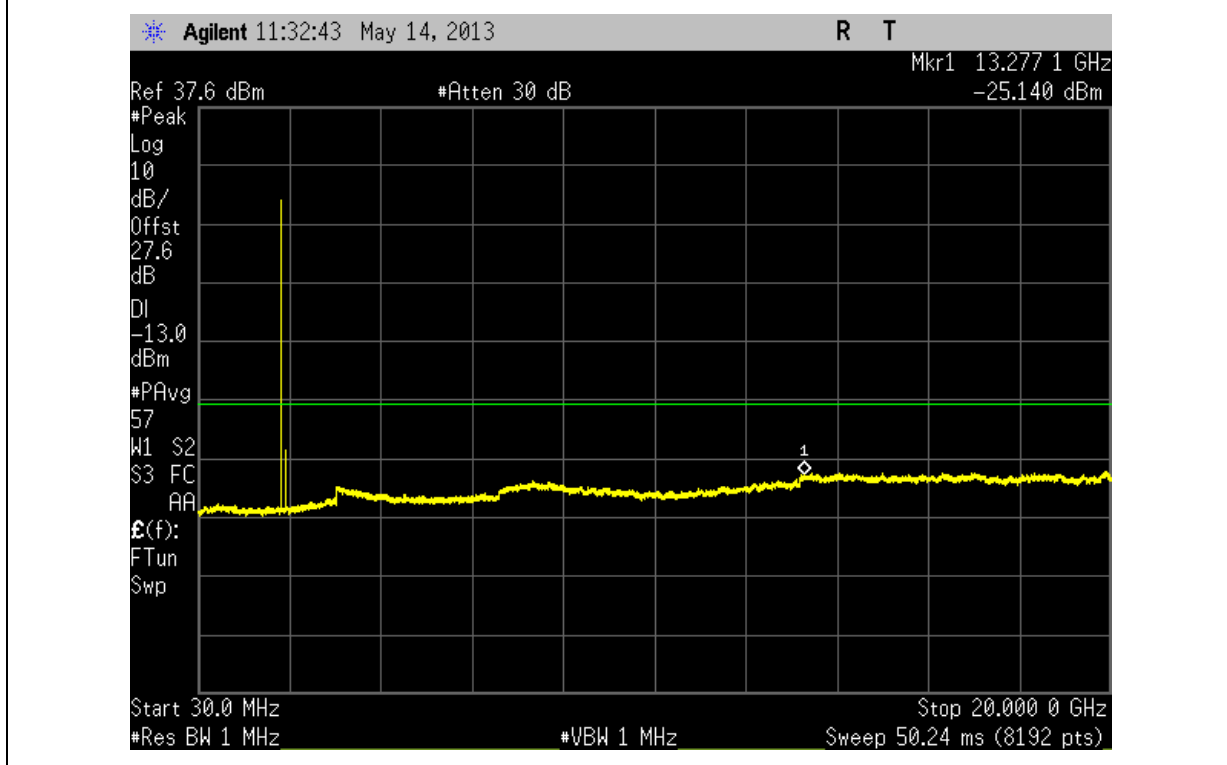

**1xEV-DO PCS Mid Channel 30MHz to 20GHz Conducted Spurious Plot**

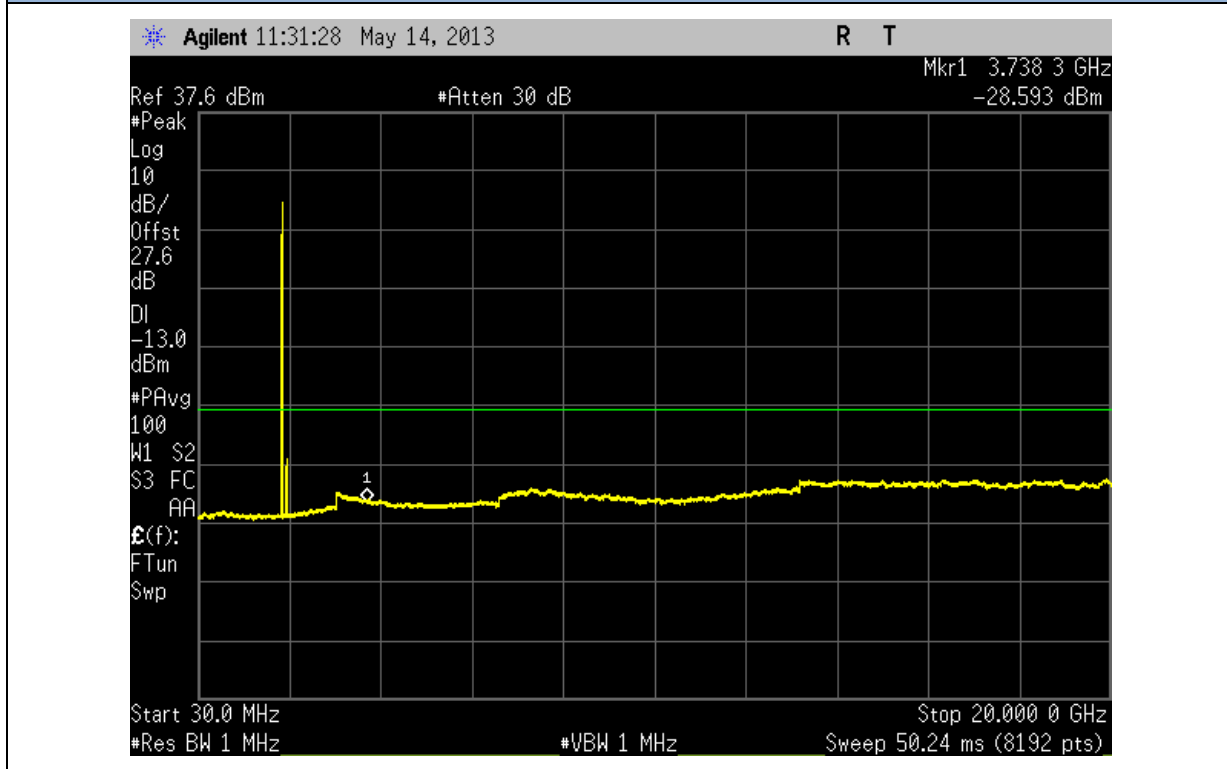

**1xEV-DO PCS High Channel 30MHz to 20GHz Conducted Spurious Plot**

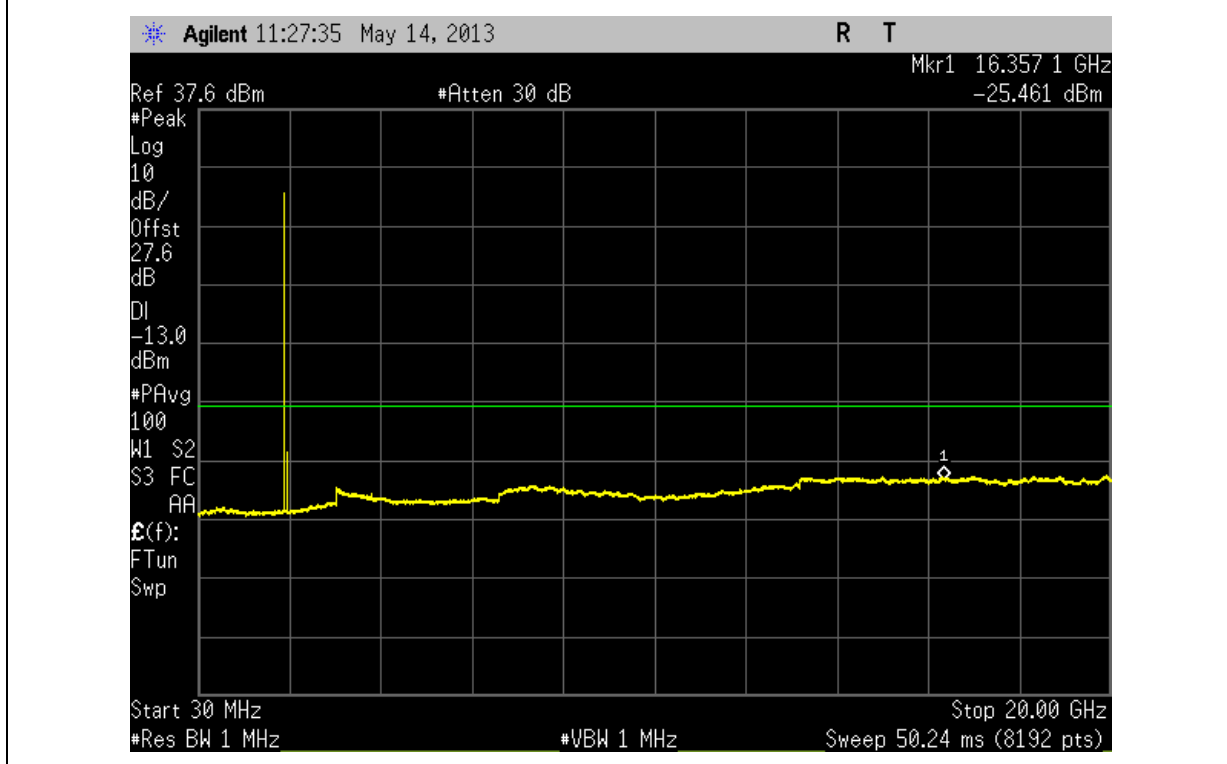



## **2.7 FIELD STRENGTH OF SPURIOUS RADIATION**

### **2.7.1 Specification Reference**

Part 22 Subpart H §22.917(a) and Part 24 Subpart E §24.238(a)

### **2.7.2 Standard Applicable**

Out of band emissions. The power of any emission outside of the authorized operating frequency ranges must be attenuated below the transmitting power (P) by a factor of at least  $43 + 10 \log(P)$  dB.

### **2.7.3 Equipment Under Test and Modification State**

Serial No: 20130418001833 and 20130418001829 / Test Configuration A

### **2.7.4 Date of Test/Initial of test personnel who performed the test**

May 15, 2013/FSC

### **2.7.5 Test Equipment Used**

The major items of test equipment used for the above tests are identified in Section 3.1.

### **2.7.6 Environmental Conditions**

Ambient Temperature	25.6 °C
Relative Humidity	42.7 %
ATM Pressure	99.2 kPa

### **2.7.7 Additional Observations**

- This is a radiated test using substitution method as per Unwanted Emissions: Radiated Spurious method of measurement of ANSI/TIA/EIA-603-C 2004, August 17, 2004.
- Only the worst case configuration presented in this test report.
- Measurement was done using EMC32 V8.53 automated software. Reported level is the actual level with all the correction factors factored in. Correction Factor column is for informational purposes only.

### **2.7.8 Test Results**

See attached plots.



**2.7.9 Test Results Below 1GHz (CDMA2000 Worst Case Configuration)**

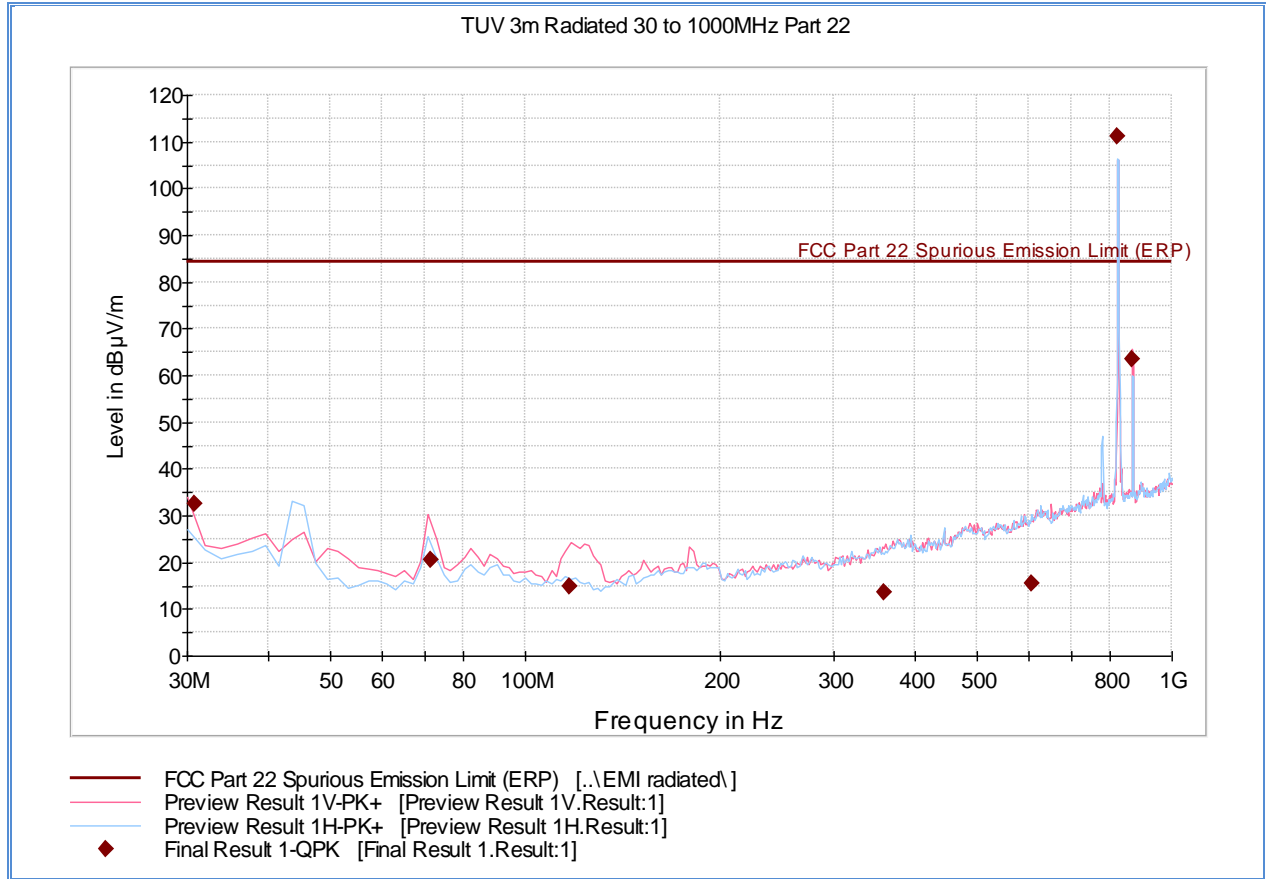

**Quasi Peak Data**

Frequency (MHz)	QuasiPeak (dBµV/m)	Meas. Time (ms)	Bandwidth (kHz)	Height (cm)	Polarization	Azimuth (deg)	Corr. (dB)	Margin (dB)	Limit (dBµV/m)
30.840000	32.4	1000.0	120.000	100.0	V	180.0	-12.1	52.0	84.4
71.501643	20.7	1000.0	120.000	100.0	V	37.0	-21.7	63.7	84.4
117.274950	15.0	1000.0	120.000	114.0	V	70.0	-20.2	69.4	84.4
358.780922	13.5	1000.0	120.000	137.0	V	15.0	-9.8	70.9	84.4
606.950782	15.4	1000.0	120.000	100.0	H	177.0	-4.6	69.0	84.4
824.770100	111.0	1000.0	120.000	100.0	H	202.0	-1.1	Fundamental	
869.679519	63.5	1000.0	120.000	184.0	V	266.0	-0.9	20.9	84.4

**Test Notes:** Only worst case channel presented for spurious emissions below 1GHz. Only case spurious emissions within 20db of the calculated limit will be proven by substitution method.



**2.7.10 Test Results Below 1GHz (1xEV-DO Worst Case Configuration)**

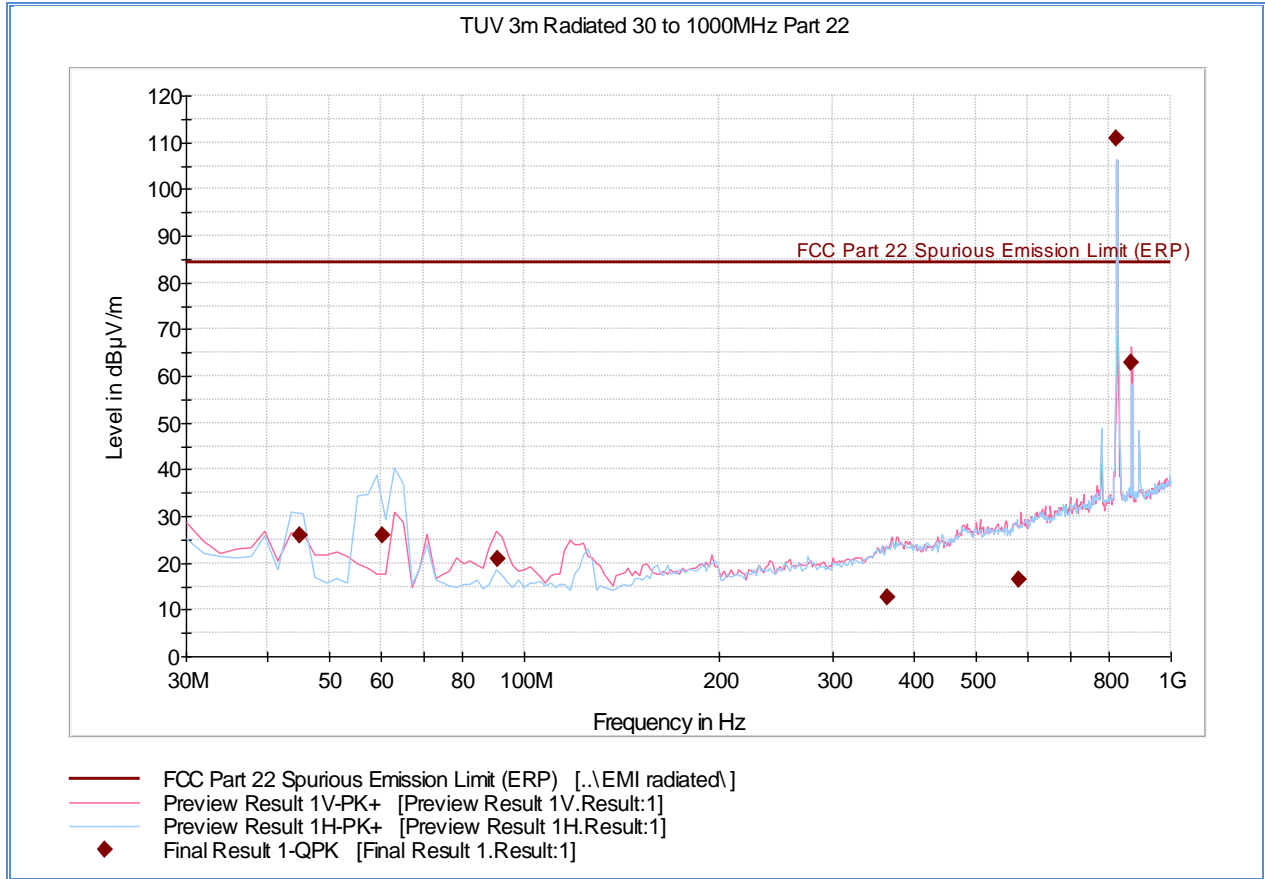

**Quasi Peak Data**

Frequency (MHz)	QuasiPeak (dBµV/m)	Meas. Time (ms)	Bandwidth (kHz)	Height (cm)	Polarization	Azimuth (deg)	Corr. (dB)	Margin (dB)	Limit (dBµV/m)
45.007214	25.8	1000.0	120.000	100.0	H	1.0	-18.7	58.5	84.4
60.406092	26.0	1000.0	120.000	100.0	H	340.0	-21.3	58.4	84.4
91.180521	20.8	1000.0	120.000	100.0	V	268.0	-20.3	63.6	84.4
363.564810	12.5	1000.0	120.000	114.0	V	280.0	-9.6	71.8	84.4
583.351904	16.5	1000.0	120.000	100.0	V	287.0	-5.7	67.8	84.4
824.970100	110.9	1000.0	120.000	100.0	H	202.0	-1.1	Fundamental	
869.199519	62.9	1000.0	120.000	100.0	V	265.0	-0.8	21.5	84.4

**Test Notes:** Only worst case channel presented for spurious emissions below 1GHz. Only case spurious emissions within 20db of the calculated limit will be proven by substitution method.



**2.7.11 Test Results Above 1GHz (CDMA2000 Cellular Low Channel)**

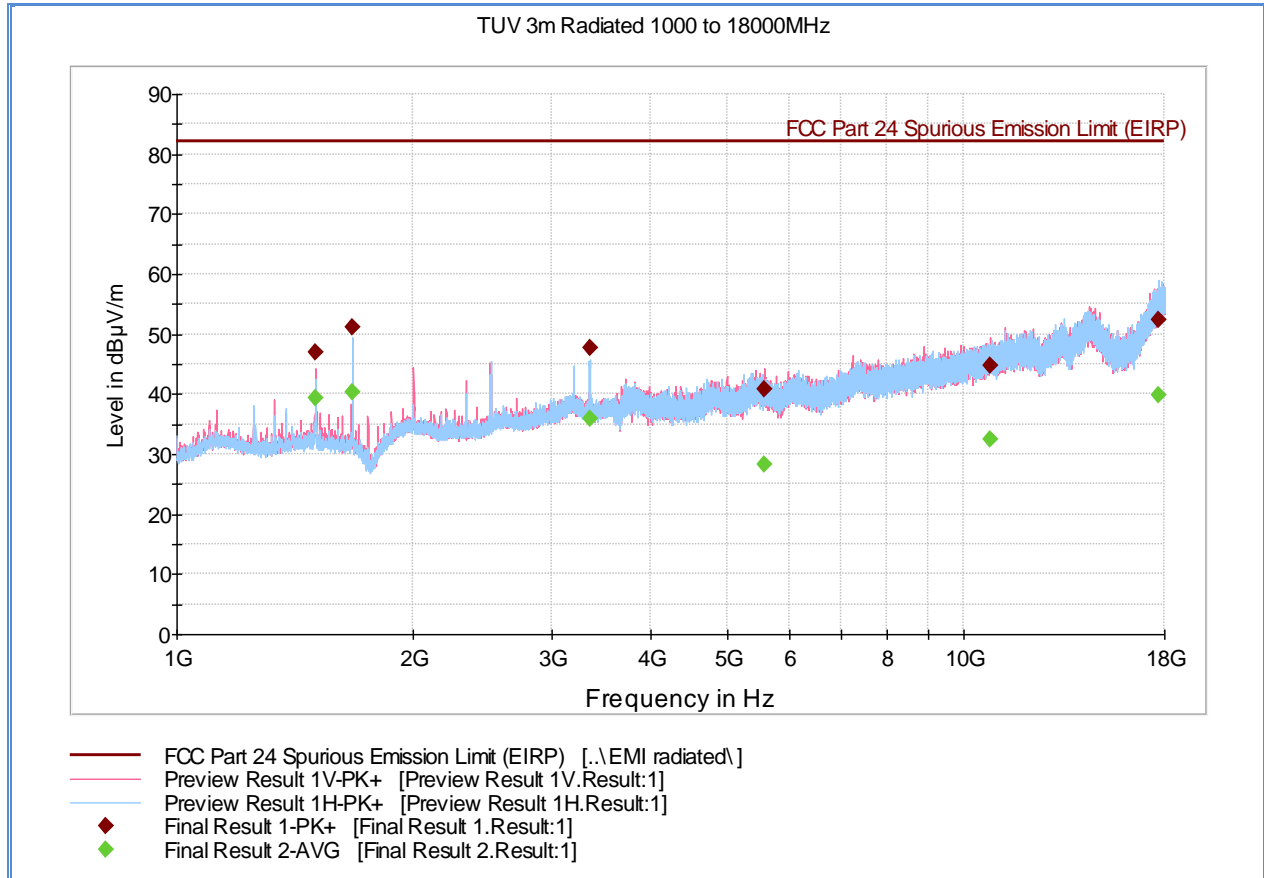

**Peak Data**

Frequency (MHz)	MaxPeak (dBµV/m)	Meas. Time (ms)	Bandwidth (kHz)	Height (cm)	Polarization	Azimuth (deg)	Corr. (dB)	Margin (dB)	Limit (dBµV/m)
1500.140000	49.7	1000.0	1000.000	99.8	V	28.0	-5.1	34.7	84.4
1649.413333	55.1	1000.0	1000.000	133.8	H	115.0	-3.8	29.3	84.4
3200.020000	49.3	1000.0	1000.000	156.7	H	110.0	1.4	35.1	84.4
5361.820000	44.1	1000.0	1000.000	163.7	H	326.0	6.6	40.3	84.4
10873.906667	48.3	1000.0	1000.000	140.8	H	226.0	14.2	36.1	84.4
17763.306667	55.2	1000.0	1000.000	133.8	H	89.0	22.2	29.2	84.4

**Substitution Data**

Frequency (MHz)	Field Strength @ 3 meters (dBµV/m)	Cable Loss (dB)	Substitution Antenna Gain (dBi)	Signal Generator Level (dBm)	Substitution Data SGL+AG-CL (dBm)	Limit (dBm)	Compliance

**Test Notes:** Only worst case channel presented for spurious emissions above 1GHz. Substitution data not required since margin is >20dB compared to the -13dBm limit (converted to field strength @ 3 meters). A 900 MHz high pass filter was used for this test.



**2.7.12 Test Results Above 1GHz (CDMA2000 PCS High Channel)**

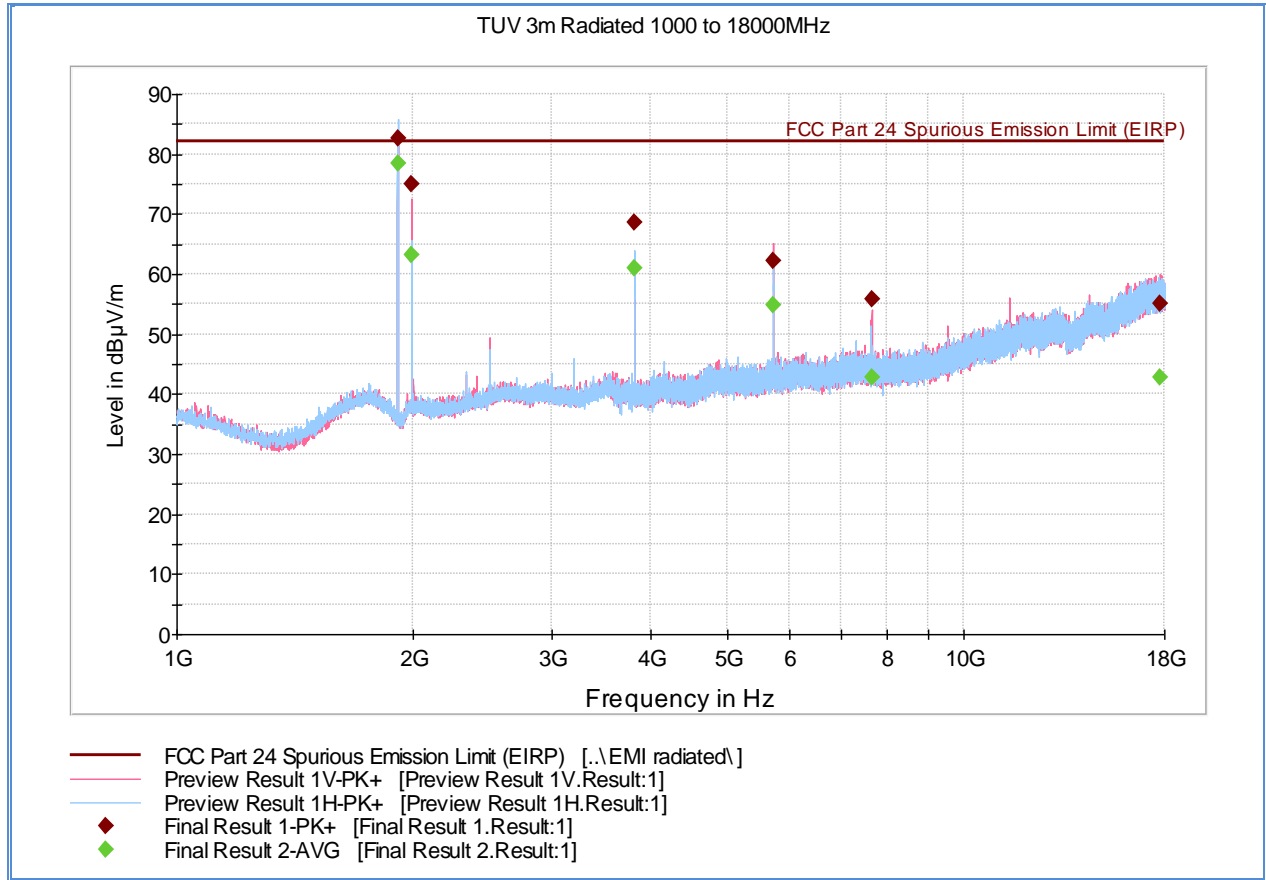

**Peak Data**

Frequency (MHz)	MaxPeak (dBµV/m)	Meas. Time (ms)	Bandwidth (kHz)	Height (cm)	Polarization	Azimuth (deg)	Corr. (dB)	Margin (dB)	Limit (dBµV/m)
1908.793333	82.7	1000.0	1000.000	113.9	H	265.0	-2.1	Fundamental	
1988.733333	74.9	1000.0	1000.000	102.8	V	352.0	-1.7	Fwd/Downlink	
3817.493333	68.7	1000.0	1000.000	119.8	H	307.0	2.9	13.5	82.2
5726.253333	62.3	1000.0	1000.000	119.8	V	220.0	7.8	19.9	82.2
7635.646667	55.7	1000.0	1000.000	383.1	V	27.0	9.5	26.5	82.2
17798.333333	55.0	1000.0	1000.000	274.3	V	286.0	22.2	27.2	82.2

**Substitution Data**

Frequency (MHz)	Field Strength @ 3 meters (dBµV/m)	Cable Loss (dB)	Substitution Antenna Gain (dBi)	Signal Generator Level (dBm)	Substitution Data SGL+AG-CL (dBm)	Limit (dBm)	Compliance
3817.493333	68.7	-3.8	9.195	-32	-26.605	-13	Complies
5726.253333	62.3	-6.1	11.518	-38	-32.582	-13	Complies

**Test Notes:** Only worst case channel presented for spurious emissions above 1GHz. 1908.75 MHz is the uplink frequency while 1988.75 MHz is the downlink frequency. A 2.0GHz high pass filter was used. Spectrum from 1GHz up to 1850 MHz was verified manually without the filter, however there are no significant emissions observed.





**2.7.13 Test Results Above 1GHz (1xEV-DO Cellular Low Channel)**

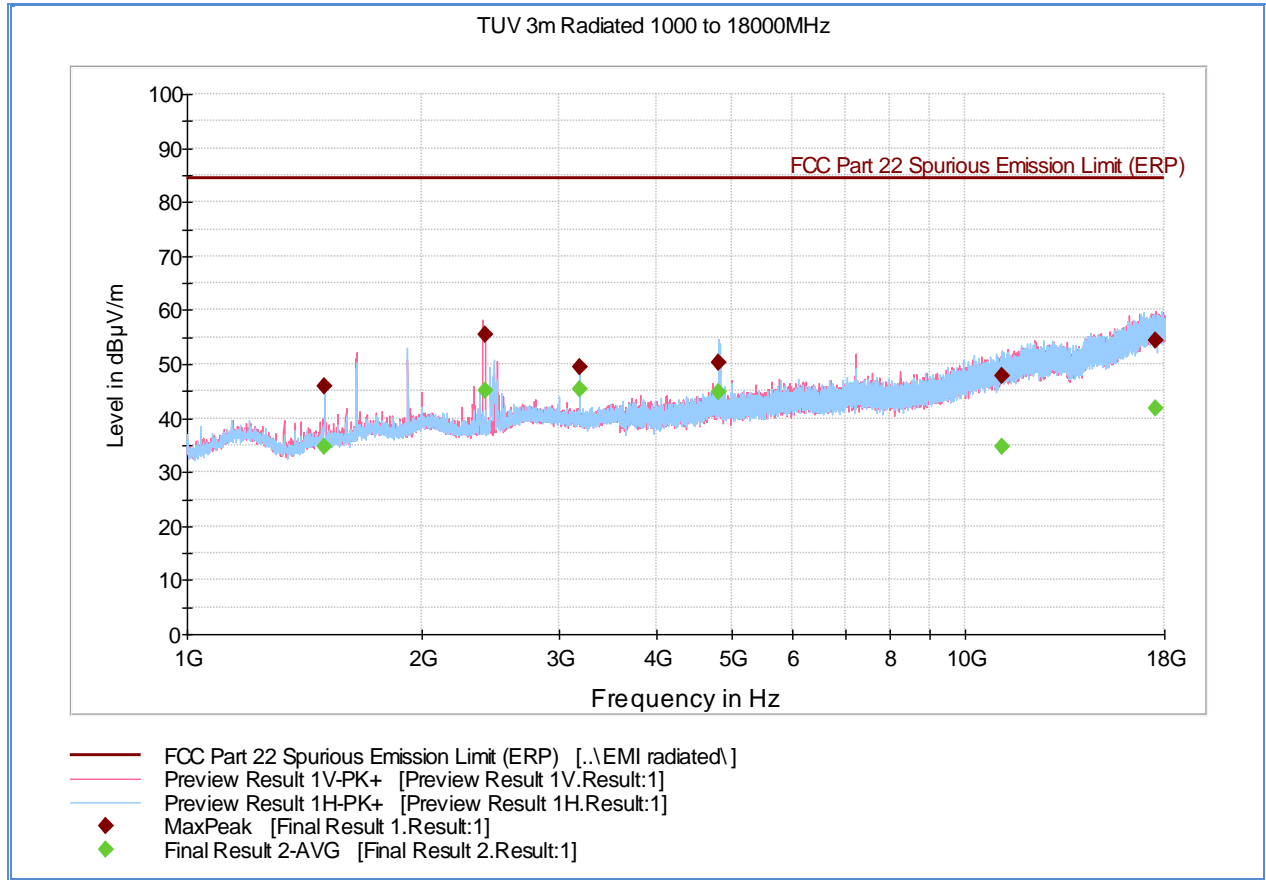

**Peak Data**

Frequency (MHz)	MaxPeak (dBµV/m)	Meas. Time (ms)	Bandwidth (kHz)	Height (cm)	Polarization	Azimuth (deg)	Corr. (dB)	Margin (dB)	Limit (dBµV/m)
1500.020000	45.8	1000.0	1000.000	120.9	H	45.0	-5.1	38.6	84.4
2411.020000	55.5	1000.0	1000.000	141.8	V	37.0	-0.4	28.8	84.4
3199.986667	49.5	1000.0	1000.000	102.9	H	110.0	1.4	34.9	84.4
4824.006667	50.3	1000.0	1000.000	101.9	H	31.0	5.3	34.1	84.4
11115.673333	47.7	1000.0	1000.000	386.9	H	82.0	14.6	36.7	84.4
17555.386667	54.4	1000.0	1000.000	178.7	V	15.0	22.1	30.0	84.4

**Substitution Data**

Frequency (MHz)	Field Strength @ 3 meters (dBµV/m)	Cable Loss (dB)	Substitution Antenna Gain (dBi)	Signal Generator Level (dBm)	Substitution Data SGL+AG-CL (dBm)	Limit (dBm)	Compliance

**Test Notes:** Only worst case channel presented for spurious emissions above 1GHz. Substitution data not required since margin is >20dB compared to the -13dBm limit (converted to field strength @ 3 meters). A 900 MHz high pass filter was used for this test.



**2.7.14 Test Results Above 1GHz (1xEV-DO PCS Mid Channel)**

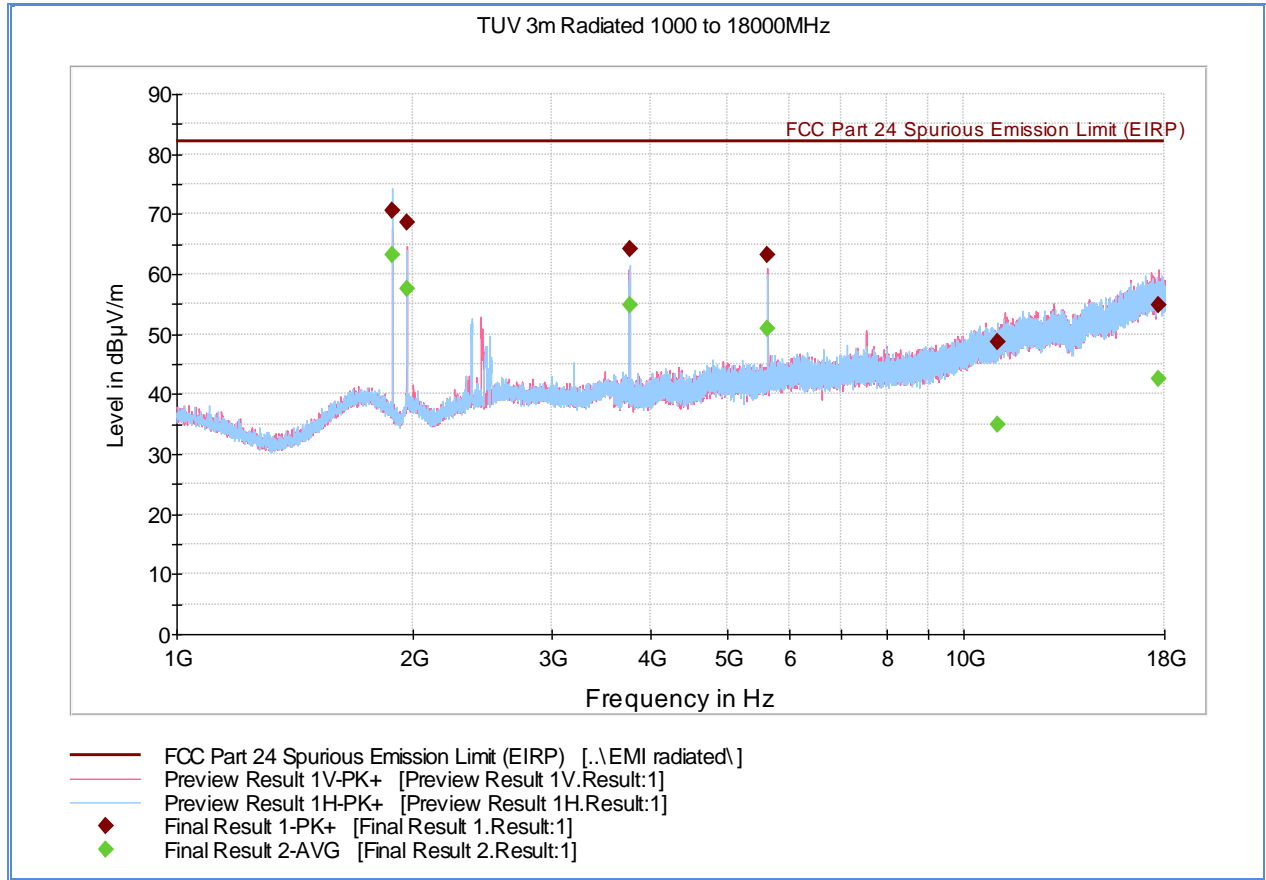

**Peak Data**

Frequency (MHz)	MaxPeak (dBµV/m)	Meas. Time (ms)	Bandwidth (kHz)	Height (cm)	Polarization	Azimuth (deg)	Corr. (dB)	Margin (dB)	Limit (dBµV/m)
1880.333333	70.5	1000.0	1000.000	111.8	H	276.0	-2.3	Fundamental	
1960.273333	68.5	1000.0	1000.000	111.8	V	357.0	-1.9	Fwd/Downlink	
3760.493333	64.2	1000.0	1000.000	142.8	H	326.0	2.9	18.1	82.2
5640.940000	63.3	1000.0	1000.000	180.6	V	220.0	7.3	19.0	82.2
11056.446667	48.7	1000.0	1000.000	338.2	H	287.0	14.6	33.6	82.2
17655.293333	54.9	1000.0	1000.000	386.9	V	133.0	22.1	27.3	82.2

**Substitution Data**

Frequency (MHz)	Field Strength @ 3 meters (dBµV/m)	Cable Loss (dB)	Substitution Antenna Gain (dBi)	Signal Generator Level (dBm)	Substitution Data SGL+AG-CL (dBm)	Limit (dBm)	Compliance
3760.493333	64.2	-3.8	9.637	-36.5	-30.663	-13	Complies
5640.940000	63.3	-5.7	11.138	-37.0	-31.562		Complies

**Test Notes:** Only worst case channel presented for spurious emissions above 1GHz. 1880 MHz is the uplink frequency while 1960 MHz is the downlink frequency. A 2.0GHz high pass filter was used. Spectrum from 1GHz up to 1850 MHz was verified manually without the filter, however there are no significant emissions observed.



**2.8 FREQUENCY STABILITY**

**2.8.1 Specification Reference**

Part 22 Subpart H §22.355 and Part 24 Subpart E §24.235

**2.8.2 Standard Applicable**

(§22.355) Except as otherwise provided in this part, the carrier frequency of each transmitter in the Public Mobile Services must be maintained within the tolerances given in Table C-1 of this section.

**Table C-1—Frequency Tolerance for Transmitters in the Public Mobile Services**

Frequency range (MHz)	Mobile ≤3 watts (ppm)
821 to 896	2.5 (0.00025%)

(§24.235) The frequency stability shall be sufficient to ensure that the fundamental emissions stay within the authorized bands of operation.

**2.8.3 Equipment Under Test and Modification State**

Serial No: 20130418001833 and 20130418001829 / Test Configuration B

**2.8.4 Date of Test/Initial of test personnel who performed the test**

May 16, 2013/FSC

**2.8.5 Test Equipment Used**

The major items of test equipment used for the above tests are identified in Section 3.1.

**2.8.6 Environmental Conditions**

Ambient Temperature      23.1°C  
Relative Humidity          49.0%  
ATM Pressure                99.0 kPa

**2.8.7 Additional Observations**

- This is a conducted test. The EUT was operated at 13.5VDC nominal voltage and was placed in the temperature chamber for this evaluation. The EUT was controlled by a CMW500 and the maximum frequency error was monitored through a Spectrum Analyzer using marker frequency count function. The results are compared to the CMW500 carrier frequency error TX Measurement application.



- The Temperature was reduced to -30°C and allowed to sit for 1 hour to allow the equipment and chamber temperature to stabilize. The measurements on both cellular and PCS channels were then performed. The temperature was then increased by 10°C steps and allowed to settle before taking the next set of measurements.
- Voltage variation was also performed at 85% and 115% of the nominal voltage.
- Only worst case configuration presented. See Section 1.4.4 of this test report for details.
- For PCS measurements, the maximum frequency deviation was verified against the frequency band edges using the EBW data. Sample calculation:

*CDMA 2000 PCS High Channel worst case frequency error:* 13.76 Hz  
*Worst case EBW (-26dB) of CDMA 2000 PCS:* 1.616 MHz  
*Edge of fundamental emission (1908.75+(1.616/2)) :* 1909.558 MHz  
*Max. fundamental frequency error (1909.558 + 0.00001376):* 1909.558014 MHz  
*EUT complies. 1909.558014 MHz < 1910 MHz (edge of authorized band)*

**2.8.8 Test Results Summary**

Mode	Frequency (MHz)	Deviation (Hz)	Deviation (ppm)
CDMA2000 Cellular (Low Channel 1013)	824.70	6.34	0.0077
CDMA2000 PCS (High Channel 1175)	1908.75	-13.76	0.0072
1xEV-DO Cellular (Low Channel 1013)	824.70	5.42	0.0066
1xEV-DO PCS (Mid Channel 600)	1880.00	11.94	0.0064

See attached tables for detailed test results.



CDMA2000 Cellular Worst Case Configuration (Low Channel 1013)					
Voltage (%)	Power (VDC)	Temp (°C)	Frequency (MHz)	Max. Frequency Deviation (Hz)	Deviation Limit (Hz)
100	13.5	-30	824.7	4.91	2061.75
100		-20		4.91	2061.75
100		-10		5.49	2061.75
100		0		4.47	2061.75
100		+10		5.55	2061.75
100		+20		5.13	2061.75
100		+30		4.17	2061.75
100		+40		5.05	2061.75
100		+50		6.30	2061.75
115		15.525		+20	
85	11.475	+20		5.43	2061.75

CDMA2000 PCS Worst Case Configuration (High Channel 1175)					
Voltage (%)	Power (VDC)	Temp (°C)	Frequency (MHz)	Max. Frequency Deviation (Hz)	Deviation Limit (Hz)
100	13.5	-30	1908.75	-10.03	EUT complies. See Section 2.8.7 for sample calculation
100		-20		-10.62	
100		-10		-11.57	
100		0		-10.62	
100		+10		-11.57	
100		+20		-13.11	
100		+30		-13.11	
100		+40		-12.89	
100		+50		-12.89	
115		15.525		+20	
85	11.475	+20		-12.56	



1xEV-DO Cellular Worst Case Configuration (Low Channel 1013)					
Voltage (%)	Power (VDC)	Temp (°C)	Frequency (MHz)	Max. Frequency Deviation (Hz)	Deviation Limit (Hz)
100	13.5	-30	824.7	4.54	2061.75
100		-20		4.98	2061.75
100		-10		4.91	2061.75
100		0		4.54	2061.75
100		+10		5.42	2061.75
100		+20		4.83	2061.75
100		+30		4.69	2061.75
100		+40		4.98	2061.75
100		+50		4.98	2061.75
115		15.525		+20	
85	11.475	+20		4.95	2061.75

1xEV-DO PCS Worst Case Configuration (Mid Channel 600)					
Voltage (%)	Power (VDC)	Temp (°C)	Frequency (MHz)	Max. Frequency Deviation (Hz)	Deviation Limit (Hz)
100	13.5	-30	1880.0	10.69	EUT complies. See Section 2.8.7 for sample calculation
100		-20		11.94	
100		-10		11.72	
100		0		10.03	
100		+10		10.25	
100		+20		9.01	
100		+30		8.06	
100		+40		8.57	
100		+50		9.16	
115		15.525		+20	
85	11.475	+20		8.20	



## **2.9 RECEIVER SPURIOUS EMISSIONS**

### **2.9.1 Specification Reference**

RSS-132(4.6) and RSS-133(6.6)

### **2.9.2 Standard Applicable**

Receiver spurious emissions shall comply with the limits specified in RSS-Gen.

### **2.9.3 Equipment Under Test and Modification State**

Serial No: 20130418001833 and 20130418001829 / Test Configuration A

### **2.9.4 Date of Test/Initial of test personnel who performed the test**

April 29 and 30, 2013/FSC

### **2.9.5 Test Equipment Used**

The major items of test equipment used for the above tests are identified in Section 3.1.

### **2.9.6 Environmental Conditions**

Ambient Temperature	25.4-25.8°C
Relative Humidity	43.5-44.5%
ATM Pressure	98.7-99.0 kPa

### **2.9.7 Additional Observations**

- This is a radiated test. The spectrum was searched from 30MHz to the 18GHz (6GHz as per requirement).
- Limit used is from FCC §15.209 which is identical to RSS-Gen limits.
- All emissions observed above 1GHz are noise floor measurements.
- Measurement was done using EMC32 automated software. Reported level is the actual level with all the correction factors factored in. Correction Factor column is for informational purposes only.

### **2.9.8 Test Results**

See attached plots.



**2.9.9 Test Results Below 1GHz (Receive Mode)**

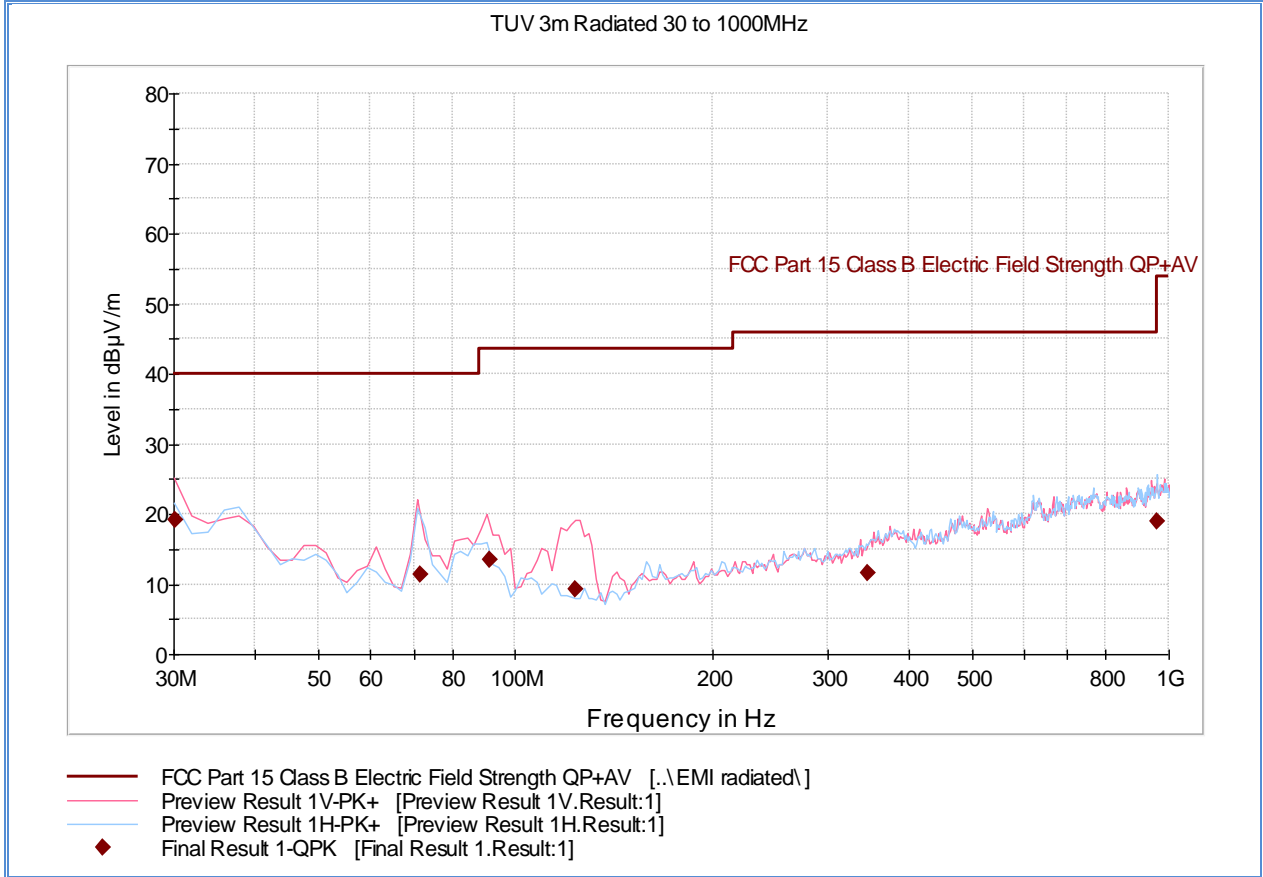

**Quasi Peak Data**

Frequency (MHz)	QuasiPeak (dBµV/m)	Meas. Time (ms)	Bandwidth (kHz)	Height (cm)	Polarization	Azimuth (deg)	Corr. (dB)	Margin (dB)	Limit (dBµV/m)
30.200000	19.2	1000.0	120.000	350.0	V	221.0	-11.8	20.8	40.0
71.381643	11.4	1000.0	120.000	100.0	V	332.0	-21.7	28.6	40.0
91.540521	13.6	1000.0	120.000	110.0	V	244.0	-20.3	29.9	43.5
123.586613	9.3	1000.0	120.000	105.0	V	156.0	-20.3	34.2	43.5
346.077595	11.6	1000.0	120.000	309.0	V	173.0	-10.2	34.4	46.0
960.258357	18.9	1000.0	120.000	200.0	H	129.0	0.8	35.0	53.9





**2.9.10 Test Results Above 1GHz (Receive Mode)**

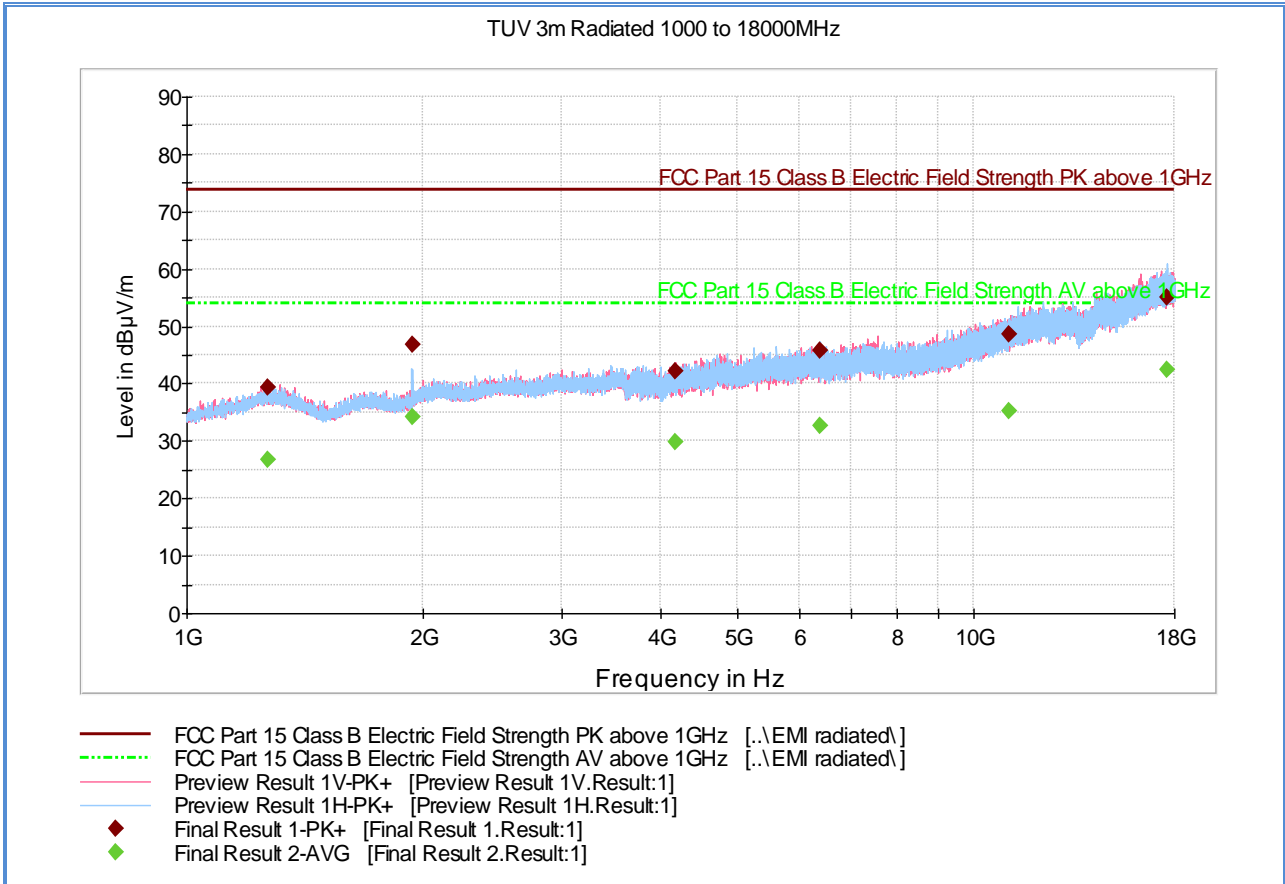

**Peak Data**

Frequency (MHz)	MaxPeak (dBµV/m)	Meas. Time (ms)	Bandwidth (kHz)	Height (cm)	Polarization	Azimuth (deg)	Corr. (dB)	Margin (dB)	Limit (dBµV/m)
1270.886667	39.3	1000.0	1000.000	400.4	V	15.0	-4.8	34.6	73.9
1932.746667	46.7	1000.0	1000.000	99.8	H	43.0	-2.0	27.2	73.9
4177.726667	42.3	1000.0	1000.000	307.2	V	15.0	3.7	31.6	73.9
6369.073333	45.8	1000.0	1000.000	209.5	H	302.0	8.4	28.1	73.9
11114.333333	48.5	1000.0	1000.000	400.4	H	331.0	14.6	25.4	73.9
17648.44000	55.0	1000.0	1000.000	296.3	H	10.0	22.1	18.9	73.9

**Average Data**

Frequency (MHz)	Average (dBµV/m)	Meas. Time (ms)	Bandwidth (kHz)	Height (cm)	Polarization	Azimuth (deg)	Corr. (dB)	Margin (dB)	Limit (dBµV/m)
1270.886667	26.9	1000.0	1000.000	400.4	V	15.0	-4.8	27.0	53.9
1932.746667	34.3	1000.0	1000.000	99.8	H	43.0	-2.0	19.6	53.9
4177.726667	29.8	1000.0	1000.000	307.2	V	15.0	3.7	24.1	53.9
6369.073333	32.5	1000.0	1000.000	209.5	H	302.0	8.4	21.4	53.9
11114.333333	35.2	1000.0	1000.000	400.4	H	331.0	14.6	18.7	53.9
17648.44000	42.3	1000.0	1000.000	296.3	H	10.0	22.1	11.6	53.9

**Test Notes:** No significant emissions observed.



**2.10 POWER LINE CONDUCTED EMISSIONS**

**2.10.1 Specification Reference**

RSS-Gen 7.2.4

**2.10.2 Standard Applicable**

Except when the requirements applicable to a given device state otherwise, for any radio apparatus equipped to operate from the public utility AC power supply, either directly or indirectly (such as with a battery charger), the radio frequency voltage of emissions conducted back onto the AC power lines in the frequency range of 0.15 MHz to 30 MHz shall not exceed the limits shown in the table below. The more stringent limit applies at the frequency range boundaries.

The conducted emissions shall be measured with a 50 ohm/50 microhenry line impedance stabilization network (LISN).

Frequency of emission (MHz)	Conducted limit (dBµV)	
	Quasi-peak	Average
0.15–0.5	66 to 56*	56 to 46*
0.5–5	56	46
5–30	60	50

*\*Decreases with the logarithm of the frequency.*

**2.10.3 Equipment Under Test and Modification State**

Not applicable. EUT is not designed to operate from the public utility AC power supply.



### SECTION 3

#### TEST EQUIPMENT USED



### 3.1 TEST EQUIPMENT USED

List of absolute measuring and other principal items of test equipment.

ID Number (SDGE/SDRB)	Test Equipment	Type	Serial Number	Manufacturer	Cal Date	Cal Due Date
<b>Conducted Port Setup</b>						
7569	Series Power Meter	N1911A P-	MY45100625	Agilent	04/15/13	04/15/14
5217 (loaner from Techmaster)	50MHz-18GHz Wideband Power Sensor	N1921A	MY45240180	Agilent	10/18/12	02/18/14
6814	PSA Series Spectrum Analyzer	E4440A	MY42510441	Agilent	11/07/12	11/07/13
ATEK Rental	Temperature Chamber	SH-241	92009707	Espec	01/28/13	01/28/13
	20dB Attenuator	34-20-34	BP4180	MCE/Weinschel	Verified by 6814 and 1003	
8686	20dB Attenuator	0846	BW-N20W5+	MCL	Verified by 6814 and 1003	
<b>Radiated Test Setup</b>						
1033	Bilog Antenna	3142C	00044556	EMCO	05/23/12	05/23/13
7575	Double-ridged waveguide horn antenna	3117	00155511	EMCO	03/25/13	03/25/14
8628	Pre-amplifier	QLJ 01182835-JO	8986002	QuinStar Technologies Inc.	09/21/12	09/21/13
1153	High-frequency cable	SucoFlex 100 SX	N/A	Suhner	09/21/12	09/21/13
1040	EMI Test Receiver	ESIB40	100292	Rhode & Schwarz	08/10/12	08/10/13
1049	EMI Test Receiver	ESU	100133	Rhode & Schwarz	06/13/12	06/13/13
TUV777	900MHz High Pass Filter	FF6549-1	004	Sage	Verified by 1049 and 1003	
TUV783	2.0GHz High Pass Filter	FF6549-2	008	Sage	Verified by 1049 and 1003	
1016	Pre-amplifier	PAM-0202	187	PAM	09/24/12	09/24/13
<b>Miscellaneous</b>						
	Test Software	EMC32	V8.53	Rhode & Schwarz	N/A	
1003	Signal Generator	SMR-40	1104.0002.40	Rhode & Schwarz	11/12/12	11/12/13
6452	Multimeter	3478A	2911A52177	Hewlett Packard	07/16/12	07/16/13
7560	Barometer/Temperature /Humidity Transmitter	iBTHX-W	1240476	Omega	11/19/12	11/19/13
7539	DC Power Supply	6434B	1140A01866	Hewlett Packard	Verified by 6452	



### 3.2 MEASUREMENT UNCERTAINTY

For a 95% confidence level, the measurement uncertainties for defined systems are:

#### 3.2.1 Radiated Emission Measurements (Below 1GHz)

Contribution		Probability Distribution Type	Probability Distribution $x_i$	Standard Uncertainty $u(x_i)$	$[u(x_i)]^2$
1	Receiver/Spectrum Analyzer	Rectangular	0.45	0.26	0.07
2	Cables	Rectangular	0.50	0.29	0.08
3	Preamp	Rectangular	0.50	0.29	0.08
4	Antenna	Rectangular	0.75	0.43	0.19
5	Site	Rectangular	3.89	2.25	5.04
6	EUT Setup	Rectangular	1.00	0.58	0.33
Combined Uncertainty ( $u_c$ ):					2.41
Coverage Factor (k):					2
Expanded Uncertainty:					4.82

#### 3.2.2 Radiated Emission Measurements (Above 1GHz)

Contribution		Probability Distribution Type	Probability Distribution $x_i$	Standard Uncertainty $u(x_i)$	$[u(x_i)]^2$
1	Receiver/Spectrum Analyzer	Rectangular	0.57	0.33	0.11
2	Cables	Rectangular	0.70	0.40	0.16
3	Preamp	Rectangular	0.50	0.29	0.08
4	Antenna	Rectangular	0.37	0.21	0.05
5	Site	Rectangular	3.89	2.25	5.04
6	EUT Setup	Rectangular	1.00	0.58	0.33
Combined Uncertainty ( $u_c$ ):					2.40
Coverage Factor (k):					2
Expanded Uncertainty:					4.81

#### 3.2.3 Conducted Antenna Port Measurement

Contribution		Probability Distribution Type	Probability Distribution $x_i$	Standard Uncertainty $u(x_i)$	$[u(x_i)]^2$
1	Receiver/Spectrum Analyzer	Rectangular	0.57	0.33	0.11
2	Cables	Rectangular	0.50	0.29	0.08
3	EUT Setup	Rectangular	1.00	0.58	0.33
Combined Uncertainty ( $u_c$ ):					0.72
Coverage Factor (k):					2
Expanded Uncertainty:					1.45



## **SECTION 4**

### **DIAGRAM OF TEST SETUP**

#### 4.1 TEST SETUP DIAGRAM

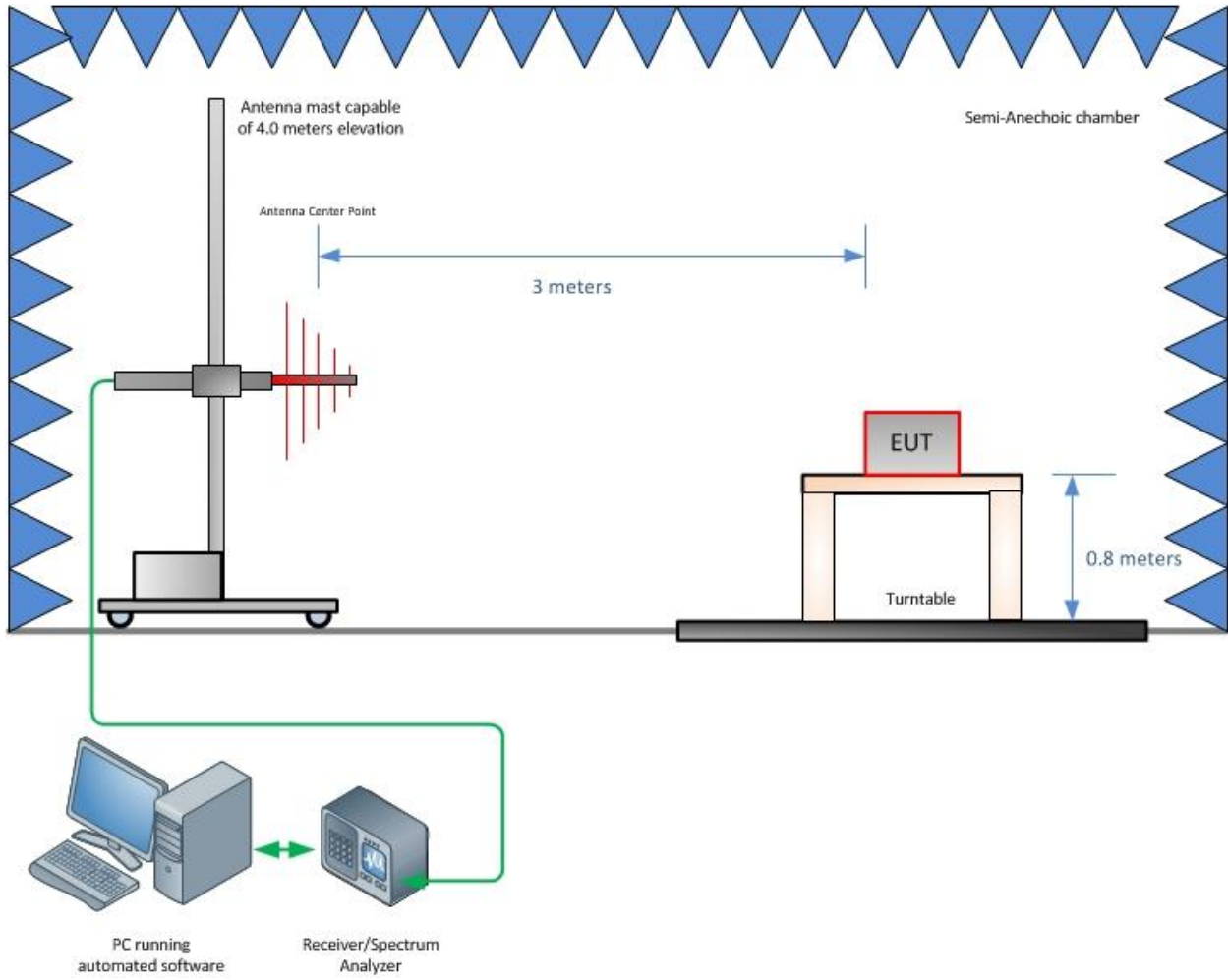

**Radiated Emission Test Setup (Below 1GHz)**

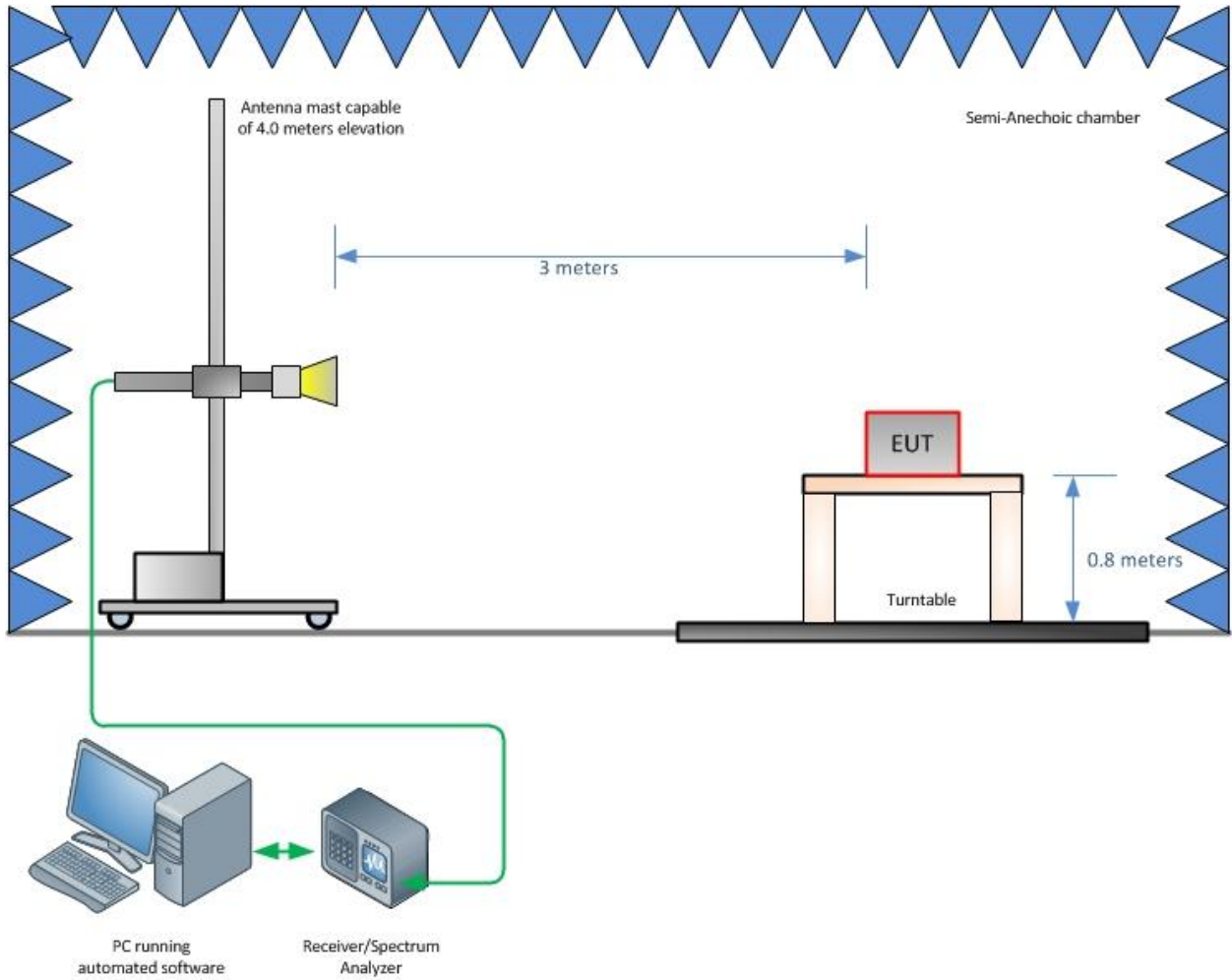

**Radiated Emission Test Setup (Above 1GHz)**



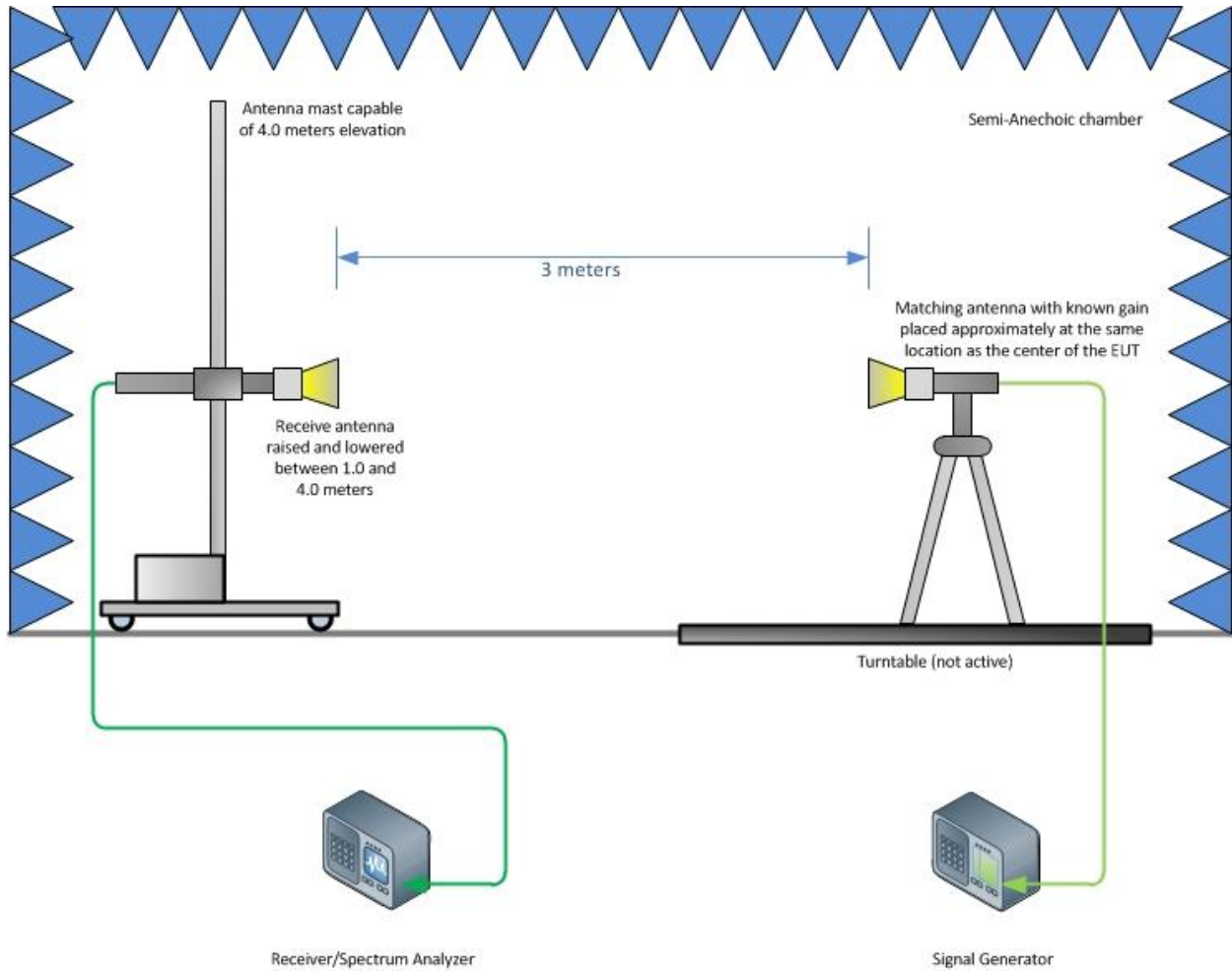

**Substitution Test Method (Above 1GHz)**

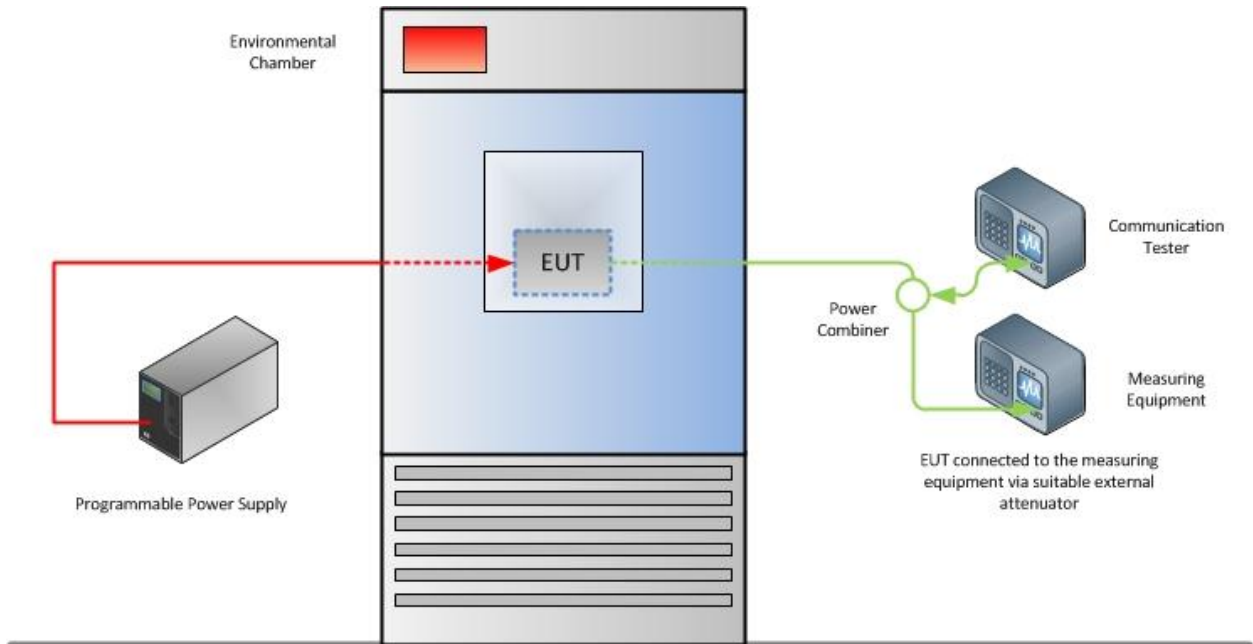

**Frequency Stability Test Configuration**

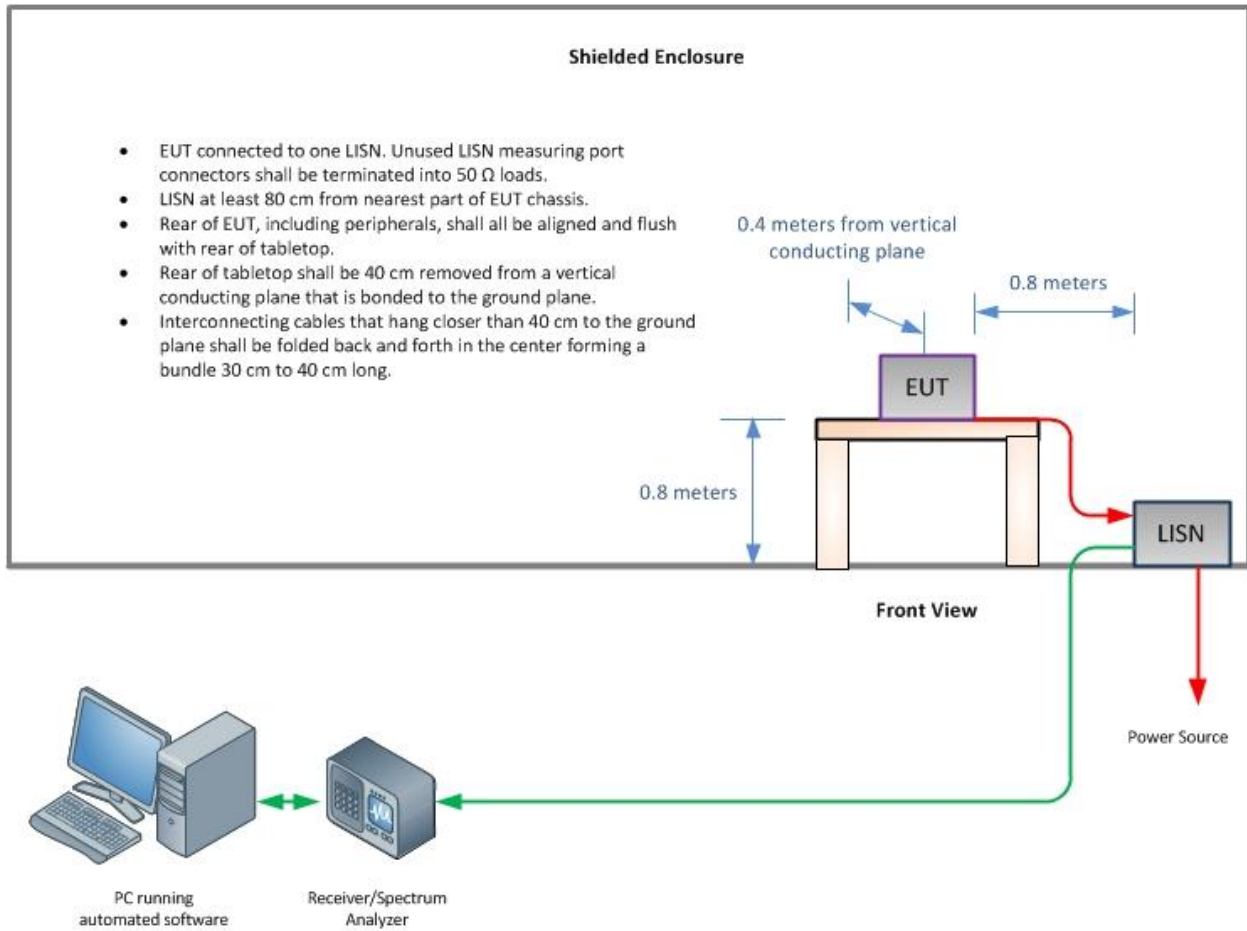



## SECTION 5

### ACCREDITATION, DISCLAIMERS AND COPYRIGHT



## 5.1 ACCREDITATION, DISCLAIMERS AND COPYRIGHT

TÜV SÜD America Inc.'s reports apply only to the specific sample tested under stated test conditions. It is the manufacturer's responsibility to assure the continued compliance of production units of this model. TÜV SÜD America, Inc. shall have no liability for any deductions, inferences or generalizations drawn by the client or others from TÜV SÜD America, Inc.'s issued reports.

This report is the confidential property of the client. As a mutual protection to our clients, the public and TÜV SÜD America, Inc., extracts from the test report shall not be reproduced, except in full without TÜV SÜD America, Inc.'s written approval.

This report must not be used to claim product certification, approval, or endorsement by NVLAP, NIST, or any agency of the federal government.

TÜV SÜD America, Inc. and its professional staff hold government and professional organization certifications for AAMI, ACIL, AEA, ANSI, IEEE, NVLAP, NIST and VCCI.



NVLAP Lab Code: 100268-0

