



Hearing Aid Compatibility (HAC) RF Emissions Test Report

APPLICANT : Unimax Communications
EQUIPMENT : CDMA EVDO REV A 800/1900MHz mobile phone
BRAND NAME : UMX
MODEL NAME : U680
FCC ID : P46-U680
STANDARD : FCC 47 CFR §20.19
ANSI C63.19-2007
M CATEGORY : M4

The product was completely tested on Dec. 24, 2012. We, SPORTON INTERNATIONAL (KUNSHAN) INC., would like to declare that the tested sample has been evaluated in accordance with the procedures and shown the compliance with the applicable technical standards.

The test results in this report apply exclusively to the tested model / sample. Without written approval of SPORTON INTERNATIONAL (KUNSHAN) INC., the test report shall not be reproduced except in full.

Reviewed by:

Jones Tsai / Manager



SPORTON INTERNATIONAL (KUNSHAN) INC.
No. 3-2, PingXiang Road, Kunshan, Jiangsu Province, P.R.C.



Table of Contents

Revision History.....3
1. Statement of Compliance.....4
2. Administration Data.....5
2.1 Testing Laboratory.....5
2.2 Applicant.....5
2.3 Manufacturer.....5
2.4 Application Details.....5
3. General Information.....6
3.1 Description of Device Under Test (DUT).....6
3.2 Product Photos.....6
3.3 Applied Standards.....7
3.4 Test Conditions.....8
3.4.1 Ambient Condition.....8
3.4.2 Test Configuration.....8
4. Hearing Aid Compliance (HAC).....9
Introduction.....9
5. HAC RF Emission Measurement Setup.....10
5.1 E-Field and H-Field Probe System.....11
5.1.1 E-Field Probe Specification.....11
5.1.2 H-Field Probe Description.....11
5.1.3 Probe Tip Description.....12
5.2 DATA Acquisition Electronics (DAE).....13
5.3 Robot.....14
5.4 Measurement Server.....14
5.5 Phone Positioner.....15
5.6 Test Arch Phantom.....15
5.7 Data Storage and Evaluation.....16
5.7.1 Data Storage.....16
5.7.2 Data Evaluation.....16
5.8 Test Equipment List.....18
6. Uncertainty Assessment.....19
7. HAC RF Emission Measurement Evaluation.....21
7.1 Purpose of System Performance Check.....21
7.2 System Setup.....21
7.3 Validation Results.....22
8. RF Field Probe Modulation Factor.....23
9. Description for DUT Testing Position.....26
10. RF Emissions Test Procedure.....28
11. HAC RF Emission Test Results.....29
11.1 Conducted Power (Unit: dBm).....29
11.2 E-Field Emission.....29
11.3 H-Field Emission.....29
12. References.....30
Appendix A. Plots of System Performance Check
Appendix B. Plots of RF Emission Measurement
Appendix C. DASy Calibration Certificate
Appendix D. Product Photos
Appendix E. Test Setup Photos



Revision History

REPORT NO.	VERSION	DESCRIPTION	ISSUED DATE
HA2D1401A	Rev. 01	Initial issue of report	Jan. 06, 2013



1. Statement of Compliance

The maximum results of RF Emission of Hearing Aid Compliance (HAC) found during testing for the **Unimax Communications; DUT: CDMA EVDO REV A 800/1900MHz mobile phone; Brand Name: UMX; Model Name: U680** are follows (with expanded uncertainty $\pm 30.4\%$ for E-field and $\pm 21.6\%$ for H-field):

Band	HAC RF Emission Test Result		M Rating
CDMA2000 BC0	E-Field (V/m)	91.655	M4
	H-Field (A/m)	0.162	M4
CDMA2000 BC1	E-Field (V/m)	43.560	M4
	H-Field (A/m)	0.125	M4

They are in compliance with HAC limits (HAC Rated category M3) specified in guidelines FCC 47 CFR §20.19 and ANSI Standard ANSI C63.19.

Results Summary : M Category = M4 (ANSI C63.19-2007)



2. Administration Data

2.1 Testing Laboratory

Test Site	SPORTON INTERNATIONAL (KUNSHAN) INC.
Test Site Location	No. 3-2, PingXiang Road, Kunshan, Jiangsu Province, P.R.C. TEL: +86-0512-5790-0158 FAX: +86-0512-5790-0958
Test Site No.	Sporton Site No. : SAR01-KS

2.2 Applicant

Company Name	Unimax Communications
Address	18201 McDermott St. West Suite E, Irvine, CA 92614

2.3 Manufacturer

Company Name	Unimax Communications
Address	18201 McDermott St. West Suite E, Irvine, CA 92614

2.4 Application Details

Date of Start during the Test	Dec. 24, 2012
Date of End during the Test	Dec. 24, 2012

3. General Information

3.1 Description of Device Under Test (DUT)

Product Feature & Specification	
DUT Type	CDMA EVDO REV A 800/1900MHz mobile phone
Brand Name	UMX
Model Name	U680
FCC ID	P46-U680
Tx Frequency	CDMA2000 BC0: 824.70 MHz ~ 848.31 MHz CDMA2000 BC1: 1851.25 MHz ~ 1908.75 MHz
Rx Frequency	CDMA2000 BC0: 869.70 MHz ~ 893.31 MHz CDMA2000 BC1: 1931.25 MHz ~ 1988.75 MHz
Maximum Output Power to Antenna	CDMA2000 BC0 : 23.61 dBm CDMA2000 BC1 : 24.07 dBm
Antenna Type	Fixed Internal Antenna
HW Version	G3616_V1.1
SW Version	U680_05.03
Type of Modulation	QPSK
DUT Stage	Identical Prototype

Remark: .

1. The above EUT's information was declared by manufacturer. Please refer to the specifications or user's manual for more detailed description.
2. There are two different types of EUT that only with different logo in the front. The others are the same including circuit design, PCB board, structure and all components. It is special to declare.

List of air interfaces / frequency bands:

Air Interface	Band (MHz)	Voice/Data	C63.19-2007 Tested	Concurrent connections	Reduced power 20.19 (c)(1)
CDMA 1XRTT	BC0, BC1	Voice	Yes	WLAN,BT	No
CDMA 1XEVD0	BC0, BC1	Data(*)	No	WLAN,BT	No
WLAN	2450	Data(*)	No	CDMA 1XRTT,CDMA 1XEVD0	No
BT	2450	Data(*)	No	CDMA 1XRTT,CDMA 1XEVD0	No

Note:

1. (*): The voice function maybe be activated via 3rd party software application.
2. Per KDB 285076 D01 7)a), during RF test, concurrent transmission is disabled.

3.2 Product Photos

Refer to Appendix D.

3.3 Applied Standards

The ANSI Standard ANSI C63.19-2007 represents performance requirements for acceptable interoperability of hearing aids with wireless communications devices. When these parameters are met, a hearing aid operates acceptably in close proximity to a wireless communications device.

The following AWF factors shall be used for the standard transmission protocols:

Standard	Technology	AWF (dB)
TIA/EIA/IS-2000	CDMA	0
TIA/EIA-136	TDMA (50 Hz)	0
J-STD-007	GSM (217)	-5
T1/T1P1/3GPP	UMTS (WCDMA)	0
iDENTM	TDMA (22 and 11 Hz)	0

Table 3.1 Articulation Weighting Factor (AWF)

Category	Telephone RF Parameters			
	Near Field	AWF	E-Field Emissions	H-Field Emissions
< 960 MHz				
Category M1	0		631.0 – 1122.0 V/m	1.91 – 3.39 A/m
	-5		473.2 – 841.4 V/m	1.43 – 2.54 A/m
Category M2	0		354.8 – 631.0 V/m	1.07 – 1.91 A/m
	-5		266.1 – 473.2 V/m	0.80 – 1.43 A/m
Category M3	0		199.5 – 354.8 V/m	0.6 – 1.07 A/m
	-5		149.6 – 266.1 V/m	0.45 – 0.80 A/m
Category M4	0		< 199.5 V/m	< 0.60 A/m
	-5		< 149.6 V/m	< 0.45 A/m
> 960 MHz				
Category M1	0		199.5 – 354.8 V/m	0.60 – 1.07 A/m
	-5		149.6 – 266.1 V/m	0.45 – 0.80 A/m
Category M2	0		112.2 – 199.5 V/m	0.34 – 0.60 A/m
	-5		84.1 – 149.6 V/m	0.25 – 0.45 A/m
Category M3	0		63.1 – 112.2 V/m	0.19 – 0.34 A/m
	-5		47.3 – 84.1 V/m	0.14 – 0.25 A/m
Category M4	0		< 63.1 V/m	< 0.19 A/m
	-5		< 47.3 V/m	< 0.14 A/m

Table 3.2 Telephone near-field categories in linear units



3.4 Test Conditions

3.4.1 Ambient Condition

Ambient Temperature	20 to 24 °C
Humidity	< 60 %

3.4.2 Test Configuration

The device was controlled by using a base station emulator Agilent 8960. Communication between the device and the emulator was established by air link. The power control bits was set to "Always Up" from the emulator to radiate maximum output power during all testing.

Measurements were performed on the low, middle and high channels of all bands.



4. Hearing Aid Compliance (HAC)

Introduction

The federal communication commission (FCC) adopted ANSI C63.19 as HAC test standard.

5. HAC RF Emission Measurement Setup

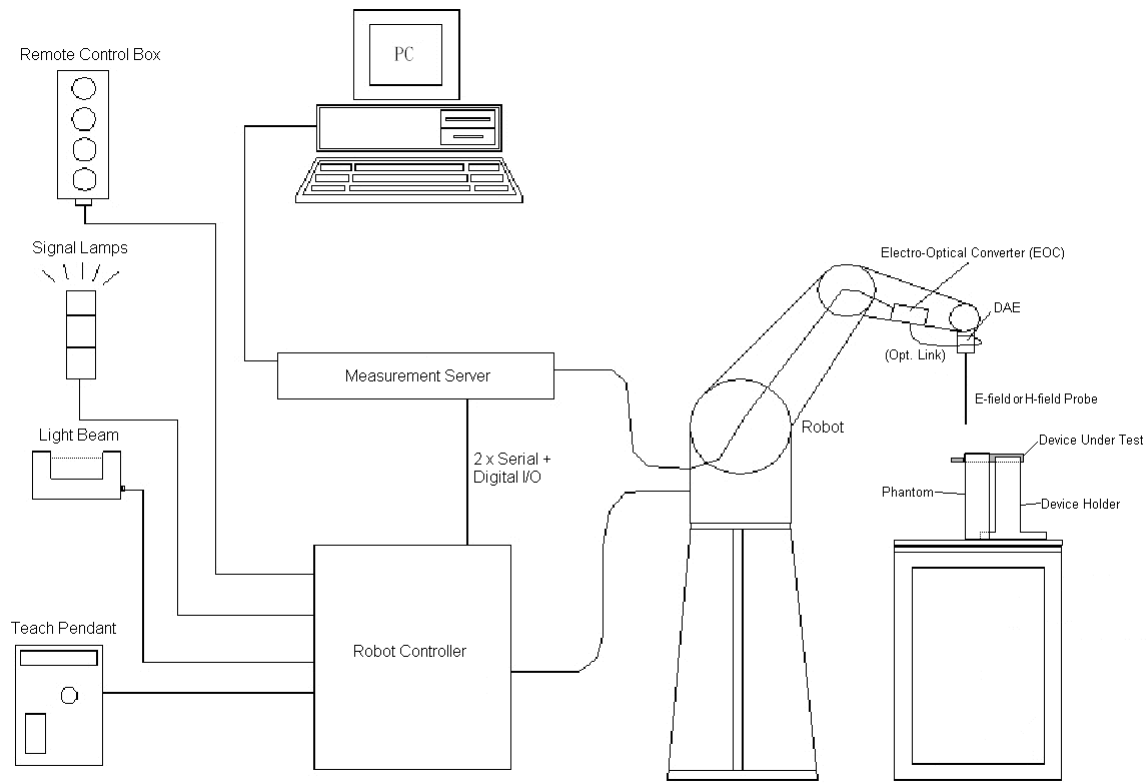

Fig 5.1 SPEAG DASY4 or DASY5 System Configurations

The DASY4 or DASY5 system for performance compliance tests is illustrated above graphically. This system consists of the following items:

- A standard high precision 6-axis robot with controller, a teach pendant and software
- A data acquisition electronic (DAE) attached to the robot arm extension
- A dosimetric probe equipped with an optical surface detector system
- The electro-optical converter (EOC) performs the conversion between optical and electrical signals
- A measurement server performs the time critical tasks such as signal filtering, control of the robot operation and fast movement interrupts.
- A probe alignment unit which improves the accuracy of the probe positioning
- A computer operating Windows XP
- DASY4 or DASY5 software
- Remote control with teach pendant and additional circuitry for robot safety such as warning lamps, etc.
- The SAM twin phantom
- A device holder
- Tissue simulating liquid
- Dipole for evaluating the proper functioning of the system

Some of the components are described in details in the following sub-sections.

5.1 E-Field and H-Field Probe System

The HAC measurement is conducted with the dosimetric probe ER3DV6 and H3DV6 (manufactured by SPEAG). The probe is specially designed and calibrated. This probe has a built in optical surface detection system to prevent from collision with DUT.

5.1.1 E-Field Probe Specification

<ER3DV6>

Construction	One dipole parallel, two dipoles normal to probe axis Built-in shielding against static charges
Calibration	In air from 100 MHz to 3.0 GHz (absolute accuracy $\pm 6.0\%$, $k=2$)
Frequency	100 MHz to 6 GHz; Linearity: ± 2.0 dB (100 MHz to 3 GHz)
Directivity	± 0.2 dB in air (rotation around probe axis) ± 0.4 dB in air (rotation normal to probe axis)
Dynamic Range	2 V/m to 1000 V/m (M3 or better device readings fall well below diode compression point)
Linearity	± 0.2 dB
Dimensions	Overall length: 330 mm (Tip: 16 mm) Tip diameter: 8 mm (Body: 12 mm) Distance from probe tip to dipole centers: 2.5 mm



Fig 5.2 Photo of E-field Probe

5.1.2 H-Field Probe Description

<H3DV6>

Construction	Three concentric loop sensors with 3.8 mm loop diameters Resistively loaded detector diodes for linear response Built-in shielding against static charges
Frequency	200 MHz to 3 GHz (absolute accuracy $\pm 6.0\%$, $k=2$); Output linearized
Directivity	± 0.25 dB (spherical isotropy error)
Dynamic Range	10 m A/m to 2 A/m at 1 GHz (M3 or better device readings fall well below diode compression point)
Dimensions	Overall length: 330 mm (Tip: 40 mm) Tip diameter: 6 mm (Body: 12 mm) Distance from probe tip to dipole centers: 3 mm
E-Field Interference	$< 10\%$ at 3 GHz (for plane wave)



Fig 5.3 Photo of H-field Probe

5.1.3 Probe Tip Description

HAC field measurements take place in the close near field with high gradients. Increasing the measuring distance from the source will generally decrease the measured field values (in case of the validation dipole approx. 10% per mm).

Magnetic field sensors are measuring the integral of the H-field across their sensor area surrounded by the loop. They are calibrated in a precise, homogeneous field. When measuring a gradient field, the result will be very close to the field in the center of the loop which is equivalent to the value of a homogeneous field equivalent to the center value. But it will be different from the field at the field at the border of the loop.

Consequently, two sensors with different loop diameters – both calibrated ideally – would give different results when measuring from the edge of the probe sensor elements. The behavior for electrically small E-field sensors is equivalent. See below for distance plots from a WD which show the conservative nature of field readings at the probe element center vs. measurements at the sensor end:

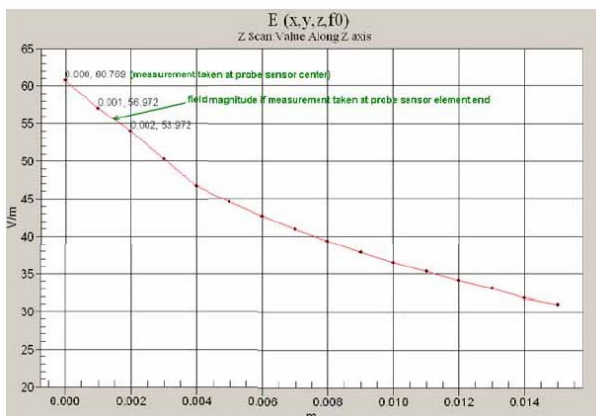

Fig 5.4 Z-Axis Scan at maximum point above a typical wireless device for E-field

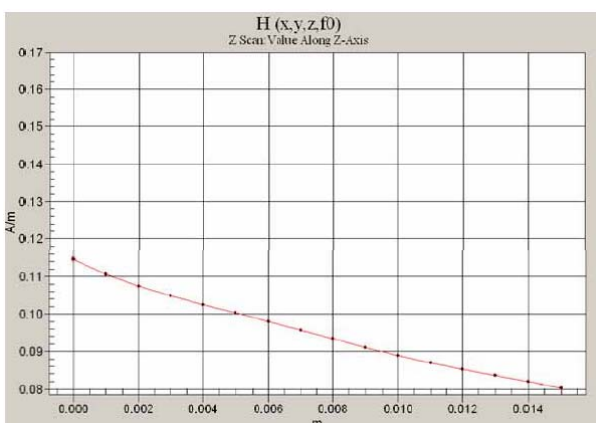

Fig 5.5 Z-Axis Scan at maximum point above a typical wireless device for H-field

The magnetic field loops of the H3D probes are concentric, with the center 3mm from the tip for H3DV6. Their radius is 1.9 mm.

The electric field probes have a more irregular internal geometry because it is physically not possible to have the 3 orthogonal sensors situated with the same center. The effect of the different sensor centers is accounted for in the HAC uncertainty budget ("sensor displacement"). Their geometric center is at 2.5 mm from the tip, and the element ends are 1.1 mm closer to the tip.

Where:

Peak Field = Peak field (in dB V/m or dB A/m)

Raw = Raw field measurement from the measurement system (in V/m or A/m).

PMF = Probe Modulation Factor (in Linear units). See Chapter 8 of test report.

5.2 DATA Acquisition Electronics (DAE)

The data acquisition electronics (DAE) consists of a highly sensitive electrometer-grade preamplifier with auto-zeroing, a channel and gain-switching multiplexer, a fast 16 bit AD-converter and a command decoder and control logic unit. Transmission to the measurement server is accomplished through an optical downlink for data and status information as well as an optical uplink for commands and the clock.

The input impedance of the DAE is 200 MOhm; the inputs are symmetrical and floating. Common mode rejection is above 80 dB.



Fig 5.6 Photo of DAE

5.3 Robot

The SPEAG DASY system uses the high precision robots (DASY4: RX90BL; DASY5: TX90XL) type from Stäubli SA (France). For the 6-axis controller system, the robot controller version (DASY4: CS7MB; DASY5: CS8c) from Stäubli is used. The Stäubli robot series have many features that are important for our application:

- High precision (repeatability ± 0.035 mm)
- High reliability (industrial design)
- Jerk-free straight movements
- Low ELF interference (the closed metallic construction shields against motor control fields)
- 6-axis controller



Fig 5.7 Photo of DASY4

5.4 Measurement Server

The measurement server is based on a PC/104 CPU board with CPU (DASY4: 166 MHz, Intel Pentium; DASY5: 400 MHz, Intel Celeron), chipdisk (DASY4: 32 MB; DASY5: 128 MB), RAM (DASY4: 64 MB, DASY5: 128 MB). The necessary circuits for communication with the DAE electronic box, as well as the 16 bit AD converter system for optical detection and digital I/O interface are contained on the DASY I/O board, which is directly connected to the PC/104 bus of the CPU board.

The measurement server performs all the real-time data evaluation for field measurements and surface detection, controls robot movements and handles safety operations.



Fig 5.8 Photo of Server for DASY5

5.5 Phone Positioner

The phone positioner shown in Fig. 5.11 is used to adjust DUT to the suitable position.



Fig 5.9 Phone Positioner

5.6 Test Arch Phantom

<p>Construction :</p>	<p>Enables easy and well defined positioning of the phone and validation dipoles as well as simple teaching of the robot.</p>	
<p>Dimensions :</p>	<p>370 x 370 x 370 mm</p>	

Fig 5.10 Photo of Arch Phantom



5.7 Data Storage and Evaluation

5.7.1 Data Storage

The DASY software stores the assessed data from the data acquisition electronics as raw data (in microvolt readings from the probe sensors), together with all the necessary software parameters for the data evaluation (probe calibration data, and device frequency and modulation data) in measurement files. The post-processing software evaluates the desired unit and format for output each time the data is visualized or exported. This allows verification of the complete software setup even after the measurement and allows correction of erroneous parameter settings.

5.7.2 Data Evaluation

The DASY post-processing software (SEMCAD) automatically executes the following procedures to calculate the field units from the microvolt readings at the probe connector. The parameters used in the evaluation are stored in the configuration modules of the software :

Probe parameters :	- Sensitivity	Norm _i , a _{i0} , a _{i1} , a _{i2}
	- Conversion factor	ConvF _i
	- Diode compression point	dcp _i
Device parameters :	- Frequency	f
	- Crest factor	cf
Media parameters :	- Conductivity	σ
	- Density	ρ

These parameters must be set correctly in the software. They can be found in the component documents or they can be imported into the software from the configuration files issued for the DASY components. In the direct measuring mode of the multi-meter option, the parameters of the actual system setup are used. In the scan visualization and export modes, the parameters stored in the corresponding document files are used.

The first step of the evaluation is a linearization of the filtered input signal to account for the compression characteristics of the detector diode. The compensation depends on the input signal, the diode type and the DC-transmission factor from the diode to the evaluation electronics. If the exciting field is pulsed, the crest factor of the signal must be known to correctly compensate for peak power. The formula for each channel can be given as :

V_i = U_i + U_i^2 * (cf / dcp_i)

- with V_i = compensated signal of channel i, (i = x, y, z)
- U_i = input signal of channel i, (i = x, y, z)
- cf = crest factor of exciting field (DASY parameter)
- dcp_i = diode compression point (DASY parameter)

From the compensated input signals, the primary field data for each channel can be evaluated :

$$\text{E-field Probes : } \mathbf{E}_i = \sqrt{\frac{V_i}{\text{Norm}_i \cdot \text{ConvF}}}$$

$$\text{H-field Probes : } \mathbf{H}_i = \sqrt{V_i} \cdot \frac{a_{i0} + a_{i1}f + a_{i2}f^2}{f}$$

- with V_i = compensated signal of channel i , ($i = x, y, z$)
- Norm_i = sensor sensitivity of channel i , ($i = x, y, z$), $\mu\text{V}/(\text{V}/\text{m})^2$ for E-field Probes
- ConvF = sensitivity enhancement in solution
- a_{ij} = sensor sensitivity factors for H-field probes
- f = carrier frequency [GHz]
- E_i = electric field strength of channel i in V/m
- H_i = magnetic field strength of channel i in A/m

The RSS value of the field components gives the total field strength (Hermitian magnitude) :

$$\mathbf{E}_{\text{tot}} = \sqrt{\mathbf{E}_x^2 + \mathbf{E}_y^2 + \mathbf{E}_z^2}$$

The primary field data are used to calculate the derived field units.

The measurement/integration time per point, as specified by the system manufacturer is > 500 ms. The signal response time is evaluated as the time required by the system to reach 90% of the expected final value after an on/off switch of the power source with an integration time of 500 ms and a probe response time of < 5 ms. In the current implementation, DASYS waits longer than 100 ms after having reached the grid point before starting a measurement, i.e., the response time uncertainty is negligible.

If the device under test does not emit a CW signal, the integration time applied to measure the electric field at a specific point may introduce additional uncertainties due to the discretization. The tolerances for the different systems had the worst-case of 2.6%.



5.8 Test Equipment List

Manufacturer	Name of Equipment	Type/Model	Serial Number	Calibration	
				Last Cal.	Due Date
SPEAG	Dipole	CD835V3	1045	Jun. 14, 2012	Jun. 13, 2013
SPEAG	Dipole	CD1880V3	1038	Jun. 14, 2012	Jun. 13, 2013
SPEAG	Data Acquisition Electronics	DAE3	360	Nov. 15, 2012	Nov. 14, 2013
SPEAG	Probe	ER3DV6	2302	Jun. 20, 2012	Jun. 19, 2013
SPEAG	Probe	H3DV6	6187	Jun. 20, 2012	Jun. 19, 2013
SPEAG	Test Arch Phantom	Par phantom	1105	NCR	NCR
SPEAG	Phone Positioner	N/A	N/A	NCR	NCR
Agilent	Wireless Communication Test Set	E5515C	MY48367160	Oct. 25, 2012	Oct. 24, 2013
AR	Amplifier	551G4	333096	NCR	NCR
Agilent	Power Meter	E4416A	MY45101555	Aug. 22, 2012	Aug. 21, 2013
Agilent	Power Sensor	E9327A	MY44421198	Aug. 22, 2012	Aug. 21, 2013
ARRA	Power Divider	A3200-2	N/A	NA	NA
MCL	Attenuation	BW-S10W5	N/A	NA	NA
R&S	Spectrum Analyzer	FSP30	101399	Jun. 01, 2012	May 31, 2013

Table 5.1 Test Equipment List

6. Uncertainty Assessment

The component of uncertainty may generally be categorized according to the methods used to evaluate them. The evaluation of uncertainty by the statistical analysis of a series of observations is termed a Type A evaluation of uncertainty. The evaluation of uncertainty by means other than the statistical analysis of a series of observation is termed a Type B evaluation of uncertainty. Each component of uncertainty, however evaluated, is represented by an estimated standard deviation, termed standard uncertainty, which is determined by the positive square root of the estimated variance.

A Type A evaluation of standard uncertainty may be based on any valid statistical method for treating data. This includes calculating the standard deviation of the mean of a series of independent observations; using the method of least squares to fit a curve to the data in order to estimate the parameter of the curve and their standard deviations; or carrying out an analysis of variance in order to identify and quantify random effects in certain kinds of measurement.

A type B evaluation of standard uncertainty is typically based on scientific judgment using all of the relevant information available. These may include previous measurement data, experience and knowledge of the behavior and properties of relevant materials and instruments, manufacture’s specification, data provided in calibration reports and uncertainties assigned to reference data taken from handbooks. Broadly speaking, the uncertainty is either obtained from an outdoor source or obtained from an assumed distribution, such as the normal distribution, rectangular or triangular distributions indicated in Table 6.1.

Uncertainty Distributions	Normal	Rectangular	Triangular	U-Shape
Multi-plying Factor ^(a)	1/k ^(b)	1/√3	1/√6	1/√2

(a) standard uncertainty is determined as the product of the multiplying factor and the estimated range of variations in the measured quantity

(b) κ is the coverage factor

Table 6.1 Multiplying Factions for Various Distributions

The combined standard uncertainty of the measurement result represents the estimated standard deviation of the result. It is obtained by combining the individual standard uncertainties of both Type A and Type B evaluation using the usual “root-sum-squares” (RSS) methods of combining standard deviations by taking the positive square root of the estimated variances.

Expanded uncertainty is a measure of uncertainty that defines an interval about the measurement result within which the measured value is confidently believed to lie. It is obtained by multiplying the combined standard uncertainty by a coverage factor. Typically, the coverage factor ranges from 2 to 3. Using a coverage factor allows the true value of a measured quantity to be specified with a defined probability within the specified uncertainty range. For purpose of this document, a coverage factor two is used, which corresponds to confidence interval of about 95 %. The DASY uncertainty Budget is showed in Table 6.2.



Error Description	Uncertainty Value (±%)	Probability Distribution	Divisor	Ci (E)	Ci (H)	Standard Uncertainty (E)	Standard Uncertainty (H)
Measurement System							
Probe Calibration	5.1	Normal	1	1	1	± 5.1 %	± 5.1 %
Axial Isotropy	4.7	Rectangular	√3	1	1	± 2.7 %	± 2.7 %
Sensor Displacement	16.5	Rectangular	√3	1	0.145	± 9.5 %	± 1.4 %
Test Arch	7.2	Rectangular	√3	1	0	± 4.1 %	± 0.0 %
Linearity	4.7	Rectangular	√3	1	1	± 2.7 %	± 2.7 %
Scaling to Peak Envelope Power	0.0	Rectangular	√3	1	1	± 0.0 %	± 0.0 %
System Detection Limit	1.0	Rectangular	√3	1	1	± 0.6 %	± 0.6 %
Readout Electronics	0.3	Normal	1	1	1	± 0.3 %	± 0.3 %
Response Time	0.8	Rectangular	√3	1	1	± 0.5 %	± 0.5 %
Integration Time	2.6	Rectangular	√3	1	1	± 1.5 %	± 1.5 %
RF Ambient Conditions	3.0	Rectangular	√3	1	1	± 1.7 %	± 1.7 %
RF Reflections	12.0	Rectangular	√3	1	1	± 6.9 %	± 6.9 %
Probe Positioner	1.2	Rectangular	√3	1	0.67	± 0.7 %	± 0.5 %
Probe Positioning	4.7	Rectangular	√3	1	0.67	± 2.7 %	± 1.8 %
Extrap. and Interpolation	1.0	Rectangular	√3	1	1	± 0.6 %	± 0.6 %
Test Sample Related							
Device Positioning Vertical	4.7	Rectangular	√3	1	0.67	± 2.7 %	± 1.8 %
Device Positioning Lateral	1.0	Rectangular	√3	1	1	± 0.6 %	± 0.6 %
Device Holder and Phantom	2.4	Rectangular	√3	1	1	± 1.4 %	± 1.4 %
Power Drift	5.0	Rectangular	√3	1	1	± 2.9 %	± 2.9 %
Phantom and Setup Related							
Phantom Thickness	2.4	Rectangular	√3	1	0.67	± 1.4 %	± 0.9 %
Combined Standard Uncertainty						± 15.2 %	± 10.8 %
Coverage Factor for 95 %						K = 2	
Expanded Uncertainty						± 30.4 %	± 21.6 %

Table 6.2 Uncertainty Budget of DASYS

7. HAC RF Emission Measurement Evaluation

Each DASY system is equipped with one or more system validation kits. These units, together with the predefined measurement procedures within the DASY software, enable the user to conduct the system performance check and system validation. System validation kit includes a dipole, tripod holder to fix it underneath the test Arch and a corresponding distance holder.

7.1 Purpose of System Performance Check

The system performance check verifies that the system operates within its specifications. System and operator errors can be detected and corrected. It is recommended that the system performance check be performed prior to any usage of the system in order to guarantee reproducible results. The system performance check uses normal HAC measurements in a simplified setup with a well characterized source. This setup was selected to give a high sensitivity to all parameters that might fail or vary over time. The system check does not intend to replace the calibration of the components, but indicates situations where the system uncertainty is exceeded due to drift or failure.

7.2 System Setup

In the simplified setup for system evaluation, the DUT is replaced by a calibrated dipole and the power source is replaced by a continuous wave which comes from a signal generator. The calibrated dipole must be placed beneath the arch phantom. The equipment setup is shown below:

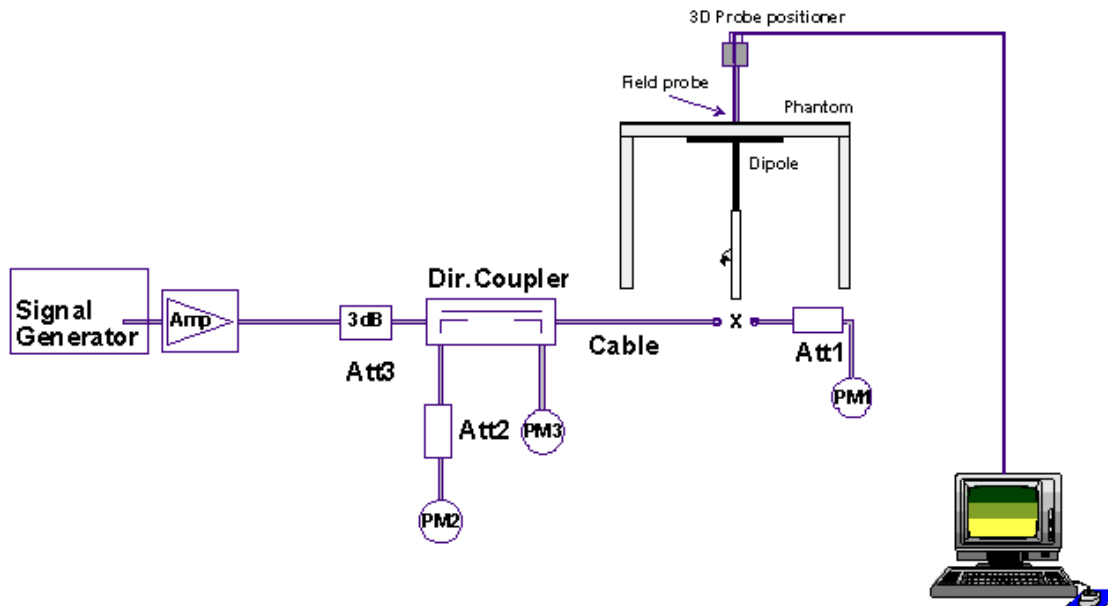

Fig. 7.1 System Setup of System Evaluation

1. Signal Generator
2. Amplifier
3. Directional Coupler
4. Power Meter
5. Calibrated Dipole

The output power on dipole port must be calibrated to 20dBm (100mW) before dipole is connected.

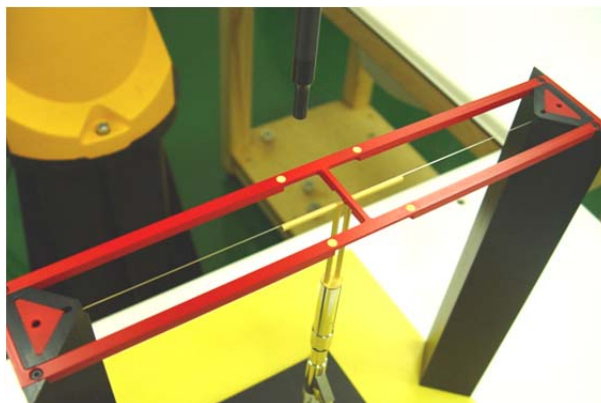

Fig 7.2 Dipole Setup

7.3 Validation Results

Comparing to the original E-field or H-field value provided by SPEAG, the validation data should be within its specification of 25 %. Table 7.1 shows the target value and measured value. The table below indicates the system performance check can meet the variation criterion and the plots can be referred to Appendix A of this report.

Frequency (MHz)	Input Power (dBm)	Target Value (V/m)	E-Field 1 (V/m)	E-Field 2 (V/m)	Average Value (V/m)	Deviation (%)	Date
835	20	167.6	160.7	169.8	165.25	0.09	Dec 24, 2012
1880	20	139.0	139.4	142.9	141.15	2.36	Dec 24, 2012
Frequency (MHz)	Input Power (dBm)	Target Value (A/m)	H-Field (A/m)		Deviation (%)	Date	
835	20	0.455	0.462		0.22	Dec 24, 2012	
1880	20	0.463	0.448		-3.66	Dec 24, 2012	

Table 7.1 Test Results of System Validation

Note: Deviation = ((E or H-field Result) - (Target field)) / (Target field) * 100%

8. RF Field Probe Modulation Factor

A calibration shall be made of the modulation response of the probe and its instrumentation chain. This calibration shall be performed with the field probe, attached to the instrumentation that is to be used with it during the measurement. The response of the probe system to a CW field at the frequency(s) of interest is compared to its response to a modulated signal with equal peak amplitude. The field level of the test signals shall be more than 10 dB above the ambient level and the noise floor of the instrumentation being used. The ratio of the CW reading to that taken with a modulated field shall be applied to the readings taken of modulated fields of the specified type.

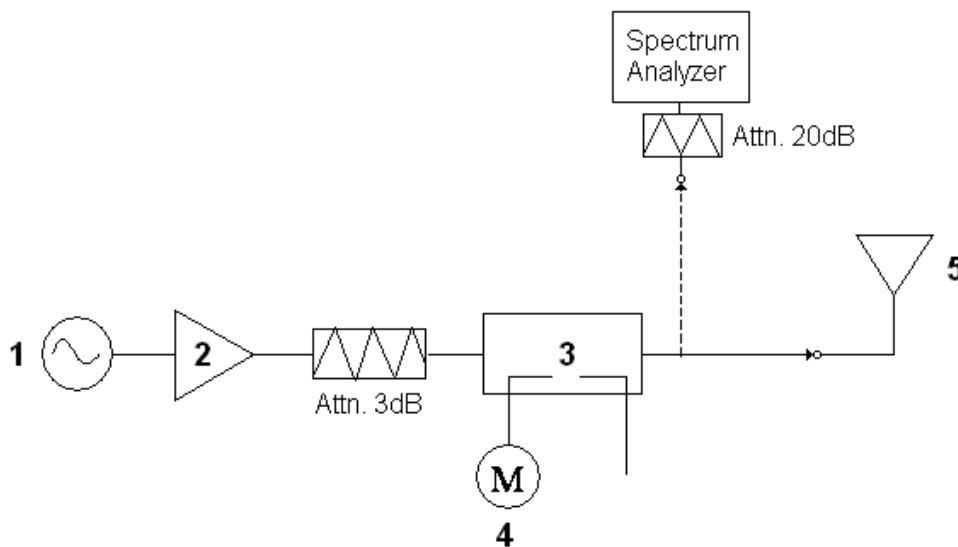

Fig. 8.1 System Calibration

This was done using the following procedure:

1. Fixing the probe in a set location relative to a field generating device.
2. Illuminate the probe with a CW signal at the intended measurement frequency.
3. Record the reading of the probe measurement system of the CW signal.
4. Determine the level of the CW signal being used to drive the field generating device.
5. Substitute a signal using the same modulation as that used by the intended WD for the CW signal.
6. Set the peak amplitude during transmission of the modulated signal to equal the amplitude of the CW signal.
7. Record the reading of the probe measurement system of the modulated signal.
8. The ratio of the CW to modulated signal reading is the modulation factor.
9. Repeat 2~8 steps at intended measurement frequency for both E and H field probe.



PMF Measurement Summary:

Frequency	Functions	E-field	H-field	PMF	
		V/m	A/m	E-field	H-field
835MHz	CW	248.0	0.705	-	-
835MHz	AM 80%	153.6	0.462	1.61	1.53
835MHz	CDMA	217.5	0.691	1.14	1.02
1880MHz	CW	301.4	0.999	-	-
1880MHz	AM 80%	187.9	0.770	1.60	1.30
1880MHz	CDMA	289.8	0.934	1.04	1.07

Zero span Spectrum Plots for RF Field Probe Modulation Factor

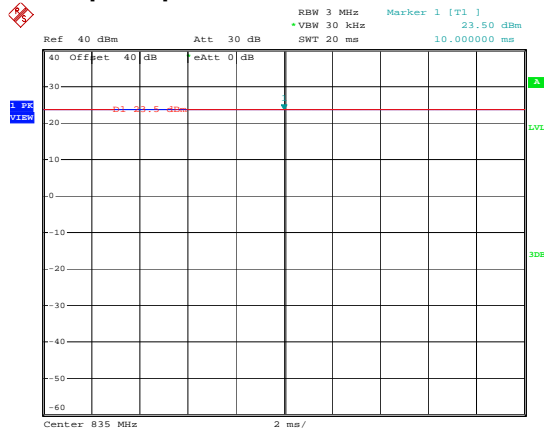

835MHz - CW

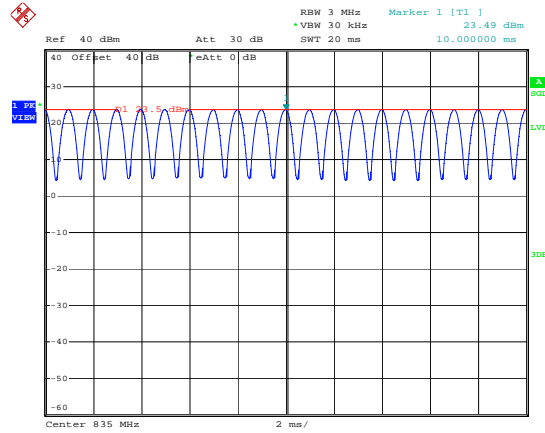

835MHz - 80% AM

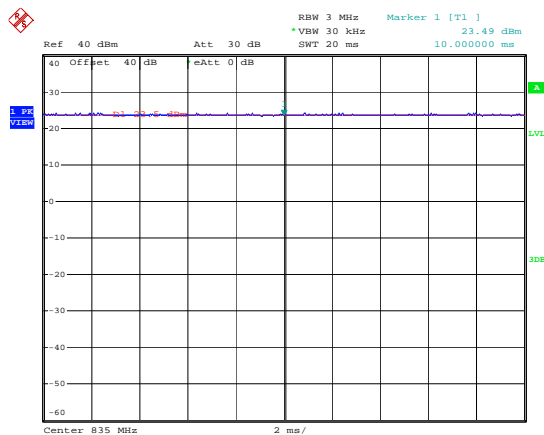

835MHz - CDMA (Full Rate)

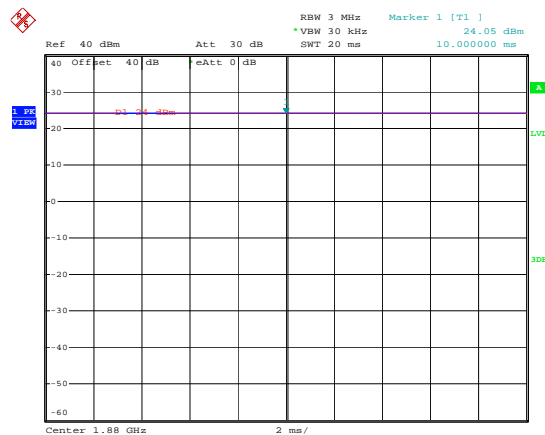

1880MHz - CW

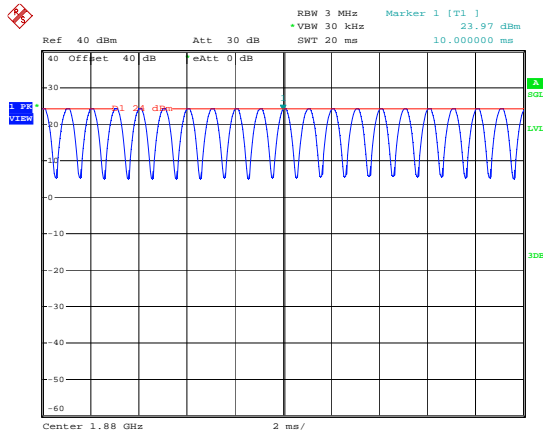

1880MHz - 80% AM

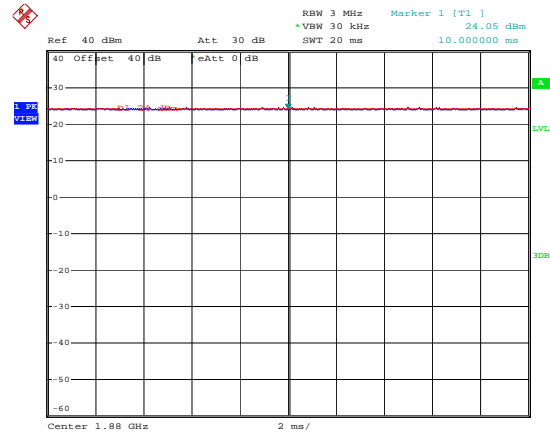

1880MHz - CDMA (Full Rate)

9. Description for DUT Testing Position

The DUT was put on device holder and adjusted to the accurate and reliable position. Please refer to Appendix E for the Setup photographs.

Fig. 9.1 illustrate the references and reference plane that shall be used in a typical DUT emissions measurement. The principle of this section is applied to DUT with similar geometry.

- The grid is 5 cm by 5 cm area that is divided into 9 evenly sized blocks or sub-grids.
- The grid is centered on the audio frequency output transducer of the DUT.
- The grid is in a reference plane, which is defined as the planar area that contains the highest point in the area of the phone that normally rests against the user's ear. It is parallel to the centerline of the receiver area of the phone and is defined by the points of the receiver-end of the DUT handset, which, in normal handset use, rest against the ear.
- The measurement plane is parallel to, and 15 mm in front of, the reference plane.



Fig 9.1 A typical DUT reference and plane for HAC measurements

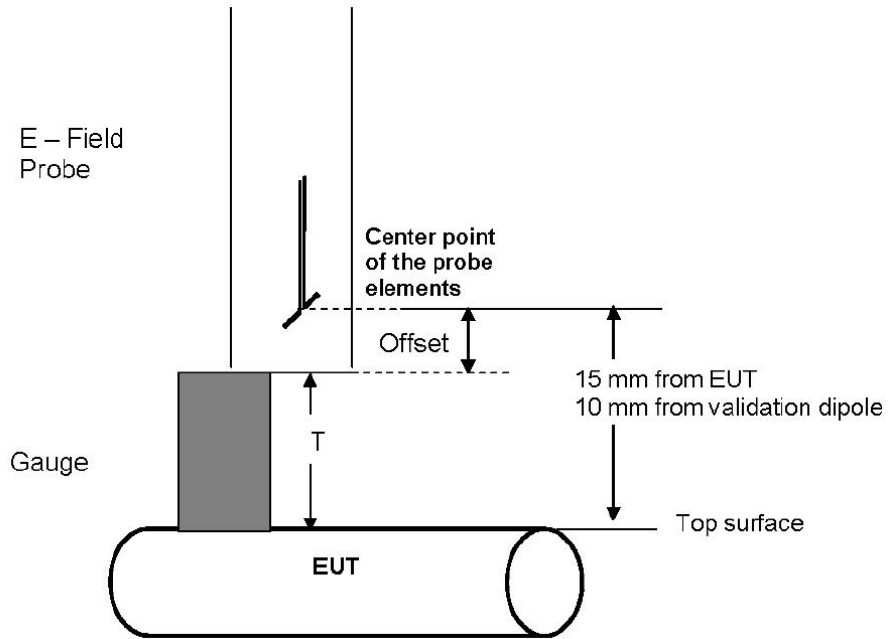

Fig. 9.2 Gauge block with E-field probe

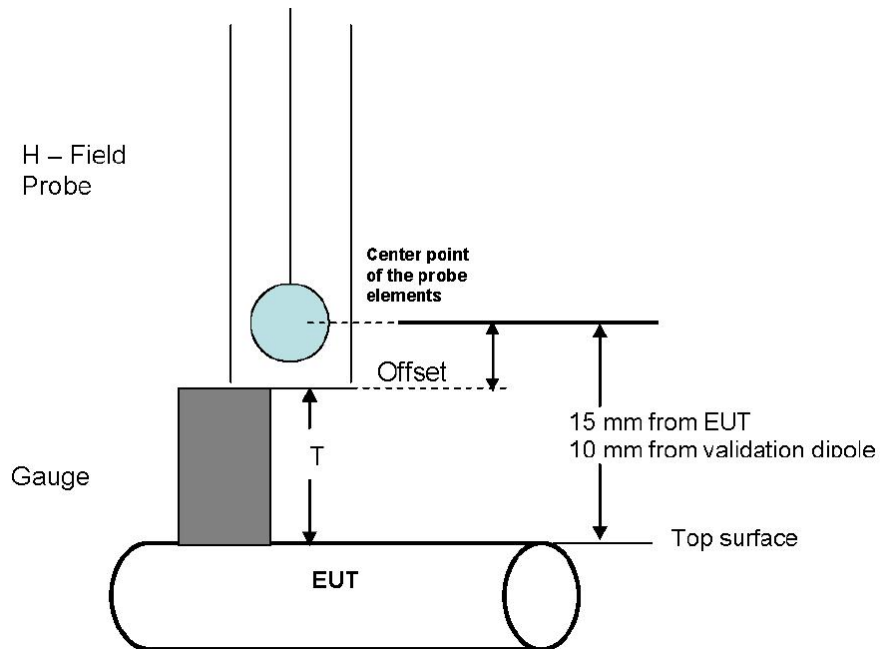

Fig. 9.3 Gauge block with H-field probe



10. RF Emissions Test Procedure

The following illustrate a typical RF emissions test scan over a wireless communications device:

1. Proper operation of the field probe, probe measurement system, other instrumentation, and the positioning system was confirmed.
2. DUT is positioned in its intended test position, acoustic output point of the device perpendicular to the field probe.
3. The DUT operation for maximum rated RF output power was configured and confirmed with the base station simulator, at the test channel and other normal operating parameters as intended for the test. The battery was ensured to be fully charged before each test.
4. The center sub-grid was centered over the center of the acoustic output (also audio band magnetic output, if applicable). The DUT audio output was positioned tangent (as physically possible) to the measurement plane.
5. A surface calibration was performed before each setup change to ensure repeatable spacing and proper maintenance of the measurement plane using the test Arch.
6. The measurement system measured the field strength at the reference location.
7. Measurements at 5 mm increments in the 5 x 5 cm region were performed and recorded. A 360° rotation about the azimuth axis at the maximum interpolated position was measured. For the worst-case condition, the peak reading from this rotation was used in re-evaluating the HAC category.
8. The system performed a drift evaluation by measuring the field at the reference location.
9. Steps 1 ~ 8 were done for both the E and H-Field measurements.

11. HAC RF Emission Test Results

11.1 Conducted Power (Unit: dBm)

Band	CDMA2000 BC0			CDMA2000 BC1		
Channel	1013	384	777	25	600	1175
Frequency (MHz)	824.70	836.52	848.31	1851.25	1880.00	1908.75
1xRTT RC1+SO55	23.52	23.55	23.60	23.97	23.95	24.03
1xRTT RC3+SO55	23.53	23.59	23.61	24.06	24.04	24.07
1xRTT RC3+SO32(+ F-SCH)	23.50	23.56	23.59	23.95	23.93	24.02
1xRTT RC3+SO32(+SCH)	23.51	23.57	23.58	23.95	23.95	24.01
1xEVDO RTAP 153.6	23.50	23.55	23.56	23.92	23.98	23.99
1xEVDO RETAP 4096	23.51	23.54	23.55	24.02	24.01	24.03

11.2 E-Field Emission

Plot No.	Band	Mode	Channel	PMF	Peak E-Field (V/m)	M-Rating
1	CDMA2000 BC0	RC3 SO55	1013	1.14	80.624	M4
2	CDMA2000 BC0	RC3 SO55	384	1.14	88.321	M4
3	CDMA2000 BC0	RC3 SO55	777	1.14	91.655	M4
4	CDMA2000 BC1	RC3 SO55	25	1.04	40.666	M4
5	CDMA2000 BC1	RC3 SO55	600	1.04	43.399	M4
6	CDMA2000 BC1	RC3 SO55	1175	1.04	43.560	M4

11.3 H-Field Emission

Plot No.	Band	Mode	Channel	PMF	Peak H-Field (A/m)	M-Rating
1	CDMA2000 BC0	RC3 SO55	1013	1.02	0.141	M4
2	CDMA2000 BC0	RC3 SO55	384	1.02	0.156	M4
3	CDMA2000 BC0	RC3 SO55	777	1.02	0.162	M4
4	CDMA2000 BC1	RC3 SO55	25	1.07	0.112	M4
5	CDMA2000 BC1	RC3 SO55	600	1.07	0.125	M4
6	CDMA2000 BC1	RC3 SO55	1175	1.07	0.122	M4

Remark:

1. The volume was adjusted to maximum level and the backlight turned off during RF Emission testing.
2. There is no special HAC mode software on this DUT.
3. Test Engineer : Fulu Hu



12. References

- [1] ANSI C63.19-2007, "American National Standard for Methods of Measurement of Compatibility between Wireless Communications Devices and Hearing Aids", 8 June 2007
- [2] SPEAG DASY System Handbook



Appendix A. Plots of System Performance Check

The plots are shown as follows.

HAC_E_Dipole_835_121224

DUT: HAC-Dipole 835 MHz

Communication System: CW; Frequency: 835 MHz; Duty Cycle: 1:1

Medium: Air Medium parameters used: $\sigma = 0$ mho/m, $\epsilon_r = 1$; $\rho = 0$ kg/m³

Ambient Temperature : 23.3 °C

DASY5 Configuration:

- Probe: ER3DV6 - SN2302; ConvF(1, 1, 1); Calibrated: 2012-6-20
- Sensor-Surface: (Fix Surface)
- Electronics: DAE3 Sn360; Calibrated: 2012-11-15
- Phantom: HAC Test Arch with AMCC; Type: SD HAC P01 BA;
- Measurement SW: DASY52, Version 52.8 (2); SEMCAD X Version 14.4.5 (3634)

E Scan - measurement distance from the probe sensor center to CD835 Dipole = 10mm/Hearing Aid Compatibility Test (41x361x1): Measurement grid: dx=5mm, dy=5mm

Maximum value of peak Total field = 169.8 V/m

Probe Modulation Factor = 1.000

Reference Value = 106.7 V/m; Power Drift = 0.02 dB

Average value of Total=(160.7+169.8) /2 = 165.25V/m

Peak E-field in V/m

Grid 1 157.4 M4	Grid 2 160.7 M4	Grid 3 155.2 M4
Grid 4 86.156 M4	Grid 5 88.008 M4	Grid 6 84.704 M4
Grid 7 162.6 M4	Grid 8 169.8 M4	Grid 9 165.8 M4

Cursor:

Total = 169.8 V/m

E Category: M4

Location: -1, 82.5, 4.7 mm

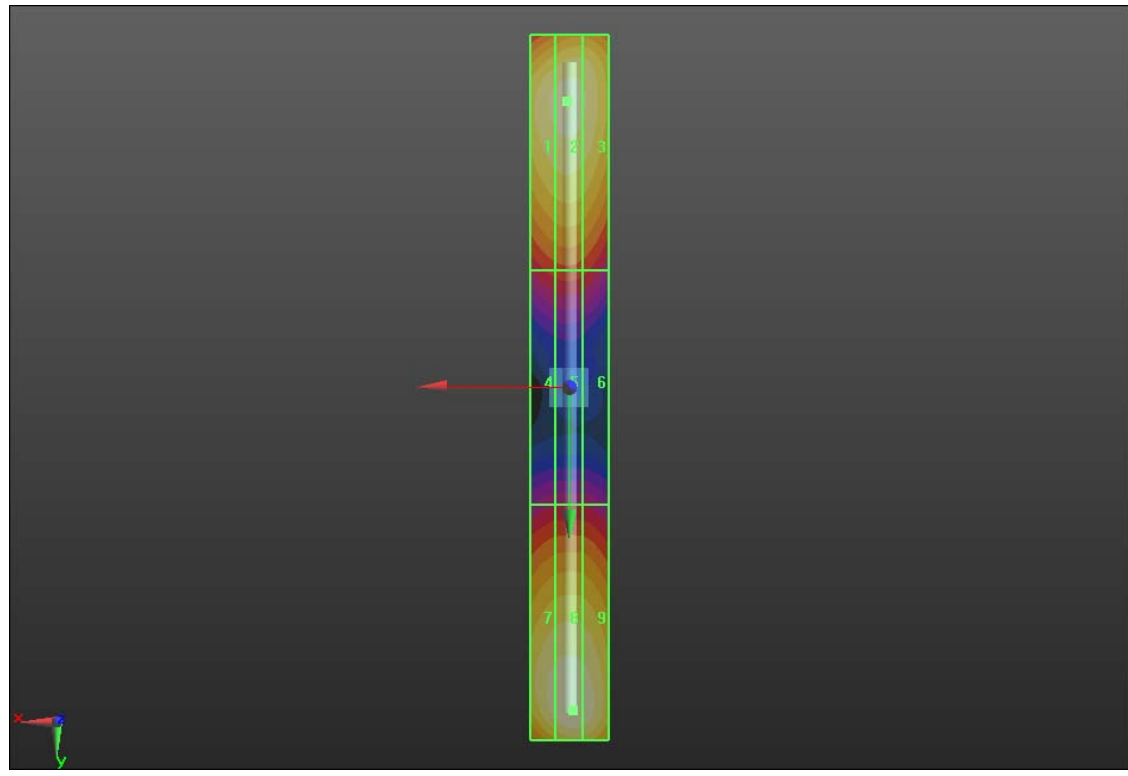
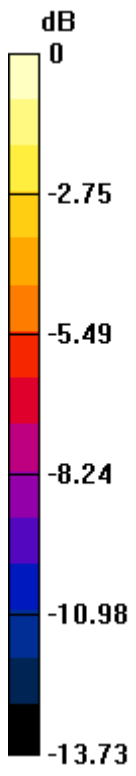

0 dB = 169.8V/m

HAC_E_Dipole_1880_121224

DUT: HAC Dipole 1880 MHz

Communication System: CW; Frequency: 1880 MHz; Duty Cycle: 1:1

Medium: Air Medium parameters used: $\sigma = 0$ mho/m, $\epsilon_r = 1$; $\rho = 0$ kg/m³

Ambient Temperature : 23.3 °C

DASY5 Configuration:

- Probe: ER3DV6 - SN2302; ConvF(1, 1, 1); Calibrated: 2012-6-20
- Sensor-Surface: (Fix Surface)
- Electronics: DAE3 Sn360; Calibrated: 2012-11-15
- Phantom: HAC Test Arch with AMCC; Type: SD HAC P01 BA;
- Measurement SW: DASY52, Version 52.8 (2); SEMCAD X Version 14.4.5 (3634)

E Scan - measurement distance from the probe sensor center to CD1880 Dipole = 10mm/Hearing Aid Compatibility Test (41x181x1): Measurement grid: dx=5mm, dy=5mm

Maximum value of peak Total field = 142.9 V/m

Probe Modulation Factor = 1.000

Reference Value = 163.7 V/m; Power Drift = 0.0019 dB

Average value of Total=(139.4+142.9) /2 = 141.15V/m

Peak E-field in V/m

Grid 1 135.3 M2	Grid 2 139.4 M2	Grid 3 135.5 M2
Grid 4 92.477 M3	Grid 5 95.116 M3	Grid 6 90.650 M3
Grid 7 135.4 M2	Grid 8 142.9 M2	Grid 9 139.8 M2

Cursor:

Total = 142.9 V/m

E Category: M2

Location: -0.5, 38.5, 4.7 mm

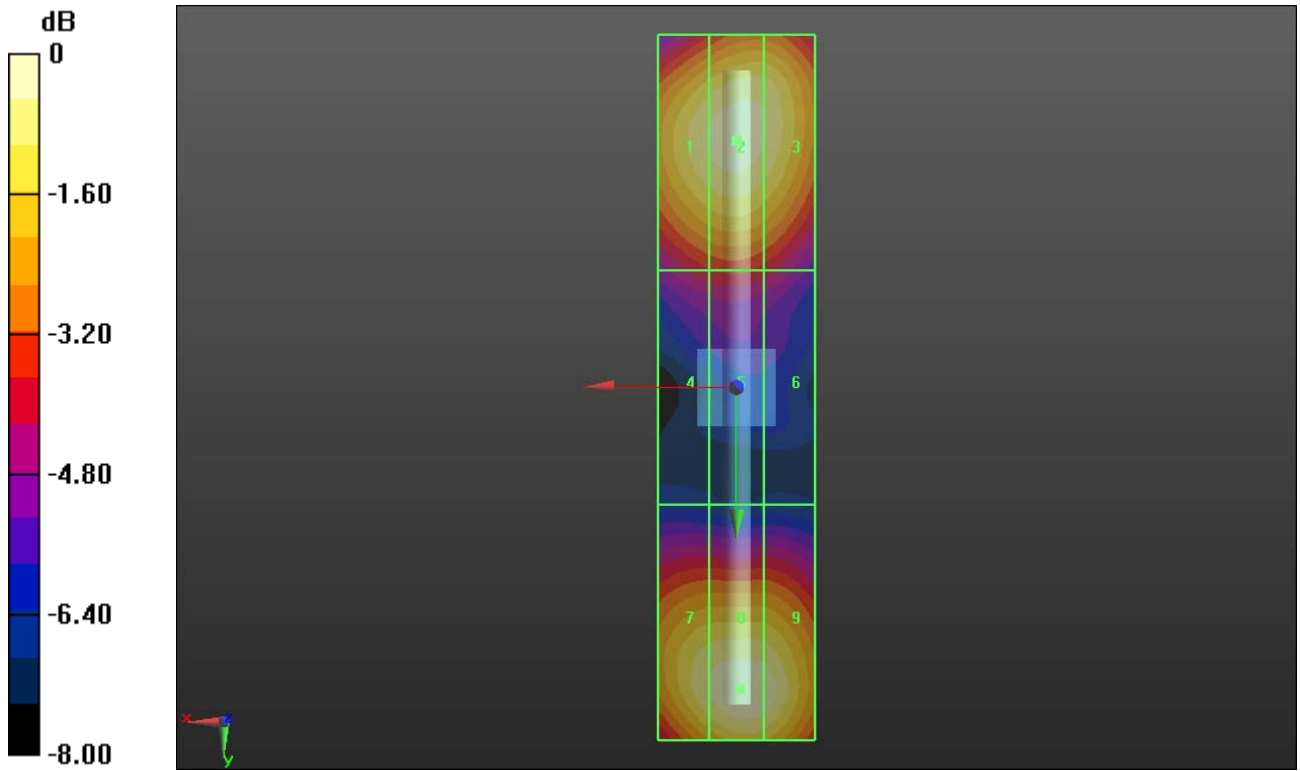

0 dB = 142.9V/m

HAC_H_Dipole_835_121224

DUT: HAC-Dipole 835 MHz

Communication System: CW; Frequency: 835 MHz; Duty Cycle: 1:1

Medium: Air Medium parameters used: $\sigma = 0$ mho/m, $\epsilon_r = 1$; $\rho = 0$ kg/m³

Ambient Temperature : 23.3 °C

DASY5 Configuration:

- Probe: H3DV6 - SN6187; ; Calibrated: 2012-6-20
- Sensor-Surface: (Fix Surface)
- Electronics: DAE3 Sn360; Calibrated: 2012-11-15
- Phantom: HAC Test Arch with AMCC; Type: SD HAC P01 BA;
- Measurement SW: DASY52, Version 52.8 (2); SEMCAD X Version 14.4.5 (3634)

H Scan - measurement distance from the probe sensor center to CD835 Dipole = 10mm/Hearing Aid Compatibility Test (41x361x1): Measurement grid: dx=5mm, dy=5mm

Probe Modulation Factor = 1.000

Reference Value = 0.484 A/m; Power Drift = 0.23 dB

Maximum value of peak Total field = 0.462 A/m

Peak H-field in A/m

Grid 1 0.384 M4	Grid 2 0.412 M4	Grid 3 0.399 M4
Grid 4 0.429 M4	Grid 5 0.462 M4	Grid 6 0.449 M4
Grid 7 0.379 M4	Grid 8 0.413 M4	Grid 9 0.401 M4

Cursor:

Total = 0.462 A/m

H Category: M4

Location: -1, 0, 4.7 mm

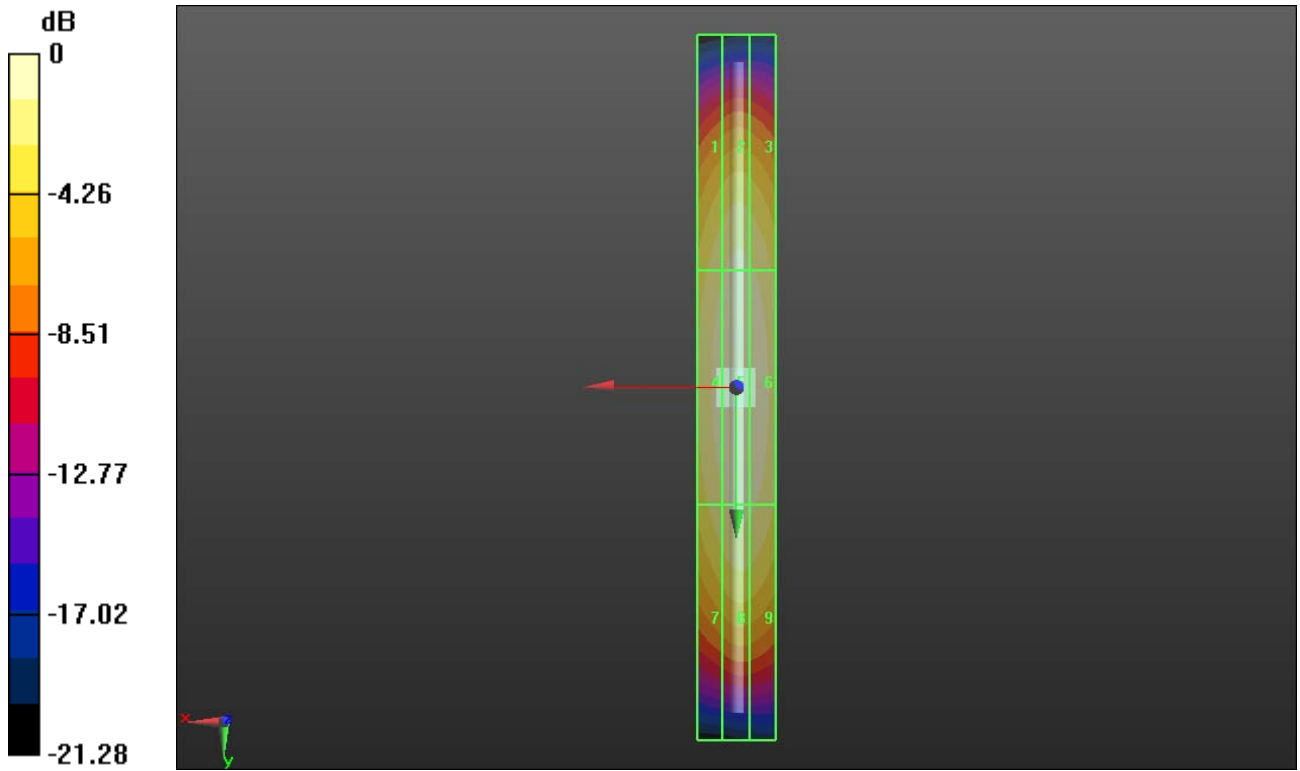

0 dB = 0.460A/m

HAC_H_Dipole_1880_121224

DUT: HAC Dipole 1880 MHz

Communication System: CW; Frequency: 1880 MHz; Duty Cycle: 1:1

Medium: Air Medium parameters used: $\sigma = 0$ mho/m, $\epsilon_r = 1$; $\rho = 0$ kg/m³

Ambient Temperature : 23.3 °C

DASY5 Configuration:

- Probe: H3DV6 - SN6187; ; Calibrated: 2012-6-20
- Sensor-Surface: (Fix Surface)
- Electronics: DAE3 Sn360; Calibrated: 2012-11-15
- Phantom: HAC Test Arch with AMCC; Type: SD HAC P01 BA;
- Measurement SW: DASY52, Version 52.8 (2); SEMCAD X Version 14.4.5 (3634)

H Scan - measurement distance from the probe sensor center to CD1880 Dipole = 10mm/Hearing Aid Compatibility Test (41x181x1): Measurement grid: dx=5mm, dy=5mm

Probe Modulation Factor = 1.000

Reference Value = 0.476 A/m; Power Drift = -0.06 dB

Maximum value of peak Total field = 0.448 A/m

Peak H-field in A/m

Grid 1 0.382 M2	Grid 2 0.411 M2	Grid 3 0.399 M2
Grid 4 0.417 M2	Grid 5 0.448 M2	Grid 6 0.436 M2
Grid 7 0.382 M2	Grid 8 0.412 M2	Grid 9 0.401 M2

Cursor:

Total = 0.448 A/m

H Category: M2

Location: -1, 0, 4.7 mm

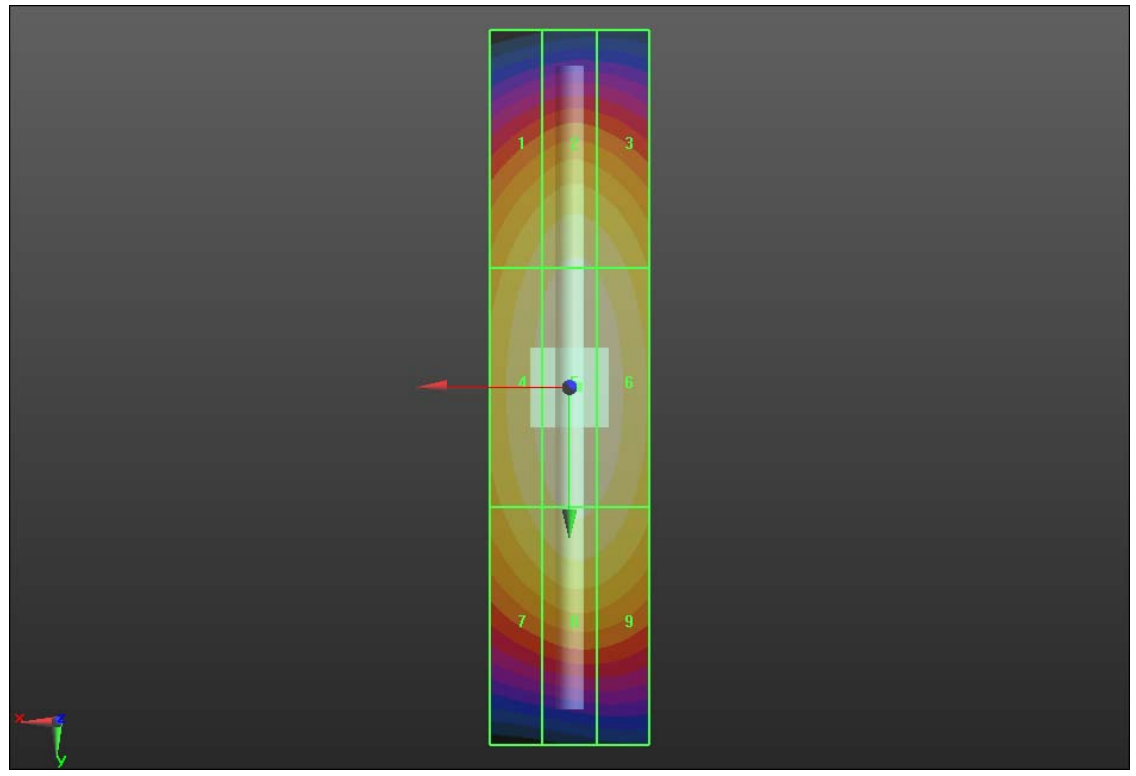
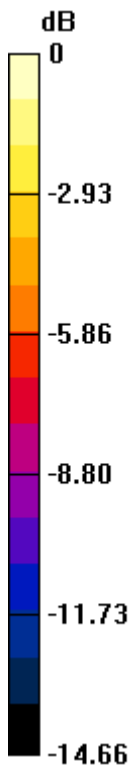

0 dB = 0.450A/m



Appendix B. Plots of RF Emission Measurement

The plots are shown as follows.

#01 HAC RF_CDMA2000 BC0_RC3 SO55_Ch1013_E

DUT: 2D1401

Communication System: CDMA2000; Frequency: 824.7 MHz; Duty Cycle: 1:1

Medium: Air Medium parameters used: $\sigma = 0$ mho/m, $\epsilon_r = 1$; $\rho = 0$ kg/m³

Ambient Temperature : 23.3 °C

DASY5 Configuration:

- Probe: ER3DV6 - SN2302; ConvF(1, 1, 1); Calibrated: 2012-6-20
- Sensor-Surface: (Fix Surface)
- Electronics: DAE3 Sn360; Calibrated: 2012-11-15
- Phantom: HAC Test Arch with AMCC; Type: SD HAC P01 BA;
- Measurement SW: DASY52, Version 52.8 (2); SEMCAD X Version 14.4.5 (3634)

Ch1013/Hearing Aid Compatibility Test (101x101x1): Measurement grid: dx=5mm, dy=5mm

Maximum value of peak Total field = 80.624 V/m

Probe Modulation Factor = 1.140

Device Reference Point: 0, 0, -6.3 mm

Reference Value = 92.910 V/m; Power Drift = 0.04 dB

Hearing Aid Near-Field Category: M4 (AWF 0 dB)

Peak E-field in V/m

Grid 1 75.492 M4	Grid 2 78.819 M4	Grid 3 72.549 M4
Grid 4 76.691 M4	Grid 5 80.624 M4	Grid 6 74.294 M4
Grid 7 75.414 M4	Grid 8 79.409 M4	Grid 9 73.228 M4

Cursor:

Total = 80.624 V/m

E Category: M4

Location: 0.5, 0.5, 8.7 mm

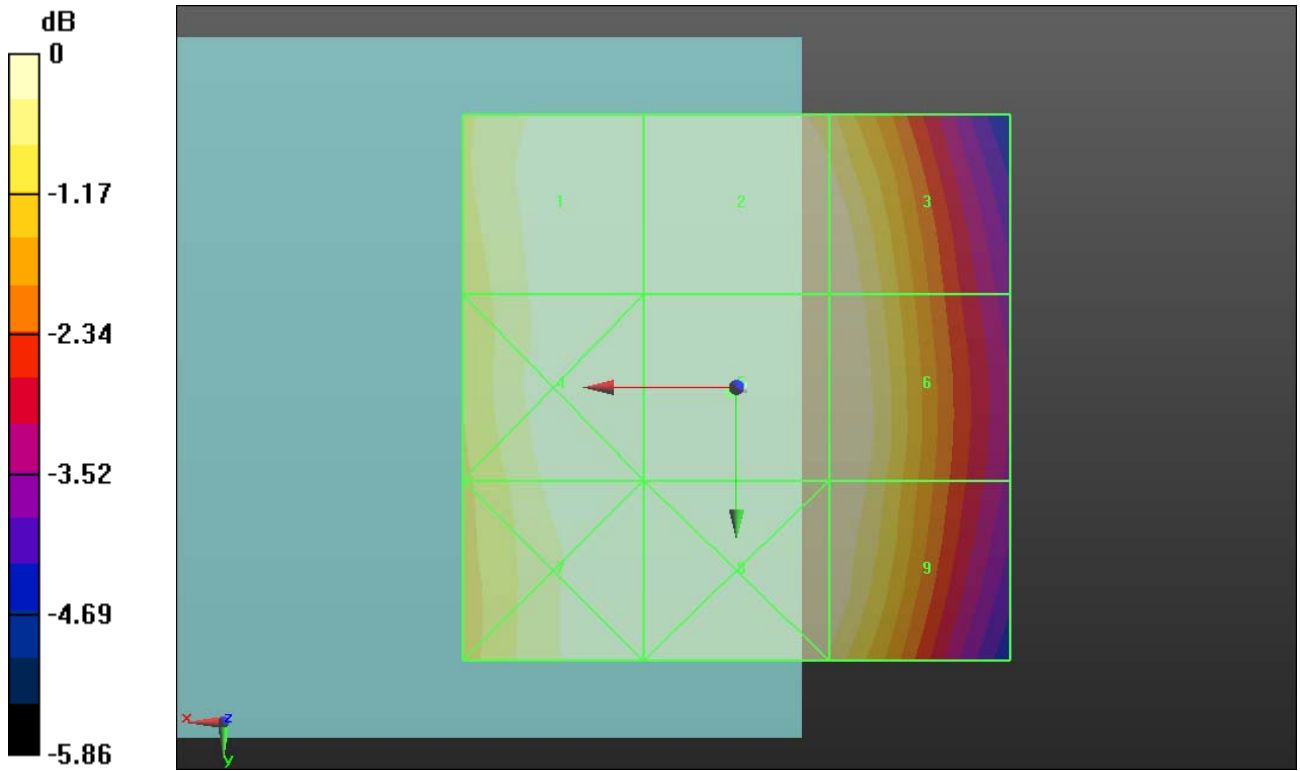

0 dB = 70.720V/m

#02 HAC RF_CDMA2000 BC0_RC3 SO55_Ch384_E

DUT: 2D1401

Communication System: CDMA2000; Frequency: 836.52 MHz; Duty Cycle: 1:1

Medium: Air Medium parameters used: $\sigma = 0$ mho/m, $\epsilon_r = 1$; $\rho = 0$ kg/m³

Ambient Temperature : 23.3 °C

DASY5 Configuration:

- Probe: ER3DV6 - SN2302; ConvF(1, 1, 1); Calibrated: 2012-6-20
- Sensor-Surface: (Fix Surface)
- Electronics: DAE3 Sn360; Calibrated: 2012-11-15
- Phantom: HAC Test Arch with AMCC; Type: SD HAC P01 BA;
- Measurement SW: DASY52, Version 52.8 (2); SEMCAD X Version 14.4.5 (3634)

Ch384/Hearing Aid Compatibility Test (101x101x1): Measurement grid: dx=5mm, dy=5mm

Maximum value of peak Total field = 88.321 V/m

Probe Modulation Factor = 1.140

Device Reference Point: 0, 0, -6.3 mm

Reference Value = 102.6 V/m; Power Drift = -0.03 dB

Hearing Aid Near-Field Category: M4 (AWF 0 dB)

Peak E-field in V/m

Grid 1 83.401 M4	Grid 2 87.280 M4	Grid 3 80.356 M4
Grid 4 84.503 M4	Grid 5 88.321 M4	Grid 6 81.519 M4
Grid 7 82.460 M4	Grid 8 87.083 M4	Grid 9 80.482 M4

Cursor:

Total = 88.321 V/m

E Category: M4

Location: 0.5, 0, 8.7 mm

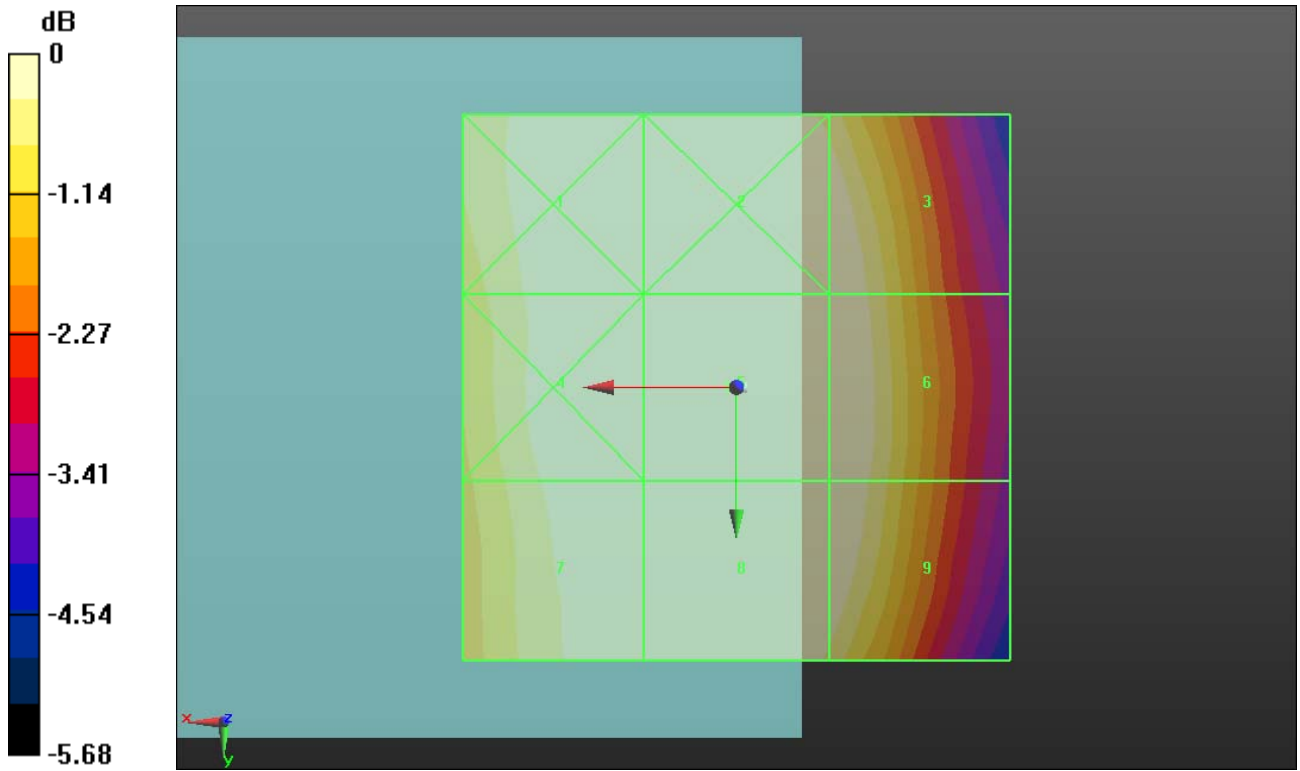

0 dB = 77.470V/m

#03 HAC RF_CDMA2000 BC0_RC3 SO55_Ch777_E

DUT: 2D1401

Communication System: CDMA2000; Frequency: 848.31 MHz; Duty Cycle: 1:1

Medium: Air Medium parameters used: $\sigma = 0$ mho/m, $\epsilon_r = 1$; $\rho = 0$ kg/m³

Ambient Temperature : 23.3 °C

DASY5 Configuration:

- Probe: ER3DV6 - SN2302; ConvF(1, 1, 1); Calibrated: 2012-6-20
- Sensor-Surface: (Fix Surface)
- Electronics: DAE3 Sn360; Calibrated: 2012-11-15
- Phantom: HAC Test Arch with AMCC; Type: SD HAC P01 BA;
- Measurement SW: DASY52, Version 52.8 (2); SEMCAD X Version 14.4.5 (3634)

Ch777/Hearing Aid Compatibility Test (101x101x1): Measurement grid: dx=5mm, dy=5mm

Maximum value of peak Total field = 91.655 V/m

Probe Modulation Factor = 1.140

Device Reference Point: 0, 0, -6.3 mm

Reference Value = 104.5 V/m; Power Drift = 0.05 dB

Hearing Aid Near-Field Category: M4 (AWF 0 dB)

Peak E-field in V/m

Grid 1 86.157 M4	Grid 2 89.610 M4	Grid 3 82.479 M4
Grid 4 87.075 M4	Grid 5 91.655 M4	Grid 6 84.242 M4
Grid 7 85.376 M4	Grid 8 90.277 M4	Grid 9 83.419 M4

Cursor:

Total = 91.655 V/m

E Category: M4

Location: 1, 1, 8.7 mm

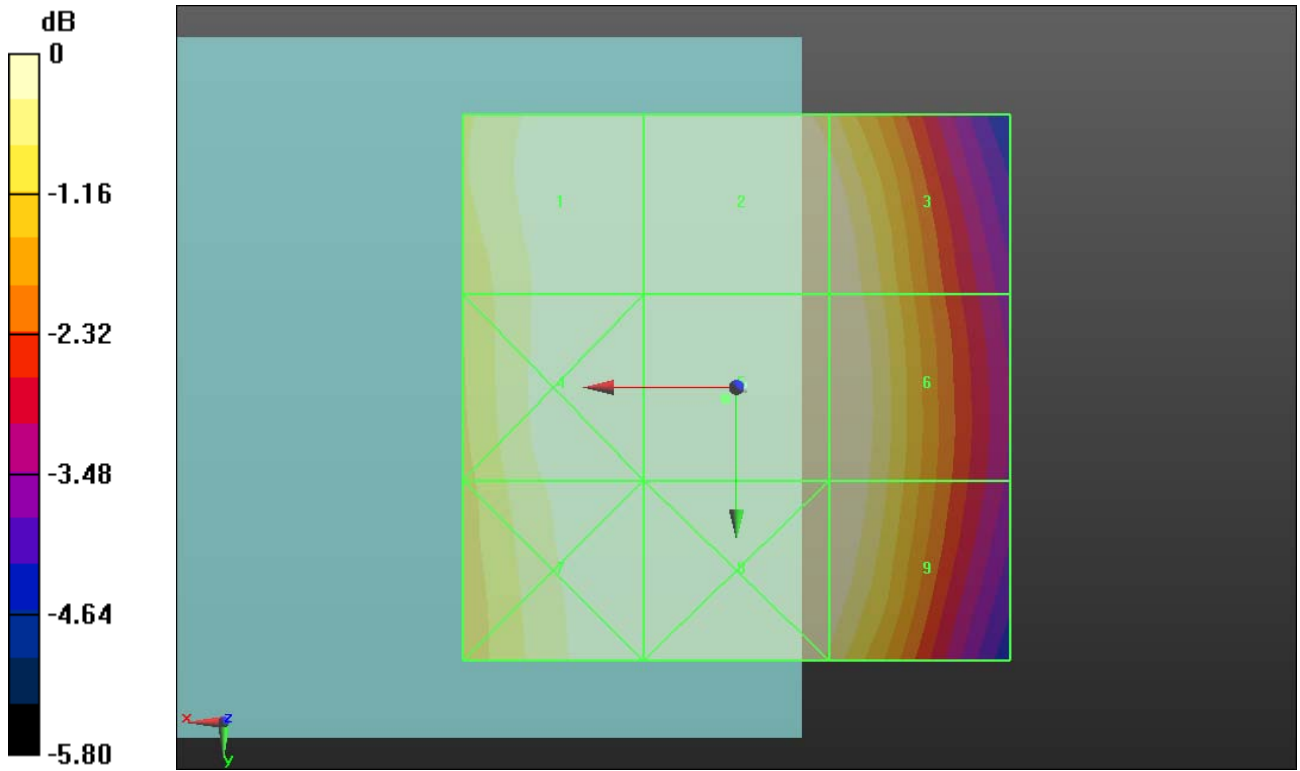

0 dB = 80.400V/m

#04 HAC RF_CDMA2000 BC1_RC3 SO55_Ch25_E

DUT: 2D1401

Communication System: CDMA2000; Frequency: 1851.25 MHz; Duty Cycle: 1:1

Medium: Air Medium parameters used: $\sigma = 0$ mho/m, $\epsilon_r = 1$; $\rho = 0$ kg/m³

Ambient Temperature : 23.3 °C

DASY5 Configuration:

- Probe: ER3DV6 - SN2302; ConvF(1, 1, 1); Calibrated: 2012-6-20
- Sensor-Surface: (Fix Surface)
- Electronics: DAE3 Sn360; Calibrated: 2012-11-15
- Phantom: HAC Test Arch with AMCC; Type: SD HAC P01 BA;
- Measurement SW: DASY52, Version 52.8 (2); SEMCAD X Version 14.4.5 (3634)

Ch25/Hearing Aid Compatibility Test (101x101x1): Measurement grid: dx=5mm, dy=5mm

Maximum value of peak Total field = 40.666 V/m

Probe Modulation Factor = 1.040

Device Reference Point: 0, 0, -6.3 mm

Reference Value = 38.903 V/m; Power Drift = -0.01 dB

Hearing Aid Near-Field Category: M4 (AWF 0 dB)

Peak E-field in V/m

Grid 1 44.224 M4	Grid 2 48.520 M4	Grid 3 45.707 M4
Grid 4 34.308 M4	Grid 5 40.666 M4	Grid 6 39.685 M4
Grid 7 29.062 M4	Grid 8 27.952 M4	Grid 9 27.967 M4

Cursor:

Total = 48.520 V/m

E Category: M4

Location: -0.5, -25, 8.7 mm

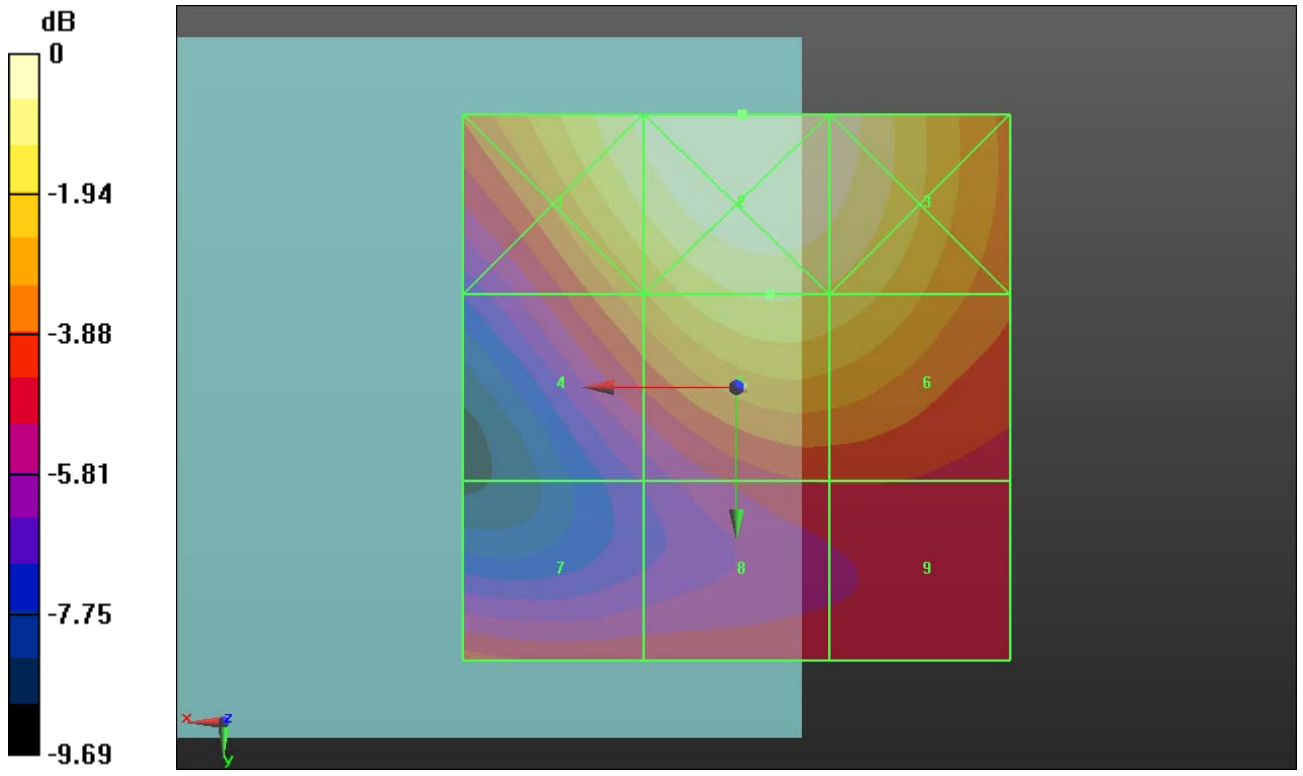

0 dB = 46.650V/m

#05 HAC RF_CDMA2000 BC1_RC3 SO55_Ch600_E

DUT: 2D1401

Communication System: CDMA2000; Frequency: 1880 MHz; Duty Cycle: 1:1

Medium: Air Medium parameters used: $\sigma = 0$ mho/m, $\epsilon_r = 1$; $\rho = 0$ kg/m³

Ambient Temperature : 23.3 °C

DASY5 Configuration:

- Probe: ER3DV6 - SN2302; ConvF(1, 1, 1); Calibrated: 2012-6-20
- Sensor-Surface: (Fix Surface)
- Electronics: DAE3 Sn360; Calibrated: 2012-11-15
- Phantom: HAC Test Arch with AMCC; Type: SD HAC P01 BA;
- Measurement SW: DASY52, Version 52.8 (2); SEMCAD X Version 14.4.5 (3634)

Ch600/Hearing Aid Compatibility Test (101x101x1): Measurement grid: dx=5mm, dy=5mm

Maximum value of peak Total field = 43.399 V/m

Probe Modulation Factor = 1.040

Device Reference Point: 0, 0, -6.3 mm

Reference Value = 41.145 V/m; Power Drift = 0.03 dB

Hearing Aid Near-Field Category: M4 (AWF 0 dB)

Peak E-field in V/m

Grid 1 47.636 M4	Grid 2 52.350 M4	Grid 3 49.199 M4
Grid 4 36.697 M4	Grid 5 43.399 M4	Grid 6 42.324 M4
Grid 7 31.122 M4	Grid 8 30.264 M4	Grid 9 29.177 M4

Cursor:

Total = 52.350 V/m

E Category: M4

Location: -1, -25, 8.7 mm

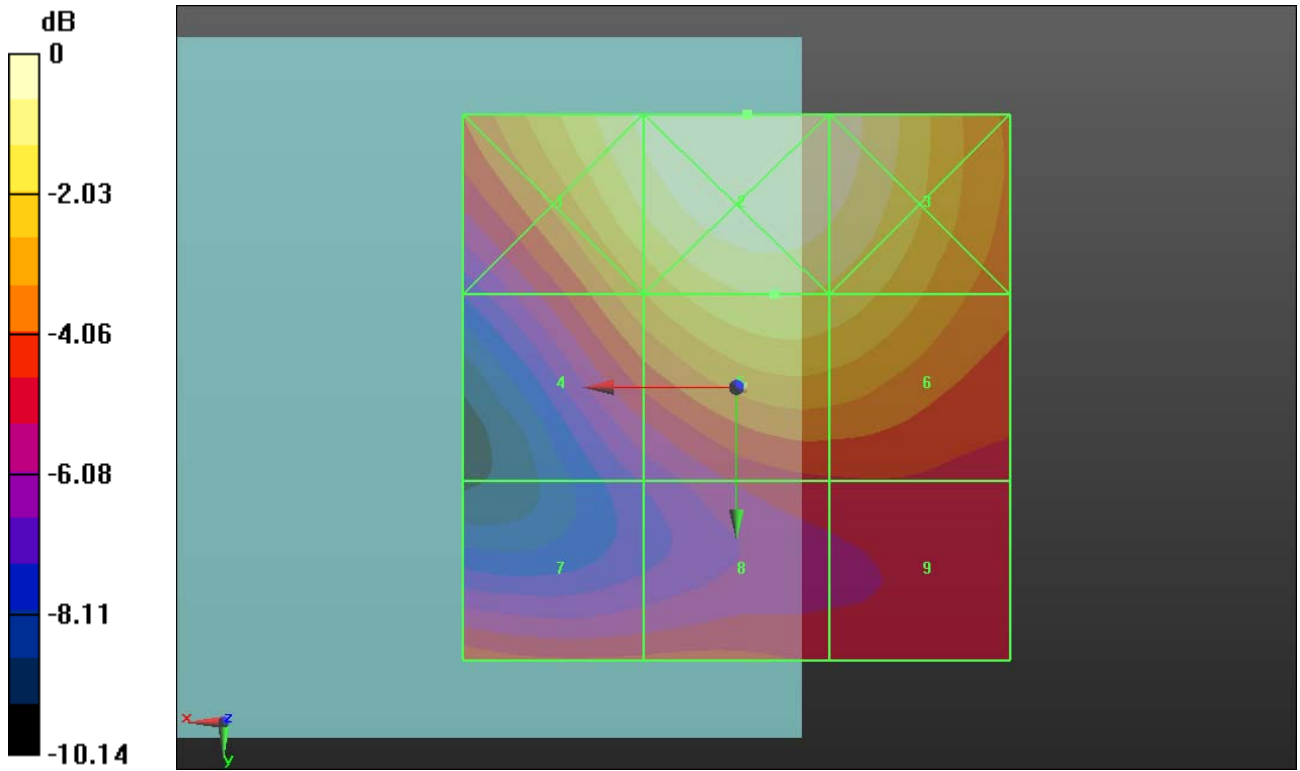

0 dB = 50.340V/m

#06 HAC RF_CDMA2000 BC1_RC3 SO55_Ch1175_E

DUT: 2D1401

Communication System: CDMA2000; Frequency: 1908.75 MHz; Duty Cycle: 1:1

Medium: Air Medium parameters used: $\sigma = 0$ mho/m, $\epsilon_r = 1$; $\rho = 0$ kg/m³

Ambient Temperature : 23.3 °C

DASY5 Configuration:

- Probe: ER3DV6 - SN2302; ConvF(1, 1, 1); Calibrated: 2012-6-20
- Sensor-Surface: (Fix Surface)
- Electronics: DAE3 Sn360; Calibrated: 2012-11-15
- Phantom: HAC Test Arch with AMCC; Type: SD HAC P01 BA;
- Measurement SW: DASY52, Version 52.8 (2); SEMCAD X Version 14.4.5 (3634)

Ch1175/Hearing Aid Compatibility Test (101x101x1): Measurement grid: dx=5mm, dy=5mm

Maximum value of peak Total field = 43.560 V/m

Probe Modulation Factor = 1.040

Device Reference Point: 0, 0, -6.3 mm

Reference Value = 41.854 V/m; Power Drift = 0.08 dB

Hearing Aid Near-Field Category: M4 (AWF 0 dB)

Peak E-field in V/m

Grid 1 45.590 M4	Grid 2 51.469 M4	Grid 3 49.182 M4
Grid 4 35.477 M4	Grid 5 43.560 M4	Grid 6 42.720 M4
Grid 7 30.339 M4	Grid 8 31.047 M4	Grid 9 30.781 M4

Cursor:

Total = 51.469 V/m

E Category: M4

Location: -1.5, -25, 8.7 mm

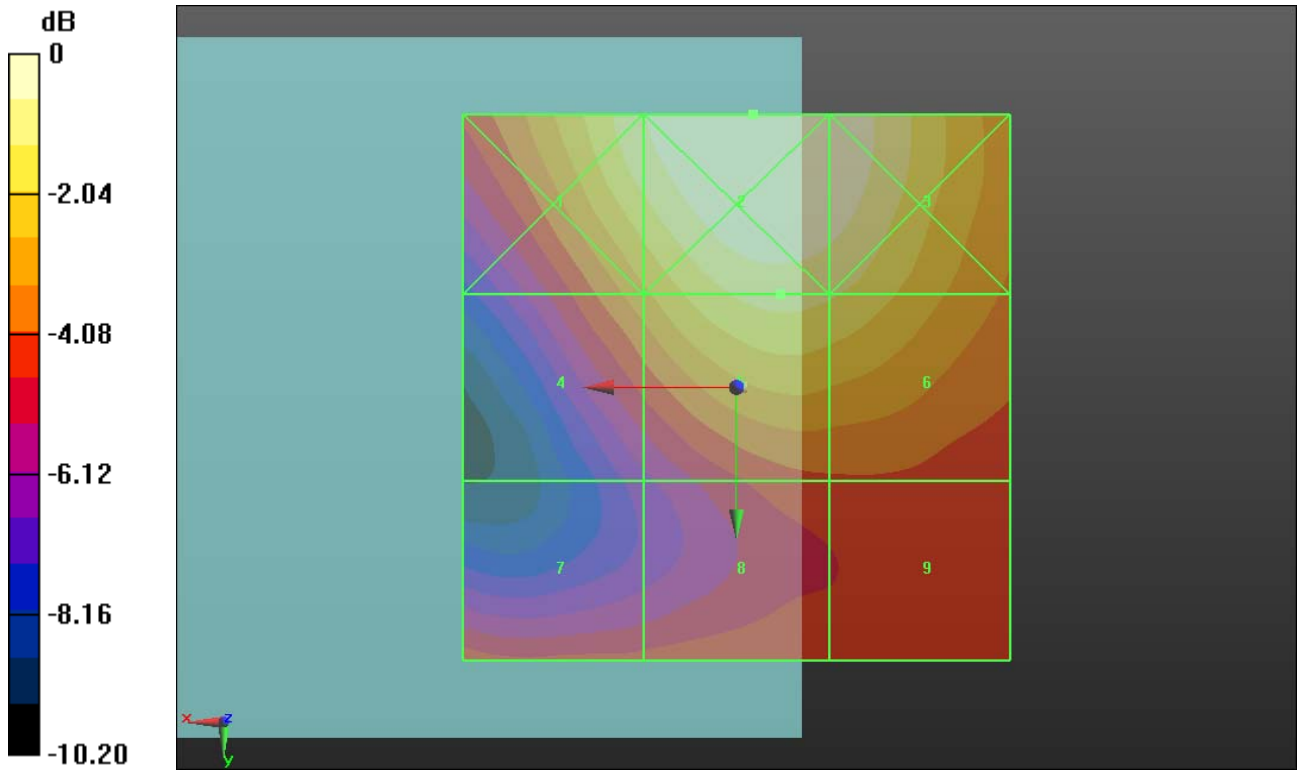

0 dB = 49.490V/m

#01 HAC RF_CDMA2000 BC0_RC3 SO55_Ch1013_H

DUT: 2D1401

Communication System: CDMA2000; Frequency: 824.7 MHz; Duty Cycle: 1:1

Medium: Air Medium parameters used: $\sigma = 0$ mho/m, $\epsilon_r = 1$; $\rho = 0$ kg/m³

Ambient Temperature : 23.3 °C

DASY5 Configuration:

- Probe: H3DV6 - SN6187; ; Calibrated: 2012-6-20
- Sensor-Surface: (Fix Surface)
- Electronics: DAE3 Sn360; Calibrated: 2012-11-15
- Phantom: HAC Test Arch with AMCC; Type: SD HAC P01 BA;
- Measurement SW: DASY52, Version 52.8 (2); SEMCAD X Version 14.4.5 (3634)

Ch1013/Hearing Aid Compatibility Test (101x101x1): Measurement grid: dx=5mm, dy=5mm

Maximum value of peak Total field = 0.141 A/m

Probe Modulation Factor = 1.020

Device Reference Point: 0, 0, -6.3 mm

Reference Value = 0.074 A/m; Power Drift = 0.06 dB

Hearing Aid Near-Field Category: M4 (AWF 0 dB)

Peak H-field in A/m

Grid 1 0.138 M4	Grid 2 0.098 M4	Grid 3 0.060 M4
Grid 4 0.132 M4	Grid 5 0.095 M4	Grid 6 0.056 M4
Grid 7 0.141 M4	Grid 8 0.097 M4	Grid 9 0.056 M4

Cursor:

Total = 0.141 A/m

H Category: M4

Location: 25, 25, 8.7 mm

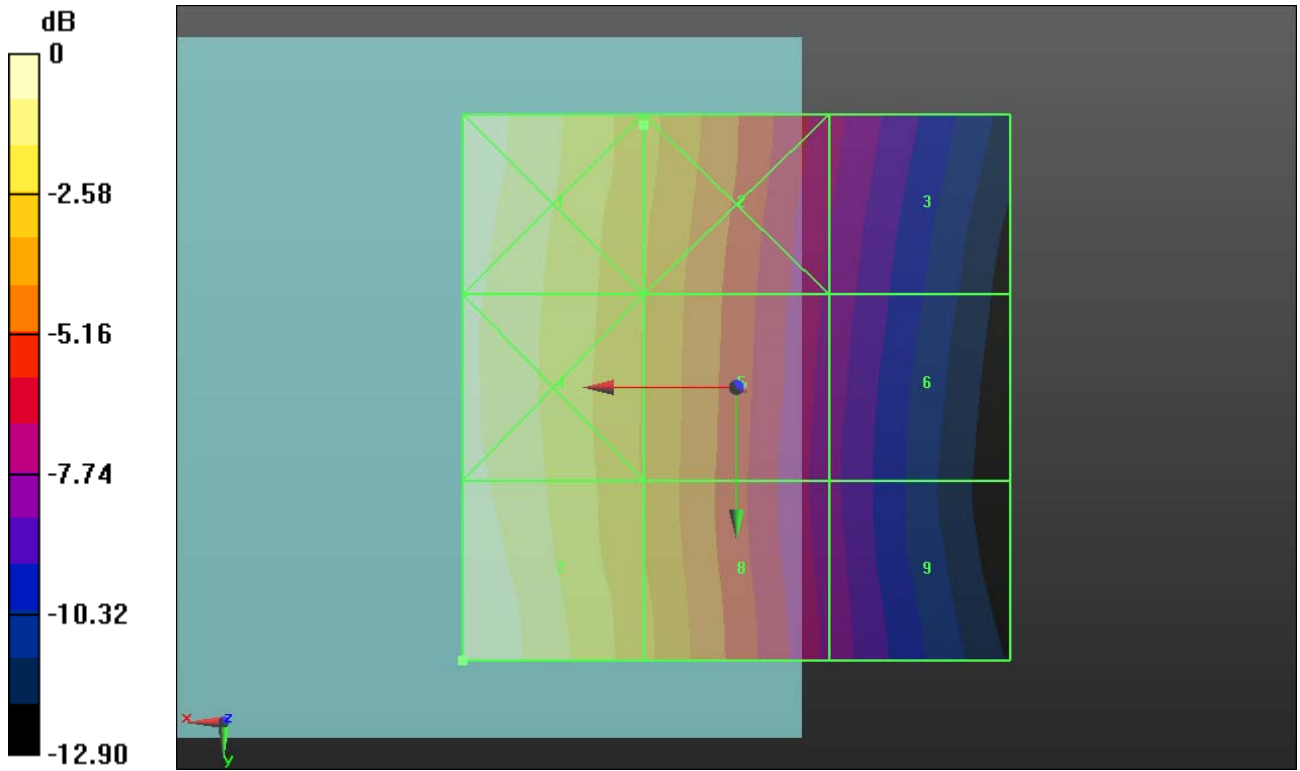

0 dB = 0.140A/m

#02 HAC RF_CDMA2000 BC0_RC3 SO55_Ch384_H

DUT: 2D1401

Communication System: CDMA2000; Frequency: 836.52 MHz; Duty Cycle: 1:1

Medium: Air Medium parameters used: $\sigma = 0$ mho/m, $\epsilon_r = 1$; $\rho = 0$ kg/m³

Ambient Temperature : 23.3 °C

DASY5 Configuration:

- Probe: H3DV6 - SN6187; ; Calibrated: 2012-6-20
- Sensor-Surface: (Fix Surface)
- Electronics: DAE3 Sn360; Calibrated: 2012-11-15
- Phantom: HAC Test Arch with AMCC; Type: SD HAC P01 BA;
- Measurement SW: DASY52, Version 52.8 (2); SEMCAD X Version 14.4.5 (3634)

Ch384/Hearing Aid Compatibility Test (101x101x1): Measurement grid: dx=5mm, dy=5mm

Maximum value of peak Total field = 0.156 A/m

Probe Modulation Factor = 1.020

Device Reference Point: 0, 0, -6.3 mm

Reference Value = 0.082 A/m; Power Drift = 0.09 dB

Hearing Aid Near-Field Category: M4 (AWF 0 dB)

Peak H-field in A/m

Grid 1 0.156 M4	Grid 2 0.111 M4	Grid 3 0.067 M4
Grid 4 0.147 M4	Grid 5 0.105 M4	Grid 6 0.062 M4
Grid 7 0.155 M4	Grid 8 0.106 M4	Grid 9 0.061 M4

Cursor:

Total = 0.156 A/m

H Category: M4

Location: 25, -25, 8.7 mm

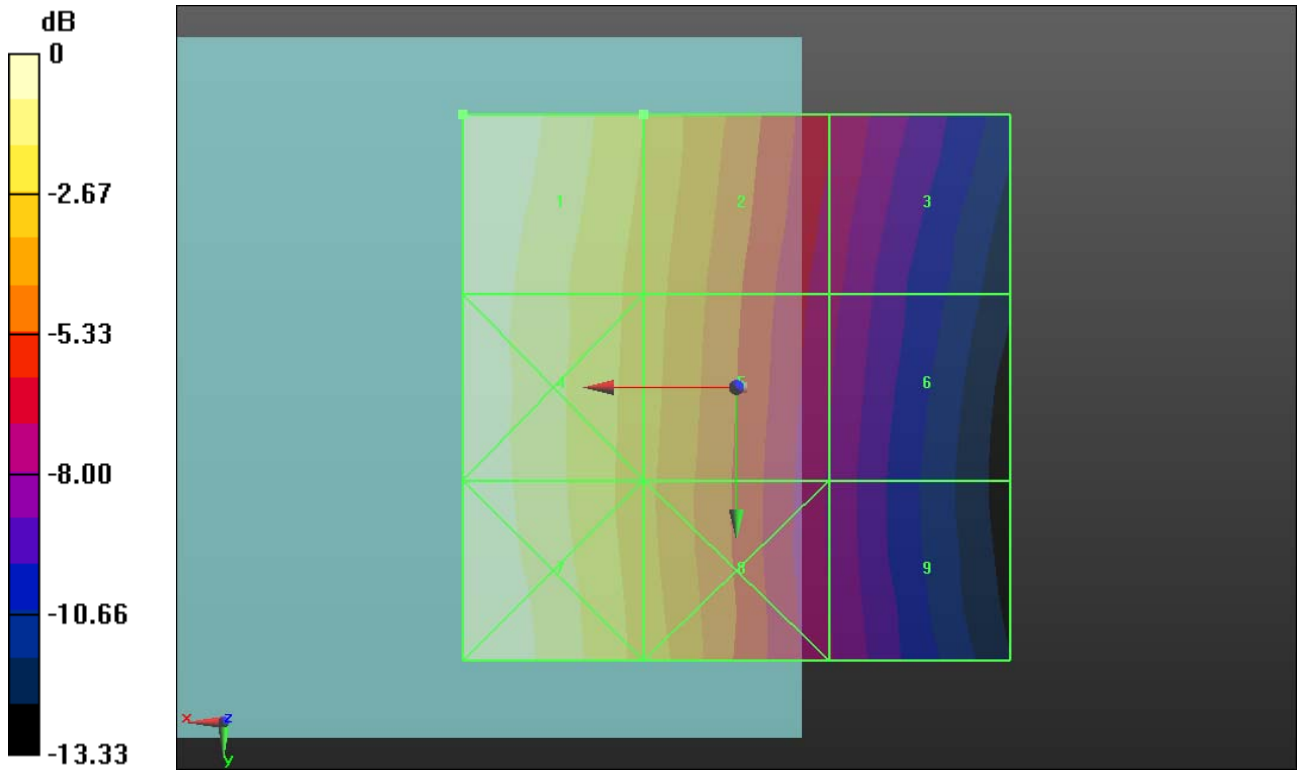

0 dB = 0.150A/m

#03 HAC RF_CDMA2000 BC0_RC3 SO55_Ch777_H

DUT: 2D1401

Communication System: CDMA2000; Frequency: 848.31 MHz; Duty Cycle: 1:1

Medium: Air Medium parameters used: $\sigma = 0$ mho/m, $\epsilon_r = 1$; $\rho = 0$ kg/m³

Ambient Temperature : 23.3 °C

DASY5 Configuration:

- Probe: H3DV6 - SN6187; ; Calibrated: 2012-6-20
- Sensor-Surface: (Fix Surface)
- Electronics: DAE3 Sn360; Calibrated: 2012-11-15
- Phantom: HAC Test Arch with AMCC; Type: SD HAC P01 BA;
- Measurement SW: DASY52, Version 52.8 (2); SEMCAD X Version 14.4.5 (3634)

Ch777/Hearing Aid Compatibility Test (101x101x1): Measurement grid: dx=5mm, dy=5mm

Maximum value of peak Total field = 0.162 A/m

Probe Modulation Factor = 1.020

Device Reference Point: 0, 0, -6.3 mm

Reference Value = 0.084 A/m; Power Drift = 0.09 dB

Hearing Aid Near-Field Category: M4 (AWF 0 dB)

Peak H-field in A/m

Grid 1 0.161 M4	Grid 2 0.113 M4	Grid 3 0.069 M4
Grid 4 0.152 M4	Grid 5 0.109 M4	Grid 6 0.064 M4
Grid 7 0.162 M4	Grid 8 0.111 M4	Grid 9 0.063 M4

Cursor:

Total = 0.162 A/m

H Category: M4

Location: 25, 25, 8.7 mm

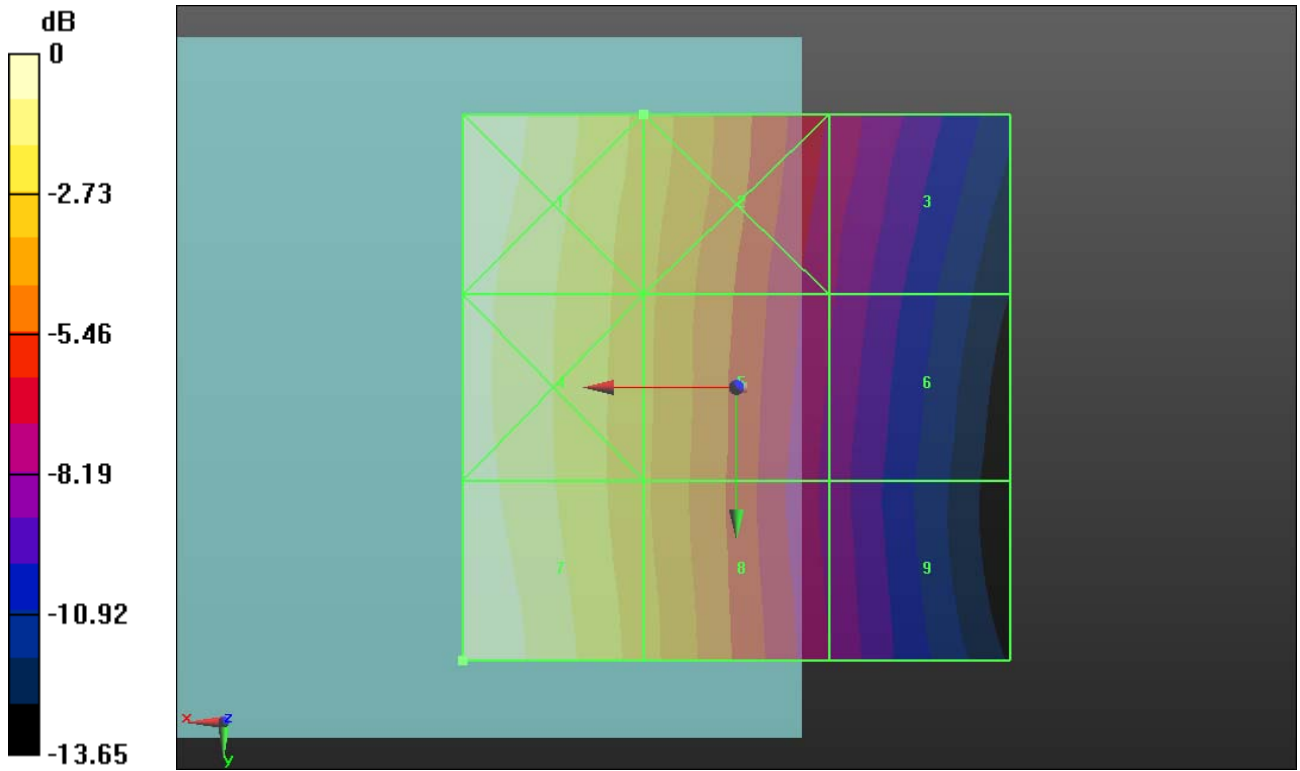

0 dB = 0.160A/m

#04 HAC RF_CDMA2000 BC1_RC3 SO55_Ch25_H

DUT: 2D1401

Communication System: CDMA2000; Frequency: 1851.25 MHz; Duty Cycle: 1:1

Medium: Air Medium parameters used: $\sigma = 0$ mho/m, $\epsilon_r = 1$; $\rho = 0$ kg/m³

Ambient Temperature : 23.3 °C

DASY5 Configuration:

- Probe: H3DV6 - SN6187; ; Calibrated: 2012-6-20
- Sensor-Surface: (Fix Surface)
- Electronics: DAE3 Sn360; Calibrated: 2012-11-15
- Phantom: HAC Test Arch with AMCC; Type: SD HAC P01 BA;
- Measurement SW: DASY52, Version 52.8 (2); SEMCAD X Version 14.4.5 (3634)

Ch25/Hearing Aid Compatibility Test (101x101x1): Measurement grid: dx=5mm, dy=5mm

Maximum value of peak Total field = 0.112 A/m

Probe Modulation Factor = 1.070

Device Reference Point: 0, 0, -6.3 mm

Reference Value = 0.112 A/m; Power Drift = -0.13 dB

Hearing Aid Near-Field Category: M4 (AWF 0 dB)

Peak H-field in A/m

Grid 1 0.126 M4	Grid 2 0.097 M4	Grid 3 0.088 M4
Grid 4 0.103 M4	Grid 5 0.110 M4	Grid 6 0.107 M4
Grid 7 0.110 M4	Grid 8 0.112 M4	Grid 9 0.109 M4

Cursor:

Total = 0.126 A/m

H Category: M4

Location: 25, -25, 8.7 mm

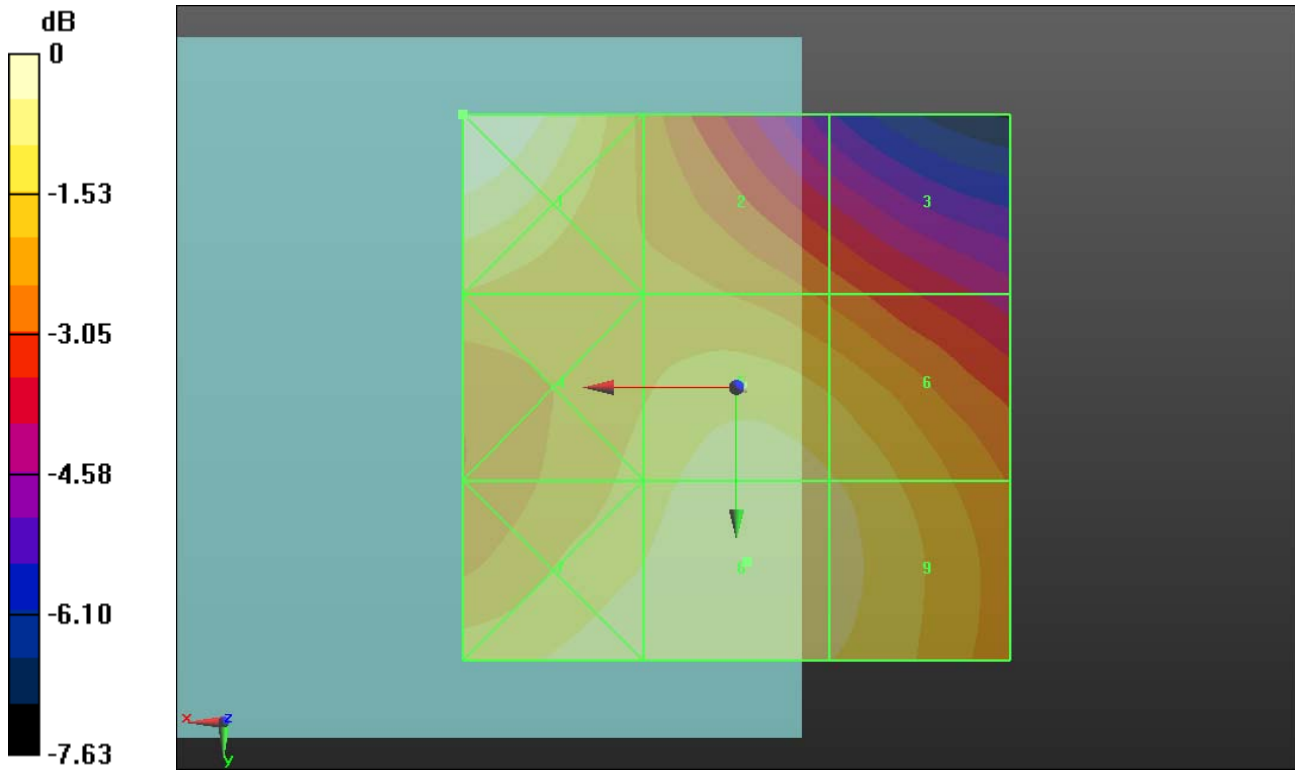

0 dB = 0.120A/m

#05 HAC RF_CDMA2000 BC1_RC3 SO55_Ch600_H

DUT: 2D1401

Communication System: CDMA2000; Frequency: 1880 MHz; Duty Cycle: 1:1

Medium: Air Medium parameters used: $\sigma = 0$ mho/m, $\epsilon_r = 1$; $\rho = 0$ kg/m³

Ambient Temperature : 23.3 °C

DASY5 Configuration:

- Probe: H3DV6 - SN6187; ; Calibrated: 2012-6-20
- Sensor-Surface: (Fix Surface)
- Electronics: DAE3 Sn360; Calibrated: 2012-11-15
- Phantom: HAC Test Arch with AMCC; Type: SD HAC P01 BA;
- Measurement SW: DASY52, Version 52.8 (2); SEMCAD X Version 14.4.5 (3634)

Ch600/Hearing Aid Compatibility Test (101x101x1): Measurement grid: dx=5mm, dy=5mm

Maximum value of peak Total field = 0.125 A/m

Probe Modulation Factor = 1.070

Device Reference Point: 0, 0, -6.3 mm

Reference Value = 0.128 A/m; Power Drift = -0.19 dB

Hearing Aid Near-Field Category: M4 (AWF 0 dB)

Peak H-field in A/m

Grid 1 0.139 M4	Grid 2 0.110 M4	Grid 3 0.101 M4
Grid 4 0.115 M4	Grid 5 0.123 M4	Grid 6 0.120 M4
Grid 7 0.119 M4	Grid 8 0.125 M4	Grid 9 0.121 M4

Cursor:

Total = 0.139 A/m

H Category: M4

Location: 25, -25, 8.7 mm

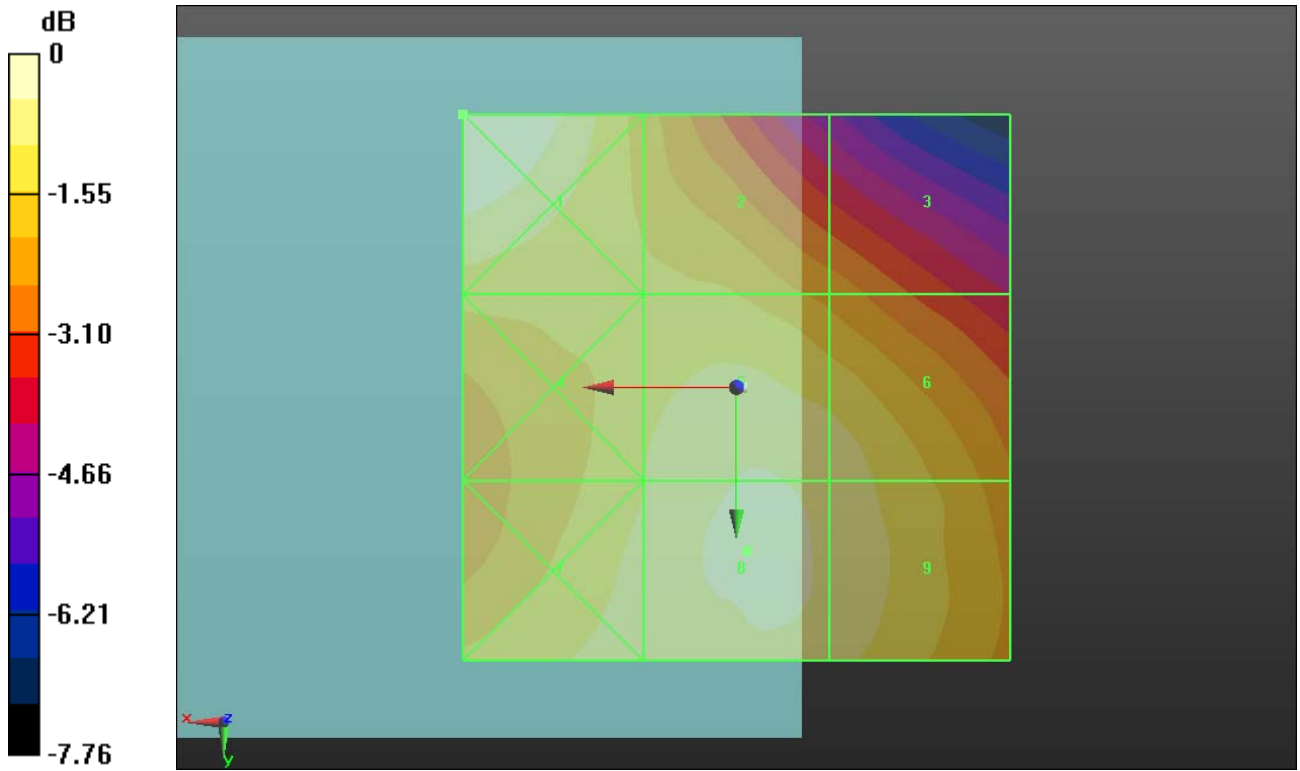

0 dB = 0.130A/m

#06 HAC RF_CDMA2000 BC1_RC3 SO55_Ch1175_H

DUT: 2D1401

Communication System: CDMA2000; Frequency: 1908.75 MHz; Duty Cycle: 1:1

Medium: Air Medium parameters used: $\sigma = 0$ mho/m, $\epsilon_r = 1$; $\rho = 0$ kg/m³

Ambient Temperature : 23.3 °C

DASY5 Configuration:

- Probe: H3DV6 - SN6187; ; Calibrated: 2012-6-20
- Sensor-Surface: (Fix Surface)
- Electronics: DAE3 Sn360; Calibrated: 2012-11-15
- Phantom: HAC Test Arch with AMCC; Type: SD HAC P01 BA;
- Measurement SW: DASY52, Version 52.8 (2); SEMCAD X Version 14.4.5 (3634)

Ch1175/Hearing Aid Compatibility Test (101x101x1): Measurement grid: dx=5mm, dy=5mm

Maximum value of peak Total field = 0.122 A/m

Probe Modulation Factor = 1.070

Device Reference Point: 0, 0, -6.3 mm

Reference Value = 0.122 A/m; Power Drift = -0.13 dB

Hearing Aid Near-Field Category: M4 (AWF 0 dB)

Peak H-field in A/m

Grid 1 0.145 M4	Grid 2 0.112 M4	Grid 3 0.098 M4
Grid 4 0.115 M4	Grid 5 0.121 M4	Grid 6 0.117 M4
Grid 7 0.119 M4	Grid 8 0.122 M4	Grid 9 0.119 M4

Cursor:

Total = 0.145 A/m

H Category: M4

Location: 25, -25, 8.7 mm

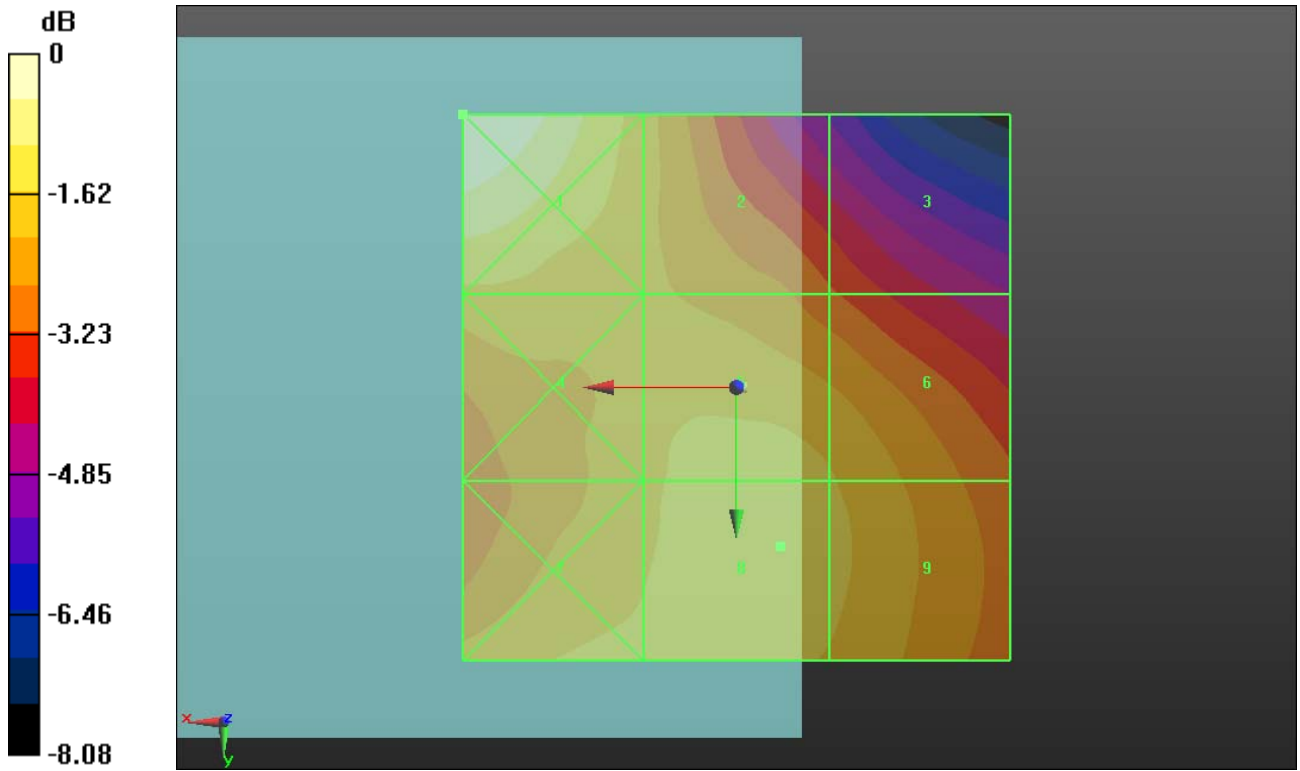

0 dB = 0.140A/m



Appendix C. DASYS Calibration Certificate

The DASYS calibration certificates are shown as follows.



Accredited by the Swiss Accreditation Service (SAS)
The Swiss Accreditation Service is one of the signatories to the EA
Multilateral Agreement for the recognition of calibration certificates

Accreditation No.: **SCS 108**

Client **Sporton-TW (Auden)**

Certificate No: **CD835V3-1045_Jun12**

CALIBRATION CERTIFICATE

Object **CD835V3 - SN: 1045**

Calibration procedure(s) **QA CAL-20.v6
Calibration procedure for dipoles in air**

Calibration date: **June 14, 2012**

This calibration certificate documents the traceability to national standards, which realize the physical units of measurements (SI).
The measurements and the uncertainties with confidence probability are given on the following pages and are part of the certificate.

All calibrations have been conducted in the closed laboratory facility: environment temperature (22 ± 3)°C and humidity < 70%.

Calibration Equipment used (M&TE critical for calibration)

Primary Standards	ID #	Cal Date (Certificate No.)	Scheduled Calibration
Power meter EPM-442A	GB37480704	05-Oct-11 (No. 217-01451)	Oct-12
Power sensor HP 8481A	US37292783	05-Oct-11 (No. 217-01451)	Oct-12
Probe ER3DV6	SN: 2336	29-Dec-11 (No. ER3-2336_Dec11)	Dec-12
Probe H3DV6	SN: 6065	29-Dec-11 (No. H3-6065_Dec11)	Dec-12
DAE4	SN: 781	29-May-12 (No. DAE4-781_May12)	May-13

Secondary Standards	ID #	Check Date (in house)	Scheduled Check
Power meter Agilent 4419B	SN: GB42420191	09-Oct-09 (in house check Oct-11)	In house check: Oct-12
Power sensor HP 8482H	SN: 3318A09450	09-Oct-09 (in house check Oct-11)	In house check: Oct-12
Power sensor HP 8482A	SN: US37295597	09-Oct-09 (in house check Oct-11)	In house check: Oct-12
Network Analyzer HP 8753E	US37390585	18-Oct-01 (in house check Oct-11)	In house check: Oct-12
RF generator E4433B	MY 41000675	03-Nov-04 (in house check Oct-11)	In house check: Oct-13

Calibrated by: **Claudio Leubler** Name: Claudio Leubler Function: Laboratory Technician

Approved by: **Katja Pokovic** Name: Katja Pokovic Function: Technical Manager

Signature

Issued: June 18, 2012

This calibration certificate shall not be reproduced except in full without written approval of the laboratory.



Accredited by the Swiss Accreditation Service (SAS)
The Swiss Accreditation Service is one of the signatories to the EA
Multilateral Agreement for the recognition of calibration certificates

Accreditation No.: **SCS 108**

References

- [1] ANSI-C63.19-2007
American National Standard for Methods of Measurement of Compatibility between Wireless Communications Devices and Hearing Aids.
- [2] ANSI-C63.19-2011
American National Standard, Methods of Measurement of Compatibility between Wireless Communications Devices and Hearing Aids.

Methods Applied and Interpretation of Parameters:

- *Coordinate System:* y-axis is in the direction of the dipole arms. z-axis is from the basis of the antenna (mounted on the table) towards its feed point between the two dipole arms. x-axis is normal to the other axes. In coincidence with the standards [1], the measurement planes (probe sensor center) are selected to be at a distance of 10 mm (15 mm for [2]) above the top metal edge of the dipole arms.
- *Measurement Conditions:* Further details are available from the hardcopies at the end of the certificate. All figures stated in the certificate are valid at the frequency indicated. The forward power to the dipole connector is set with a calibrated power meter connected and monitored with an auxiliary power meter connected to a directional coupler. While the dipole under test is connected, the forward power is adjusted to the same level.
- *Antenna Positioning:* The dipole is mounted on a HAC Test Arch phantom using the matching dipole positioner with the arms horizontal and the feeding cable coming from the floor. The measurements are performed in a shielded room with absorbers around the setup to reduce the reflections. It is verified before the mounting of the dipole under the Test Arch phantom, that its arms are perfectly in a line. It is installed on the HAC dipole positioner with its arms parallel below the dielectric reference wire and able to move elastically in vertical direction without changing its relative position to the top center of the Test Arch phantom. The vertical distance to the probe is adjusted after dipole mounting with a DASY5 Surface Check job. Before the measurement, the distance between phantom surface and probe tip is verified. The proper measurement distance is selected by choosing the matching section of the HAC Test Arch phantom with the proper device reference point (upper surface of the dipole) and the matching grid reference point (tip of the probe) considering the probe sensor offset. The vertical distance to the probe is essential for the accuracy.
- *Feed Point Impedance and Return Loss:* These parameters are measured using a HP 8753E Vector Network Analyzer. The impedance is specified at the SMA connector of the dipole. The influence of reflections was eliminated by applying the averaging function while moving the dipole in the air, at least 70cm away from any obstacles.
- *E-field distribution:* E field is measured in the x-y-plane with an isotropic ER3D-field probe with 100 mW forward power to the antenna feed point. In accordance with [1] and [2], the scan area is 20mm wide, its length exceeds the dipole arm length (180 or 90mm). The sensor center is 10 mm (15 mm for [2]) (in z) above the metal top of the dipole arms. Two 3D maxima are available near the end of the dipole arms. Assuming the dipole arms are perfectly in one line, the average of these two maxima (in subgrid 2 and subgrid 8) is determined to compensate for any non-parallelity to the measurement plane as well as the sensor displacement. The E-field value stated as calibration value represents the maximum of the interpolated 3D-E-field, in the plane above the dipole surface.
- *H-field distribution:* H-field is measured with an isotropic H-field probe with 100mW forward power to the antenna feed point, in the x-y-plane. The scan area and sensor distance is equivalent to the E-field scan. The maximum of the field is available at the center (subgrid 5) above the feed point. The H-field value stated as calibration value represents the maximum of the interpolated H-field, 10mm above the dipole surface at the feed point.

The reported uncertainty of measurement is stated as the standard uncertainty of measurement multiplied by the coverage factor $k=2$, which for a normal distribution corresponds to a coverage probability of approximately 95%.

Measurement Conditions

DASY system configuration, as far as not given on page 1.

DASY Version	DASY5	V52.8.1
Extrapolation	Advanced Extrapolation	
Phantom	HAC Test Arch	
Distance Dipole Top - Probe Center	10mm 15mm	
Scan resolution	dx, dy = 5 mm	
Frequency	835 MHz \pm 1 MHz	
Input power drift	< 0.05 dB	

Maximum Field values at 835 MHz

H-field 10 mm above dipole surface	condition	interpolated maximum
Maximum measured	100 mW input power	0.455 A / m \pm 8.2 % (k=2)

E-field 10 mm above dipole surface	condition	Interpolated maximum
Maximum measured above high end	100 mW input power	173.2 V / m
Maximum measured above low end	100 mW input power	162.0 V / m
Averaged maximum above arm	100 mW input power	167.6 V / m \pm 12.8 % (k=2)

E-field 15 mm above dipole surface	condition	Interpolated maximum
Maximum measured above high end	100 mW input power	109.5 V / m
Maximum measured above low end	100 mW input power	105.8 V / m
Averaged maximum above arm	100 mW input power	107.7 V / m \pm 12.8 % (k=2)

Appendix

Antenna Parameters

Frequency	Return Loss	Impedance
800 MHz	15.2 dB	42.0 Ω - 14.1 j Ω
835 MHz	33.4 dB	48.8 Ω + 1.8 j Ω
900 MHz	17.1 dB	54.6 Ω - 14.0 j Ω
950 MHz	17.3 dB	46.4 Ω + 12.8 j Ω
960 MHz	13.4 dB	57.2 Ω + 22.4 j Ω

3.2 Antenna Design and Handling

The calibration dipole has a symmetric geometry with a built-in two stub matching network, which leads to the enhanced bandwidth.

The dipole is built of standard semirigid coaxial cable. The internal matching line is open ended. The antenna is therefore open for DC signals.

Do not apply force to dipole arms, as they are liable to bend. The soldered connections near the feedpoint may be damaged. After excessive mechanical stress or overheating, check the impedance characteristics to ensure that the internal matching network is not affected.

After long term use with 40W radiated power, only a slight warming of the dipole near the feedpoint can be measured.

Impedance Measurement Plot

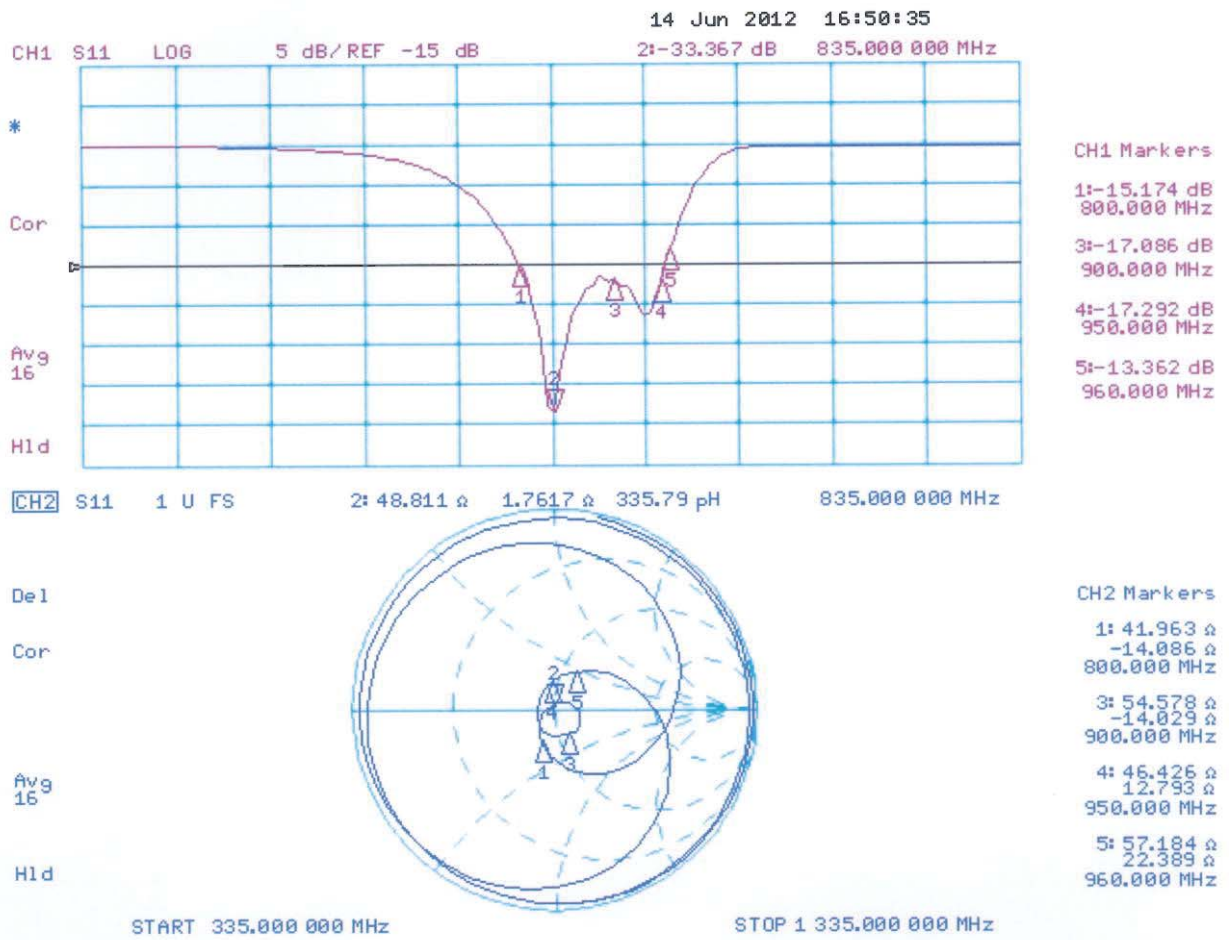

DASY4 H-field Result

Date: 14.06.2012

Test Laboratory: SPEAG Lab2

DUT: HAC-Dipole 835 MHz; Type: CD835V3; Serial: CD835V3 - SN: 1045

Communication System: CW; Frequency: 835 MHz

Medium parameters used: $\sigma = 0$ mho/m, $\epsilon_r = 1$; $\rho = 1$ kg/m³

Phantom section: RF Section

Measurement Standard: DASY5 (IEEE/IEC/ANSI C63.19-2007)

DASY52 Configuration:

- Probe: H3DV6 - SN6065; ; Calibrated: 29.12.2011
- Sensor-Surface: (Fix Surface)
- Electronics: DAE4 Sn781; Calibrated: 29.05.2012
- Phantom: HAC Test Arch with AMCC; Type: SD HAC P01 BA; Serial: 1070
- DASY52 52.8.1(838); SEMCAD X 14.6.5(6469)

Dipole H-Field measurement @ 835MHz/H-Scan - 835MHz d=10mm/Hearing Aid Compatibility Test (41x361x1):

Measurement grid: dx=5mm, dy=5mm

Device Reference Point: 0, 0, -6.3 mm

Reference Value = 0.4840 A/m; Power Drift = 0.01 dB

PMR not calibrated. PMF = 1.000 is applied.

H-field emissions = 0.4547 A/m

Near-field category: M4 (AWF 0 dB)

PMF scaled H-field

Grid 1 M4	Grid 2 M4	Grid 3 M4
0.386 A/m	0.403 A/m	0.376 A/m
Grid 4 M4	Grid 5 M4	Grid 6 M4
0.437 A/m	0.455 A/m	0.423 A/m
Grid 7 M4	Grid 8 M4	Grid 9 M4
0.391 A/m	0.403 A/m	0.370 A/m

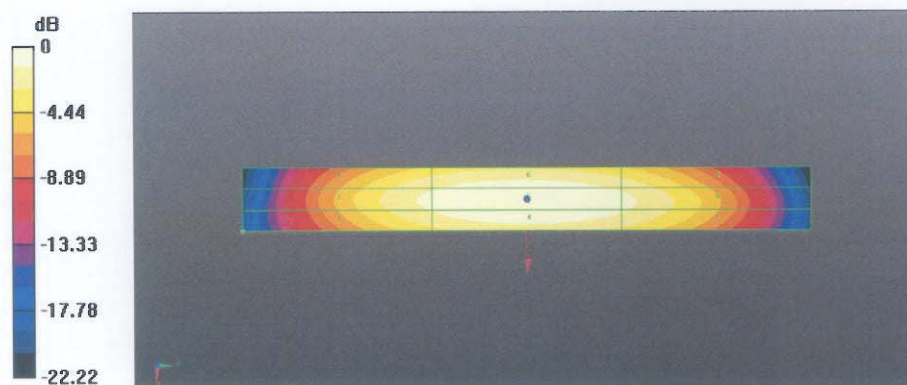

0 dB = 0.4547 A/m = -6.85 dB A/m

DASY4 E-field Result

Date: 14.06.2012

Test Laboratory: SPEAG Lab2

DUT: HAC-Dipole 835 MHz; Type: CD835V3; Serial: CD835V3 - SN: 1045

Communication System: CW; Frequency: 835 MHz

Medium parameters used: $\sigma = 0$ mho/m, $\epsilon_r = 1$; $\rho = 1000$ kg/m³

Phantom section: RF Section

Measurement Standard: DASY5 (IEEE/IEC/ANSI C63.19-2007)

DASY52 Configuration:

- Probe: ER3DV6 - SN2336; ConvF(1, 1, 1); Calibrated: 29.12.2011;
- Sensor-Surface: (Fix Surface)
- Electronics: DAE4 Sn781; Calibrated: 29.05.2012
- Phantom: HAC Test Arch with AMCC; Type: SD HAC P01 BA; Serial: 1070
- DASY52 52.8.1(838); SEMCAD X 14.6.5(6469)

Dipole E-Field measurement @ 835MHz/E-Scan - 835MHz d=10mm/Hearing Aid Compatibility Test (41x361x1):

Measurement grid: dx=5mm, dy=5mm

Device Reference Point: 0, 0, -6.3 mm

Reference Value = 110.5 V/m; Power Drift = -0.01 dB

PMR not calibrated. PMF = 1.000 is applied.

E-field emissions = 173.2 V/m

Near-field category: M4 (AWF 0 dB)

PMF scaled E-field

Grid 1 M4 156.7 V/m	Grid 2 M4 162.0 V/m	Grid 3 M4 157.7 V/m
Grid 4 M4 85.93 V/m	Grid 5 M4 87.68 V/m	Grid 6 M4 83.94 V/m
Grid 7 M4 171.2 V/m	Grid 8 M4 173.2 V/m	Grid 9 M4 158.0 V/m

Dipole E-Field measurement @ 835MHz/E-Scan - 835MHz d=15mm/Hearing Aid Compatibility Test (41x361x1):

Measurement grid: dx=5mm, dy=5mm

Device Reference Point: 0, 0, -6.3 mm

Reference Value = 110.4 V/m; Power Drift = -0.01 dB

PMR not calibrated. PMF = 1.000 is applied.

E-field emissions = 105.8 V/m

Near-field category: M4 (AWF 0 dB)

PMF scaled E-field

Grid 1 M4 103.8 V/m	Grid 2 M4 105.8 V/m	Grid 3 M4 104.5 V/m
Grid 4 M4 62.22 V/m	Grid 5 M4 62.87 V/m	Grid 6 M4 61.54 V/m
Grid 7 M4 109.1 V/m	Grid 8 M4 109.5 V/m	Grid 9 M4 104.3 V/m

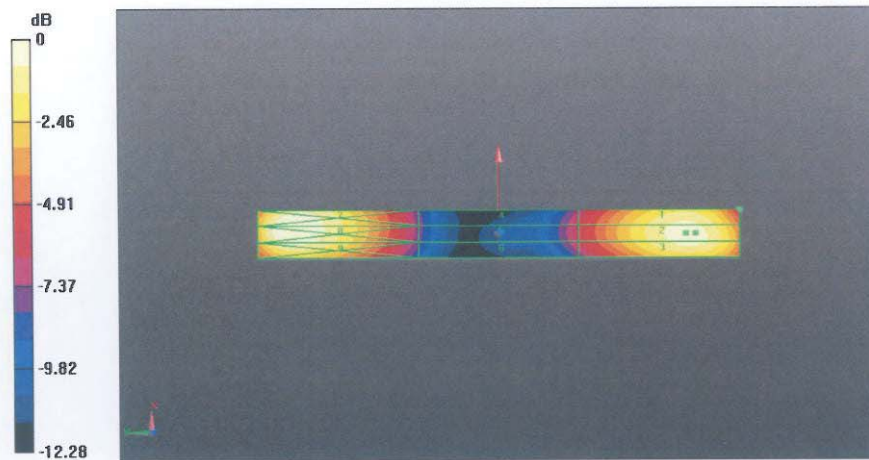

0 dB = 173.2 V/m = 44.77 dB V/m