

FCC SAR Test Report

APPLICANT : Unimax Communications
EQUIPMENT : CDMA1X handset
BRAND NAME : UMX
MODEL NAME : C5610/COMPANION
FCC ID : P46-C5610
STANDARD : FCC 47 CFR Part 2 (2.1093)
ANSI/IEEE C95.1-1992
IEEE 1528-2003
FCC OET Bulletin 65 Supplement C (Edition 01-01)

The product was completely tested on Nov. 04, 2012. We, SPORTON INTERNATIONAL (SHENZHEN) INC., would like to declare that the tested sample has been evaluated in accordance with the procedures and shown the compliance with the applicable technical standards.

The test results in this report apply exclusively to the tested model / sample. Without written approval of SPORTON INTERNATIONAL (SHENZHEN) INC., the test report shall not be reproduced except in full.

Reviewed by:



Jones Tsai / Manager



SPORTON INTERNATIONAL (SHENZHEN) INC.
No. 101, Complex Building C, Guanglong Village, Xili Town,
Nanshan District, Shenzhen, Guangdong, P.R.C. Jiangsu Province, P.R.C.



Table of Contents

1. Statement of Compliance	4
2. Administration Data	5
2.1 Testing Laboratory	5
2.2 Applicant	5
2.3 Manufacturer	5
2.4 Application Details	5
3. General Information	6
3.1 Description of Equipment Under Test (EUT)	6
3.2 Product Photos	7
3.3 Applied Standard	7
3.4 Device Category and SAR Limits	7
3.5 Test Conditions	7
4. Specific Absorption Rate (SAR)	8
4.1 Introduction	8
4.2 SAR Definition	8
5. SAR Measurement System	9
5.1 E-Field Probe	10
5.2 Data Acquisition Electronics (DAE)	11
5.3 Robot	11
5.4 Measurement Server	11
5.5 Phantom	12
5.6 Device Holder	12
5.7 Data Storage and Evaluation	13
5.8 Test Equipment List	15
6. Tissue Simulating Liquids	16
7. SAR Measurement Evaluation	17
7.1 Purpose of System Performance check	17
7.2 System Setup	17
7.3 Validation Results	18
8. EUT Testing Position	19
8.1 Define two imaginary lines on the handset	19
8.2 Cheek Position	20
8.3 Tilted Position	20
8.4 Body Worn Position	21
9. Measurement Procedures	22
9.1 Spatial Peak SAR Evaluation	22
9.2 Area & Zoom Scan Procedures	22
9.3 Volume Scan Procedures	23
9.4 SAR Averaged Methods	23
9.5 Power Drift Monitoring	23
10. SAR Test Configurations	24
10.1 Exposure Positions Consideration	24
10.2 Conducted RF Output Power (Unit: dBm)	25
11. SAR Test Results	26
11.1 Test Records for Head SAR Test	26
11.2 Test Records for Body-worn SAR Test	26
11.3 Simultaneous Multi-band Transmission Analysis	27
12. Uncertainty Assessment	28
13. References	30
Appendix A. Plots of System Performance Check	
Appendix B. Plots of SAR Measurement	
Appendix C. DASYS Calibration Certificate	
Appendix D. Product Photos	
Appendix E. Test Setup Photos	



Revision History

REPORT NO.	VERSION	DESCRIPTION	ISSUED DATE
FA2O1106	Rev. 01	Initial issue of report	Nov. 09, 2012

1. Statement of Compliance

The maximum results of Specific Absorption Rate (SAR) found during testing for **Unimax Communications DUT: CDMA1X handset; Brand Name: UMX; Model Name: C5610/COMPANION** are as follows.

<Standalone SAR>

Band	Position	SAR _{1g} (W/kg)	Scaled SAR _{1g} (W/kg)
CDMA2000 BC0	Head	0.469	0.515
CDMA2000 BC1	Head	0.281	0.347
CDMA2000 BC14	Head	0.252	0.317
CDMA2000 BC0	Body-worn (1.5 cm)	0.721	0.800
CDMA2000 BC1	Body-worn (1.5 cm)	0.771	0.968
CDMA2000 BC14	Body-worn (1.5 cm)	0.590	0.753

This device is in compliance with Specific Absorption Rate (SAR) for general population/uncontrolled exposure limits (1.6 W/kg) specified in FCC 47 CFR part 2 (2.1093) and ANSI/IEEE C95.1-1992, and had been tested in accordance with the measurement methods and procedures specified in IEEE 1528-2003 and FCC OET Bulletin 65 Supplement C (Edition 01-01).



2. Administration Data

2.1 Testing Laboratory

Test Site	SPORTON INTERNATIONAL (SHENZHEN) INC.
Test Site Location	No. 101, Complex Building C, Guanglong Village, Xili Town, Nanshan District, Shenzhen, Guangdong, P.R.C. TEL: +86-755-8637-9589 FAX: +86-755-8637-9595

2.2 Applicant

Company Name	Unimax Communications
Address	18201 McDermott Street W.Suite E Irvine, CA 92614

2.3 Manufacturer

Company Name	Unimax Communications
Address	18201 McDermott Street W.Suite E Irvine, CA 92614

2.4 Application Details

Date of Start during the Test	Nov. 03, 2012
Date of End during the Test	Nov. 04, 2012



3. General Information

3.1 Description of Equipment Under Test (EUT)

Product Feature & Specification	
EUT	CDMA1X handset
Brand Name	UMX
Model Name	C5610/COMPANION
FCC ID	P46-C5610
MEID HEX	A1000009AFFFFA
Tx Frequency	CDMA2000 BC0 : 824.70 MHz ~ 848.31 MHz CDMA2000 BC1 : 1851.25 MHz ~ 1908.75 MHz CDMA2000 BC14 : 1851.25 MHz ~ 1913.75 MHz Bluetooth : 2402 MHz ~ 2480 MHz
Rx Frequency	CDMA2000 BC0 : 869.70 MHz ~ 893.31 MHz CDMA2000 BC1 : 1931.25 MHz ~ 1988.75 MHz CDMA2000 BC14 : 1931.25 MHz ~ 1993.75 MHz Bluetooth : 2402 MHz ~ 2480 MHz
Maximum Average Output Power to Antenna	CDMA2000 BC0 : 24.09 dBm CDMA2000 BC1 : 24.08 dBm CDMA2000 BC14 : 24.00 dBm Bluetooth: -8.10 dBm
Antenna Type	WWAN: Fixed Internal Antenna Bluetooth: PIFA Antenna
HW Version	C5610-Main_V1.0
SW Version	C5610_01.11.
Type of Modulation	CDMA2000 1xRTT: QPSK Bluetooth (1Mbps) : GFSK Bluetooth EDR (2Mbps) : $\pi/4$ -DQPSK Bluetooth EDR (3Mbps) : 8-DPSK
EUT Stage	Identical Prototype
Remark: The above EUT's information was declared by manufacturer. Please refer to the specifications or user's manual for more detailed description.	



3.2 Product Photos

Please refer to Appendix D.

3.3 Applied Standard

The Specific Absorption Rate (SAR) testing specification, method and procedure for this device is in accordance with the following standards:

- FCC 47 CFR Part 2 (2.1093)
- ANSI/IEEE C95.1-1992
- IEEE 1528-2003
- FCC OET Bulletin 65 Supplement C (Edition 01-01)
- FCC KDB 447498 D01 v04
- FCC KDB 648474 D01 v01r05
- FCC KDB 941225 D01 v02

3.4 Device Category and SAR Limits

This device belongs to portable device category because its radiating structure is allowed to be used within 20 centimeters of the body of the user. Limit for General Population/Uncontrolled exposure should be applied for this device, it is 1.6 W/kg as averaged over any 1 gram of tissue.

3.5 Test Conditions

3.5.1 Ambient Condition

Ambient Temperature	20 to 24 °C
Humidity	< 60 %

3.5.2 Test Configuration

The device was controlled by using a base station emulator. Communication between the device and the emulator was established by air link. The distance between the EUT and the antenna of the emulator is larger than 50 cm and the output power radiated from the emulator antenna is at least 30 dB smaller than the output power of EUT. The EUT was set from the emulator to radiate maximum output power during all tests.

The maximum rated power of WWAN is listed in "Tune-Up Procedure" exhibit; the scaling factor is calculated according to the difference between measured output power and maximum tolerance power on this device.

4. Specific Absorption Rate (SAR)

4.1 Introduction

SAR is related to the rate at which energy is absorbed per unit mass in an object exposed to a radio field. The SAR distribution in a biological body is complicated and is usually carried out by experimental techniques or numerical modeling. The standard recommends limits for two tiers of groups, occupational/controlled and general population/uncontrolled, based on a person's awareness and ability to exercise control over his or her exposure. In general, occupational/controlled exposure limits are higher than the limits for general population/uncontrolled.

4.2 SAR Definition

The SAR definition is the time derivative (rate) of the incremental energy (dW) absorbed by (dissipated in) an incremental mass (dm) contained in a volume element (dv) of a given density (ρ). The equation description is as below:

$$\text{SAR} = \frac{d}{dt} \left(\frac{dW}{dm} \right) = \frac{d}{dt} \left(\frac{dW}{\rho dv} \right)$$

SAR is expressed in units of Watts per kilogram (W/kg)

SAR measurement can be either related to the temperature elevation in tissue by

$$\text{SAR} = c \left(\frac{\delta T}{\delta t} \right)$$

Where: C is the specific heat capacity, δT is the temperature rise and δt is the exposure duration, or related to the electrical field in the tissue by

$$\text{SAR} = \frac{\sigma |E|^2}{\rho}$$

Where: σ is the conductivity of the tissue, ρ is the mass density of the tissue and E is the RMS electrical field strength.

However for evaluating SAR of low power transmitter, electrical field measurement is typically applied.

5. SAR Measurement System

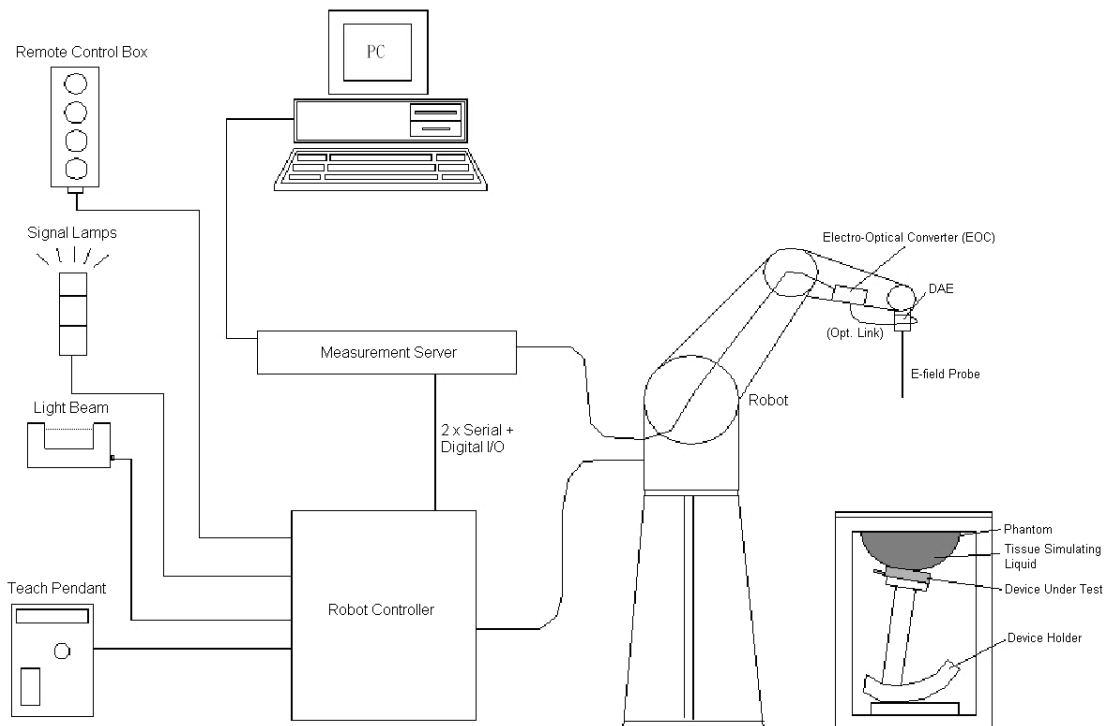

Fig 5.1 SPEAG DASY System Configurations

The DASY system for performance compliance tests is illustrated above graphically. This system consists of the following items:

- A standard high precision 6-axis robot with controller, a teach pendant and software
- A data acquisition electronic (DAE) attached to the robot arm extension
- A dosimetric probe equipped with an optical surface detector system
- The electro-optical converter (EOC) performs the conversion between optical and electrical signals
- A measurement server performs the time critical tasks such as signal filtering, control of the robot operation and fast movement interrupts.
- A probe alignment unit which improves the accuracy of the probe positioning
- A computer operating Windows XP
- DASY software
- Remote control with teach pendant and additional circuitry for robot safety such as warning lamps, etc.
- The SAM twin phantom
- A device holder
- Tissue simulating liquid
- Dipole for evaluating the proper functioning of the system

Component details are described in in the following sub-sections.

5.1 E-Field Probe

The SAR measurement is conducted with the dosimetric probe (manufactured by SPEAG). The probe is specially designed and calibrated for use in liquid with high permittivity. The dosimetric probe has special calibration in liquid at different frequency. This probe has a built in optical surface detection system to prevent from collision with phantom.

5.1.1 E-Field Probe Specification

<EX3DV4 Probe>

Construction	Symmetrical design with triangular core Built-in shielding against static charges PEEK enclosure material (resistant to organic solvents, e.g., DGBE)	
Frequency	10 MHz to 6 GHz; Linearity: ± 0.2 dB	
Directivity	± 0.3 dB in HSL (rotation around probe axis) ± 0.5 dB in tissue material (rotation normal to probe axis)	
Dynamic Range	10 μ W/g to 100 mW/g; Linearity: ± 0.2 dB (noise: typically < 1 μ W/g)	
Dimensions	Overall length: 330 mm (Tip: 20 mm) Tip diameter: 2.5 mm (Body: 12 mm) Typical distance from probe tip to dipole centers: 1 mm	

Fig 5.2 Photo of EX3DV4

5.1.2 E-Field Probe Calibration

Each probe needs to be calibrated according to a dosimetric assessment procedure with accuracy better than $\pm 10\%$. The spherical isotropy shall be evaluated and within ± 0.25 dB. The sensitivity parameters (NormX, NormY, and NormZ), the diode compression parameter (DCP) and the conversion factor (ConvF) of the probe are tested. The calibration data can be referred to appendix C of this report.

5.2 Data Acquisition Electronics (DAE)

The data acquisition electronics (DAE) consists of a highly sensitive electrometer-grade preamplifier with auto-zeroing, a channel and gain-switching multiplexer, a fast 16 bit AD-converter and a command decoder and control logic unit. Transmission to the measurement server is accomplished through an optical downlink for data and status information as well as an optical uplink for commands and the clock. The input impedance of the DAE is 200 MOhm; the inputs are symmetrical and floating. Common mode rejection is above 80 dB.



Fig 5.3 Photo of DAE

5.3 Robot

The SPEAG DASY system uses the high precision robots (DASY5: TX90XL) type from Stäubli SA (France). For the 6-axis controller system, the robot controller version (DASY5: CS8c) from Stäubli is used. The Stäubli robot series have many features that are important for our application:

- High precision (repeatability ± 0.035 mm)
- High reliability (industrial design)
- Jerk-free straight movements
- Low ELF interference (the closed metallic construction shields against motor control fields)



Fig 5.4 Photo of DASY5

5.4 Measurement Server

The measurement server is based on a PC/104 CPU board with CPU (DASY5: 400 MHz, Intel Celeron), chipdisk (DASY5: 128 MB), RAM (DASY5: 128 MB). The necessary circuits for communication with the DAE electronic box, as well as the 16 bit AD converter system for optical detection and digital I/O interface are contained on the DASY I/O board, which is directly connected to the PC/104 bus of the CPU board.

The measurement server performs all the real-time data evaluation for field measurements and surface detection, controls robot movements and handles safety operations.



Fig 5.5 Photo of Server for DASY5

5.5 Phantom

<SAM Twin Phantom>

Shell Thickness	2 ± 0.2 mm; Center ear point: 6 ± 0.2 mm	 <p>Fig 5.6 Photo of SAM Phantom</p>
Filling Volume	Approx. 25 liters	
Dimensions	Length: 1000 mm; Width: 500 mm; Height: adjustable feet	
Measurement Areas	Left Hand, Right Hand, Flat Phantom	

The bottom plate contains three pair of bolts for locking the device holder. The device holder positions are adjusted to the standard measurement positions in the three sections. A white cover is provided to tap the phantom during off-periods to prevent water evaporation and changes in the liquid parameters. On the phantom top, three reference markers are provided to identify the phantom position with respect to the robot.

5.6 Device Holder

<Device Holder for SAM Twin Phantom>

The SAR in the phantom is approximately inversely proportional to the square of the distance between the source and the liquid surface. For a source at 5 mm distance, a positioning uncertainty of ± 0.5 mm would produce a SAR uncertainty of ± 20 %. Accurate device positioning is therefore crucial for accurate and repeatable measurements. The positions in which the devices must be measured are defined by the standards.

The DASY device holder is designed to cope with different positions given in the standard. It has two scales for the device rotation (with respect to the body axis) and the device inclination (with respect to the line between the ear reference points). The rotation center for both scales is the ear reference point (EPR). Thus the device needs no repositioning when changing the angles.

The DASY device holder is constructed of low-loss POM material having the following dielectric parameters: relative permittivity $\epsilon = 3$ and loss tangent $\delta = 0.02$. The amount of dielectric material has been reduced in the closest vicinity of the device, since measurements have suggested that the influence of the clamp on the test results could thus be lowered.



Fig 5.7 Device Holder

5.7 Data Storage and Evaluation

5.7.1 Data Storage

The DASY software stores the assessed data from the data acquisition electronics as raw data (in microvolt readings from the probe sensors), together with all the necessary software parameters for the data evaluation (probe calibration data, liquid parameters and device frequency and modulation data) in measurement files. The post-processing software evaluates the desired unit and format for output each time the data is visualized or exported. This allows verification of the complete software setup even after the measurement and allows correction of erroneous parameter settings. For example, if a measurement has been performed with an incorrect crest factor parameter in the device setup, the parameter can be corrected afterwards and the data can be reevaluated.

The measured data can be visualized or exported in different units or formats, depending on the selected probe type (e.g., [V/m], [A/m], [mW/g]). Some of these units are not available in certain situations or give meaningless results, e.g., a SAR-output in a non-lose media, will always be zero. Raw data can also be exported to perform the evaluation with other software packages.

5.7.2 Data Evaluation

The DASY post-processing software (SEMCAD) automatically executes the following procedures to calculate the field units from the microvolt readings at the probe connector. The parameters used in the evaluation are stored in the configuration modules of the software :

Probe parameters :	- Sensitivity	Norm _i , a _{i0} , a _{i1} , a _{i2}
	- Conversion factor	ConvF _i
	- Diode compression point	dcp _i
Device parameters :	- Frequency	f
	- Crest factor	cf
Media parameters :	- Conductivity	σ
	- Density	ρ

These parameters must be set correctly in the software. They can be found in the component documents or they can be imported into the software from the configuration files issued for the DASY components. In the direct measuring mode of the multi-meter option, the parameters of the actual system setup are used. In the scan visualization and export modes, the parameters stored in the corresponding document files are used.

The first step of the evaluation is a linearization of the filtered input signal to account for the compression characteristics of the detector diode. The compensation depends on the input signal, the diode type and the DC-transmission factor from the diode to the evaluation electronics. If the exciting field is pulsed, the crest factor of the signal must be known to correctly compensate for peak power.

The formula for each channel can be given as :

$$V_i = U_i + U_i^2 \cdot \frac{cf}{dcp_i}$$

with V_i = compensated signal of channel i, (i = x, y, z)
 U_i = input signal of channel i, (i = x, y, z)
 cf = crest factor of exciting field (DASY parameter)
 dcp_i = diode compression point (DASY parameter)

From the compensated input signals, the primary field data for each channel can be evaluated :

$$\text{E-field Probes : } E_i = \sqrt{\frac{V_i}{\text{Norm}_i \cdot \text{ConvF}}}$$

$$\text{H-field Probes : } H_i = \sqrt{V_i \cdot \frac{a_{i0} + a_{i1}f + a_{i2}f^2}{f}}$$

with V_i = compensated signal of channel i, (i = x, y, z)
 Norm_i = sensor sensitivity of channel i, (i = x, y, z), $\mu\text{V}/(\text{V/m})^2$ for E-field Probes
 ConvF = sensitivity enhancement in solution
 a_{ij} = sensor sensitivity factors for H-field probes
 f = carrier frequency [GHz]
 E_i = electric field strength of channel i in V/m
 H_i = magnetic field strength of channel i in A/m

The RSS value of the field components gives the total field strength (Hermitian magnitude) :

$$E_{\text{tot}} = \sqrt{E_x^2 + E_y^2 + E_z^2}$$

The primary field data are used to calculate the derived field units.

$$\text{SAR} = E_{\text{tot}}^2 \cdot \frac{\sigma}{\rho \cdot 1000}$$

with SAR = local specific absorption rate in mW/g
 E_{tot} = total field strength in V/m
 σ = conductivity in [mho/m] or [Siemens/m]
 ρ = equivalent tissue density in g/cm^3

Note that the density is set to 1, to account for actual head tissue density rather than the density of the tissue simulating liquid.

**5.8 Test Equipment List**

Manufacturer	Name of Equipment	Type/Model	Serial Number	Calibration	
				Last Cal.	Due Date
SPEAG	835MHz System Validation Kit	D835V2	4d091	Nov. 18, 2011	Nov. 17, 2012
SPEAG	1900MHz System Validation Kit	D1900V2	5d118	Nov. 21, 2011	Nov. 20, 2012
SPEAG	Data Acquisition Electronics	DAE4	1303	Nov. 10, 2011	Nov. 09, 2012
SPEAG	Dosimetric E-Field Probe	EX3DV4	3819	Nov. 16, 2011	Nov. 15, 2012
SPEAG	SAM Twin Phantom	QD 000 P40 CD	TP-1670	NCR	NCR
SPEAG	SAM Twin Phantom	QD 000 P40 CD	TP-1671	NCR	NCR
SPEAG	Test Arch Phantom	Par phantom	1105	NCR	NCR
SPEAG	Phone Positioner	N/A	N/A	NCR	NCR
Agilent	Base Station	E5515C	MY50267224	Dec. 29, 2011	Dec. 28, 2012
Agilent	ENA Series Network Analyzer	E5071C	MY46111157	Apr. 13, 2012	Apr. 12, 2013
R&S	Signal Generator	SMR40	100455	Dec. 30, 2011	Dec. 29, 2012
Agilent	Power Meter	E4416A	MY45101555	Aug. 23, 2012	Aug. 22, 2013
Agilent	Power Sensor	E9327A	MY44421198	Aug. 23, 2012	Aug. 22, 2013
R&S	Spectrum Analyzer	FSP30	101400	Jun. 01, 2012	May 31, 2013

Table 5.1 Test Equipment List

Note: The calibration certificate of DASY can be referred to appendix C of this report.

6. Tissue Simulating Liquids

For the measurement of the field distribution inside the SAM phantom with DASY, the phantom must be filled with around 25 liters of homogeneous body tissue simulating liquid. For head SAR testing, the liquid height from the ear reference point (ERP) of the phantom to the liquid top surface is larger than 15 cm, which is shown in Fig. 6.1. For body SAR testing, the liquid height from the center of the flat phantom to the liquid top surface is larger than 15 cm, which is shown in Fig. 6.2.



Fig 6.1 Photo of Liquid Height for Head SAR



Fig 6.2 Photo of Liquid Height for Body SAR

The following table gives the recipes for tissue simulating liquid.

Frequency (MHz)	Water (%)	Sugar (%)	Cellulose (%)	Salt (%)	Preventol (%)	DGBE (%)	Conductivity (σ)	Permittivity (ϵ_r)
For Head								
835	40.3	57.9	0.2	1.4	0.2	0	0.90	41.5
1800, 1900, 2000	55.2	0	0	0.3	0	44.5	1.40	40.0
For Body								
835	50.8	48.2	0	0.9	0.1	0	0.97	55.2
1800, 1900, 2000	70.2	0	0	0.4	0	29.4	1.52	53.3

Table 6.1 Recipes of Tissue Simulating Liquid

The dielectric parameters of the liquids were verified prior to the SAR evaluation using an Agilent 85070D Dielectric Probe Kit and an Agilent Network Analyzer.

The following table shows the measuring results for simulating liquid.

Freq. (MHz)	Liquid Type	Temp. (°C)	Conductivity (σ)	Permittivity (ϵ_r)	Conductivity Target (σ)	Permittivity Target (ϵ_r)	Delta (σ) (%)	Delta (ϵ_r) (%)	Limit (%)	Date
835	Head	21.6	0.925	41.705	0.90	41.5	2.78	0.49	±5	Nov. 04, 2012
1900	Head	21.4	1.419	40.609	1.40	40.0	1.36	1.52	±5	Nov. 03, 2012
835	Body	21.7	0.971	56.304	0.97	55.2	0.10	2.00	±5	Nov. 04, 2012
1900	Body	21.5	1.543	52.519	1.52	53.3	1.51	-1.47	±5	Nov. 03, 2012

Table 6.2 Measuring Results for Simulating Liquid

7. SAR Measurement Evaluation

Each DASY system is equipped with one or more system validation kits. These units, together with the predefined measurement procedures within the DASY software, enable the user to conduct the system performance check and system validation. System validation kit includes a dipole, tripod holder to fix it underneath the flat phantom and a corresponding distance holder.

7.1 Purpose of System Performance check

The system performance check verifies that the system operates within its specifications. System and operator errors can be detected and corrected. It is recommended that the system performance check be performed prior to any usage of the system in order to guarantee reproducible results. The system performance check uses normal SAR measurements in a simplified setup with a well characterized source. This setup was selected to give a high sensitivity to all parameters that might fail or vary over time. The system check does not intend to replace the calibration of the components, but indicates situations where the system uncertainty is exceeded due to drift or failure.

7.2 System Setup

In the simplified setup for system evaluation, the EUT is replaced by a calibrated dipole and the power source is replaced by a continuous wave that comes from a signal generator. The calibrated dipole must be placed beneath the flat phantom section of the SAM twin phantom with the correct distance holder. The distance holder should touch the phantom surface with a light pressure at the reference marking and be oriented parallel to the long side of the phantom. The equipment setup is shown below:

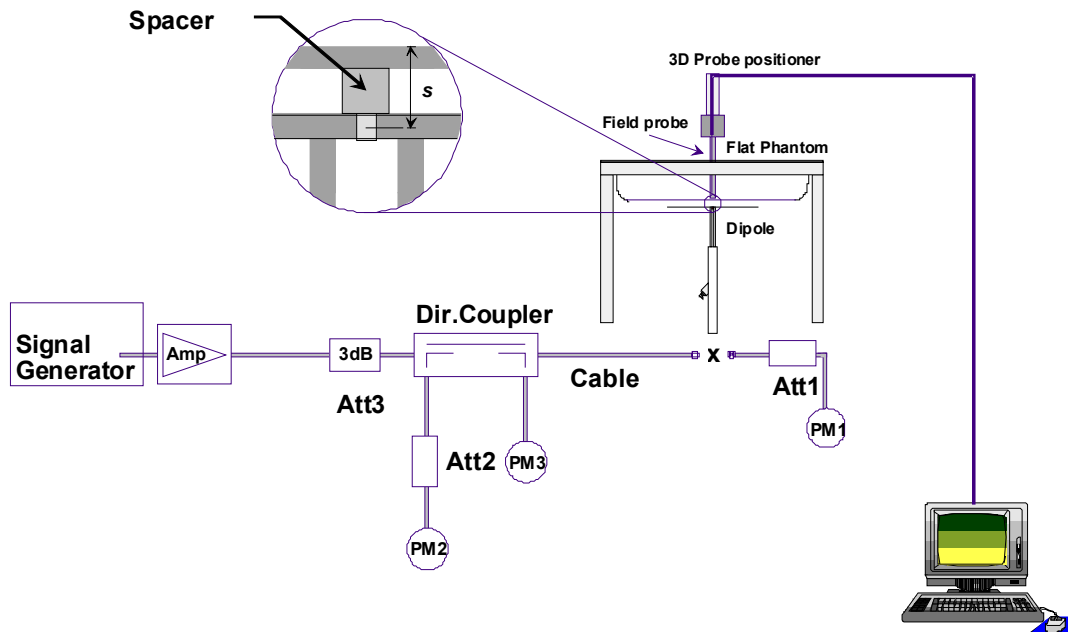

Fig 7.1 System Setup for System Evaluation

1. Signal Generator
2. Amplifier
3. Directional Coupler
4. Power Meter
5. Calibrated Dipole

The output power on dipole port must be calibrated to 24 dBm (250 mW) before dipole is connected.



Fig 7.2 Photo of Dipole Setup

7.3 Validation Results

Comparing to the original SAR value provided by SPEAG, the validation data should be within its specification of 10 %. Table 7.1 shows the target SAR and measured SAR after normalized to 1W input power. The table below indicates the system performance check can meet the variation criterion and the plots can be referred to Appendix A of this report.

Measurement Date	Frequency (MHz)	Liquid Type	Targeted SAR _{1g} (W/kg)	Measured SAR _{1g} (W/kg)	Normalized SAR _{1g} (W/kg)	Deviation (%)
Nov. 04, 2012	835	Head	9.40	2.4	9.60	2.13
Nov. 03, 2012	1900	Head	40.30	10.2	40.80	1.24
Nov. 04, 2012	835	Body	9.42	2.36	9.44	0.21
Nov. 03, 2012	1900	Body	41.80	10.4	41.60	-0.48

Table 7.1 Target and Measurement SAR after Normalized

8. EUT Testing Position

This EUT was tested in six different positions. They are right cheek, right tilted, left cheek, left tilted, front of the EUT with phantom 1.5 cm gap, back of the EUT with phantom 1.5 cm gap, as illustrated below:

8.1 Define two imaginary lines on the handset

- The vertical centerline passes through two points on the front side of the handset - the midpoint of the width w_t of the handset at the level of the acoustic output, and the midpoint of the width w_b of the bottom of the handset.
- The horizontal line is perpendicular to the vertical centerline and passes through the center of the acoustic output. The horizontal line is also tangential to the face of the handset at point A.
- The two lines intersect at point A. Note that for many handsets, point A coincides with the center of the acoustic output; however, the acoustic output may be located elsewhere on the horizontal line. Also note that the vertical centerline is not necessarily parallel to the front face of the handset, especially for clamshell handsets, handsets with flip covers, and other irregularly shaped handsets.

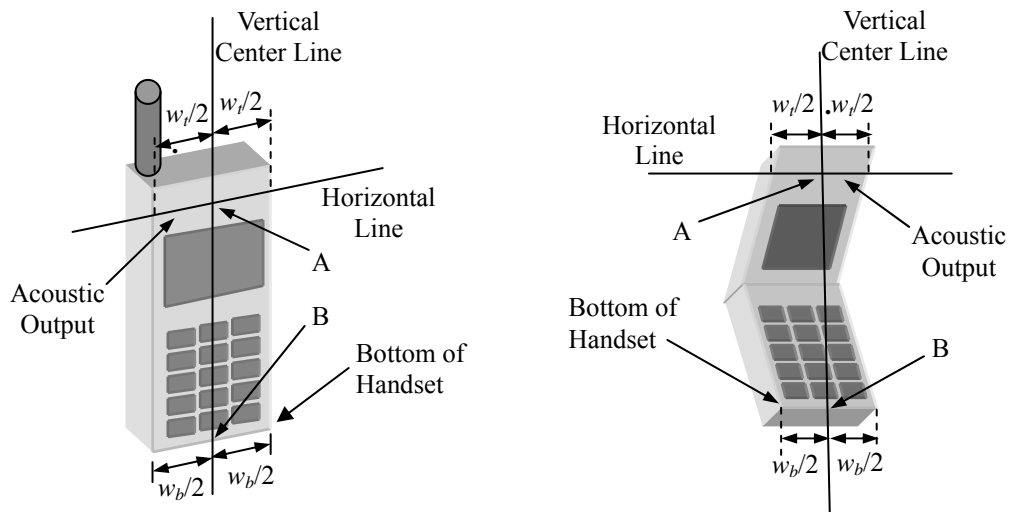

Fig 9.1 Illustration for Handset Vertical and Horizontal Reference Lines

8.2 Cheek Position

- (a) To position the device with the vertical center line of the body of the device and the horizontal line crossing the center piece in a plane parallel to the sagittal plane of the phantom. While maintaining the device in this plane, align the vertical center line with the reference plane containing the three ear and mouth reference point (M: Mouth, RE: Right Ear, and LE: Left Ear) and align the center of the ear piece with the line RE-LE.
- (b) To move the device towards the phantom with the ear piece aligned with the line LE-RE until the phone touched the ear. While maintaining the device in the reference plane and maintaining the phone contact with the ear, move the bottom of the phone until any point on the front side is in contact with the cheek of the phantom or until contact with the ear is lost (see Fig. 9.2).

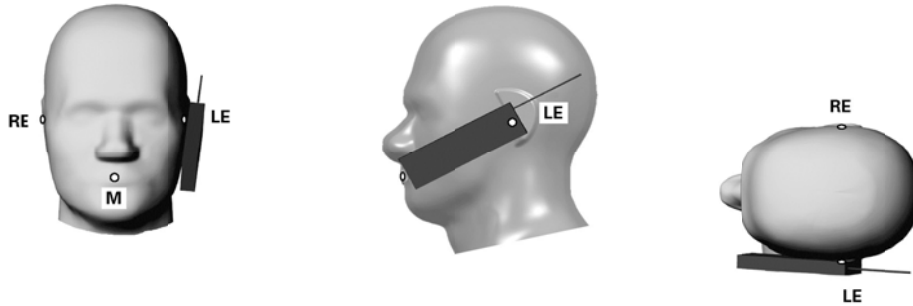

Fig 9.2 Illustration for Cheek Position

8.3 Tilted Position

- (a) To position the device in the “cheek” position described above.
- (b) While maintaining the device the reference plane described above and pivoting against the ear, moves it outward away from the mouth by an angle of 15 degrees or until contact with the ear is lost (see Fig. 9.3).

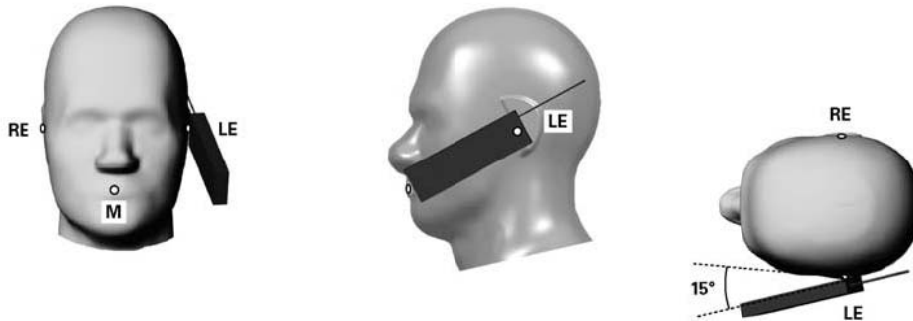

Fig 9.3 Illustration for Tilted Position

8.4 Body Worn Position

- (a) To position the device parallel to the phantom surface with either keypad up or down.
- (b) To adjust the device parallel to the flat phantom.
- (c) To adjust the distance between the device surface and the flat phantom to 1.5 cm.

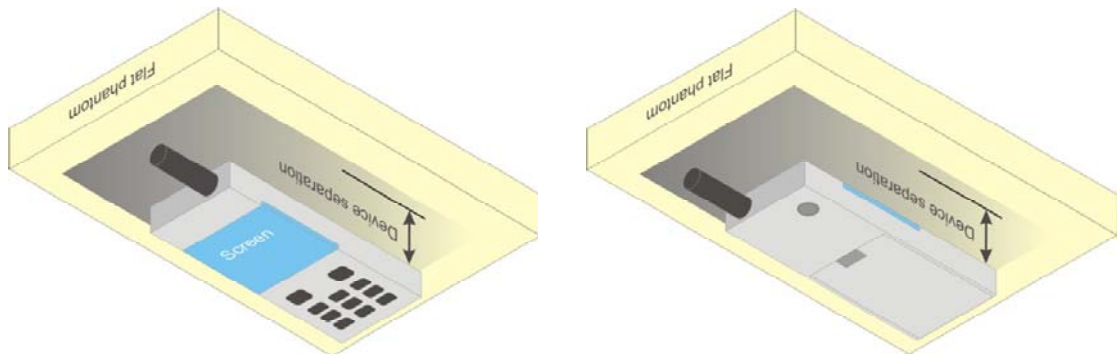

Fig 9.4 Illustration for Body Worn Position

<EUT Setup Photos>

Please refer to Appendix E for the test setup photos.

9. Measurement Procedures

The measurement procedures are as follows:

- (a) Use base station simulator (if applicable) or engineering software to transmit RF power continuously (continuous Tx) in the highest power channel.
- (b) Keep EUT to radiate maximum output power or 100% duty factor (if applicable)
- (c) Measure output power through RF cable and power meter.
- (d) Place the EUT in the positions as Appendix E demonstrates.
- (e) Set scan area, grid size and other setting on the DASY software.
- (f) Measure SAR results for the highest power channel on each testing position.
- (g) Find out the largest SAR result on these testing positions of each band
- (h) Measure SAR results for other channels in worst SAR testing position if the SAR of highest power channel is larger than 0.8 W/kg

According to the test standard, the recommended procedure for assessing the peak spatial-average SAR value consists of the following steps:

- (a) Power reference measurement
- (b) Area scan
- (c) Zoom scan
- (d) Power drift measurement

9.1 Spatial Peak SAR Evaluation

The procedure for spatial peak SAR evaluation has been implemented according to the test standard. It can be conducted for 1g and 10g, as well as for user-specific masses. The DASY software includes all numerical procedures necessary to evaluate the spatial peak SAR value.

The base for the evaluation is a "cube" measurement. The measured volume must include the 1g and 10g cubes with the highest averaged SAR values. For that purpose, the center of the measured volume is aligned to the interpolated peak SAR value of a previously performed area scan.

The entire evaluation of the spatial peak values is performed within the post-processing engine (SEMCAD). The system always gives the maximum values for the 1g and 10g cubes. The algorithm to find the cube with highest averaged SAR is divided into the following stages:

- (a) Extraction of the measured data (grid and values) from the Zoom Scan
- (b) Calculation of the SAR value at every measurement point based on all stored data (A/D values and measurement parameters)
- (c) Generation of a high-resolution mesh within the measured volume
- (d) Interpolation of all measured values from the measurement grid to the high-resolution grid
- (e) Extrapolation of the entire 3-D field distribution to the phantom surface over the distance from sensor to surface
- (f) Calculation of the averaged SAR within masses of 1g and 10g

9.2 Area & Zoom Scan Procedures

First Area Scan is used to locate the approximate location(s) of the local peak SAR value(s). The measurement grid within an Area Scan is defined by the grid extent, grid step size and grid offset. Next, in order to determine the EM field distribution in a three-dimensional spatial extension, Zoom Scan is required. The Zoom Scan measures 5x5x7 points with step size 8, 8 and 5 mm for 300 MHz to 3 GHz, and 8x8x8 points with step size 4, 4 and 2.5 mm for 3 GHz to 6 GHz. The Zoom Scan is performed around the highest E-field value to determine the averaged SAR-distribution over 10 g.



9.3 Volume Scan Procedures

The volume scan is used to assess overlapping SAR distributions for antennas transmitting in different frequency bands. It is equivalent to an oversized zoom scan used in standalone measurements. The measurement volume will be used to enclose all the simultaneous transmitting antennas. For antennas transmitting simultaneously in different frequency bands, the volume scan is measured separately in each frequency band. In order to sum correctly to compute the 1g aggregate SAR, the EUT remains in the same test position for all measurements and all volume scans use the same spatial resolution and grid spacing (step-size is 4, 4 and 2.5 mm). When all volume scans are completed, the software, SEMCAD postprocessor can combine and subsequently superpose these measurement data to calculate the multiband SAR.

9.4 SAR Averaged Methods

In DASy, the interpolation and extrapolation are both based on the modified Quadratic Shepard's method. The interpolation scheme combines a least-square fitted function method and a weighted average method which are the two basic types of computational interpolation and approximation.

Extrapolation routines are used to obtain SAR values between the lowest measurement points and the inner phantom surface. The extrapolation distance is determined by the surface detection distance and the probe sensor offset. The uncertainty increases with the extrapolation distance. To keep the uncertainty within 1% for the 1 g and 10 g cubes, the extrapolation distance should not be larger than 5 mm.

9.5 Power Drift Monitoring

All SAR testing is under the EUT installed full charged battery and transmit maximum output power. In DASy measurement software, the power reference measurement and power drift measurement procedures are used for monitoring the power drift of EUT during SAR test. Both these procedures measure the field at a specified reference position before and after the SAR testing. The software will calculate the field difference in dB. If the power drift is more than 5%, the SAR will be retested.

10. SAR Test Configurations

10.1 Exposure Positions Consideration

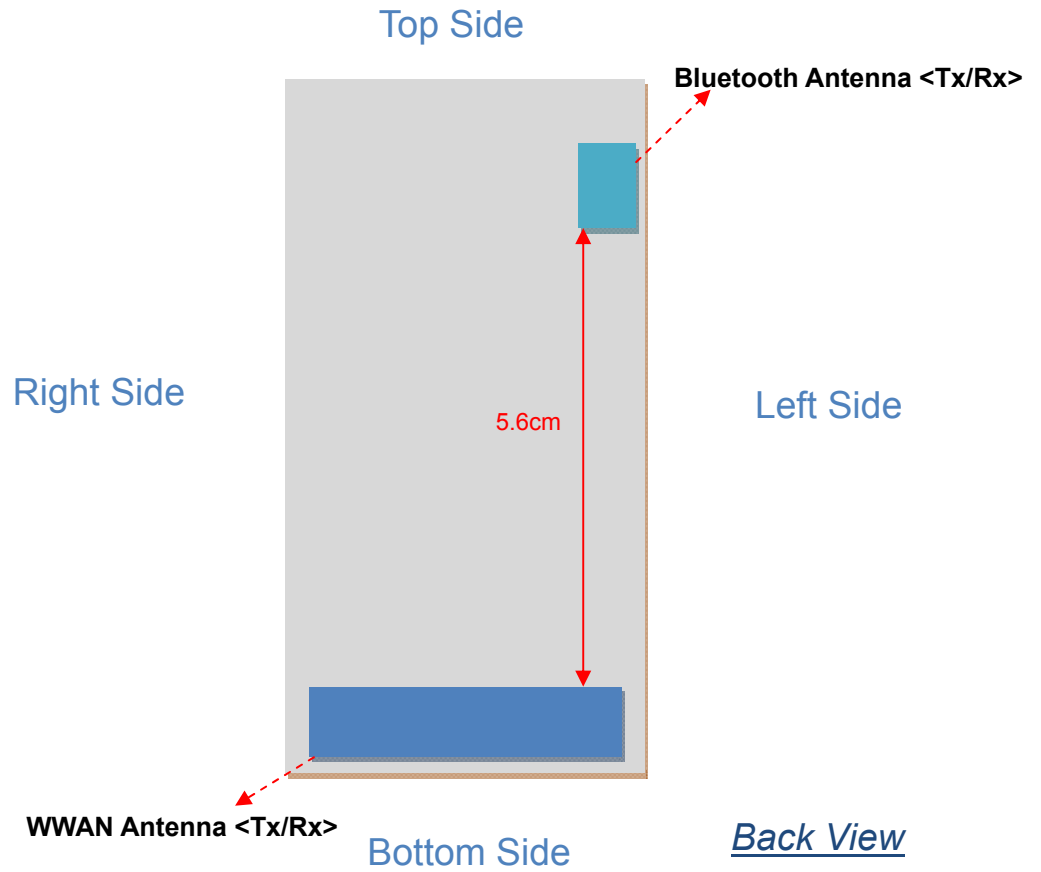

Antennas	Wireless Interface
WWAN Antenna (Tx / Rx)	CDMA2000 1xRTT: BC 0/1/14
Bluetooth Antenna (Tx / Rx)	Bluetooth



10.2 Conducted RF Output Power (Unit: dBm)

<CDMA2000>

Band	CDMA2000 BC0			CDMA2000 BC1			CDMA2000 BC14
	1013	384	777	25	600	1175	1275
Channel	1013	384	777	25	600	1175	1275
Frequency (MHz)	824.70	836.52	848.31	1851.25	1880.00	1908.75	1913.75
1xRTT RC1+SO55	24.06	23.83	23.83	23.64	24.07	24.01	23.93
1xRTT RC3+SO55	24.09	23.89	23.91	23.65	24.08	24.02	24.00
1xRTT RC3+SO32 (FCH)	24.05	23.94	23.94	23.55	24.01	23.93	23.94
1xRTT RC3+SO32 (FCH+SCH)	24.05	23.88	23.90	23.52	24.01	23.90	23.91

Note:

1. According to KDB 941225 D01, Head SAR for RC1+SO55 is not required because the maximum average output power of RC1 is less than 1/4 dB higher than RC3+SO55.
2. Referring to KDB 941225 D01, the CDMA Handset Body-worn SAR tests based on RC3+SO32. RC1 power is less than 1/4 dB higher than RC3, thus SAR tests in these mode are not necessary.

<Bluetooth>

Mode	Channel	Frequency (MHz)	Average Power (dBm)								
			Data Rate								
			DH1	DH3	DH5	2DH1	2DH3	2DH5	3DH1	3DH3	3DH5
Bluetooth	CH 00	2402	-8.90	-10.95	-11.41	-9.55	-11.93	-12.39	-10.03	-12.32	-12.91
	CH 39	2441	-8.56	-10.68	-11.04	-9.61	-11.85	-12.23	-9.93	-12.23	-12.82
	CH 78	2480	-8.10	-9.85	-10.15	-8.95	-10.80	-11.18	-9.28	-11.18	-11.61

Note: Per KDB 648474, 2.4GHz Bluetooth SAR is excluded due to highest output power $\leq 2 \cdot P_{Ref}$, where $2 \cdot P_{Ref} = 24mW = 13.8dBm$.

11. SAR Test Results

11.1 Test Records for Head SAR Test

<CDMA2000>

Plot No.	Band	Mode	Test Position	Ch.	Output Power (dBm)	Tune-Up Limit (dBm)	Scaling Factor	SAR _{1g} (W/kg)	Scaled SAR _{1g} (W/kg)
11	CDMA2000 BC0	RC3 SO55	Right Cheek	1013	24.09	24.5	1.10	0.469	0.515
12	CDMA2000 BC0	RC3 SO55	Right Tilted	1013	24.09	24.5	1.10	0.310	0.341
13	CDMA2000 BC0	RC3 SO55	Left Cheek	1013	24.09	24.5	1.10	0.429	0.471
14	CDMA2000 BC0	RC3 SO55	Left Tilted	1013	24.09	24.5	1.10	0.251	0.276
6	CDMA2000 BC1	RC3 SO55	Right Cheek	600	24.08	25	1.24	0.281	0.347
7	CDMA2000 BC1	RC3 SO55	Right Tilted	600	24.08	25	1.24	0.195	0.241
8	CDMA2000 BC1	RC3 SO55	Left Cheek	600	24.08	25	1.24	0.257	0.318
9	CDMA2000 BC1	RC3 SO55	Left Tilted	600	24.08	25	1.24	0.198	0.245
10	CDMA2000 BC14	RC3 SO55	Right Cheek	1275	24.00	25	1.26	0.252	0.317

Note:

- Per KDB 447498, if the highest output channel SAR for each exposure position ≤ 0.8 W/kg other channels SAR tests are not necessary.

11.2 Test Records for Body-worn SAR Test

<CDMA2000>

Plot No.	Band	Mode	Test Position	Gap (cm)	Ch.	Output Power (dBm)	Tune-Up Limit (dBm)	Scaling Factor	Headset	SAR _{1g} (W/kg)	Scaled SAR _{1g} (W/kg)
15	CDMA2000 BC0	RC3 SO32	Front	1.5	1013	24.05	24.5	1.11	w/Headset	0.489	0.542
16	CDMA2000 BC0	RC3 SO32	Back	1.5	1013	24.05	24.5	1.11	w/Headset	0.721	0.800
1	CDMA2000 BC1	RC3 SO32	Front	1.5	600	24.01	25	1.26	w/Headset	0.298	0.374
2	CDMA2000 BC1	RC3 SO32	Back	1.5	600	24.01	25	1.26	w/Headset	0.771	0.968
3	CDMA2000 BC14	RC3 SO32	Back	1.5	1275	23.94	25	1.28	w/Headset	0.590	0.753

Note:

- Per KDB 447498, if the highest output channel SAR for each exposure position ≤ 0.8 W/kg other channels SAR tests are not necessary.
- "V" in the headset column means the earphone is plugged during SAR testing.



11.3 Simultaneous Multi-band Transmission Analysis

No.	Applicable Simultaneous Transmission Combination
1.	CDMA2000 + Bluetooth

Note: Per KDB 648474 D01, Bluetooth output power (-8.10 dBm) $\leq 2 \cdot P_{Ref}$ and the distance to WWAN transmitting antenna ≥ 5 cm, therefore, stand-alone SAR is not required; the simultaneous transmission SAR for WWAN and Bluetooth was not required, because Bluetooth standalone SAR is not required and the maximum WWAN measured SAR (0.771 W/kg), so the SAR summation is less than 1.6 W/kg.

Test Engineer : Krin Wu and Jeme Li

12. Uncertainty Assessment

The component of uncertainty may generally be categorized according to the methods used to evaluate them. The evaluation of uncertainty by the statistical analysis of a series of observations is termed a Type A evaluation of uncertainty. The evaluation of uncertainty by means other than the statistical analysis of a series of observations is termed a Type B evaluation of uncertainty. Each component of uncertainty, however evaluated, is represented by an estimated standard deviation, termed standard uncertainty, which is determined by the positive square root of the estimated variance.

A Type A evaluation of standard uncertainty may be based on any valid statistical method for treating data. This includes calculating the standard deviation of the mean of a series of independent observations; using the method of least squares to fit a curve to the data in order to estimate the parameter of the curve and their standard deviations; or carrying out an analysis of variance in order to identify and quantify random effects in certain kinds of measurement.

A type B evaluation of standard uncertainty is typically based on scientific judgment using all of the relevant information available. These may include previous measurement data, experience and knowledge of the behavior and properties of relevant materials and instruments, manufacture’s specification, data provided in calibration reports and uncertainties assigned to reference data taken from handbooks. Broadly speaking, the uncertainty is either obtained from an outdoor source or obtained from an assumed distribution, such as the normal distribution, rectangular or triangular distributions indicated in Table 12.1

Uncertainty Distributions	Normal	Rectangular	Triangular	U-Shape
Multi-plying Factor ^(a)	1/k ^(b)	1/√3	1/√6	1/√2

(a) standard uncertainty is determined as the product of the multiplying factor and the estimated range of variations in the measured quantity

(b) κ is the coverage factor

Table 12.1 Standard Uncertainty for Assumed Distribution

The combined standard uncertainty of the measurement result represents the estimated standard deviation of the result. It is obtained by combining the individual standard uncertainties of both Type A and Type B evaluation using the usual “root-sum-squares” (RSS) methods of combining standard deviations by taking the positive square root of the estimated variances.

Expanded uncertainty is a measure of uncertainty that defines an interval about the measurement result within which the measured value is confidently believed to lie. It is obtained by multiplying the combined standard uncertainty by a coverage factor. Typically, the coverage factor ranges from 2 to 3. Using a coverage factor allows the true value of a measured quantity to be specified with a defined probability within the specified uncertainty range. For purpose of this document, a coverage factor two is used, which corresponds to confidence interval of about 95 %. The DASY uncertainty Budget is shown in the following tables.



Error Description	Uncertainty	Probability	Divisor	Ci	Ci	Standard	Standard
	Value (±%)	Distribution		(1g)	(10g)	Uncertainty (1g)	Uncertainty (10g)
Measurement System							
Probe Calibration	6.0	Normal	1	1	1	± 6.0 %	± 6.0 %
Axial Isotropy	4.7	Rectangular	√3	0.7	0.7	± 1.9 %	± 1.9 %
Hemispherical Isotropy	9.6	Rectangular	√3	0.7	0.7	± 3.9 %	± 3.9 %
Boundary Effects	1.0	Rectangular	√3	1	1	± 0.6 %	± 0.6 %
Linearity	4.7	Rectangular	√3	1	1	± 2.7 %	± 2.7 %
System Detection Limits	1.0	Rectangular	√3	1	1	± 0.6 %	± 0.6 %
Readout Electronics	0.3	Normal	1	1	1	± 0.3 %	± 0.3 %
Response Time	0.8	Rectangular	√3	1	1	± 0.5 %	± 0.5 %
Integration Time	2.6	Rectangular	√3	1	1	± 1.5 %	± 1.5 %
RF Ambient Noise	3.0	Rectangular	√3	1	1	± 1.7 %	± 1.7 %
RF Ambient Reflections	3.0	Rectangular	√3	1	1	± 1.7 %	± 1.7 %
Probe Positioner	0.4	Rectangular	√3	1	1	± 0.2 %	± 0.2 %
Probe Positioning	2.9	Rectangular	√3	1	1	± 1.7 %	± 1.7 %
Max. SAR Eval.	1.0	Rectangular	√3	1	1	± 0.6 %	± 0.6 %
Test Sample Related							
Device Positioning	2.9	Normal	1	1	1	± 2.9 %	± 2.9 %
Device Holder	3.6	Normal	1	1	1	± 3.6 %	± 3.6 %
Power Drift	5.0	Rectangular	√3	1	1	± 2.9 %	± 2.9 %
Phantom and Setup							
Phantom Uncertainty	4.0	Rectangular	√3	1	1	± 2.3 %	± 2.3 %
Liquid Conductivity (Target)	5.0	Rectangular	√3	0.64	0.43	± 1.8 %	± 1.2 %
Liquid Conductivity (Meas.)	2.5	Normal	1	0.64	0.43	± 1.6 %	± 1.1 %
Liquid Permittivity (Target)	5.0	Rectangular	√3	0.6	0.49	± 1.7 %	± 1.4 %
Liquid Permittivity (Meas.)	2.5	Normal	1	0.6	0.49	± 1.5 %	± 1.2 %
Combined Standard Uncertainty						± 11.0 %	± 10.8 %
Coverage Factor for 95 %						K=2	
Expanded Uncertainty						± 22.0 %	± 21.5 %

Table 12.2 Uncertainty Budget of DASY for frequency range 300 MHz to 3 GHz



13. References

- [1] FCC 47 CFR Part 2 “Frequency Allocations and Radio Treaty Matters; General Rules and Regulations”
- [2] ANSI/IEEE Std. C95.1-1992, “IEEE Standard for Safety Levels with Respect to Human Exposure to Radio Frequency Electromagnetic Fields, 3 kHz to 300 GHz”, September 1992
- [3] IEEE Std. 1528-2003, “Recommended Practice for Determining the Peak Spatial-Average Specific Absorption Rate (SAR) in the Human Head from Wireless Communications Devices: Measurement Techniques”, December 2003
- [4] FCC OET Bulletin 65 (Edition 97-01) Supplement C (Edition 01-01), “Evaluating Compliance with FCC Guidelines for Human Exposure to Radiofrequency Electromagnetic Fields”, June 2001
- [5] SPEAG DASY System Handbook
- [6] FCC KDB 248227 D01 v01r02, “SAR Measurement Procedures for 802.11 a/b/g Transmitters”, May 2007
- [7] FCC KDB 447498 D01 v04, “Mobile and Portable Device RF Exposure Procedures and Equipment Authorization Policies”, November 2009
- [8] FCC KDB 447498 D02 v02, “SAR Measurement Procedures for USB Dongle Transmitters”, November 2009
- [9] FCC KDB 616217 D01 v01r01, “SAR Evaluation Considerations for Laptop Computers with Antennas Built-in on Display Screens”, November 2009
- [10] FCC KDB 616217 D03 v01, “SAR Evaluation Considerations for Laptop/Notebook/Netbook and Tablet Computers”, November 2009
- [11] FCC KDB 648474 D01 v01r05, “SAR Evaluation Considerations for Handsets with Multiple Transmitters and Antennas”, September 2008
- [12] FCC KDB 941225 D01 v02, “SAR Measurement Procedures for 3G Devices – CDMA 2000 / Ev-Do / WCDMA / HSDPA / HSPA”, October 2007
- [13] FCC KDB 941225 D02 v02 "3GPP R6 HSPA and R7 HSPA+ SAR Guidance", December 2009.
- [14] FCC KDB 941225 D03 v01, “Recommended SAR Test Reduction Procedures for GSM / GPRS / EDGE”, December 2008
- [15] FCC KDB 941225 D04 v01, “Evaluating SAR for GSM/(E)GPRS Dual Transfer Mode”, January 27 2010
- [16] FCC KDB 941225 D05 v01, “SAR Test Considerations for LTE Handsets and Data Modems”, December 15 2010
- [17] FCC KDB 941225 D06 v01, "SAR Evaluation Procedures for Portable Devices with Wireless Router Capabilities", April 2011
- [18] FCC KDB 388624 D02, "Permit But Ask List", December 2011



Appendix A. Plots of System Performance Check

The plots are shown as follows.

System Check_Head_835MHz_121104

DUT: D835V2 - SN:4d091

Communication System: CW; Frequency: 835 MHz; Duty Cycle: 1:1

Medium: HSL_835_121104 Medium parameters used: $f = 835 \text{ MHz}$; $\sigma = 0.925 \text{ mho/m}$; $\epsilon_r = 41.705$; $\rho = 1000 \text{ kg/m}^3$

Ambient Temperature : $23.5 \text{ }^\circ\text{C}$; Liquid Temperature : $21.6 \text{ }^\circ\text{C}$

DASY5 Configuration:

- Probe: EX3DV4 - SN3819; ConvF(9.4, 9.4, 9.4); Calibrated: 16.11.2011;
- Sensor-Surface: 4mm (Mechanical Surface Detection)
- Electronics: DAE4 Sn1303; Calibrated: 10.11.2011
- Phantom: SAM2; Type: QD000P40CD; Serial: TP:1671
- Measurement SW: DASY52, Version 52.8 (2); SEMCAD X Version 14.6.6 (6824)

Pin=250mW/Area Scan (61x61x1): Interpolated grid: $dx=15\text{mm}$, $dy=15\text{mm}$

Maximum value of SAR (interpolated) = 2.59 W/kg

Pin=250mW/Zoom Scan (7x7x7)/Cube 0: Measurement grid: $dx=5\text{mm}$, $dy=5\text{mm}$, $dz=5\text{mm}$

Reference Value = 52.714 V/m ; Power Drift = -0.01 dB

Peak SAR (extrapolated) = 3.618 mW/g

SAR(1 g) = 2.4 mW/g ; SAR(10 g) = 1.57 mW/g

Maximum value of SAR (measured) = 2.58 W/kg

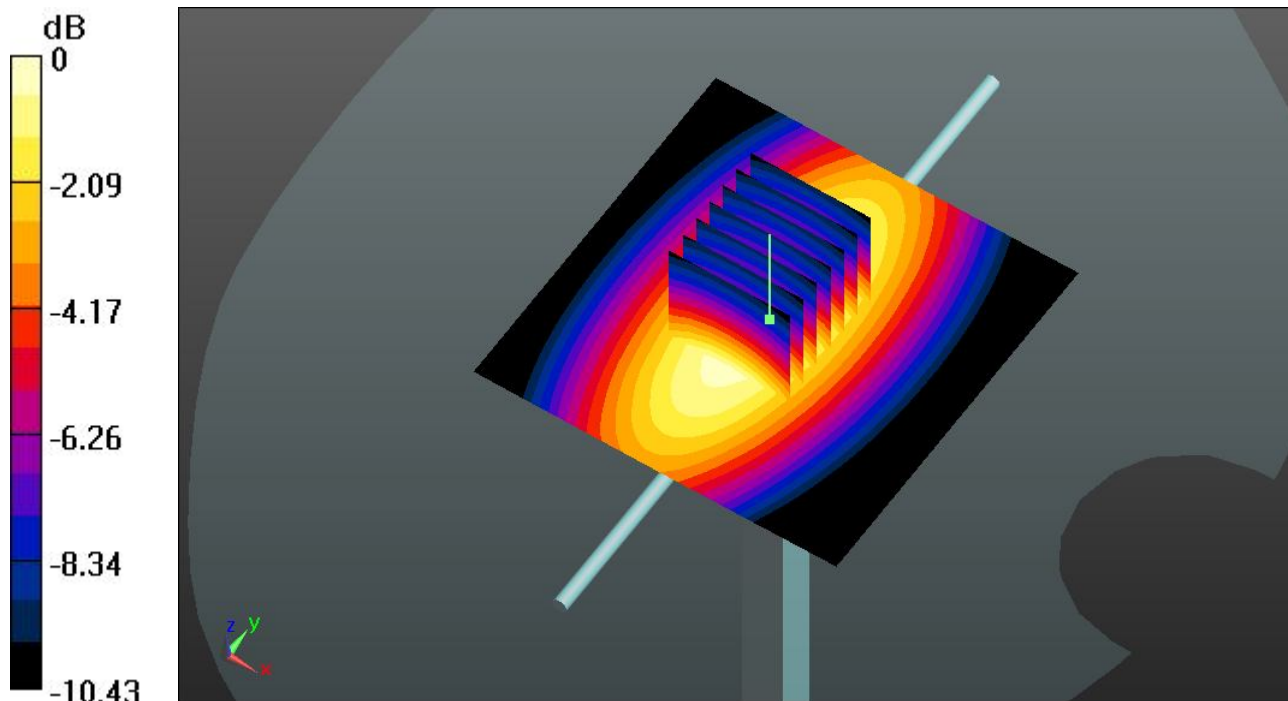

0 dB = 2.58 W/kg

System Check_Head_1900MHz_121103

DUT: D1900V2 - SN:5d118

Communication System: CW; Frequency: 1900 MHz; Duty Cycle: 1:1

Medium: HSL_1900_121103 Medium parameters used: $f = 1900$ MHz; $\sigma = 1.419$ mho/m; $\epsilon_r =$

40.609 ; $\rho = 1000$ kg/m³

Ambient Temperature : 23.5 °C ; Liquid Temperature : 21.4 °C

DASY5 Configuration:

- Probe: EX3DV4 - SN3819; ConvF(8.36, 8.36, 8.36); Calibrated: 16.11.2011;
- Sensor-Surface: 4mm (Mechanical Surface Detection)
- Electronics: DAE4 Sn1303; Calibrated: 10.11.2011
- Phantom: SAM1; Type: QD000P40CD; Serial: TP:1670
- Measurement SW: DASY52, Version 52.8 (2); SEMCAD X Version 14.6.6 (6824)

Pin=250mW/Area Scan (61x61x1): Interpolated grid: dx=15mm, dy=15mm

Maximum value of SAR (interpolated) = 11.5 W/kg

Pin=250mW/Zoom Scan (7x7x7)/Cube 0: Measurement grid: dx=5mm, dy=5mm, dz=5mm

Reference Value = 88.904 V/m; Power Drift = 0.01 dB

Peak SAR (extrapolated) = 18.723 mW/g

SAR(1 g) = 10.2 mW/g; SAR(10 g) = 5.35 mW/g

Maximum value of SAR (measured) = 11.3 W/kg

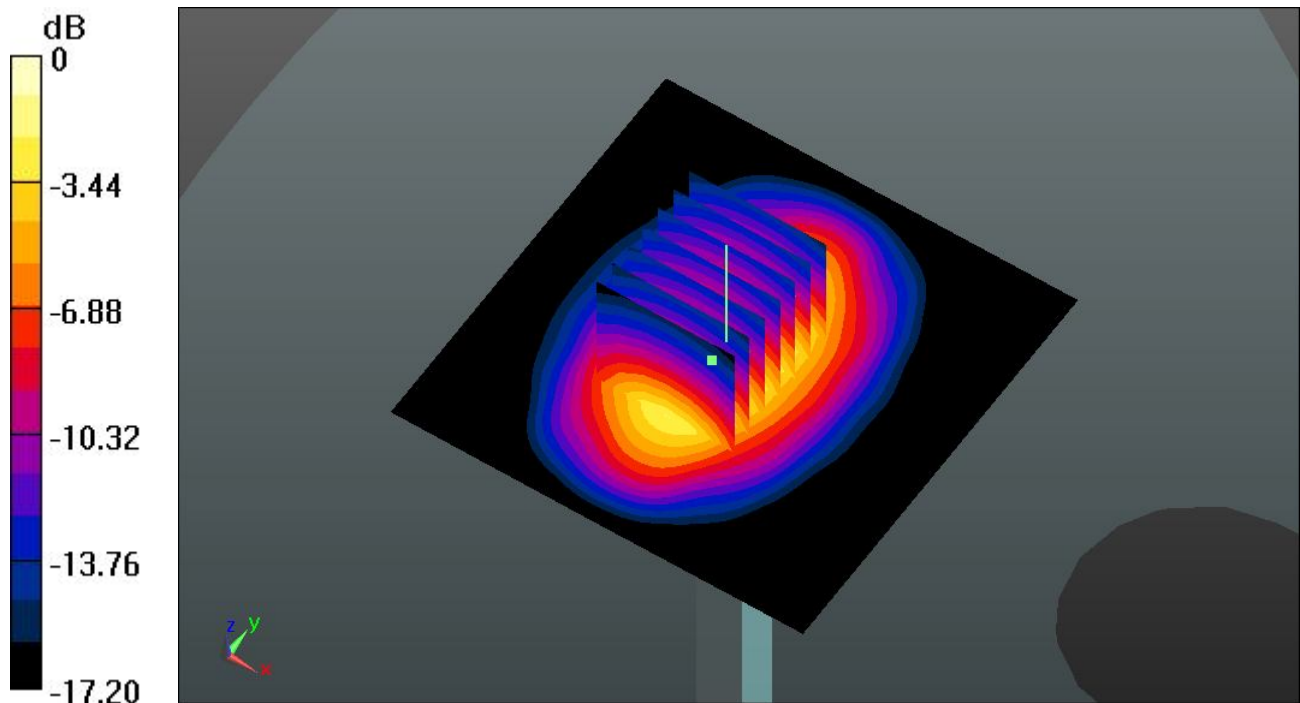

0 dB = 11.3 W/kg

System Check_Body_835MHz_121104

DUT: D835V2 - SN:4d091

Communication System: CW; Frequency: 835 MHz; Duty Cycle: 1:1

Medium: MSL_835_121104 Medium parameters used: $f = 835 \text{ MHz}$; $\sigma = 0.971 \text{ mho/m}$; $\epsilon_r = 56.304$;

$\rho = 1000 \text{ kg/m}^3$

Ambient Temperature : $23.5 \text{ }^\circ\text{C}$; Liquid Temperature : $21.7 \text{ }^\circ\text{C}$

DASY5 Configuration:

- Probe: EX3DV4 - SN3819; ConvF(9.72, 9.72, 9.72); Calibrated: 16.11.2011;
- Sensor-Surface: 4mm (Mechanical Surface Detection)
- Electronics: DAE4 Sn1303; Calibrated: 10.11.2011
- Phantom: SAM2; Type: QD000P40CD; Serial: TP:1671
- Measurement SW: DASY52, Version 52.8 (2); SEMCAD X Version 14.6.6 (6824)

Pin=250mW/Area Scan (61x61x1): Interpolated grid: $dx=15\text{mm}$, $dy=15\text{mm}$

Maximum value of SAR (interpolated) = 2.55 W/kg

Pin=250mW/Zoom Scan (7x7x7)/Cube 0: Measurement grid: $dx=5\text{mm}$, $dy=5\text{mm}$, $dz=5\text{mm}$

Reference Value = 51.263 V/m ; Power Drift = -0.01 dB

Peak SAR (extrapolated) = 3.511 mW/g

SAR(1 g) = 2.36 mW/g ; SAR(10 g) = 1.56 mW/g

Maximum value of SAR (measured) = 2.55 W/kg

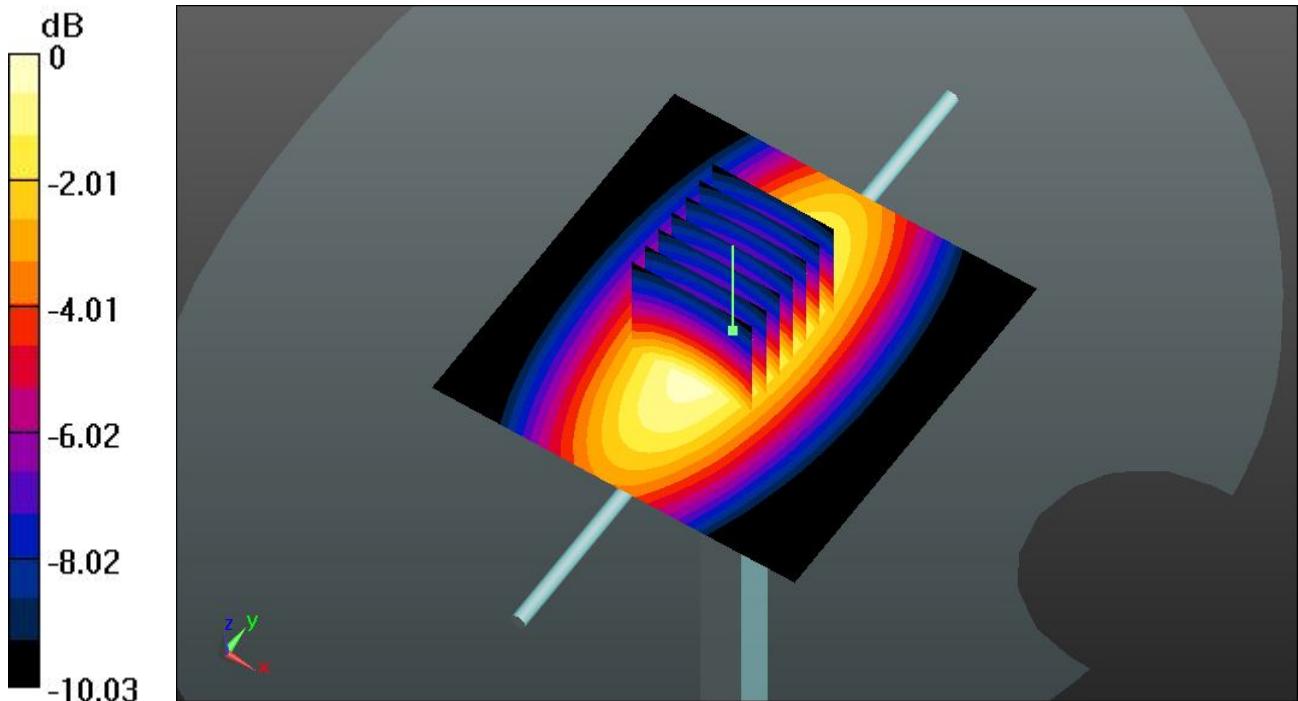

0 dB = 2.55 W/kg

System Check_Body_1900MHz_121103

DUT: D1900V2 - SN:5d118

Communication System: CW; Frequency: 1900 MHz; Duty Cycle: 1:1

Medium: MSL_1900_121103 Medium parameters used: $f = 1900 \text{ MHz}$; $\sigma = 1.543 \text{ mho/m}$; $\epsilon_r =$

52.519 ; $\rho = 1000 \text{ kg/m}^3$

Ambient Temperature : $23.5 \text{ }^\circ\text{C}$; Liquid Temperature : $21.5 \text{ }^\circ\text{C}$

DASY5 Configuration:

- Probe: EX3DV4 - SN3819; ConvF(7.71, 7.71, 7.71); Calibrated: 16.11.2011;
- Sensor-Surface: 4mm (Mechanical Surface Detection)
- Electronics: DAE4 Sn1303; Calibrated: 10.11.2011
- Phantom: SAM2; Type: QD000P40CD; Serial: TP:1671
- Measurement SW: DASY52, Version 52.8 (2); SEMCAD X Version 14.6.6 (6824)

Pin=250mW/Area Scan (61x61x1): Interpolated grid: $dx=15\text{mm}$, $dy=15\text{mm}$

Maximum value of SAR (interpolated) = 11.9 W/kg

Pin=250mW/Zoom Scan (7x7x7)/Cube 0: Measurement grid: $dx=5\text{mm}$, $dy=5\text{mm}$, $dz=5\text{mm}$

Reference Value = 87.111 V/m ; Power Drift = -0.01 dB

Peak SAR (extrapolated) = 19.156 mW/g

SAR(1 g) = 10.4 mW/g ; SAR(10 g) = 5.43 mW/g

Maximum value of SAR (measured) = 11.7 W/kg

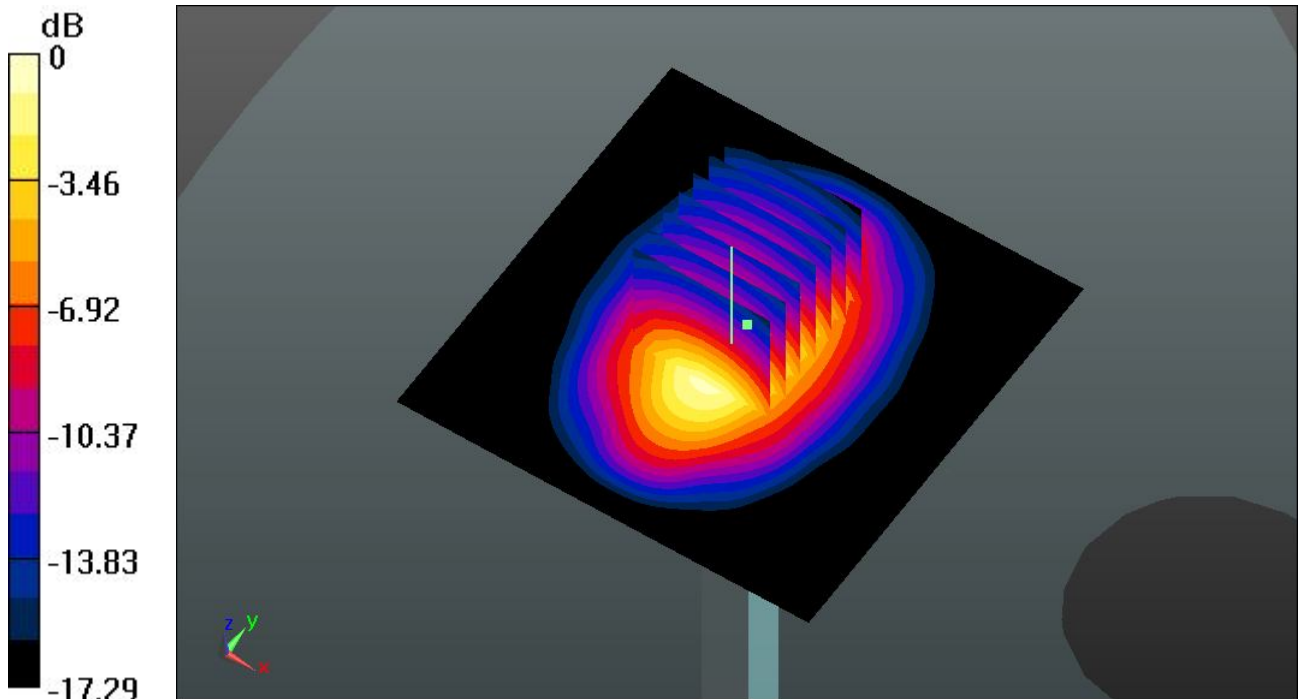

0 dB = 11.7 W/kg



Appendix B. Plots of SAR Measurement

The plots are shown as follows.

11 CDMA2000 BC0_RC3 SO55_Right Cheek_Ch1013

DUT: 2O1106

Communication System: CDMA2000; Frequency: 824.7 MHz; Duty Cycle: 1:1

Medium: HSL_835_121104 Medium parameters used: $f = 825$ MHz; $\sigma = 0.916$ mho/m; $\epsilon_r = 41.828$; $\rho = 1000$ kg/m³

Ambient Temperature : 23.5 °C ; Liquid Temperature : 21.6 °C

DASY5 Configuration:

- Probe: EX3DV4 - SN3819; ConvF(9.4, 9.4, 9.4); Calibrated: 16.11.2011;
- Sensor-Surface: 4mm (Mechanical Surface Detection)
- Electronics: DAE4 Sn1303; Calibrated: 10.11.2011
- Phantom: SAM2; Type: QD000P40CD; Serial: TP:1671
- Measurement SW: DASY52, Version 52.8 (2); SEMCAD X Version 14.6.6 (6824)

Ch1013/Area Scan (51x101x1): Interpolated grid: dx=15mm, dy=15mm

Maximum value of SAR (interpolated) = 0.519 W/kg

Ch1013/Zoom Scan (5x5x7)/Cube 0: Measurement grid: dx=8mm, dy=8mm, dz=5mm

Reference Value = 12.567 V/m; Power Drift = -0.05 dB

Peak SAR (extrapolated) = 0.594 mW/g

SAR(1 g) = 0.469 mW/g; SAR(10 g) = 0.349 mW/g

Maximum value of SAR (measured) = 0.492 W/kg

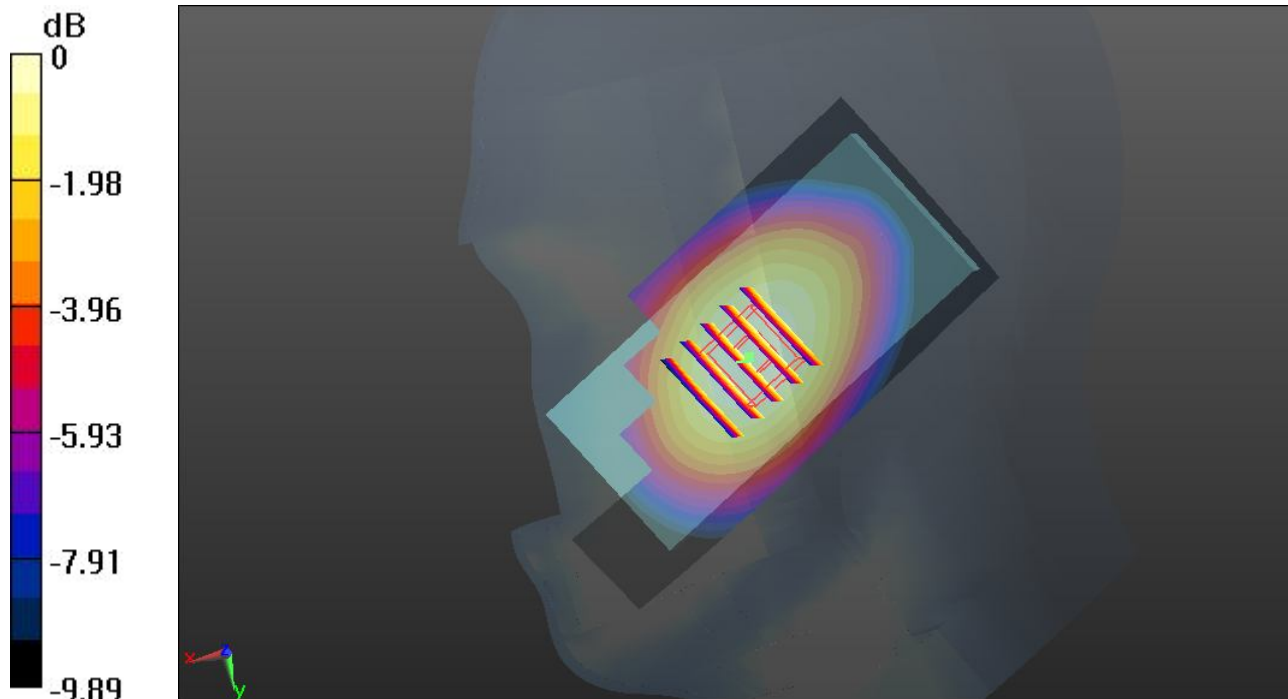

0 dB = 0.492 W/kg

11 CDMA2000 BC0_RC3 SO55_Right Cheek_Ch1013_2D

DUT: 2O1106

Communication System: CDMA2000; Frequency: 824.7 MHz; Duty Cycle: 1:1

Medium: HSL_835_121104 Medium parameters used: $f = 825$ MHz; $\sigma = 0.916$ mho/m; $\epsilon_r = 41.828$;

$\rho = 1000$ kg/m³

Ambient Temperature : 23.5 °C ; Liquid Temperature : 21.6 °C

DASY5 Configuration:

- Probe: EX3DV4 - SN3819; ConvF(9.4, 9.4, 9.4); Calibrated: 16.11.2011;
- Sensor-Surface: 4mm (Mechanical Surface Detection)
- Electronics: DAE4 Sn1303; Calibrated: 10.11.2011
- Phantom: SAM2; Type: QD000P40CD; Serial: TP:1671
- Measurement SW: DASY52, Version 52.8 (2); SEMCAD X Version 14.6.6 (6824)

Ch1013/Area Scan (51x101x1): Interpolated grid: dx=15mm, dy=15mm

Maximum value of SAR (interpolated) = 0.519 W/kg

Ch1013/Zoom Scan (5x5x7)/Cube 0: Measurement grid: dx=8mm, dy=8mm, dz=5mm

Reference Value = 12.567 V/m; Power Drift = -0.05 dB

Peak SAR (extrapolated) = 0.594 mW/g

SAR(1 g) = 0.469 mW/g; SAR(10 g) = 0.349 mW/g

Maximum value of SAR (measured) = 0.492 W/kg

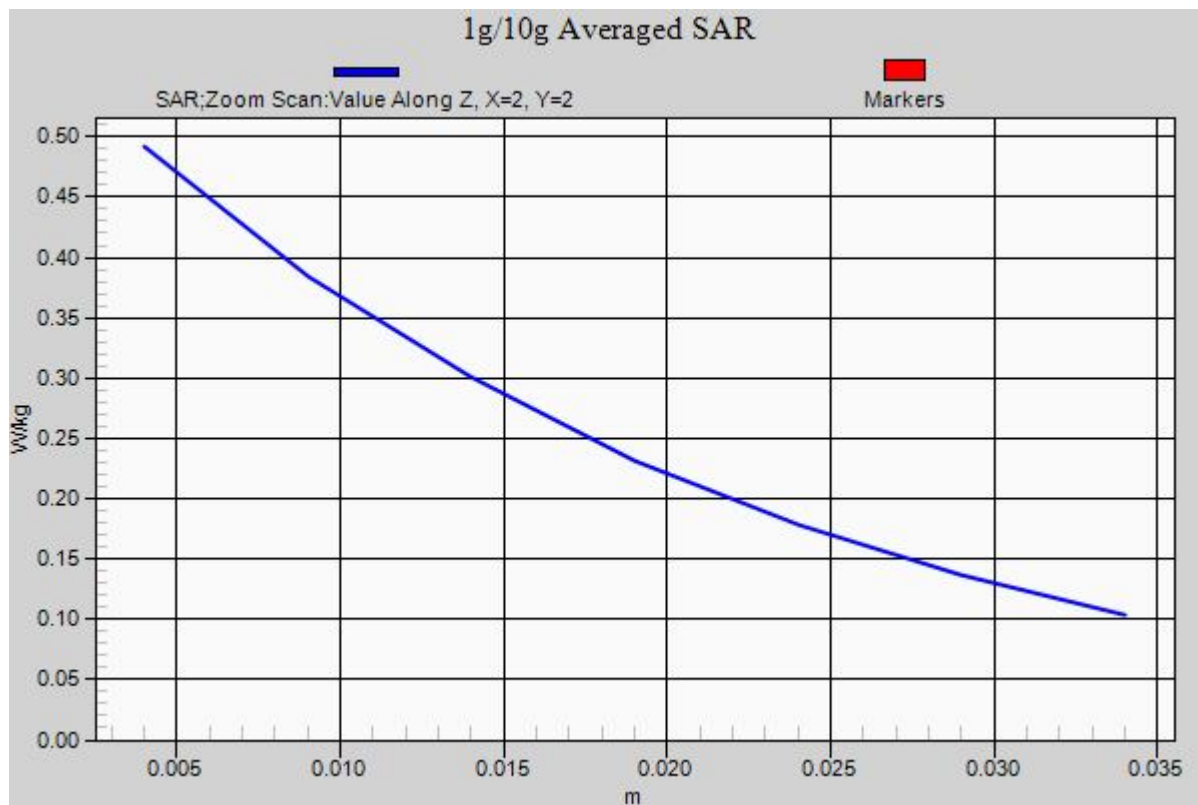

12 CDMA2000 BC0_RC3 SO55_Right Tilted_Ch1013

DUT: 2O1106

Communication System: CDMA2000; Frequency: 824.7 MHz; Duty Cycle: 1:1

Medium: HSL_835_121104 Medium parameters used: $f = 825$ MHz; $\sigma = 0.916$ mho/m; $\epsilon_r = 41.828$; $\rho = 1000$ kg/m³

Ambient Temperature : 23.5 °C ; Liquid Temperature : 21.6 °C

DASY5 Configuration:

- Probe: EX3DV4 - SN3819; ConvF(9.4, 9.4, 9.4); Calibrated: 16.11.2011;
- Sensor-Surface: 4mm (Mechanical Surface Detection)
- Electronics: DAE4 Sn1303; Calibrated: 10.11.2011
- Phantom: SAM2; Type: QD000P40CD; Serial: TP:1671
- Measurement SW: DASY52, Version 52.8 (2); SEMCAD X Version 14.6.6 (6824)

Ch1013/Area Scan (51x101x1): Interpolated grid: dx=15mm, dy=15mm

Maximum value of SAR (interpolated) = 0.336 W/kg

Ch1013/Zoom Scan (5x5x7)/Cube 0: Measurement grid: dx=8mm, dy=8mm, dz=5mm

Reference Value = 15.993 V/m; Power Drift = -0.09 dB

Peak SAR (extrapolated) = 0.395 mW/g

SAR(1 g) = 0.310 mW/g; SAR(10 g) = 0.229 mW/g

Maximum value of SAR (measured) = 0.328 W/kg

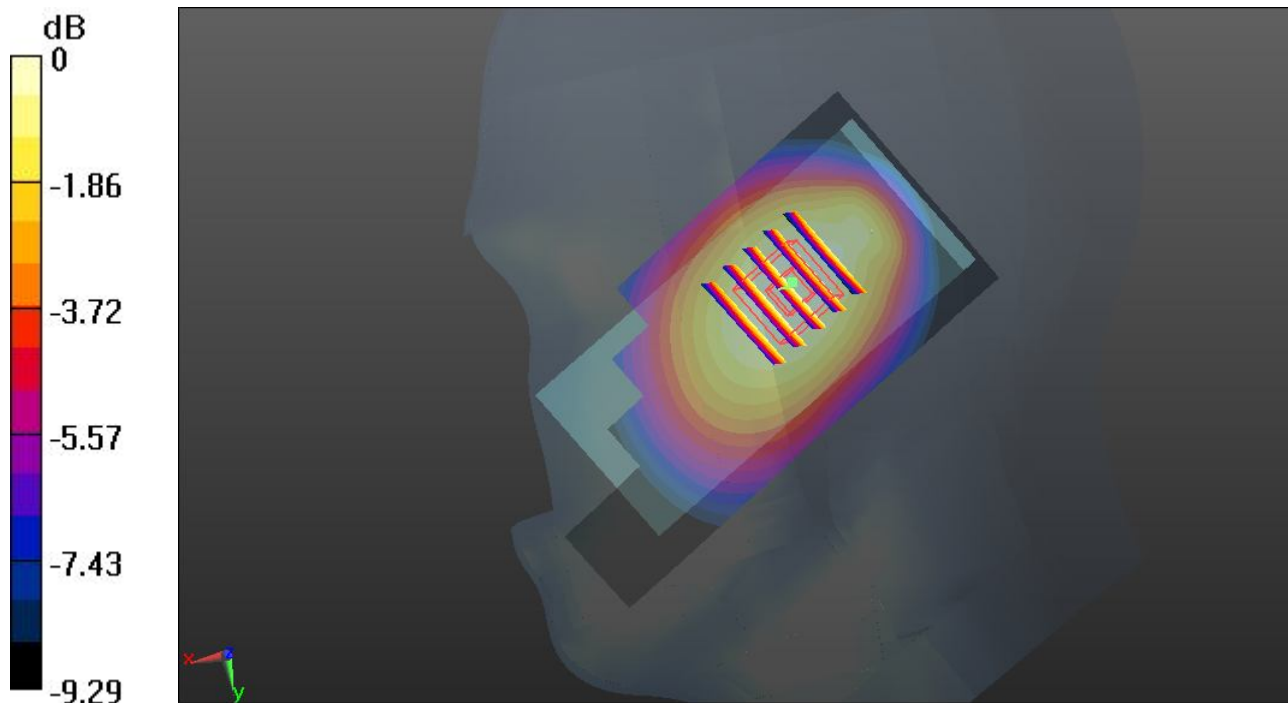

0 dB = 0.328 W/kg

13 CDMA2000 BC0_RC3 SO55_Left Cheek_Ch1013

DUT: 2O1106

Communication System: CDMA2000; Frequency: 824.7 MHz; Duty Cycle: 1:1

Medium: HSL_835_121104 Medium parameters used: $f = 825$ MHz; $\sigma = 0.916$ mho/m; $\epsilon_r = 41.828$; $\rho = 1000$ kg/m³

Ambient Temperature : 23.5 °C ; Liquid Temperature : 21.6 °C

DASY5 Configuration:

- Probe: EX3DV4 - SN3819; ConvF(9.4, 9.4, 9.4); Calibrated: 16.11.2011;
- Sensor-Surface: 4mm (Mechanical Surface Detection)
- Electronics: DAE4 Sn1303; Calibrated: 10.11.2011
- Phantom: SAM2; Type: QD000P40CD; Serial: TP:1671
- Measurement SW: DASY52, Version 52.8 (2); SEMCAD X Version 14.6.6 (6824)

Ch1013/Area Scan (51x101x1): Interpolated grid: dx=15mm, dy=15mm

Maximum value of SAR (interpolated) = 0.441 W/kg

Ch1013/Zoom Scan (5x5x7)/Cube 0: Measurement grid: dx=8mm, dy=8mm, dz=5mm

Reference Value = 12.505 V/m; Power Drift = 0.12 dB

Peak SAR (extrapolated) = 0.540 mW/g

SAR(1 g) = 0.429 mW/g; SAR(10 g) = 0.316 mW/g

Maximum value of SAR (measured) = 0.454 W/kg

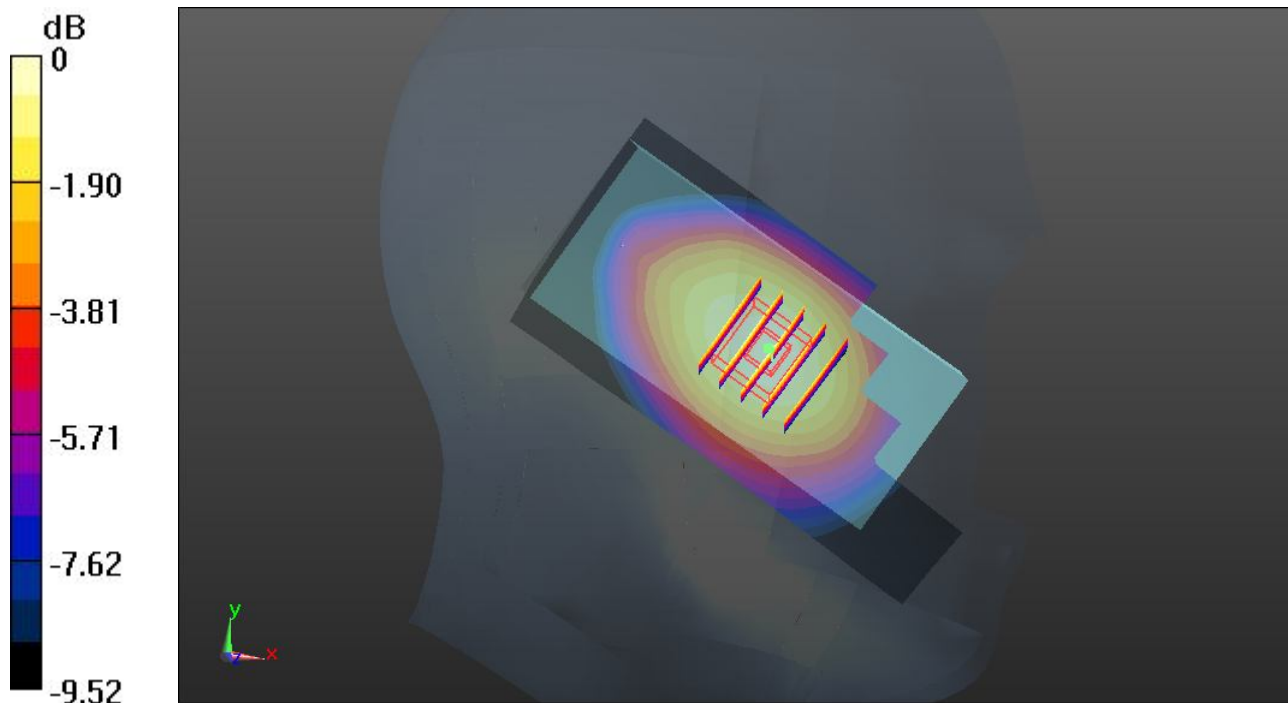

0 dB = 0.454 W/kg

14 CDMA2000 BC0_RC3 SO55_Left Tilted_Ch1013

DUT: 2O1106

Communication System: CDMA2000; Frequency: 824.7 MHz; Duty Cycle: 1:1

Medium: HSL_835_121104 Medium parameters used: $f = 825$ MHz; $\sigma = 0.916$ mho/m; $\epsilon_r = 41.828$; $\rho = 1000$ kg/m³

Ambient Temperature : 23.5 °C ; Liquid Temperature : 21.6 °C

DASY5 Configuration:

- Probe: EX3DV4 - SN3819; ConvF(9.4, 9.4, 9.4); Calibrated: 16.11.2011;
- Sensor-Surface: 4mm (Mechanical Surface Detection)
- Electronics: DAE4 Sn1303; Calibrated: 10.11.2011
- Phantom: SAM2; Type: QD000P40CD; Serial: TP:1671
- Measurement SW: DASY52, Version 52.8 (2); SEMCAD X Version 14.6.6 (6824)

Ch1013/Area Scan (51x101x1): Interpolated grid: dx=15mm, dy=15mm

Maximum value of SAR (interpolated) = 0.263 W/kg

Ch1013/Zoom Scan (5x5x7)/Cube 0: Measurement grid: dx=8mm, dy=8mm, dz=5mm

Reference Value = 15.029 V/m; Power Drift = 0.01 dB

Peak SAR (extrapolated) = 0.330 mW/g

SAR(1 g) = 0.251 mW/g; SAR(10 g) = 0.184 mW/g

Maximum value of SAR (measured) = 0.266 W/kg

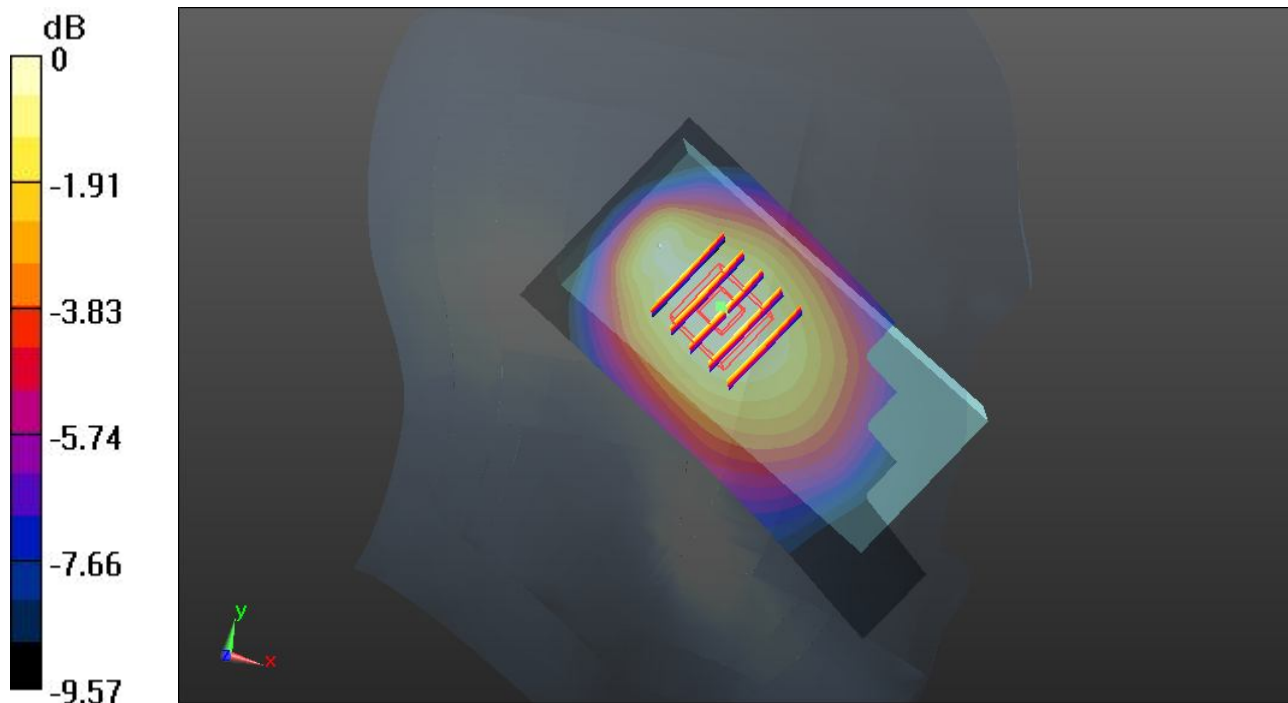

06 CDMA2000 BC1_RC3 SO55_Right Cheek_Ch600

DUT: 2O1106

Communication System: CDMA2000; Frequency: 1880 MHz; Duty Cycle: 1:1
Medium: HSL_1900_121103 Medium parameters used: $f = 1880$ MHz; $\sigma = 1.399$ mho/m; $\epsilon_r = 40.745$; $\rho = 1000$ kg/m³
Ambient Temperature : 23.5 °C ; Liquid Temperature : 21.4 °C

DASY5 Configuration:

- Probe: EX3DV4 - SN3819; ConvF(8.36, 8.36, 8.36); Calibrated: 16.11.2011;
- Sensor-Surface: 4mm (Mechanical Surface Detection)
- Electronics: DAE4 Sn1303; Calibrated: 10.11.2011
- Phantom: SAM1; Type: QD000P40CD; Serial: TP:1670
- Measurement SW: DASY52, Version 52.8 (2); SEMCAD X Version 14.6.6 (6824)

Ch600/Area Scan (51x101x1): Interpolated grid: dx=15mm, dy=15mm
Maximum value of SAR (interpolated) = 0.309 W/kg

Ch600/Zoom Scan (5x5x7)/Cube 0: Measurement grid: dx=8mm, dy=8mm, dz=5mm
Reference Value = 8.344 V/m; Power Drift = 0.12 dB
Peak SAR (extrapolated) = 0.431 mW/g
SAR(1 g) = 0.281 mW/g; SAR(10 g) = 0.182 mW/g
Maximum value of SAR (measured) = 0.304 W/kg

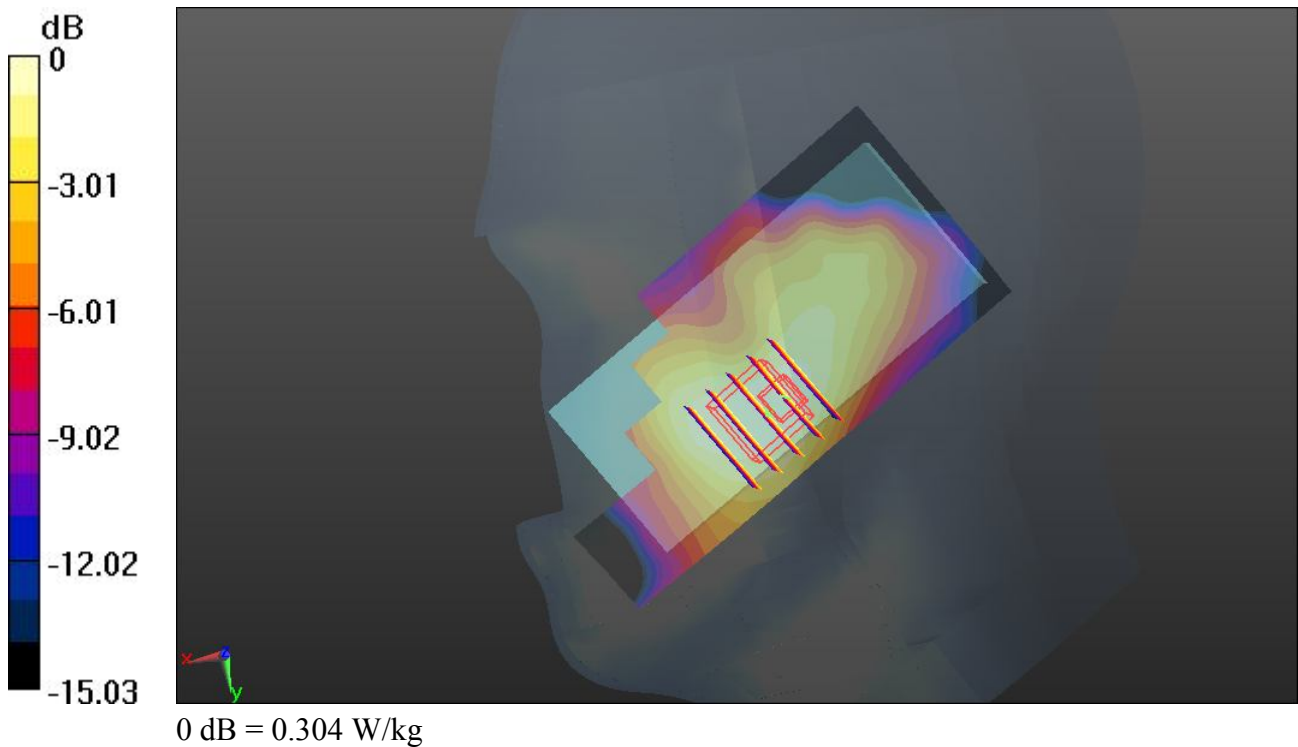

06 CDMA2000 BC1_RC3 SO55_Right Cheek_Ch600_2D

DUT: 2O1106

Communication System: CDMA2000; Frequency: 1880 MHz; Duty Cycle: 1:1
Medium: HSL_1900_121103 Medium parameters used: $f = 1880$ MHz; $\sigma = 1.399$ mho/m; $\epsilon_r = 40.745$; $\rho = 1000$ kg/m³
Ambient Temperature : 23.5 °C ; Liquid Temperature : 21.4 °C

DASY5 Configuration:

- Probe: EX3DV4 - SN3819; ConvF(8.36, 8.36, 8.36); Calibrated: 16.11.2011;
- Sensor-Surface: 4mm (Mechanical Surface Detection)
- Electronics: DAE4 Sn1303; Calibrated: 10.11.2011
- Phantom: SAM1; Type: QD000P40CD; Serial: TP:1670
- Measurement SW: DASY52, Version 52.8 (2); SEMCAD X Version 14.6.6 (6824)

Ch600/Area Scan (51x101x1): Interpolated grid: dx=15mm, dy=15mm
Maximum value of SAR (interpolated) = 0.309 W/kg

Ch600/Zoom Scan (5x5x7)/Cube 0: Measurement grid: dx=8mm, dy=8mm, dz=5mm
Reference Value = 8.344 V/m; Power Drift = 0.12 dB
Peak SAR (extrapolated) = 0.431 mW/g
SAR(1 g) = 0.281 mW/g; SAR(10 g) = 0.182 mW/g
Maximum value of SAR (measured) = 0.304 W/kg

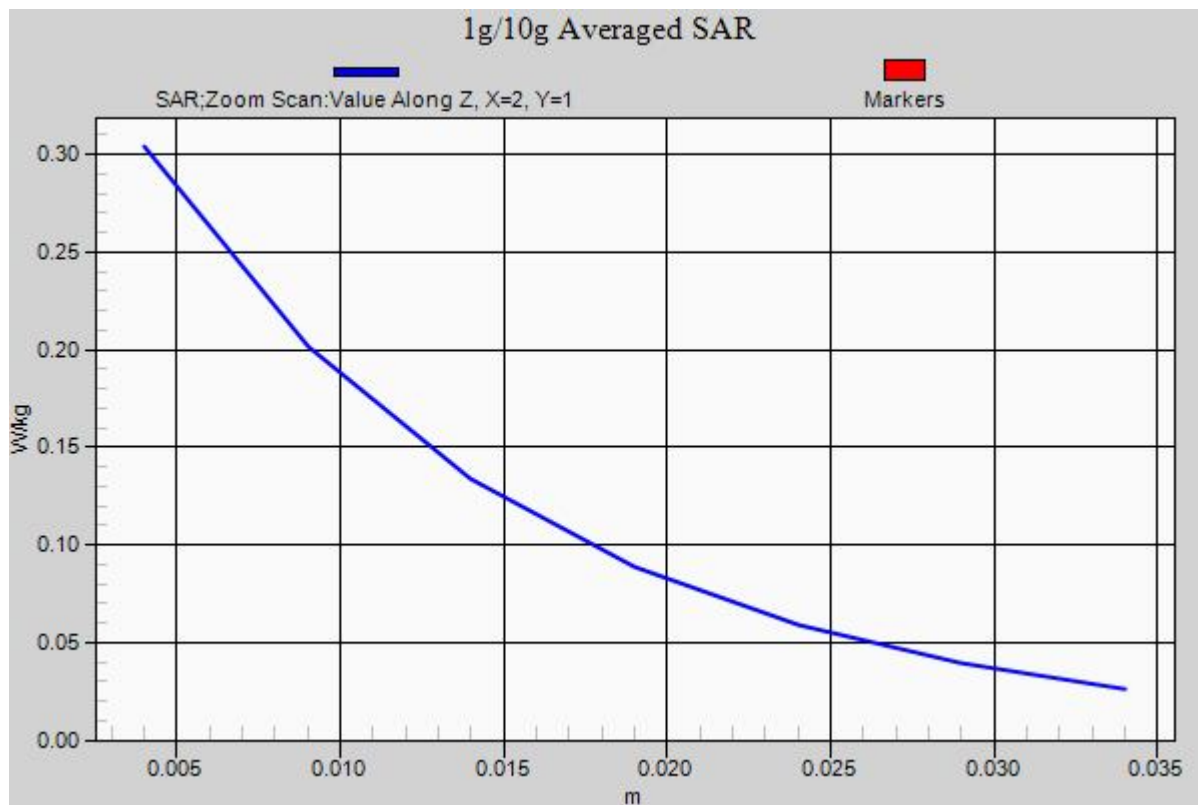

07 CDMA2000 BC1_RC3 SO55_Right Tilted_Ch600

DUT: 2O1106

Communication System: CDMA2000; Frequency: 1880 MHz; Duty Cycle: 1:1
Medium: HSL_1900_121103 Medium parameters used: $f = 1880$ MHz; $\sigma = 1.399$ mho/m; $\epsilon_r = 40.745$; $\rho = 1000$ kg/m³
Ambient Temperature : 23.5 °C ; Liquid Temperature : 21.4 °C

DASY5 Configuration:

- Probe: EX3DV4 - SN3819; ConvF(8.36, 8.36, 8.36); Calibrated: 16.11.2011;
- Sensor-Surface: 4mm (Mechanical Surface Detection)
- Electronics: DAE4 Sn1303; Calibrated: 10.11.2011
- Phantom: SAM1; Type: QD000P40CD; Serial: TP:1670
- Measurement SW: DASY52, Version 52.8 (2); SEMCAD X Version 14.6.6 (6824)

Ch600/Area Scan (51x101x1): Interpolated grid: dx=15mm, dy=15mm

Maximum value of SAR (interpolated) = 0.230 W/kg

Ch600/Zoom Scan (5x5x7)/Cube 0: Measurement grid: dx=8mm, dy=8mm, dz=5mm

Reference Value = 11.823 V/m; Power Drift = 0.09 dB

Peak SAR (extrapolated) = 0.298 mW/g

SAR(1 g) = 0.195 mW/g; SAR(10 g) = 0.123 mW/g

Maximum value of SAR (measured) = 0.209 W/kg

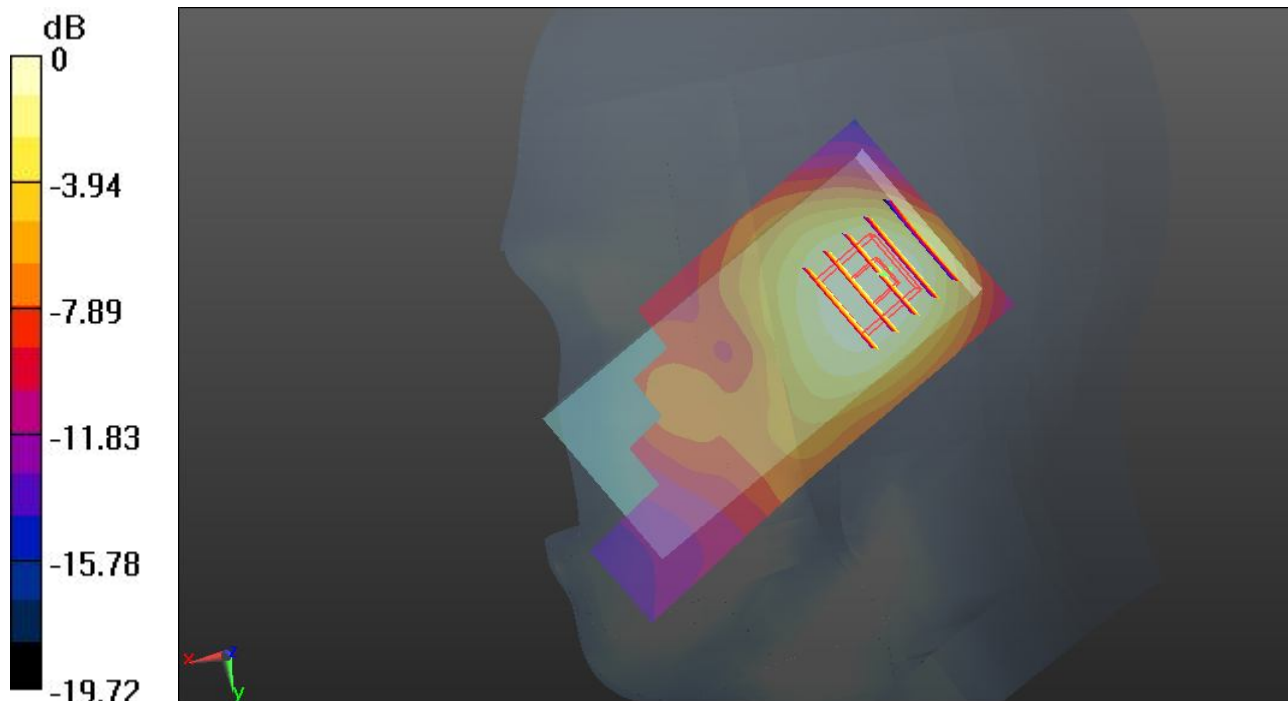

0 dB = 0.209 W/kg

08 CDMA2000 BC1_RC3 SO55_Left Cheek_Ch600

DUT: 2O1106

Communication System: CDMA2000; Frequency: 1880 MHz; Duty Cycle: 1:1
Medium: HSL_1900_121103 Medium parameters used: $f = 1880$ MHz; $\sigma = 1.399$ mho/m; $\epsilon_r = 40.745$; $\rho = 1000$ kg/m³
Ambient Temperature : 23.5 °C ; Liquid Temperature : 21.4 °C

DASY5 Configuration:

- Probe: EX3DV4 - SN3819; ConvF(8.36, 8.36, 8.36); Calibrated: 16.11.2011;
- Sensor-Surface: 4mm (Mechanical Surface Detection)
- Electronics: DAE4 Sn1303; Calibrated: 10.11.2011
- Phantom: SAM1; Type: QD000P40CD; Serial: TP:1670
- Measurement SW: DASY52, Version 52.8 (2); SEMCAD X Version 14.6.6 (6824)

Ch600/Area Scan (51x101x1): Interpolated grid: dx=15mm, dy=15mm

Maximum value of SAR (interpolated) = 0.295 W/kg

Ch600/Zoom Scan (5x5x7)/Cube 0: Measurement grid: dx=8mm, dy=8mm, dz=5mm

Reference Value = 7.860 V/m; Power Drift = -0.11 dB

Peak SAR (extrapolated) = 0.374 mW/g

SAR(1 g) = 0.257 mW/g; SAR(10 g) = 0.159 mW/g

Maximum value of SAR (measured) = 0.276 W/kg

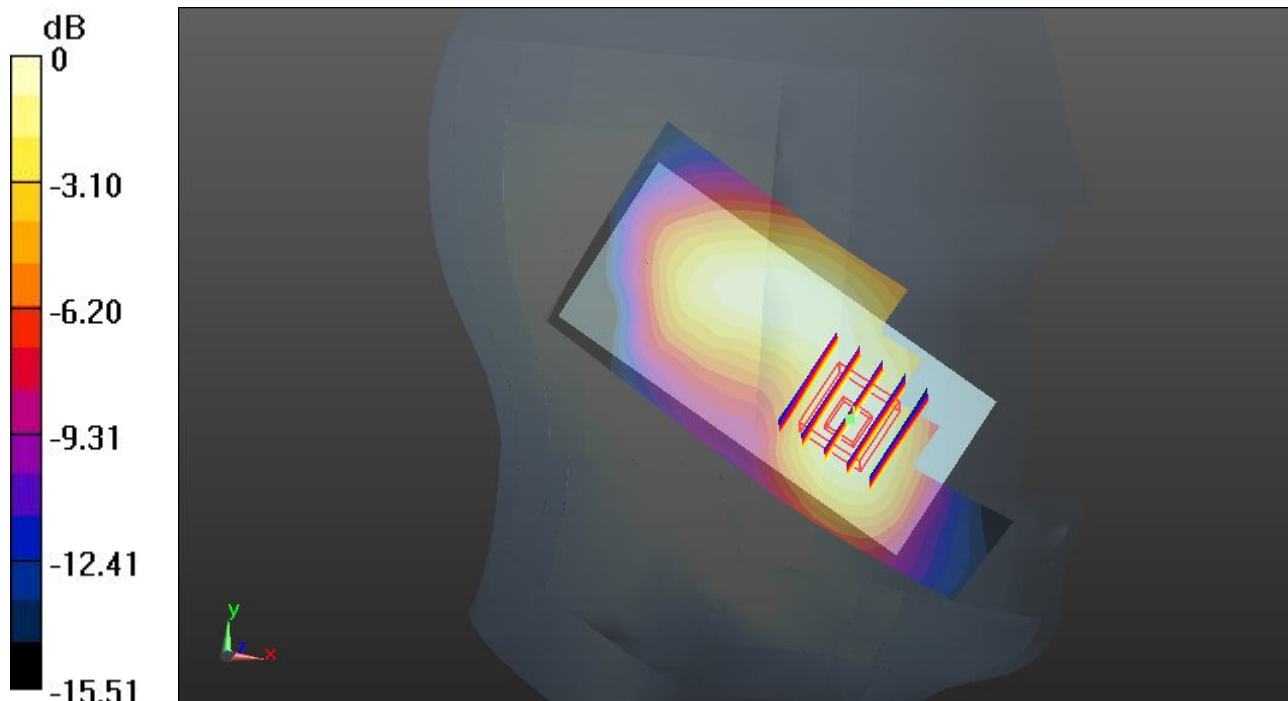

0 dB = 0.276 W/kg

09 CDMA2000 BC1_RC3 SO55_Left Tilted_Ch600

DUT: 2O1106

Communication System: CDMA2000; Frequency: 1880 MHz; Duty Cycle: 1:1
Medium: HSL_1900_121103 Medium parameters used: $f = 1880$ MHz; $\sigma = 1.399$ mho/m; $\epsilon_r = 40.745$; $\rho = 1000$ kg/m³
Ambient Temperature : 23.5 °C ; Liquid Temperature : 21.4 °C

DASY5 Configuration:

- Probe: EX3DV4 - SN3819; ConvF(8.36, 8.36, 8.36); Calibrated: 16.11.2011;
- Sensor-Surface: 4mm (Mechanical Surface Detection)
- Electronics: DAE4 Sn1303; Calibrated: 10.11.2011
- Phantom: SAM1; Type: QD000P40CD; Serial: TP:1670
- Measurement SW: DASY52, Version 52.8 (2); SEMCAD X Version 14.6.6 (6824)

Ch600/Area Scan (51x101x1): Interpolated grid: dx=15mm, dy=15mm
Maximum value of SAR (interpolated) = 0.224 W/kg

Ch600/Zoom Scan (5x5x7)/Cube 0: Measurement grid: dx=8mm, dy=8mm, dz=5mm
Reference Value = 10.548 V/m; Power Drift = -0.02 dB
Peak SAR (extrapolated) = 0.297 mW/g
SAR(1 g) = 0.198 mW/g; SAR(10 g) = 0.124 mW/g
Maximum value of SAR (measured) = 0.213 W/kg

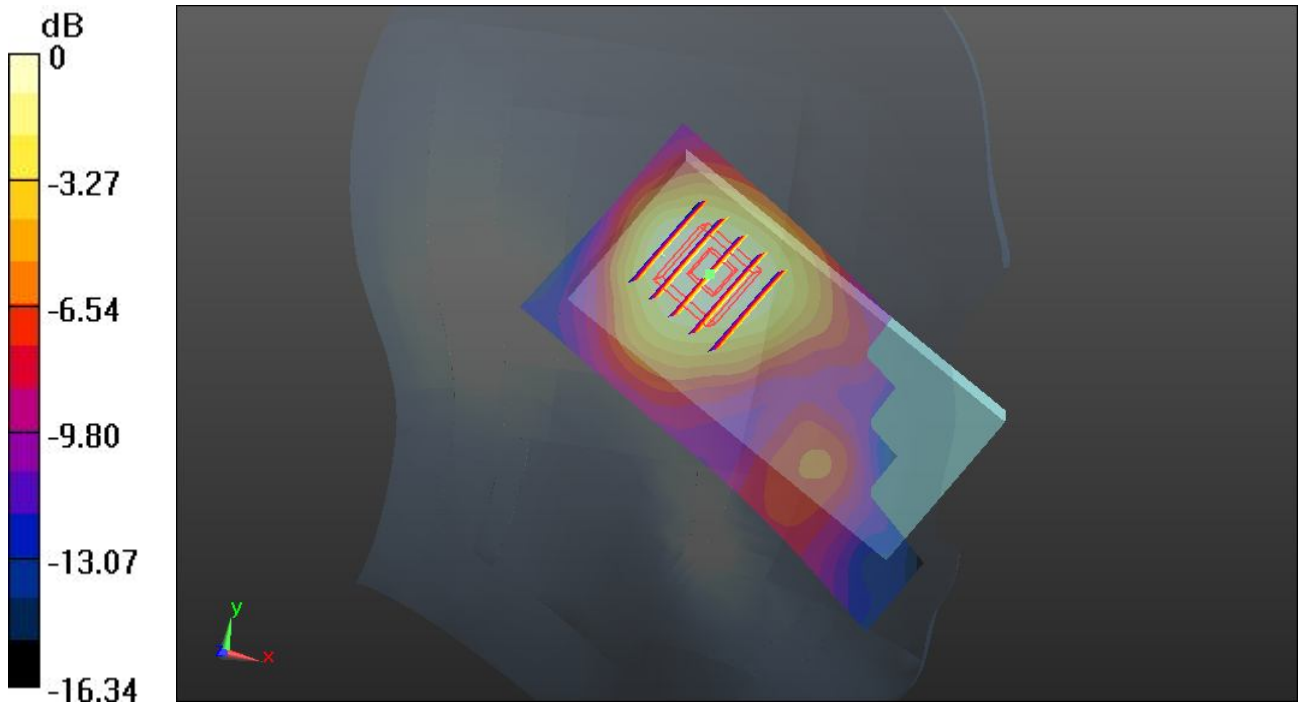

0 dB = 0.213 W/kg

10 CDMA2000 BC14_RC3 SO55_Right Cheek_Ch1275

DUT: 2O1106

Communication System: CDMA2000; Frequency: 1913.75 MHz; Duty Cycle: 1:1

Medium: HSL_1900_121103 Medium parameters used: $f = 1913.75$ MHz; $\sigma = 1.434$ mho/m; $\epsilon_r =$

40.632 ; $\rho = 1000$ kg/m³

Ambient Temperature : 23.5 °C ; Liquid Temperature : 21.4 °C

DASY5 Configuration:

- Probe: EX3DV4 - SN3819; ConvF(8.36, 8.36, 8.36); Calibrated: 16.11.2011;
- Sensor-Surface: 4mm (Mechanical Surface Detection)
- Electronics: DAE4 Sn1303; Calibrated: 10.11.2011
- Phantom: SAM1; Type: QD000P40CD; Serial: TP:1670
- Measurement SW: DASY52, Version 52.8 (2); SEMCAD X Version 14.6.6 (6824)

Ch1275/Area Scan (51x101x1): Interpolated grid: dx=15mm, dy=15mm

Maximum value of SAR (interpolated) = 0.295 W/kg

Ch1275/Zoom Scan (5x5x7)/Cube 0: Measurement grid: dx=8mm, dy=8mm, dz=5mm

Reference Value = 8.698 V/m; Power Drift = -0.17 dB

Peak SAR (extrapolated) = 0.392 mW/g

SAR(1 g) = 0.252 mW/g; SAR(10 g) = 0.159 mW/g

Maximum value of SAR (measured) = 0.266 W/kg

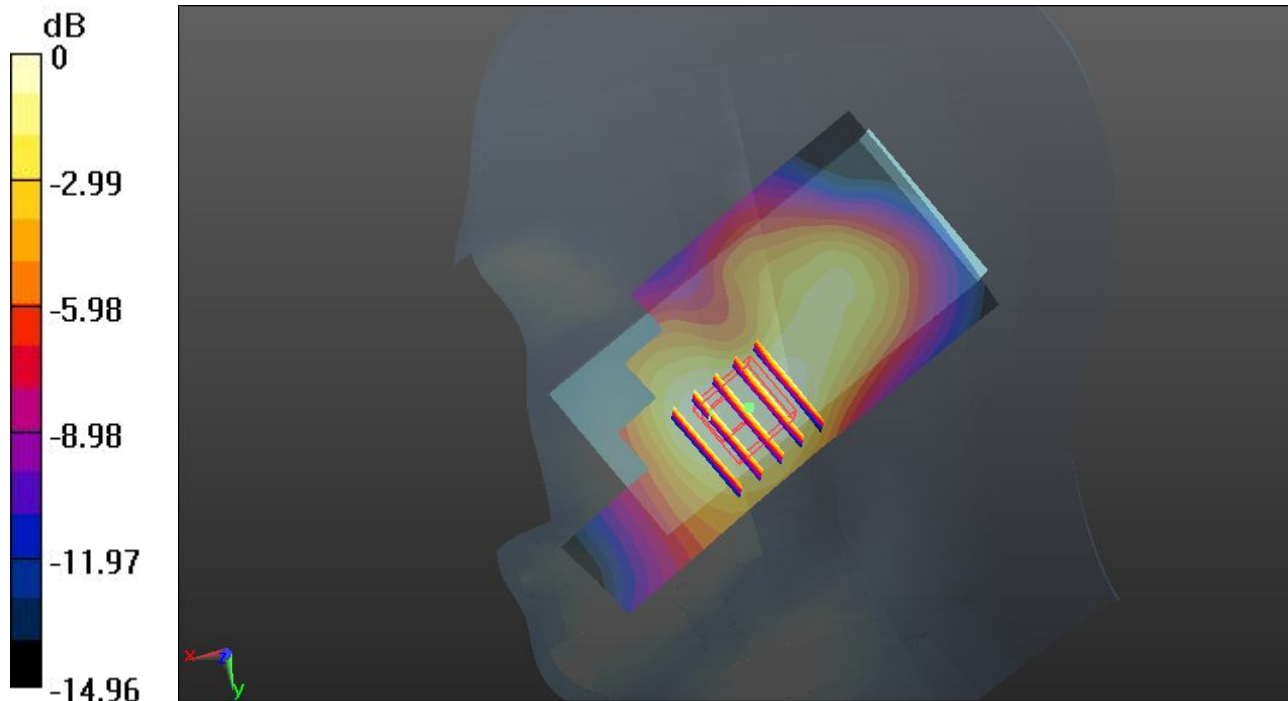

0 dB = 0.266 W/kg

15 CDMA2000 BC0_RC3 SO32_Front_1.5cm_Ch1013_Headset

DUT: 2O1106

Communication System: CDMA2000; Frequency: 824.7 MHz; Duty Cycle: 1:1

Medium: MSL_835_121104 Medium parameters used: $f = 825 \text{ MHz}$; $\sigma = 0.961 \text{ mho/m}$; $\epsilon_r = 56.389$;

$\rho = 1000 \text{ kg/m}^3$

Ambient Temperature : $23.5 \text{ }^\circ\text{C}$; Liquid Temperature : $21.7 \text{ }^\circ\text{C}$

DASY5 Configuration:

- Probe: EX3DV4 - SN3819; ConvF(9.72, 9.72, 9.72); Calibrated: 16.11.2011;
- Sensor-Surface: 4mm (Mechanical Surface Detection)
- Electronics: DAE4 Sn1303; Calibrated: 10.11.2011
- Phantom: SAM2; Type: QD000P40CD; Serial: TP:1671
- Measurement SW: DASY52, Version 52.8 (2); SEMCAD X Version 14.6.6 (6824)

Ch1013/Area Scan (51x101x1): Interpolated grid: $dx=15\text{mm}$, $dy=15\text{mm}$

Maximum value of SAR (interpolated) = 0.514 W/kg

Ch1013/Zoom Scan (5x5x7)/Cube 0: Measurement grid: $dx=8\text{mm}$, $dy=8\text{mm}$, $dz=5\text{mm}$

Reference Value = 22.754 V/m ; Power Drift = 0.02 dB

Peak SAR (extrapolated) = 0.634 mW/g

SAR(1 g) = 0.489 mW/g ; SAR(10 g) = 0.361 mW/g

Maximum value of SAR (measured) = 0.514 W/kg

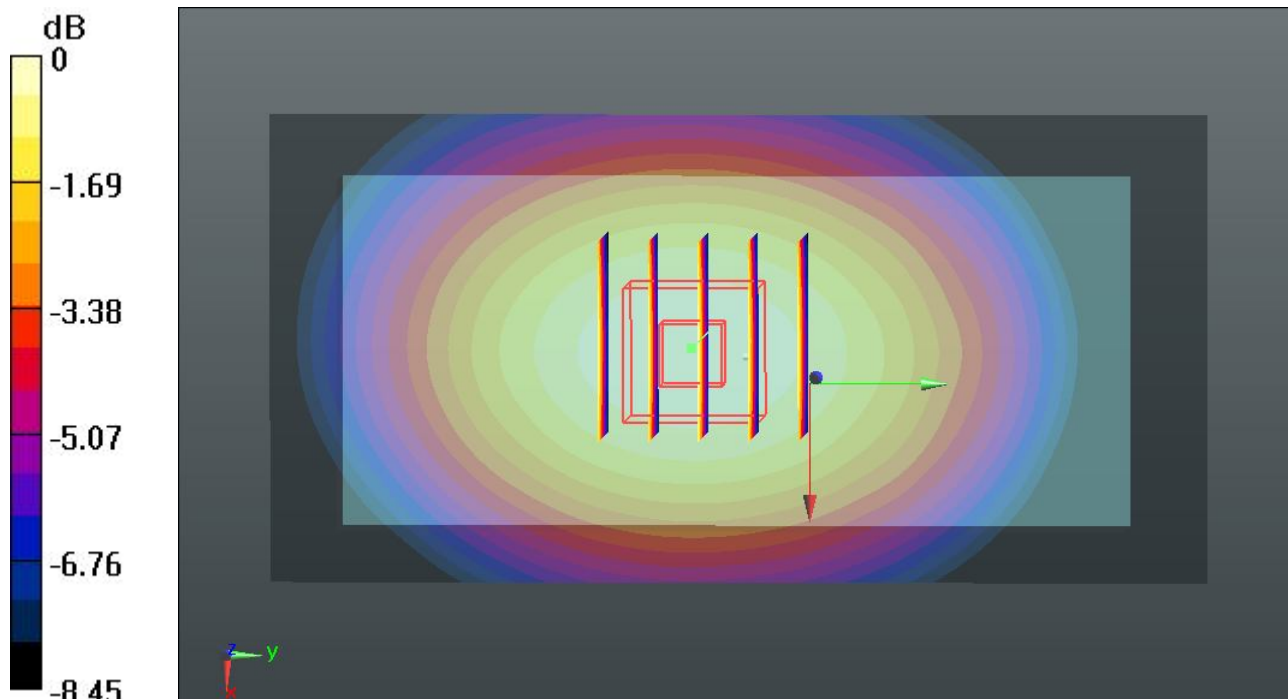

0 dB = 0.514 W/kg

16 CDMA2000 BC0_RC3 SO32_Back_1.5cm_Ch1013_Headset

DUT: 2O1106

Communication System: CDMA2000; Frequency: 824.7 MHz; Duty Cycle: 1:1

Medium: MSL_835_121104 Medium parameters used: $f = 825$ MHz; $\sigma = 0.961$ mho/m; $\epsilon_r = 56.389$;

$\rho = 1000$ kg/m³

Ambient Temperature : 23.5 °C ; Liquid Temperature : 21.7 °C

DASY5 Configuration:

- Probe: EX3DV4 - SN3819; ConvF(9.72, 9.72, 9.72); Calibrated: 16.11.2011;
- Sensor-Surface: 4mm (Mechanical Surface Detection)
- Electronics: DAE4 Sn1303; Calibrated: 10.11.2011
- Phantom: SAM2; Type: QD000P40CD; Serial: TP:1671
- Measurement SW: DASY52, Version 52.8 (2); SEMCAD X Version 14.6.6 (6824)

Ch1013/Area Scan (51x101x1): Interpolated grid: dx=15mm, dy=15mm

Maximum value of SAR (interpolated) = 0.758 W/kg

Ch1013/Zoom Scan (5x5x7)/Cube 0: Measurement grid: dx=8mm, dy=8mm, dz=5mm

Reference Value = 27.668 V/m; Power Drift = -0.04 dB

Peak SAR (extrapolated) = 0.946 mW/g

SAR(1 g) = 0.721 mW/g; SAR(10 g) = 0.528 mW/g

Maximum value of SAR (measured) = 0.761 W/kg

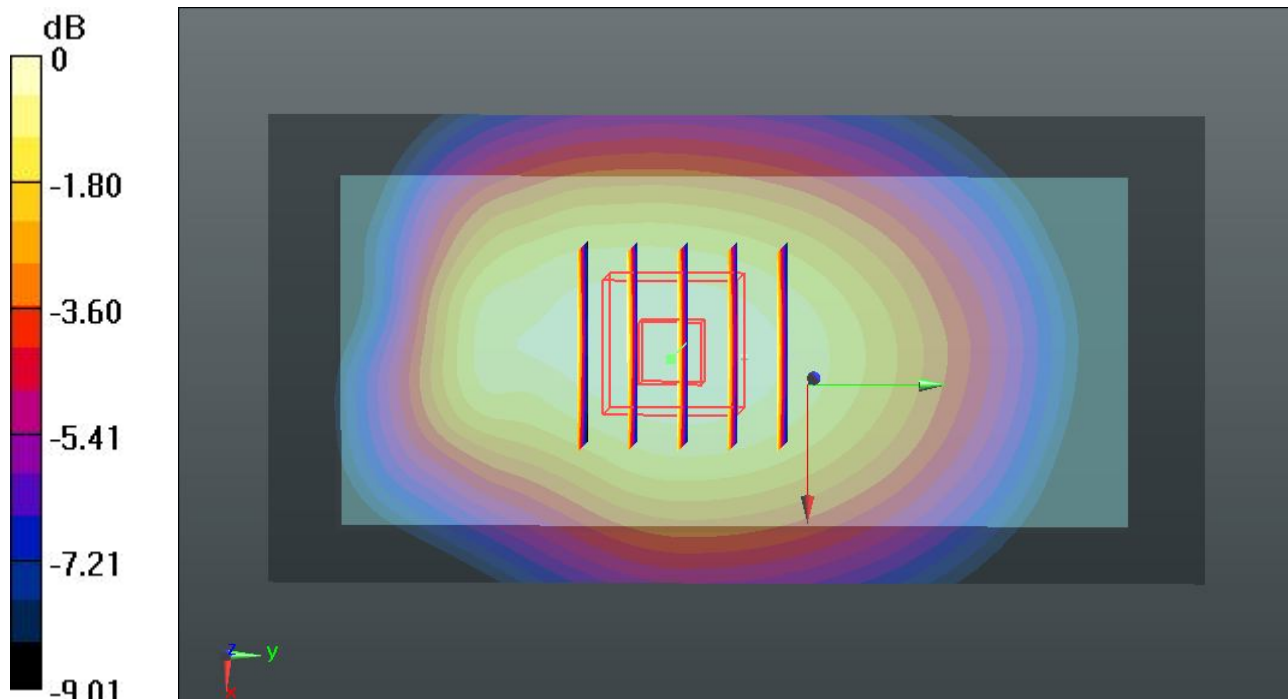

0 dB = 0.761 W/kg

16 CDMA2000 BC0_RC3 SO32_Back_1.5cm_Ch1013_Headset_2D

DUT: 2O1106

Communication System: CDMA2000; Frequency: 824.7 MHz; Duty Cycle: 1:1

Medium: MSL_835_121104 Medium parameters used: $f = 825 \text{ MHz}$; $\sigma = 0.961 \text{ mho/m}$; $\epsilon_r = 56.389$;

$\rho = 1000 \text{ kg/m}^3$

Ambient Temperature : $23.5 \text{ }^\circ\text{C}$; Liquid Temperature : $21.7 \text{ }^\circ\text{C}$

DASY5 Configuration:

- Probe: EX3DV4 - SN3819; ConvF(9.72, 9.72, 9.72); Calibrated: 16.11.2011;
- Sensor-Surface: 4mm (Mechanical Surface Detection)
- Electronics: DAE4 Sn1303; Calibrated: 10.11.2011
- Phantom: SAM2; Type: QD000P40CD; Serial: TP:1671
- Measurement SW: DASY52, Version 52.8 (2); SEMCAD X Version 14.6.6 (6824)

Ch1013/Area Scan (51x101x1): Interpolated grid: $dx=15\text{mm}$, $dy=15\text{mm}$

Maximum value of SAR (interpolated) = 0.758 W/kg

Ch1013/Zoom Scan (5x5x7)/Cube 0: Measurement grid: $dx=8\text{mm}$, $dy=8\text{mm}$, $dz=5\text{mm}$

Reference Value = 27.668 V/m ; Power Drift = -0.04 dB

Peak SAR (extrapolated) = 0.946 mW/g

SAR(1 g) = 0.721 mW/g ; SAR(10 g) = 0.528 mW/g

Maximum value of SAR (measured) = 0.761 W/kg

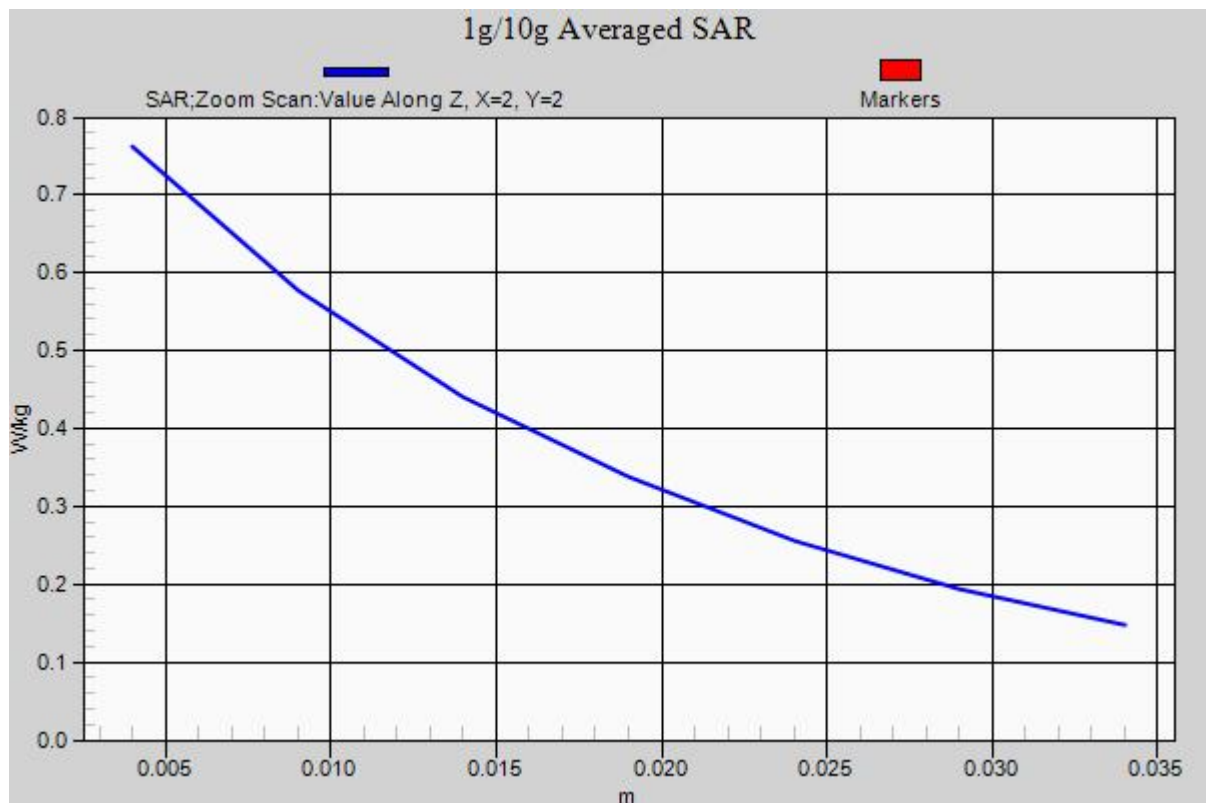

01 CDMA2000 BC1_RC3 SO32_Front_1.5cm_Ch600_Headset

DUT: 2O1106

Communication System: CDMA2000; Frequency: 1880 MHz; Duty Cycle: 1:1

Medium: MSL_1900_121103 Medium parameters used: $f = 1880$ MHz; $\sigma = 1.52$ mho/m; $\epsilon_r = 52.589$;

$\rho = 1000$ kg/m³

Ambient Temperature : 23.5 °C ; Liquid Temperature : 21.5 °C

DASY5 Configuration:

- Probe: EX3DV4 - SN3819; ConvF(7.71, 7.71, 7.71); Calibrated: 16.11.2011;
- Sensor-Surface: 4mm (Mechanical Surface Detection)
- Electronics: DAE4 Sn1303; Calibrated: 10.11.2011
- Phantom: SAM2; Type: QD000P40CD; Serial: TP:1671
- Measurement SW: DASY52, Version 52.8 (2); SEMCAD X Version 14.6.6 (6824)

Ch600/Area Scan (51x101x1): Interpolated grid: dx=15mm, dy=15mm

Maximum value of SAR (interpolated) = 0.332 W/kg

Ch600/Zoom Scan (5x5x7)/Cube 0: Measurement grid: dx=8mm, dy=8mm, dz=5mm

Reference Value = 7.077 V/m; Power Drift = 0.01 dB

Peak SAR (extrapolated) = 0.464 mW/g

SAR(1 g) = 0.298 mW/g; SAR(10 g) = 0.183 mW/g

Maximum value of SAR (measured) = 0.319 W/kg

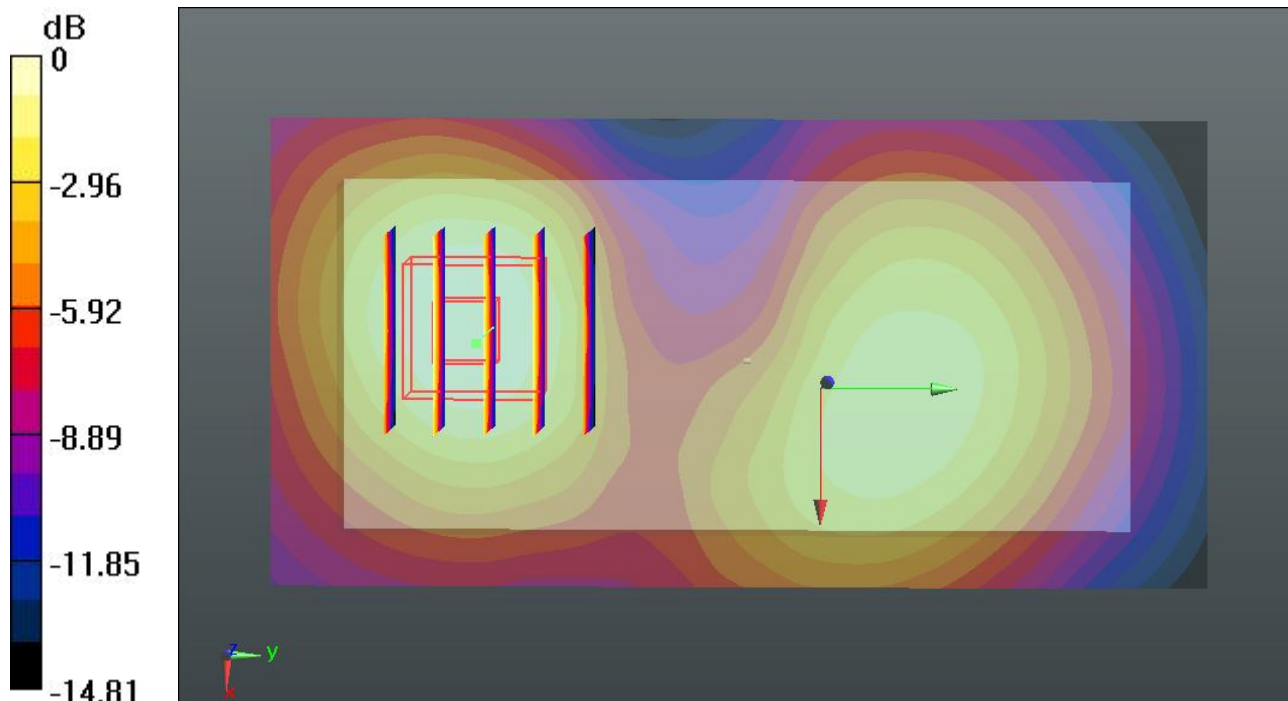

0 dB = 0.319 W/kg

02 CDMA2000 BC1_RC3 SO32_Back_1.5cm_Ch600_Headset

DUT: 2O1106

Communication System: CDMA2000; Frequency: 1880 MHz; Duty Cycle: 1:1

Medium: MSL_1900_121103 Medium parameters used: $f = 1880$ MHz; $\sigma = 1.52$ mho/m; $\epsilon_r = 52.589$;

$\rho = 1000$ kg/m³

Ambient Temperature : 23.5 °C ; Liquid Temperature : 21.5 °C

DASY5 Configuration:

- Probe: EX3DV4 - SN3819; ConvF(7.71, 7.71, 7.71); Calibrated: 16.11.2011;
- Sensor-Surface: 4mm (Mechanical Surface Detection)
- Electronics: DAE4 Sn1303; Calibrated: 10.11.2011
- Phantom: SAM2; Type: QD000P40CD; Serial: TP:1671
- Measurement SW: DASY52, Version 52.8 (2); SEMCAD X Version 14.6.6 (6824)

Ch600/Area Scan (51x101x1): Interpolated grid: dx=15mm, dy=15mm

Maximum value of SAR (interpolated) = 0.807 W/kg

Ch600/Zoom Scan (5x5x7)/Cube 0: Measurement grid: dx=8mm, dy=8mm, dz=5mm

Reference Value = 8.703 V/m; Power Drift = 0.08 dB

Peak SAR (extrapolated) = 1.264 mW/g

SAR(1 g) = 0.771 mW/g; SAR(10 g) = 0.462 mW/g

Maximum value of SAR (measured) = 0.845 W/kg

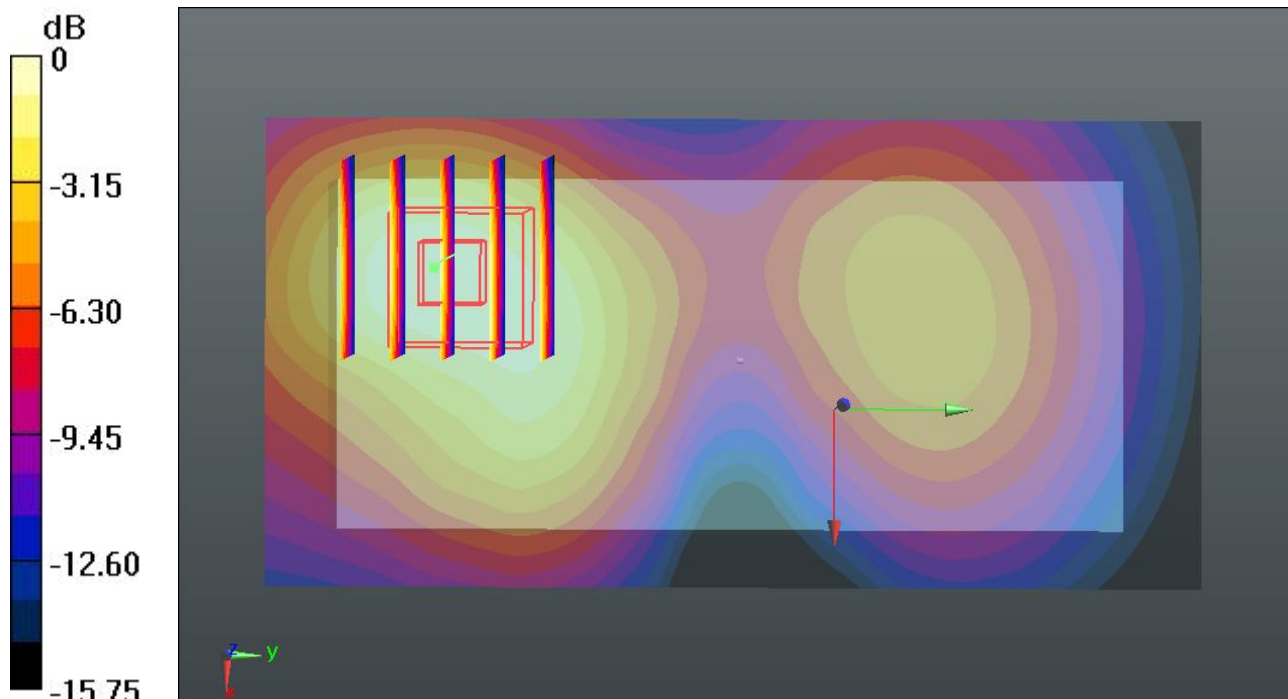

0 dB = 0.845 W/kg

02 CDMA2000 BC1_RC3 SO32_Back_1.5cm_Ch600_Headset_2D

DUT: 2O1106

Communication System: CDMA2000; Frequency: 1880 MHz; Duty Cycle: 1:1
Medium: MSL_1900_121103 Medium parameters used: $f = 1880$ MHz; $\sigma = 1.52$ mho/m; $\epsilon_r = 52.589$; $\rho = 1000$ kg/m³
Ambient Temperature : 23.5 °C ; Liquid Temperature : 21.5 °C

DASY5 Configuration:

- Probe: EX3DV4 - SN3819; ConvF(7.71, 7.71, 7.71); Calibrated: 16.11.2011;
- Sensor-Surface: 4mm (Mechanical Surface Detection)
- Electronics: DAE4 Sn1303; Calibrated: 10.11.2011
- Phantom: SAM2; Type: QD000P40CD; Serial: TP:1671
- Measurement SW: DASY52, Version 52.8 (2); SEMCAD X Version 14.6.6 (6824)

Ch600/Area Scan (51x101x1): Interpolated grid: dx=15mm, dy=15mm
Maximum value of SAR (interpolated) = 0.807 W/kg

Ch600/Zoom Scan (5x5x7)/Cube 0: Measurement grid: dx=8mm, dy=8mm, dz=5mm
Reference Value = 8.703 V/m; Power Drift = 0.08 dB
Peak SAR (extrapolated) = 1.264 mW/g
SAR(1 g) = 0.771 mW/g; SAR(10 g) = 0.462 mW/g
Maximum value of SAR (measured) = 0.845 W/kg

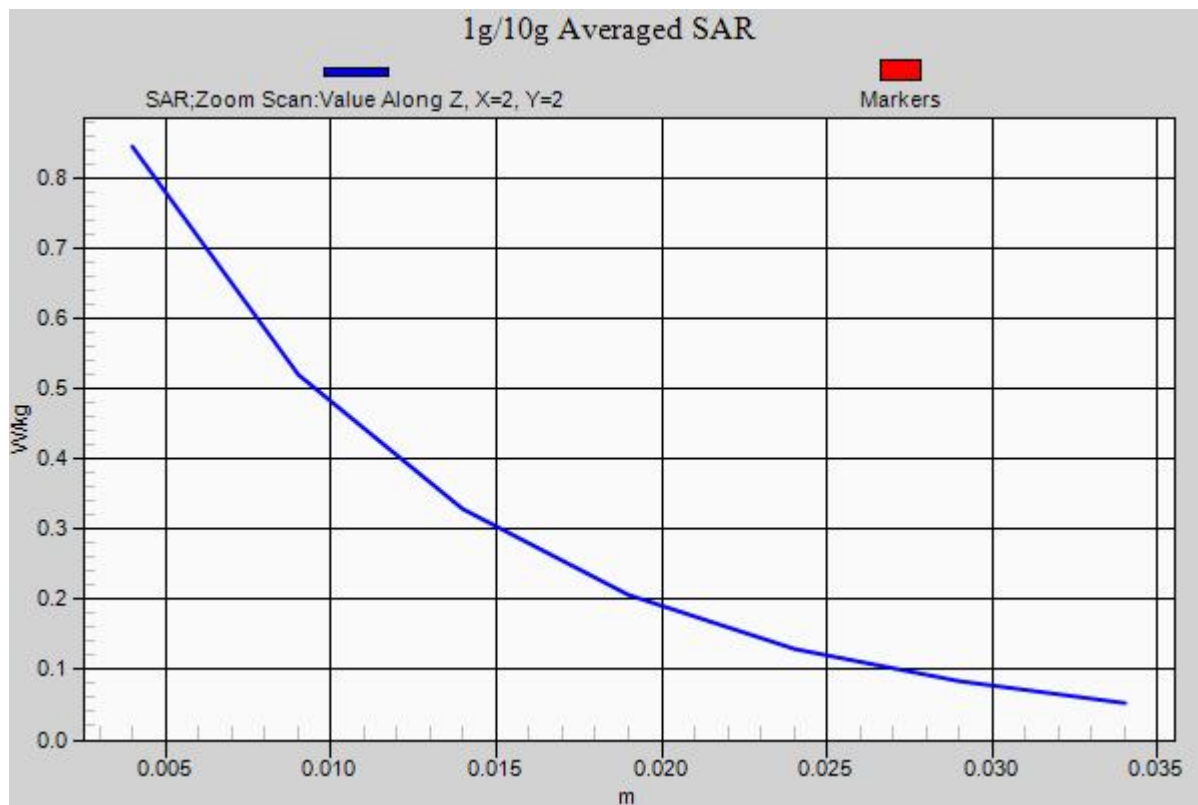

03 CDMA2000 BC14_RC3 SO32_Back_1.5cm_Ch1275_Headset

DUT: 2O1106

Communication System: CDMA2000; Frequency: 1913.75 MHz; Duty Cycle: 1:1

Medium: MSL_1900_121103 Medium parameters used: $f = 1913.75$ MHz; $\sigma = 1.558$ mho/m; $\epsilon_r =$

52.481 ; $\rho = 1000$ kg/m³

Ambient Temperature : 23.5 °C ; Liquid Temperature : 21.5 °C

DASY5 Configuration:

- Probe: EX3DV4 - SN3819; ConvF(7.71, 7.71, 7.71); Calibrated: 16.11.2011;
- Sensor-Surface: 4mm (Mechanical Surface Detection)
- Electronics: DAE4 Sn1303; Calibrated: 10.11.2011
- Phantom: SAM2; Type: QD000P40CD; Serial: TP:1671
- Measurement SW: DASY52, Version 52.8 (2); SEMCAD X Version 14.6.6 (6824)

Ch1275/Area Scan (51x101x1): Interpolated grid: dx=15mm, dy=15mm

Maximum value of SAR (interpolated) = 0.628 W/kg

Ch1275/Zoom Scan (5x5x7)/Cube 0: Measurement grid: dx=8mm, dy=8mm, dz=5mm

Reference Value = 7.502 V/m; Power Drift = -0.12 dB

Peak SAR (extrapolated) = 0.969 mW/g

SAR(1 g) = 0.590 mW/g; SAR(10 g) = 0.350 mW/g

Maximum value of SAR (measured) = 0.623 W/kg

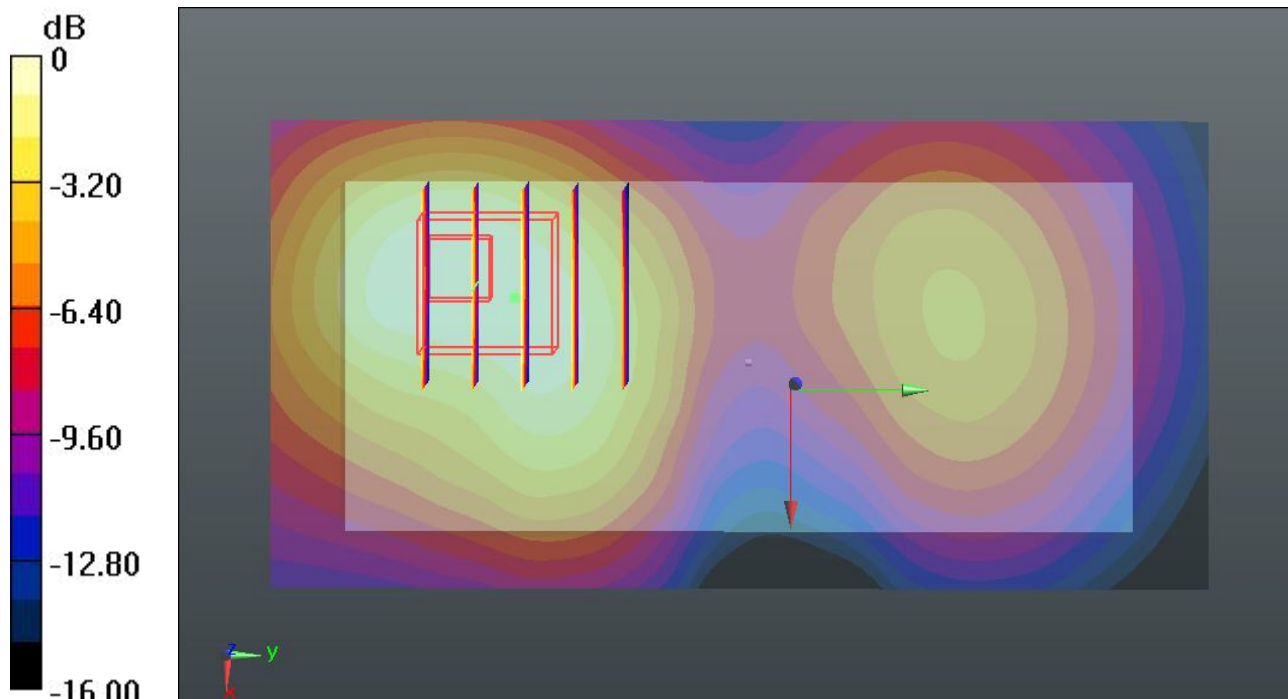

0 dB = 0.623 W/kg



Appendix C. DASYS Calibration Certificate

The DASYS calibration certificates are shown as follows.



Accredited by the Swiss Accreditation Service (SAS)
The Swiss Accreditation Service is one of the signatories to the EA
Multilateral Agreement for the recognition of calibration certificates

Accreditation No.: **SCS 108**

Client **Sporton-CN (Auden)**

Certificate No: **D835V2-4d091_Nov11**

CALIBRATION CERTIFICATE

Object: **D835V2 - SN: 4d091**

Calibration procedure(s): **QA CAL-05.v8
Calibration procedure for dipole validation kits above 700 MHz**

Calibration date: **November 18, 2011**

This calibration certificate documents the traceability to national standards, which realize the physical units of measurements (SI).
The measurements and the uncertainties with confidence probability are given on the following pages and are part of the certificate.

All calibrations have been conducted in the closed laboratory facility: environment temperature (22 ± 3)°C and humidity < 70%.

Calibration Equipment used (M&TE critical for calibration)

Primary Standards	ID #	Cal Date (Certificate No.)	Scheduled Calibration
Power meter EPM-442A	GB37480704	05-Oct-11 (No. 217-01451)	Oct-12
Power sensor HP 8481A	US37292783	05-Oct-11 (No. 217-01451)	Oct-12
Reference 20 dB Attenuator	SN: 5086 (20g)	29-Mar-11 (No. 217-01368)	Apr-12
Type-N mismatch combination	SN: 5047.2 / 06327	29-Mar-11 (No. 217-01371)	Apr-12
Reference Probe ES3DV3	SN: 3205	29-Apr-11 (No. ES3-3205_Apr11)	Apr-12
DAE4	SN: 601	04-Jul-11 (No. DAE4-601_Jul11)	Jul-12
Secondary Standards	ID #	Check Date (in house)	Scheduled Check
Power sensor HP 8481A	MY41092317	18-Oct-02 (in house check Oct-11)	In house check: Oct-13
RF generator R&S SMT-06	100005	04-Aug-99 (in house check Oct-11)	In house check: Oct-13
Network Analyzer HP 8753E	US37390585 S4206	18-Oct-01 (in house check Oct-11)	In house check: Oct-12

Calibrated by: **Dimce Iliev** (Name) / **Laboratory Technician** (Function) / *[Signature]* (Signature)

Approved by: **Katja Pokovic** (Name) / **Technical Manager** (Function) / *[Signature]* (Signature)

Issued: November 18, 2011

This calibration certificate shall not be reproduced except in full without written approval of the laboratory.



Accredited by the Swiss Accreditation Service (SAS)

Accreditation No.: **SCS 108**

The Swiss Accreditation Service is one of the signatories to the EA
Multilateral Agreement for the recognition of calibration certificates

Glossary:

TSL	tissue simulating liquid
ConvF	sensitivity in TSL / NORM x,y,z
N/A	not applicable or not measured

Calibration is Performed According to the Following Standards:

- IEEE Std 1528-2003, "IEEE Recommended Practice for Determining the Peak Spatial-Averaged Specific Absorption Rate (SAR) in the Human Head from Wireless Communications Devices: Measurement Techniques", December 2003
- IEC 62209-1, "Procedure to measure the Specific Absorption Rate (SAR) for hand-held devices used in close proximity to the ear (frequency range of 300 MHz to 3 GHz)", February 2005
- Federal Communications Commission Office of Engineering & Technology (FCC OET), "Evaluating Compliance with FCC Guidelines for Human Exposure to Radiofrequency Electromagnetic Fields; Additional Information for Evaluating Compliance of Mobile and Portable Devices with FCC Limits for Human Exposure to Radiofrequency Emissions", Supplement C (Edition 01-01) to Bulletin 65

Additional Documentation:

- DASY4/5 System Handbook

Methods Applied and Interpretation of Parameters:

- Measurement Conditions:** Further details are available from the Validation Report at the end of the certificate. All figures stated in the certificate are valid at the frequency indicated.
- Antenna Parameters with TSL:** The dipole is mounted with the spacer to position its feed point exactly below the center marking of the flat phantom section, with the arms oriented parallel to the body axis.
- Feed Point Impedance and Return Loss:** These parameters are measured with the dipole positioned under the liquid filled phantom. The impedance stated is transformed from the measurement at the SMA connector to the feed point. The Return Loss ensures low reflected power. No uncertainty required.
- Electrical Delay:** One-way delay between the SMA connector and the antenna feed point. No uncertainty required.
- SAR measured:** SAR measured at the stated antenna input power.
- SAR normalized:** SAR as measured, normalized to an input power of 1 W at the antenna connector.
- SAR for nominal TSL parameters:** The measured TSL parameters are used to calculate the nominal SAR result.

Measurement Conditions

DASY system configuration, as far as not given on page 1.

DASY Version	DASY5	V52.6.2
Extrapolation	Advanced Extrapolation	
Phantom	Modular Flat Phantom	
Distance Dipole Center - TSL	15 mm	with Spacer
Zoom Scan Resolution	dx, dy, dz = 5 mm	
Frequency	835 MHz \pm 1 MHz	

Head TSL parameters

The following parameters and calculations were applied.

	Temperature	Permittivity	Conductivity
Nominal Head TSL parameters	22.0 °C	41.5	0.90 mho/m
Measured Head TSL parameters	(22.0 \pm 0.2) °C	41.4 \pm 6 %	0.90 mho/m \pm 6 %
Head TSL temperature change during test	< 0.5 °C	----	----

SAR result with Head TSL

SAR averaged over 1 cm ³ (1 g) of Head TSL	Condition	
SAR measured	250 mW input power	2.35 mW / g
SAR for nominal Head TSL parameters	normalized to 1W	9.40 mW / g \pm 17.0 % (k=2)

SAR averaged over 10 cm ³ (10 g) of Head TSL	condition	
SAR measured	250 mW input power	1.54 mW / g
SAR for nominal Head TSL parameters	normalized to 1W	6.16 mW / g \pm 16.5 % (k=2)

Body TSL parameters

The following parameters and calculations were applied.

	Temperature	Permittivity	Conductivity
Nominal Body TSL parameters	22.0 °C	55.2	0.97 mho/m
Measured Body TSL parameters	(22.0 \pm 0.2) °C	53.3 \pm 6 %	0.99 mho/m \pm 6 %
Body TSL temperature change during test	< 0.5 °C	----	----

SAR result with Body TSL

SAR averaged over 1 cm ³ (1 g) of Body TSL	Condition	
SAR measured	250 mW input power	2.41 mW / g
SAR for nominal Body TSL parameters	normalized to 1W	9.42 mW / g \pm 17.0 % (k=2)

SAR averaged over 10 cm ³ (10 g) of Body TSL	condition	
SAR measured	250 mW input power	1.58 mW / g
SAR for nominal Body TSL parameters	normalized to 1W	6.21 mW / g \pm 16.5 % (k=2)

Appendix

Antenna Parameters with Head TSL

Impedance, transformed to feed point	50.9 Ω - 5.1 j Ω
Return Loss	- 25.7 dB

Antenna Parameters with Body TSL

Impedance, transformed to feed point	47.1 Ω - 6.9 j Ω
Return Loss	- 22.3 dB

General Antenna Parameters and Design

Electrical Delay (one direction)	1.396 ns.
----------------------------------	-----------

After long term use with 100W radiated power, only a slight warming of the dipole near the feedpoint can be measured.

The dipole is made of standard semirigid coaxial cable. The center conductor of the feeding line is directly connected to the second arm of the dipole. The antenna is therefore short-circuited for DC-signals.

No excessive force must be applied to the dipole arms, because they might bend or the soldered connections near the feedpoint may be damaged.

Additional EUT Data

Manufactured by	SPEAG
Manufactured on	September 15, 2009

DASY5 Validation Report for Head TSL

Date: 18.11.2011

Test Laboratory: SPEAG, Zurich, Switzerland

DUT: Dipole 835 MHz; Type: D835V2; Serial: D835V2 - SN: 4d091

Communication System: CW; Frequency: 835 MHz

Medium parameters used: $f = 835$ MHz; $\sigma = 0.9$ mho/m; $\epsilon_r = 41.4$; $\rho = 1000$ kg/m³

Phantom section: Flat Section

Measurement Standard: DASY5 (IEEE/IEC/ANSI C63.19-2007)

DASY52 Configuration:

- Probe: ES3DV3 - SN3205; ConvF(6.07, 6.07, 6.07); Calibrated: 29.04.2011
- Sensor-Surface: 3mm (Mechanical Surface Detection)
- Electronics: DAE4 Sn601; Calibrated: 04.07.2011
- Phantom: Flat Phantom 4.9L; Type: QD000P49AA; Serial: 1001
- DASY52 52.6.2(482); SEMCAD X 14.4.5(3634)

Dipole Calibration for Head Tissue/Pin=250 mW, d=15mm/Zoom Scan (7x7x7)/Cube 0:

Measurement grid: dx=5mm, dy=5mm, dz=5mm

Reference Value = 56.950 V/m; Power Drift = -0.0036 dB

Peak SAR (extrapolated) = 3.473 W/kg

SAR(1 g) = 2.35 mW/g; SAR(10 g) = 1.54 mW/g

Maximum value of SAR (measured) = 2.740 mW/g

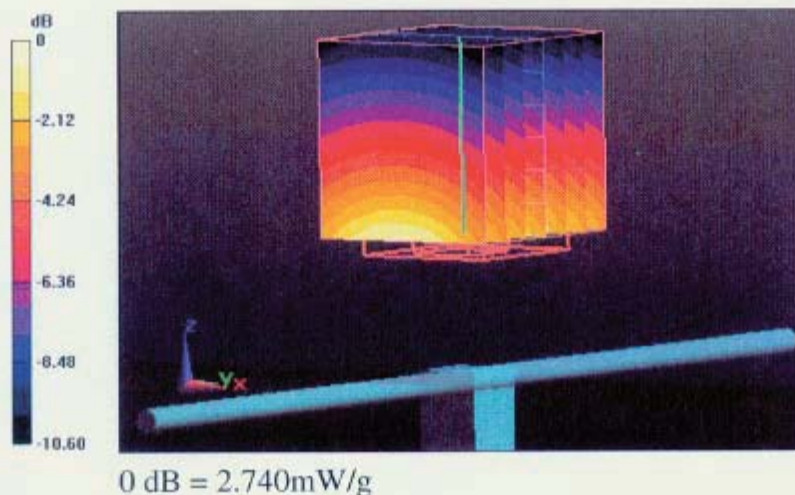

Impedance Measurement Plot for Head TSL

18 Nov 2011 15:39:43
[CH1] S11 1 U FS 1: 50.867 Ω -5.1504 Ω 37.009 pF 835.000 000 MHz

De1
Cor

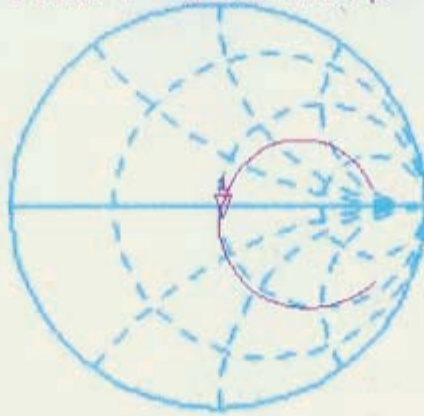

Avg
16

H1 d

CH2 S11 LOG 5 dB/REF -20 dB 1:-25.734 dB 835.000 000 MHz

Cor

Avg
16

H1 d

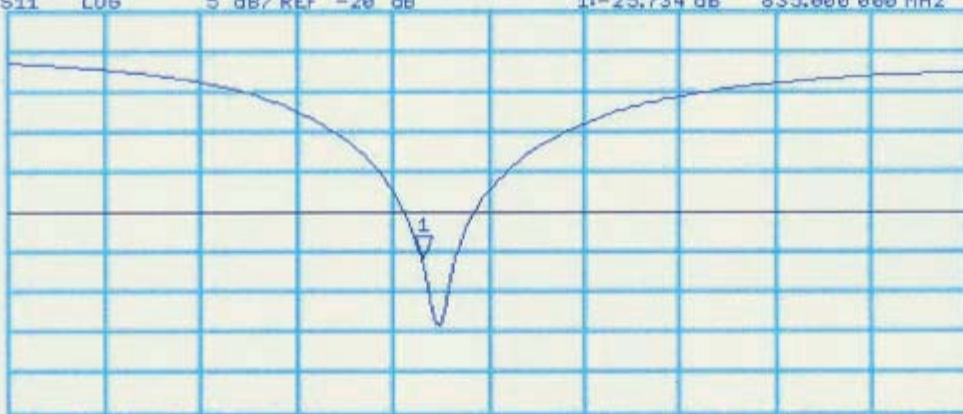

START 635.000 000 MHz

STOP 1 100.000 000 MHz

DASY5 Validation Report for Body TSL

Date: 18.11.2011

Test Laboratory: SPEAG, Zurich, Switzerland

DUT: Dipole 835 MHz; Type: D835V2; Serial: D835V2 - SN: 4d091

Communication System: CW; Frequency: 835 MHz

Medium parameters used: $f = 835$ MHz; $\sigma = 0.99$ mho/m; $\epsilon_r = 53.3$; $\rho = 1000$ kg/m³

Phantom section: Flat Section

Measurement Standard: DASY5 (IEEE/IEC/ANSI C63.19-2007)

DASY52 Configuration:

- Probe: ES3DV3 - SN3205; ConvF(6.02, 6.02, 6.02); Calibrated: 29.04.2011
- Sensor-Surface: 3mm (Mechanical Surface Detection)
- Electronics: DAE4 Sn601; Calibrated: 04.07.2011
- Phantom: Flat Phantom 4.9L; Type: QD000P49AA; Serial: 1001
- DASY52 52.6.2(482); SEMCAD X 14.4.5(3634)

Dipole Calibration for Body Tissue/Pin=250 mW, d=15mm/Zoom Scan (7x7x7)/Cube 0:

Measurement grid: dx=5mm, dy=5mm, dz=5mm

Reference Value = 55.082 V/m; Power Drift = 0.01 dB

Peak SAR (extrapolated) = 3.502 W/kg

SAR(1 g) = 2.41 mW/g; SAR(10 g) = 1.58 mW/g

Maximum value of SAR (measured) = 2.809 mW/g

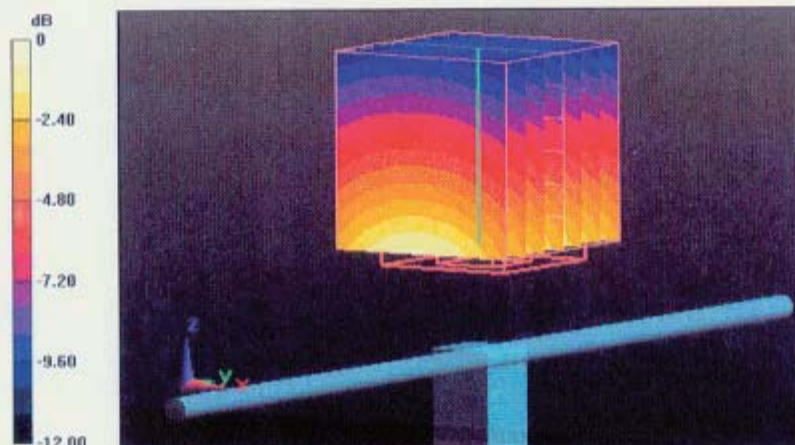

0 dB = 2.810mW/g

Impedance Measurement Plot for Body TSL

18 Nov 2011 10:16:18

CH1 S11 1 U FS

1: 47.082 Ω -6.8594 Ω 27.787 pF

835.000 000 MHz

*
Del
Cor

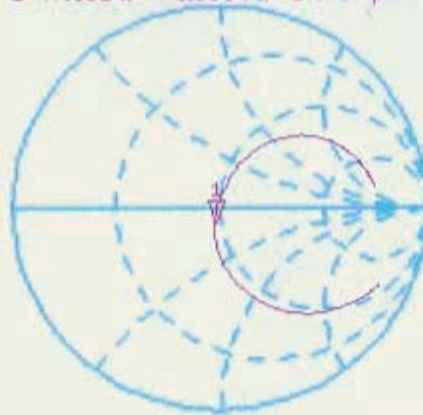

avg
16

H1d

CH2 S11 LOG

5 dB/REF -20 dB

1: -22.318 dB

835.000 000 MHz

Cor

avg
16

H1d

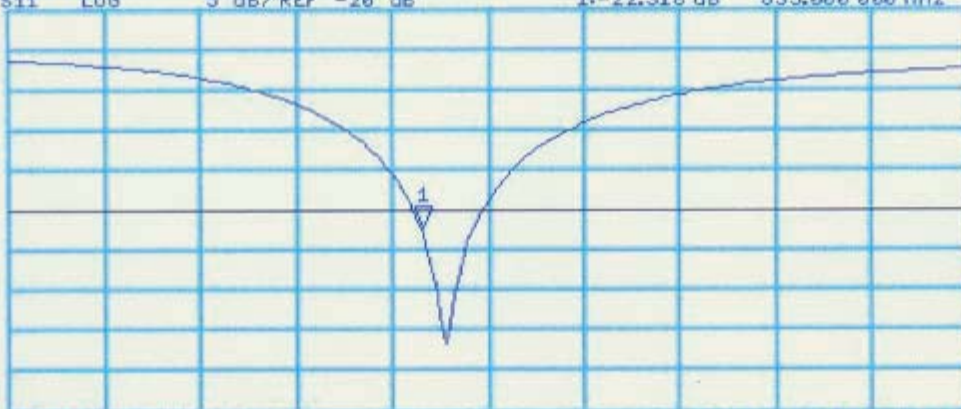

START 635.000 000 MHz

STOP 1 100.000 000 MHz

**Calibration Laboratory of
Schmid & Partner
Engineering AG**
Zeughausstrasse 43, 8004 Zurich, Switzerland



S Schweizerischer Kalibrierdienst
S Service suisse d'étalonnage
C Servizio svizzero di taratura
S Swiss Calibration Service

Accredited by the Swiss Accreditation Service (SAS)
The Swiss Accreditation Service is one of the signatories to the EA
Multilateral Agreement for the recognition of calibration certificates

Accreditation No.: **SCS 108**

Client **Sporton-CN (Auden)**

Certificate No: **D1900V2-5d118_Nov11**

CALIBRATION CERTIFICATE

Object: **D1900V2 - SN: 5d118**

Calibration procedure(s): **QA CAL-05.v8
Calibration procedure for dipole validation kits above 700 MHz**

Calibration date: **November 21, 2011**

This calibration certificate documents the traceability to national standards, which realize the physical units of measurements (SI).
The measurements and the uncertainties with confidence probability are given on the following pages and are part of the certificate.

All calibrations have been conducted in the closed laboratory facility: environment temperature (22 ± 3)°C and humidity < 70%.

Calibration Equipment used (M&TE critical for calibration)

Primary Standards	ID #	Cal Date (Certificate No.)	Scheduled Calibration
Power meter EPM-442A	GB37480704	05-Oct-11 (No. 217-01451)	Oct-12
Power sensor HP 8481A	US37292783	05-Oct-11 (No. 217-01451)	Oct-12
Reference 20 dB Attenuator	SN: 5086 (20g)	29-Mar-11 (No. 217-01368)	Apr-12
Type-N mismatch combination	SN: 5047.2 / 06327	29-Mar-11 (No. 217-01371)	Apr-12
Reference Probe ES3DV3	SN: 3205	29-Apr-11 (No. ES3-3205_Apr11)	Apr-12
DAE4	SN: 601	04-Jul-11 (No. DAE4-601_Jul11)	Jul-12
Secondary Standards	ID #	Check Date (in house)	Scheduled Check
Power sensor HP 8481A	MY41092317	18-Oct-02 (in house check Oct-11)	In house check: Oct-13
RF generator R&S SMT-06	100005	04-Aug-99 (in house check Oct-11)	In house check: Oct-13
Network Analyzer HP 8753E	US37390585 S4206	18-Oct-01 (in house check Oct-11)	In house check: Oct-12

	Name	Function	Signature
Calibrated by:	Dimce Iliev	Laboratory Technician	
Approved by:	Katja Pokovic	Technical Manager	

Issued: November 21, 2011

This calibration certificate shall not be reproduced except in full without written approval of the laboratory.

**Calibration Laboratory of
Schmid & Partner
Engineering AG**
Zeughausstrasse 43, 8004 Zurich, Switzerland



S Schweizerischer Kalibrierdienst
C Service suisse d'étalonnage
S Servizio svizzero di taratura
S Swiss Calibration Service

Accredited by the Swiss Accreditation Service (SAS)

The Swiss Accreditation Service is one of the signatories to the EA
Multilateral Agreement for the recognition of calibration certificates

Accreditation No.: **SCS 108**

Glossary:

TSL	tissue simulating liquid
ConvF	sensitivity in TSL / NORM x,y,z
N/A	not applicable or not measured

Calibration is Performed According to the Following Standards:

- IEEE Std 1528-2003, "IEEE Recommended Practice for Determining the Peak Spatial-Averaged Specific Absorption Rate (SAR) in the Human Head from Wireless Communications Devices: Measurement Techniques", December 2003
- IEC 62209-1, "Procedure to measure the Specific Absorption Rate (SAR) for hand-held devices used in close proximity to the ear (frequency range of 300 MHz to 3 GHz)", February 2005
- Federal Communications Commission Office of Engineering & Technology (FCC OET), "Evaluating Compliance with FCC Guidelines for Human Exposure to Radiofrequency Electromagnetic Fields; Additional Information for Evaluating Compliance of Mobile and Portable Devices with FCC Limits for Human Exposure to Radiofrequency Emissions", Supplement C (Edition 01-01) to Bulletin 65

Additional Documentation:

- DASY4/5 System Handbook

Methods Applied and Interpretation of Parameters:

- Measurement Conditions:** Further details are available from the Validation Report at the end of the certificate. All figures stated in the certificate are valid at the frequency indicated.
- Antenna Parameters with TSL:** The dipole is mounted with the spacer to position its feed point exactly below the center marking of the flat phantom section, with the arms oriented parallel to the body axis.
- Feed Point Impedance and Return Loss:** These parameters are measured with the dipole positioned under the liquid filled phantom. The impedance stated is transformed from the measurement at the SMA connector to the feed point. The Return Loss ensures low reflected power. No uncertainty required.
- Electrical Delay:** One-way delay between the SMA connector and the antenna feed point. No uncertainty required.
- SAR measured:** SAR measured at the stated antenna input power.
- SAR normalized:** SAR as measured, normalized to an input power of 1 W at the antenna connector.
- SAR for nominal TSL parameters:** The measured TSL parameters are used to calculate the nominal SAR result.

Measurement Conditions

DASY system configuration, as far as not given on page 1.

DASY Version	DASY5	V52.6.2
Extrapolation	Advanced Extrapolation	
Phantom	Modular Flat Phantom	
Distance Dipole Center - TSL	10 mm	with Spacer
Zoom Scan Resolution	dx, dy, dz = 5 mm	
Frequency	1900 MHz \pm 1 MHz	

Head TSL parameters

The following parameters and calculations were applied.

	Temperature	Permittivity	Conductivity
Nominal Head TSL parameters	22.0 °C	40.0	1.40 mho/m
Measured Head TSL parameters	(22.0 \pm 0.2) °C	39.5 \pm 6 %	1.42 mho/m \pm 6 %
Head TSL temperature change during test	< 0.5 °C	----	----

SAR result with Head TSL

SAR averaged over 1 cm³ (1 g) of Head TSL	Condition	
SAR measured	250 mW input power	10.2 mW / g
SAR for nominal Head TSL parameters	normalized to 1W	40.3 mW / g \pm 17.0 % (k=2)

SAR averaged over 10 cm³ (10 g) of Head TSL	condition	
SAR measured	250 mW input power	5.29 mW / g
SAR for nominal Head TSL parameters	normalized to 1W	21.0 mW / g \pm 16.5 % (k=2)

Body TSL parameters

The following parameters and calculations were applied.

	Temperature	Permittivity	Conductivity
Nominal Body TSL parameters	22.0 °C	53.3	1.52 mho/m
Measured Body TSL parameters	(22.0 \pm 0.2) °C	54.2 \pm 6 %	1.59 mho/m \pm 6 %
Body TSL temperature change during test	< 0.5 °C	----	----

SAR result with Body TSL

SAR averaged over 1 cm³ (1 g) of Body TSL	Condition	
SAR measured	250 mW input power	10.7 mW / g
SAR for nominal Body TSL parameters	normalized to 1W	41.8 mW / g \pm 17.0 % (k=2)

SAR averaged over 10 cm³ (10 g) of Body TSL	condition	
SAR measured	250 mW input power	5.59 mW / g
SAR for nominal Body TSL parameters	normalized to 1W	22.0 mW / g \pm 16.5 % (k=2)

Appendix

Antenna Parameters with Head TSL

Impedance, transformed to feed point	53.4 Ω + 6.9 j Ω
Return Loss	- 22.5 dB

Antenna Parameters with Body TSL

Impedance, transformed to feed point	47.8 Ω + 7.1 j Ω
Return Loss	- 22.4 dB

General Antenna Parameters and Design

Electrical Delay (one direction)	1.200 ns
----------------------------------	----------

After long term use with 100W radiated power, only a slight warming of the dipole near the feedpoint can be measured.

The dipole is made of standard semirigid coaxial cable. The center conductor of the feeding line is directly connected to the second arm of the dipole. The antenna is therefore short-circuited for DC-signals.

No excessive force must be applied to the dipole arms, because they might bend or the soldered connections near the feedpoint may be damaged.

Additional EUT Data

Manufactured by	SPEAG
Manufactured on	August 21, 2009

DASY5 Validation Report for Head TSL

Date: 21.11.2011

Test Laboratory: SPEAG, Zurich, Switzerland

DUT: Dipole 1900 MHz; Type: D1900V2; Serial: D1900V2 - SN: 5d118

Communication System: CW; Frequency: 1900 MHz

Medium parameters used: $f = 1900$ MHz; $\sigma = 1.42$ mho/m; $\epsilon_r = 39.5$; $\rho = 1000$ kg/m³

Phantom section: Flat Section

Measurement Standard: DASY5 (IEEE/IEC/ANSI C63.19-2007)

DASY52 Configuration:

- Probe: ES3DV3 - SN3205; ConvF(5.01, 5.01, 5.01); Calibrated: 29.04.2011
- Sensor-Surface: 3mm (Mechanical Surface Detection)
- Electronics: DAE4 Sn601; Calibrated: 04.07.2011
- Phantom: Flat Phantom 5.0 (front); Type: QD000P50AA; Serial: 1001
- DASY52 52.6.2(482); SEMCAD X 14.4.5(3634)

Dipole Calibration for Head Tissue/Pin=250 mW, d=10mm/Zoom Scan (7x7x7)/Cube 0:

Measurement grid: dx=5mm, dy=5mm, dz=5mm

Reference Value = 98.061 V/m; Power Drift = 0.04 dB

Peak SAR (extrapolated) = 18.620 W/kg

SAR(1 g) = 10.2 mW/g; SAR(10 g) = 5.29 mW/g

Maximum value of SAR (measured) = 12.702 mW/g

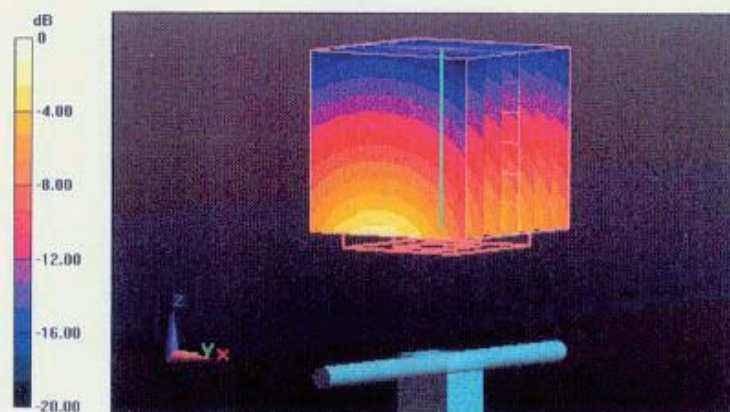

0 dB = 12.700mW/g

Impedance Measurement Plot for Head TSL

21 Nov 2011 11:13:15

CHI S11 1 U F8

Z: 53.449 Ω 6.9277 Ω 588.31 pF 1 900.000 000 MHz

*

Del

Cor

Avg
16

H1d

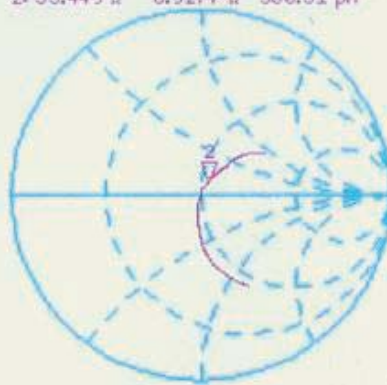

CH2 S11 LOG 5 dB/REF -20 dB Z: -22.535 dB 1 900.000 000 MHz

Cor

Avg
16

H1d

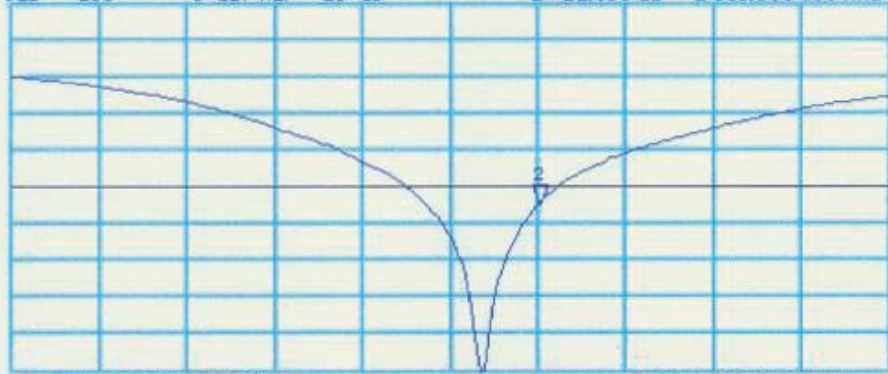

DASY5 Validation Report for Body TSL

Date: 21.11.2011

Test Laboratory: SPEAG, Zurich, Switzerland

DUT: Dipole 1900 MHz; Type: D1900V2; Serial: D1900V2 - SN: 5d118

Communication System: CW; Frequency: 1900 MHz

Medium parameters used: $f = 1900$ MHz; $\sigma = 1.59$ mho/m; $\epsilon_r = 54.2$; $\rho = 1000$ kg/m³

Phantom section: Flat Section

Measurement Standard: DASY5 (IEEE/IEC/ANSI C63.19-2007)

DASY52 Configuration:

- Probe: ES3DV3 - SN3205; ConvF(4.62, 4.62, 4.62); Calibrated: 29.04.2011
- Sensor-Surface: 3mm (Mechanical Surface Detection)
- Electronics: DAE4 Sn601; Calibrated: 04.07.2011
- Phantom: Flat Phantom 5.0 (back); Type: QD000P50AA; Serial: 1002
- DASY52 52.6.2(482); SEMCAD X 14.4.5(3634)

Dipole Calibration for Body Tissue/Pin=250 mW, d=10mm/Zoom Scan (7x7x7)/Cube 0:

Measurement grid: dx=5mm, dy=5mm, dz=5mm

Reference Value = 96.110 V/m; Power Drift = -0.01 dB

Peak SAR (extrapolated) = 18.910 W/kg

SAR(1 g) = 10.7 mW/g; SAR(10 g) = 5.59 mW/g

Maximum value of SAR (measured) = 13.549 mW/g

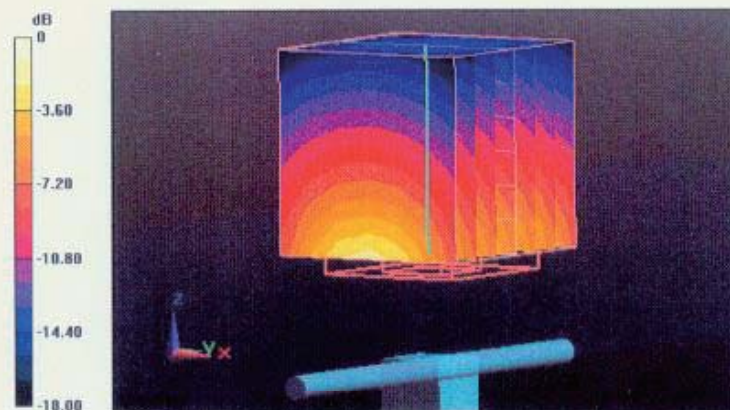

0 dB = 13.550mW/g

Impedance Measurement Plot for Body TSL

21 Nov 2011 11:14:07

CH1 S11 1 U FS 2: 47.820 Ω 7.1133 Ω 595.85 μH 1 900.000 000 MHz

*
De1
Cor

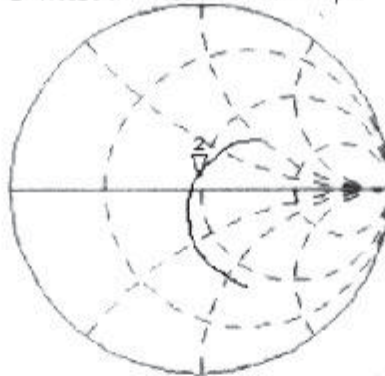

Avg
15

H1 d

CH2 S11 L00 5 dB/REF -20 dB 2:-22.401 dB 1 900.000 000 MHz

Cor

Avg
15

H1 d

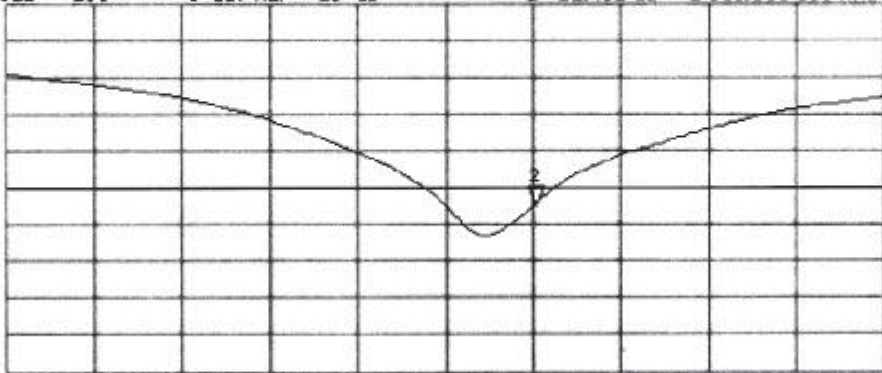

START 1 1500.000 000 MHz

STOP 2 2100.000 000 MHz

IMPORTANT NOTICE

USAGE OF THE DAE 4

The DAE unit is a delicate, high precision instrument and requires careful treatment by the user. There are no serviceable parts inside the DAE. Special attention shall be given to the following points:

Battery Exchange: The battery cover of the DAE4 unit is closed using a screw, over tightening the screw may cause the threads inside the DAE to wear out.

Shipping of the DAE: Before shipping the DAE to SPEAG for calibration, remove the batteries and pack the DAE in an antistatic bag. This antistatic bag shall then be packed into a larger box or container which protects the DAE from impacts during transportation. The package shall be marked to indicate that a fragile instrument is inside.

E-Stop Failures: Touch detection may be malfunctioning due to broken magnets in the E-stop. Rough handling of the E-stop may lead to damage of these magnets. Touch and collision errors are often caused by dust and dirt accumulated in the E-stop. To prevent E-stop failure, the customer shall always mount the probe to the DAE carefully and keep the DAE unit in a non-dusty environment if not used for measurements.

Repair: Minor repairs are performed at no extra cost during the annual calibration. However, SPEAG reserves the right to charge for any repair especially if rough unprofessional handling caused the defect.

DASY Configuration Files: Since the exact values of the DAE input resistances, as measured during the calibration procedure of a DAE unit, are not used by the DASY software, a nominal value of 200 MOhm is given in the corresponding configuration file.

Important Note:

Warranty and calibration is void if the DAE unit is disassembled partly or fully by the Customer.

Important Note:

Never attempt to grease or oil the E-stop assembly. Cleaning and readjusting of the E-stop assembly is allowed by certified SPEAG personnel only and is part of the annual calibration procedure.

Important Note:

To prevent damage of the DAE probe connector pins, use great care when installing the probe to the DAE. Carefully connect the probe with the connector notch oriented in the mating position. Avoid any rotational movement of the probe body versus the DAE while turning the locking nut of the connector. The same care shall be used when disconnecting the probe from the DAE.



Accredited by the Swiss Accreditation Service (SAS)
The Swiss Accreditation Service is one of the signatories to the EA
Multilateral Agreement for the recognition of calibration certificates

Accreditation No.: SCS 108

Client Sporton (Auden)

Certificate No: DAE4-1303_Nov11

CALIBRATION CERTIFICATE

Object: DAE4 - SD 000 D04 BJ - SN: 1303

Calibration procedure(s): QA CAL-06.v23
Calibration procedure for the data acquisition electronics (DAE)

Calibration date: November 10, 2011

This calibration certificate documents the traceability to national standards, which realize the physical units of measurements (SI).
The measurements and the uncertainties with confidence probability are given on the following pages and are part of the certificate.

All calibrations have been conducted in the closed laboratory facility: environment temperature (22 ± 3)°C and humidity < 70%.

Calibration Equipment used (M&TE critical for calibration)

Primary Standards	ID #	Cal Date (Certificate No.)	Scheduled Calibration
Keithley Multimeter Type 2001	SN: 0810278	28-Sep-11 (No:11450)	Sep-12
Secondary Standards	ID #	Check Date (in house)	Scheduled Check
Calibrator Box V1.1	SE UMS 006 AB 1004	08-Jun-11 (in house check)	In house check: Jun-12

Calibrated by:	Name Andrea Guntli	Function Technician	Signature
Approved by:	Fin Bomholt	R&D Director	

Issued: November 10, 2011

This calibration certificate shall not be reproduced except in full without written approval of the laboratory.



Accredited by the Swiss Accreditation Service (SAS)
The Swiss Accreditation Service is one of the signatories to the EA
Multilateral Agreement for the recognition of calibration certificates

Accreditation No.: **SCS 108**

Glossary

DAE data acquisition electronics
Connector angle information used in DASY system to align probe sensor X to the robot coordinate system.

Methods Applied and Interpretation of Parameters

- *DC Voltage Measurement:* Calibration Factor assessed for use in DASY system by comparison with a calibrated instrument traceable to national standards. The figure given corresponds to the full scale range of the voltmeter in the respective range.
- *Connector angle:* The angle of the connector is assessed measuring the angle mechanically by a tool inserted. Uncertainty is not required.
- The following parameters as documented in the Appendix contain technical information as a result from the performance test and require no uncertainty.
 - *DC Voltage Measurement Linearity:* Verification of the Linearity at +10% and -10% of the nominal calibration voltage. Influence of offset voltage is included in this measurement.
 - *Common mode sensitivity:* Influence of a positive or negative common mode voltage on the differential measurement.
 - *Channel separation:* Influence of a voltage on the neighbor channels not subject to an input voltage.
 - *AD Converter Values with inputs shorted:* Values on the internal AD converter corresponding to zero input voltage
 - *Input Offset Measurement:* Output voltage and statistical results over a large number of zero voltage measurements.
 - *Input Offset Current:* Typical value for information; Maximum channel input offset current, not considering the input resistance.
 - *Input resistance:* Typical value for information: DAE input resistance at the connector, during internal auto-zeroing and during measurement.
 - *Low Battery Alarm Voltage:* Typical value for information. Below this voltage, a battery alarm signal is generated.
 - *Power consumption:* Typical value for information. Supply currents in various operating modes.

DC Voltage Measurement

A/D - Converter Resolution nominal

High Range: 1LSB = 6.1 μ V, full range = -100...+300 mV

Low Range: 1LSB = 61nV, full range = -1.....+3mV

DASY measurement parameters: Auto Zero Time: 3 sec; Measuring time: 3 sec

Calibration Factors	X	Y	Z
High Range	405.540 \pm 0.1% (k=2)	403.440 \pm 0.1% (k=2)	404.880 \pm 0.1% (k=2)
Low Range	3.96478 \pm 0.7% (k=2)	3.99094 \pm 0.7% (k=2)	3.98659 \pm 0.7% (k=2)

Connector Angle

Connector Angle to be used in DASY system	98.0 $^{\circ}$ \pm 1 $^{\circ}$
---	------------------------------------

Appendix

1. DC Voltage Linearity

High Range	Reading (μV)	Difference (μV)	Error (%)
Channel X + Input	199991.5	0.55	0.00
Channel X + Input	20001.05	1.85	0.01
Channel X - Input	-19998.05	1.05	-0.01
Channel Y + Input	199999.7	1.22	0.00
Channel Y + Input	19998.99	-1.81	-0.01
Channel Y - Input	-19999.45	-0.05	0.00
Channel Z + Input	199999.8	2.58	0.00
Channel Z + Input	19998.62	-2.08	-0.01
Channel Z - Input	-20000.66	-1.46	0.01

Low Range	Reading (μV)	Difference (μV)	Error (%)
Channel X + Input	2000.2	0.42	0.02
Channel X + Input	200.40	0.50	0.25
Channel X - Input	-199.78	0.12	-0.06
Channel Y + Input	2000.2	0.14	0.01
Channel Y + Input	199.51	-0.59	-0.29
Channel Y - Input	-200.62	-0.72	0.36
Channel Z + Input	1999.8	-0.34	-0.02
Channel Z + Input	199.52	-0.38	-0.19
Channel Z - Input	-201.03	-1.03	0.51

2. Common mode sensitivity

DASY measurement parameters: Auto Zero Time: 3 sec; Measuring time: 3 sec

	Common mode Input Voltage (mV)	High Range Average Reading (μV)	Low Range Average Reading (μV)
Channel X	200	8.61	7.05
	- 200	-5.72	-7.64
Channel Y	200	5.57	5.59
	- 200	-7.50	-7.56
Channel Z	200	-3.76	-4.32
	- 200	1.32	1.78

3. Channel separation

DASY measurement parameters: Auto Zero Time: 3 sec; Measuring time: 3 sec

	Input Voltage (mV)	Channel X (μV)	Channel Y (μV)	Channel Z (μV)
Channel X	200	-	3.28	-0.13
Channel Y	200	2.85	-	4.47
Channel Z	200	1.85	-0.35	-

4. AD-Converter Values with inputs shorted

DASY measurement parameters: Auto Zero Time: 3 sec; Measuring time: 3 sec

	High Range (LSB)	Low Range (LSB)
Channel X	15918	16080
Channel Y	15626	16237
Channel Z	16154	16086

5. Input Offset Measurement

DASY measurement parameters: Auto Zero Time: 3 sec; Measuring time: 3 sec
Input 10M Ω

	Average (μ V)	min. Offset (μ V)	max. Offset (μ V)	Std. Deviation (μ V)
Channel X	-0.19	-0.92	0.71	0.28
Channel Y	-1.87	-3.04	0.07	0.39
Channel Z	-0.56	-1.71	1.44	0.58

6. Input Offset Current

Nominal Input circuitry offset current on all channels: <25fA

7. Input Resistance (Typical values for information)

	Zeroing (kOhm)	Measuring (MOhm)
Channel X	200	200
Channel Y	200	200
Channel Z	200	200

8. Low Battery Alarm Voltage (Typical values for information)

Typical values	Alarm Level (VDC)
Supply (+ Vcc)	+7.9
Supply (- Vcc)	-7.6

9. Power Consumption (Typical values for information)

Typical values	Switched off (mA)	Stand by (mA)	Transmitting (mA)
Supply (+ Vcc)	+0.01	+6	+14
Supply (- Vcc)	-0.01	-8	-9



Accredited by the Swiss Accreditation Service (SAS)

Accreditation No.: **SCS 108**

The Swiss Accreditation Service is one of the signatories to the EA
Multilateral Agreement for the recognition of calibration certificates

Client **Sporton (Auden)**

Certificate No: **EX3-3819_Nov11**

CALIBRATION CERTIFICATE

Object **EX3DV4 - SN:3819**

Calibration procedure(s) **QA CAL-01.v8, QA CAL-14.v3, QA CAL-23.v4, QA CAL-25.v4
Calibration procedure for dosimetric E-field probes**

Calibration date: **November 16, 2011**

This calibration certificate documents the traceability to national standards, which realize the physical units of measurements (SI).
The measurements and the uncertainties with confidence probability are given on the following pages and are part of the certificate.

All calibrations have been conducted in the closed laboratory facility: environment temperature (22 ± 3)°C and humidity < 70%.

Calibration Equipment used (M&TE critical for calibration)

Primary Standards	ID	Cal Date (Certificate No.)	Scheduled Calibration
Power meter E4419B	GB41293874	31-Mar-11 (No. 217-01372)	Apr-12
Power sensor E4412A	MY41498087	31-Mar-11 (No. 217-01372)	Apr-12
Reference 3 dB Attenuator	SN: S5054 (3c)	29-Mar-11 (No. 217-01369)	Apr-12
Reference 20 dB Attenuator	SN: S5086 (20b)	29-Mar-11 (No. 217-01367)	Apr-12
Reference 30 dB Attenuator	SN: S5129 (30b)	29-Mar-11 (No. 217-01370)	Apr-12
Reference Probe ES3DV2	SN: 3013	29-Dec-10 (No. ES3-3013_Dec10)	Dec-11
DAE4	SN: 654	3-May-11 (No. DAE4-654_May11)	May-12
Secondary Standards	ID	Check Date (in house)	Scheduled Check
RF generator HP 8648C	US3642U01700	4-Aug-99 (in house check Apr-11)	In house check: Apr-13
Network Analyzer HP 8753E	US37390585	18-Oct-01 (in house check Oct-11)	In house check: Oct-12

	Name	Function	Signature
Calibrated by:	Jeton Kastrati	Laboratory Technician	
Approved by:	Katja Pokovic	Technical Manager	

Issued: November 16, 2011

This calibration certificate shall not be reproduced except in full without written approval of the laboratory.



Accredited by the Swiss Accreditation Service (SAS)

Accreditation No.: SCS 108

The Swiss Accreditation Service is one of the signatories to the EA
Multilateral Agreement for the recognition of calibration certificates

Glossary:

TSL	tissue simulating liquid
NORM _{x,y,z}	sensitivity in free space
ConvF	sensitivity in TSL / NORM _{x,y,z}
DCP	diode compression point
CF	crest factor (1/duty_cycle) of the RF signal
A, B, C	modulation dependent linearization parameters
Polarization φ	φ rotation around probe axis
Polarization ϑ	ϑ rotation around an axis that is in the plane normal to probe axis (at measurement center), i.e., $\vartheta = 0$ is normal to probe axis

Calibration is Performed According to the Following Standards:

- IEEE Std 1528-2003, "IEEE Recommended Practice for Determining the Peak Spatial-Averaged Specific Absorption Rate (SAR) in the Human Head from Wireless Communications Devices: Measurement Techniques", December 2003
- IEC 62209-1, "Procedure to measure the Specific Absorption Rate (SAR) for hand-held devices used in close proximity to the ear (frequency range of 300 MHz to 3 GHz)", February 2005

Methods Applied and Interpretation of Parameters:

- NORM_{x,y,z}:** Assessed for E-field polarization $\vartheta = 0$ ($f \leq 900$ MHz in TEM-cell; $f > 1800$ MHz: R22 waveguide). NORM_{x,y,z} are only intermediate values, i.e., the uncertainties of NORM_{x,y,z} does not affect the E²-field uncertainty inside TSL (see below ConvF).
- NORM(f)_{x,y,z} = NORM_{x,y,z} * frequency_response** (see Frequency Response Chart). This linearization is implemented in DASY4 software versions later than 4.2. The uncertainty of the frequency response is included in the stated uncertainty of ConvF.
- DCP_{x,y,z}:** DCP are numerical linearization parameters assessed based on the data of power sweep with CW signal (no uncertainty required). DCP does not depend on frequency nor media.
- PAR:** PAR is the Peak to Average Ratio that is not calibrated but determined based on the signal characteristics
- A_{x,y,z}; B_{x,y,z}; C_{x,y,z}; VR_{x,y,z}:** A, B, C are numerical linearization parameters assessed based on the data of power sweep for specific modulation signal. The parameters do not depend on frequency nor media. VR is the maximum calibration range expressed in RMS voltage across the diode.
- ConvF and Boundary Effect Parameters:** Assessed in flat phantom using E-field (or Temperature Transfer Standard for $f \leq 800$ MHz) and inside waveguide using analytical field distributions based on power measurements for $f > 800$ MHz. The same setups are used for assessment of the parameters applied for boundary compensation (alpha, depth) of which typical uncertainty values are given. These parameters are used in DASY4 software to improve probe accuracy close to the boundary. The sensitivity in TSL corresponds to NORM_{x,y,z} * ConvF whereby the uncertainty corresponds to that given for ConvF. A frequency dependent ConvF is used in DASY version 4.4 and higher which allows extending the validity from ± 50 MHz to ± 100 MHz.
- Spherical isotropy (3D deviation from isotropy):** in a field of low gradients realized using a flat phantom exposed by a patch antenna.
- Sensor Offset:** The sensor offset corresponds to the offset of virtual measurement center from the probe tip (on probe axis). No tolerance required.

Probe EX3DV4

SN:3819

Manufactured: September 2, 2011
Calibrated: November 16, 2011

Calibrated for DASY/EASY Systems
(Note: non-compatible with DASY2 system!)

DASY/EASY - Parameters of Probe: EX3DV4 - SN:3819

Basic Calibration Parameters

	Sensor X	Sensor Y	Sensor Z	Unc (k=2)
Norm ($\mu\text{V}/(\text{V}/\text{m})^2$) ^A	0.49	0.37	0.52	± 10.1 %
DCP (mV) ^B	100.1	104.6	99.8	

Modulation Calibration Parameters

UID	Communication System Name	PAR		A dB	B dB	C dB	VR mV	Unc ^E (k=2)
10000	CW	0.00	X	0.00	0.00	1.00	114.7	±3.0 %
			Y	0.00	0.00	1.00	98.7	
			Z	0.00	0.00	1.00	114.5	

The reported uncertainty of measurement is stated as the standard uncertainty of measurement multiplied by the coverage factor k=2, which for a normal distribution corresponds to a coverage probability of approximately 95%.

^A The uncertainties of NormX,Y,Z do not affect the E²-field uncertainty inside TSL (see Pages 5 and 6).

^B Numerical linearization parameter: uncertainty not required.

^E Uncertainty is determined using the max. deviation from linear response applying rectangular distribution and is expressed for the square of the field value.

DASY/EASY - Parameters of Probe: EX3DV4 - SN:3819

Calibration Parameter Determined in Head Tissue Simulating Media

f (MHz) ^C	Relative Permittivity ^F	Conductivity (S/m) ^F	ConvF X	ConvF Y	ConvF Z	Alpha	Depth (mm)	Unct. (k=2)
750	41.9	0.89	9.82	9.82	9.82	0.75	0.68	± 12.0 %
835	41.5	0.90	9.40	9.40	9.40	0.70	0.72	± 12.0 %
900	41.5	0.97	9.32	9.32	9.32	0.80	0.63	± 12.0 %
1750	40.1	1.37	8.69	8.69	8.69	0.74	0.64	± 12.0 %
1900	40.0	1.40	8.36	8.36	8.36	0.80	0.60	± 12.0 %
2000	40.0	1.40	8.26	8.26	8.26	0.80	0.59	± 12.0 %
2450	39.2	1.80	7.33	7.33	7.33	0.80	0.57	± 12.0 %
2600	39.0	1.96	7.33	7.33	7.33	0.77	0.61	± 12.0 %
5200	36.0	4.66	5.07	5.07	5.07	0.40	1.80	± 13.1 %
5300	35.9	4.76	4.71	4.71	4.71	0.42	1.80	± 13.1 %
5500	35.6	4.96	4.74	4.74	4.74	0.42	1.80	± 13.1 %
5800	35.3	5.27	4.47	4.47	4.47	0.45	1.80	± 13.1 %

^C Frequency validity of ± 100 MHz only applies for DASY v4.4 and higher (see Page 2), else it is restricted to ± 50 MHz. The uncertainty is the RSS of the ConvF uncertainty at calibration frequency and the uncertainty for the indicated frequency band.

^F At frequencies below 3 GHz, the validity of tissue parameters (ϵ and σ) can be relaxed to ± 10% if liquid compensation formula is applied to measured SAR values. At frequencies above 3 GHz, the validity of tissue parameters (ϵ and σ) is restricted to ± 5%. The uncertainty is the RSS of the ConvF uncertainty for indicated target tissue parameters.

DASY/EASY - Parameters of Probe: EX3DV4 - SN:3819

Calibration Parameter Determined in Body Tissue Simulating Media

f (MHz) ^C	Relative Permittivity ^F	Conductivity (S/m) ^F	ConvF X	ConvF Y	ConvF Z	Alpha	Depth (mm)	Unct. (k=2)
750	55.5	0.96	9.81	9.81	9.81	0.78	0.66	± 12.0 %
835	55.2	0.97	9.72	9.72	9.72	0.80	0.66	± 12.0 %
900	55.0	1.05	9.43	9.43	9.43	0.67	0.73	± 12.0 %
1750	53.4	1.49	8.00	8.00	8.00	0.80	0.59	± 12.0 %
1900	53.3	1.52	7.71	7.71	7.71	0.80	0.58	± 12.0 %
2000	53.3	1.52	7.93	7.93	7.93	0.65	0.66	± 12.0 %
2450	52.7	1.95	7.40	7.40	7.40	0.80	0.50	± 12.0 %
2600	52.5	2.16	7.26	7.26	7.26	0.77	0.57	± 12.0 %
5200	49.0	5.30	4.48	4.48	4.48	0.50	1.90	± 13.1 %
5300	48.9	5.42	4.24	4.24	4.24	0.52	1.90	± 13.1 %
5500	48.6	5.65	3.90	3.90	3.90	0.55	1.90	± 13.1 %
5800	48.2	6.00	4.02	4.02	4.02	0.60	1.90	± 13.1 %

^C Frequency validity of ± 100 MHz only applies for DASY v4.4 and higher (see Page 2), else it is restricted to ± 50 MHz. The uncertainty is the RSS of the ConvF uncertainty at calibration frequency and the uncertainty for the indicated frequency band.

^F At frequencies below 3 GHz, the validity of tissue parameters (ϵ and σ) can be relaxed to ± 10% if liquid compensation formula is applied to measured SAR values. At frequencies above 3 GHz, the validity of tissue parameters (ϵ and σ) is restricted to ± 5%. The uncertainty is the RSS of the ConvF uncertainty for indicated target tissue parameters.

Frequency Response of E-Field

(TEM-Cell: ifi110 EXX, Waveguide: R22)

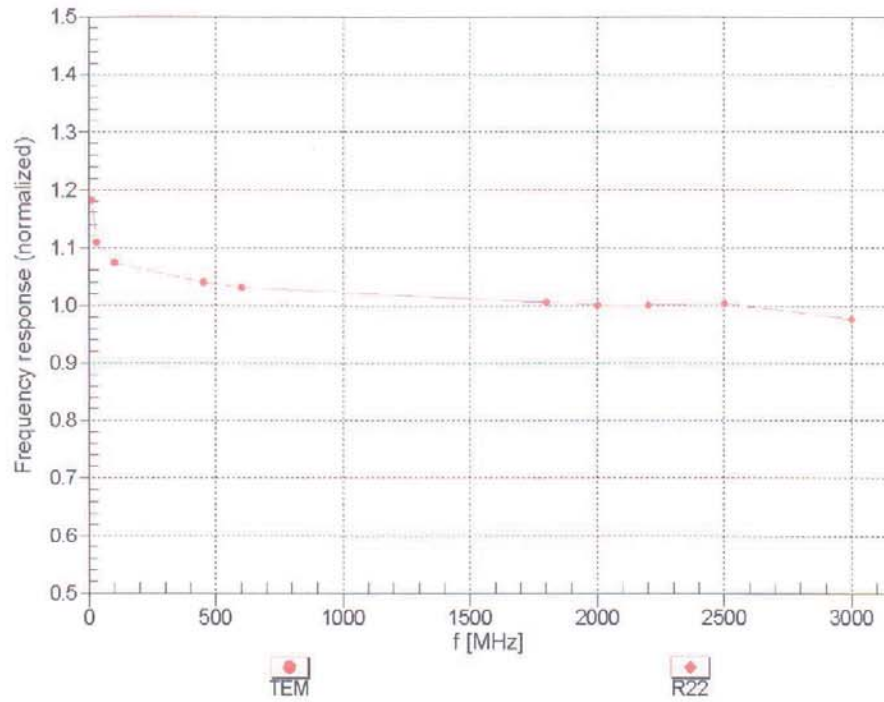

Uncertainty of Frequency Response of E-field: $\pm 6.3\%$ ($k=2$)

Receiving Pattern (ϕ), $\vartheta = 0^\circ$

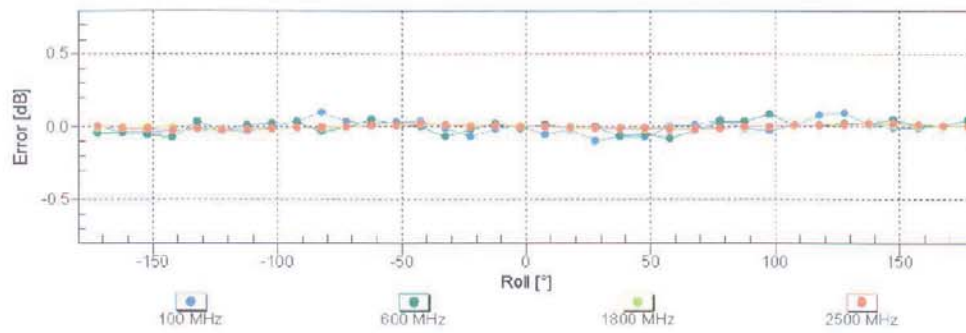
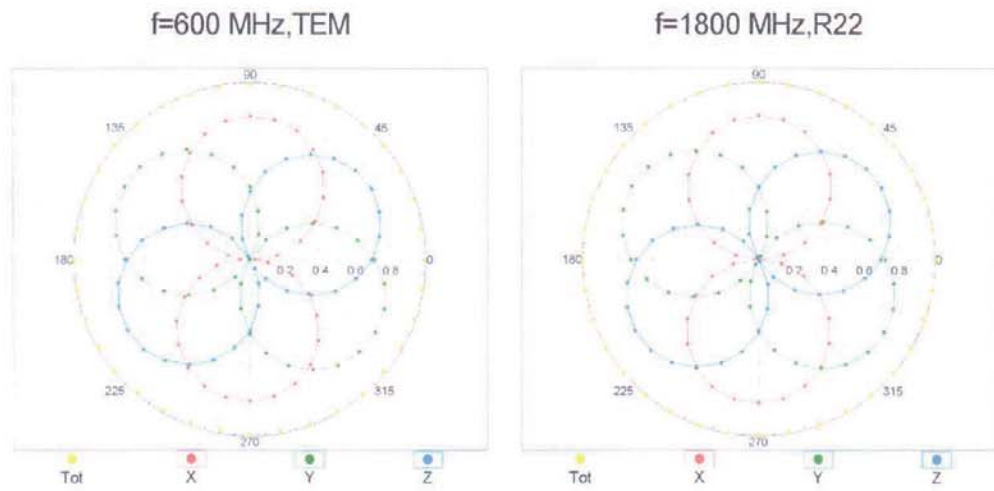

Uncertainty of Axial Isotropy Assessment: $\pm 0.5\%$ ($k=2$)

Dynamic Range f(SAR_{head}) (TEM cell , f = 900 MHz)

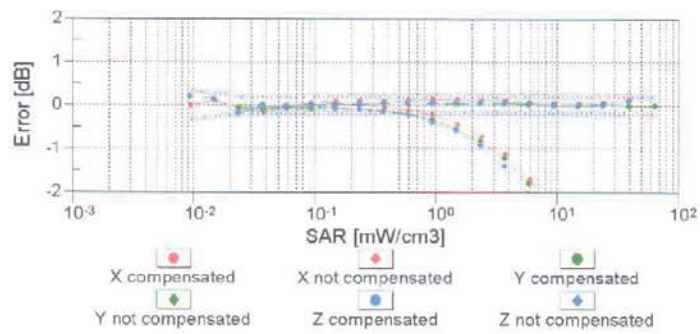
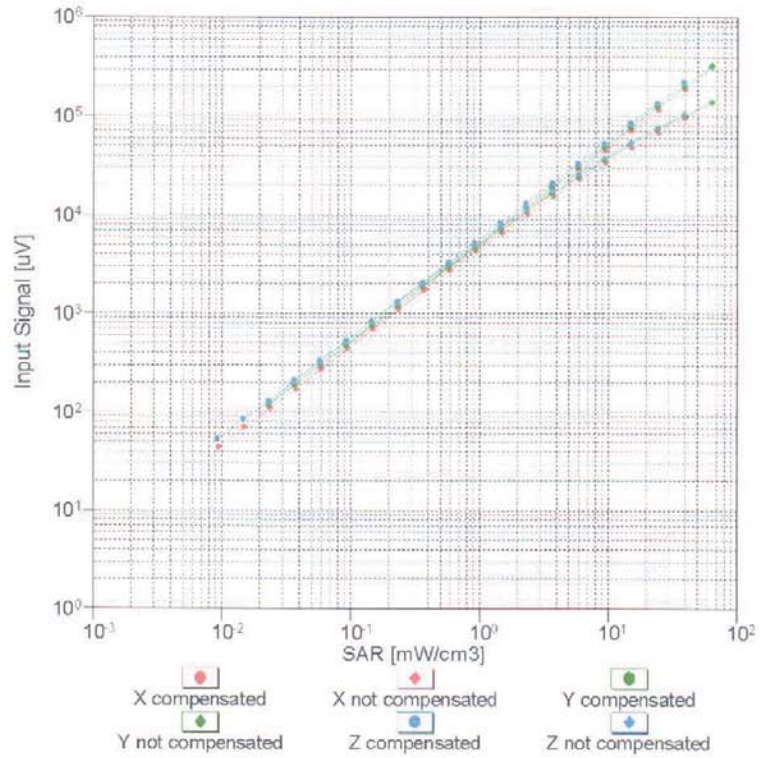

Uncertainty of Linearity Assessment: ± 0.6% (k=2)

Conversion Factor Assessment

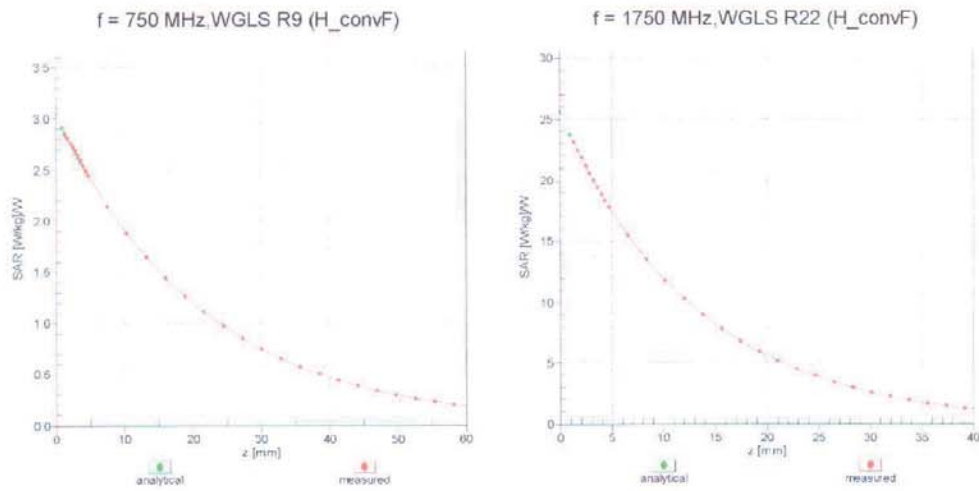

Deviation from Isotropy in Liquid

Error (ϕ, ϑ), f = 900 MHz

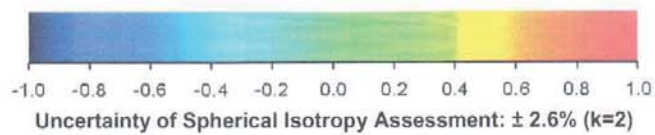
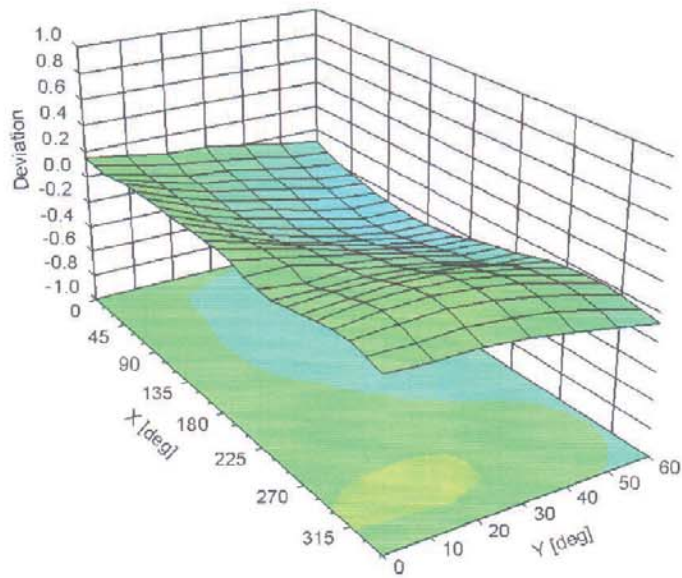

DASY/EASY - Parameters of Probe: EX3DV4 - SN:3819

Other Probe Parameters

Sensor Arrangement	Triangular
Connector Angle (°)	Not applicable
Mechanical Surface Detection Mode	enabled
Optical Surface Detection Mode	disabled
Probe Overall Length	337 mm
Probe Body Diameter	10 mm
Tip Length	9 mm
Tip Diameter	2.5 mm
Probe Tip to Sensor X Calibration Point	1 mm
Probe Tip to Sensor Y Calibration Point	1 mm
Probe Tip to Sensor Z Calibration Point	1 mm
Recommended Measurement Distance from Surface	2 mm