



FCC CFR 47 Part 90.219 Test Report

APPLICANT	FIPLEX COMMUNICATIONS INC.
ADDRESS	2101 NW 79th Ave. MIAMI FL 33122 USA
FCC ID	P3TDHS37
MODEL NUMBER	DHS37
PRODUCT DESCRIPTION	800 MHZ DUAL BAND INDUSTRIAL BOOSTER
DATE SAMPLE RECEIVED	07/15/2019
FINAL TEST DATE	07/30/2019
TESTED BY	Franklin Rose
APPROVED BY	Tim Royer
TEST RESULTS	<input checked="" type="checkbox"/> PASS <input type="checkbox"/> FAIL

Report Number	Report Version	Description	Issue Date
1802AUT19TestReport_	Rev1	Initial Issue	07/30/2019

THE ATTACHED REPORT SHALL NOT BE REPRODUCED EXCEPT IN FULL WITHOUT THE WRITTEN APPROVAL OF TIMCO ENGINEERING, INC.



TABLE OF CONTENTS

GENERAL REMARKS	2
GENERAL INFORMATION	3
SUMMARY OF RESULTS	4
EMISSION DESIGNATION	5
TEST FREQUENCIES	6
INPUT SIGNALS	7
4K00F3E (NARROWBAND ANALOG FM VOICE)	8
8K10F1E/F1D (P25 PHASE I C4FM VOICE, DATA)	9
8K10F1W (P25 PHASE II H-CPM VOICE & DATA)	10
9K80F1E/F1D (P25 PHASE II H-DQPSK VOICE, DATA)	11
11K3F3E (NARROWBAND ANALOG FM VOICE)	12
16K0F3E (WIDEBAND ANALOG FM VOICE)	13
AWGN SIGNAL ("4.1 MHZ" BANDWIDTH-LIMITED ADDITIVE GAUSSIAN WHITE NOISE)	14
AGC THRESHOLD	15
TEST DATA: 800 BAND UPLINK AGC	16
TEST DATA: 800 BAND DOWNLINK AGC	17
OUT OF BAND REJECTION	18
TEST DATA: 800 BAND UPLINK PASSBAND	19
TEST DATA: 800 BAND DOWNLINK PASSBAND	20

INPUT VS OUTPUT COMPARISON	21
800 BAND, (806-809 MHz, 851 – 854 MHz) EMISSION MASKS	23
800 BAND, (809 - 824 MHz, 854 - 869 MHz) EMISSION MASKS	24
800 BAND UPLINK	25
800 BAND DOWNLINK	49
RF POWER OUTPUT	73
TEST DATA: 800 BAND MEASUREMENT TABLE	74
POWER TO FINAL AMPLIFIER.....	75
TEST DATA: POWER TO FINAL AMPLIFIER CALCULATION	75
NOISE FIGURE.....	76
800 BAND NOISE FIGURE	77
PASSBAND NOISE	81
800 BAND PASSBAND NOISE	82
INTERMODULATION SPURIOUS EMISSIONS	86
800 BAND UPLINK	87
800 BAND DOWNLINK	93
SPURIOUS EMISSIONS AT ANTENNA TERMINALS	99
800 BAND CONDUCTED SPURIOUS EMISSIONS.....	100
FREQUENCY STABILITY	104
FIELD STRENGTH OF SPURIOUS EMISSIONS.....	105
800 BAND RADIATED SPURIOUS EMISSIONS	107
STATEMENT OF MEASUREMENT UNCERTAINTY.....	108
EMC EQUIPMENT LIST	109

GENERAL REMARKS

Summary

The device under test does:

- Fulfill the general approval requirements as identified in this test report and was selected by the customer.
- Not fulfill the general approval requirements as identified in this test report

Attestations

This equipment has been tested in accordance with the standards identified in this test report. To the best of my knowledge and belief, these tests were performed using the measurement procedures described in this report.

All instrumentation and accessories used to test products for compliance to the indicated standards are calibrated regularly in accordance with ISO 17025 requirements.

I attest that the necessary measurements were made at:

Timco Engineering Inc.
849 NW State Road 45
Newberry, FL 32669
Designation #: US1070

Tested by:



Name and Title Franklin Rose, Project Manager / EMC Specialist

Date 07/30/2019

Reviewed and Approved by:



Name and Title Tim Royer, Project Manager / EMC Engineer

Date 08/01/2019

GENERAL INFORMATION

EUT Definition: FCC 90.219(a)

Signal booster. A device or system that automatically receives, amplifies, and retransmits signals from wireless stations into and out of building interiors, tunnels, shielded outdoor areas and other locations where these signals would otherwise be too weak for reliable communications. Signal booster systems may contain both Class A and Class B signal boosters as components.

EUT Technical Specifications:

EUT Description	800 MHZ DUAL BAND INDUSTRIAL BOOSTER		
EUT Details	Single Cabinet Bi-Directional Dual Band (700/800) CLASS A Signal Booster for Public Safety and Public Safety LTE Operations		
FCC ID	P3TDHS37		
Model Number	DHS37		
Operating Frequency	800 Band, Downlink: 851 – 869 MHz 800 Band, Uplink: 806 – 824 MHz		
EUT Power Source	<input checked="" type="checkbox"/> 110–120Vac, 50– 60Hz	<input type="checkbox"/> DC Power	<input type="checkbox"/> Battery Operated
Test Item	<input type="checkbox"/> Engineering Prototype	<input checked="" type="checkbox"/> Pre-Production	<input type="checkbox"/> Production
Type of Equipment	<input checked="" type="checkbox"/> Fixed	<input type="checkbox"/> Mobile	<input type="checkbox"/> Portable
Antenna Connector	3 external N Type		
Test Conditions	The temperature was 26°C Relative humidity of 50%.		
Modification to the EUT	No Modification to EUT.		
Test Exercise	The EUT was operated in accordance with the service manual using software supplied by the manufacturer.		
Applicable Standards	TIA 603-E:2016, ANSI C63.26, FCC CFR 47 Part 2, Part 90, KDB 935210 D05 v01r02, section 4		
Test Facility	Timco Engineering Inc. at 849 NW State Road 45 Newberry, FL 32669 USA. Designation #: US1070		

SUMMARY OF RESULTS

Applied Rule Part(s)	Test	Result
KDB 935210 s.4, FCC Pt. 90.531(a)	Test Frequencies	For Reporting Only
KDB 935210 s.4.1	Input Signals	For Reporting Only
KDB 935210 s.4.2	AGC Threshold	For Reporting Only
KDB 935210 s.4.3, FCC Pt. 90.219(a), FCC Pt. 90.219(d)(7)	Out-of-Band Rejection	CLASS A DEVICE
KDB 935210 s.4.4, FCC Pt. 2.1049(c), FCC Pt. 90.219(e)(4)(ii), FCC Pt. 90.210(c)	Input vs. Output Signal Comparison	PASS
KDB 935210 s.4.5, FCC Pt. 90.219(e)(1), FCC Pt. 90.219(e)(4)(iii)	RF Power Output (and Gain)	PASS
FCC Pt. 2.1033(c)(8)	Power Input to the Final Power Amplifier	For Reporting Only
KDB 935210 s.4.6, FCC Pt. 90.219(e)(2)	Noise Figure	PASS
FCC Pt. 90.219(d)(6)(ii), FCC Pt. 90.219(d)(6)(iii)	Passband Noise	For Reporting Only
KDB 935210 s.4.7.2 FCC Part 2.1051(a), FCC Pt. 90.219(d)(6)(i), FCC Pt. 90.219(e)(3)	Intermodulation Spurious Emissions	PASS
KDB 935210 s.4.7.3, FCC Part 2.1051(a), FCC Pt. 90.219(e)(3)	Spurious Emissions at Antenna Terminals	PASS
KDB 935210 s.4.8, FCC Part 2.1055(a)(1), FCC Part 2.1055(b), FCC Pt. 90.219(e)(4)(i)	Frequency Stability	n/a
KDB 935210 s.4.9, FCC Part 2.1053(a), FCC Pt. 90.219(e)(3)	Field Strength of Spurious Emissions	PASS

EMISSION DESIGNATION

Rule Part No.: FCC Part 2.202(g)

Note: All signals used here are representative of the type of signals which will be passed through this EUT, as outlined in KDB 935210 s.4.1.

Analog Signals

Emission Designator	Description	Modulation Type	M (modulation Freq., kHz)	R (rate, baud)	D (deviation, kHz)	K (numeric constant)	S (symbols)	Bandwidth Calculation	Necessary Bandwidth
4K00F3E	Narrowband Analog FM Voice	FM	1.0	-	1.0	1.0	-	Bn = 2M + 2DK	4.00
11K2F3E	Narrowband Analog FM Voice	FM	3.0	-	2.5	1.0	-		11.00
16K0F3E	Wideband Analog FM Voice	FM	3.0	-	5.0	1.0	-		16.00

Digital Signals

Emission Designator	Description	Modulation Type	M (modulation Freq., kHz)	R (rate, baud)	D (deviation, kHz)	K (numeric constant)	S (symbols)	Bandwidth Calculation	Bn (necessary bandwidth, kHz)
4K00F1E	Narrow NXDN Voice	4FSK	-	4800	1.55	0.516	4	Bn = (R/log ₂ S) + 2DK	4.00
4K00F1D	Narrow NXDN Data	4FSK	-	4800	1.55	0.516	4		4.00
4K00F1W	Narrow NXDN Voice/Data	4FSK	-	4800	1.55	0.516	4		4.00
8K30F1E	Wide NXDN Voice	4FSK	-	4800	3	0.984	4		8.30
8K30F1D	Wide NXDN Data	4FSK	-	4800	3	0.984	4		8.30
8K30F1W	Wide NXDN Voice & Data	4FSK	-	4800	3	0.984	4		8.30
4K00F2D	Narrow NXDN CW ID	4FSK	0.8	4800	1.2	1.0	4	Bn = 2M + 2DK	4.00
8K30F2D	Wide NXDN CW ID	4FSK	1.15	4800	3	1	4		8.30
7K60FXE	DMR Voice	4FSK	-	9600	1.8	0.778	4	Bn = (R/log ₂ S) + 2DK	7.60
7K60FXD	DMR Data	4FSK	-	9600	1.8	0.778	4		7.60
8K10F1E	P25 Phase I C4FM Voice	4FSK	-	9600	1.8	0.916	4	Bn = (R/log ₂ S) + 2DK	8.10
8K10F1D	P25 Phase I C4FM Data	4FSK	-	9600	1.8	0.916	4		8.10
8K10F1W	P25 Phase II H-CPM Voice/Data	4FSK	-	9600	1.8	0.916	4		8.10
9K80F1E	P25 Phase II H-DQPSK Voice	QPSK	-	12000	-	0.817	4	Bn = 2RK/log ₂ S	9.80
9K80F1D	P25 Phase II H-DQPSK Data	QPSK	-	12000	-	0.817	4		9.80

TEST FREQUENCIES

Rule Part No.: KDB 935210 s.4

All tests specified in KDB 935210 D05, Section 4 are intended for each band/block of operation. The bands/blocks of operation of this EUT are as follows:

EUT Operational Band(s): KDB 935210 D02, Appendix D, Table D.3

Table D.3 – Various Part 90 PLMRS band allocations, rule parts/sections, and service types for Section 90.219 purposes (for info only – see rules for details, also KDB Publication 634817 [R14])

F _L (MHz)	–	F _H (MHz)	Rule(s)	Misc. Notes
806	–	809	90 NPSPAC (PS) [90.617(a)(1)]	B9B/B9A
809	–	815	90 Interleaved PS; B/ILT; SMR [90.614(a); 90.613 ch. nos. 1-470] ^a	B9B/B9A
815	–	816	90 Expansion B/ILT; SMR [90.614(a); 90.613 ch. nos. 470-550] ^a	B9B/B9A
816	–	817	90 Guardband	B9B/B9A
817	–	824	CMRS 90 ESMR [90.614(b); 90.613 ch. nos. 551-830]	B21 90-S
851	–	854	90 NPSPAC (PS) [90.617(a)(1)]	B9B/B9A
854	–	860	90 Interleaved PS; B/ILT; SMR [90.614(a); 90.613 ch. nos. 1-470] ^a	B9B/B9A
860	–	861	90 Expansion B/ILT; SMR [90.614(a); 90.613 ch. nos. 470-550] ^a	B9B/B9A
861	–	862	90 Guardband	B9B/B9A
862	–	869	CMRS 90 ESMR [90.614(b); 90.613 ch. nos. 551-830]	B21 90-S

Frequencies for Testing:

The EUT will utilize the bands:

Operation	Band	Test Frequencies	Notes
800 Band, Uplink			
PLMRS/PSRS	806 – 824 MHz	806.03125 MHz 816.96875 MHz 823.96875 MHz	
800 Band, Downlink			
PLMRS/PSRS	851 – 869 MHz	851.03125 MHz 861.968750 MHz 868.968750 MHz	

INPUT SIGNALS

Rule Part No.: KDB 935210 s.4.1

The procedures in this clause are specific to EUTs intended for operating in the Private Land Mobile Radio Services (PLMRS) and Public Safety Radio Services (PSRS)⁵, which are governed under the provisions and requirements of the Part 90 rules (i.e., Section 90.219 applies).

Table 1 depicts signal types associated with PLMRS operations, which are to be considered as test signals to be used in performing compliance testing on PLMRS amplifiers, repeaters, and industrial boosters. Not all of the procedures in this clause will require using each of the signals listed in Table 1, because for many EUTs a CW tone can adequately model the narrowband signals typically encountered within these services. For EUTs supporting digitally modulated signals, the intended operating signal types should be tested (e.g., P25 Phase 1, P25 Phase 2, TETRA, etc.), especially for PSRS devices. Devices intended for use in 700 MHz Public Safety Broadband spectrum shall be tested using a representative band-limited AWGN signal (99 % OBW of 4.1 MHz) or the applicable signal type (e.g., LTE).

Table 1—Test signals for PLMRS devices

Emission Designator	Modulation	Occupied Bandwidth	Channel Bandwidth	Audio Frequency
16K0F3E	FM	16 kHz	25 kHz	1 kHz
11K3F3E	FM	11.3 kHz	12.5 kHz	1 kHz
4K00F1E	FM	4 kHz	6.25 kHz	1 kHz
N/A	CW	N/A	N/A	N/A

Input Signals

4K00F3E (Narrowband Analog FM Voice)

Substituted for signals:

4K00F1E (Narrow NXDN Voice)

4K00F1D (Narrow NXDN Data)

4K00F1W (Narrow NXDN Voice & Data)

4K00F2D (Narrow NXDN CW ID)

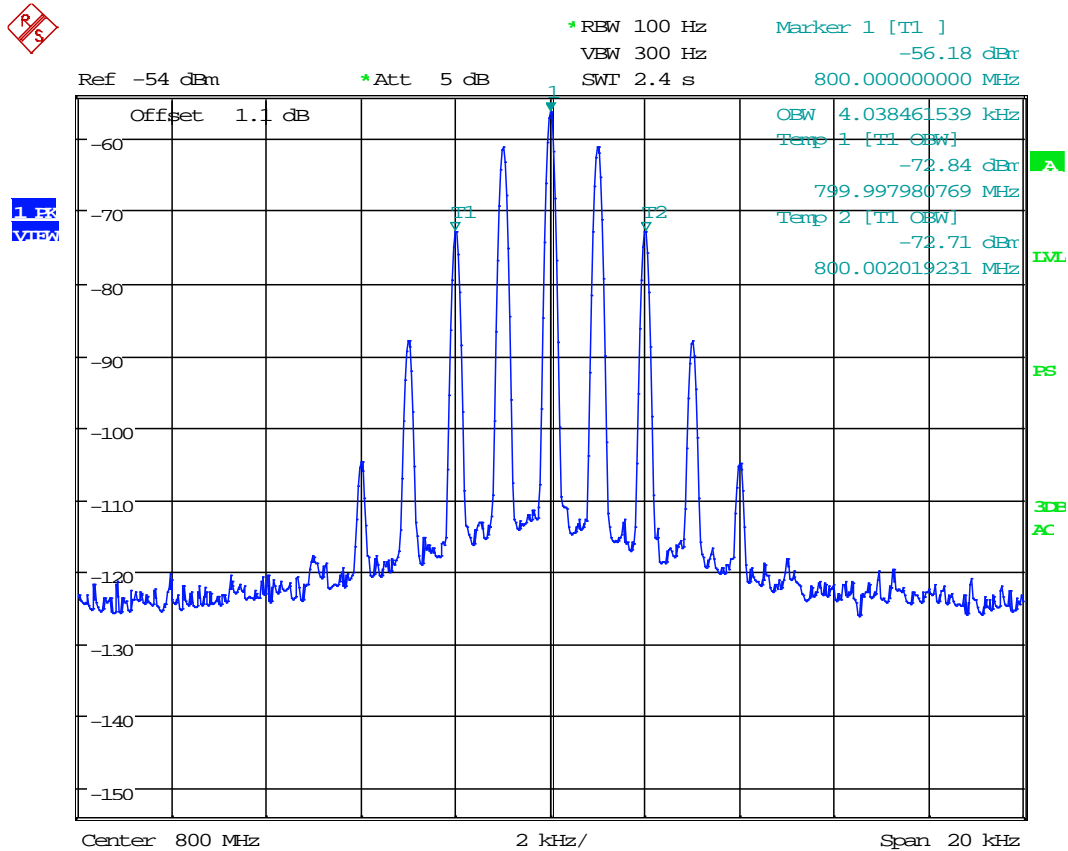

Date: 30.JAN.2019 13:10:11

Occupied Bandwidth: 4.04 kHz

Input Signals

8K10F1E/F1D (P25 Phase I C4FM Voice, Data)

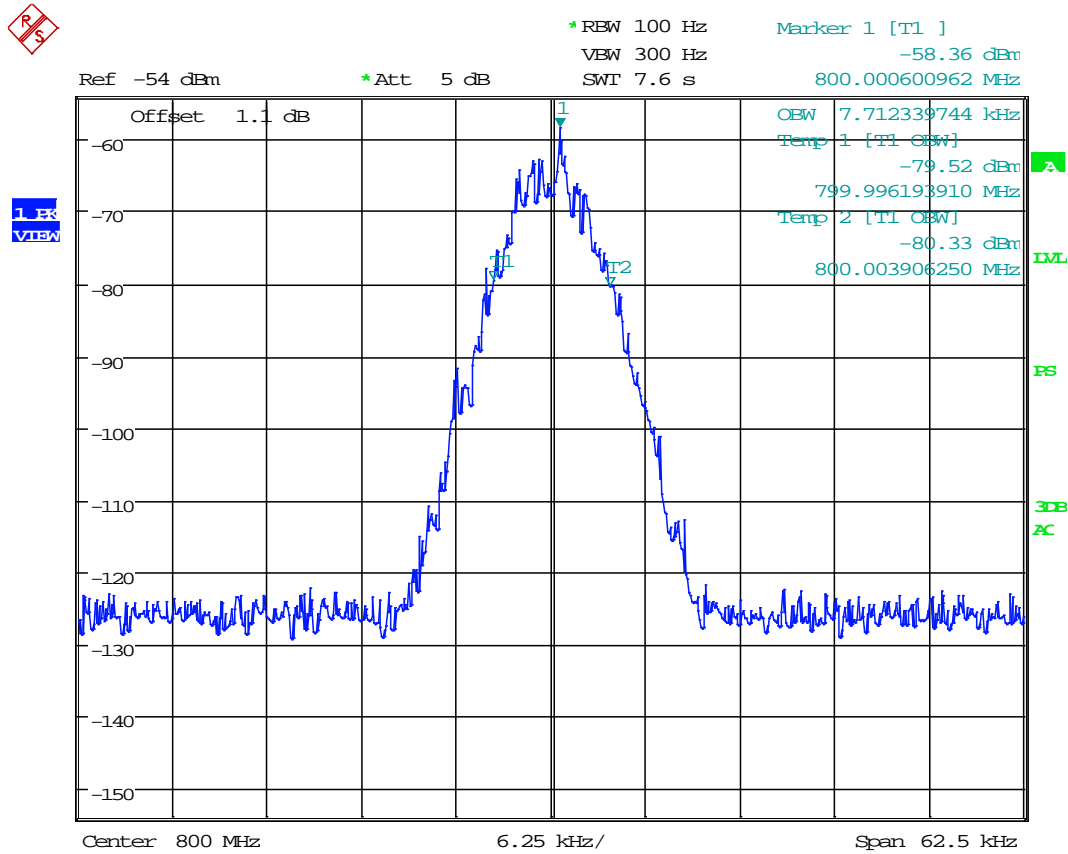

Date: 30.JAN.2019 14:28:58

Occupied Bandwidth: 7.71 kHz

Input Signals

8K10F1W (P25 Phase II H-CPM Voice & Data)

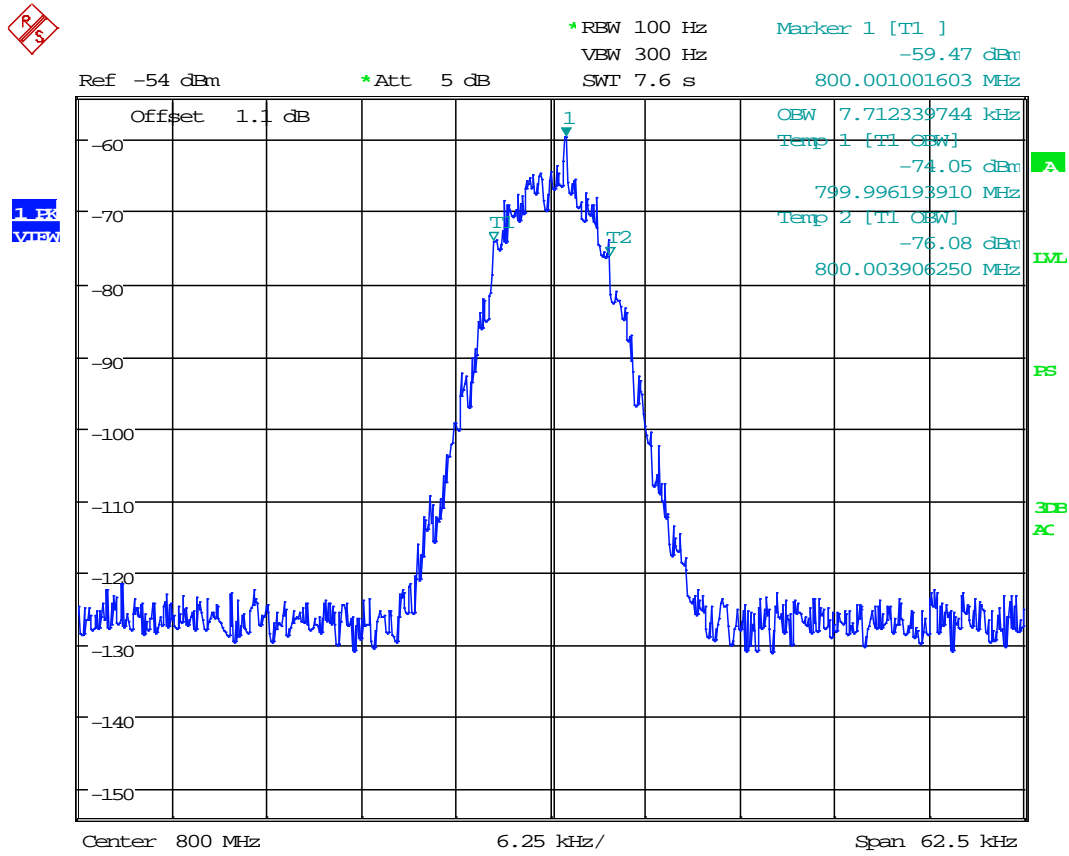

Date: 30.JAN.2019 14:30:47

Occupied Bandwidth: 7.71 kHz

Input Signals

9K80F1E/F1D (P25 Phase II H-DQPSK Voice, Data)

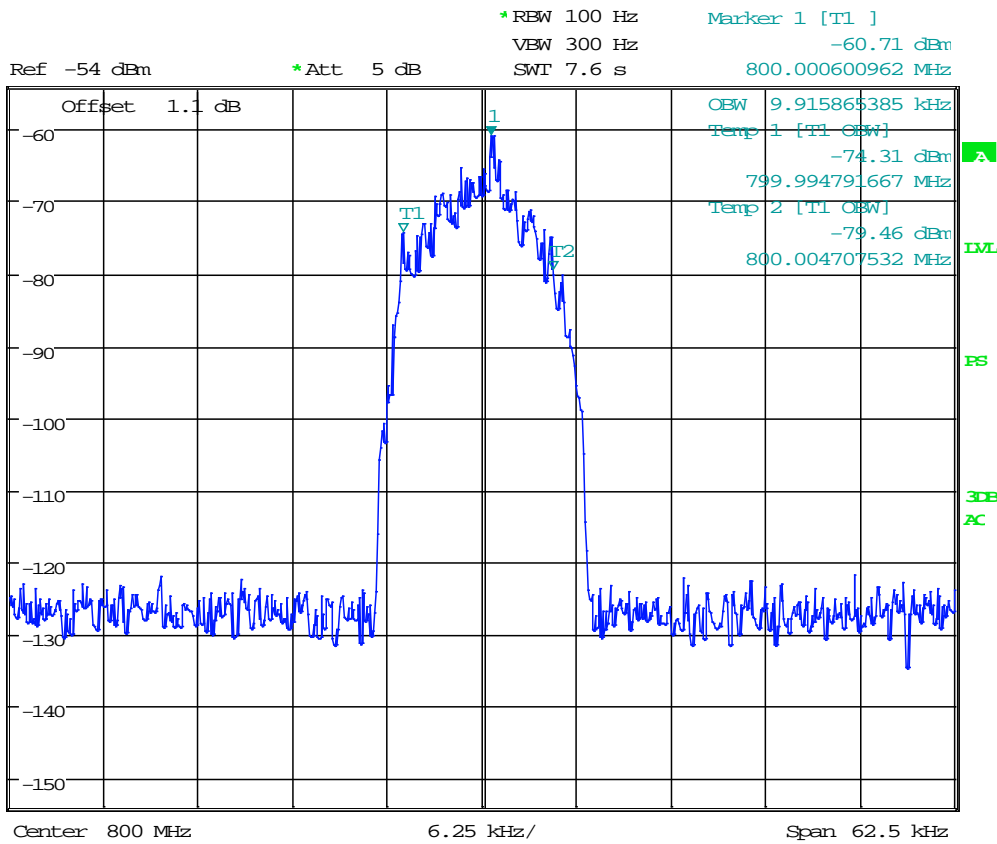

Date: 30.JAN.2019 14:32:35

Occupied Bandwidth: 9.92 kHz

Input Signals

11K3F3E (Narrowband Analog FM Voice)

Substituted for signals:

- 7K60FXE (2-Slot DMR TDMA Voice)
- 7K60FXD (2-Slot DMR TDMA Data)
- 8K30F1E (Wide NXDN Voice)
- 8K30F1D (Wide NXDN Data)
- 8K30F1W (Wide NXDN Voice & Data)
- 8K30F2D (Wide NXDN CW ID)

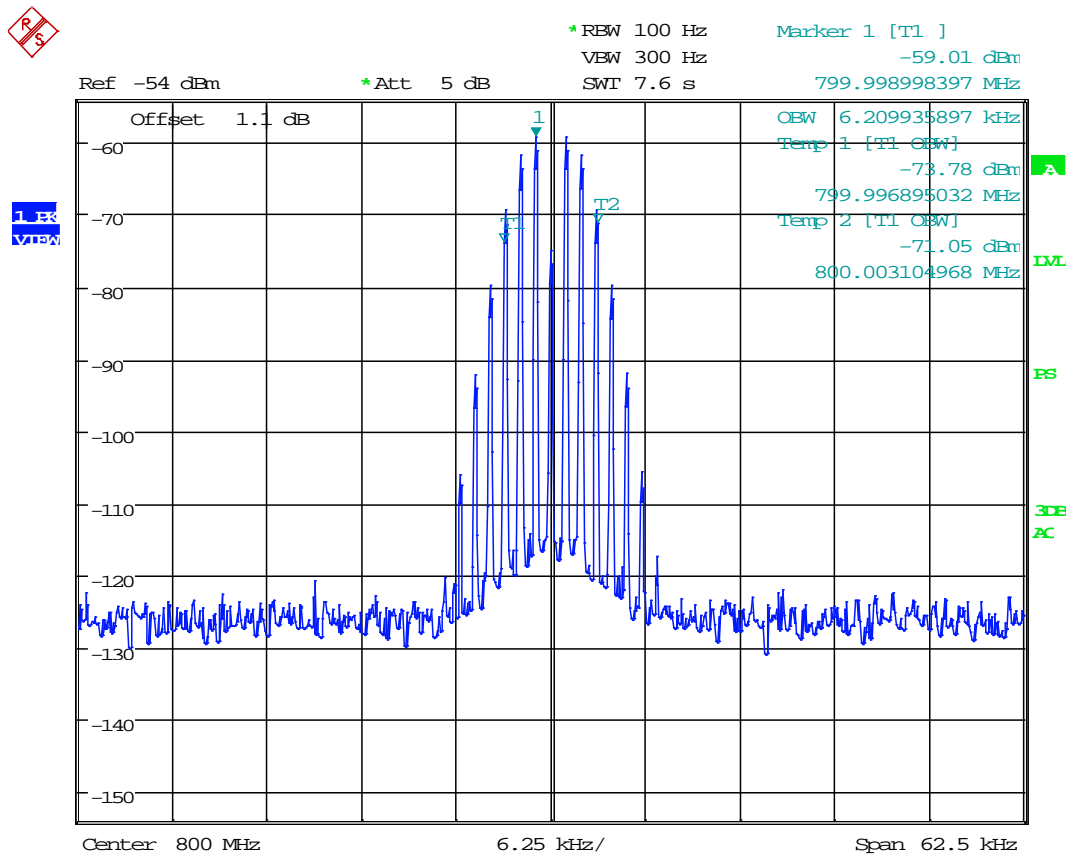

Date: 30.JAN.2019 14:19:45

Occupied Bandwidth: 6.21 kHz

Applicant: FIPLEX COMMUNICATIONS INC.
 FCC ID: P3TDHS37
 Report: 1802AUT19TestReport_Rev1

Input Signals

16K0F3E (Wideband Analog FM Voice)

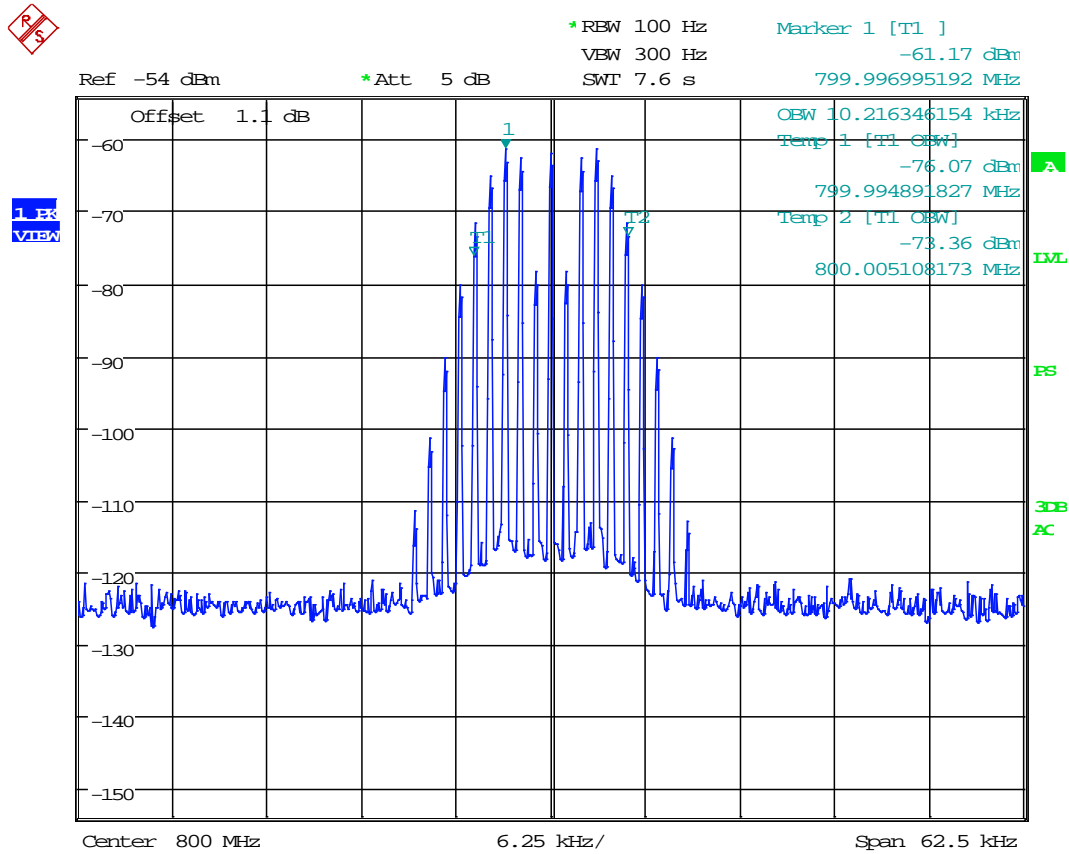

Date: 30.JAN.2019 14:23:14

Occupied Bandwidth: 10.22 kHz

Input Signals

AWGN Signal ("4.1 MHz" Bandwidth-Limited Additive Gaussian White Noise)

Substituted for signals:

- 5M00G7D ("Public Safety LTE", GSM/EDGE)
- 5M00D7W ("Public Safety LTE", QAM)
- 5M00W7D ("Public Safety LTE", OFDM)
- 5M00F9W ("Public Safety LTE", CDMA/EVDO/HSPA)
- 10M0G7D ("Public Safety LTE", GSM/EDGE)
- 10M0D7W ("Public Safety LTE", QAM)
- 10M0W7D ("Public Safety LTE", OFDM)
- 10M0F9W ("Public Safety LTE", CDMA/EVDO/HSPA)

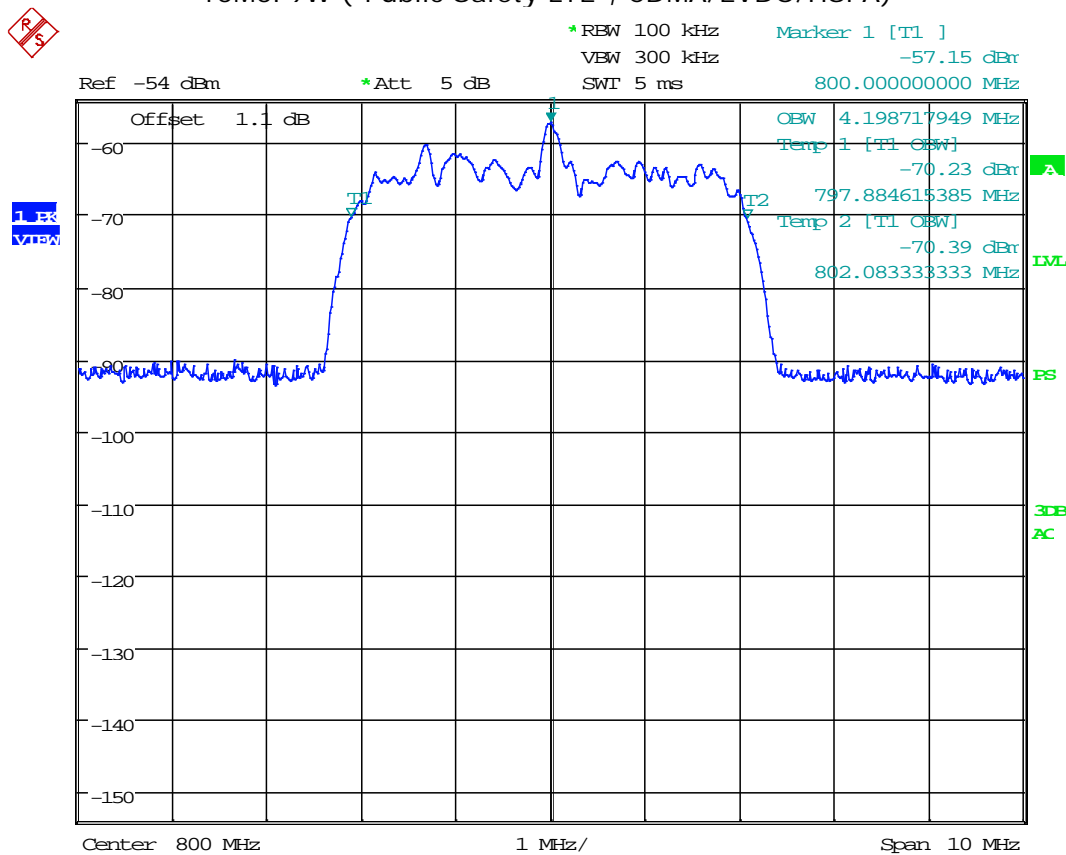

Date: 30.JAN.2019 14:36:46

Occupied Bandwidth: 4.20 MHz

Applicant: FIPLEX COMMUNICATIONS INC.
 FCC ID: P3TDHS37
 Report: 1802AUT19TestReport_Rev1

AGC THRESHOLD

Rule Part No.: KDB 935210 s.4.2

Requirements:

Testing at and above the AGC threshold will be required.⁶ The AGC threshold shall be determined by applying the procedure of 3.2, but with the signal generator configured to produce a test signal defined in Table 1, a CW input signal, or a digitally modulated signal, consistent with the discussion about signal types in 4.1.

⁶ See footnote 1 about the terms and concepts AGC, ALC, OLC.

Test Procedure: KDB 935210 s.3.2

The AGC threshold is to be determined as follows.³

In the case of fiber-optic distribution systems, the RF input port of the equipment under test (EUT) refers to the RF input of the supporting equipment RF to optical convertor; see also descriptions and diagrams for typical DAS booster systems in KDB Publication 935210 D02 [R7].

Devices intended to be directly connected to an RF source (donor port) only need to be evaluated for any over-the-air transmit paths.

- a) Connect a signal generator to the input of the EUT.
- b) Connect a spectrum analyzer or power meter to the output of the EUT using appropriate attenuation as necessary.
- c) The signal generator should initially be configured to produce either of the required test signals (i.e., broadband or narrowband).
- d) Set the signal generator frequency to the center frequency of the EUT operating band.
- e) While monitoring the output power of the EUT, measured using the methods of 3.5.3 or 3.5.4, increase the input level until a 1 dB increase in the input signal power no longer causes a 1 dB increase in the output signal power.
- f) Record this level as the AGC threshold level.
- g) Repeat the procedure with the remaining test signal.

³ Consistent with for example TIA-156 [R10], for compliance testing purposes the terms automatic gain control (AGC), automatic level control (ALC), and output level control (OLC) are generally taken to be synonyms, which refer to a means by which gain or output power is electronically adjusted as a function of voltage or some other specified parameter(s).

Test Setup Block Diagram: KDB 935210 s.3.2

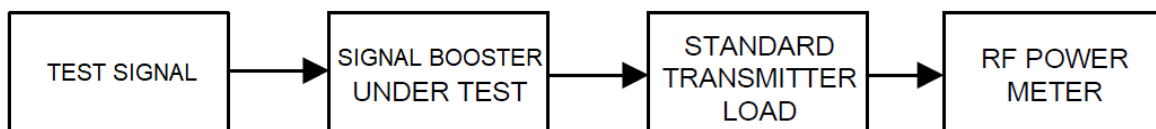

AGC THRESHOLD

Test Data: 800 Band Uplink AGC

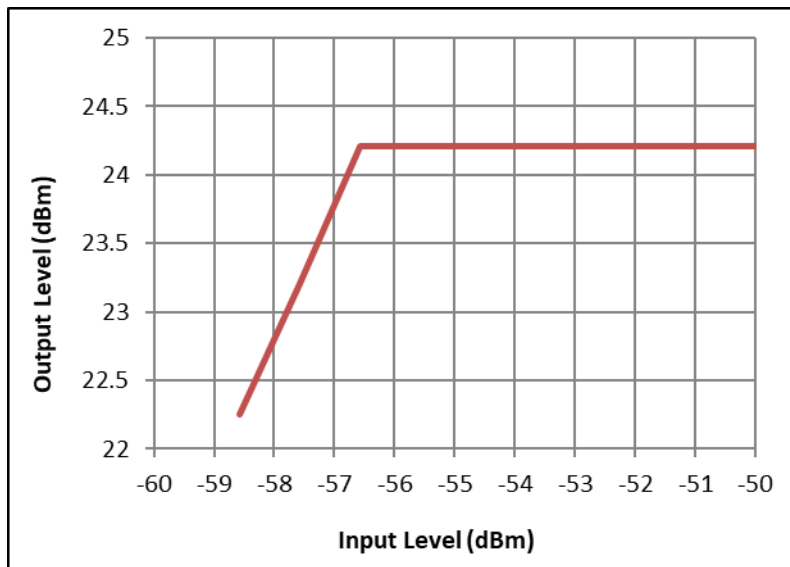

INPUT (dBm)	CORRECTED INPUT (dBm)	CORRECTED OUTPUT (dBm)	GAIN (dB)
-50	-58.58	22.25	80.8
-49	-57.58	23.21	80.8
-48	-56.58	24.21	80.8
-47	-55.58	24.21	79.8
-46	-54.58	24.21	78.8
-45	-53.58	24.21	77.8
-44	-52.58	24.21	76.8
-43	-51.58	24.21	75.8
-42	-50.58	24.21	74.8
-41	-49.58	24.21	73.8
-40	-48.58	24.17	72.8

AGC THRESHOLD

Test Data: 800 Band Downlink AGC

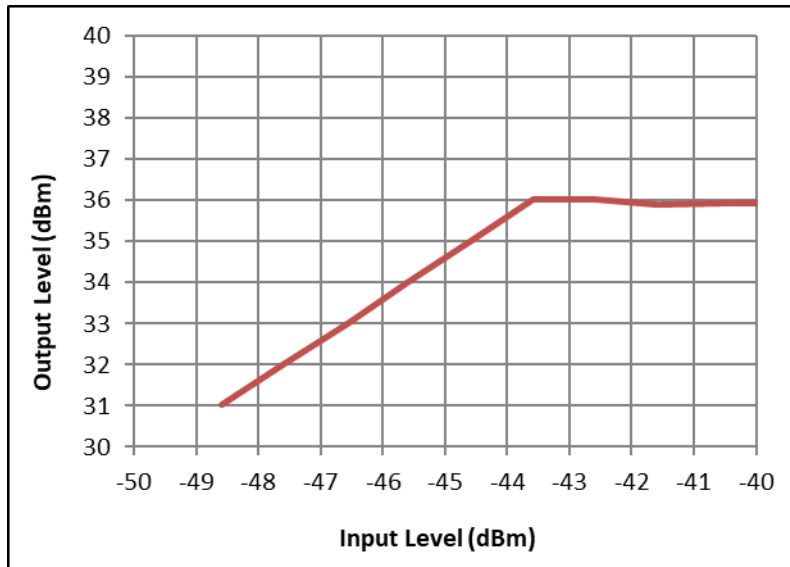

INPUT (dBm)	CORRECTED INPUT (dBm)	CORRECTED OUTPUT (dBm)	GAIN (dB)
-40	-48.58	31.02	79.6
-39	-47.58	32.03	79.6
-38	-46.58	33	79.6
-37	-45.58	34.02	79.6
-36	-44.58	35.02	79.6
-35	-43.58	36.01	79.6
-34	-42.58	36.01	78.6
-33	-41.58	35.91	77.5
-32	-40.58	35.92	76.5
-31	-39.58	35.92	75.5
-30	-38.58	35.92	74.5

OUT OF BAND REJECTION

Rule Part No.: KDB 935210 s.4.3, FCC Pt. 90.219(a), FCC Pt. 90.219(d)(7)

(a) *Definitions.* The definitions in this paragraph apply only to the rules in this section.

Class A signal booster. A signal booster designed to retransmit signals on one or more specific channels. A signal booster is deemed to be a Class A signal booster if none of its passbands exceed 75 kHz.

Class B signal booster. A signal booster designed to retransmit any signals within a wide frequency band. A signal booster is deemed to be a Class B signal booster if it has a passband that exceeds 75 kHz.

Requirements:

(7) Signal booster passbands are limited to the service band or bands for which the operator is authorized. In general, signal boosters should utilize the minimum passband that is sufficient to accomplish the purpose. Except for distributed antenna systems (DAS) installed in buildings, the passband of a Class B booster should not encompass both commercial services (such as ESMR and Cellular Radiotelephone) and part 90 Land Mobile and Public Safety Services.

Test Procedure: KDB 935210 s.4.3

Adjust the internal gain control of the EUT to the maximum gain for which equipment certification is sought.

- a) Connect a signal generator to the input of the EUT.
- b) Configure a swept CW signal with the following parameters:
 - 1) Frequency range = $\pm 250\%$ of the manufacturer's specified pass band.
 - 2) The CW amplitude shall be 3 dB below the AGC threshold (see 4.2), and shall not activate the AGC threshold throughout the test.
 - 3) Dwell time = approximately 10 ms.
 - 4) Frequency step = 50 kHz.
- c) Connect a spectrum analyzer to the output of the EUT using appropriate attenuation.
- d) Set the RBW of the spectrum analyzer to between 1 % and 5 % of the manufacturer's rated passband, and VBW = $3 \times$ RBW.
- e) Set the detector to Peak and the trace to Max-Hold.
- f) After the trace is completely filled, place a marker at the peak amplitude, which is designated as f_0 , and with two additional markers (use the marker-delta method) at the 20 dB bandwidth (i.e., at the points where the level has fallen by 20 dB).
- g) Capture the frequency response plot for inclusion in the test report.

Test Setup Block Diagram: KDB 935210 s.4.3

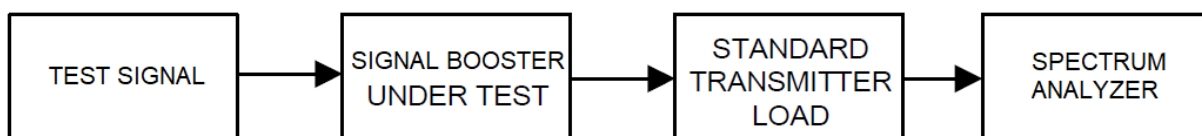

OUT OF BAND REJECTION

Test Data: 800 Band Uplink Passband

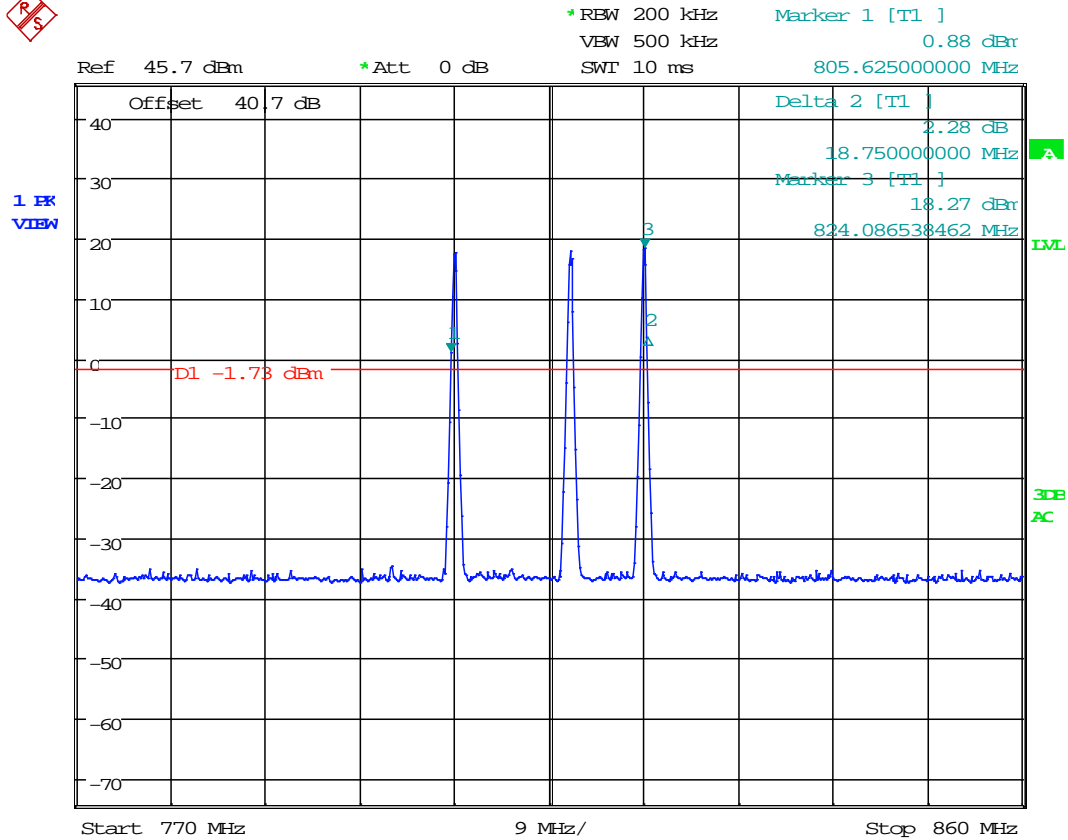

Date: 30.JUL.2019 17:38:12

RESULT:

CLASS A DEVICE, Channelized Equipment with ≤ 60 kHz Passband

OPERATING FREQUENCY RANGE = 18.75 MHz

OUT OF BAND REJECTION

Test Data: 800 Band Downlink Passband

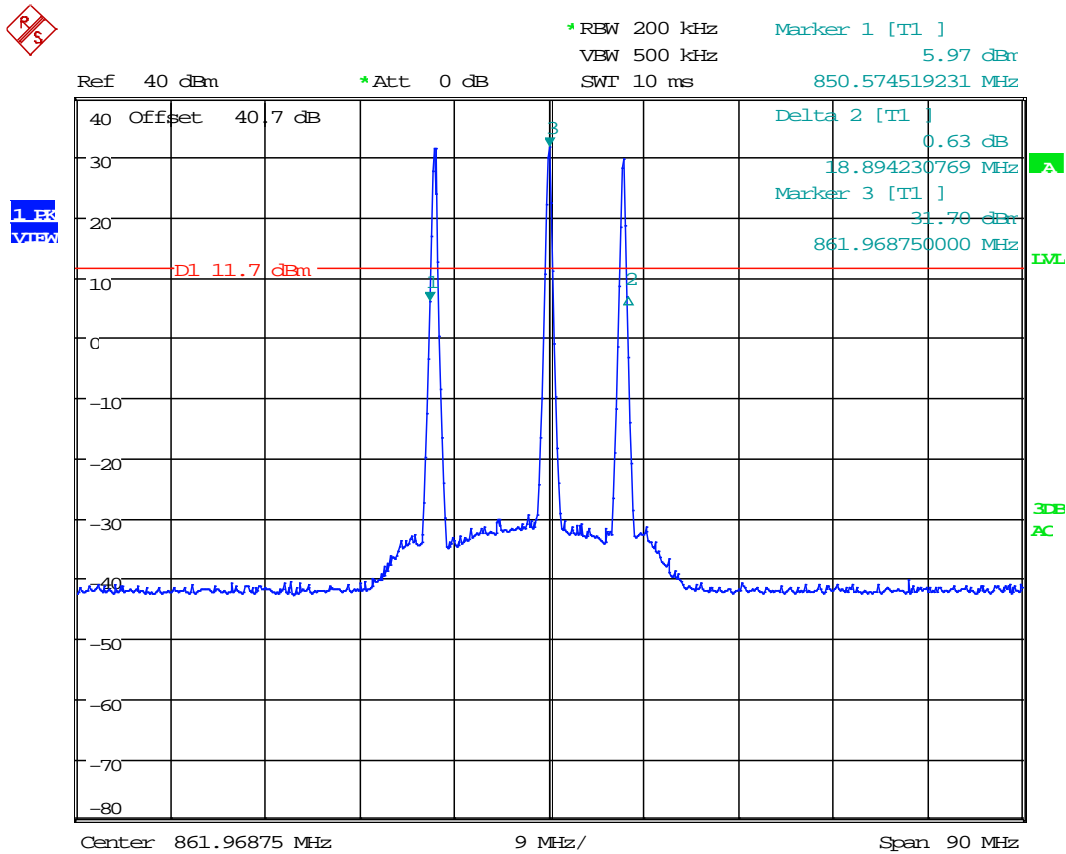

Date: 31.JUL.2019 12:17:15

RESULT:

CLASS A DEVICE, Channelized Equipment with ≤ 60 kHz Passband

OPERATING FREQUENCY RANGE = 18.89 MHz

INPUT VS OUTPUT COMPARISON

Rule Part No.: KDB 935210 s.4.4, FCC Pt. 2.1049(h), FCC Pt. 90.219(e)(4)(ii),
FCC Pt. 90.219(e)(4)(iii), FCC Pt. 90.210(c)

Compliance with the emission mask of the EUT output shall be measured for the public safety service signal types as specified in 4.1.

Refer to the applicable regulatory requirements (e.g., Section 90.210) for emission mask specifications.

Requirements:

(e) *Device Specifications.* In addition to the general rules for equipment certification in §90.203(a)(2) and part 2, subpart J of this chapter, a signal booster must also meet the rules in this paragraph.

(4) A signal booster must be designed such that all signals that it retransmits meet the following requirements:

(ii) There is no change in the occupied bandwidth of the retransmitted signals.

(iii) The retransmitted signals continue to meet the unwanted emissions limits of §90.210 applicable to the corresponding received signals (assuming that these received signals meet the applicable unwanted emissions limits by a reasonable margin).

APPLICABLE EMISSION MASKS

Frequency band (MHz)	Mask for equipment with audio low pass filter	Mask for equipment without audio low pass filter
806-809/851-854 ⁶	B	H

Frequency band (MHz)	Mask for equipment with audio low pass filter	Mask for equipment without audio low pass filter
809-824/854-869 ³⁵	B, D	D, G.

³Equipment used in this licensed to EA or non-EA systems shall comply with the emission mask provisions of §90.691 of this chapter.

⁵Equipment designed to operate on 25 kilohertz bandwidth channels must meet the requirements of either Emission Mask B or G, whichever is applicable, while equipment designed to operate on 12.5 kilohertz bandwidth channels must meet the requirements of Emission Mask D. Equipment designed to operate on 25 kilohertz bandwidth channels may alternatively meet the Adjacent Channel Power limits of §90.221.

⁶Transmitters utilizing analog emissions that are equipped with an audio low-pass filter must meet Emission Mask B. All transmitters utilizing digital emissions and those transmitters using analog emissions without an audio low-pass filter must meet Emission Mask H.

Frequency band (MHz)	Mask for equipment with audio low pass filter	Mask for equipment without audio low pass filter
All other bands	B	C

INPUT VS OUTPUT COMPARISON

Test Procedure: KDB 935210 s.4.4

- a) Connect a signal generator to the input of the EUT.
- b) Configure the signal generator to transmit the appropriate test signal associated with the public safety emission designation (see Table 1).
- c) Configure the signal level to be just below the AGC threshold (see results from 4.2).
- d) Connect a spectrum analyzer to the output of the EUT using appropriate attenuation as necessary.
- e) Set the spectrum analyzer center frequency to the nominal EUT channel center frequency. The span range for the spectrum analyzer shall be between 2 times to 5 times the EBW (or OBW).
- f) The nominal RBW shall be 300 Hz for 16K0F3E, and 100 Hz for all other emissions types.
- g) Set the reference level of the spectrum analyzer to accommodate the maximum input amplitude level, i.e., the level at f_0 per 4.2.
- h) Set spectrum analyzer detection mode to peak, and trace mode to max hold.
- i) Allow the trace to fully stabilize.
- j) Confirm that the signal is contained within the appropriate emissions mask.
- k) Use the marker function to determine the maximum emission level and record the associated frequency as f_0 .
- l) Capture the emissions mask plot for inclusion in the test report (output signal spectra).
- m) Measure the EUT input signal power (signal generator output signal) directly from the signal generator using power measurement guidance provided in KDB Publication 971168 [R8] (input signal spectra).
- n) Compare the spectral plot of the output signal (determined in step k), to the input signal (determined in step l) to affirm they are similar (in passband and rolloff characteristic features and relative spectral locations).
- o) Repeat steps d) to n) with the input signal amplitude set 3 dB above the AGC threshold.
- p) Repeat steps b) to o) for all authorized operational bands and emissions types (see applicable regulatory specifications, e.g., Section 90.210).
- q) Include all accumulated spectral plots depicting EUT input signal and EUT output signal in the test report, and note any observed dissimilarities.

Test Setup Block Diagram: KDB 935210 s.4.4

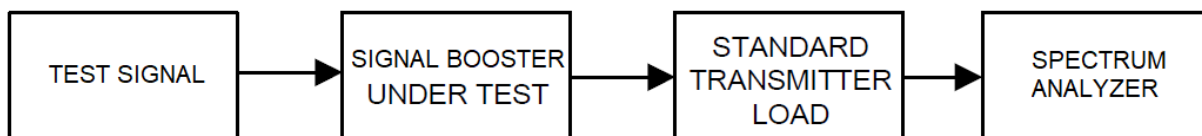

INPUT VS OUTPUT COMPARISON

Emission Mask Calculation: FCC Pt. 90.219(e)(4)(ii), FCC Pt. 90.219(e)(4)(iii),
FCC Pt. 90.210(c)

FCC CFR 47 Part 90 Emission Masks						
Frequency Band (MHz)	Mask for equipment with audio low pass filter			Mask for equipment without audio low pass filter		
	6.25 kHz	12.5 kHz	25 kHz	6.25 kHz	12.5 kHz	25 kHz
806 - 809	B, 20 kHz ABW			H, 20 kHz ABW		
809 - 817	D, 11.25 kHz ABW		B, 20 kHz ABW	D, 11.25 kHz ABW		G, 20 kHz ABW
817 - 824	D, 20 kHz ABW		B, 20 kHz ABW	D, 20 kHz ABW		G, 20 kHz ABW
851 - 854	B, 20 kHz ABW			H, 20 kHz ABW		
854 - 862	D, 11.25 kHz ABW		B, 20 kHz ABW	D, 11.25 kHz ABW		G, 20 kHz ABW
862 - 869	D, 20 kHz ABW		B, 20 kHz ABW	D, 20 kHz ABW		G, 20 kHz ABW

800 Band, (806-809 MHz, 851 – 854 MHz) Emission Masks

Calculation	Limit (dBc)	dBc	dBm
#7 (Mask H)	$107 * \text{Log}(4 / 4)$	0.00	36.99
	$107 * \text{Log}(8.5 / 4)$	35.03	1.96
	$40.5 * \text{Log}(8.5 / 1.16)$	35.03	1.96
	$40.5 * \text{Log}(15 / 1.16)$	45.02	-8.03
	$116 * \text{Log}(15 / 6.1)$	45.33	-8.34
	$116 * \text{Log}(25 / 6.1)$	71.06	-34.07

MASK H, 20 kHz Authorized BW			
Requirement	f_d (kHz)	Level (dBc)	Level (dBm)
≤ -25 kHz, see #1	≤ -25	49.99	-13.00
-15 kHz to -25 kHz, see #7	-25	71.06	-34.07
	-15	45.33	-8.34
-8.5 kHz to -15 kHz, see #7	-15	45.02	-8.03
	-8.5	35.03	1.96
-4 kHz to -8.5 kHz, see #7	-8.5	35.03	1.96
	-4	0.00	36.99
-4 kHz > fundamental < +4 kHz, 0 dBc	-4	0.00	36.99
	0		
	+4		
+3 kHz to +4.6 kHz, see #4	+4	0.00	36.99
	+8.5	35.03	1.96
+3 kHz to +4.6 kHz, see #4	+8.5	35.03	1.96
	+15	45.02	-8.03
+3 kHz to +4.6 kHz, see #4	+15	45.33	-8.34
	+25	71.06	-34.07
$\geq +25$ kHz, see #1	$\geq +25$	49.99	-13.00

INPUT VS OUTPUT COMPARISON

800 Band, (809 - 824 MHz, 854 - 869 MHz) Emission Masks

Calculation	Limit (dBc)	dBc	dBm
#3 (Mask D)	7.27(5.625 - 2.88)	19.96	17.03
	7.27(12.5 - 2.88)	69.94	-32.95
#6 (Mask G)	Min dBc of: 70 or 50 + 10 * Log(P) or 116 * Log(10 / 6.1)	24.90	12.09
	Min dBc of: 70 or 50 + 10 * Log(P) or 116 * Log((250% ABW) / 6.1)	56.99	-20.00

MASK D, 11.25/20 kHz ABW			
Requirement	f _d (kHz)	Level (dBc)	Level (dBm)
≤ -12.5 kHz, see #3	≤ -12.5	49.99	-13.00
- 5.625 kHz to -12.5 kHz, see #3	-12.5	69.94	-32.95
	-5.625	19.96	17.03
-5.625 kHz > fundamental < +5.625 kHz, 0 dBc	-5.625	0.00	36.99
	0		
	+ 5.625		
+ 5.625 kHz to +12.5 kHz, see #3	+ 5.625	19.96	17.03
	+ 12.5	69.94	-32.95
≥ +12.5 kHz, see #3	≥ + 12.5	49.99	-13.00

MASK G, 20 kHz ABW			
Requirement	f _d (kHz)	Level (dBc)	Level (dBm)
≥ 250% of ABW, see #1	≤ -50	49.99	-13.00
-10 kHz to -250% of ABW, see #6	-50	56.99	-20.00
	-10	24.90	12.09
(Fundamental)	0	36.99	36.99
+10 kHz to +250% of ABW, see #6	+ 10	24.90	12.09
	+ 50	56.99	-20.00
≥ 250% of ABW, see #1	≥ + 50	49.99	-13.00

INPUT VS OUTPUT COMPARISON

800 Band Uplink

Note: Select plots in this section display additional masks for compliance with RSS-119, via RSS-131 (Canada)

Test Data: Uplink (806.03125 MHz), 4K00F3E Output Signal, @ AGC

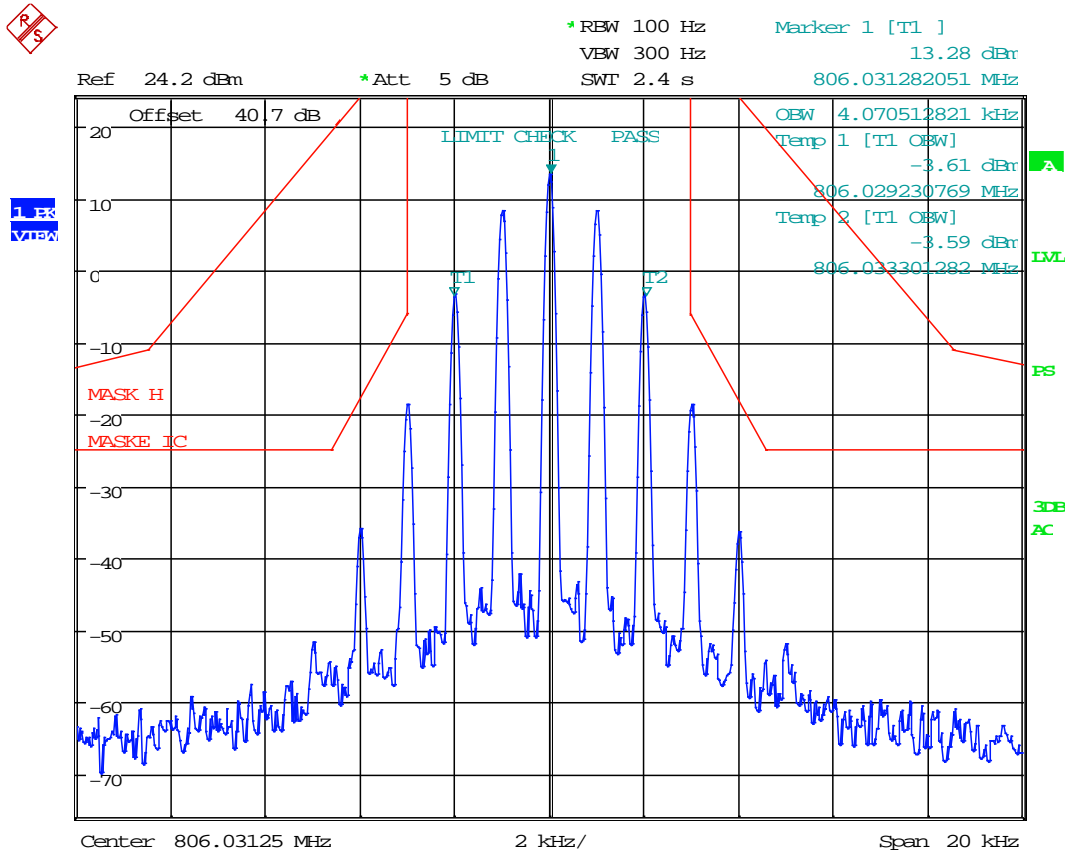

Date: 31.JUL.2019 11:27:12

RESULT: AGC Output Signal 99% OBW = 4.07 kHz

INPUT VS OUTPUT COMPARISON

Test Data: Uplink (806.03125 MHz), 4K00F3E Output Signal, @ AGC +3 dBm

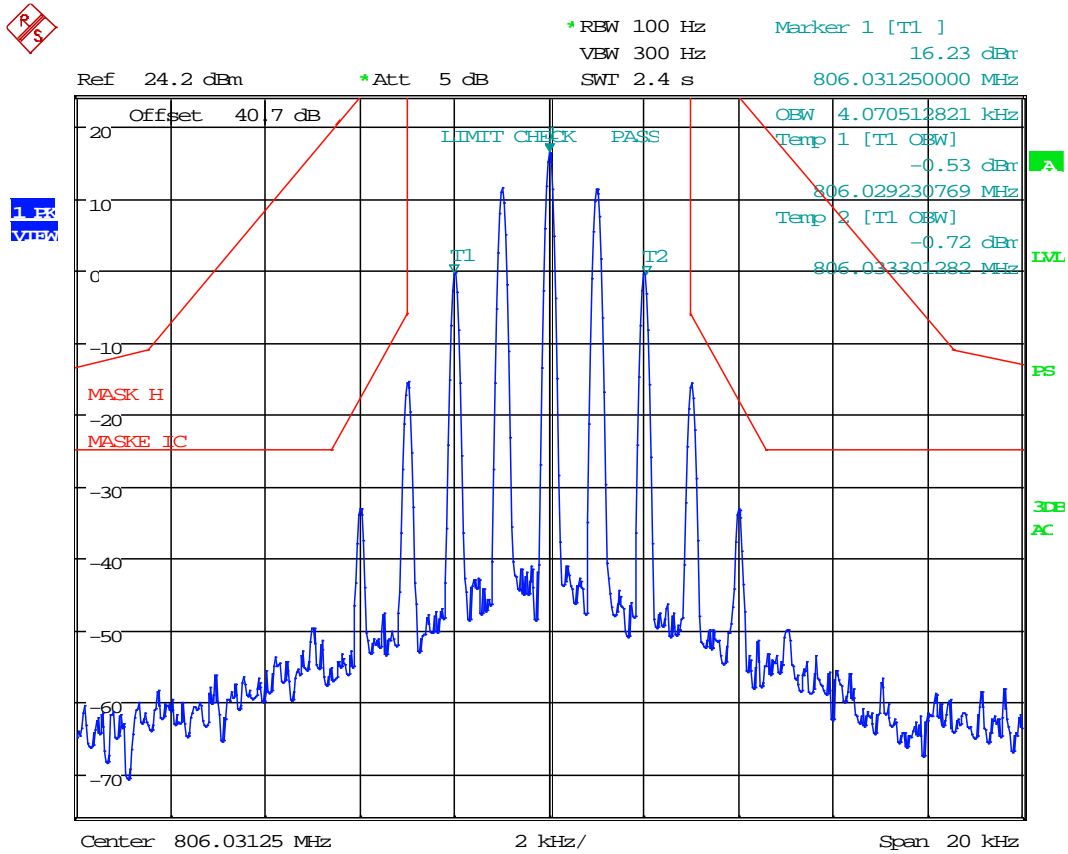

Date: 31.JUL.2019 11:28:07

RESULT: AGC+3 Output Signal 99% OBW = 4.07 kHz

INPUT VS OUTPUT COMPARISON

Test Data: Uplink (806.03125 MHz), 8K10F1E/F1D Output Signal, @ AGC

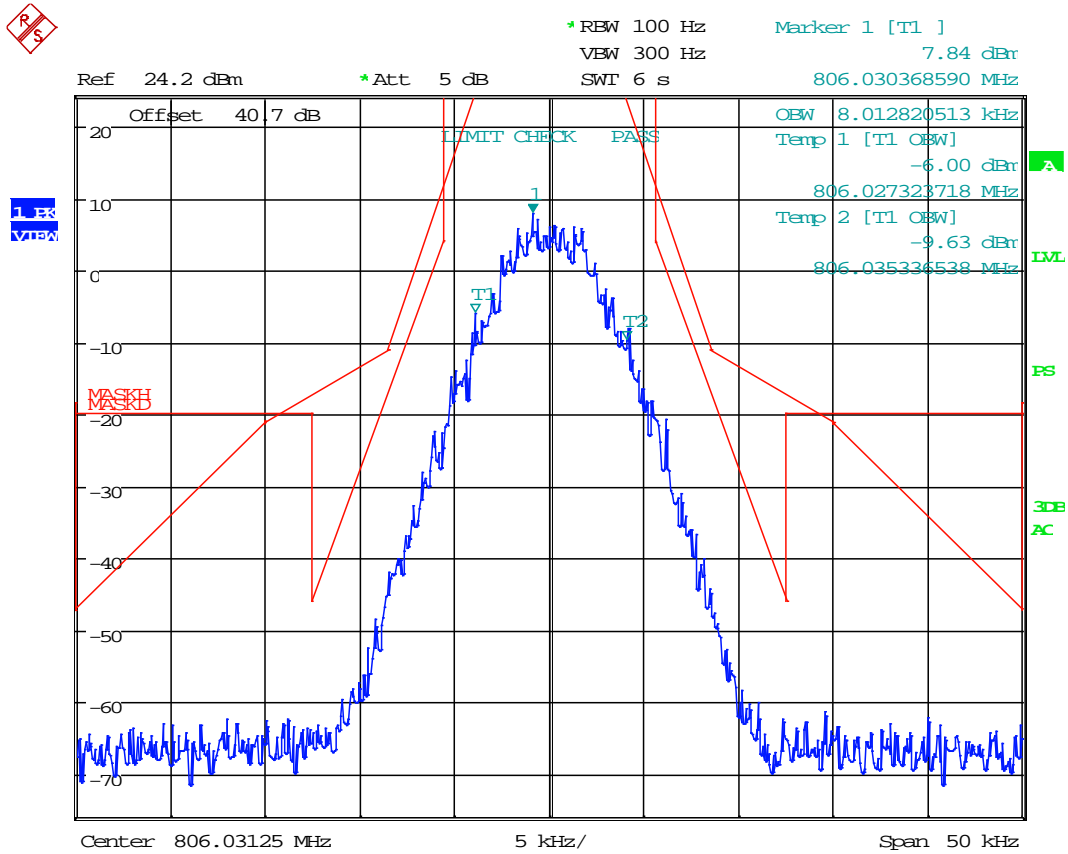

Date: 31.JUL.2019 11:37:19

RESULT: AGC Output Signal 99% OBW = 8.01 kHz

INPUT VS OUTPUT COMPARISON

Test Data: Uplink (806.03125 MHz), 8K10F1E/F1D Output Signal, @ AGC +3 dBm

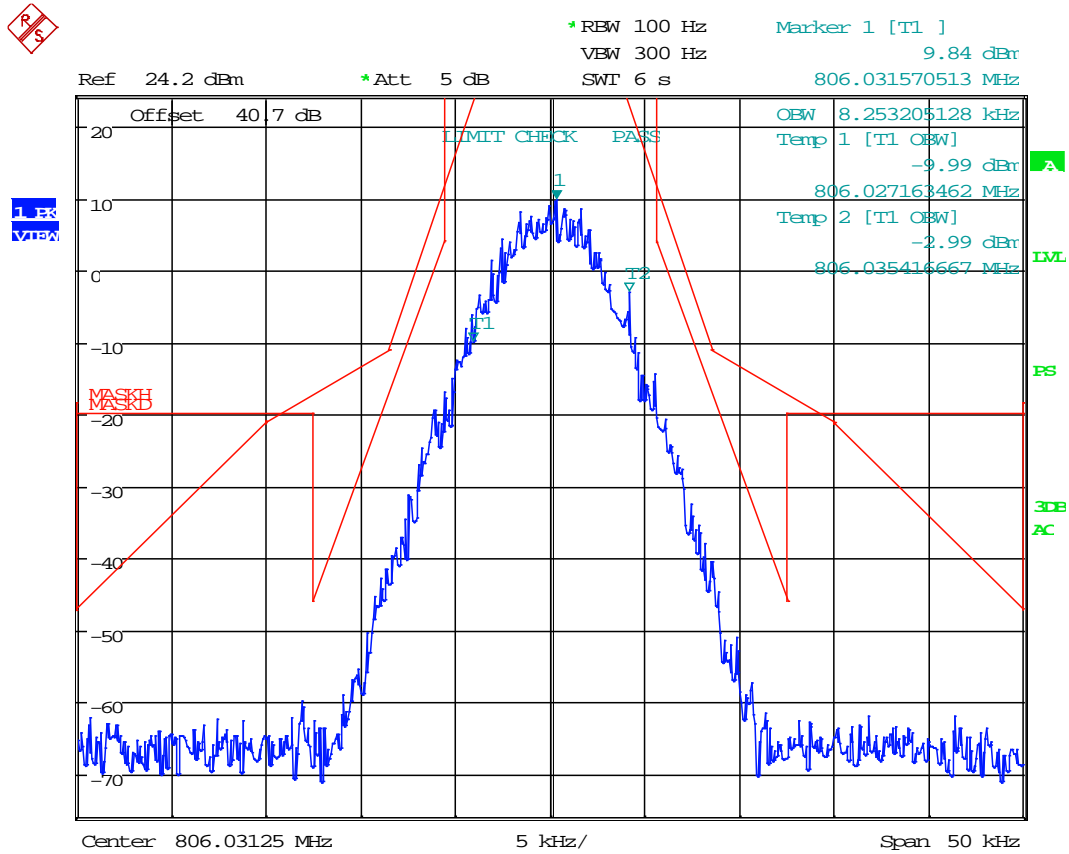

Date: 31.JUL.2019 11:37:48

RESULT: AGC+3 Output Signal 99% OBW = 8.25 kHz

INPUT VS OUTPUT COMPARISON

Test Data: Uplink (806.03125 MHz), 8K10F1W Output Signal, @ AGC

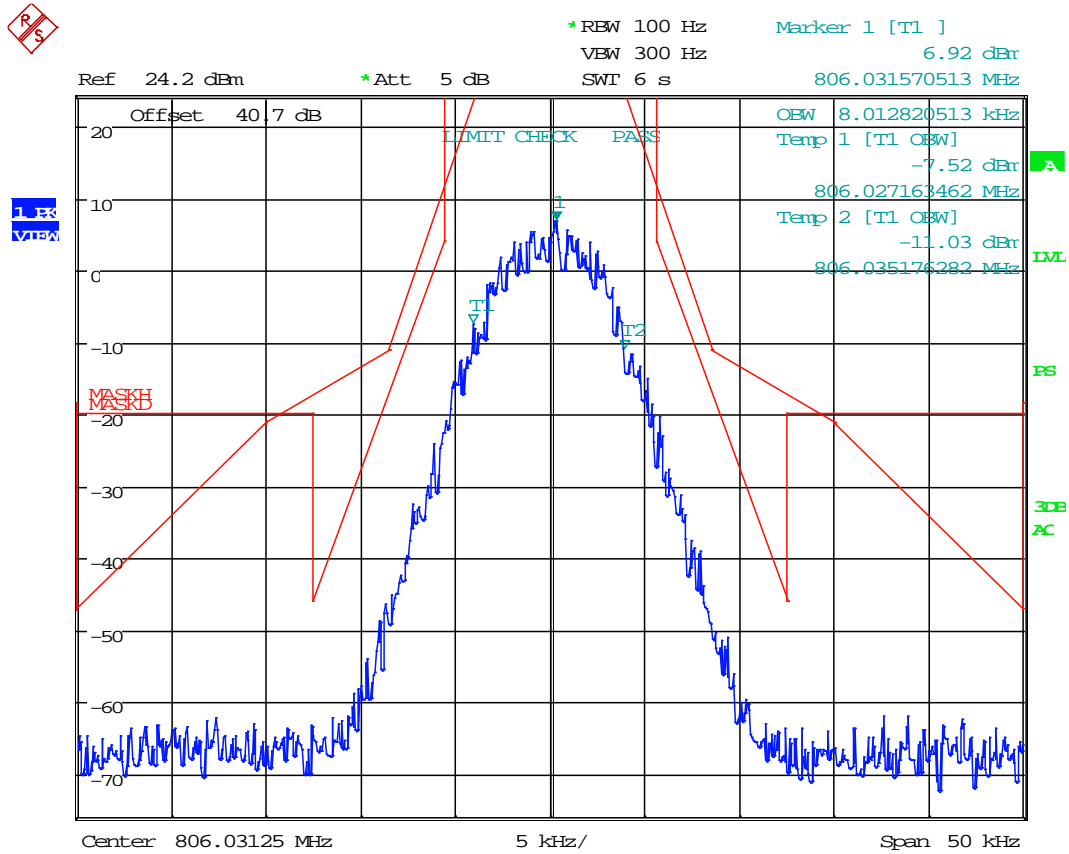

Date: 31.JUL.2019 11:38:31

RESULT: AGC Output Signal 99% OBW = 8.01 kHz

INPUT VS OUTPUT COMPARISON

Test Data: Uplink (806.03125 MHz), 8K10F1W Output Signal, @ AGC +3 dBm

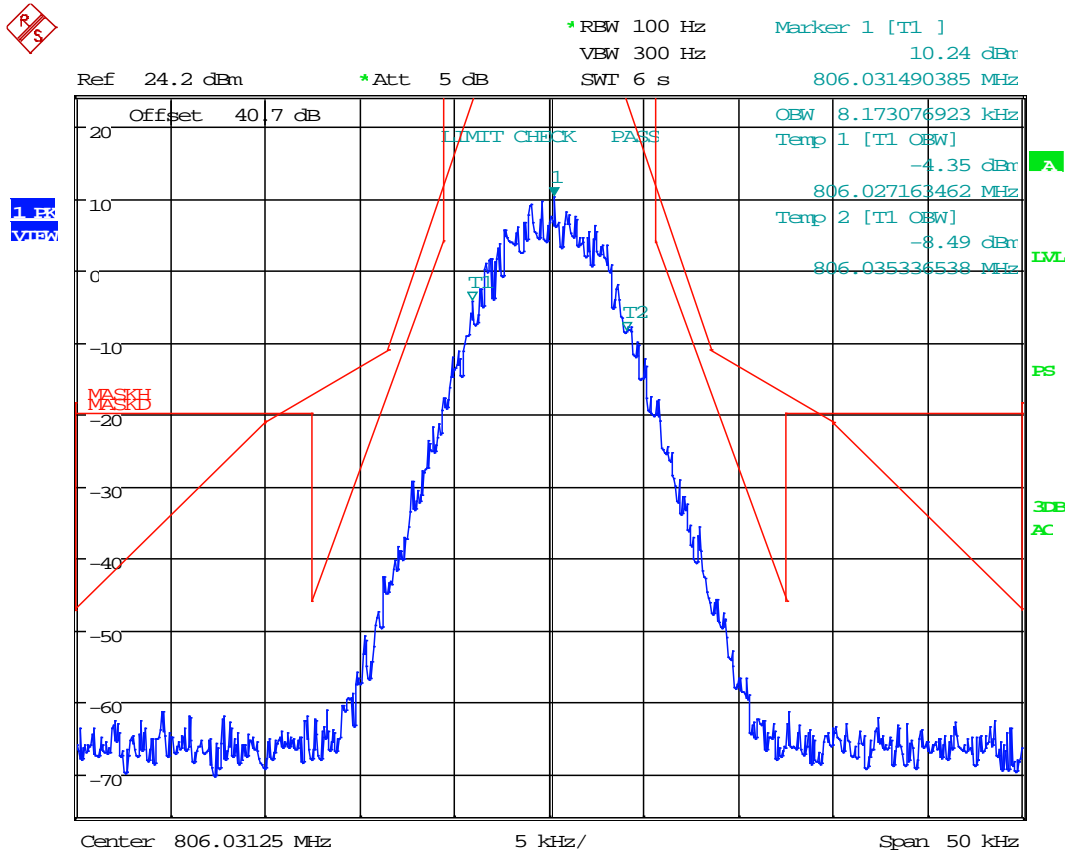

Date: 31.JUL.2019 11:39:18

RESULT: AGC+3 Output Signal 99% OBW = 8.17 kHz

INPUT VS OUTPUT COMPARISON

Test Data: Uplink (806.03125 MHz), 9K80F1E/F1D Output Signal, @ AGC

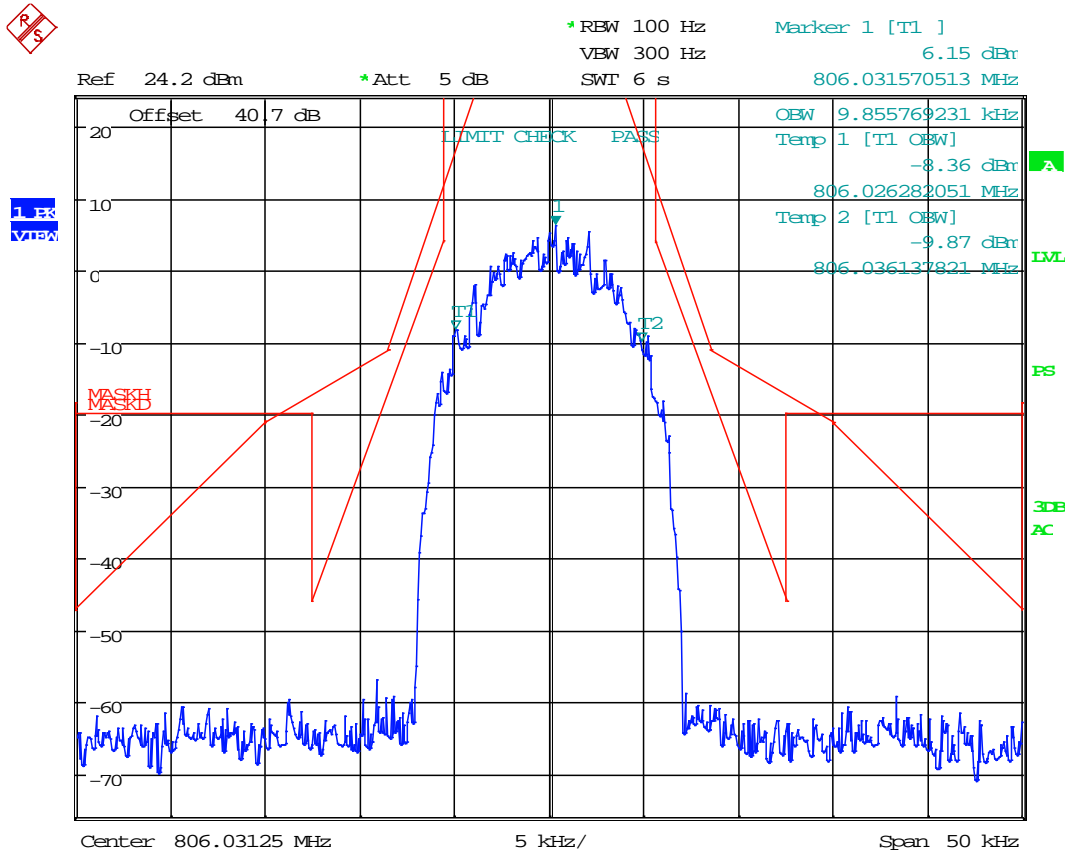

Date: 31.JUL.2019 11:35:15

RESULT: AGC Output Signal 99% OBW = 9.86 kHz

INPUT VS OUTPUT COMPARISON

Test Data: Uplink (806.03125 MHz), 9K80F1E/F1D Output Signal, @ AGC +3 dBm

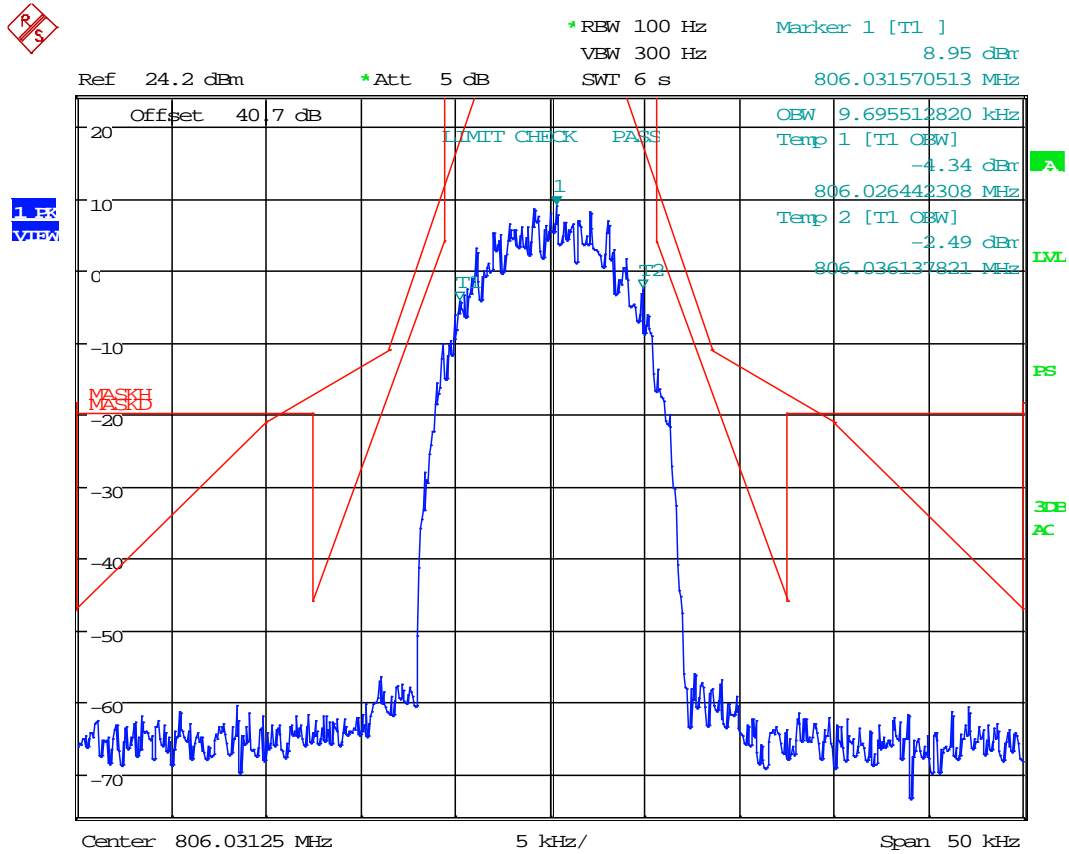

Date: 31.JUL.2019 11:36:18

RESULT: AGC+3 Output Signal 99% OBW = 9.70 kHz

INPUT VS OUTPUT COMPARISON

Test Data: Uplink (806.03125 MHz), 11K3F3E Output Signal, @ AGC

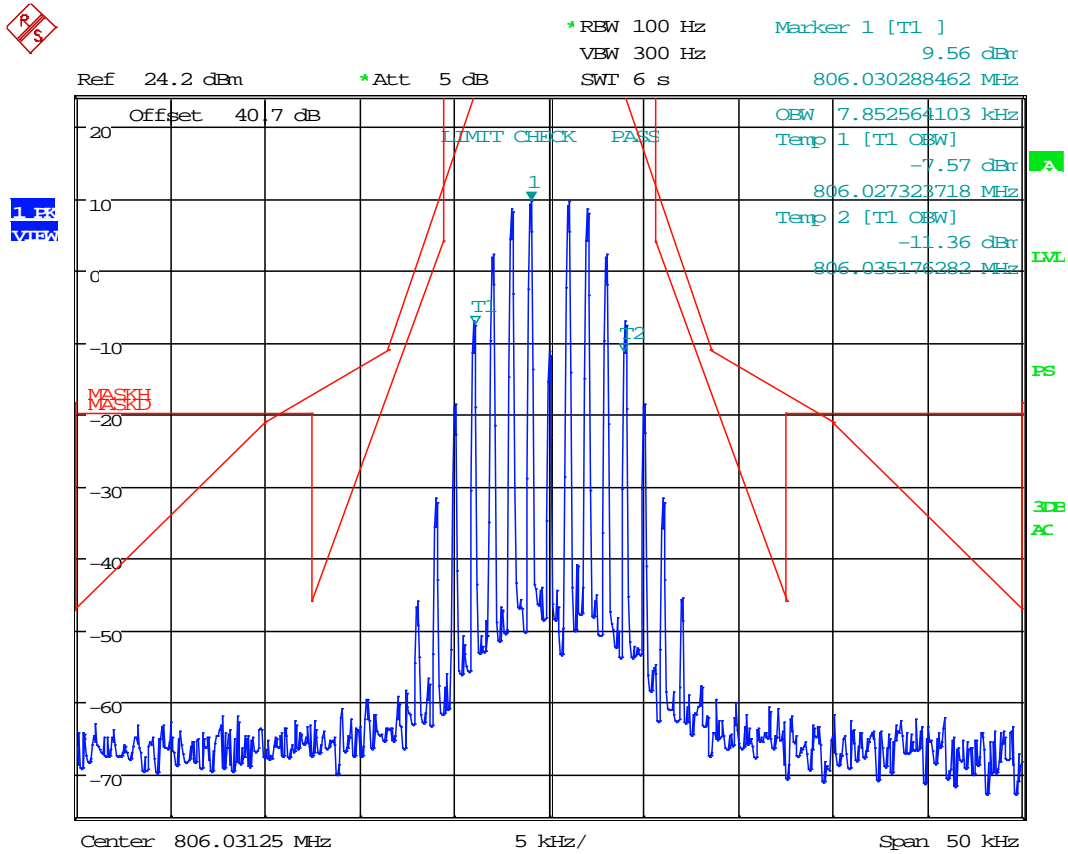

Date: 31.JUL.2019 11:32:57

RESULT: AGC Output Signal 99% OBW = 7.85 kHz

INPUT VS OUTPUT COMPARISON

Test Data: Uplink (806.03125 MHz), 11K3F3E Output Signal, @ AGC +3 dBm

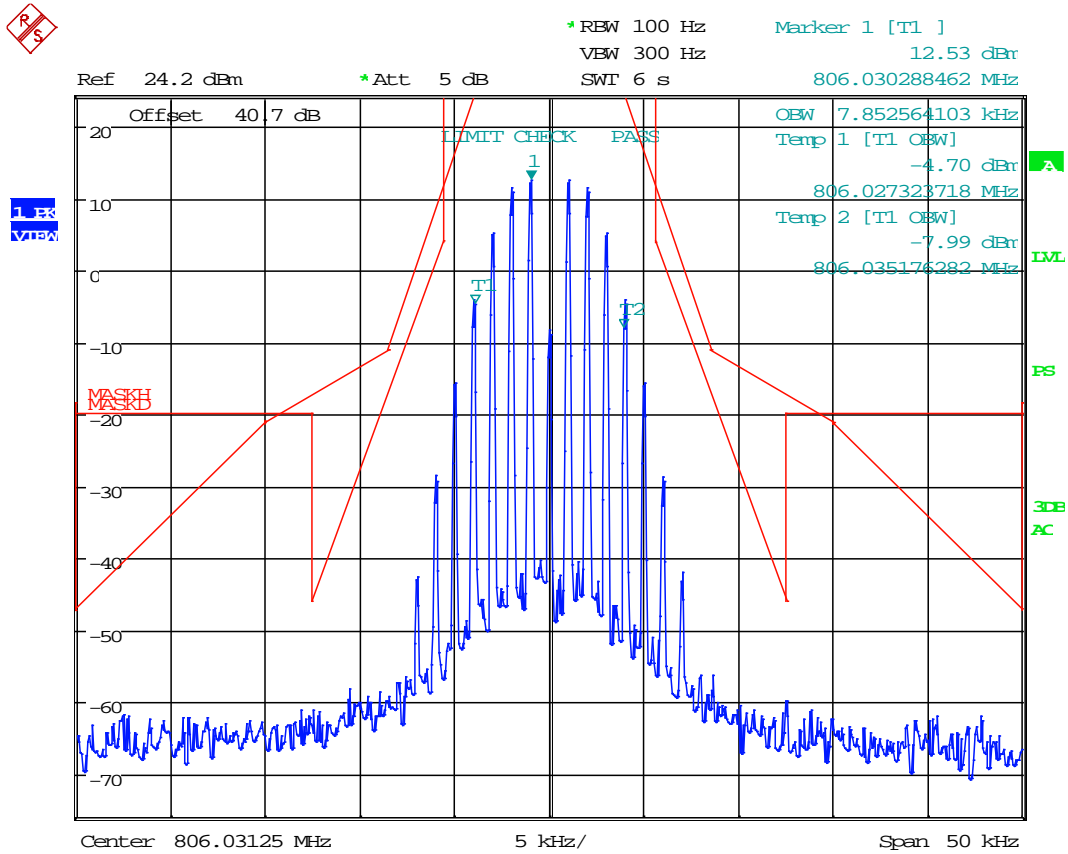

Date: 31.JUL.2019 11:32:02

RESULT: AGC+3 Output Signal 99% OBW = 7.85 kHz

INPUT VS OUTPUT COMPARISON

Test Data: Uplink (806.03125 MHz), 16KOF3E Output Signal, @ AGC

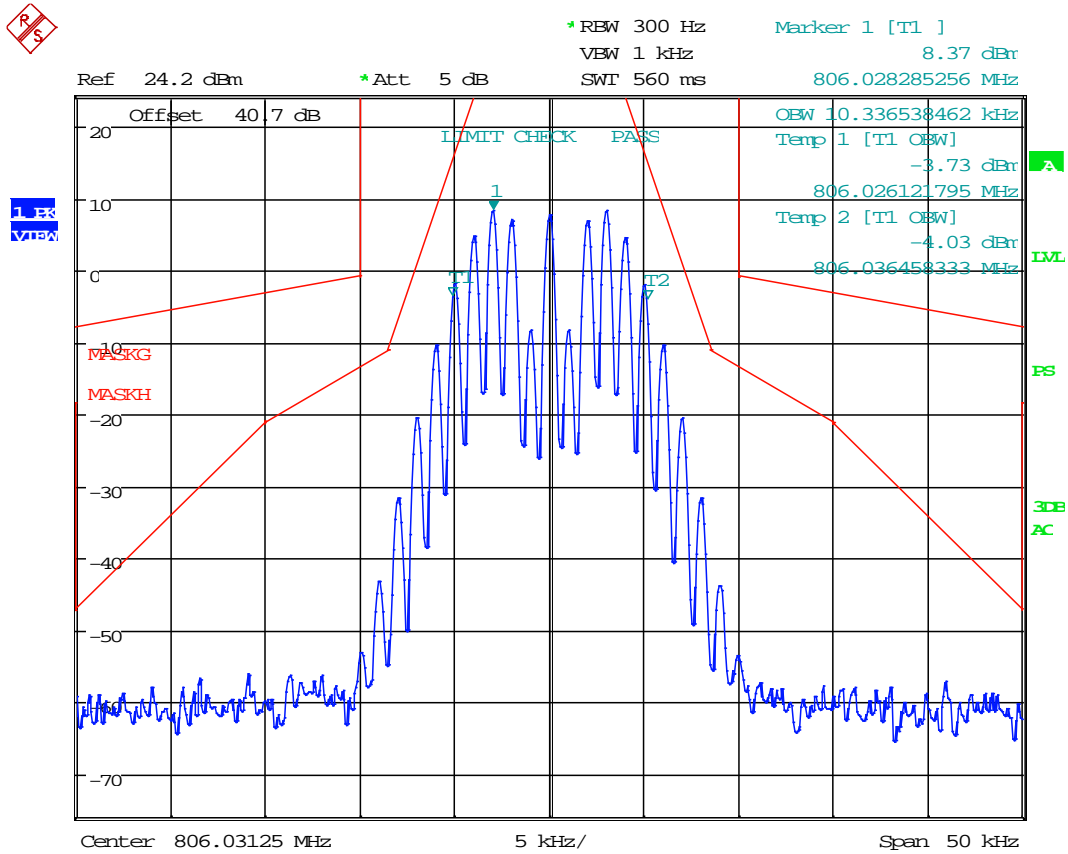

Date: 31.JUL.2019 11:40:55

RESULT: AGC Output Signal 99% OBW = 10.34 kHz

INPUT VS OUTPUT COMPARISON

Test Data: Uplink (806.03125 MHz), 16KOF3E Output Signal, @ AGC +3 dBm

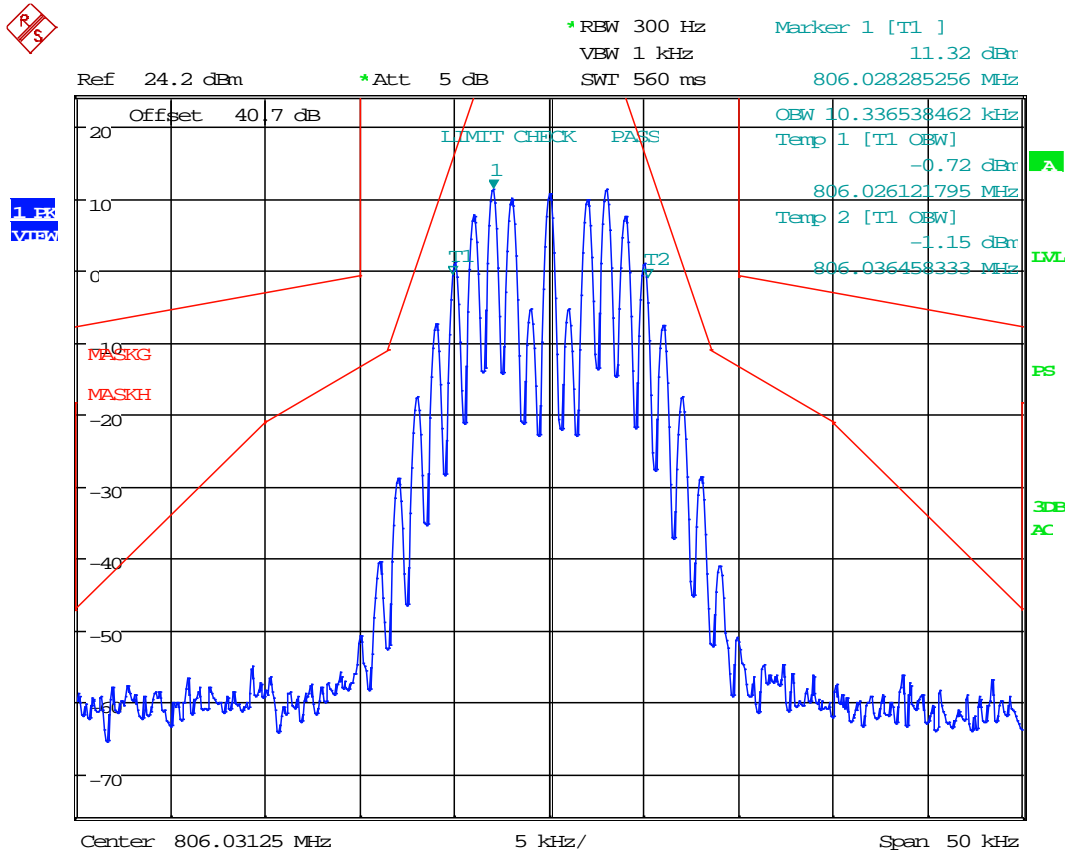

Date: 31.JUL.2019 11:41:24

RESULT: AGC+3 Output Signal 99% OBW = 10.34 kHz

INPUT VS OUTPUT COMPARISON

Test Data: Uplink (816.96875 MHz), 4K00F3E Output Signal, @ AGC

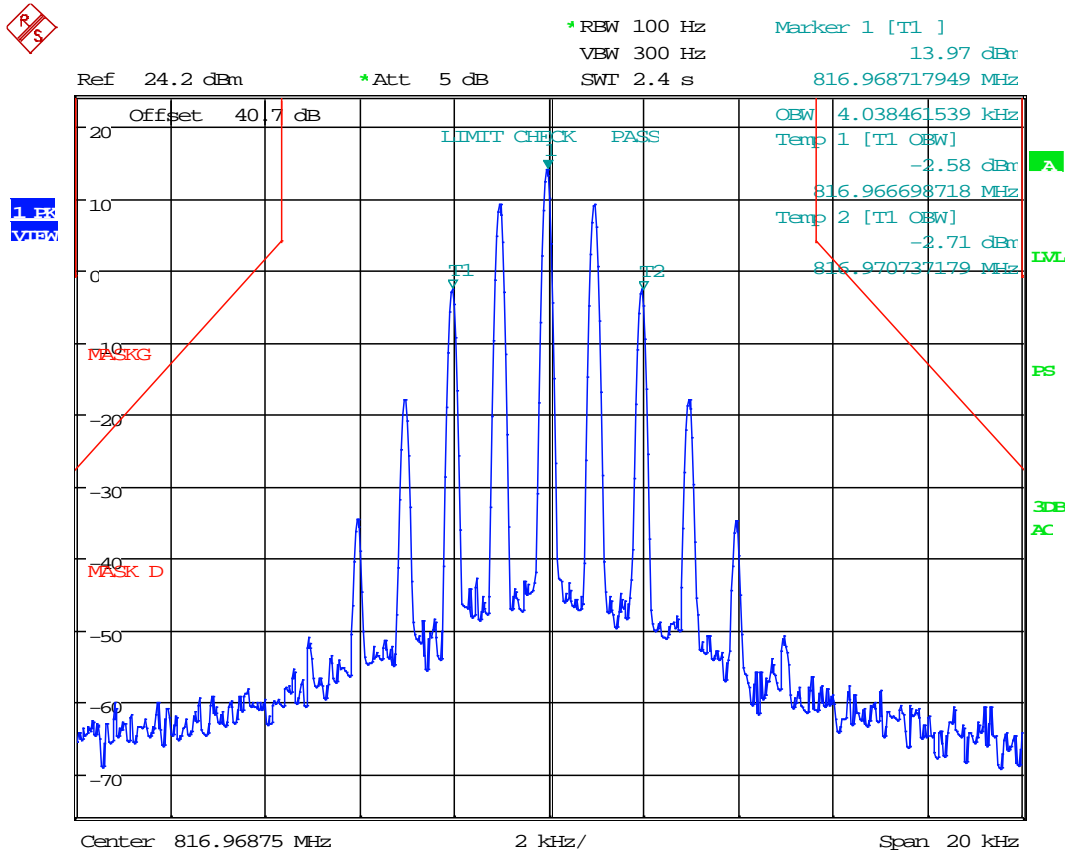

Date: 31.JUL.2019 11:11:17

RESULT: AGC Output Signal 99% OBW = 4.04 kHz

INPUT VS OUTPUT COMPARISON

Test Data: Uplink (816.96875 MHz), 4K00F3E Output Signal, @ AGC +3 dBm

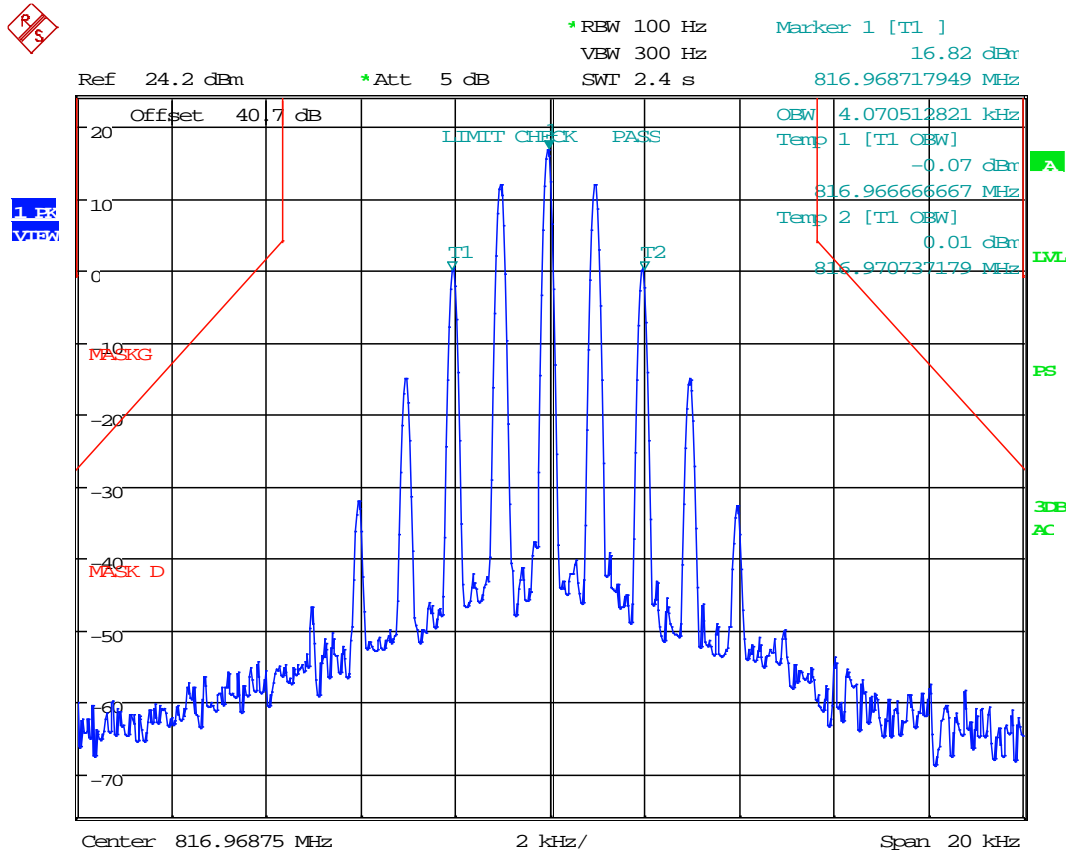

Date: 31.JUL.2019 11:12:23

RESULT: AGC+3 Output Signal 99% OBW = 4.07 kHz

INPUT VS OUTPUT COMPARISON

Test Data: Uplink (816.96875 MHz), 8K10F1E/F1D Output Signal, @ AGC

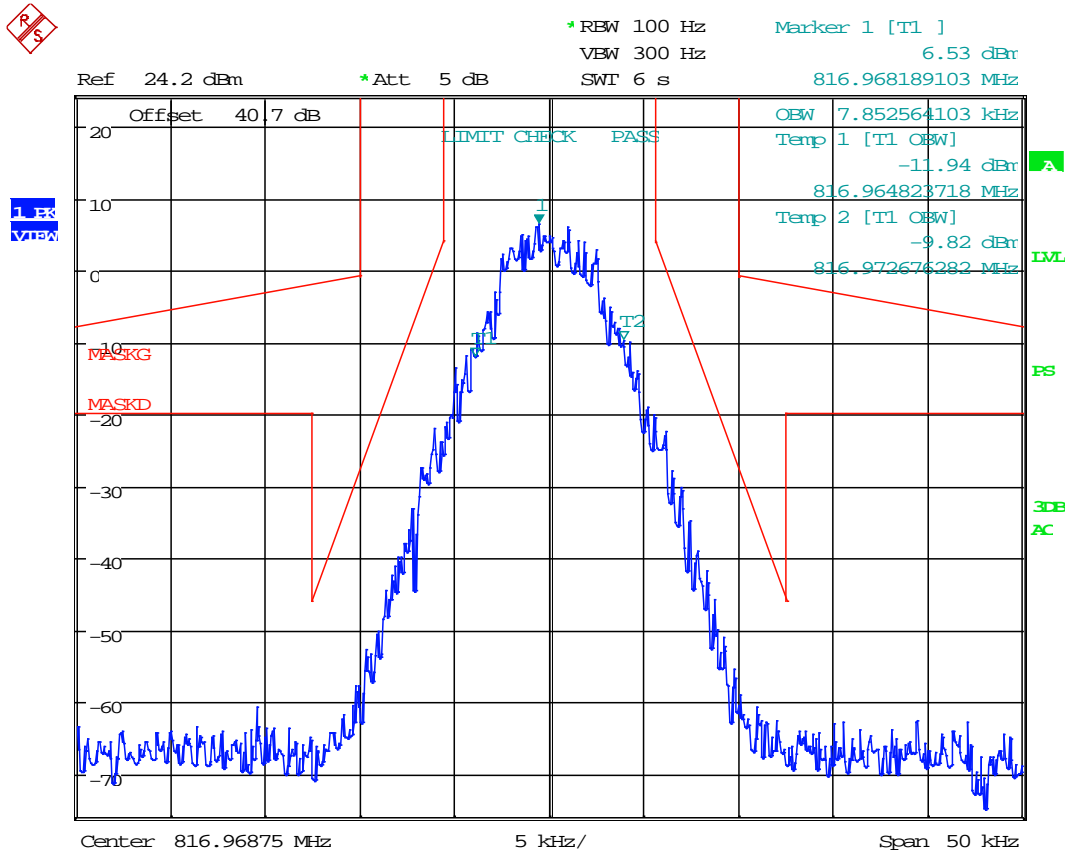

Date: 31.JUL.2019 11:17:31

RESULT: AGC Output Signal 99% OBW = 7.85 kHz

INPUT VS OUTPUT COMPARISON

Test Data: Uplink (816.96875 MHz), 8K10F1E/F1D Output Signal, @ AGC +3 dBm

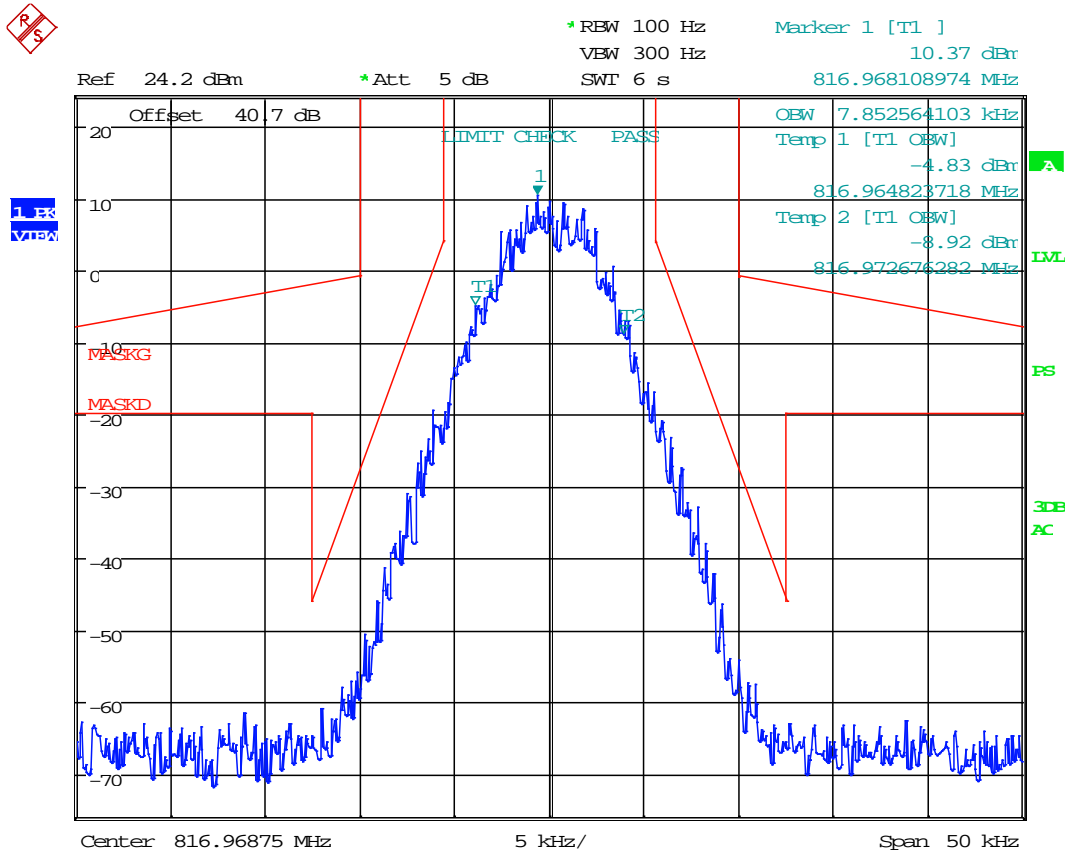

Date: 31.JUL.2019 11:18:01

RESULT: AGC+3 Output Signal 99% OBW = 7.85 kHz

INPUT VS OUTPUT COMPARISON

Test Data: Uplink (816.96875 MHz), 8K10F1W Output Signal, @ AGC

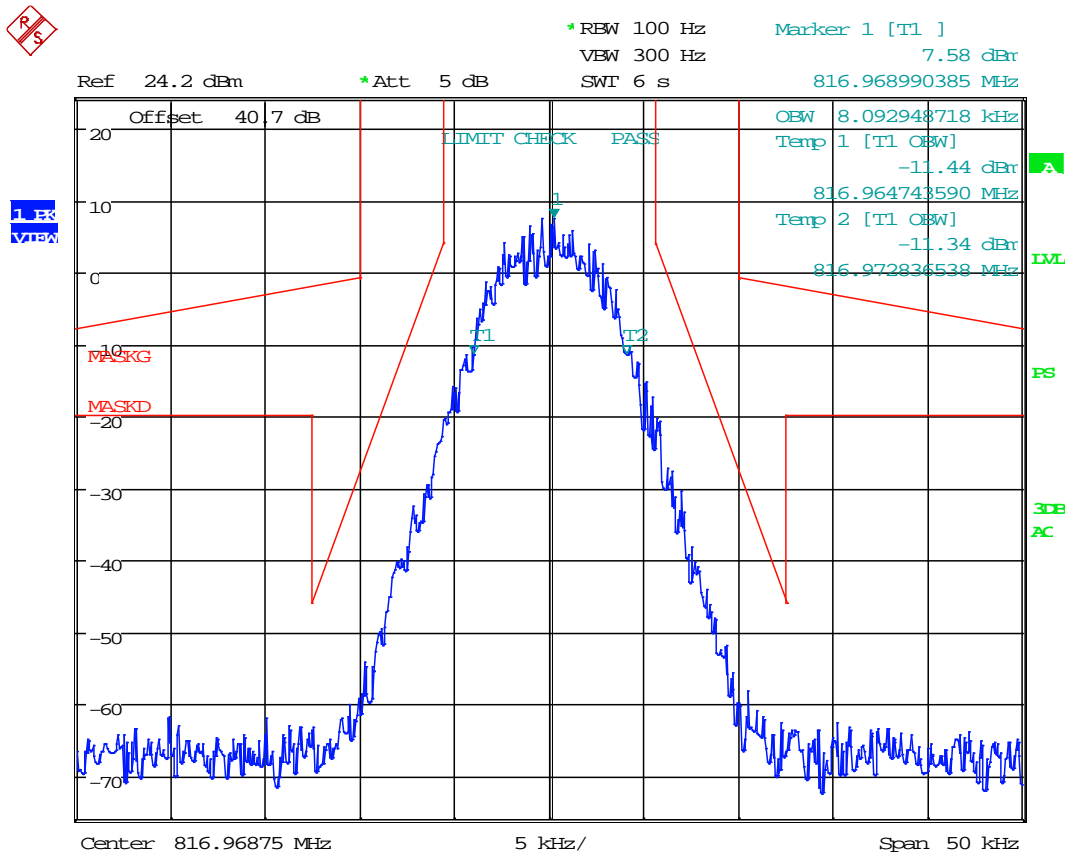

Date: 31.JUL.2019 11:18:39

RESULT: AGC Output Signal 99% OBW = 8.09 kHz

INPUT VS OUTPUT COMPARISON

Test Data: Uplink (816.96875 MHz), 8K10F1W Output Signal, @ AGC +3 dBm

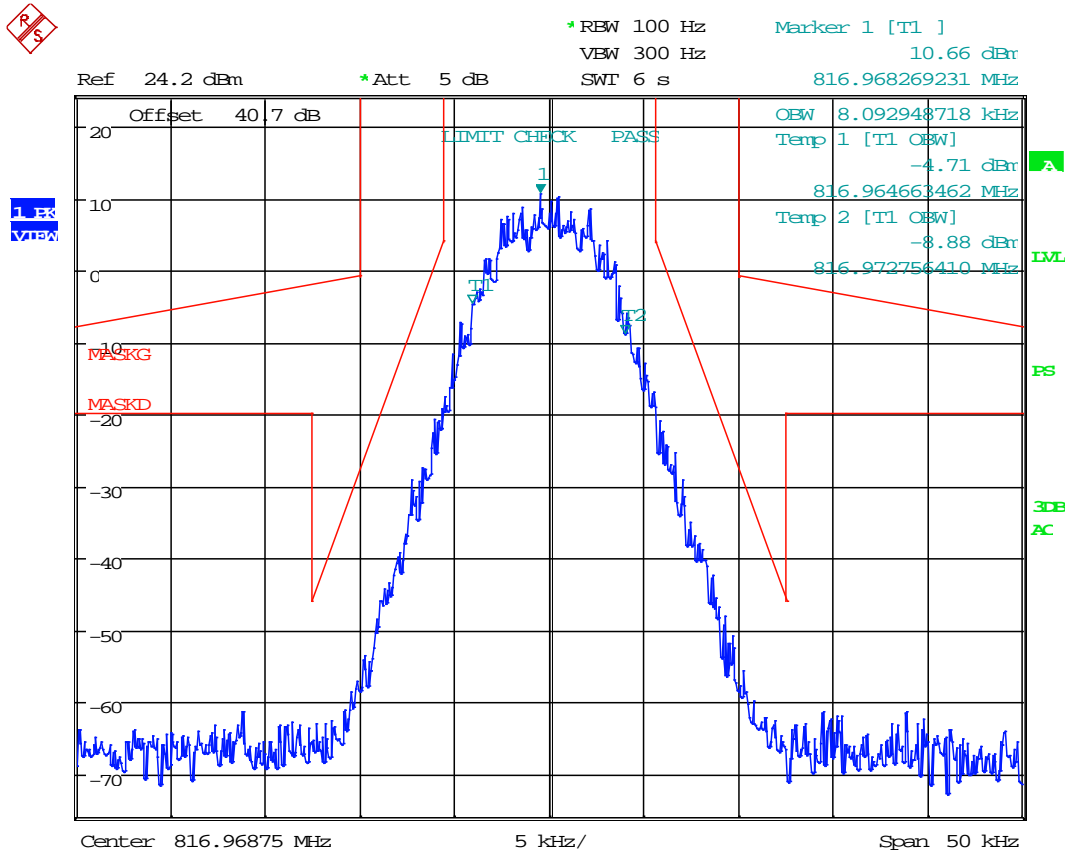

Date: 31.JUL.2019 11:19:11

RESULT: AGC+3 Output Signal 99% OBW = 8.09 kHz

INPUT VS OUTPUT COMPARISON

Test Data: Uplink (816.96875 MHz), 9K80F1E/F1D Output Signal, @ AGC

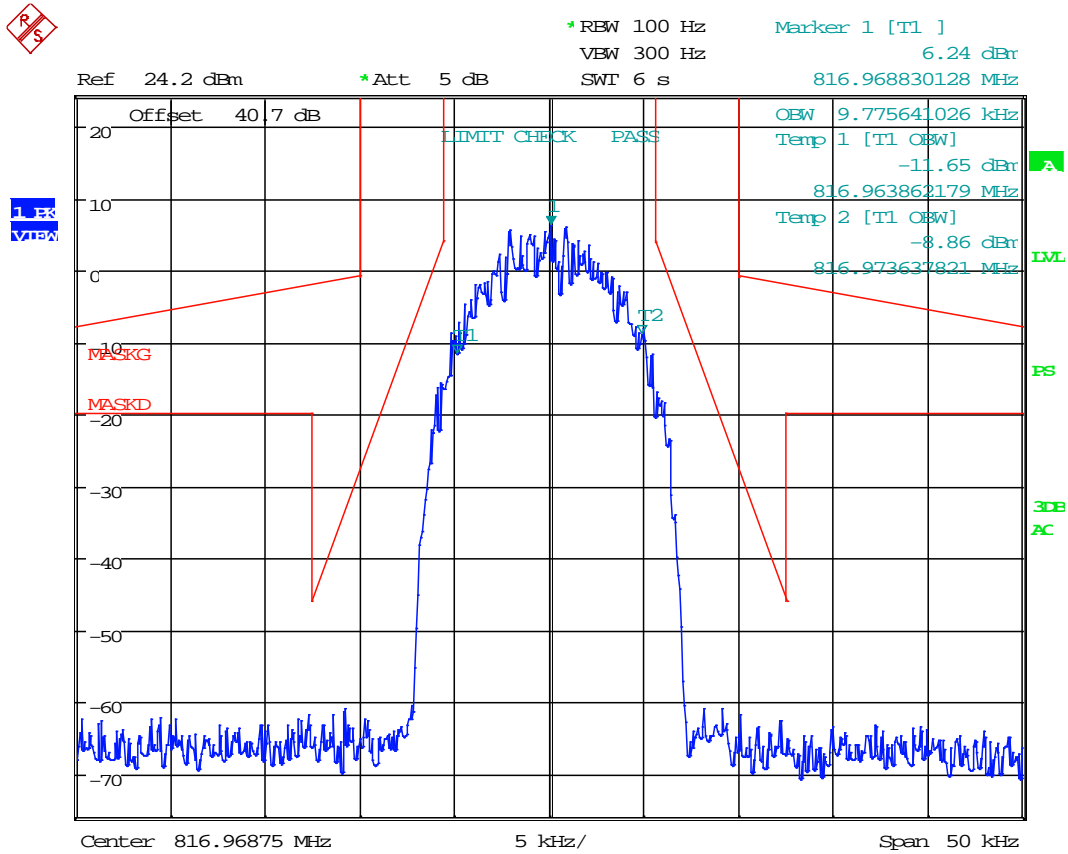

Date: 31.JUL.2019 11:19:50

RESULT: AGC Output Signal 99% OBW = 9.78 kHz

INPUT VS OUTPUT COMPARISON

Test Data: Uplink (816.96875 MHz), 9K80F1E/F1D Output Signal, @ AGC +3 dBm

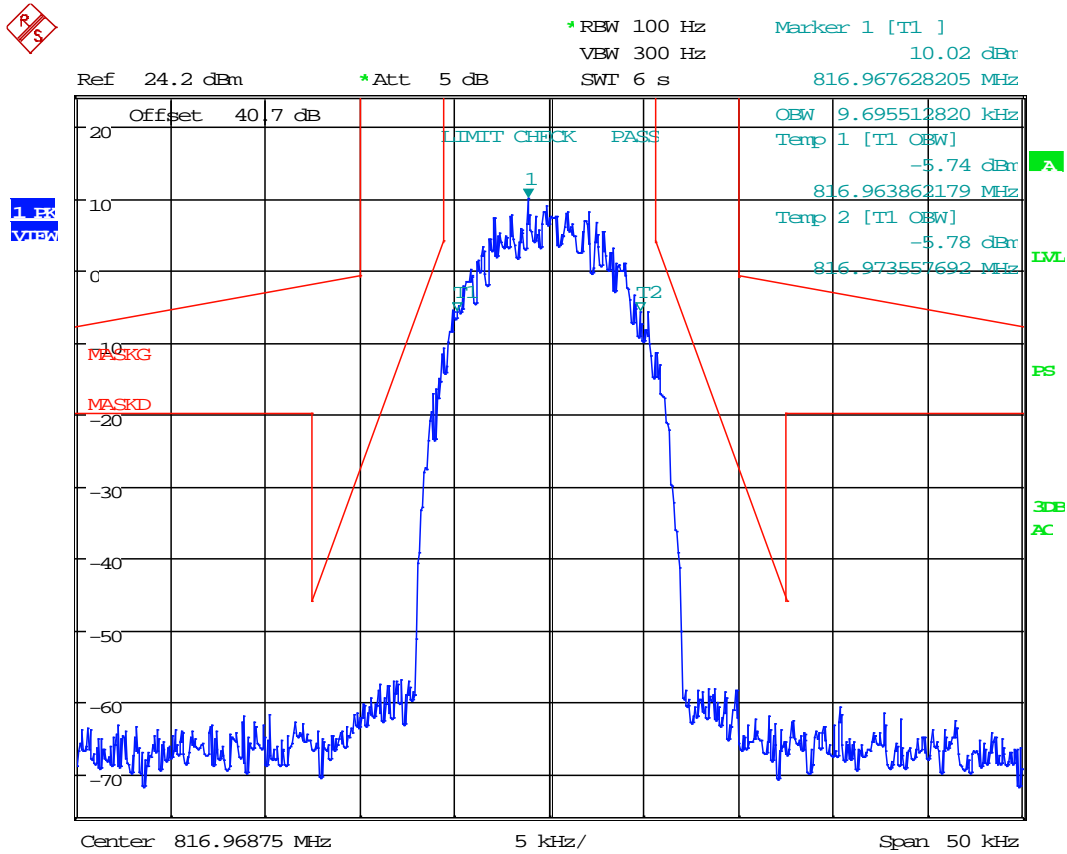

Date: 31.JUL.2019 11:20:21

RESULT: AGC+3 Output Signal 99% OBW = 9.70 kHz

INPUT VS OUTPUT COMPARISON

Test Data: Uplink (816.96875 MHz), 11K3F3E Output Signal, @ AGC

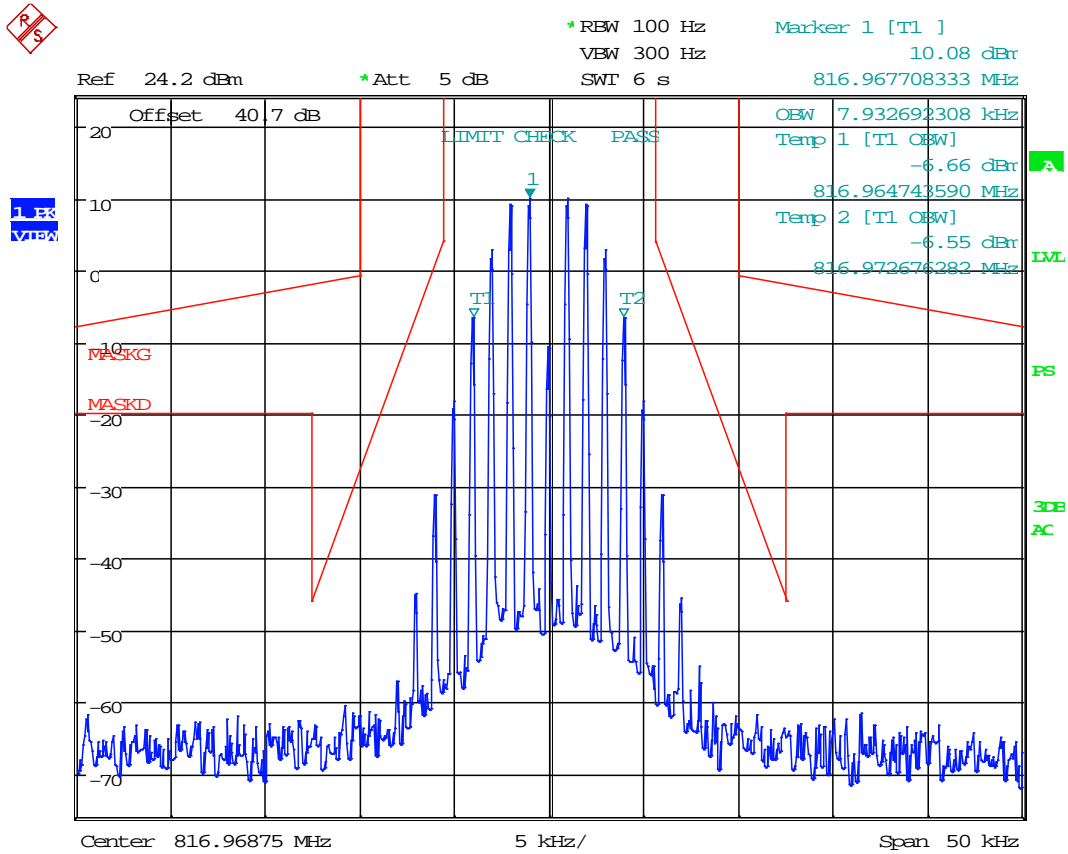

Date: 31.JUL.2019 11:15:50

RESULT: AGC Output Signal 99% OBW = 7.93 kHz

INPUT VS OUTPUT COMPARISON

Test Data: Uplink (816.96875 MHz), 11K3F3E Output Signal, @ AGC +3 dBm

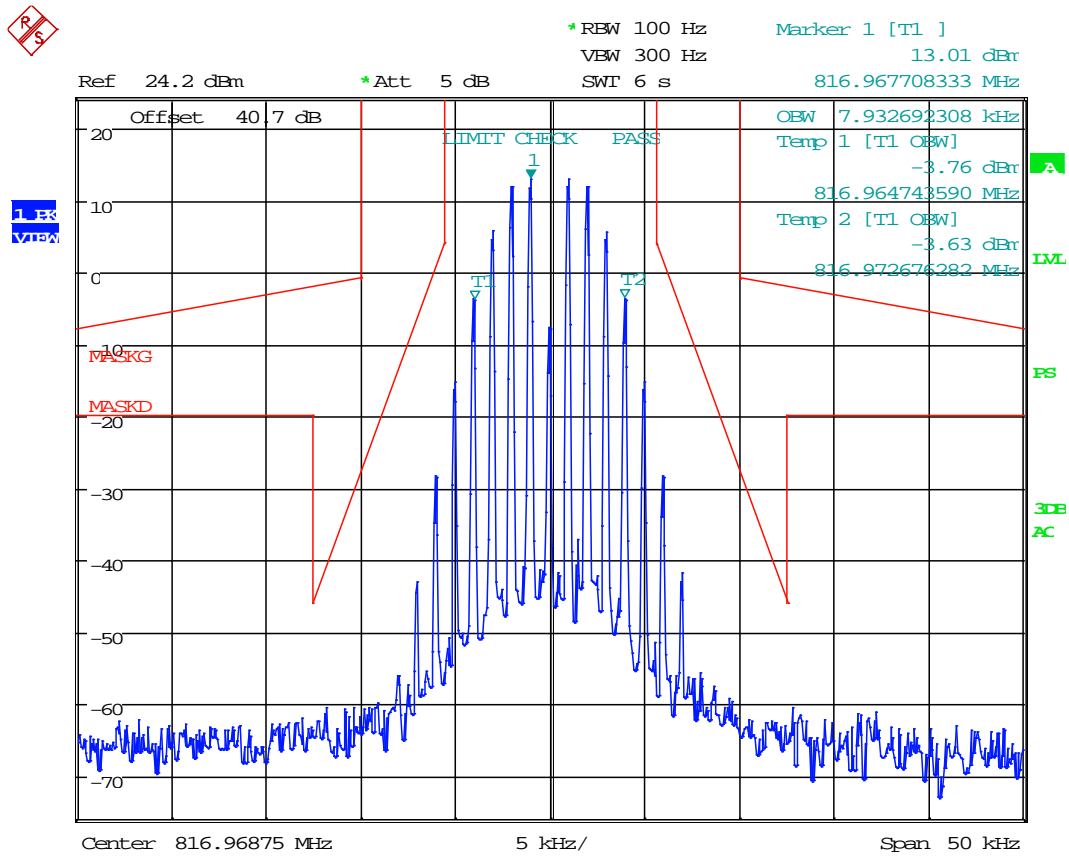

Date: 31.JUL.2019 11:16:35

RESULT: AGC+3 Output Signal 99% OBW = 7.93 kHz

INPUT VS OUTPUT COMPARISON

Test Data: Uplink (816.96875 MHz), 16KOF3E Output Signal, @ AGC

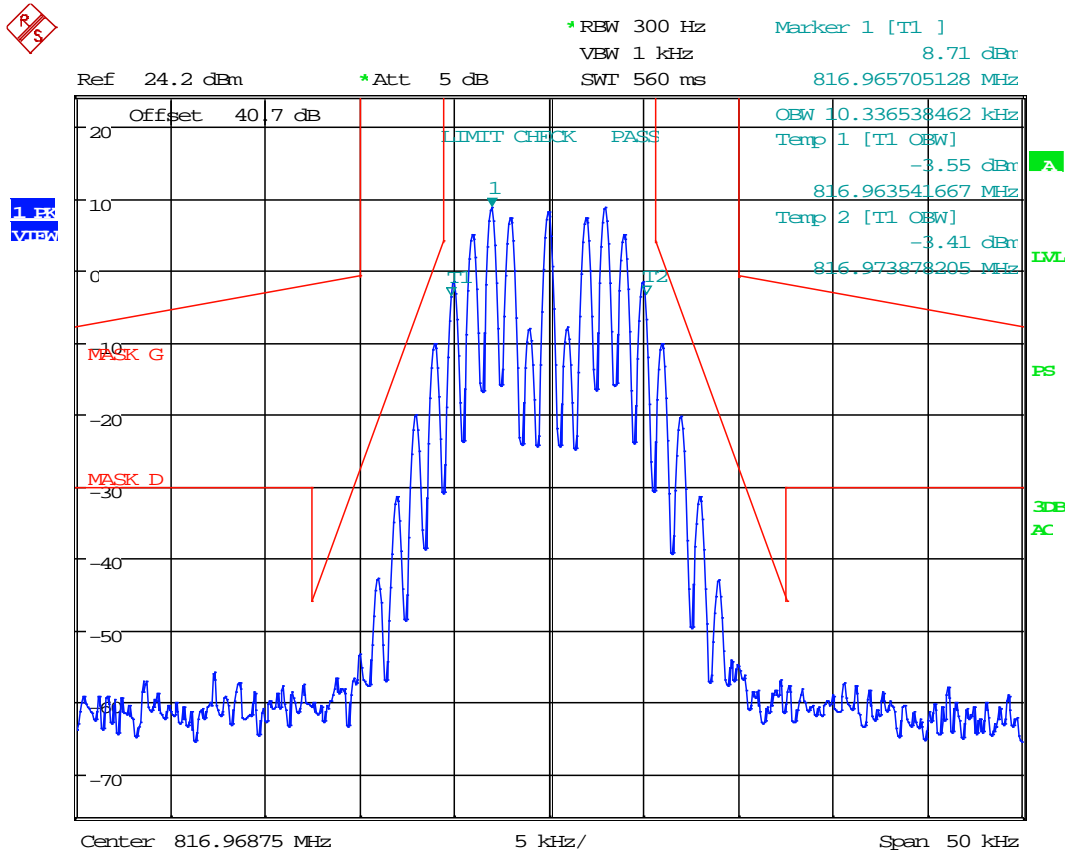

Date: 31.JUL.2019 11:22:09

RESULT: AGC Output Signal 99% OBW = 10.34 kHz

INPUT VS OUTPUT COMPARISON

Test Data: Uplink (816.96875 MHz), 16KOF3E Output Signal, @ AGC +3 dBm

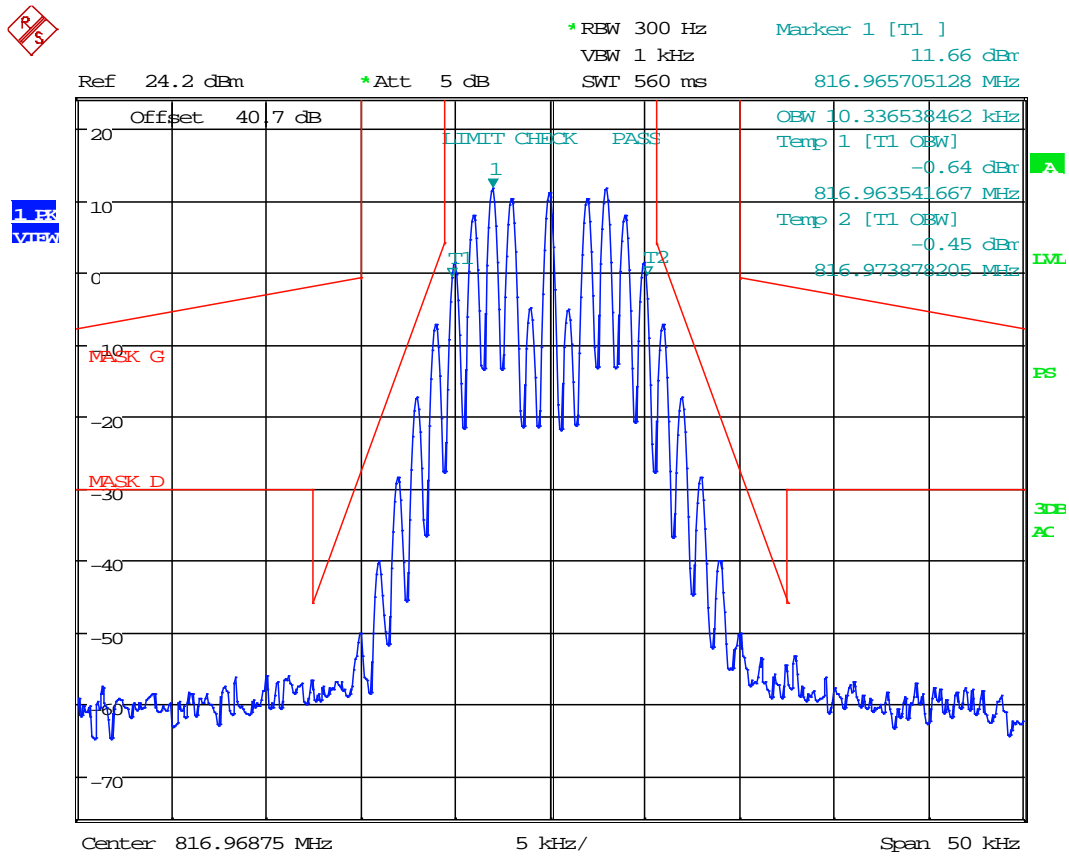

Date: 31.JUL.2019 11:22:34

RESULT: AGC+3 Output Signal 99% OBW = 10.34 kHz

INPUT VS OUTPUT COMPARISON

800 Band Downlink

Note: Select plots in this section display additional masks for compliance with RSS-119, via RSS-131 (Canada)

Test Data: Downlink (851.03125 MHz), 4K00F3E Output Signal, @ AGC

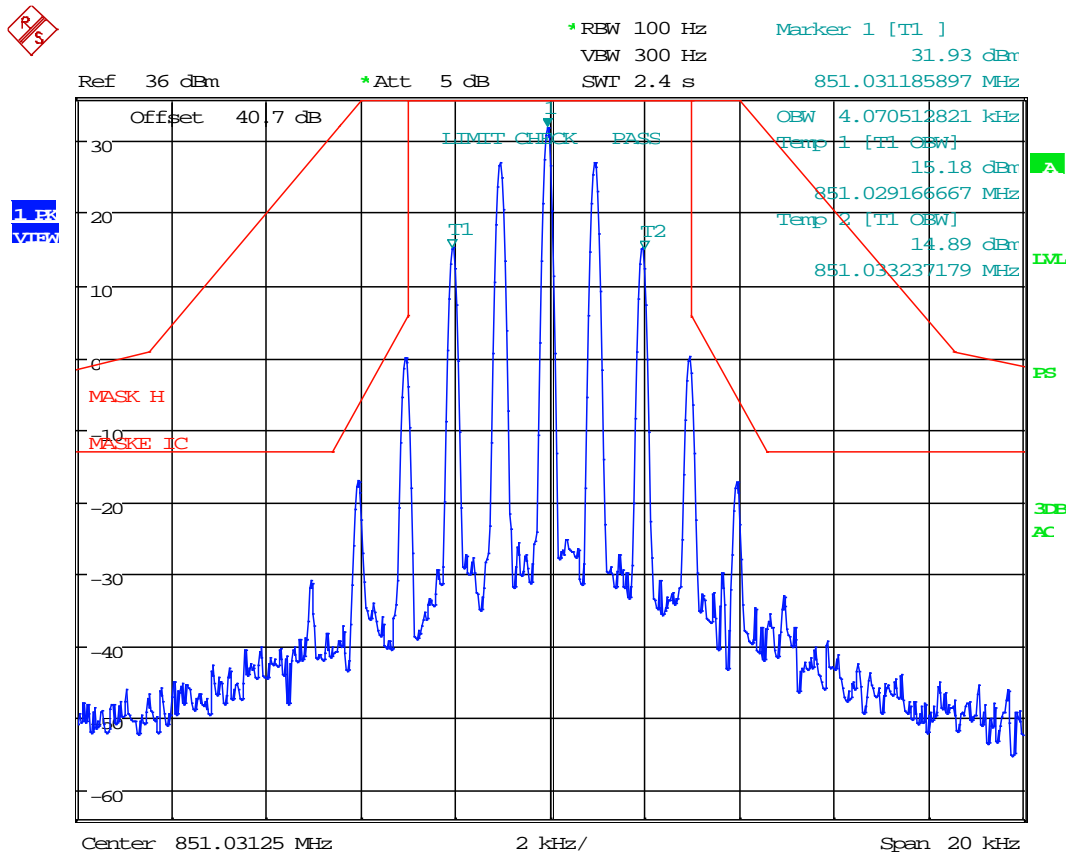

Date: 31.JUL.2019 16:19:30

RESULT: AGC Output Signal 99% OBW = 4.07 kHz

INPUT VS OUTPUT COMPARISON

Test Data: Downlink (851.03125 MHz), 4K00F3E Output Signal, @ AGC +3 dBm

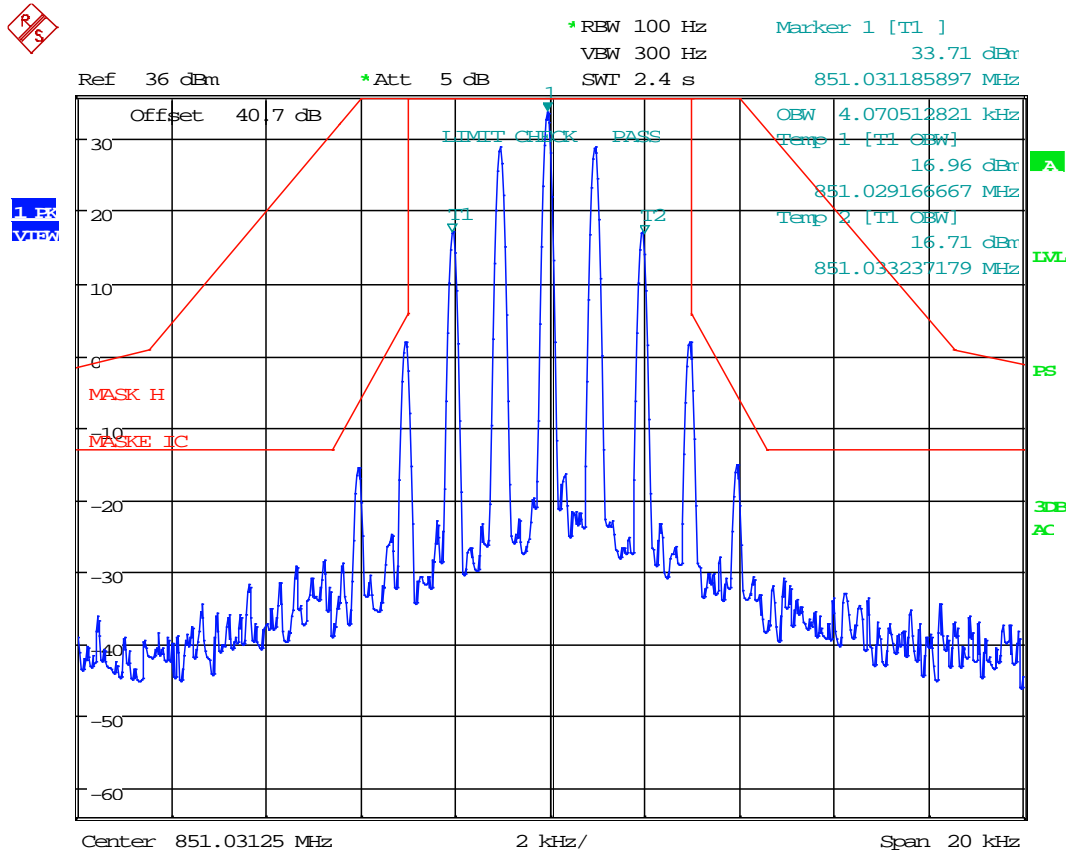

Date: 31.JUL.2019 16:20:22

RESULT: AGC+3 Output Signal 99% OBW = 4.07 kHz

INPUT VS OUTPUT COMPARISON

Test Data: Downlink (851.03125 MHz), 8K10F1E/F1D Output Signal, @ AGC

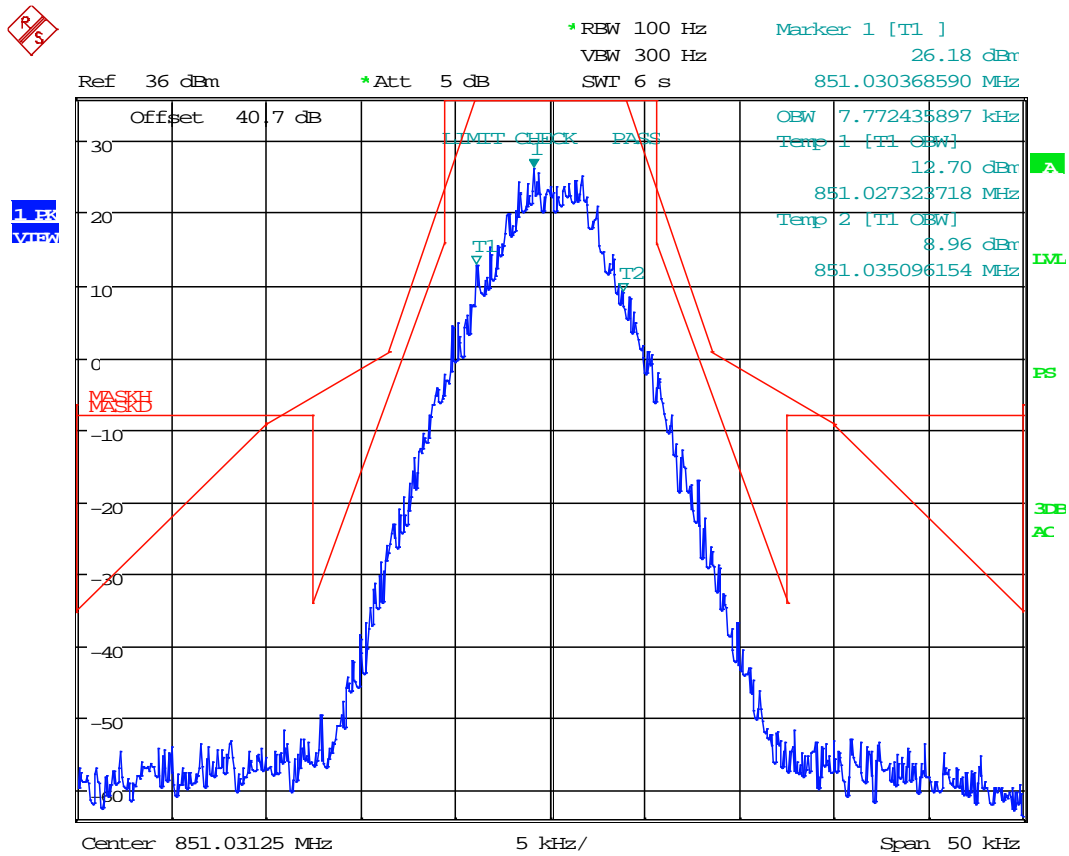

Date: 31.JUL.2019 16:30:23

RESULT: AGC Output Signal 99% OBW = 7.77 kHz

INPUT VS OUTPUT COMPARISON

Test Data: Downlink (851.03125 MHz), 8K10F1E/F1D Output Signal, @ AGC +3 dBm

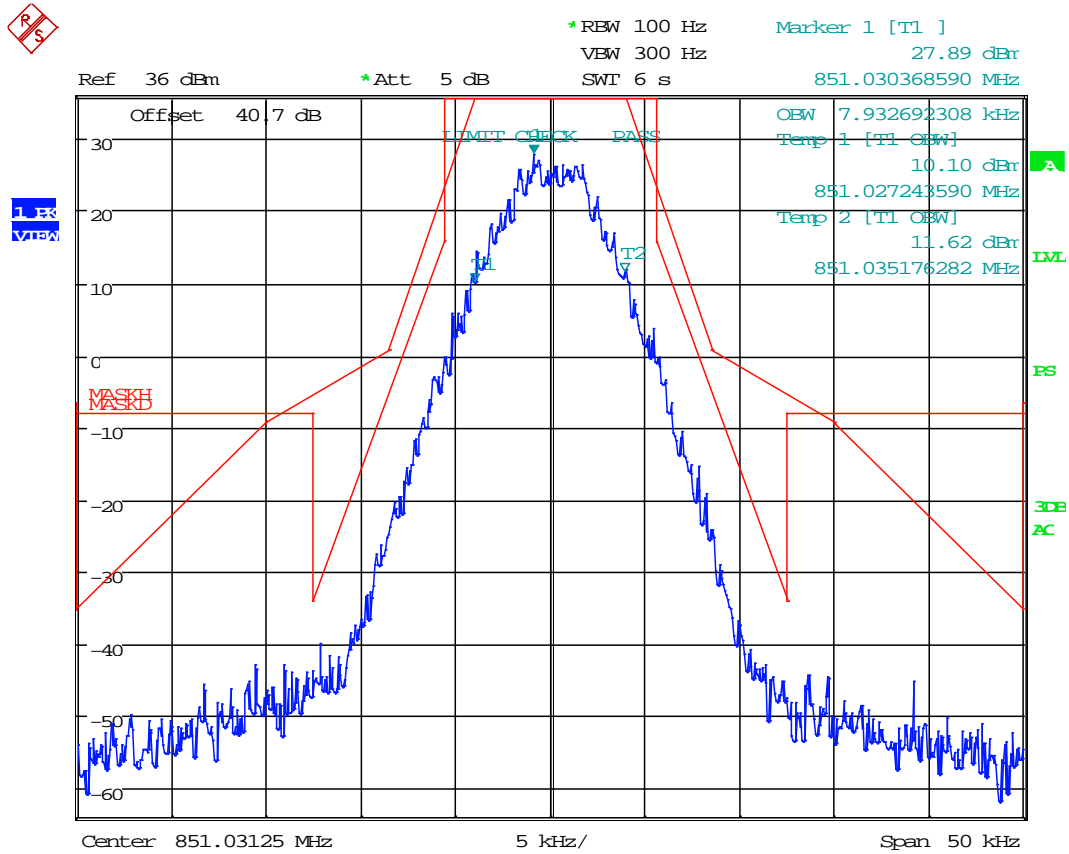

Date: 31.JUL.2019 16:31:27

RESULT: AGC+3 Output Signal 99% OBW = 7.93 kHz

INPUT VS OUTPUT COMPARISON

Test Data: Downlink (851.03125 MHz), 8K10F1W Output Signal, @ AGC

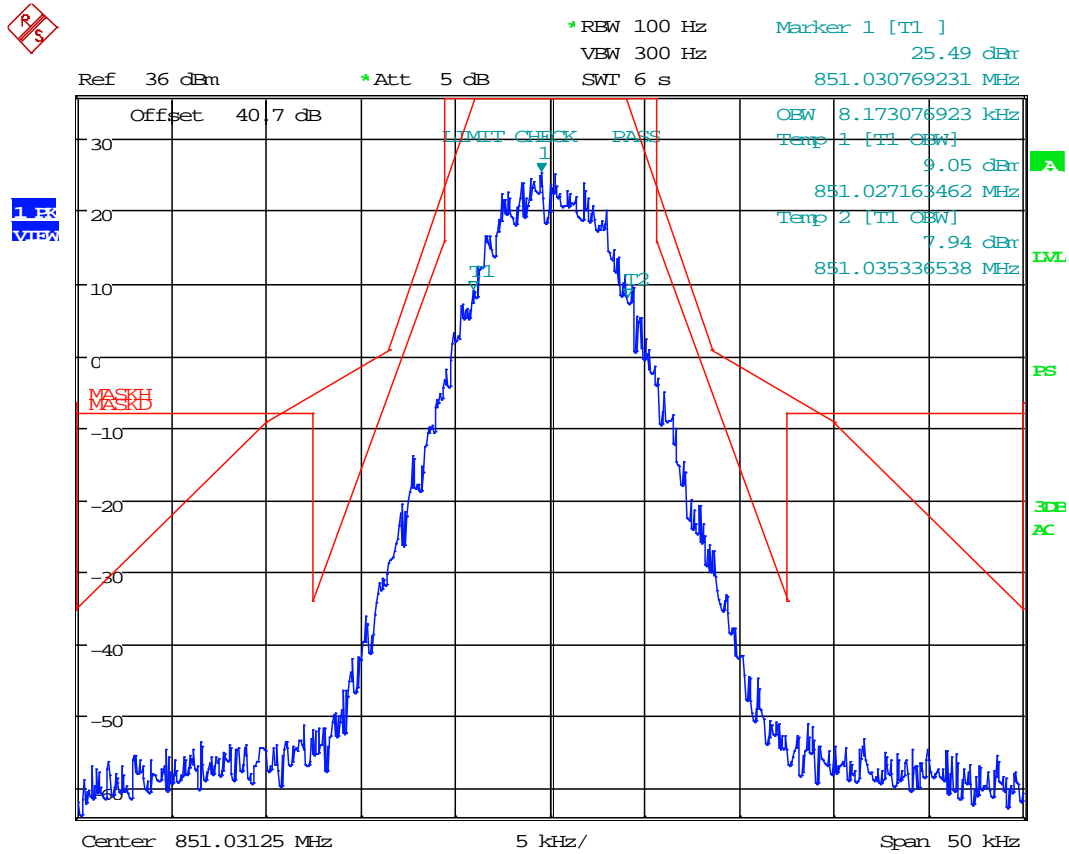

Date: 31.JUL.2019 16:26:55

RESULT: AGC Output Signal 99% OBW = 8.17 kHz

INPUT VS OUTPUT COMPARISON

Test Data: Downlink (851.03125 MHz), 8K10F1W Output Signal, @ AGC +3 dBm

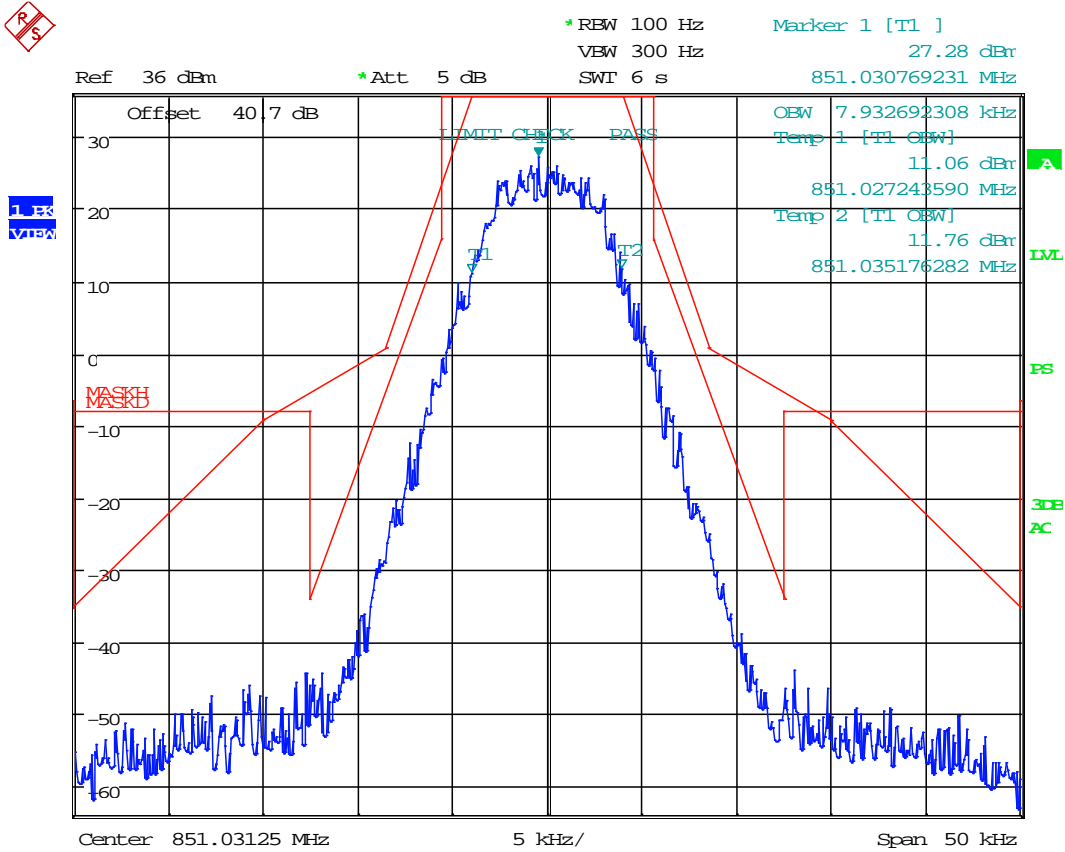

Date: 31.JUL.2019 16:29:04

RESULT: AGC+3 Output Signal 99% OBW = 7.93 kHz

INPUT VS OUTPUT COMPARISON

Test Data: Downlink (851.03125 MHz), 9K80F1E/F1D Output Signal, @ AGC

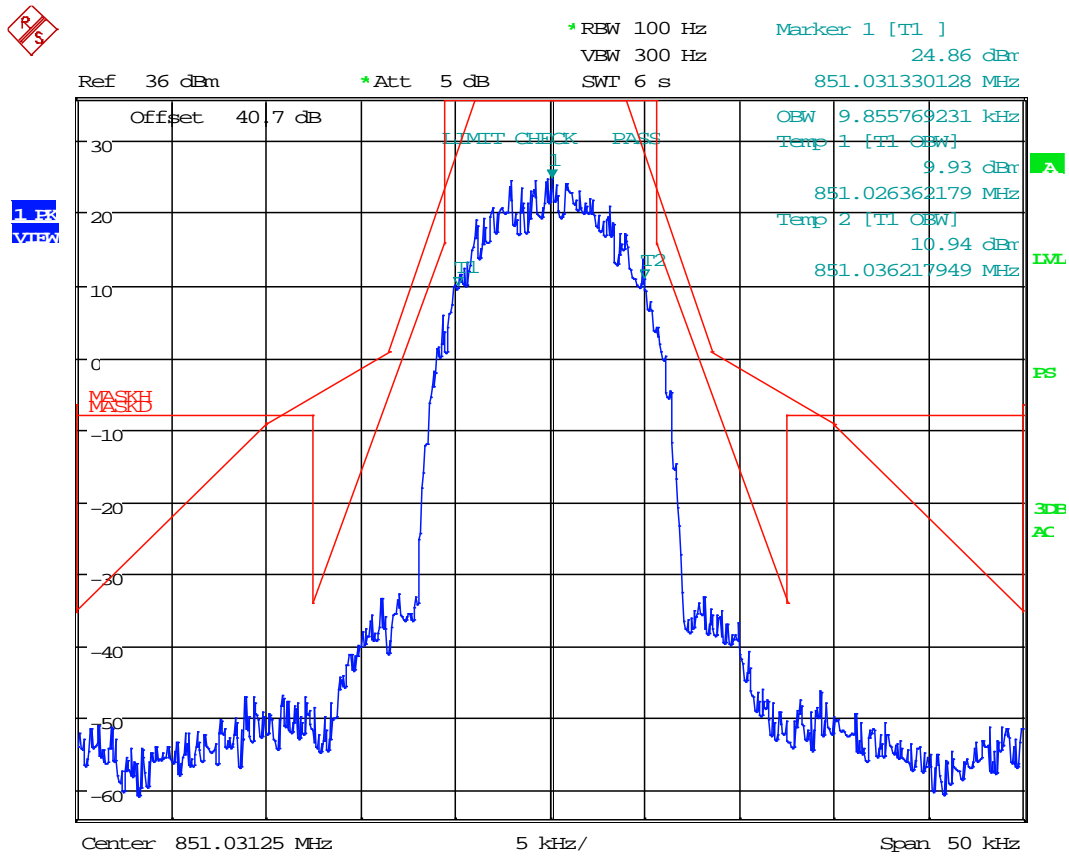

Date: 31.JUL.2019 16:23:53

RESULT: AGC Output Signal 99% OBW = 9.86 kHz

INPUT VS OUTPUT COMPARISON

Test Data: Downlink (851.03125 MHz), 9K80F1E/F1D Output Signal, @ AGC +3 dBm

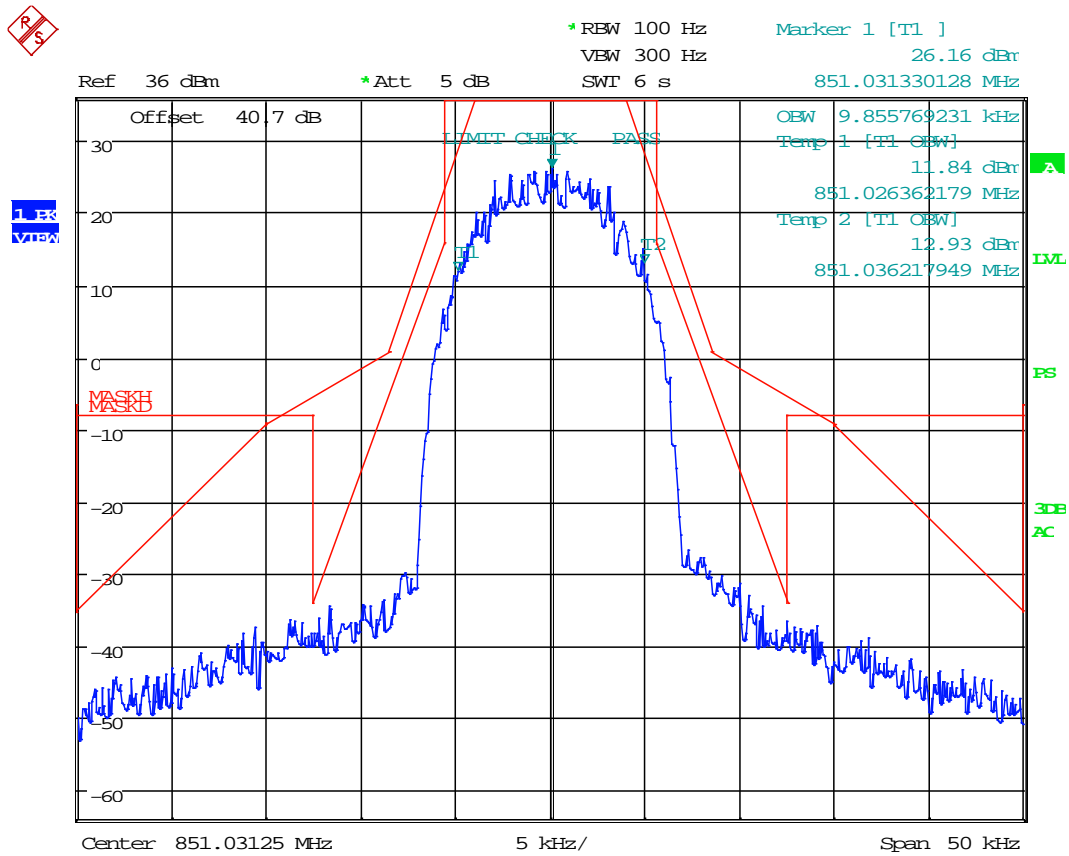

Date: 31.JUL.2019 16:25:53

RESULT: AGC+3 Output Signal 99% OBW = 9.86 kHz

INPUT VS OUTPUT COMPARISON

Test Data: Downlink (851.03125 MHz), 11K3F3E Output Signal, @ AGC

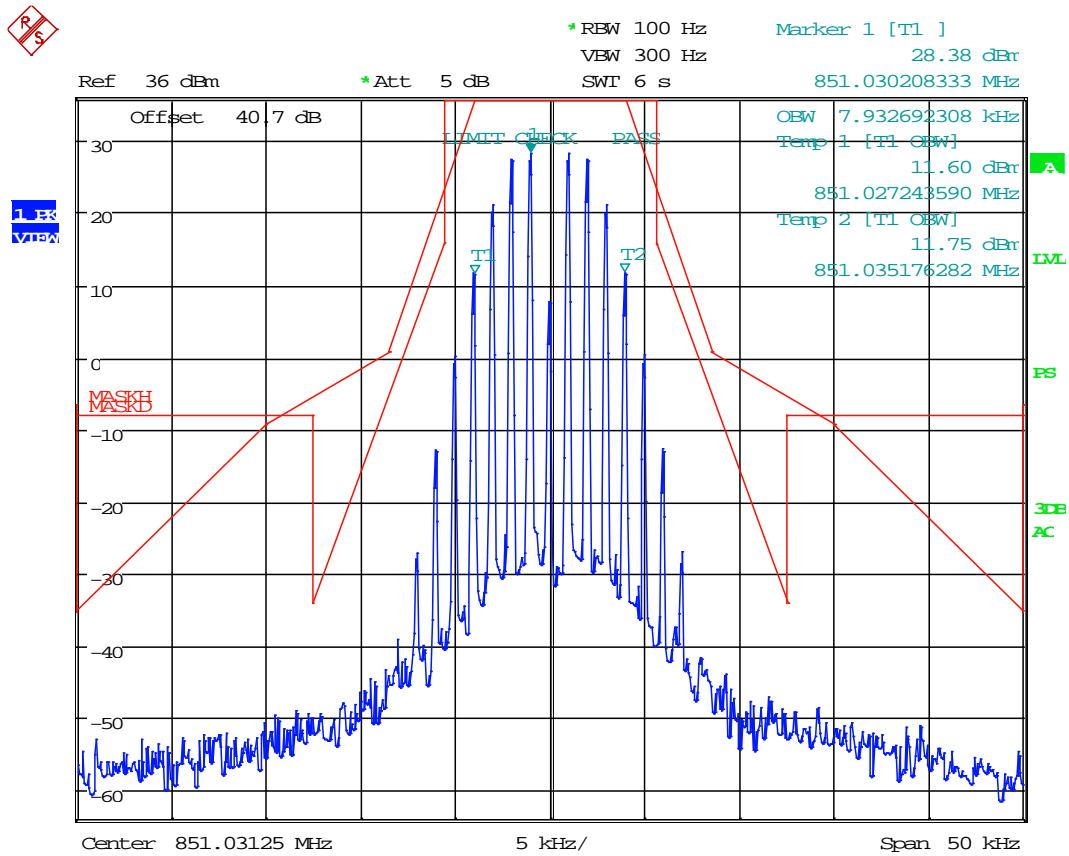

Date: 31.JUL.2019 16:21:46

RESULT: AGC Output Signal 99% OBW = 7.93 kHz

INPUT VS OUTPUT COMPARISON

Test Data: Downlink (851.03125 MHz), 11K3F3E Output Signal, @ AGC +3 dBm

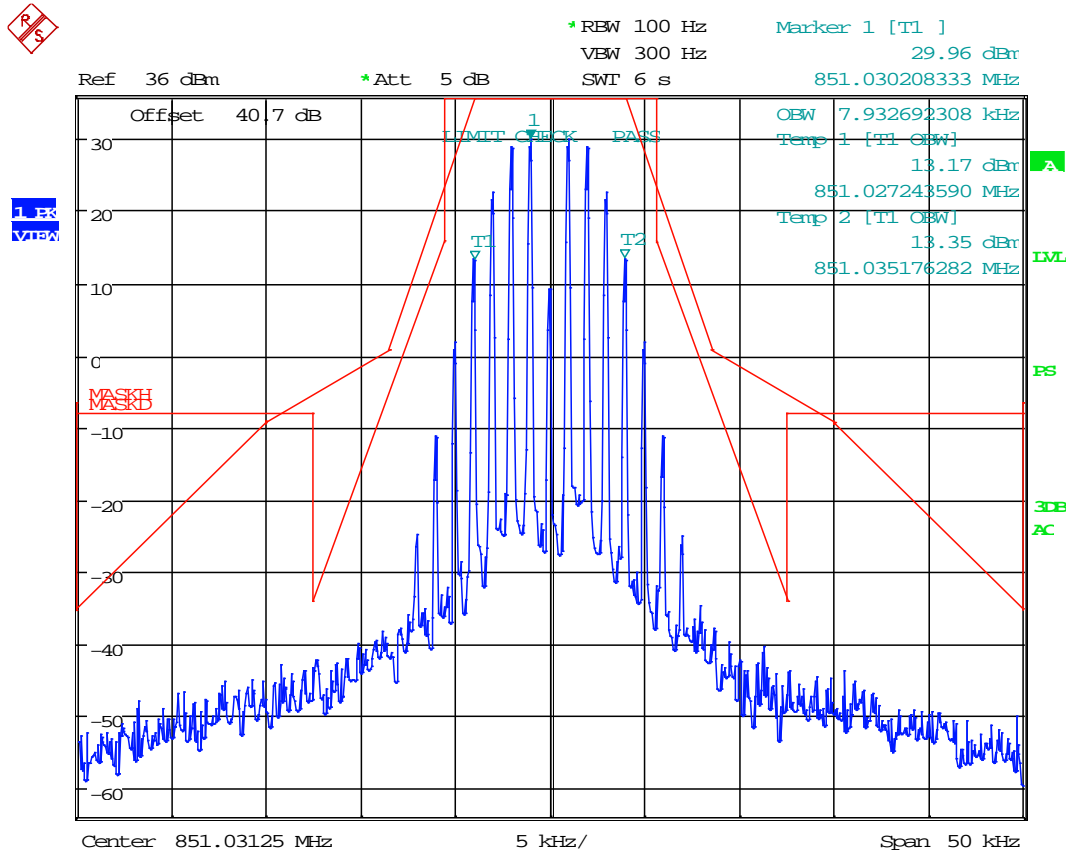

Date: 31.JUL.2019 16:22:35

RESULT: AGC+3 Output Signal 99% OBW = 7.93 kHz

INPUT VS OUTPUT COMPARISON

Test Data: Downlink (851.03125 MHz), 16K0F3E Output Signal, @ AGC

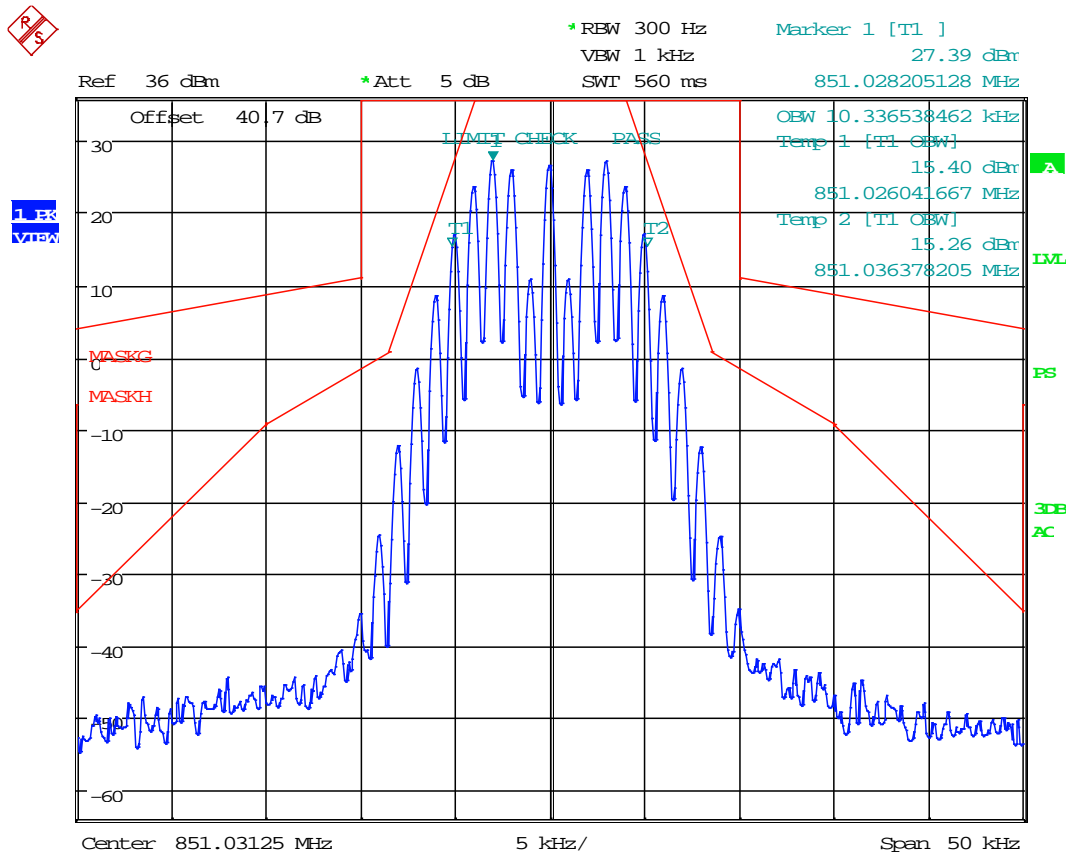

Date: 31.JUL.2019 16:36:25

RESULT: AGC Output Signal 99% OBW = 10.34 kHz

INPUT VS OUTPUT COMPARISON

Test Data: Downlink (851.03125 MHz), 16K0F3E Output Signal, @ AGC +3 dBm

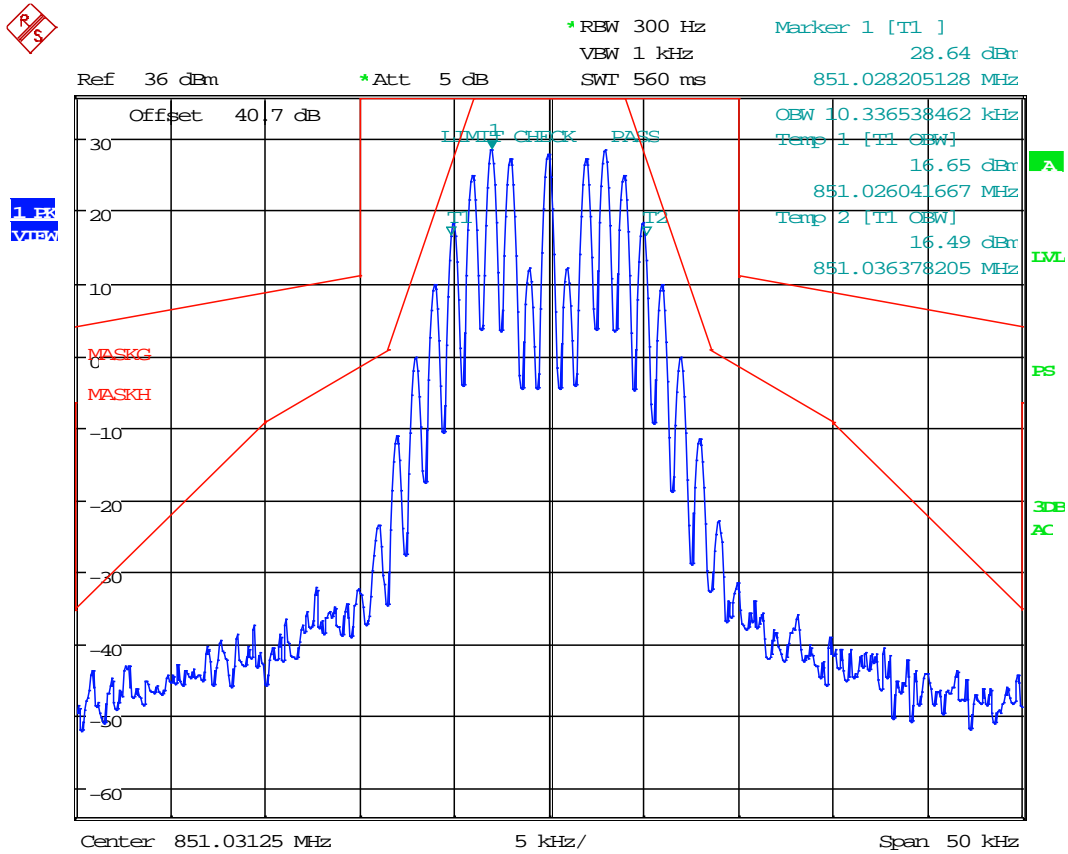

Date: 31.JUL.2019 16:37:02

RESULT: AGC+3 Output Signal 99% OBW = 10.34 kHz

INPUT VS OUTPUT COMPARISON

Test Data: Downlink (861.96875 MHz), 4K00F3E Output Signal, @ AGC

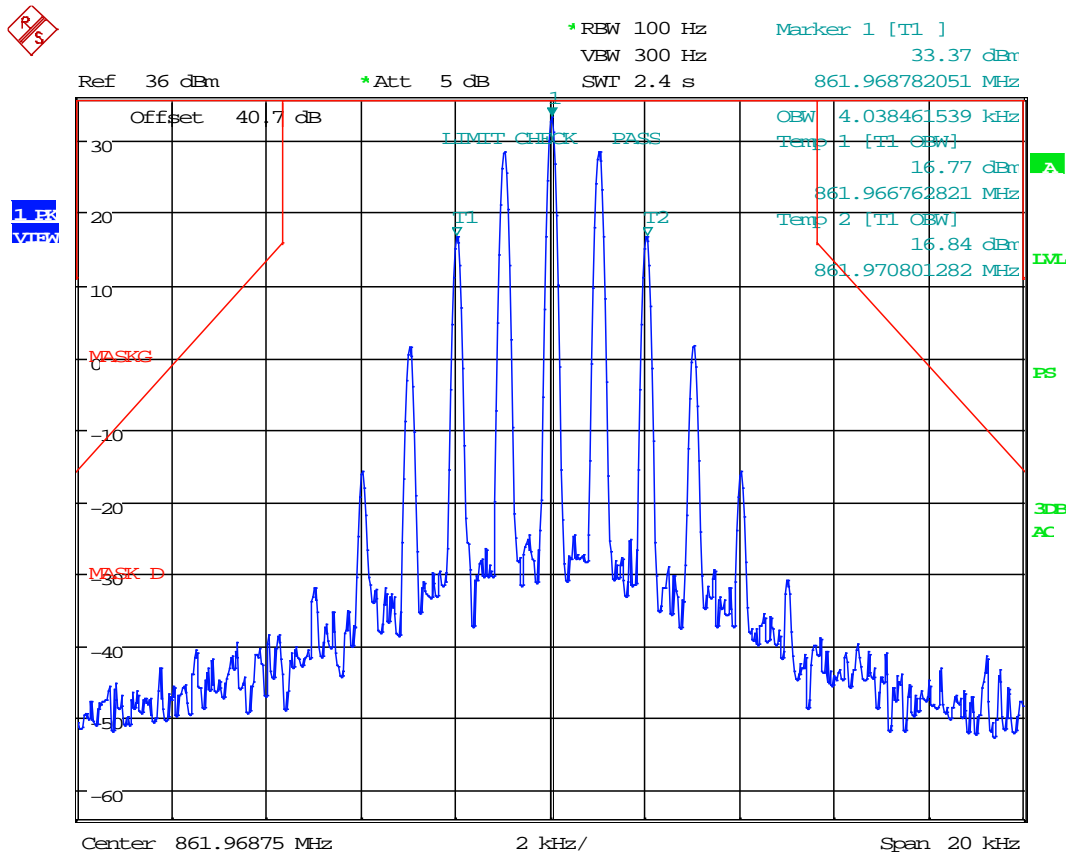

Date: 31.JUL.2019 16:03:57

RESULT: AGC Output Signal 99% OBW = 4.04 kHz

INPUT VS OUTPUT COMPARISON

Test Data: Downlink (861.96875 MHz), 4K00F3E Output Signal, @ AGC +3 dBm

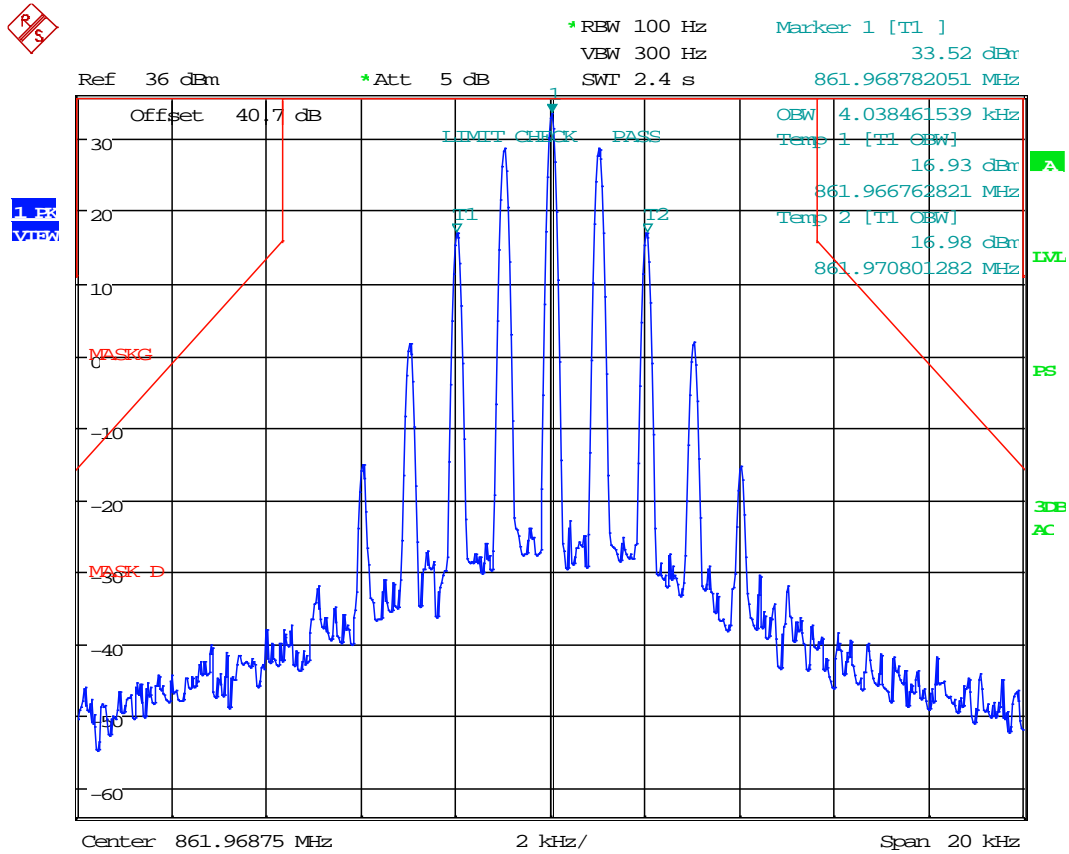

Date: 31.JUL.2019 16:05:03

RESULT: AGC+3 Output Signal 99% OBW = 4.04 kHz

INPUT VS OUTPUT COMPARISON

Test Data: Downlink (861.96875 MHz), 8K10F1E/F1D Output Signal, @ AGC

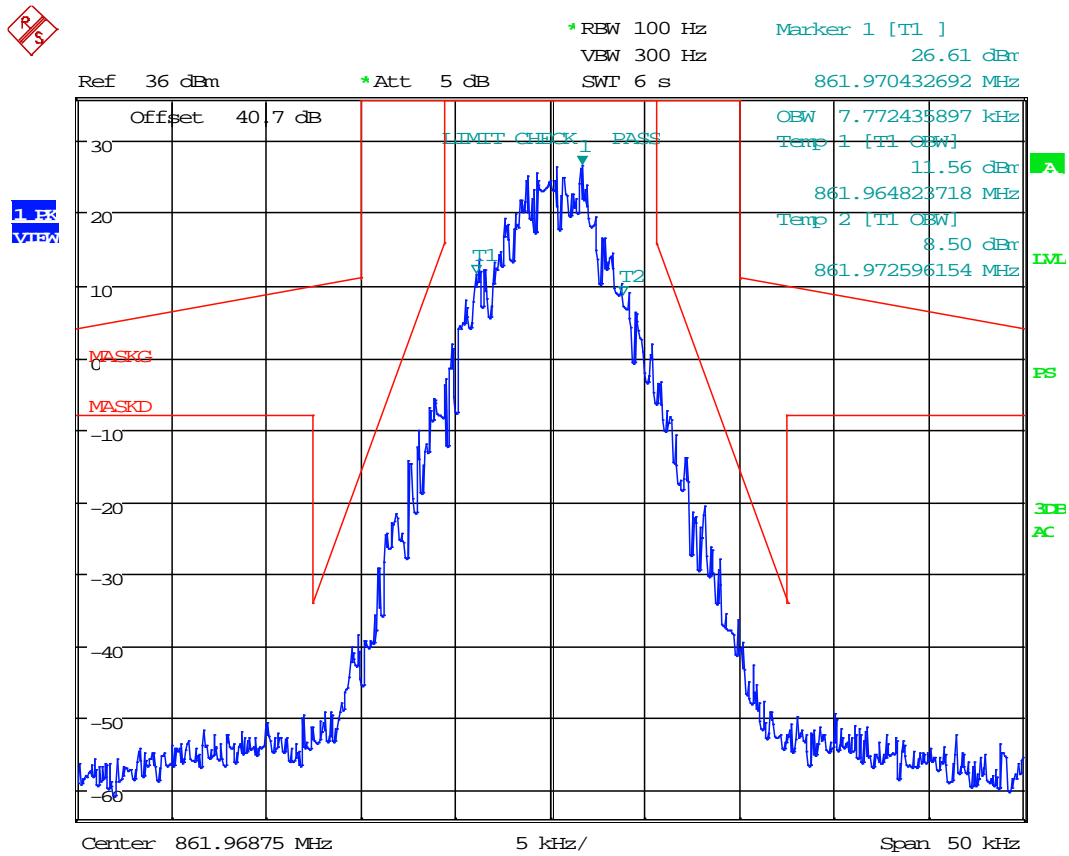

Date: 31.JUL.2019 16:08:34

RESULT: AGC Output Signal 99% OBW = 7.77 kHz

INPUT VS OUTPUT COMPARISON

Test Data: Downlink (861.96875 MHz), 8K10F1E/F1D Output Signal, @ AGC +3 dBm

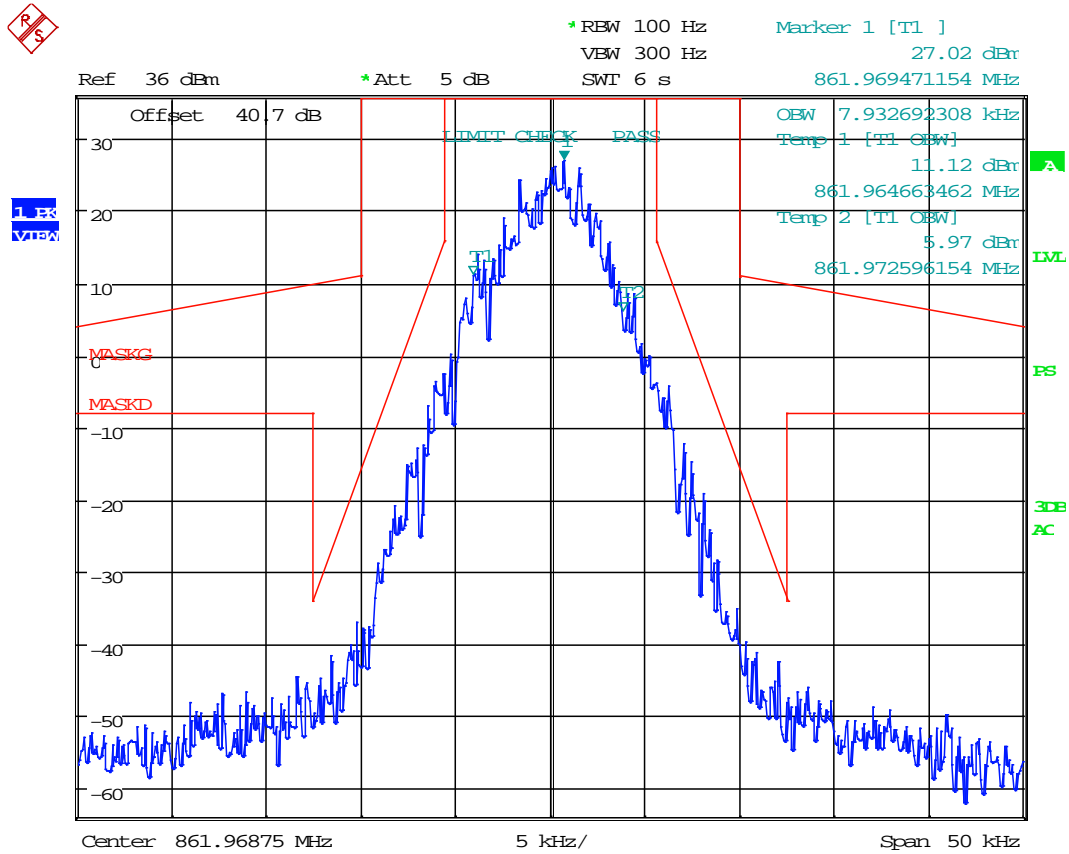

Date: 31.JUL.2019 16:09:20

RESULT: AGC+3 Output Signal 99% OBW = 7.93 kHz

INPUT VS OUTPUT COMPARISON

Test Data: Downlink (861.96875 MHz), 8K10F1W Output Signal, @ AGC

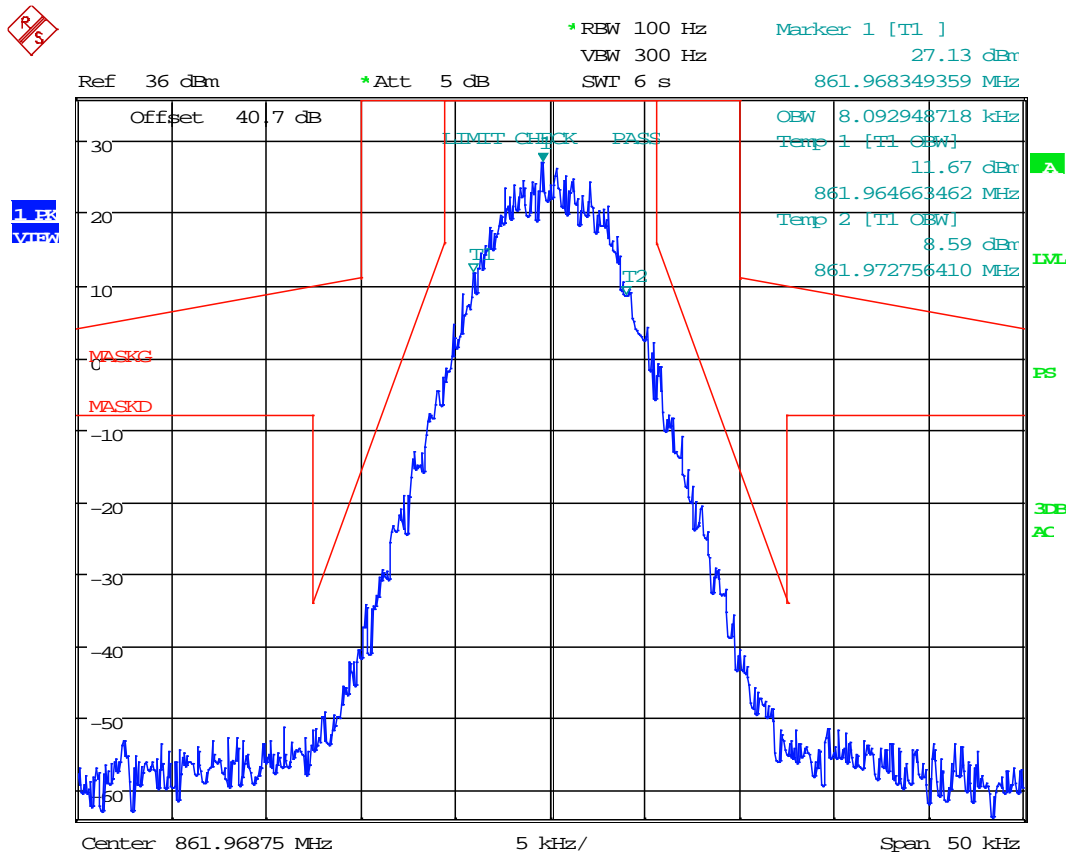

Date: 31.JUL.2019 16:11:03

RESULT: AGC Output Signal 99% OBW = 8.09 kHz

INPUT VS OUTPUT COMPARISON

Test Data: Downlink (861.96875 MHz), 8K10F1W Output Signal, @ AGC +3 dBm

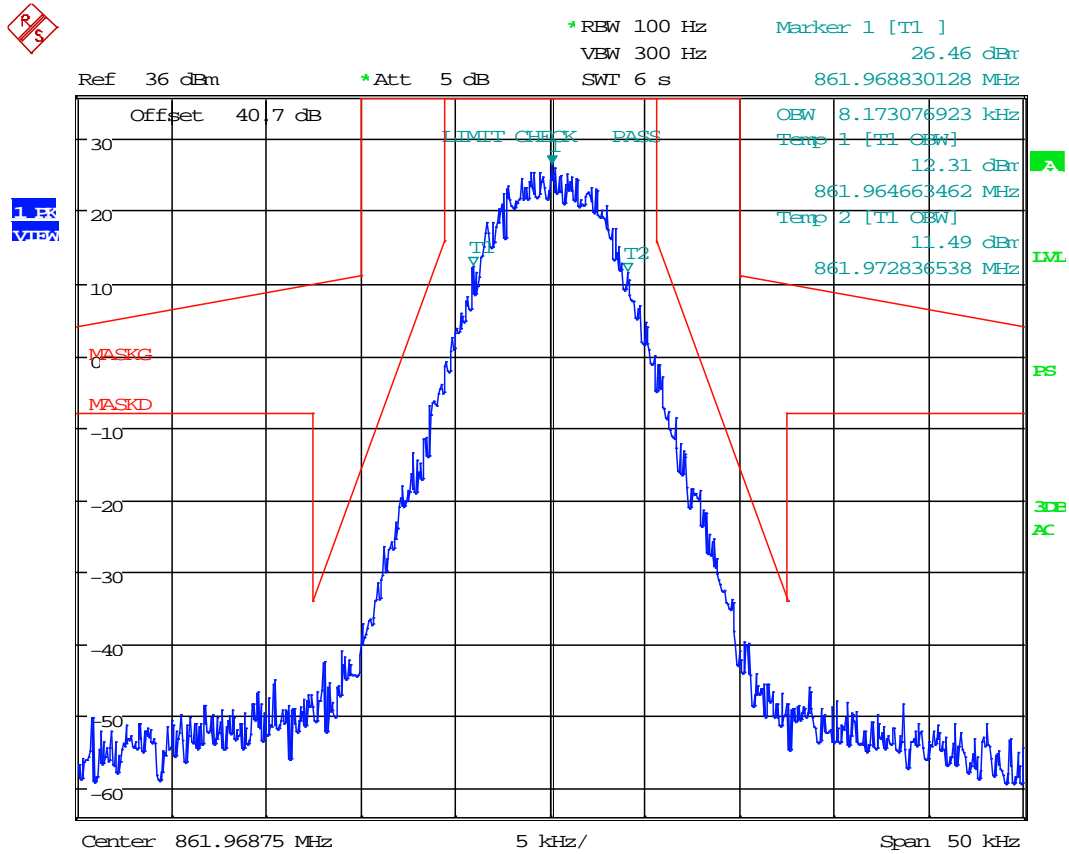

Date: 31.JUL.2019 16:11:47

RESULT: AGC+3 Output Signal 99% OBW = 8.17 kHz

INPUT VS OUTPUT COMPARISON

Test Data: Downlink (861.96875 MHz), 9K80F1E/F1D Output Signal, @ AGC

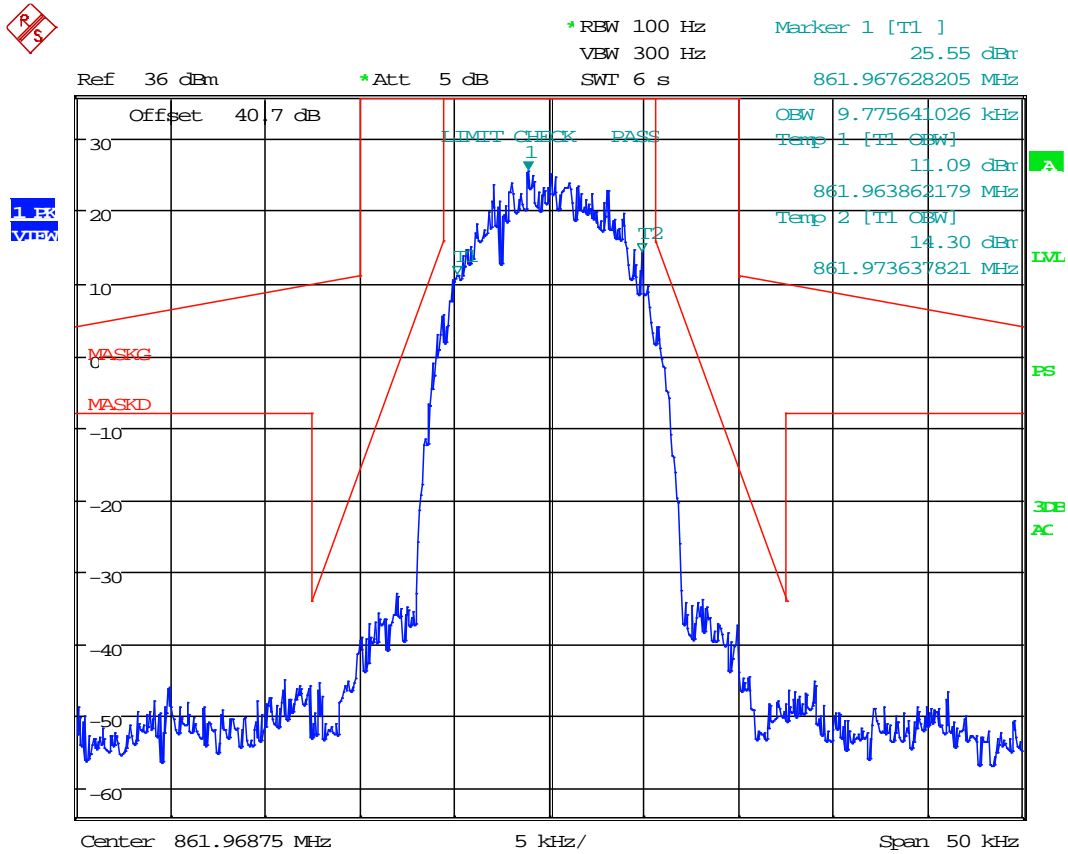

Date: 31.JUL.2019 16:15:02

RESULT: AGC Output Signal 99% OBW = 9.78 kHz

INPUT VS OUTPUT COMPARISON

Test Data: Downlink (861.96875 MHz), 9K80F1E/F1D Output Signal, @ AGC +3 dBm

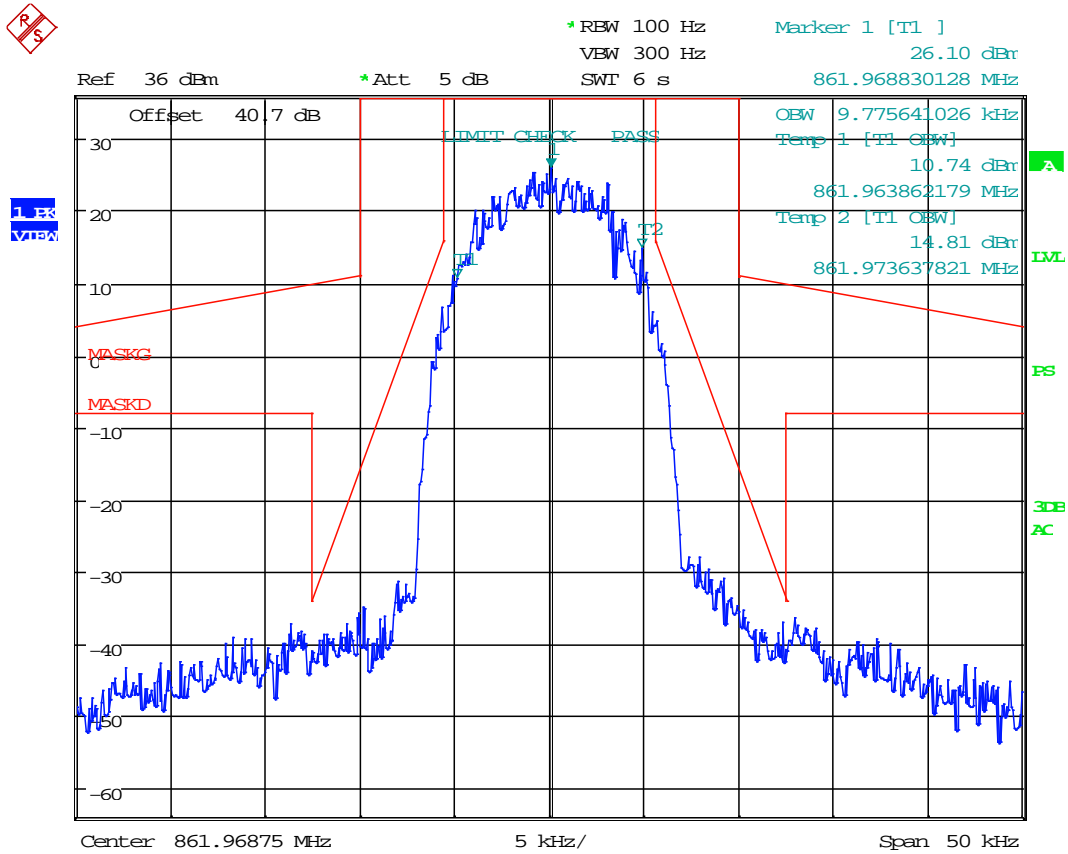

Date: 31.JUL.2019 16:15:59

RESULT: AGC+3 Output Signal 99% OBW = 9.78 kHz

INPUT VS OUTPUT COMPARISON

Test Data: Downlink (861.96875 MHz), 11K3F3E Output Signal, @ AGC

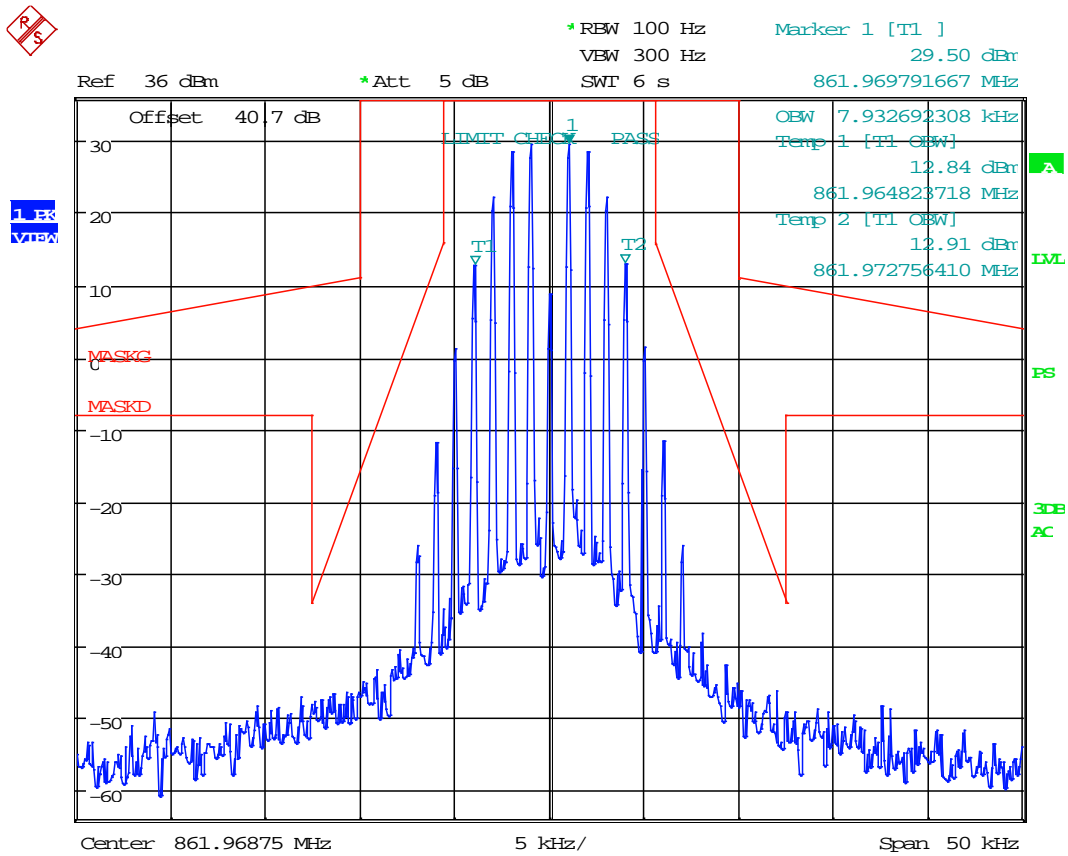

Date: 31.JUL.2019 16:06:32

RESULT: AGC Output Signal 99% OBW = 7.93 kHz

INPUT VS OUTPUT COMPARISON

Test Data: Downlink (861.96875 MHz), 11K3F3E Output Signal, @ AGC +3 dBm

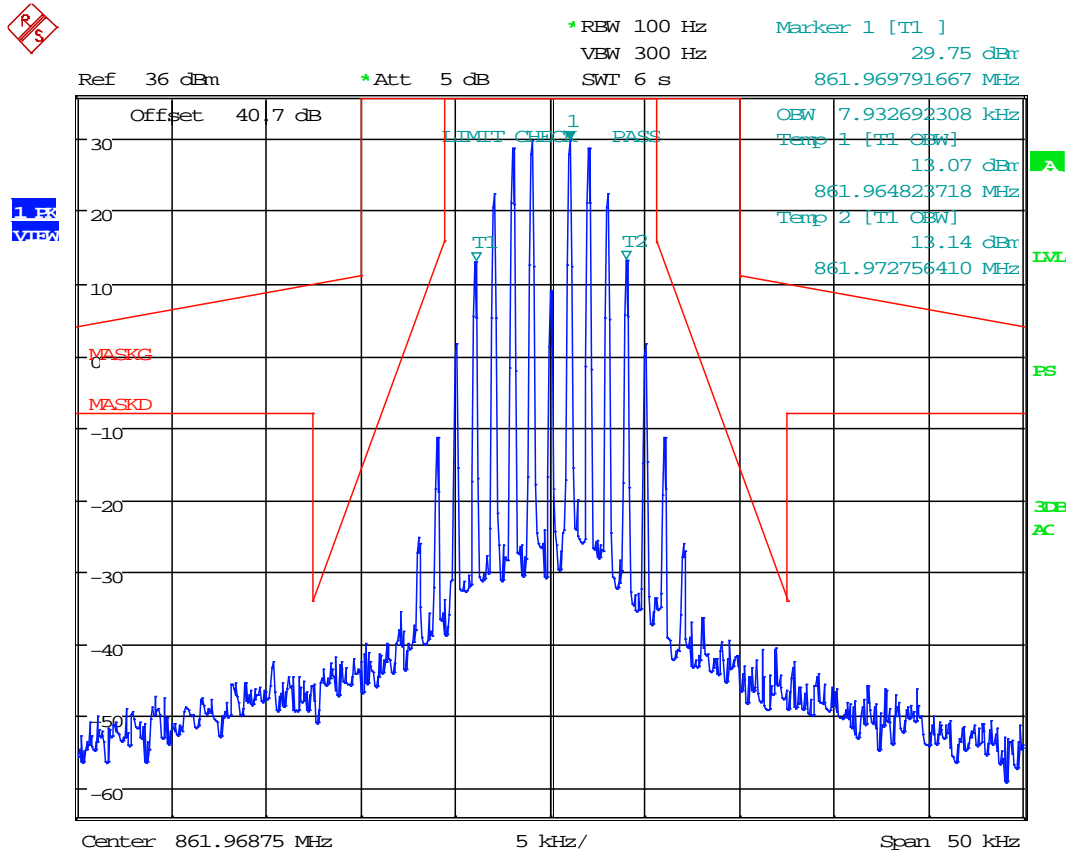

Date: 31.JUL.2019 16:07:16

RESULT: AGC+3 Output Signal 99% OBW = 7.93 kHz

INPUT VS OUTPUT COMPARISON

Test Data: Downlink (861.96875 MHz), 16K0F3E Output Signal, @ AGC

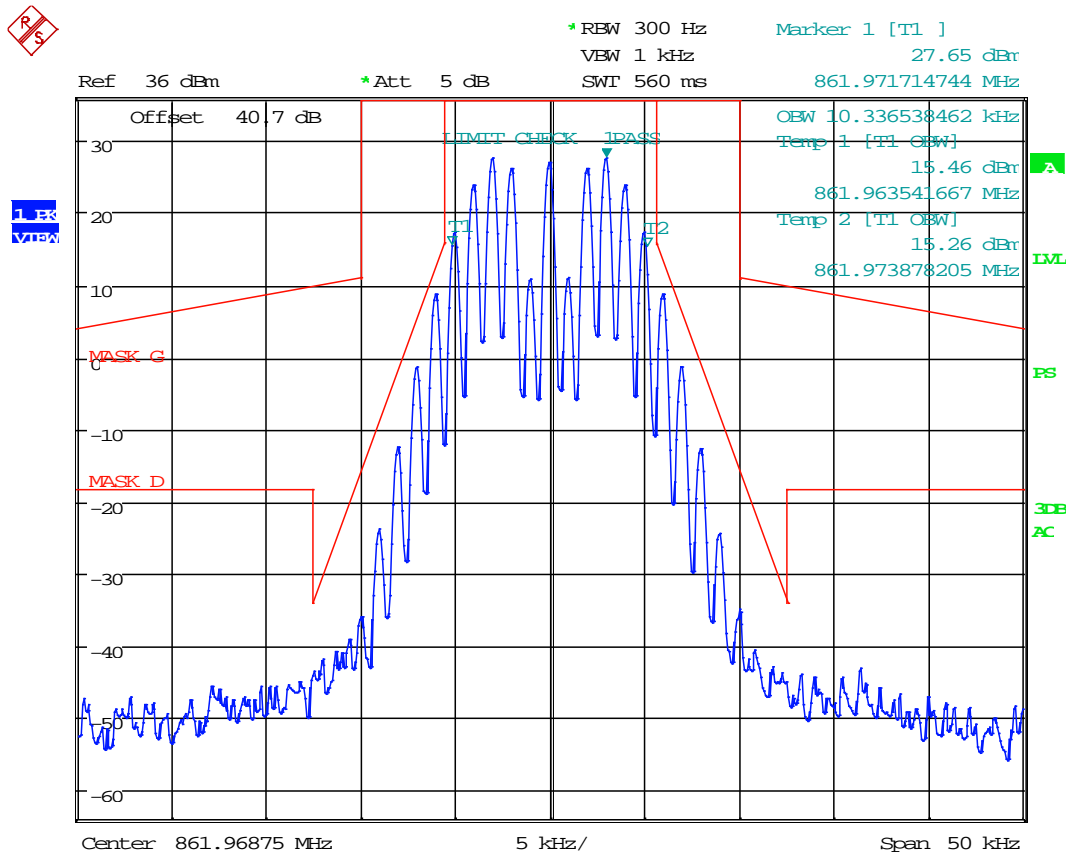

Date: 31.JUL.2019 16:38:51

RESULT: AGC Output Signal 99% OBW = 10.34 kHz

INPUT VS OUTPUT COMPARISON

Test Data: Downlink (861.96875 MHz), 16K0F3E Output Signal, @ AGC +3 dBm

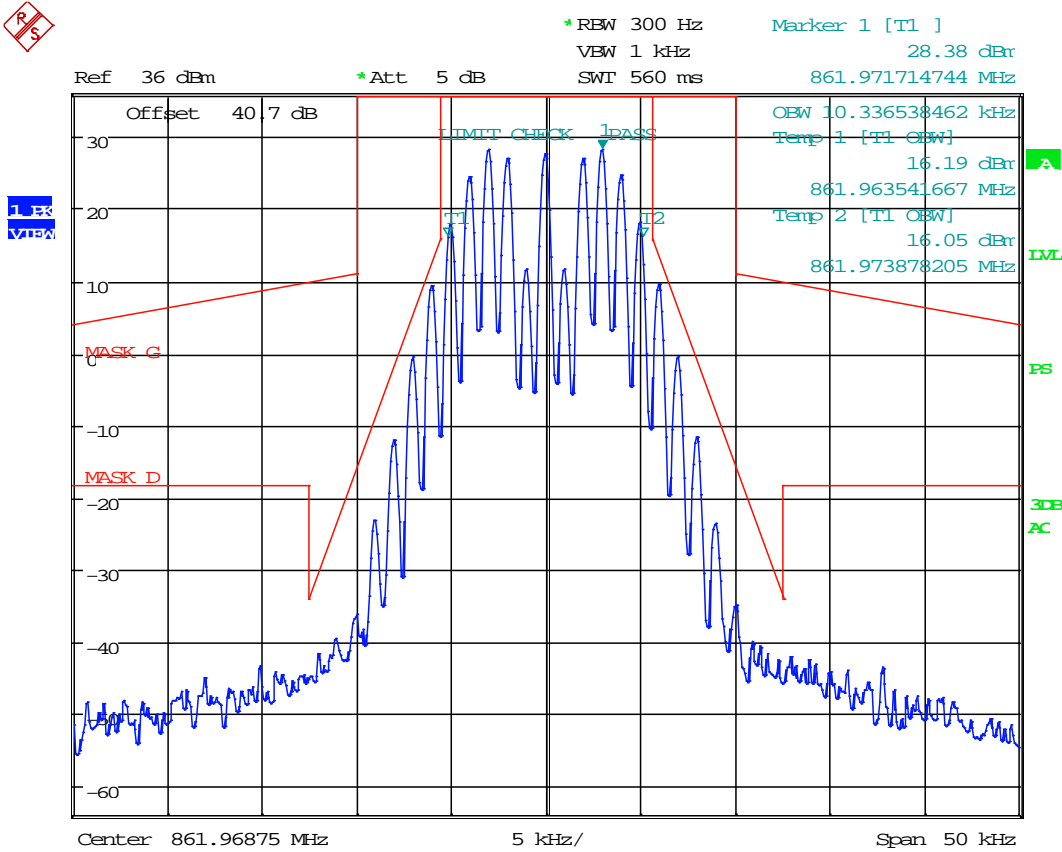

Date: 31.JUL.2019 16:39:26

RESULT: AGC+3 Output Signal 99% OBW = 10.34 kHz

RF POWER OUTPUT

Rule Part No.: KDB 935210 s.4.5, 4.5.5, FCC Pt. 2.1046(a), FCC Pt. 2.1033(c)(8), FCC Pt. 90.219(d)(3), FCC Pt. 90.219(e)(1), FCC Pt. 90.219(e)(4)(iii)

Requirements:

(d) *Deployment rules.* Deployment of signal boosters must be carried out in accordance with the rules in this paragraph.

(3) Signal boosters must be deployed such that the radiated power of the each retransmitted channel, on the forward link and on the reverse link, does not exceed 5 Watts effective radiated power (ERP).

(e) *Device Specifications.* In addition to the general rules for equipment certification in §90.203(a)(2) and part 2, subpart J of this chapter, a signal booster must also meet the rules in this paragraph.

(1) The output power capability of a signal booster must be designed for deployments providing a radiated power not exceeding 5 Watts ERP for each retransmitted channel.

Test Procedure: KDB 935210 s.4.5, & 4.5.3, TIA 603-E

Adjust the internal gain control of the EUT to the maximum gain for which the equipment certification is being sought. Any EUT attenuation settings shall be set to their minimum value.

Input power levels (uplink and downlink) should be set to maximum input ratings, while confirming that the device is not capable of operating in saturation (non-linear mode) at the rated input levels, including during the performance of the input/output power measurements.

4.5.3 Power measurement Method 1: using a spectrum or signal analyzer

- a) Set the frequency span to at least 1 MHz.
- b) Set RBW = 100 kHz.
- c) Set VBW $\geq 3 \times$ RBW.
- d) Set the detector to PEAK, and trace mode to MAX HOLD.
- e) Place a marker on the peak of the signal, and record the value as the maximum power.
- f) Repeat step e) but with the EUT in place.
- g) EUT gain may be calculated as described in 4.5.5.

NOTE—Sections 90.219 and 2.1033(c) do not require gain test data; inclusion of industrial booster gain test data in test reports submitted for FCC equipment authorization is optional.

After the input and output power levels have been measured as described in the preceding subclauses, the gain of the EUT can be determined from:

$$\text{Gain (dB)} = \text{output power (dBm)} - \text{input power (dBm)}.$$

Report the gain for each authorized operating frequency band, and each test signal stimulus.

Test Setup Block Diagram: KDB 935210 s.4.5

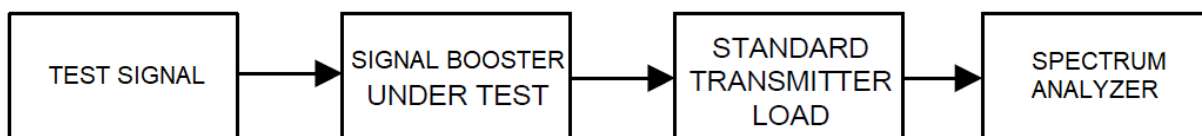

RF POWER OUTPUT

Test Data: 800 Band Measurement Table

800 Band, Uplink

	Gen Freq (MHz)	Input Power (dBm)	Output (dBm)	Gain (dB)	Antenna Gain (dBi)	Cable Loss (dB)	ERP (dBm)	ERP (W)	Limit ERP (W)	Margin (W)
AGC	816.96875	-56.58	24.21	80.79	0.00	0.00	24.21	0.26	5.00	4.74
AGC +3 dBm	816.96875	-53.58	24.21	77.79	0.00	0.00	24.21	0.26	5.00	4.74
Saturation	816.96875	-35	24.17	59.17	0.00	0.00	24.17	0.26	5.00	4.74

800 Band, Downlink

	Gen Freq (MHz)	Input Power (dBm)	Output (dBm)	Gain (dB)	Antenna Gain (dBi)	Cable Loss (dB)	ERP (dBm)	ERP (W)	Limit ERP (W)	Margin (W)
AGC	861.96875	-43.58	36.01	79.59	0.00	0.00	36.01	3.99	5.00	1.01
AGC +3 dBm	861.96875	-40.58	35.92	76.50	0.00	0.00	35.92	3.91	5.00	1.09
Saturation	861.96875	-35	35.92	70.92	0.00	0.00	35.92	3.91	5.00	1.09

Maximum Measured Power Output: 36.01 dBm (3.99 W)

Maximum Rated Power Output: 36.99 dBm (5.0 W)

POWER TO FINAL AMPLIFIER

Rule Part No.: FCC Pt. 2.1033(c)(8)

Requirements:

(c) Applications for equipment other than that operating under parts 15, 11 and 18 of this chapter shall be accompanied by a technical report containing the following information:

(8) The dc voltages applied to and dc currents into the several elements of the final radio frequency amplifying device for normal operation over the power range.

Test Setup Block Diagram:

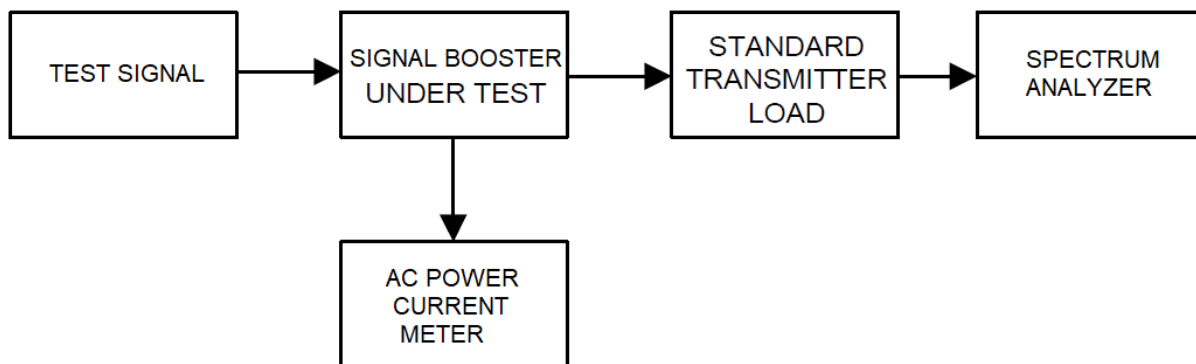

Test Data: Power to Final Amplifier Calculation

INPUT POWER: (110 VAC) (2.73 A) = **300 Watts Maximum**

NOISE FIGURE

Rule Part No.: KDB 935210 s.4.6, FCC Pt. 90.219(e)(2)

Section 90.219(e)(2) limits the noise figure of a signal booster to ≤ 9 dB in either direction. The following discussion provides guidance for demonstrating compliance with this requirement.

Several widely recognized methods for performing noise figure measurements are available. Some require the use of specialized equipment, such as a noise figure analyzer and/or an excess noise ratio (ENR) calibrated noise source, while others involve the use of conventional measurement instrumentation such as a spectrum analyzer. Methods that require use of a noise figure analyzer are generally accepted as producing the most accurate results, and are considered to be the reference method within this document, while others are considered to be acceptable alternative methods. Consult the relevant instrumentation application notes for detailed guidance regarding the selection and application of an appropriate methodology for performing noise figure measurements. Note also that noise figure measurements require that any AGC circuitry be disabled over the duration of the measurement.

Requirements:

(e) *Device Specifications.* In addition to the general rules for equipment certification in §90.203(a)(2) and part 2, subpart J of this chapter, a signal booster must also meet the rules in this paragraph.

(2) The noise figure of a signal booster must not exceed 9 dB in either direction.

Test Procedure: 1MA178_2e R&S Application Note the Y Factor Technique Noise Figure Sections 2 Background Theory and Equations & 3 Detailed Measurement Steps

Setup using an RBW of 10 kHz, VBW $\geq 3x$ RBW, Span $> 2x$ Passband, Max Hold, Peak Detector. "Noise Source off" and "Noise Source on" traces were taken.

Note: EUT's AGC method(s) and/or squelch function should be disabled for this test.

Test Setup Block Diagram:

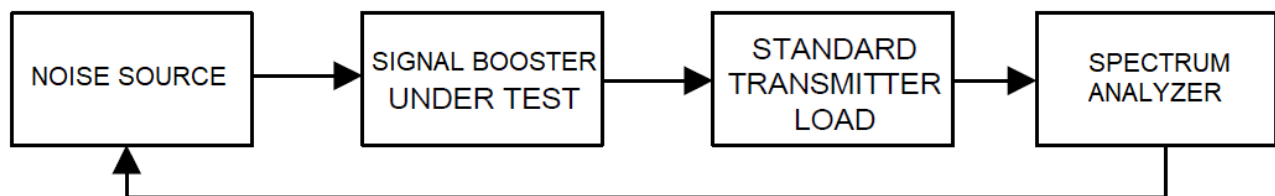

NOISE FIGURE

800 Band Noise Figure

Test Data: 800 Band Uplink Noise Calculation

FCC KDB 935210 S. 4.6, ISSED RSS-131 S. 6.4 - NOISE FIGURE	
Measurement Freq. (MHz)	816.96875
Noise Source ENR (dB)	15.0624
Noise Source T_s^{OFF}, T_o (K)	290
Noise Source T_s^{ON} (K)	9593.2576
Noise Source Cal N_2^{off} (dB)	-109.88
Noise Source Cal N_2^{off} (pW)	0.01028
Noise Source Cal N_2^{on} (dB)	-106.26
Noise Source Cal N_2^{on} (pW)	0.02366
Calibration Ratio Y_2	2.3014
Calibration T_2	6858.4238
Noise + EUT N_{12}^{off} (dB)	-40.33
Noise + EUT N_{12}^{off} (pW)	92682.98
Noise + EUT N_{12}^{on} (dB)	-27.22
Noise + EUT N_{12}^{on} (pW)	1896705.92
Noise + EUT Ratio Y_{12}	20.4644
Noise + EUT T_{12}	187.9616
Gain (Ratio)	134839551.1767
Gain (dB)	81.2982
2nd Stage Correction T_1	187.961532363452
Noise Factor F	1.64814
Noise Figure (dB)	2.17
Limit (dB)	9.00
Margin (dB)	6.83

NOISE FIGURE

Test Data: 800 Band Uplink Noise Figure Plot

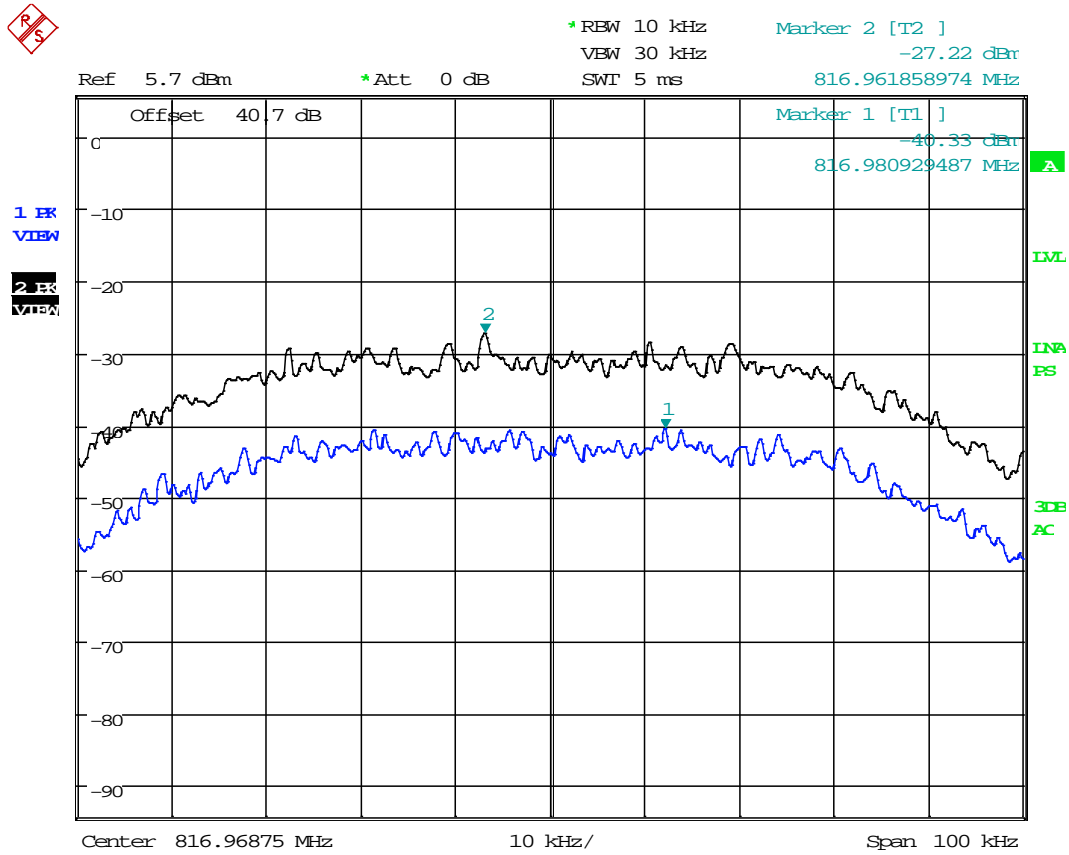

Date: 30.JUL.2019 17:51:48

NOISE FIGURE

Test Data: 800 Band Downlink Noise Calculation

FCC KDB 935210 S. 4.6, ISED RSS-131 S. 6.4 - NOISE FIGURE	
Measurement Freq. (MHz)	861.96875
Noise Source ENR (dB)	15.0569
Noise Source T_s^{OFF}, T_o (K)	290
Noise Source T_s^{ON} (K)	9581.4832
Noise Source Cal N_2^{off} (dB)	-110.55
Noise Source Cal N_2^{off} (pW)	0.00881
Noise Source Cal N_2^{on} (dB)	-105.1
Noise Source Cal N_2^{on} (pW)	0.03090
Calibration Ratio Y_2	3.5075
Calibration T_2	3415.4492
Noise + EUT N_{12}^{off} (dB)	-41.93
Noise + EUT N_{12}^{off} (pW)	64120.96
Noise + EUT N_{12}^{on} (dB)	-29.93
Noise + EUT N_{12}^{on} (pW)	1016248.69
Noise + EUT Ratio Y_{12}	15.8489
Noise + EUT T_{12}	335.7341
Gain (Ratio)	43097395.8572
Gain (dB)	76.3445
2nd Stage Correction T_1	335.734031358381
Noise Factor F	2.15770
Noise Figure (dB)	3.34
Limit (dB)	9.00
Margin (dB)	5.66

NOISE FIGURE

Test Data: 800 Band Downlink Noise Figure Plot

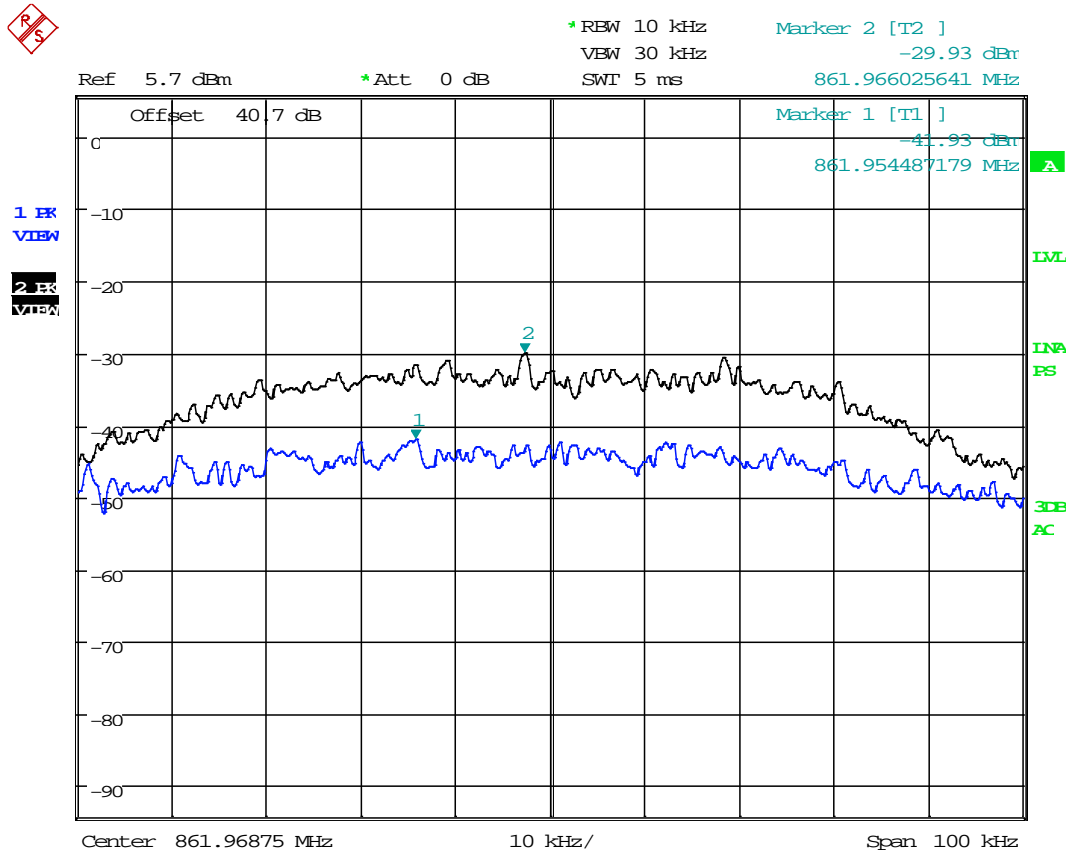

Date: 31.JUL.2019 12:25:57

PASSBAND NOISE

Rule Part No.: FCC Pt. 90.219(d)(6)(ii), FCC Pt. 90.219(d)(6)(iii)

Requirements: Reporting only.

(d) *Deployment rules.* Deployment of signal boosters must be carried out in accordance with the rules in this paragraph.

(6) Good engineering practice must be used in regard to the radiation of intermodulation products and noise, such that interference to licensed communications systems is avoided. In the event of harmful interference caused by any given deployment, the FCC may require additional attenuation or filtering of the emissions and/or noise from signal boosters or signal booster systems, as necessary to eliminate the interference.

(ii) In general, the ERP of noise within the passband should not exceed -43 dBm in 10 kHz measurement bandwidth.

(iii) In general, the ERP of noise on spectrum more than 1 MHz outside of the passband should not exceed -70 dBm in a 10 kHz measurement bandwidth.

Test Procedure: With the Rx Port terminated, setup using an RBW of 10 kHz, VBW $\geq 3 \times$ RBW, Span $> 2 \times$ Passband, Max Hold, Peak Detector. Markers were placed in and > 1 MHz outside Passband.

Note: EUT's AGC method(s) and/or squelch function should be disabled for this test.

Test Setup Block Diagram:

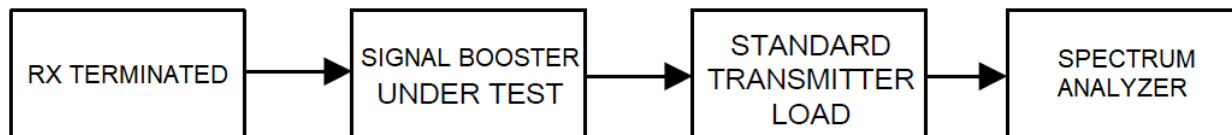

PASSBAND NOISE

800 Band Passband Noise

Test Data: 800 Band Uplink Noise Inside Passband

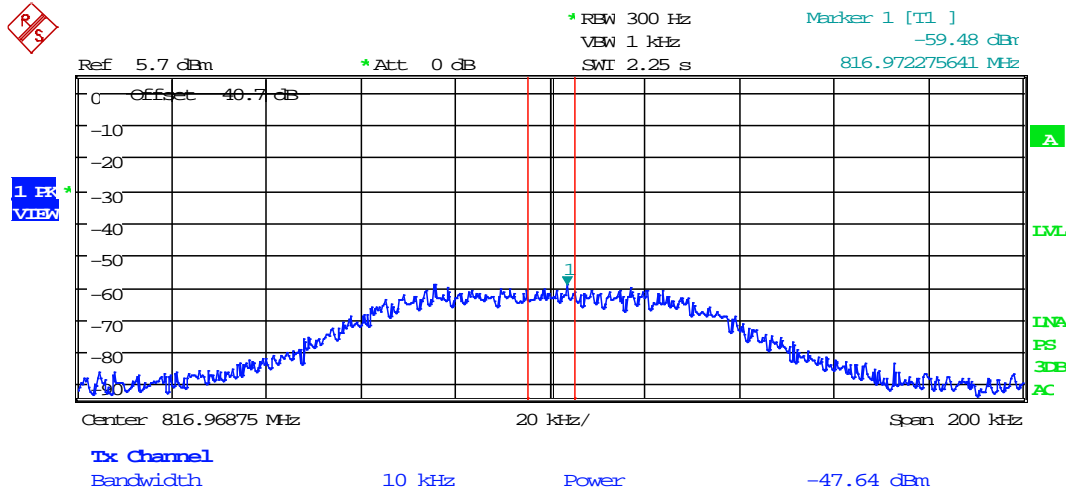

Date: 30.JUL.2019 17:53:47

PASSBAND NOISE

Test Data: 800 Band Uplink Noise Outside Passband

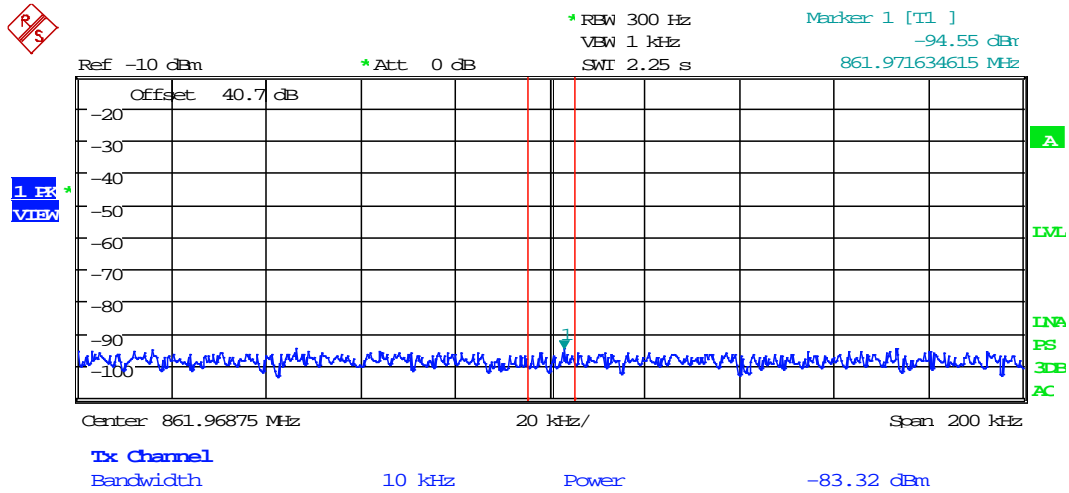

Date: 30.JUL.2019 17:54:53

PASSBAND NOISE

Test Data: 800 Band Downlink Noise Inside Passband

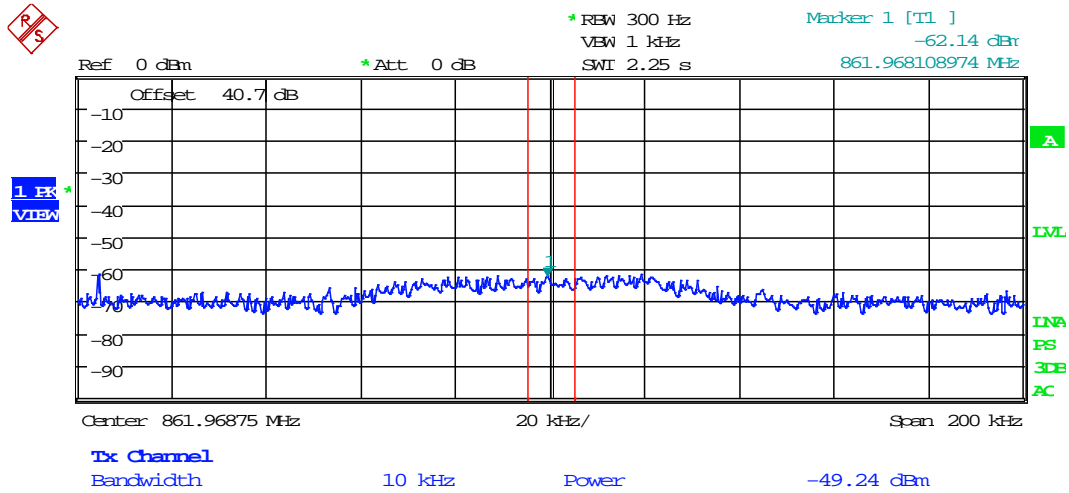

Date: 31.JUL.2019 12:23:21

PASSBAND NOISE

Test Data: 800 Band Downlink Noise Outside Passband

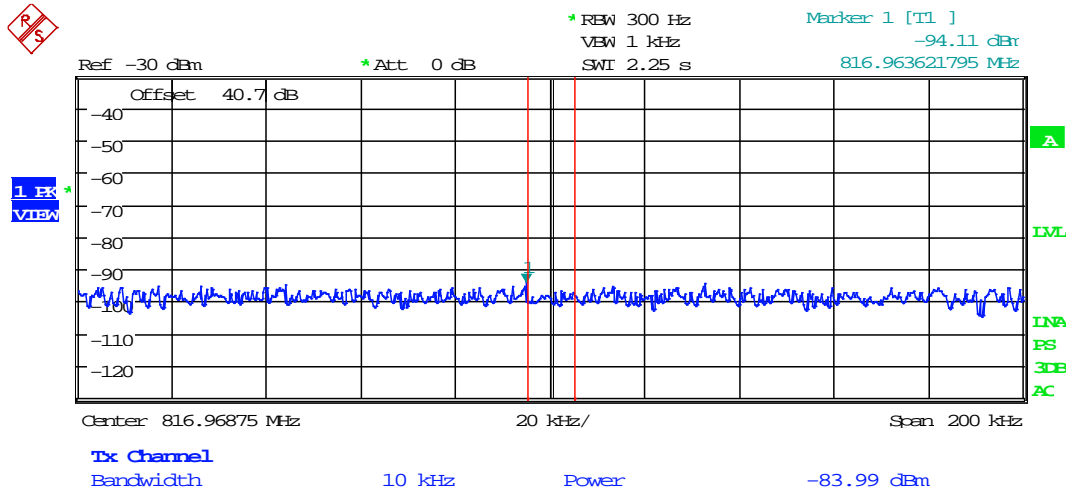

Date: 31.JUL.2019 12:24:22

INTERMODULATION SPURIOUS EMISSIONS

Test Procedure: KDB 935210 s.4.7.2, TIA 603-E

Intermodulation products shall be measured using two CW signals with all available channel spacings (e.g., 12.5 kHz and 6.25 kHz) with the center between these channels being equal to the center frequency f_0 as determined from 4.4.

NOTE—Intermodulation-product spurious emission measurements are not required for single-channel boosters that cannot accommodate two simultaneous signals within the passband.

- a) Connect a signal generator to the input of the EUT.
If the signal generator is not capable of producing two independent modulated carriers simultaneously, then two discrete signal generators can be connected, with an appropriate combining network to support the two-signal test.
- b) Configure the two signal generators to produce CW on frequencies spaced consistent with 4.7.1, with amplitude levels set to just below the AGC threshold (see 4.2).
- c) Connect a spectrum analyzer to the EUT output.
- d) Set the span to 100 kHz.
- e) Set RBW = 300 Hz with VBW $\geq 3 \times$ RBW.
- f) Set the detector to power averaging (rms).
- g) Place a marker on highest intermodulation product amplitude.
- h) Capture the plot for inclusion in the test report.
- i) Repeat steps c) to h) with the composite input power level set to 3 dB above the AGC threshold.
- j) Repeat steps b) to i) for all operational bands.

Test Setup Block Diagram: KDB 935210 s.4.7.2

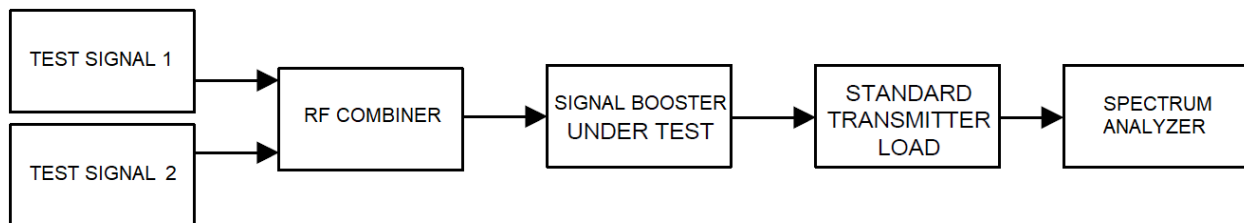

INTERMODULATION SPURIOUS EMISSIONS

800 Band Uplink

Test Data: Uplink (816.96875 MHz), 6.25 kHz Channel Spacing, @ AGC

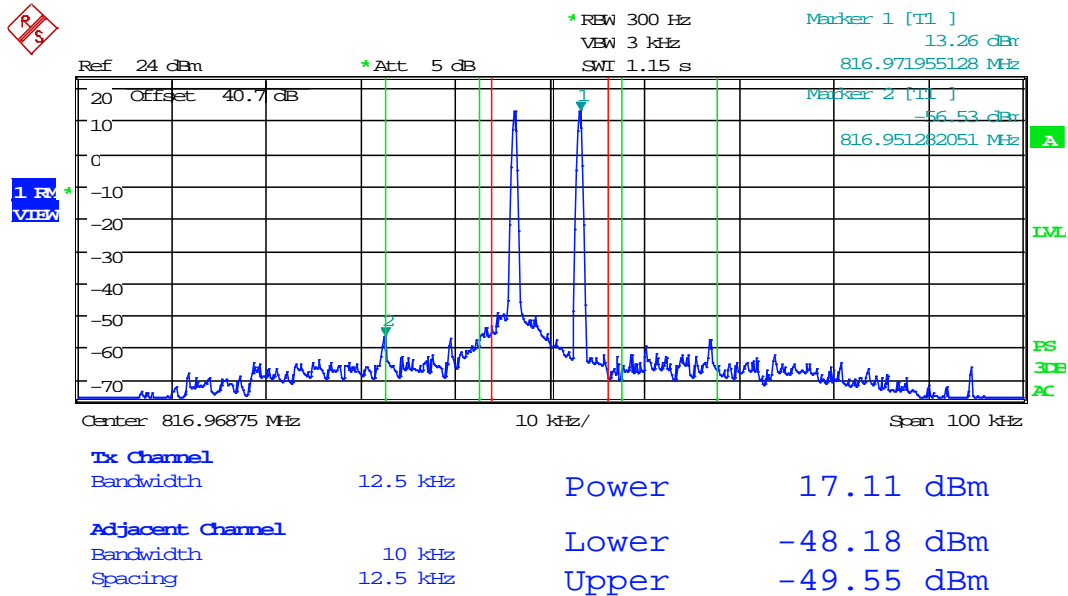

Date: 31.JUL.2019 10:53:05

INTERMODULATION

Test Data: Uplink (816.96875 MHz), 6.25 kHz Channel Spacing, @ AGC +3 dBm

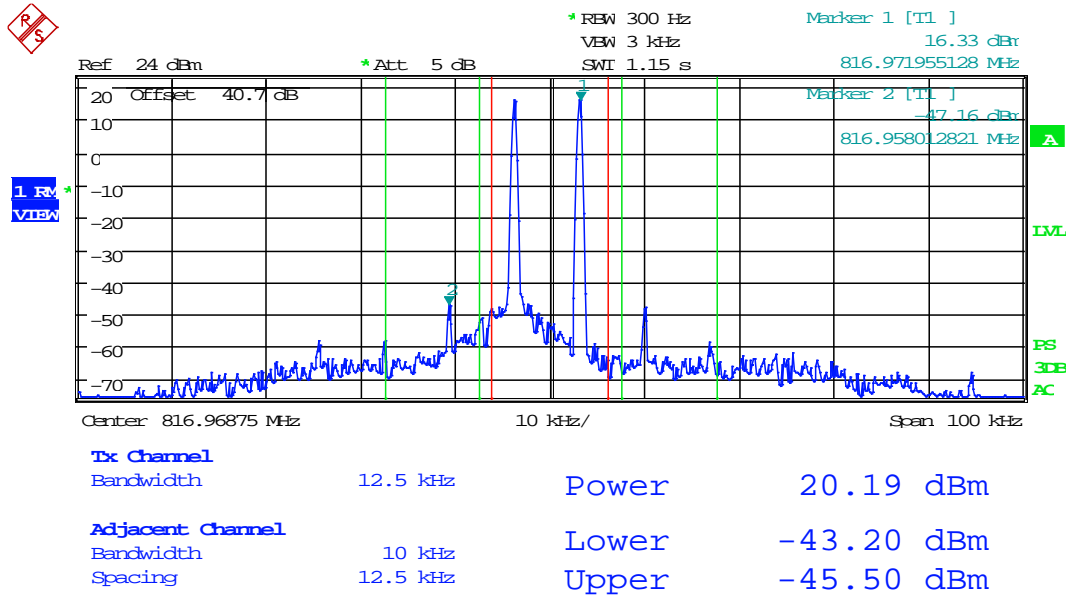

Date: 31.JUL.2019 10:51:56

INTERMODULATION

Test Data: Uplink (816.96875 MHz), 12.5 kHz Channel Spacing, @ AGC

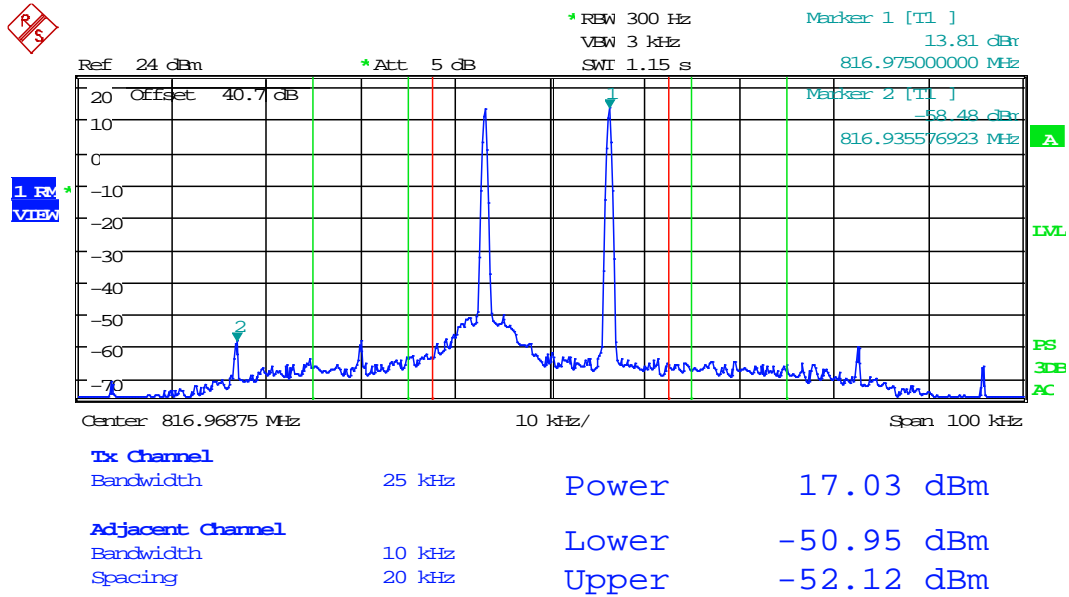

Date: 31.JUL.2019 10:54:48

INTERMODULATION

Test Data: Uplink (816.96875 MHz), 12.5 kHz Channel Spacing, @ AGC +3 dBm

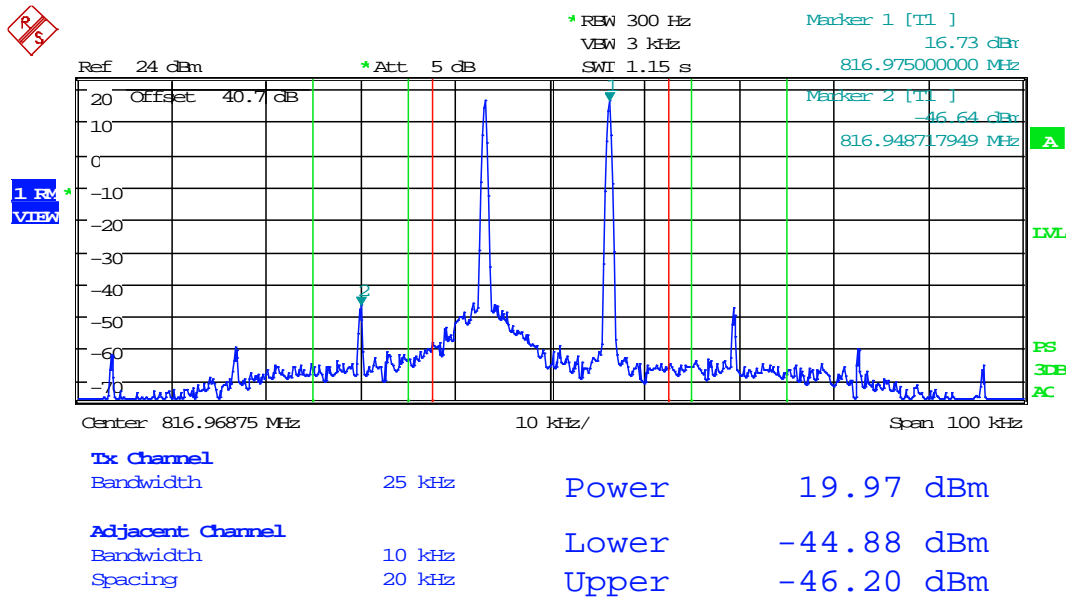

Date: 31.JUL.2019 10:55:28

INTERMODULATION

Test Data: Uplink (816.96875 MHz), 25 kHz Channel Spacing, @ AGC

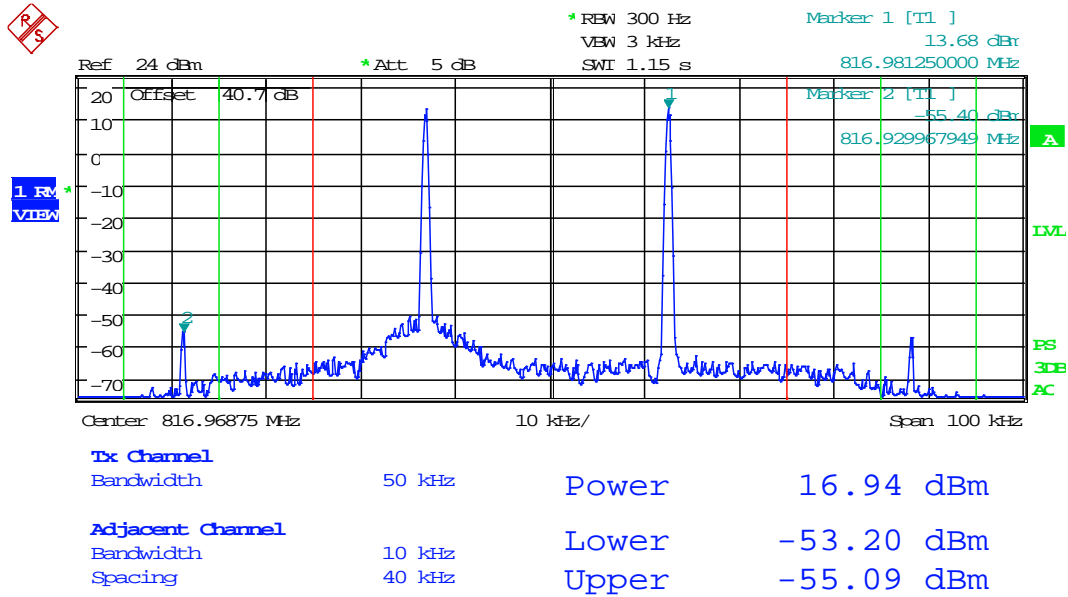

Date: 31.JUL.2019 10:58:04

INTERMODULATION

Test Data: Uplink (816.96875 MHz), 25 kHz Channel Spacing, @ AGC +3 dBm

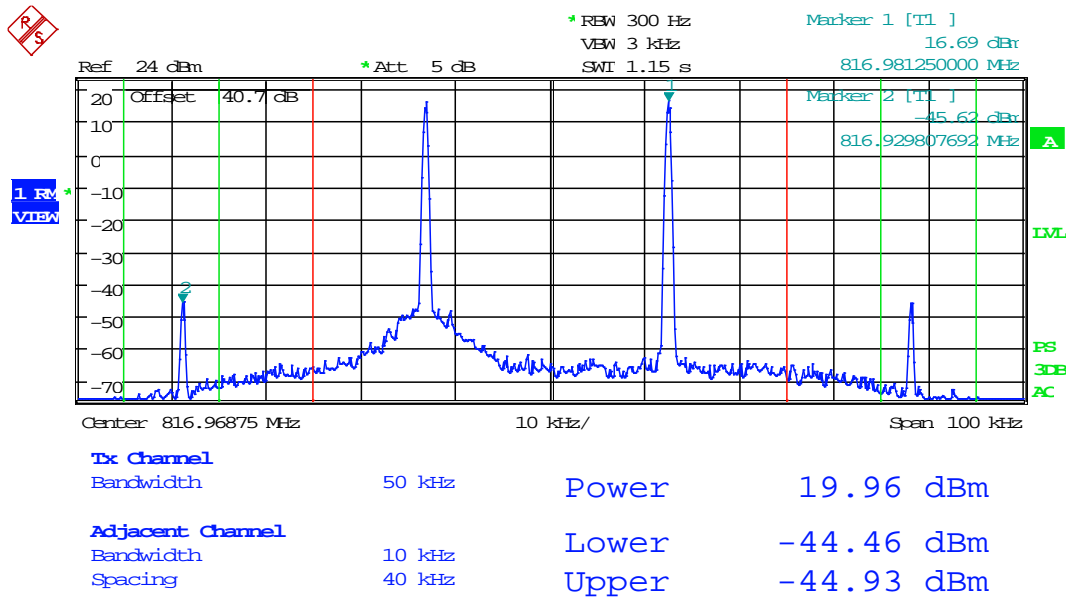

Date: 31.JUL.2019 10:57:12

INTERMODULATION

800 Band Downlink

Test Data: Downlink (861.96875 MHz), 6.25 kHz Channel Spacing, @ AGC

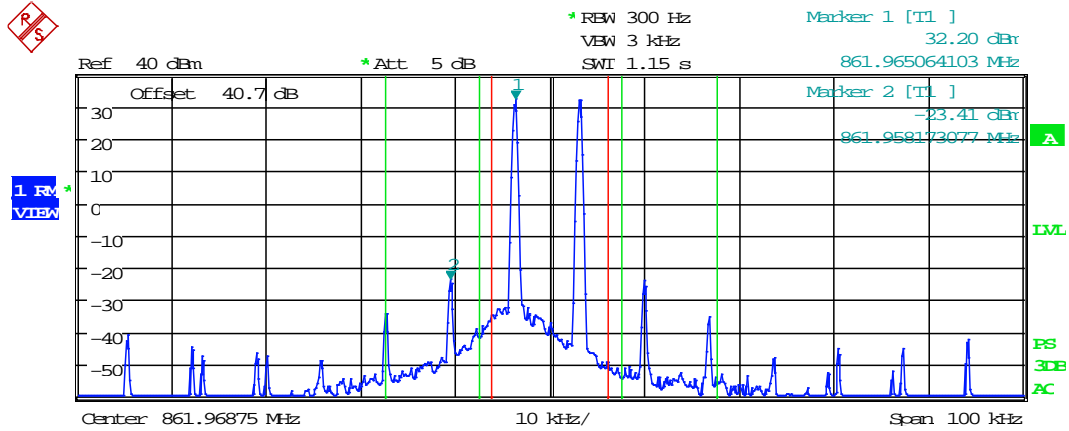

Tx Channel			
Bandwidth	12.5 kHz	Power	35.68 dBm
Adjacent Channel			
Bandwidth	10 kHz	Lower	-22.28 dBm
Spacing	12.5 kHz	Upper	-23.34 dBm

Date: 31.JUL.2019 14:54:24

INTERMODULATION

Test Data: Downlink (861.96875 MHz), 6.25 kHz Channel Spacing, @ AGC +3 dBm

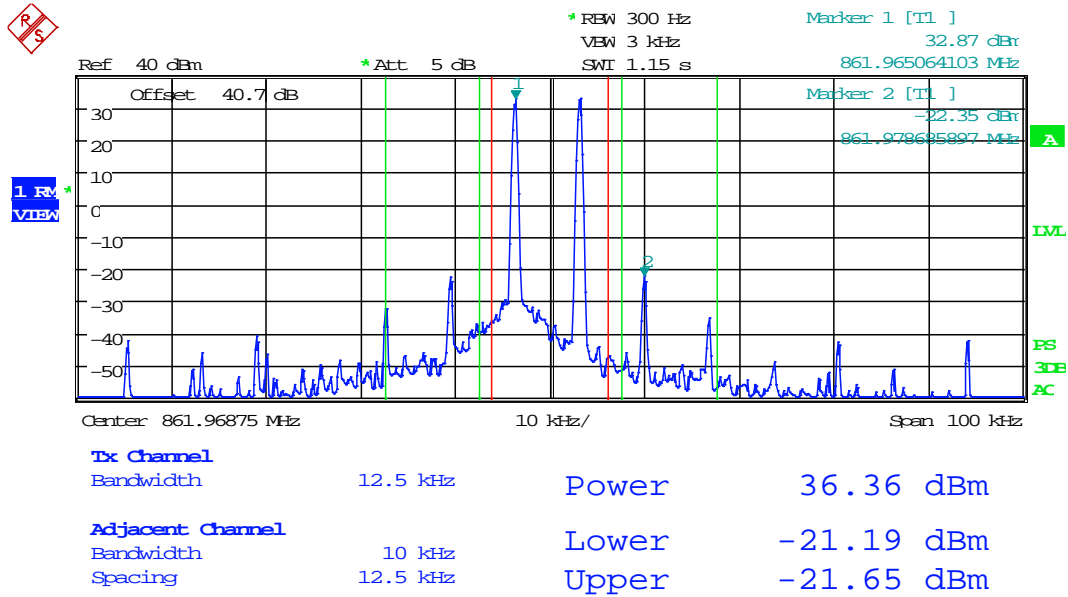

Date: 31.JUL.2019 14:55:56

INTERMODULATION

Test Data: Downlink (861.96875 MHz), 12.5 kHz Channel Spacing, @ AGC

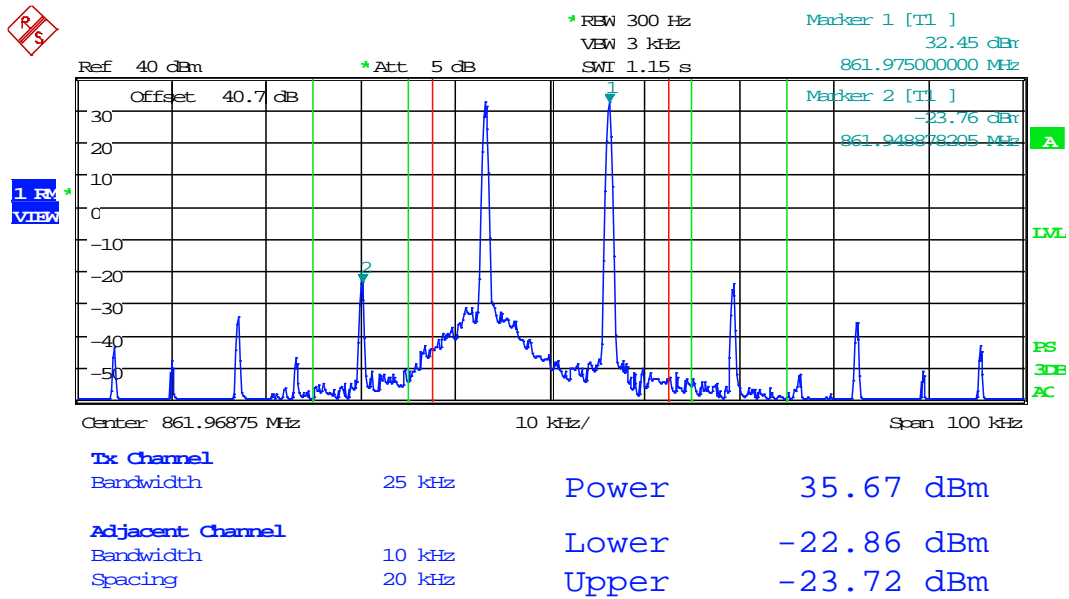

Date: 31.JUL.2019 14:59:09

INTERMODULATION

Test Data: Downlink (861.96875 MHz), 12.5 kHz Channel Spacing, @ AGC +3 dBm

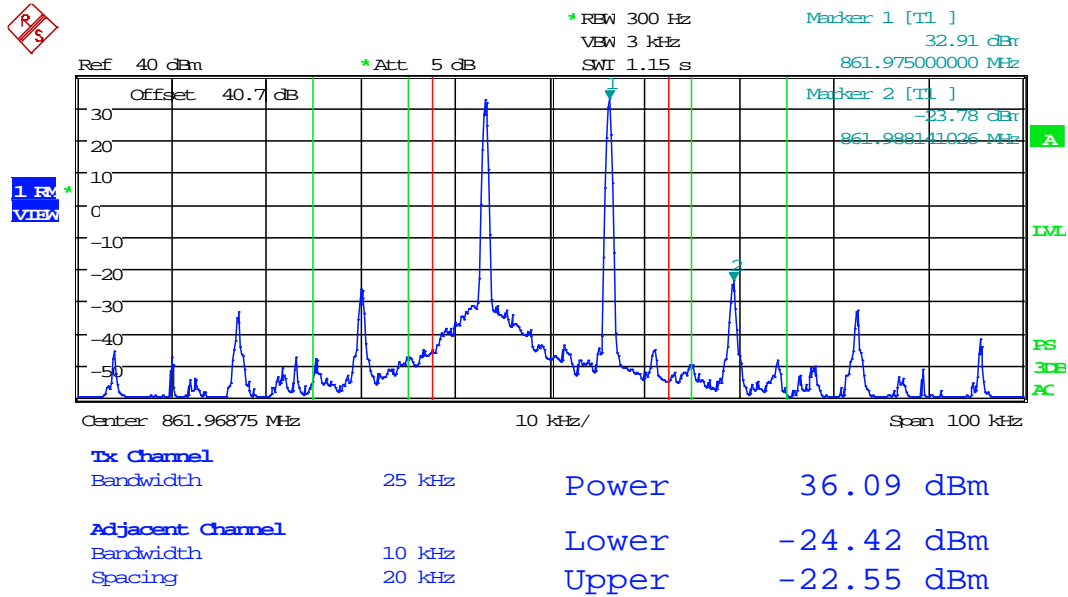

Date: 31.JUL.2019 14:58:26

INTERMODULATION

Test Data: Downlink (861.96875 MHz), 25 kHz Channel Spacing, @ AGC

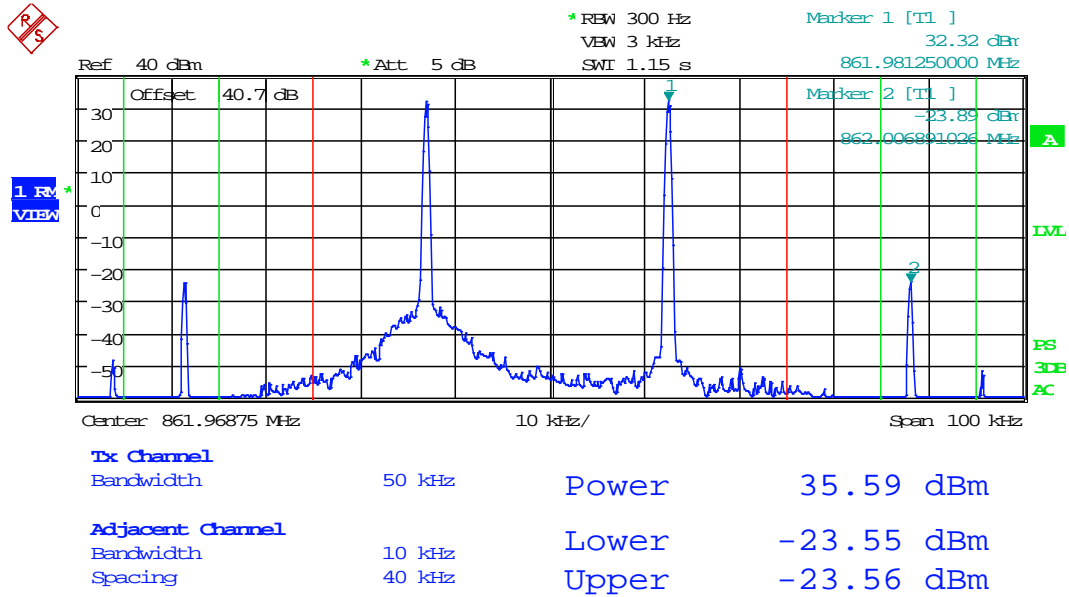

Date: 31.JUL.2019 15:01:54

INTERMODULATION

Test Data: Downlink (861.96875 MHz), 25 kHz Channel Spacing, @ AGC +3 dBm

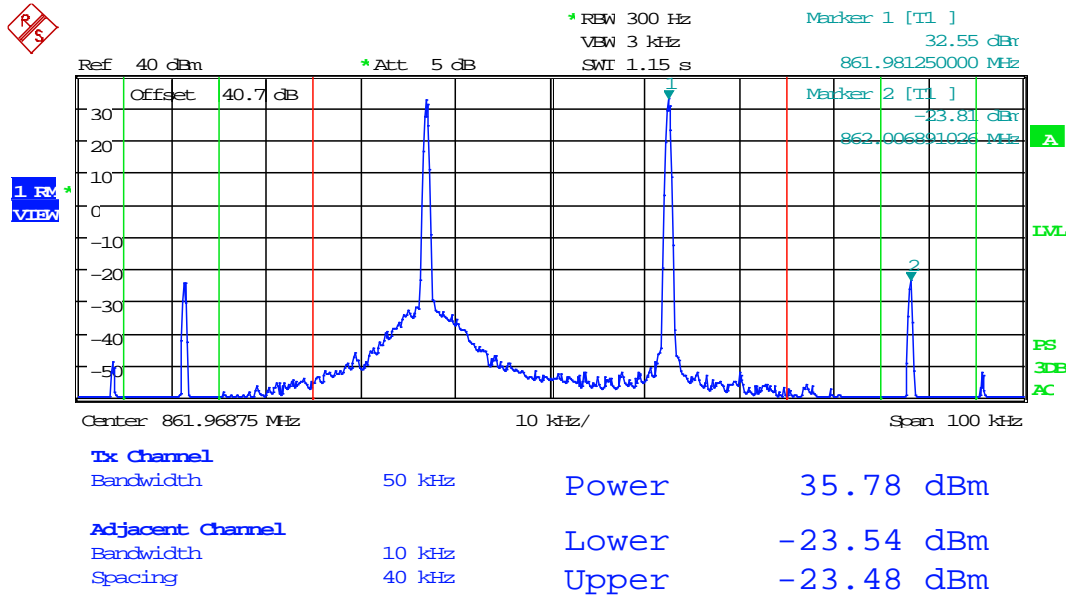

Date: 31.JUL.2019 15:02:46

SPURIOUS EMISSIONS AT ANTENNA TERMINALS

Rule Part No.: KDB 935210 s.4.7.3, FCC Part 2.1051(a), FCC Pt. 90.219(e)(3)

Refer to the applicable rule part(s) for specified limits on unwanted (out-of-band/out-of-block and spurious) emissions (e.g., Section 90.210).

Requirements:

(e) *Device Specifications.* In addition to the general rules for equipment certification in §90.203(a)(2) and part 2, subpart J of this chapter, a signal booster must also meet the rules in this paragraph.

(3) Spurious emissions from a signal booster must not exceed -13 dBm within any 100 kHz measurement bandwidth.

Test Procedure: KDB 935210 s.4.7.3, TIA 603-E

Spurious emissions shall be measured using a single test signal sequentially tuned to the low, middle, and high channels or frequencies within each authorized frequency band of operation.

- a) Connect a signal generator to the input of the EUT.
- b) Configure the signal generator to produce a CW signal.
- c) Set the frequency of the CW signal to the center channel of the EUT passband.
- d) Set the output power level so that the resultant signal is just below the AGC threshold (see 4.2).
- e) Connect a spectrum analyzer to the output of the EUT, using appropriate attenuation as necessary.
- f) Set the RBW = 100 kHz. (i.e., for 30 MHz to 1 GHz PLMRS and/or PSRS booster devices)
- g) Set the VBW = $3 \times$ RBW.
- h) Set the Sweep time = auto-couple.
- i) Set the detector to PEAK.
- j) Set the spectrum analyzer start frequency to 30 MHz (or the lowest radio frequency signal generated in the EUT, without going below 9 kHz if the EUT has additional internal clock frequencies), and the stop frequency to 10 times the highest allowable frequency of the EUT passband.
- k) Select MAX HOLD, and use the marker peak function to find the highest emission(s) outside the passband. (This could be either at a frequency lesser or greater than the passband frequencies.)
- l) Capture a plot for inclusion in the test report.
- m) Repeat steps c) to l) for each authorized frequency band/block of operation.

Test Setup Block Diagram: KDB 935210 s.4.7.3

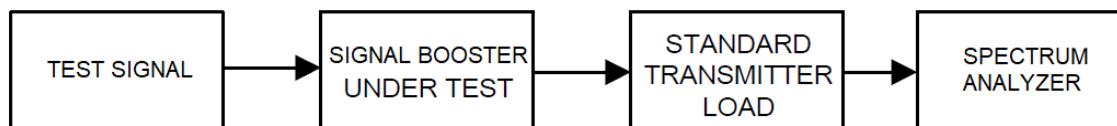

SPURIOUS EMISSIONS AT ANTENNA TERMINALS

800 Band Conducted Spurious Emissions

Test Data: 800 Band Uplink Spurious Emissions Plot, 30 MHz – 1 GHz

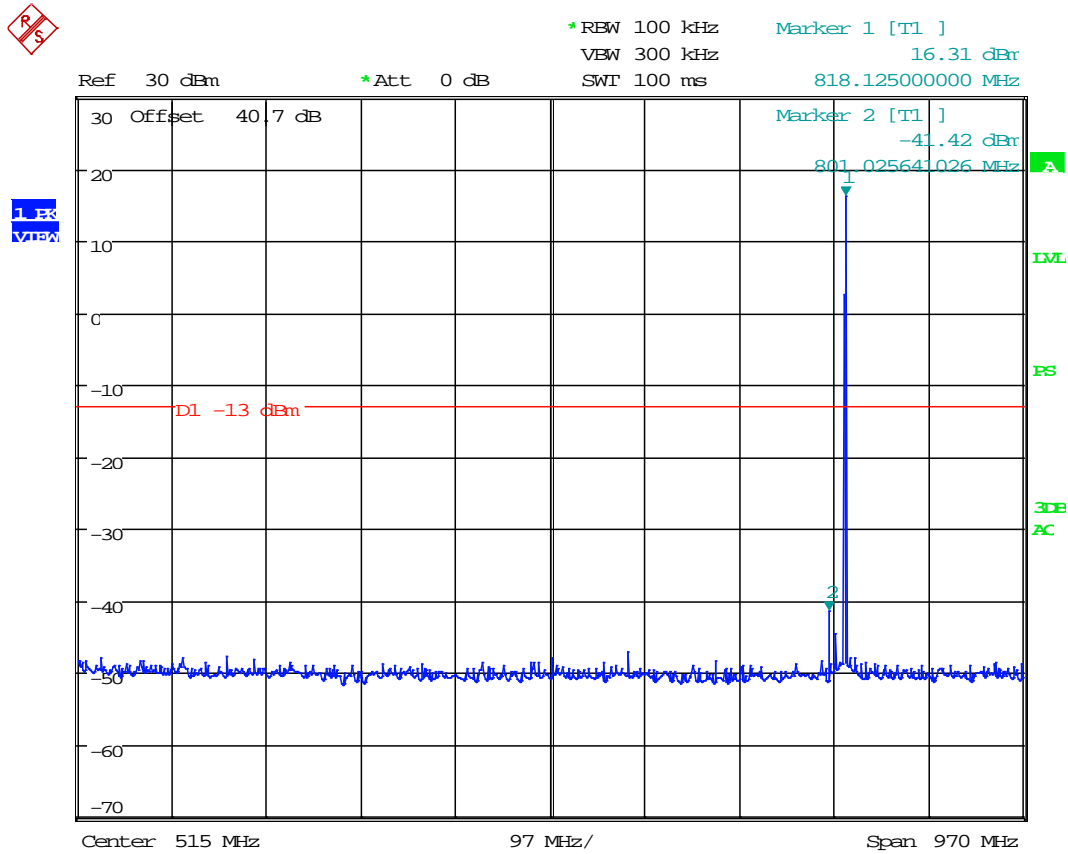

Date: 30.JUL.2019 18:03:29

SPURIOUS EMISSIONS AT ANTENNA TERMINALS

Test Data: 800 Band Uplink Spurious Emissions Plot, > 1 GHz

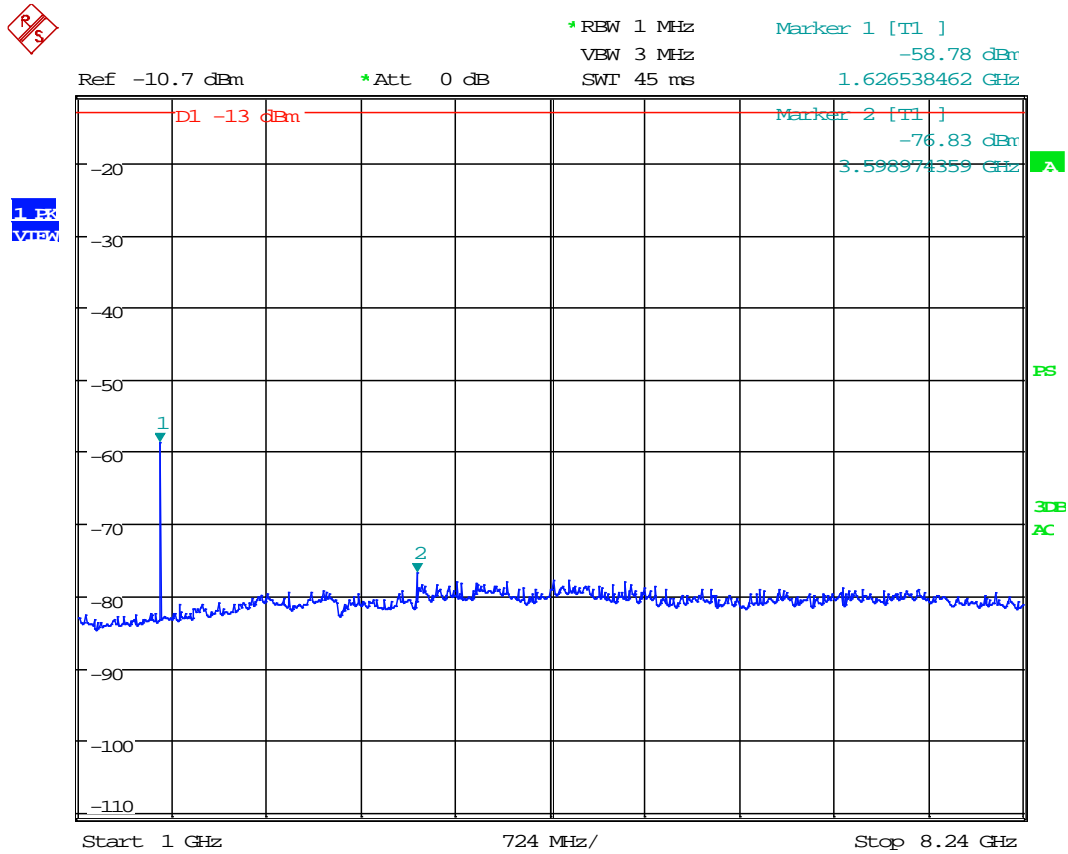

Date: 30.JUL.2019 18:08:26

Frequency	Measured Level (dBm)	Loss (dB)	Output (dBm)	Limit (dBm)	Margin (W)
1626.54	-58.78	0.87	-57.91	-13.00	44.91
3598.97	-76.83	6.43	-70.40	-13.00	57.40

SPURIOUS EMISSIONS AT ANTENNA TERMINALS

Test Data: 800 Band Downlink Spurious Emissions Plot, 30 MHz – 1 GHz

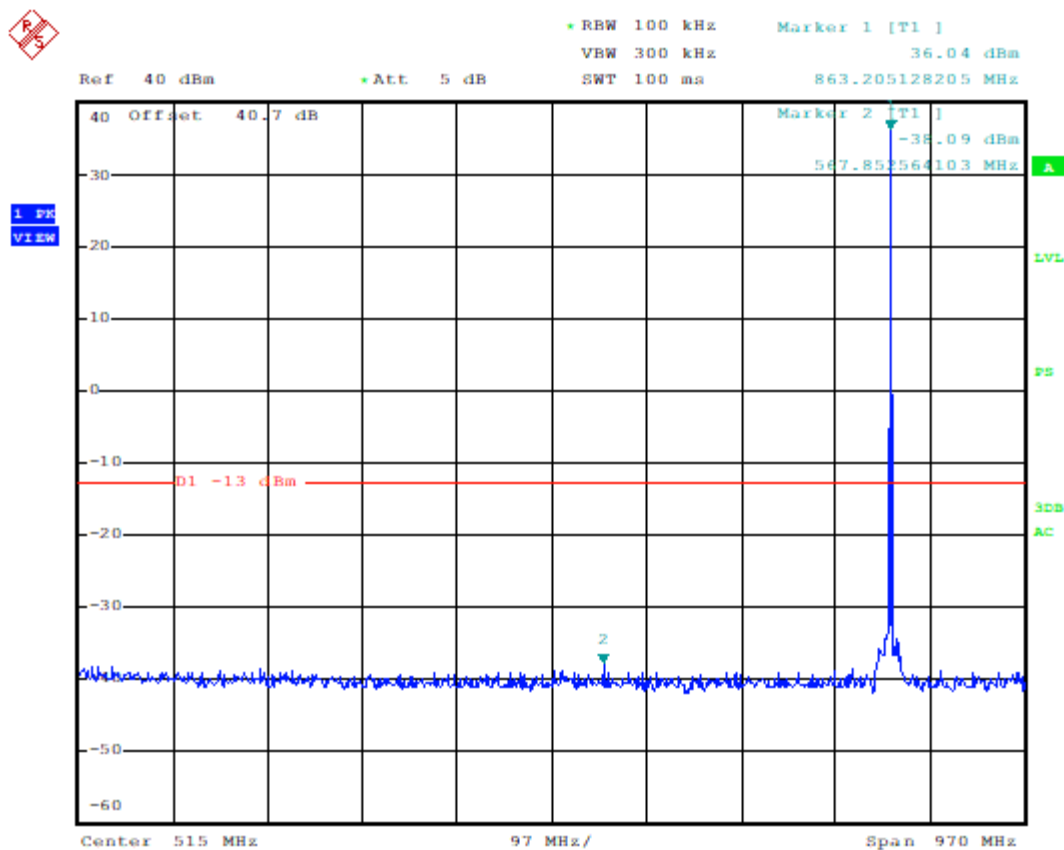

Date: 31.JUL.2019 15:10:01

SPURIOUS EMISSIONS AT ANTENNA TERMINALS

Test Data: 800 Band Downlink Spurious Emissions Plot, > 1 GHz

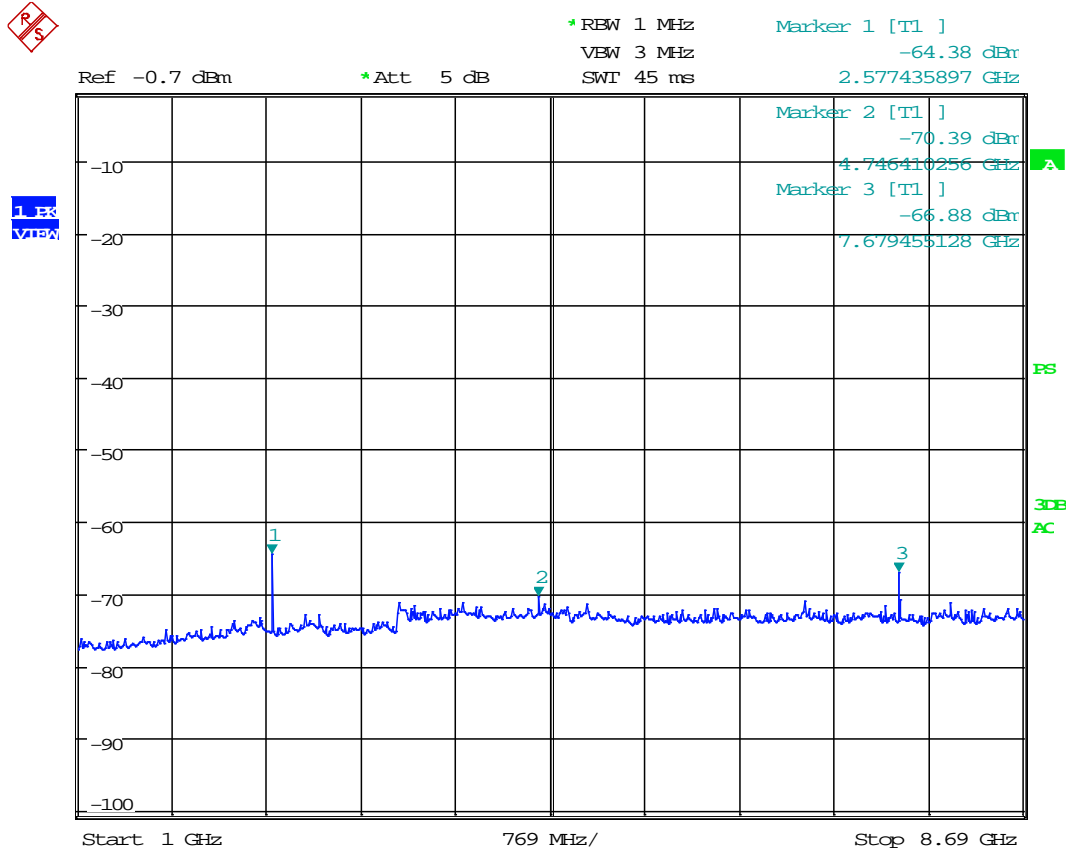

Date: 31.JUL.2019 15:21:00

Frequency	Measured Level (dBm)	Loss (dB)	Output (dBm)	Limit (dBm)	Margin (W)
2577.44	-64.38	2.11	-62.27	-13.00	49.27
4746.41	-70.39	1.42	-68.97	-13.00	55.97
7679.46	-66.88	8.26	-58.62	-13.00	45.62

FREQUENCY STABILITY

Rule Part No.: KDB 935210 s.4.8, FCC Part 2.1055(a)(1), FCC Pt. 90.219(e)(4)(i)

Section 90.219(e)(4)(i) requires that a signal being retransmitted by an amplifier, repeater, or industrial booster meets the frequency stability requirements of Section 90.213. However, this requirement presumes that the EUT processes an input signal in ways that can influence the output signal frequency/frequencies; however, most signal boosters do not incorporate an oscillator). If the amplifier, booster, or repeater does not alter the input signal in any way, then a frequency stability test may not be required.

Requirements: FCC Part 2.1055(a)(1)

(a) The frequency stability shall be measured with variation of ambient temperature as follows:

(1) From -30° to $+50^{\circ}$ centigrade for all equipment except that specified in paragraphs (a) (2) and (3) of this section.

Test Procedure: KDB 935210 s.4.8, FCC Part 2.1055(b), TIA 603-E

When performing frequency stability measurements on these types of devices, the instability associated with the EUT must be isolated from any frequency instability associated with the measurement instrumentation. One method for realizing such isolation is to connect the reference clock input of the signal generator to the reference output of the frequency counter, to confirm that any frequency instability is associated with the EUT, and is not due to differences between the reference oscillators internal to the measurement instrumentation.

(b) Frequency measurements shall be made at the extremes of the specified temperature range and at intervals of not more than 10° centigrade through the range. A period of time sufficient to stabilize all of the components of the oscillator circuit at each temperature level shall be allowed prior to frequency measurement. The short term transient effects on the frequency of the transmitter due to keying (except for broadcast transmitters) and any heating element cycling normally occurring at each ambient temperature level also shall be shown. Only the portion or portions of the transmitter containing the frequency determining and stabilizing circuitry need be subjected to the temperature variation test.

Test Setup Block Diagram:

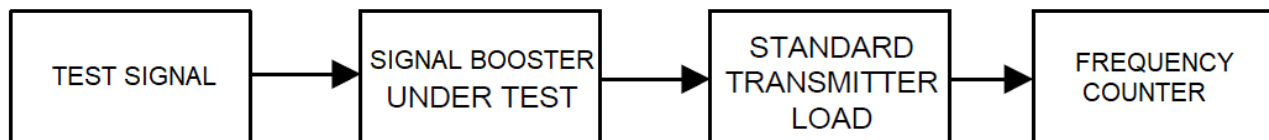

RESULT: Not Applicable to EUT.

FIELD STRENGTH OF SPURIOUS EMISSIONS

Rule Part No.: KDB 935210 s.4.9, FCC Part 2.1053(a), FCC Pt. 90.219(e)(3)

Refer to the applicable rule part(s) for specified limits on unwanted (out-of-band/out-of-block and spurious) emissions (e.g., Section 90.210).

Requirements:

(e) *Device Specifications.* In addition to the general rules for equipment certification in §90.203(a)(2) and part 2, subpart J of this chapter, a signal booster must also meet the rules in this paragraph.

(3) Spurious emissions from a signal booster must not exceed -13 dBm within any 100 kHz measurement bandwidth.

Test Procedure: KDB 935210 s.4.7.3, TIA 603-E

Spurious emissions shall be measured using a single test signal sequentially tuned to the low, middle, and high channels or frequencies within each authorized frequency band of operation.

- a) Connect a signal generator to the input of the EUT.
- b) Configure the signal generator to produce a CW signal.
- c) Set the frequency of the CW signal to the center channel of the EUT passband.
- d) Set the output power level so that the resultant signal is just below the AGC threshold (see 4.2).
- e) Connect a spectrum analyzer to the output of the EUT, using appropriate attenuation as necessary.
- f) Set the RBW = 100 kHz. (i.e., for 30 MHz to 1 GHz PLMRS and/or PSRS booster devices)
- g) Set the VBW = $3 \times$ RBW.
- h) Set the Sweep time = auto-couple.
- i) Set the detector to PEAK.
- j) Set the spectrum analyzer start frequency to 30 MHz (or the lowest radio frequency signal generated in the EUT, without going below 9 kHz if the EUT has additional internal clock frequencies), and the stop frequency to 10 times the highest allowable frequency of the EUT passband.
- k) Select MAX HOLD, and use the marker peak function to find the highest emission(s) outside the passband. (This could be either at a frequency lesser or greater than the passband frequencies.)
- l) Capture a plot for inclusion in the test report.
- m) Repeat steps c) to l) for each authorized frequency band/block of operation.

FIELD STRENGTH OF SPURIOUS EMISSIONS

Test Site Setup:

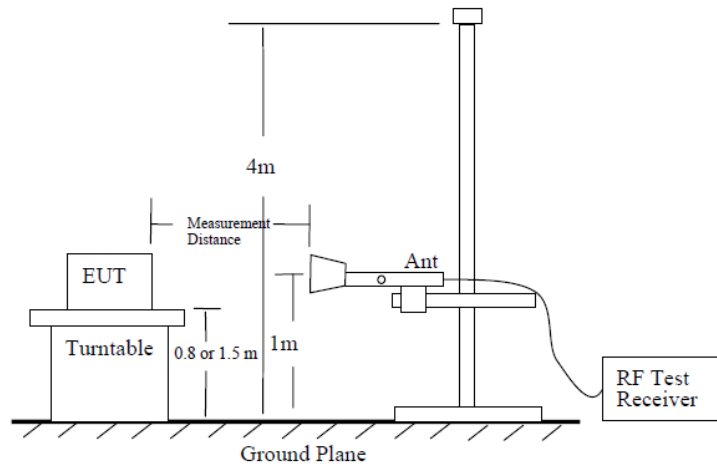

EUT Orientation(s):

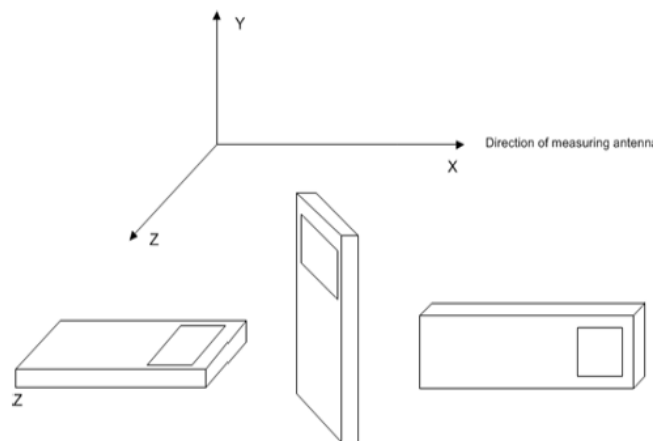

Note: The tabulated data shows the results of the radiated field strength emissions test. The spectrum was scanned from the lowest frequency generated internally to at least the tenth harmonic of the fundamental. This test was conducted in accordance with the standard listed above using the substitution method. Measurements were made at the test site of TIMCO ENGINEERING, INC. located at 849 NW State Road 45, Newberry, FL 32669. The measurements below represent the worst case of all the frequencies tested.

Note: Six (6) or more of the highest emissions of each worst-case operational mode of the EUT are represented below. Emissions 20 dB below the limit were not required to be reported.

FIELD STRENGTH OF SPURIOUS EMISSIONS

800 Band Radiated Spurious Emissions

Test Data: Uplink, 816.96875 MHz

Tuned Frequency (MHz)	Emission Frequency (MHz)	Detector	Meter Reading (dBµV)	Antenna Polarity	Coax Loss (dB)	Correction Factor (dB/m)	Distance (m)	Field Strength (dBµV/m)	ERP (dBm)	Limit (dBm)	Margin (dBm)
816.97	1633.90	PK	2.04	H	4.71	28.43	3.00	35.18	-62.20	-13.00	49.20
816.97	1633.90	PK	-0.13	V	4.71	28.43	3.00	33.01	-64.37	-13.00	51.37
816.97	2450.90	PK	0.35	H	5.62	31.85	3.00	37.82	-59.56	-13.00	46.56
816.97	2450.90	PK	0.02	V	5.62	31.85	3.00	37.49	-59.89	-13.00	46.89
816.97	3267.90	PK	-0.32	H	6.66	32.66	3.00	39.00	-58.38	-13.00	45.38
816.97	3267.90	PK	0.10	V	6.66	32.66	3.00	39.42	-57.96	-13.00	44.96
816.97	4084.80	PK	-1.68	H	7.13	33.39	3.00	38.84	-58.54	-13.00	45.54
816.97	4084.80	PK	-2.12	V	7.13	33.39	3.00	38.40	-58.98	-13.00	45.98
816.97	4901.80	PK	0.80	H	7.35	33.92	3.00	42.07	-55.31	-13.00	42.31
816.97	4901.80	PK	-1.82	V	7.35	33.92	3.00	39.45	-57.93	-13.00	44.93
816.97	5718.80	PK	-0.19	H	8.17	34.62	3.00	42.60	-54.78	-13.00	41.78
816.97	5718.80	PK	-2.73	V	8.17	34.62	3.00	40.06	-57.32	-13.00	44.32
816.97	6535.80	PK	-2.19	H	9.11	35.55	3.00	42.47	-54.91	-13.00	41.91
816.97	6535.80	PK	-0.73	V	9.11	35.55	3.00	43.93	-53.45	-13.00	40.45
816.97	7352.70	PK	-2.00	H	9.45	36.16	3.00	43.61	-53.77	-13.00	40.77
816.97	7352.70	PK	-1.21	V	9.45	36.16	3.00	44.40	-52.98	-13.00	39.98
816.97	8169.70	PK	-1.47	H	9.99	35.80	3.00	44.32	-53.06	-13.00	40.06
816.97	8169.70	PK	-1.76	V	9.99	35.80	3.00	44.03	-53.35	-13.00	40.35

Test Data: Downlink, 861.96875 MHz

Tuned Frequency (MHz)	Emission Frequency (MHz)	Detector	Meter Reading (dBµV)	Antenna Polarity	Coax Loss (dB)	Correction Factor (dB/m)	Distance (m)	Field Strength (dBµV/m)	ERP (dBm)	Limit (dBm)	Margin (dBm)
861.97	1723.90	PK	0.78	V	4.81	29.38	3.00	34.97	-62.41	-13.00	49.41
861.97	1723.90	PK	-0.10	H	4.81	29.38	3.00	34.09	-63.29	-13.00	50.29
861.97	2585.90	PK	-1.27	V	5.77	32.46	3.00	36.96	-60.42	-13.00	47.42
861.97	2585.90	PK	-0.63	H	5.77	32.46	3.00	37.60	-59.78	-13.00	46.78
861.97	3447.90	PK	-1.76	V	6.83	32.60	3.00	37.67	-59.70	-13.00	46.70
861.97	3447.90	PK	-0.10	H	6.83	32.60	3.00	39.33	-58.04	-13.00	45.04
861.97	4309.80	PK	-1.96	V	7.24	33.48	3.00	38.76	-58.62	-13.00	45.62
861.97	4309.80	PK	-0.37	H	7.24	33.48	3.00	40.35	-57.03	-13.00	44.03
861.97	5171.80	PK	-2.91	V	7.84	34.13	3.00	39.06	-58.32	-13.00	45.32
861.97	5171.80	PK	2.56	H	7.84	34.13	3.00	44.53	-52.85	-13.00	39.85
861.97	6033.80	PK	-3.11	V	8.64	35.16	3.00	40.70	-56.68	-13.00	43.68
861.97	6033.80	PK	-2.60	H	8.64	35.16	3.00	41.20	-56.18	-13.00	43.18
861.97	6895.80	PK	-1.56	V	9.22	35.93	3.00	43.59	-53.78	-13.00	40.78
861.97	6895.80	PK	-1.35	H	9.22	35.93	3.00	43.80	-53.57	-13.00	40.57
861.97	7757.70	PK	0.51	V	10.12	35.87	3.00	46.50	-50.87	-13.00	37.87
861.97	7757.70	PK	0.28	H	10.12	35.87	3.00	46.27	-51.10	-13.00	38.10
861.97	8619.70	PK	-3.42	V	10.17	36.03	3.00	42.78	-54.60	-13.00	41.60
861.97	8619.70	PK	-0.77	H	10.17	36.03	3.00	45.43	-51.95	-13.00	38.95

STATEMENT OF MEASUREMENT UNCERTAINTY

The data and results referenced in this document are true and accurate. The measurement uncertainty was calculated for all measurements listed in this test report according To CISPR 16-4 or ENTR 100-028 Specification for radio disturbance and immunity measuring apparatus and methods – Part 4: “Uncertainty in EMC Measurements” and is documented in the Timco Engineering, Inc. quality system according to DIN EN ISO/IEC 17025. Furthermore, component and process variability of devices similar to that tested may result in additional deviation. The manufacturer has the sole responsibility of continued compliance of the device.

Hereafter the best measurement capability for Timco Engineering, Inc. is reported:

Test Items	Measurement Uncertainty	Notes
RF Frequency Accuracy	± 49.5 Hz	(1)
RF Conducted Power	±0.93dB	(1)
Conducted spurious emission of transmitter valid up to 40GHz	±1.86dB	
Occupied Bandwidth	±2.65%	
Radiated RF Power	±1.4dB	
Rad Emissions Sub Meth up to 26.5GHz	±2.14dB	
Adjacent channel power	±0.93dB	(1)

Notes: (1) This uncertainty represents an expanded uncertainty expressed at approximately the 95% confidence level using a coverage factor of k=1.96.

EMC EQUIPMENT LIST

Device	Manufacturer	Model	Serial Number	Cal/Char Date	Due Date
CHAMBER	Panashield	3M	N/A	03/12/19	03/12/21
Antenna: Biconical 1057	Eaton	94455-1	1057	12/13/17	12/13/19
Antenna: Log-Periodic 1243	Eaton	96005	1243	04/20/18	04/20/21
Antenna: Double-Ridged Horn/ETS Horn 1	ETS-Lindgren	3117	00035923	01/30/17	01/30/20
Coaxial Cable - Chamber 3 cable set (backup)	Micro-Coax	Chamber 3 cable set (backup)	KMKM-0244-02 KMKM-0670-01 KFKF-0197-00	02/27/19	02/27/21
Chamber Pre-amplifier	RF-LAMBDA	RLNA00M45GA	NA	02/27/19	02/27/21
Software: Field Strength Program	Timco	N/A	Version 4.10.7.0	N/A	N/A
EMI Test Receiver R & S ESU 40	Rohde & Schwarz	ESU 40	100320	08/28/18	08/28/20
Comb Generator	Com-Power Corp	CGO-515	291728	NA	NA
Attenuator N 30dB 100W DC-6G	Pasternack	PE7214-30	#110	07/16/19	07/16/21
Attenuator N 3dB 10W DC-18G	Pasternack	PE7015-3	#21	07/16/19	07/16/21
Coaxial Cable #101 - NMNM-0180-01 Aqua DC-40G	Micro-Coax	UFB311A-0-0720-50U50U	225362-002 (#101)	07/16/19	07/16/21
Terminator N 20W DC-18G	Narda	8205	#14	07/16/19	07/16/21
Splitter 1-1000MHz	Mini-Circuits	ZFSC-4-1-BNC+	U115700825	11/19/17	11/19/19
Coaxial Cable #100 - NMNM-0180-00 Aqua	Micro-Coax	UFB311A-0-0720-50U50U	225362-001 (#100)	07/15/19	07/15/21
Coaxial Cable - BMBM-0122-01 RG400	Pasternack	PE3582LF-48	BMBM-0122-01	07/15/19	07/15/21
Coaxial Cable - BMBM-0122-02 RG400	Pasternack	PE3582LF-48	BMBM-0122-02	07/15/19	07/15/21

*EMI RECEIVER SOFTWARE VERSION

The receiver firmware used was version 4.43 Service Pack 3

END OF TEST REPORT