



849 NW STATE ROAD 45
 NEWBERRY, FL 32669 USA
 PH: 888.472.2424 OR 352.472.5500
 FAX: 352.472.2030
 EMAIL: INFO@TIMCOENGR.COM
[HTTP://WWW.TIMCOENGR.COM](http://WWW.TIMCOENGR.COM)

**AMPLIFIER
 FCC PART 90
 TEST REPORT**

Applicant	FIPLEX COMMUNICATIONS INC.
Address	7331 N.W. 54TH STREET MIAMI FL 33166 USA
FCC ID	P3TDH440-HG-SCH-3
Model Number	DH440-HG-SCH-3
Product Description	UHF SINGLE CARRIER AMPLIFIER
Standards Applied	CFR 47 Part 90
Date Sample Received	06/16/2017
Date Report Issued	8/04/2017
Date Tested	06/27/2017, 07/05/2017, 08/04/2017
Tested By	Christian Pawlak
Approved By	Sid Sanders
Test Results	<input checked="" type="checkbox"/> PASS <input type="checkbox"/> FAIL

Report Number	Version Number	Description	Issue Date
1088CUT17TestReport	Rev1	Initial Issue	07/6/2017
1088CUT17TestReport	Rev2	Retest to KDB	08/04/2017

**THE ATTACHED REPORT SHALL NOT BE REPRODUCED EXCEPT IN FULL
 WITHOUT THE WRITTEN APPROVAL OF TIMCO ENGINEERING, INC.**

TABLE OF CONTENTS

GENERAL REMARKS	3
TEST RESULTS SUMMARY	5
AGC THRESHOLD §4.2	7
Test Data: AGC Threshold Measurement Table	7
NOISE FIGURE §4.6	23
OUT OF BAND / OUT OF BLOCK EMISSIONS (intermodulation) §4.7.....	24
Test Data: Measurement Table	24
Test Data: 12.5 kHz Intermodulation without AGC	25
Test Data: 12.5 kHz Intermodulation with AGC.....	26
Test Data: 25 kHz Intermodulation without AGC	27
Test Data: 25 kHz Intermodulation with AGC	28
ANTENNA CONDUCTED EMISSIONS §4.7	29
FIELD STRENGTH OF SPURIOUS RADIATION EMISSIONS §4.9	30
Test Data:	30
EQUIPMENT LIST	31
STATE OF THE MEASUREMENT UC –	32

GENERAL REMARKS

The attached report shall not be reproduced except in full without the written permission of Timco Engineering Inc.

Summary

The device under test does:

- Fulfill the general approval requirements as identified in this test report and was selected by the customer.
- Not fulfill the general approval requirements as identified in this test report

Attestations

This equipment has been tested in accordance with the standards identified in this test report. To the best of my knowledge and belief, these tests were performed using the measurement procedures described in this report.

All instrumentation and accessories used to test products for compliance to the indicated standards are calibrated regularly in accordance with ISO 17025 requirements.

I attest that the necessary measurements were made at:

Timco Engineering Inc.
849 NW State Road 45
Newberry, FL 32669



Tested by:

Name and Title: Christian Pawlak, Project Manager

Date: 08/04/2017

Reviewed and approved by:  _____

Name and Title: Sid Sanders, Engineer

Date: 8/7/2017

APPLICANT: FIPLEX COMMUNICATIONS INC.
FCC ID: P3TDH440-HG-SCH-3
REPORT #: 1088CUT17TestReport

[TABLE OF CONTENTS](#)

EUT DESCRIPTION

EUT Description	UHF SINGLE CARRIER AMPLIFIER
FCC ID	P3TDH440-HG-SCH-3
Model Number	DH440-HG-SCH-3
Operating Frequency	506 MHz – 511 MHz
Type of Emission	F1E, F3E
EUT Power Source	<input type="checkbox"/> 110–120Vac/50– 60Hz
	<input checked="" type="checkbox"/> DC Power 27V
	<input type="checkbox"/> Battery Operated Exclusively
Test Item	<input type="checkbox"/> Prototype
	<input type="checkbox"/> Pre-Production
	<input checked="" type="checkbox"/> Production
Type of Equipment	<input checked="" type="checkbox"/> Fixed
	<input type="checkbox"/> Mobile
	<input type="checkbox"/> Portable
Test Conditions	The temperature was 26°C with a relative humidity of 50%.
Revision History to the EUT	None
Test Exercise	The EUT was operated in a normal mode.
Applicable Standards	FCC CFR 47 Part 90.219, FCC Part 2, KDB 935210 DO 02 v03 02, DO5 v01r01, TIA-102.CAAA-D ,
Test Facility	Timco Engineering Inc. at 849 NW State Road 45 Newberry, FL 32669 USA.

TEST RESULTS SUMMARY

FCC RULE PART	Limit	TEST DESCRIPTION	RESULT PASS/FAIL
KDB 935210-DO5 v01r01 §4.5	Reporting Only	Input/output power	Pass
KDB 935210-DO5 v01r01 §4.2	Reporting Only	AGC Threshold	Pass
KDB 935210-DO5 v01r01 §4.3	Reporting Only	Out-Of-band rejection	Pass
KDB 935210-DO5 v01r01 §4.4	Reporting Only	Input-versus-output signal comparison	Pass
KDB 935210-DO5 v01r01 §4.6	Reporting Only	Noise Figure	Pass
47CFR90.210 AND KDB 935210-DO5 v01r01 §4.7.2	-13 dBm	Out-of-band/out-of- block Intermodulation	Pass
47CFR90.210 AND KDB 935210-DO5 v01r01 §4.7.3	-13 dBm	Spurious Emissions Conducted	Pass
47CFR90.213 AND KDB 935210-DO5 v01r01 §4.8	Refer to Table	Frequency Stability	N/A
47CFR90.210 AND KDB 935210-DO5 v01r01 §4.9	-13 dBm	Spurious emissions radiated	Pass

RF POWER OUTPUT

Rule Part No.: KDB 935210-DO5 v01r01 §4.5

Requirements: Report Only

Procedure: KDB935210 Measurement Guidance for Industrial Boosters
§ 4.5.1 General
§ 4.5.2 Determining Amplifier/Booster Gain

Test Data: Below AGC Threshold Measurement Table

Test Frequency (MHz)	Input (dBm)	Output (dBm)	Output (W)
506.2	-92	39.29	8.49
510.2	-92	39.18	8.28

Result meets requirements

AGC THRESHOLD §4.2

Rule Part No.: KDB 935210-DO5 v01r01 §4.2

Requirements: Report Only

Procedure: KDB935210 Measurement Guidance for Industrial Boosters
§ 4.2 Measuring AGC threshold

Setup Diagram:

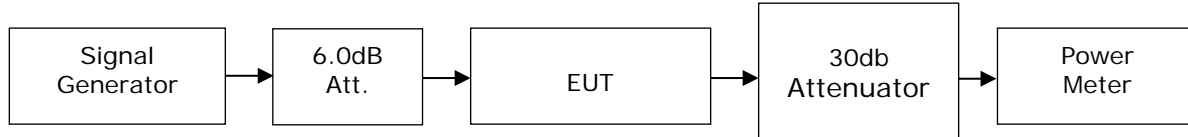

Test Data: AGC Threshold Measurement Table

Gen Freq (MHz)	Gen Output (dBm)	Insertion Loss (dB)	Input (dBm)	Output (dBm)
506.2	-88.5	3.5	-92	39.29
510.2	-88.5	3.5	-92	39.18

Result meets requirements

OUT-OF-BAND REJECTION § 4.3

Rule Part No.: KDB 935210-DO5 v01r01 §4.3

Requirements: Report Only

Procedure: KDB935210 § 4.3 Out of band rejection

Setup Diagram: Out-of-Band Rejection §4.3

Test Data: Low End of Band Plot

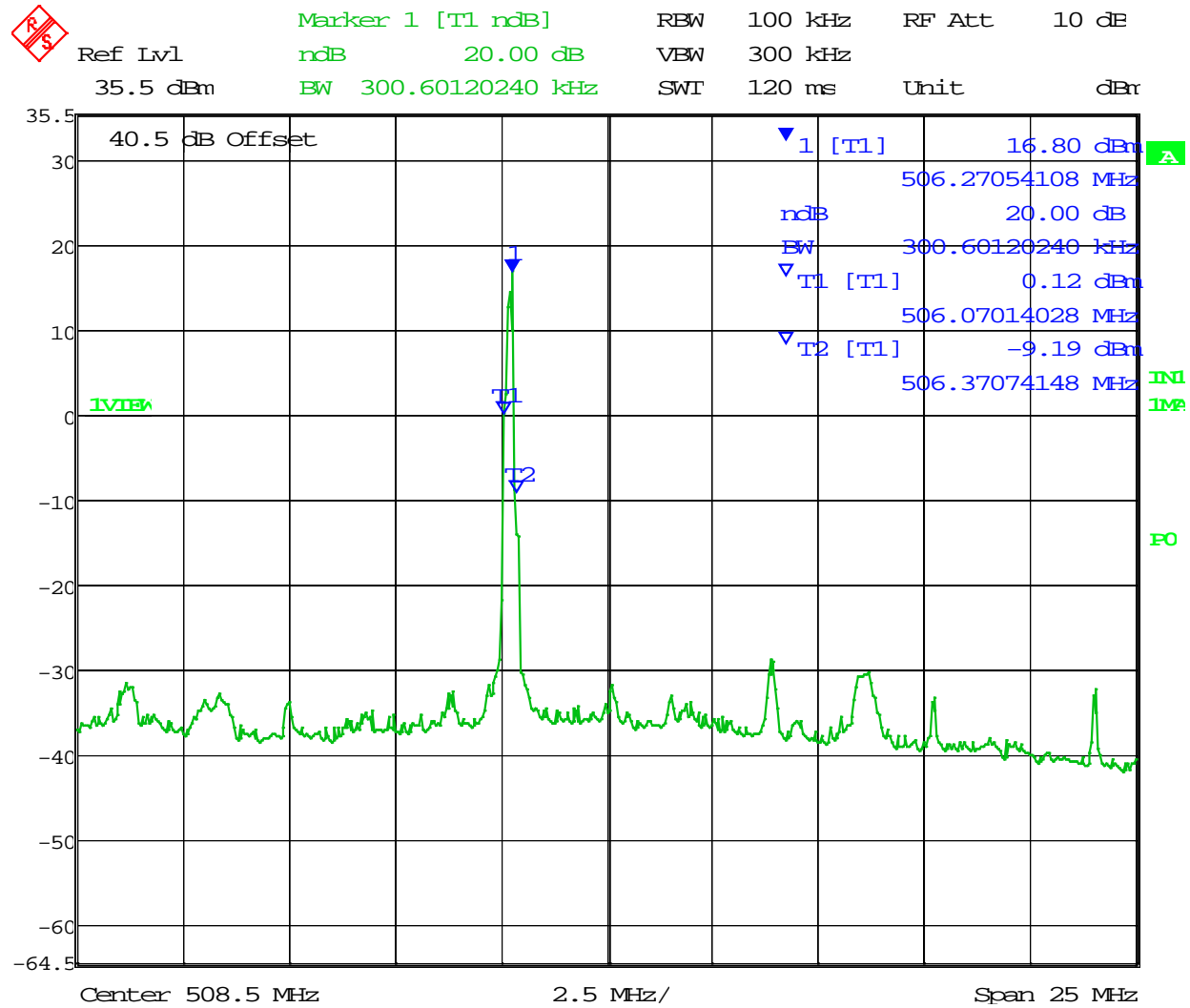

Date: 4.AUG.2017 15:17:19

Out-of-Band Rejection §4.3

Test Data: High End of Band Plot

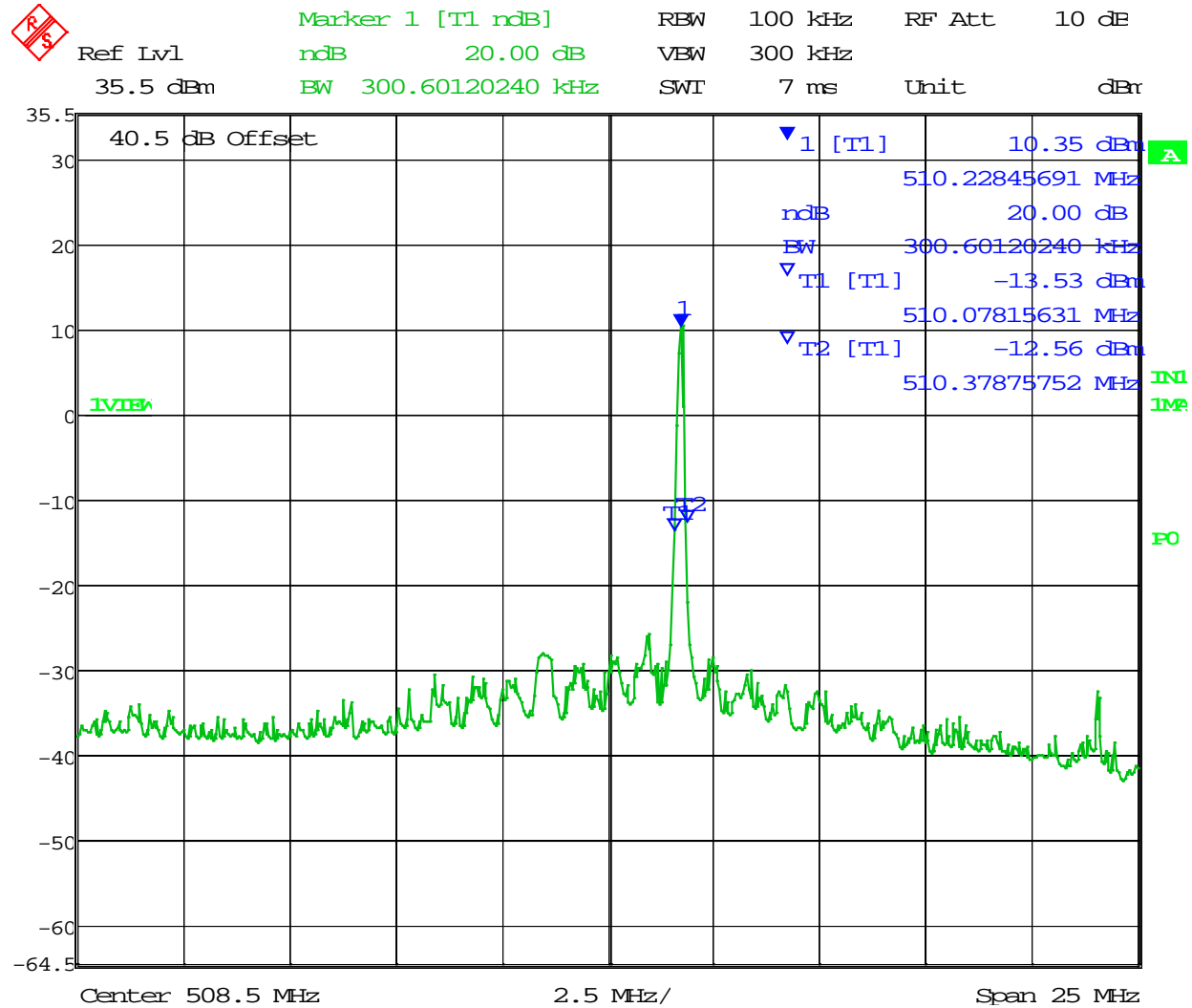

Date: 4.AUG.2017 15:28:12

INPUT-VERSUS-OUTPUT SIGNAL COMPARISON §4.4

Rule Part No.: KDB 935210-DO5 v01r01 §4.4

Requirements: A signal booster must be designed such that all signals that it retransmits meet the following requirements:

The signals are retransmitted on the same channels as received. Minor departures from the exact provider or reference frequencies of the input signals are allowed, provided that the retransmitted signals meet the requirements of §90.213.

There is no change in the occupied bandwidth of the retransmitted signals.

The retransmitted signals continue to meet the unwanted emissions limits of §90.210 applicable to the corresponding received signals (assuming that these received signals meet the applicable unwanted emissions limits by a reasonable margin).

Procedure: KDB935210 § 4.4 Input versus output signal comparison

The EUT was test for this requirement at 2 places in the band and the data below represents the worst case.

INPUT-VERSUS-OUTPUT SIGNAL COMPARISON §4.4

Test Data: High End of Band Input for 16K0F3E

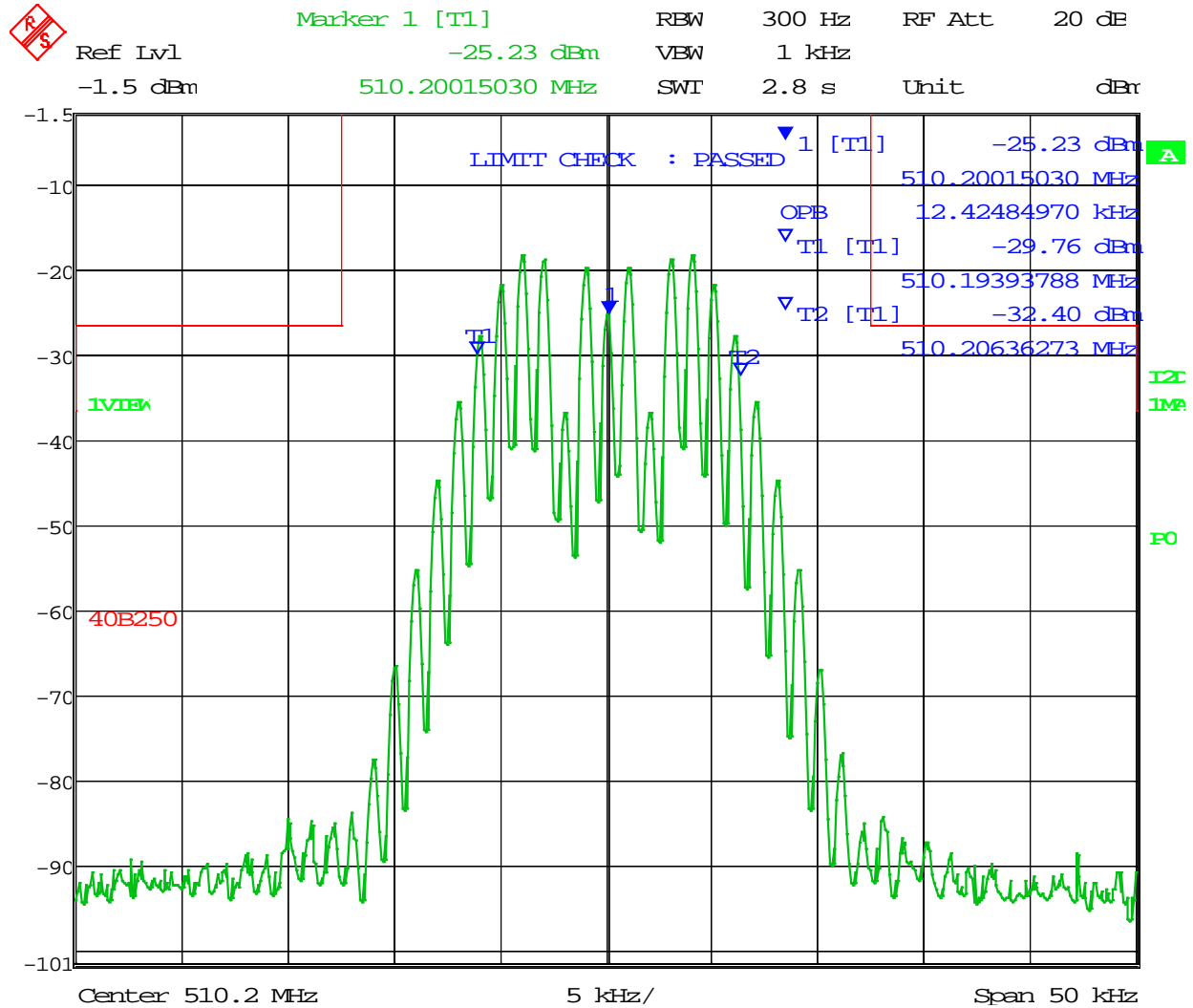

Date: 4.AUG.2017 15:59:31

INPUT-VERSUS-OUTPUT SIGNAL COMPARISON §4.4

Test Data: High End of Band Output without AGC for 16KOF3E

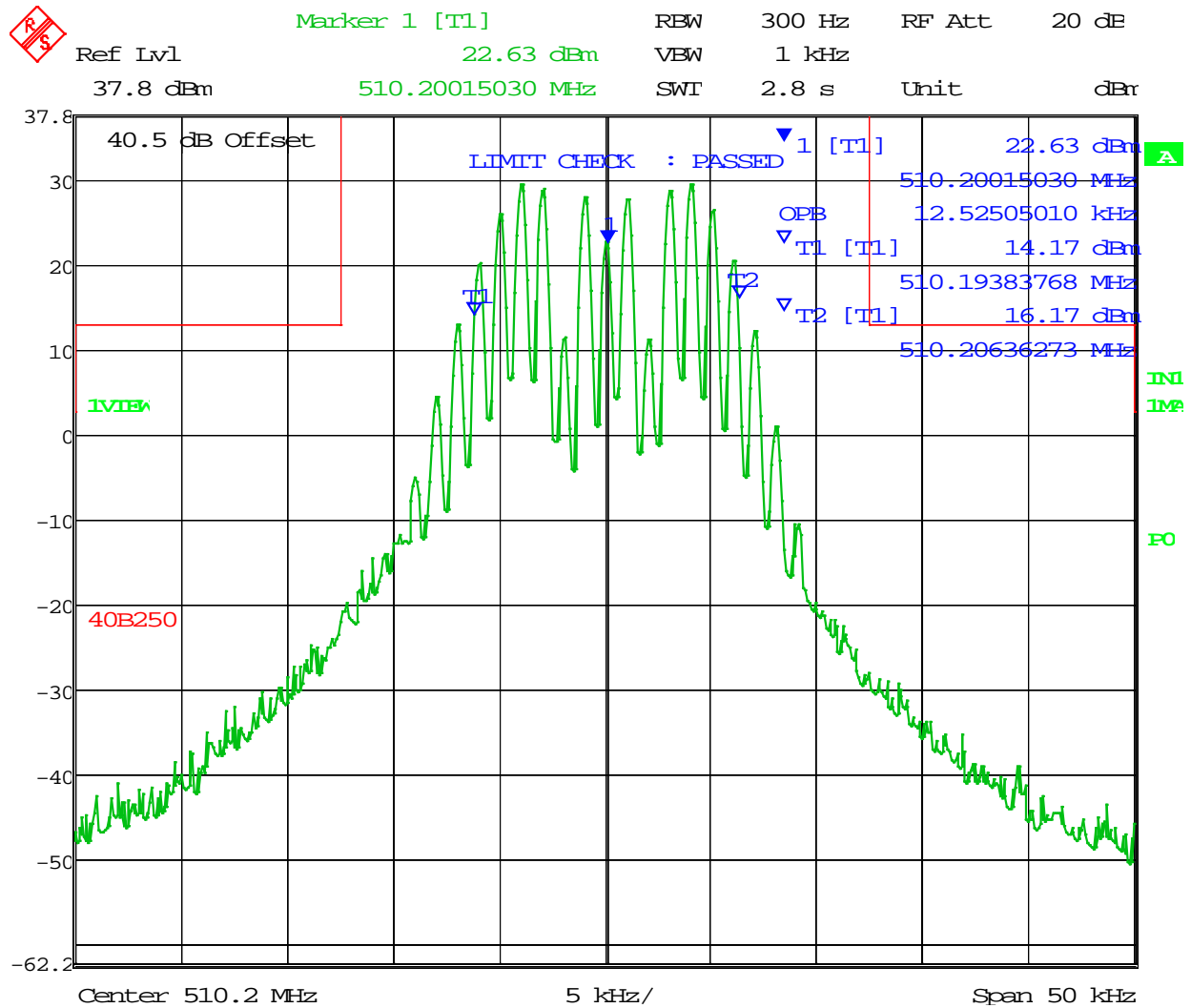

Date: 4.AUG.2017 15:40:52

INPUT-VERSUS-OUTPUT SIGNAL COMPARISON §4.4

Test Data: High End of Band Output with AGC for 16K0F3E

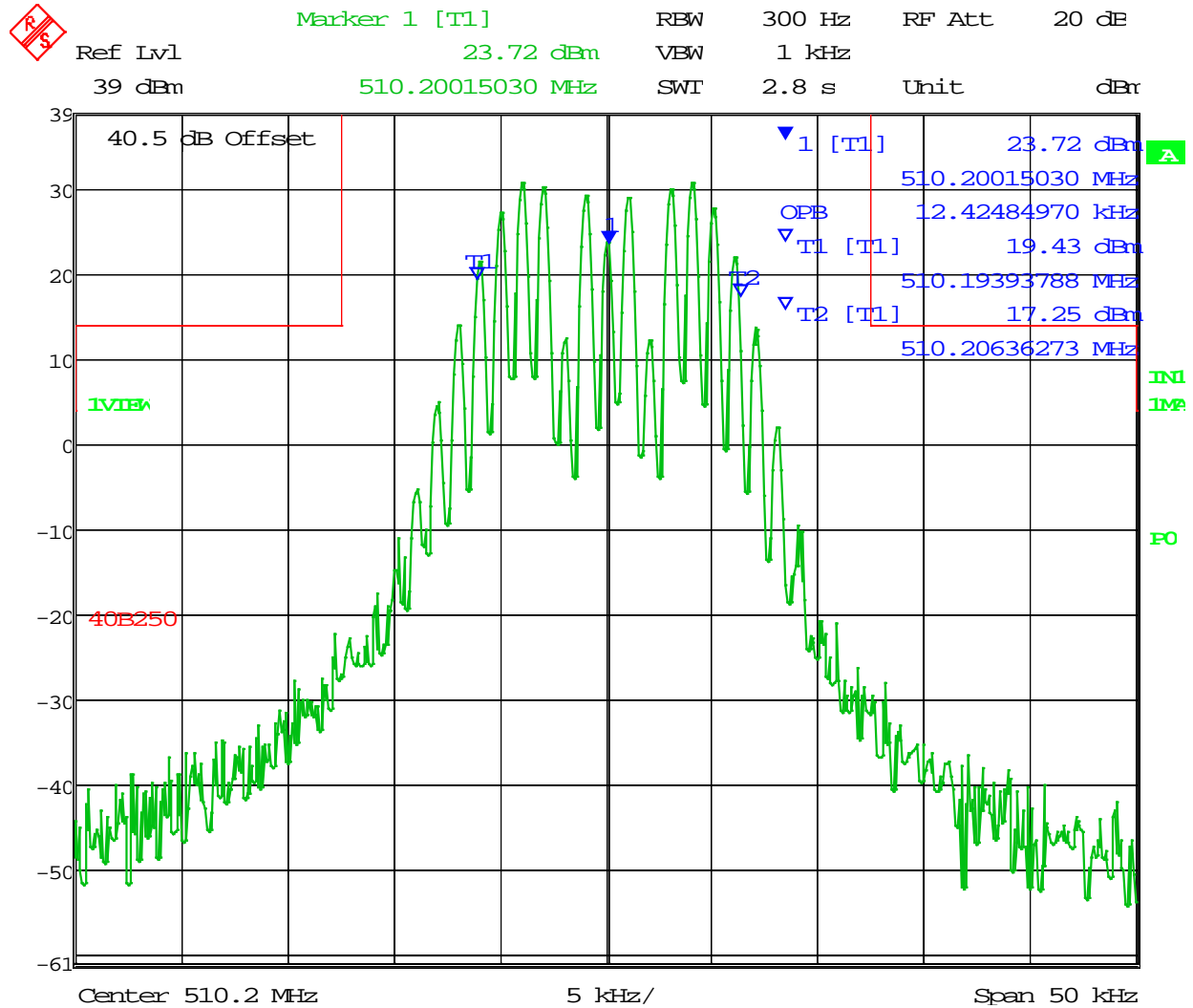

Date: 4.AUG.2017 15:39:41

INPUT-VERSUS-OUTPUT SIGNAL COMPARISON §4.4

Test Data: High End of Band Output without AGC for 11K3F3E

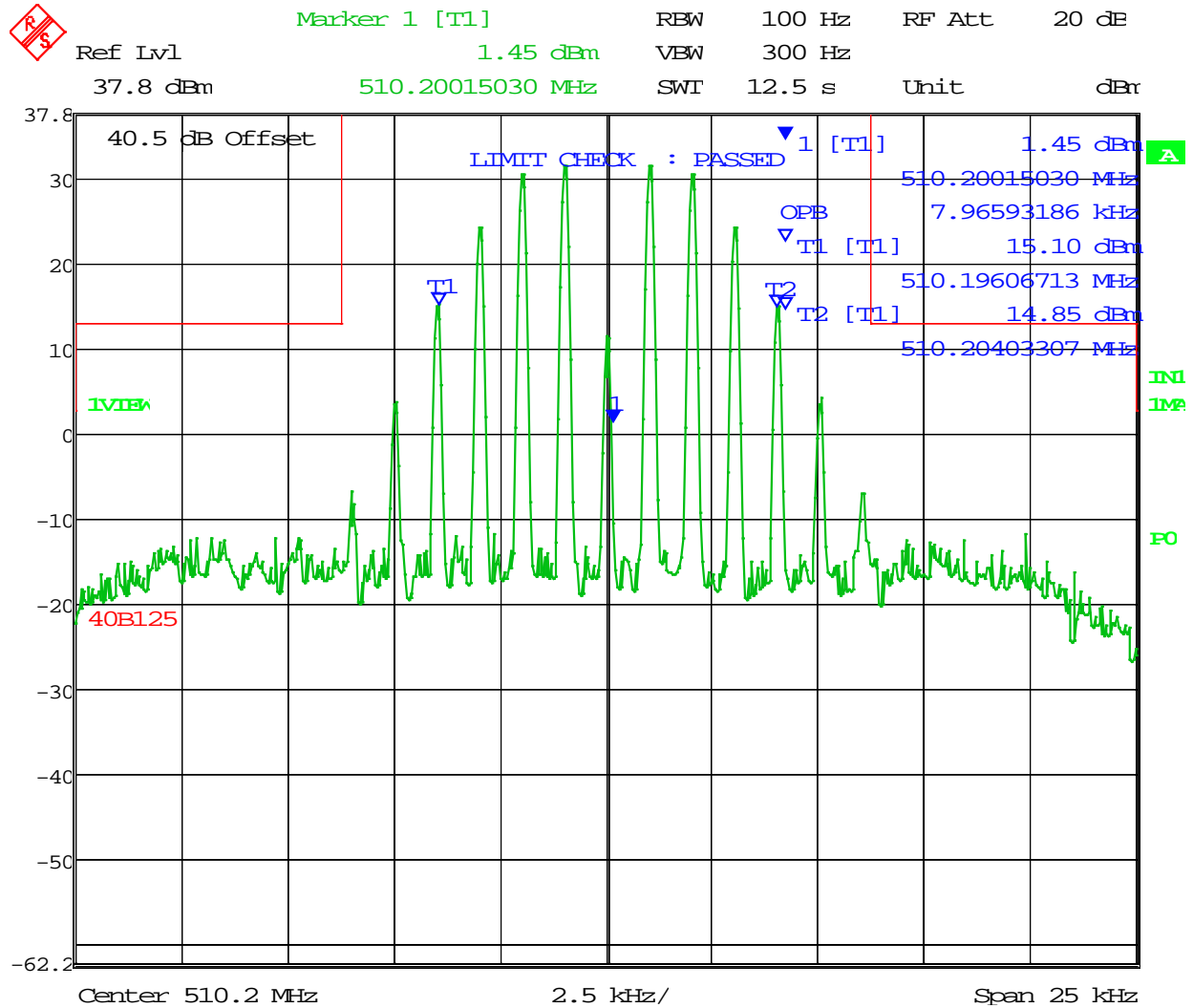

Date: 4.AUG.2017 16:09:38

INPUT-VERSUS-OUTPUT SIGNAL COMPARISON §4.4

Test Data: High End of Band Output with AGC for 11K3F3E

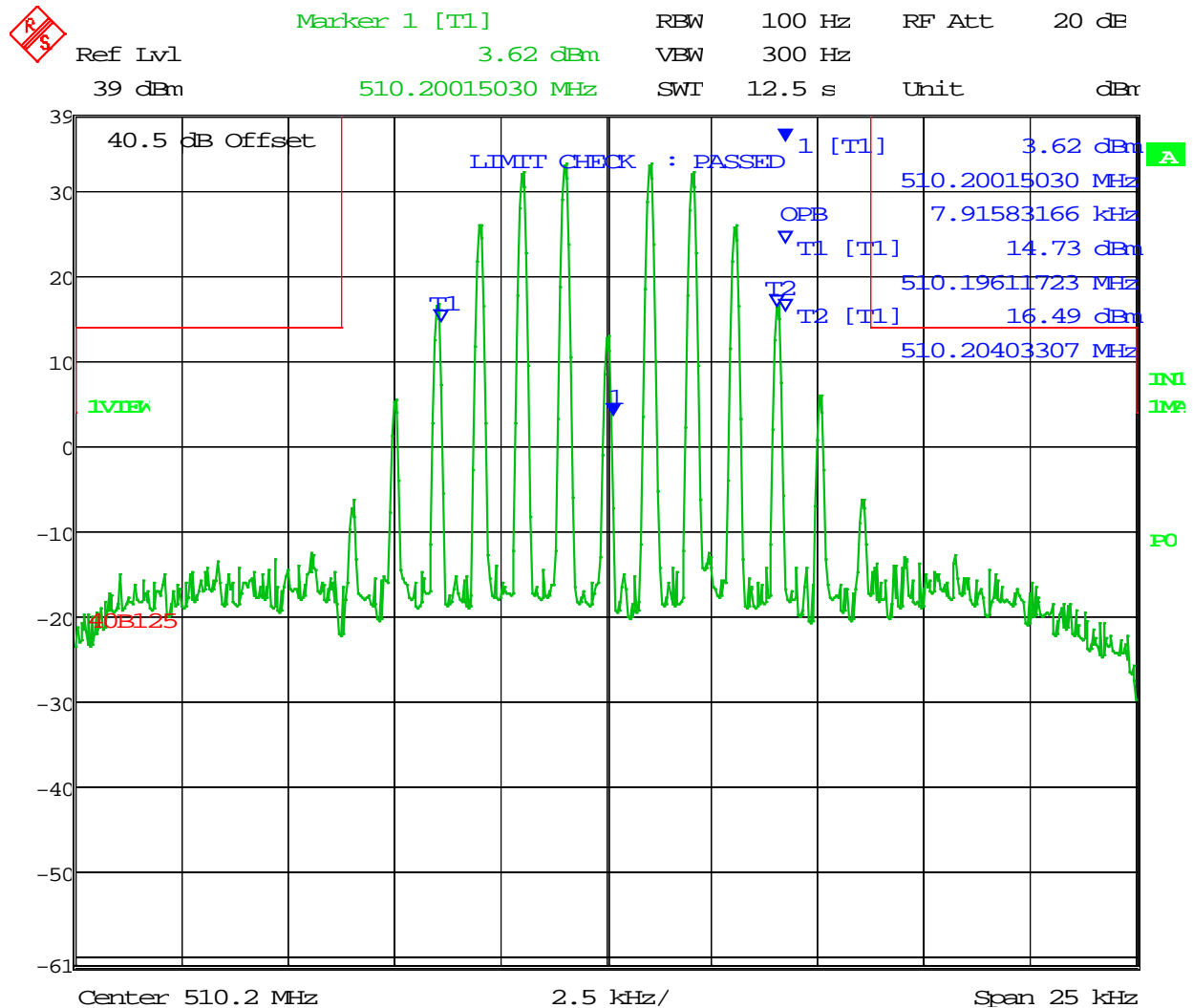

Date: 4.AUG.2017 16:06:00

INPUT-VERSUS-OUTPUT SIGNAL COMPARISON §4.4

Test Data: High End of Band Input for 8K10F1E

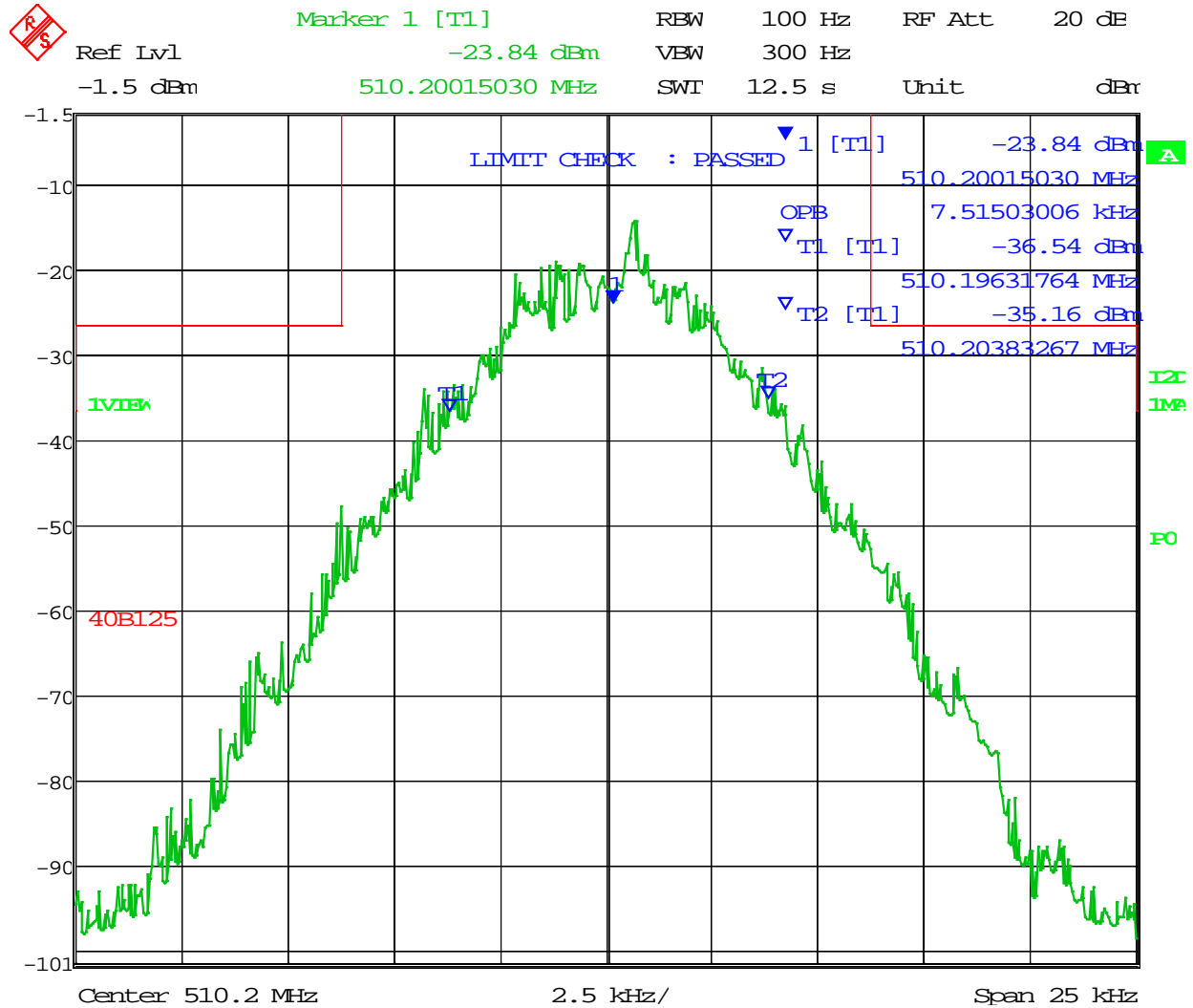

Date: 4.AUG.2017 16:01:59

INPUT-VERSUS-OUTPUT SIGNAL COMPARISON §4.4

Test Data: High End of Band Output without AGC for 8K10F1E

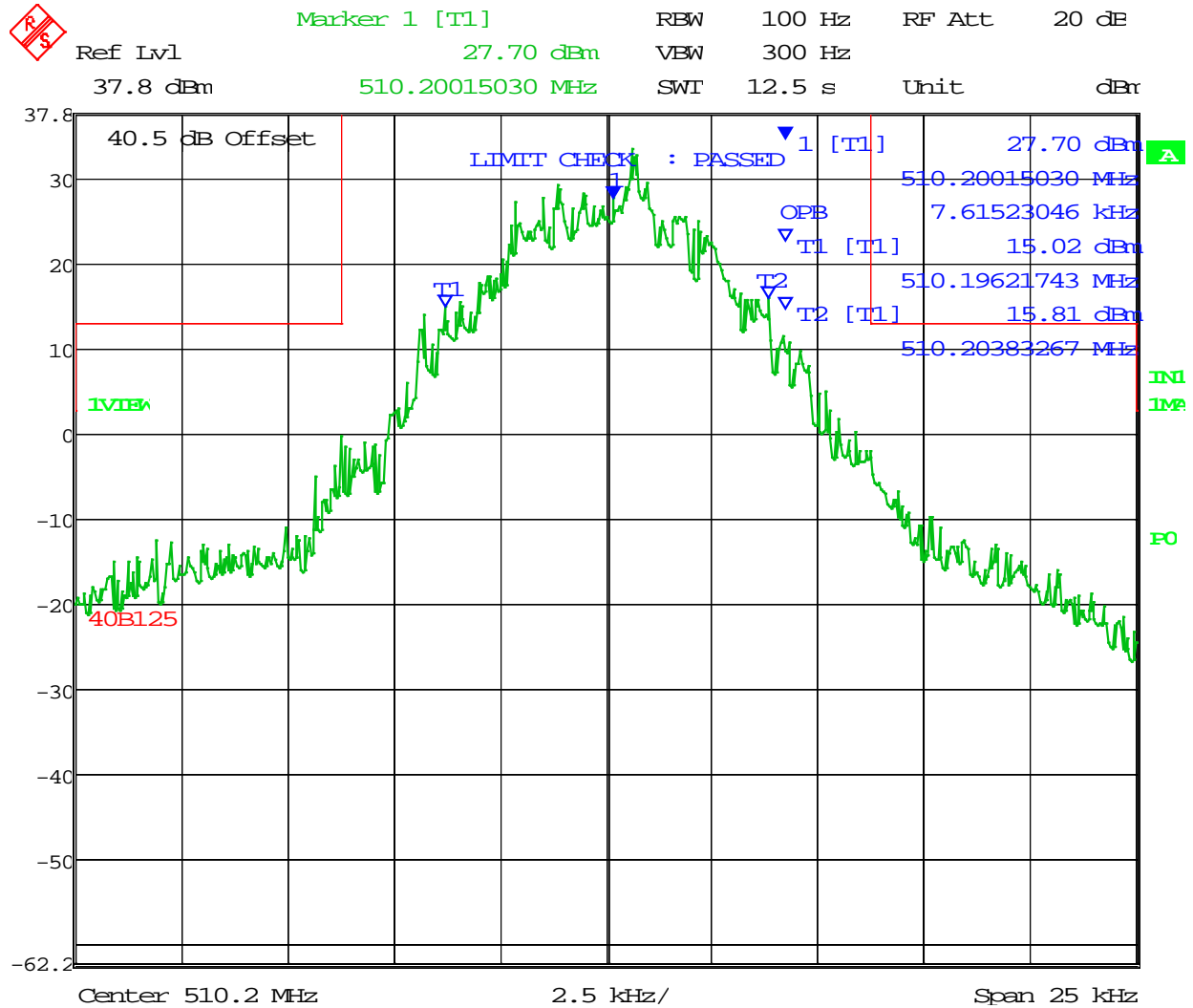

Date: 4.AUG.2017 16:08:32

INPUT-VERSUS-OUTPUT SIGNAL COMPARISON §4.4

Test Data: High End of Band Output with AGC for 8K10F1E

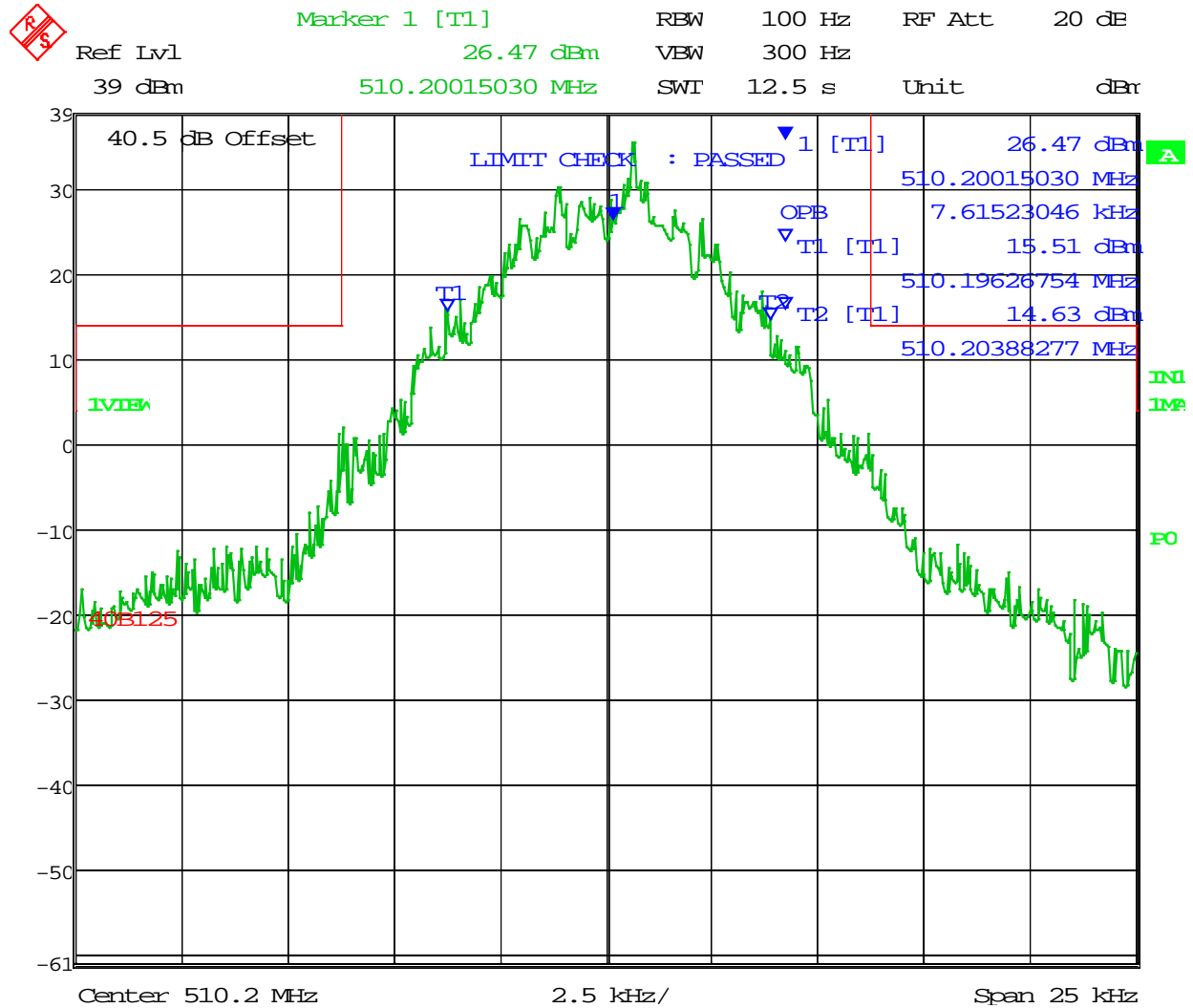

Date: 4.AUG.2017 16:07:17

INPUT-VERSUS-OUTPUT SIGNAL COMPARISON §4.4

Test Data: High End of Band Input for 20K0D1E

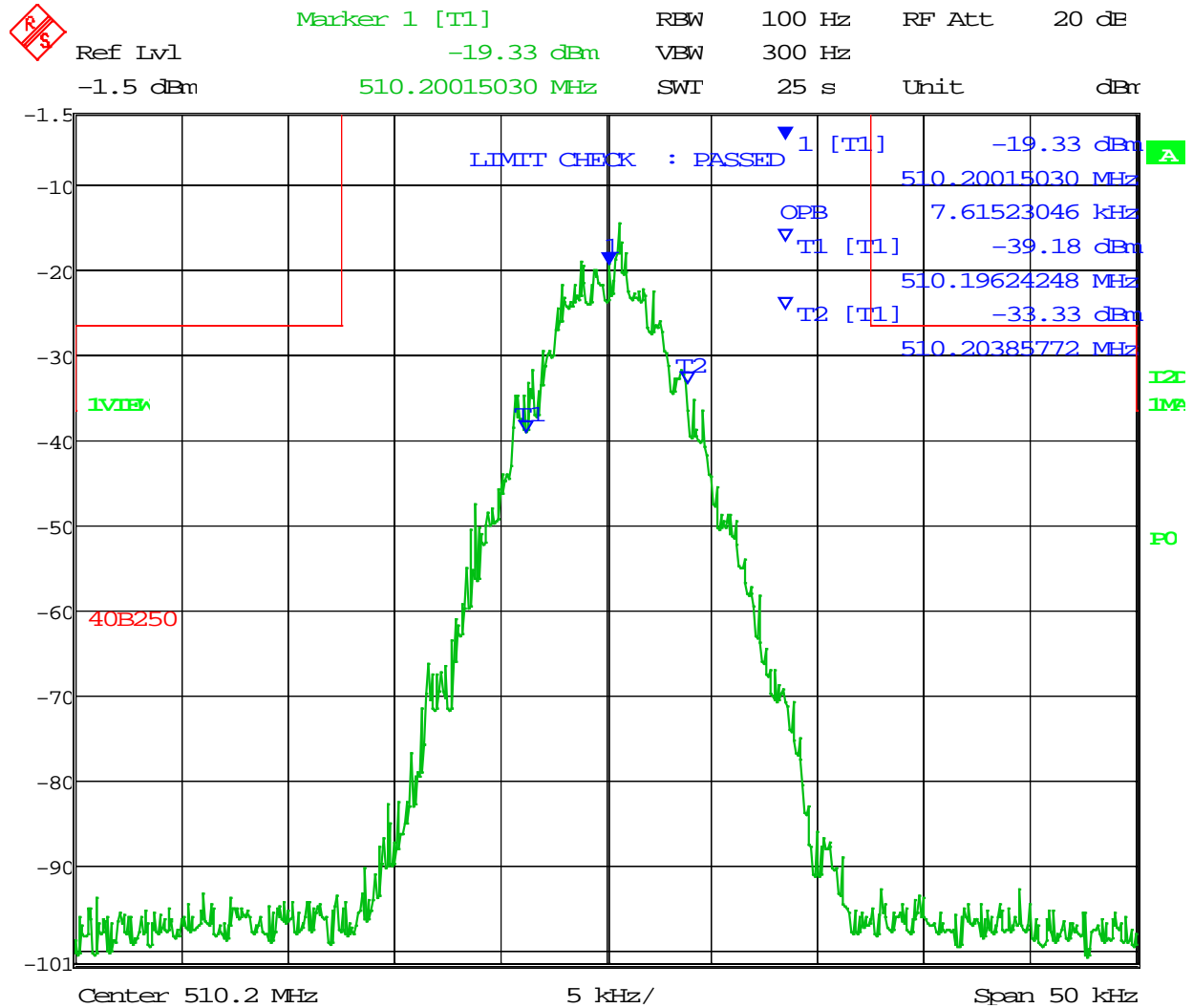

Date: 4.AUG.2017 15:58:23

INPUT-VERSUS-OUTPUT SIGNAL COMPARISON §4.4

Test Data: High End of Band Output without AGC for 20K0D1E

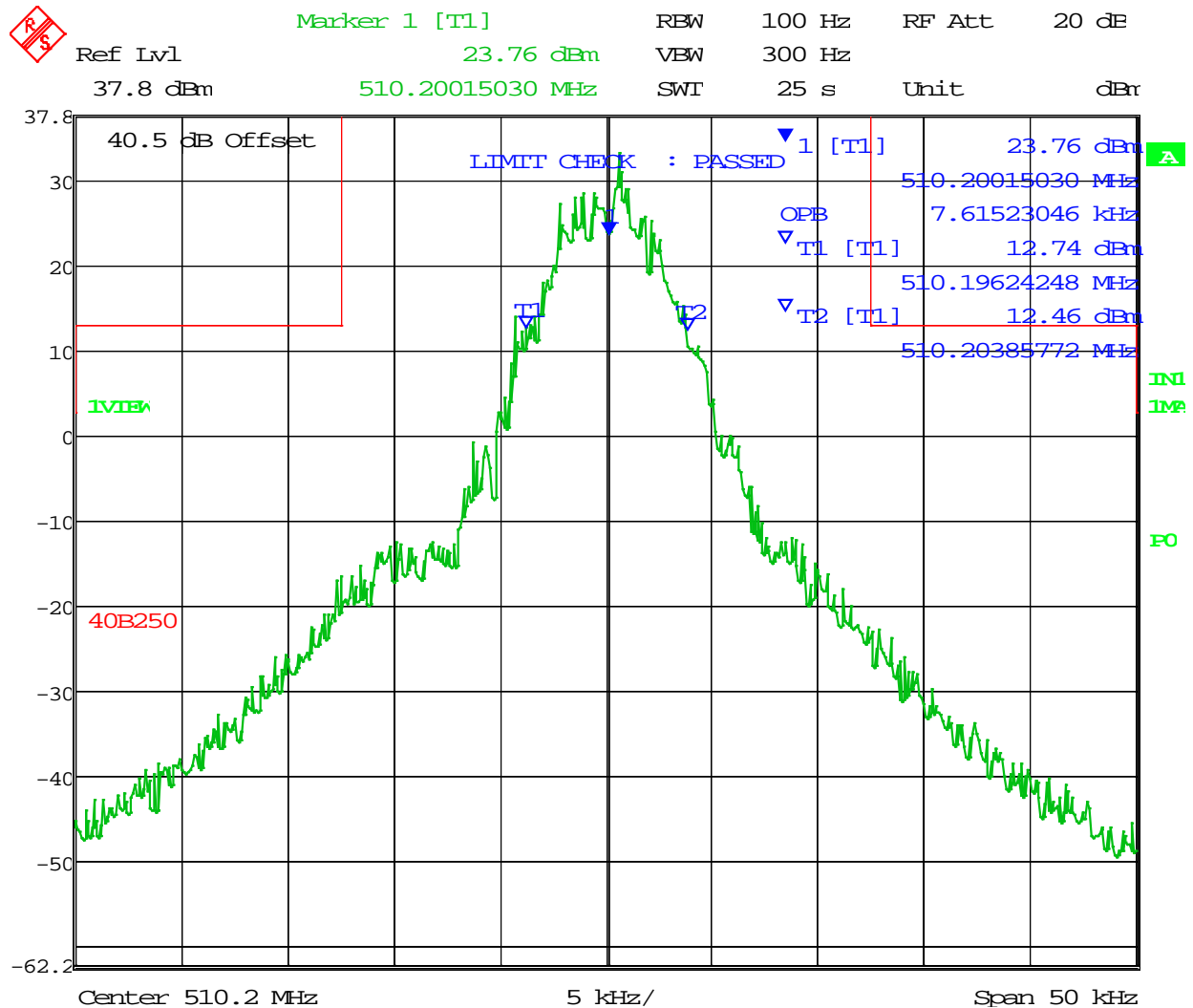

Date: 4.AUG.2017 15:54:26

INPUT-VERSUS-OUTPUT SIGNAL COMPARISON §4.4

Test Data: High End of Band Output with AGC for 20K0D1E

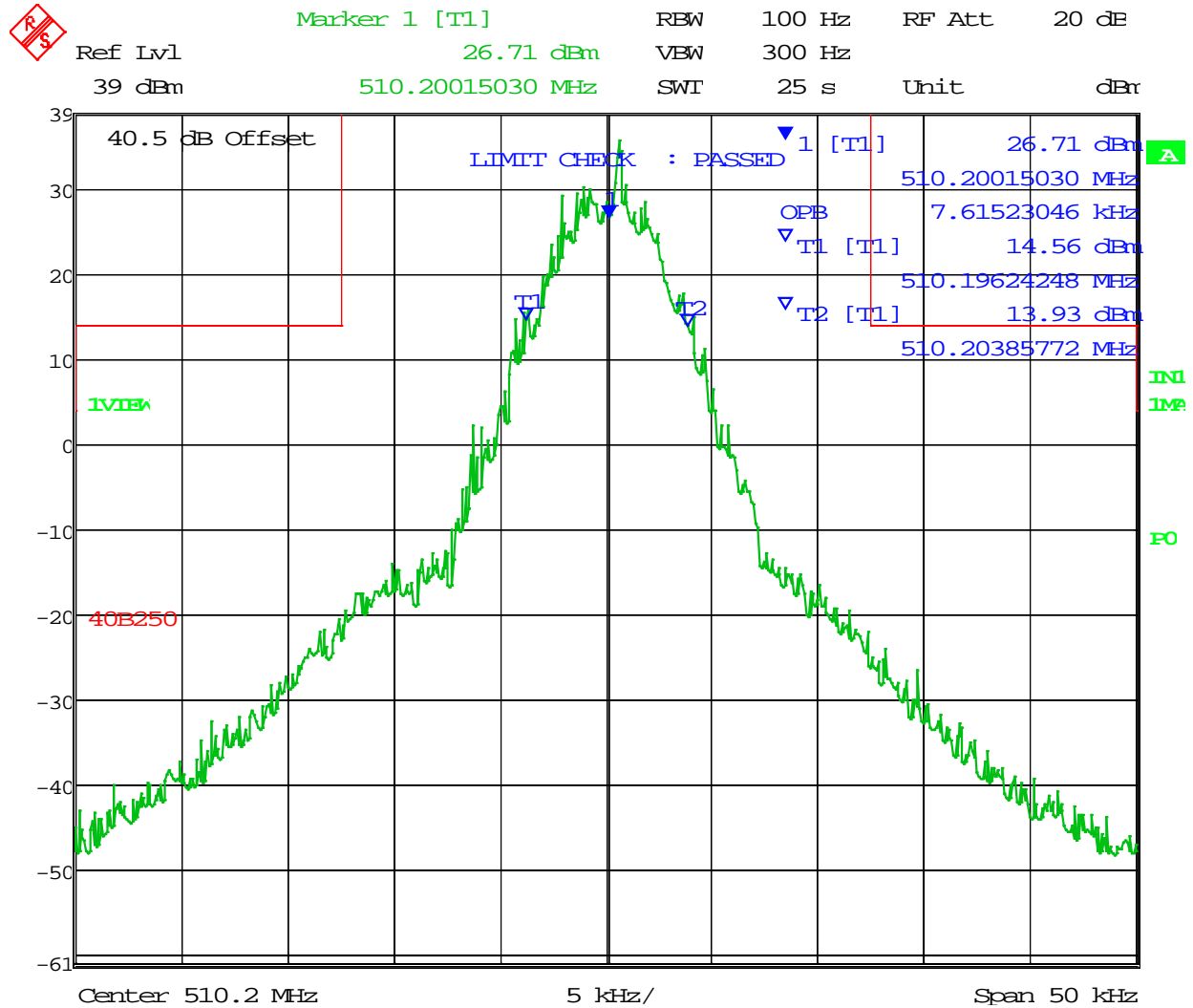

Date: 4.AUG.2017 15:56:17

NOISE FIGURE §4.6

Rule Part No.: KDB 935210-DO5 v01r01 §4.6

Requirements: Report Only

Procedure: KDB935210 Measurement Guidance for Industrial Boosters
§ 4.6 Noise Figure Measurements

1MA178_2e R&S Application Note the Y Factor Technique Noise Figure
§ 2 Background Theory and Equations
§ 3 Detailed Measurement Steps

Setup Diagram:

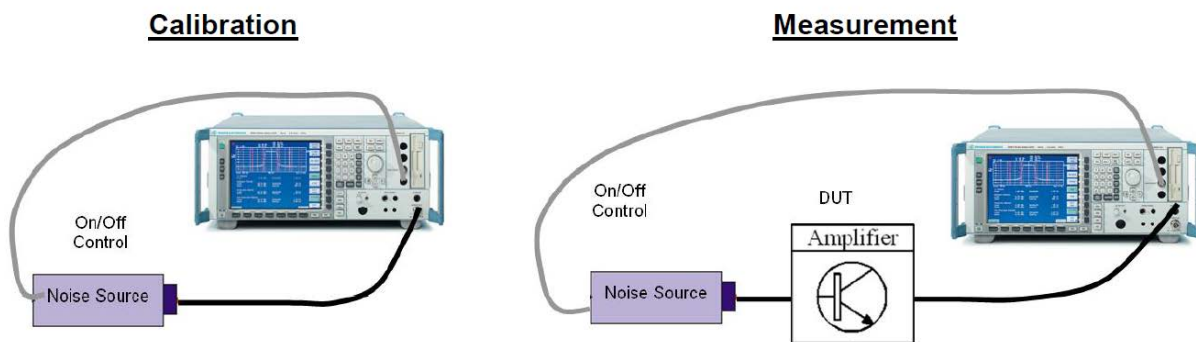

Test Data: Noise Figure Measurement Table

Ambient Temperature (°C)	26.00
Ambient Temperature (°K)	299.15
Noise Source ENR (dB)	15.04
N1 (dB)	-3.57
N2 (dB)	3.71
Y(dB)	7.28
Y	5.35
Noise Factor	3.57
Noise Figure (dB)	5.53

Results Meet Requirements

OUT OF BAND / OUT OF BLOCK EMISSIONS (intermodulation) §4.7

Rule Part No.: 47CFR90.210, KDB 935210-DO5 v01r01 §4.7.2

Requirements: - 13 dBm in any 100 KHz Bandwidth

Procedure: KDB935210 Measurement Guidance for Industrial Boosters
 § 4.7.1 General
 § 4.7.2 Out of Band/ Out of block emissions conducted measurements

Setup Diagram:

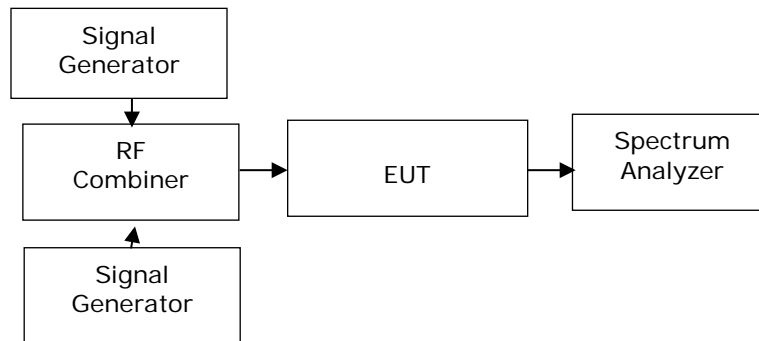

Test Data: Measurement Table

CH Spacing (KHz)	f0 (MHz)	Input Level (dBm)	Low Freq (MHz)	High Freq (MHz)	Read Level (dBm)	Limit (dBm)	Margin (dB)
12.50	510.2	-92.0	510.18750	510.21250	-20.51	-13.00	7.51
12.50	510.2	-89.0	510.18750	510.21250	-13.75	-13.00	0.75
25.00	510.2	-92.0	510.17500	510.22500	-45.46	-13.00	32.46
25.00	510.2	-89.0	510.17500	510.22500	-49.24	-13.00	36.24

Out-of-band/out-of-block Emissions(including intermodulation) §4.7.2

Test Data: 12.5 kHz Intermodulation without AGC

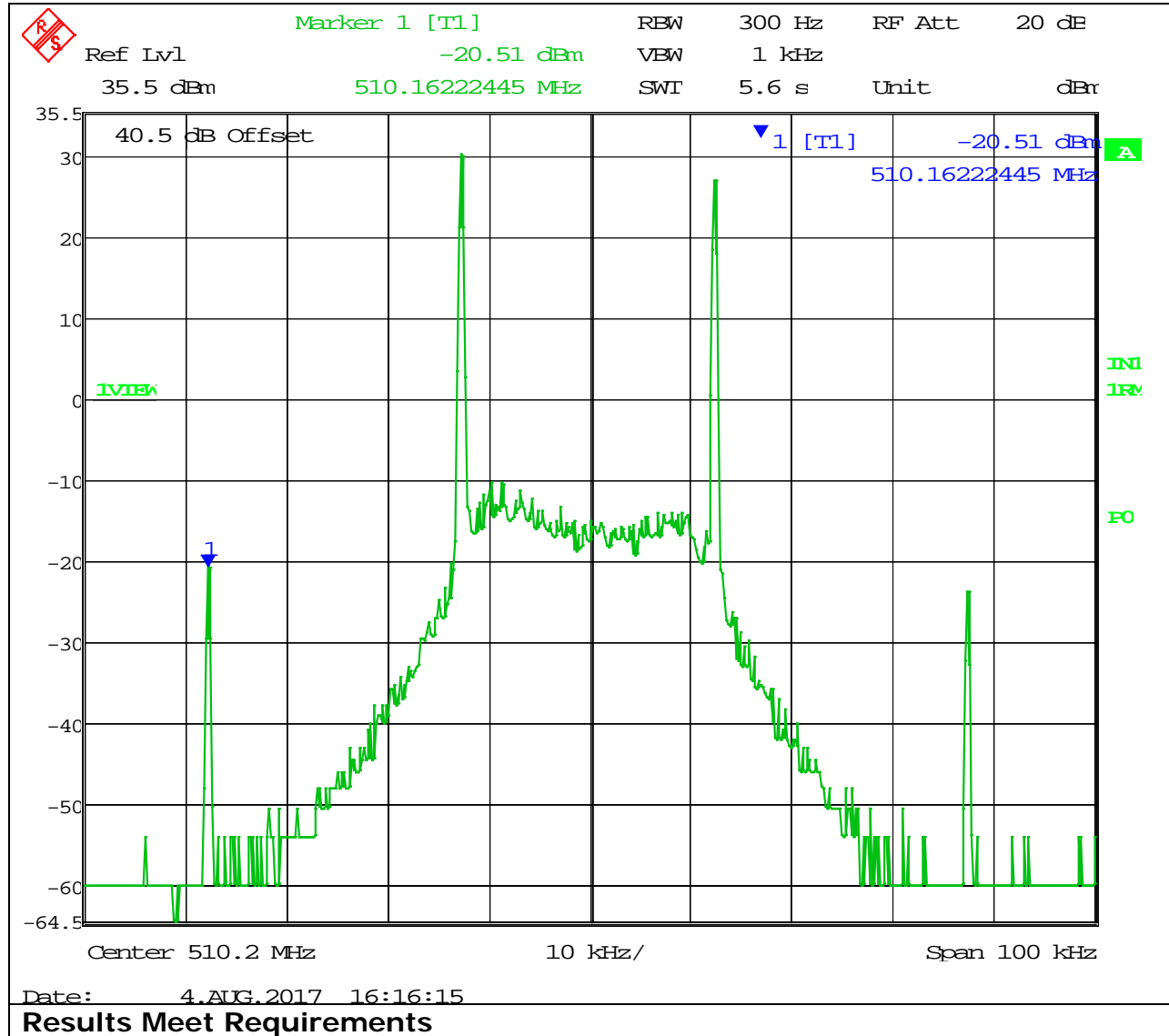

Out-of-band/out-of-block Emissions(including intermodulation) §4.7.2

Test Data: 12.5 kHz Intermodulation with AGC

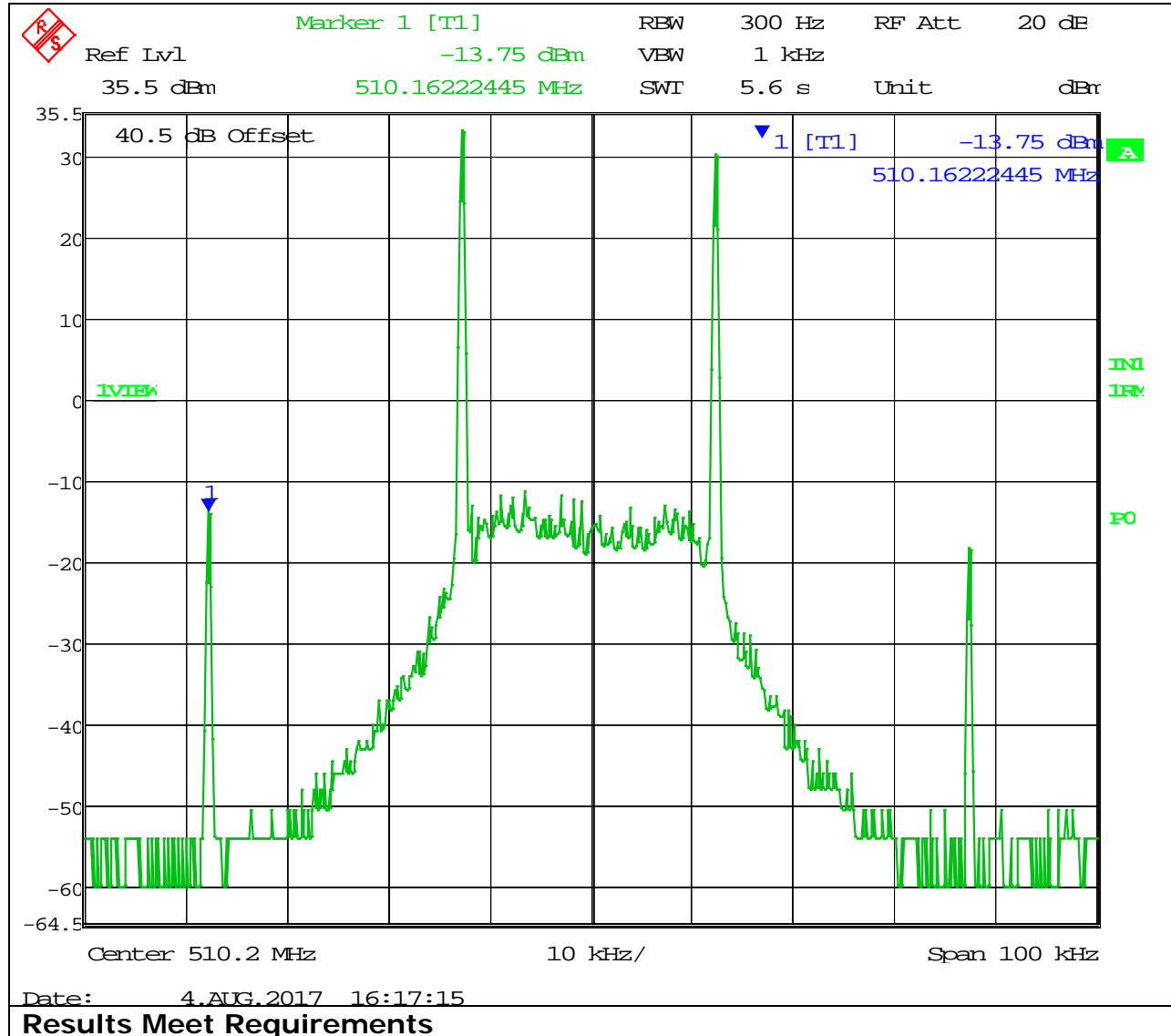

Out-of-band/out-of-block Emissions(including intermodulation) §4.7.2

Test Data: 25 kHz Intermodulation without AGC

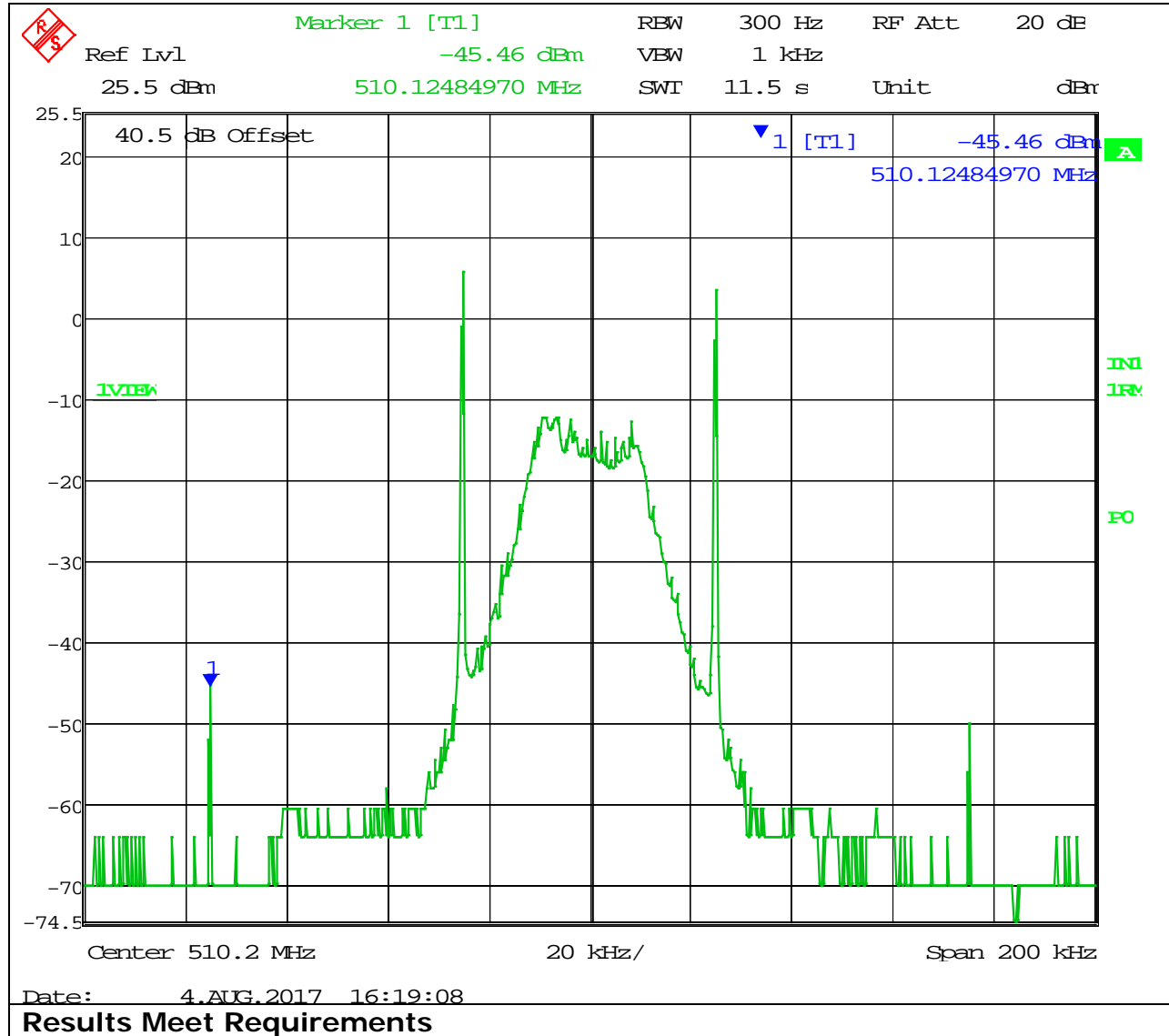

Out-of-band/out-of-block Emissions(including intermodulation) §4.7.2

Test Data: 25 kHz Intermodulation with AGC

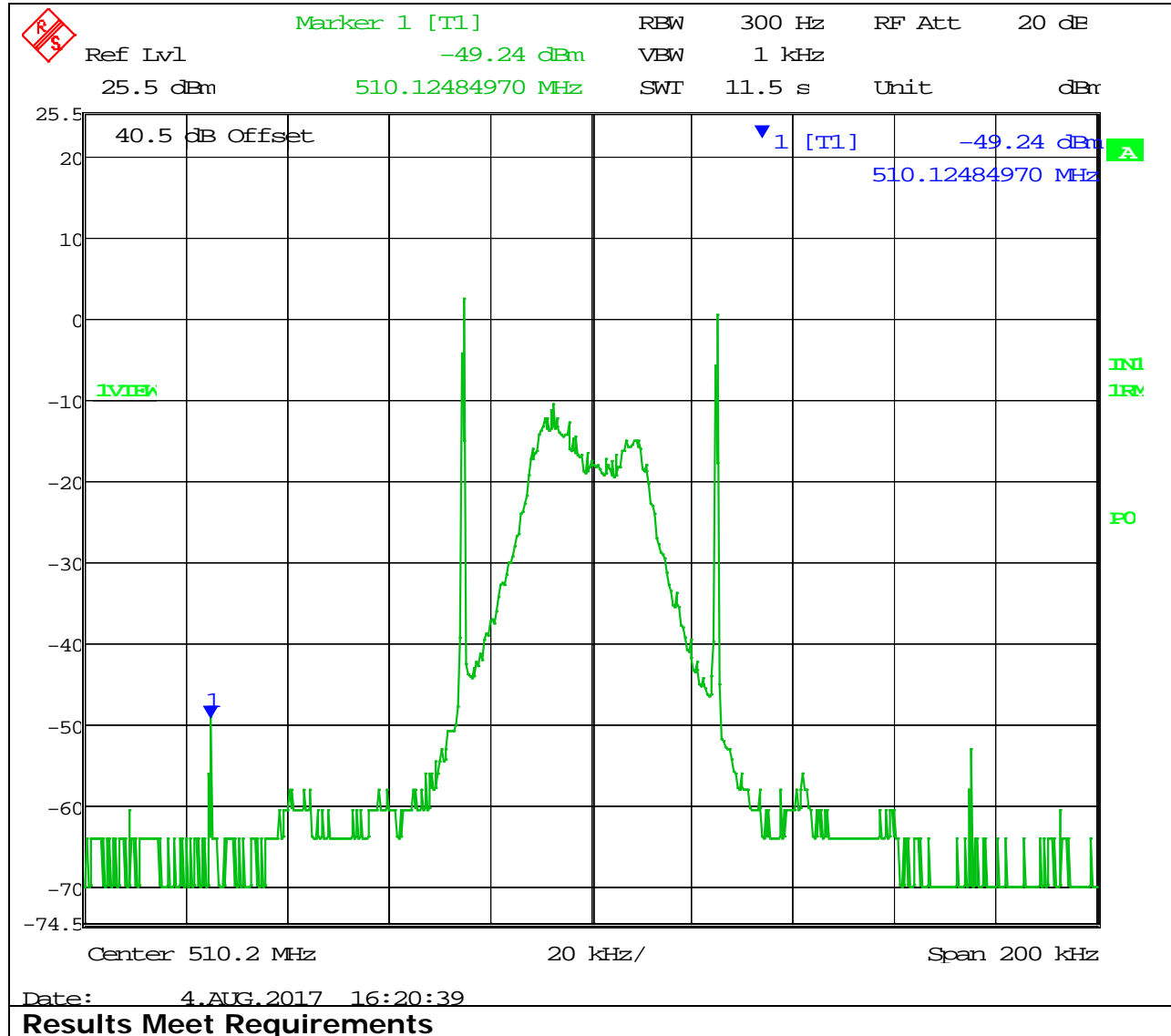

ANTENNA CONDUCTED EMISSIONS §4.7

Rule Parts. No.: 47CFR90.210, KDB 935210-DO5 v01r01 §4.7.3

Requirements: - 13 dBm in any 100 KHz Bandwidth

Procedure: KDB935210 Measurement Guidance for Industrial Boosters
 § 4.7.1 General
 § 4.7.3 EUT Spurious emissions conducted measurements

Test Setup Diagram:

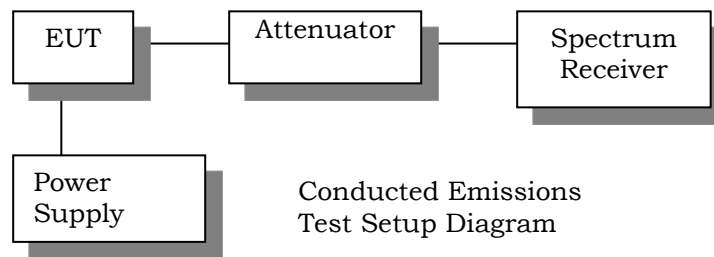

Test Data:

Tuned Frequency (MHz)	Emission Frequency (MHz)	Fundamental Power (dBm)	Emission Power (dBm)	Difference (dB)	Limit (dBc)	Margin (dB)
506.2	1013.0	38.8	-21.9	60.7	51.8	8.9
510.2	1020.0	38.4	-21.4	59.8	51.4	8.4

Result meets requirements

FIELD STRENGTH OF SPURIOUS RADIATION EMISSIONS §4.9

Rule Parts. No.: 47CFR90.210, KDB 935210-DO5 v01r01 §4.9

Requirements: - 13 dBm in any 100 KHz Bandwidth

Procedure: KDB935210 Measurement Guidance for Industrial Boosters
§ 4.7.1 General
§ 4.9 Spurious emissions radiated measurements

The tabulated data shows the results of the radiated field strength emissions test. The spectrum was scanned from 9 KHz to at least the tenth harmonic of the fundamental. Measurements were made at the test site of **TIMCO ENGINEERING, INC. located at 849 NW State Road 45, Newberry, FL 32669.**

Test Data:

No emissions present within 20 dB of the limit.

Results meet requirements

EQUIPMENT LIST

Device	Manufacturer	Model	Serial Number	Cal/Char Date	Due Date
Antenna: Biconical 1057 Chamber	Eaton	94455-1	1057	11/18/15	11/18/17
Antenna: Log-Periodic	Electro-Metrics	LPA-30	409	02/17/16	02/17/18
CHAMBER	Panashield	3M	N/A	04/25/16	12/31/17
Sweep/Signal Generator	Anritsu	68369B	985112	10/28/15	10/28/17
Antenna: Double-Ridged Horn/ETS Horn 2	ETS-Lindgren Chamber	3117	00041534	03/01/17	03/01/19
Antenna: Active Loop	ETS-Lindgren	6502	00062529	11/18/15	11/18/17
Coaxial Cable - NMNM-0300-001	Insulated Wire Inc.		NMNM-0300-00	08/05/15	08/05/17
Signal Generator R & S SMIQ 02	Rohde & Schwarz	SMIQ02	DE24678	01/09/16	01/09/18
Coaxial Cable - BMBM-0130-00	Alpha Wire		BMBM-0130-00	05/24/16	05/24/18
Coaxial Cable - Chamber 3 cable set (Primary)	Micro-Coax	Chamber 3 cable set (Primary)	KMKM-0244-01; KMKM-0670-00; KFKF-0198-01	08/08/16	08/08/18
Signal Generator R & S SMU 200A	Rohde & Schwarz	SMU200A	103195	02/29/16	02/28/18
Coaxial Cable - NMNM-0317-00	Unknown		NMNM-0317-00	07/13/16	07/13/18
EMI Test Receiver R & S ESIB 40	Rohde & Schwarz	ESIB 40	100274	08/16/16	08/16/18
Bore-sight Antenna Positioning Tower	Sunol Sciences	TLT2	N/A	N/A	N/A
Pre-amp	RF-LAMBDA	RLNA00M45GA	NA	01/04/16	01/04/18
Noise Source 10MHz - 18GHz	Agilent	346B	MY44421884	05/04/16	05/04/18

*EMI RECEIVER SOFTWARE VERSION

The receiver firmware used was version 4.43 Service Pack 3

STATE OF THE MEASUREMENT UC –

The data and results referenced in this document are true and accurate. The measurement uncertainty was calculated for all measurements listed in this test report according To CISPR 16–4 or ENTR 100-028 Specification for radio disturbance and immunity measuring apparatus and methods – Part 4: “Uncertainty in EMC Measurements” and is documented in the Timco Engineering, Inc. quality system according to DIN EN ISO/IEC 17025. Furthermore, component and process variability of devices similar to that tested may result in additional deviation. The manufacturer has the sole responsibility of continued compliance of the device.

Hereafter the best measurement capability for Timco Engineering, Inc. is reported:

Test Items	Measurement Uncertainty	Notes
RF Frequency Accuracy	± 49.5 Hz	(1)
RF Conducted Power	±0.93dB	(1)
Conducted spurious emission of transmitter valid up to 40GHz	±1.86dB	
Occupied Bandwidth	±2.65%	
Audio Frequency Response	±1.86dB	
Modulation limiting	±1.88%	
Radiated RF Power	±1.4dB	
Maximum frequency deviation: Within 300 Hz and 6kHz of audio freq.	±1.88%	
Within 6kHz and 25kHz of audio Freq.	±2.04%	
Rad Emissions Sub Meth up to 26.5GHz	±2.14dB	
Rad Emissions Sub Meth up to 18-40 GHz	±2.04%	
Adjacent channel power	±1.47dB	(1)
Transient Frequency Response	±1.88%	
Temperature	±1.0°C	(1)
Humidity	±5.0%	

This uncertainty represents an expanded uncertainty expressed at approximately the 95% confidence level using a coverage factor of k=1.96.

END OF REPORT