



849 NW STATE ROAD 45
NEWBERRY, FL 32669 USA
PH: 888.472.2424 OR 352.472.5500
FAX: 352.472.2030
EMAIL: TEI@TIMCOENGR.COM
[HTTP://WWW.TIMCOENGR.COM](http://WWW.TIMCOENGR.COM)

FCC PART 22H AND PART 24E TEST REPORT

Applicant	FIPLEX COMMUNICATIONS INC.
Address	7331 N.W. 54TH STREET MIAMI FL 33166
FCC ID	P3TCBDAS-1A1S
Model Number	CBDAS-1A1S
Product Description	BIDIRECTIONAL AMPLIFIER ESMR BAND
Date Sample Received	6/28/2012
Date Tested	7/20/2012
Tested By	Nam Nguyen
Approved By	Mario de Aranzeta
Report No.	1631AUT12TestReport.doc
Test Results	<input checked="" type="checkbox"/> PASS <input type="checkbox"/> FAIL

THE ATTACHED REPORT SHALL NOT BE REPRODUCED EXCEPT IN FULL
WITHOUT THE WRITTEN APPROVAL OF TIMCO ENGINEERING, INC.



Test Certificate #0955-01



TABLE OF CONTENTS

ATTESTATION STATEMENT 3
REPORT SUMMARY 4
TEST ENVIRONMENT 4
TEST SETUP 4
DEVICE UNDER TEST INFORMATION 5
EQUIPMENT LIST 6
TEST PROCEDURE 7
RF POWER OUTPUT 10
Test Data Table 1 - Output Power - FM - Uplink/Downlink 10
Test Data Table 2 - Output Power - APCO25 - Uplink/Downlink 10
Test Data Table 3 - Output Power - IDEN - Uplink/Downlink 10
INPUT/OUTPUT MODULATED AMPLITUDE COMPARISON AND BAND-EDGES
COMPLIANCE 11
Test Data Table 4 - FM - Uplink/Downlink 12
Test Data Table 5 - APCO25 - Uplink/Downlink 16
Test Data Table 6 - IDEN - Uplink/Downlink 20
INTERMODULATION PRODUCT SPURIOUS EMISSIONS 24
Figure 13: APCO25 3 tones intermodulation - (806 - 824) MHz 24
Figure 14: APCO25 3 tones intermodulation - (851 - 869) MHz 25
Figure 15: IDEN 3 tones intermodulation - (806 - 824) MHz 26
Figure 16: IDEN 3 tones intermodulation - (851 - 869) MHz 27
SPURIOUS EMISSIONS AT ANTENNA TERMINALS 28
Test Data Table 7 - Conducted Emissions - CW 800 - Uplink 28
Test Data Table 8 - Conducted Emissions - CW 800 - Downlink 28
FIELD STRENGTH OF SPURIOUS EMISSIONS 29
Test Data Table 9 - Radiated Emissions - CW (800 MHz) - Uplink /Downlink 29
OUT OF BAND REJECTION: FREQUENCY RESPONSE 30

ATTESTATION STATEMENT

Summary

The device under test does:

- fulfill the general approval requirements as identified in this test report
- not fulfill the general approval requirements as identified in this test report

This equipment has been tested in accordance with the standards identified in this test report. To the best of my knowledge and belief, these tests were performed using the measurement procedures described in this report. All instrumentation and accessories used to test products for compliance to the indicated standards are calibrated regularly in accordance with ISO 17025: 2005 requirements.



Certificate # 0955-01

I attest that the necessary measurements were made, under my supervision, at TIMCO ENGINEERING, INC. located at 849 N.W. State Road 45, Newberry, Florida 32669.

Authorized Signatory Name: Mario de Aranzeta



Signature:

Function: Engineer

Date: 7/25/2012

REPORT SUMMARY

Disclaimer	The test results relate only to the items tested.
Report Purpose	To demonstrate the DUT comply with FCC Part 22H and Pt 24 and Industry Canada RS-131 requirements for a dual band signal amplifier.
Applicable Rule Part(s)	Pt 22, Pt 24, Pt 15.109
Test Procedure(s)	ANSI/TIA-603-C: 2004

TEST ENVIRONMENT

Test Facilities	All required tests were performed by Timco Engineering Inc. that is located at 849 NW State Road 45 Newberry, FL 32669.
Test Conditions	Temperature: 26°C Relative Humidity: 50%

TEST SETUP

Deviation to the rules	There was no deviation from the test standards.
Modification to the DUT	No modification was made to the DUT.
Test Exercise (e.g. software description, test signal, etc.)	The DUT was placed in continuous transmit mode of operation.

DEVICE UNDER TEST INFORMATION

Manufactured by	FIPLEX COMMUNICATIONS INC.
DUT Description	BIDIRECTIONAL AMPLIFIER ESMR BAND
FCC ID	P3TCBDAS-1A1S
Model Name	CBDAS-1A1S
Operating Frequency	Uplink 806 – 824 MHz Downlink 851 – 869 MHz
Emission Designators	20K0GXW (IDEN), 8K10F1E , 8K10F1D (APCO25)
Modulation(s)	FM, IDEN, APCO25
User Power Range & Control	There are NO user power controls
Test Item	Pre-Production
DC Voltage and Current into final amplifier	Power Into Final Amplifier (uplink) Vcc = 5Vdc, 1.9A Power Input (downlink) Vcc= 5Vdc, 1.9A
Type of Equipment	Fixed

EQUIPMENT LIST

Device	Manufacturer	Model	Serial Number	Cal/Char Date	Due Date
3-Meter Semi-Anechoic Chamber	Panashield	N/A	N/A	Listed 12/31/11	12/31/13
AC Voltmeter	HP	400FL	2213A14499	CAL 6/12/11	6/12/13
Antenna: Active Loop	ETS-Lindgren	6502	00062529	CAL 9/23/10	9/23/12
Frequency Counter	HP	5385A	2730A03025	CAL 8/17/11	8/17/13
Hygro-Thermometer	Extech	445703	0602	CAL 6/15/11	6/15/13
Modulation Analyzer	HP	8901A	3435A06868	CAL 7/18/11	7/18/13
Digital Multimeter	Fluke	FLUKE-77	35053830	CAL 9/9/11	9/9/13
Power Meter	Boonton Electronics	4531	11793	CAL 11/12/2010	11/12/2012
EMI Receiver	Rohde & Schwarz	ESIB40	100274	CAL 3/16/2012	3/16/2014
Analyzer Tan Tower Preamplifier	HP	8449B-H02	3008A00372	CAL 10/28/11	10/28/13
Analyzer Tan Tower Quasi-Peak Adapter	HP	85650A	3303A01690	CAL 10/28/11	10/28/13
Analyzer Tan Tower RF Preselector	HP	85685A	3221A01400	CAL 10/28/11	10/28/13
Analyzer Tan Tower Spectrum Analyzer	HP	8566B Opt 462	3138A07786 3144A20661	CAL 10/28/11	10/28/13
Temperature Chamber	Tenney Engineering	TTRC	11717-7	CHAR 2/22/12	2/22/13
Antenna	ETS	3117	35923	12/7/2011	12/7/2013
Antenna	Electro metrics	LPA-25	1122	5/04/2011	5/04/2013
Antenna	Electro metrics	BIA-25	1096	5/04/2011	5/04/2013

TEST PROCEDURE

RF Power Output

RF power is measured by connecting a 50-ohm, resistive wattmeter to the RF output connector. With a nominal voltage and the amplifier properly adjusted the RF output measures.

RF Output Power Test Setup Diagram

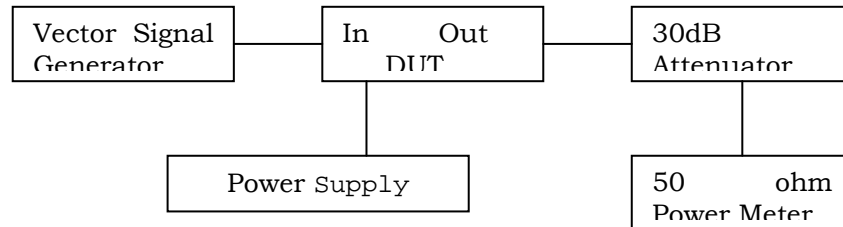

Input/Output Modulated Amplitude Comparison And Band-Edges Compliance

On the following plot, the reference level was calibrated using a resolution bandwidth wider than the emission bandwidth. First the gain was measured for the maximum output power. Then for each frequency and type of modulation, an attenuation equals to the gain of the amplifier was added on the measurement side of the amplifier, as to overlay the input versus output modulated envelope.

Test Setup Diagram

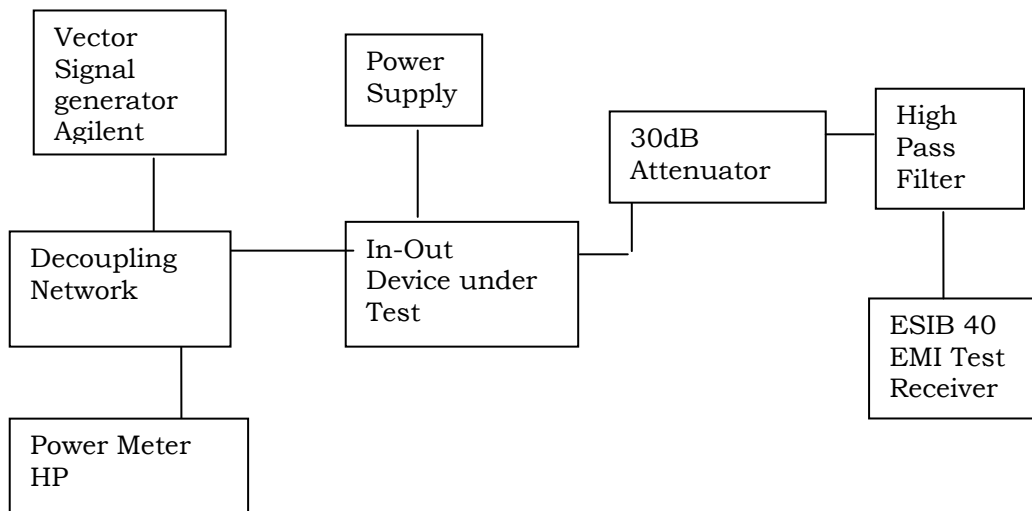

[Continued]

Intermodulation Product Spurious Emissions

The procedure used was ANSI/TIA-603-C: 2004. The spectrum was scanned from 9kHz to at least the tenth harmonic of the fundamental using a HP 8566B spectrum analyzer.

The modulation type was tested using the two-tone / three tone test method. The input power to the amplifier was set at maximum drive level by combining the two tones. The two tones were chosen in such a way (1) the third order intermodulation product frequencies are located within the pass band of the DUT and (2) they produce the worst-case emissions out of band.

Setup Diagram

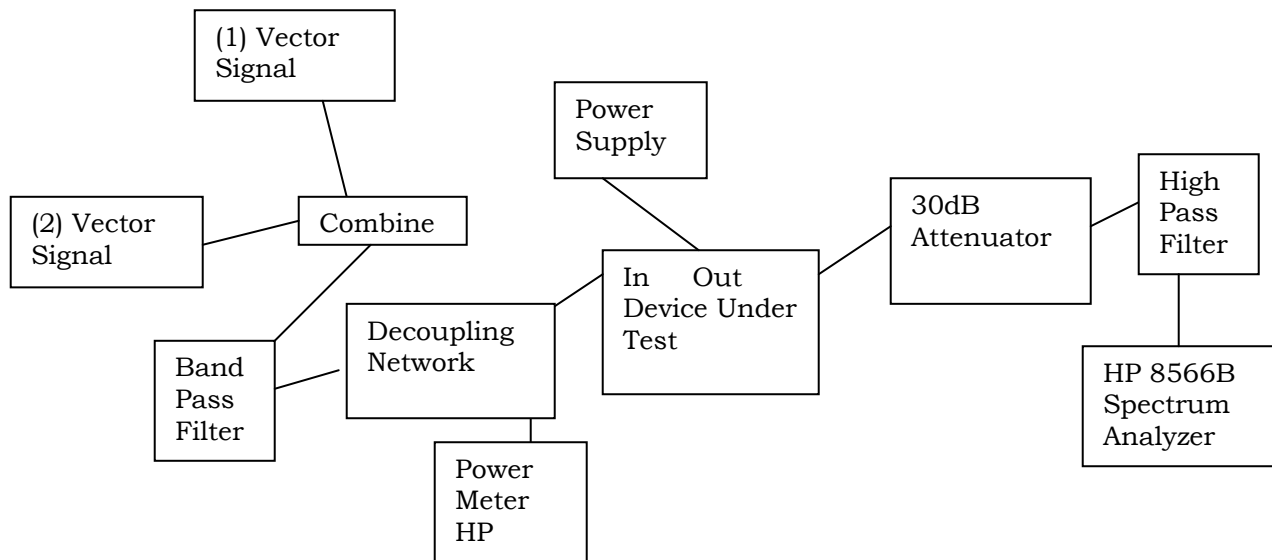

Spurious Emissions at Antenna Terminals

The procedure used was ANSI/TIA-603-C: 2004. The spectrum was scanned from 9kHz to at least the tenth harmonic of the fundamental using a HP model 8566B spectrum analyzer.

Data on the following page shows the level of conducted spurious responses. For analog modulation, the carrier was modulated 100% using a 2500 Hz tone. For digital modulation, the carrier is modulated to its maximum extent. The spectrum was scanned from 9 kHz to at least the 10th harmonic of the fundamental. The measurements were made in accordance with standard ANSI/TIA-603-C: 2004. The maximum input power was set for each test.

[Continued]

Conducted Spurious Emissions Test Setup Diagram

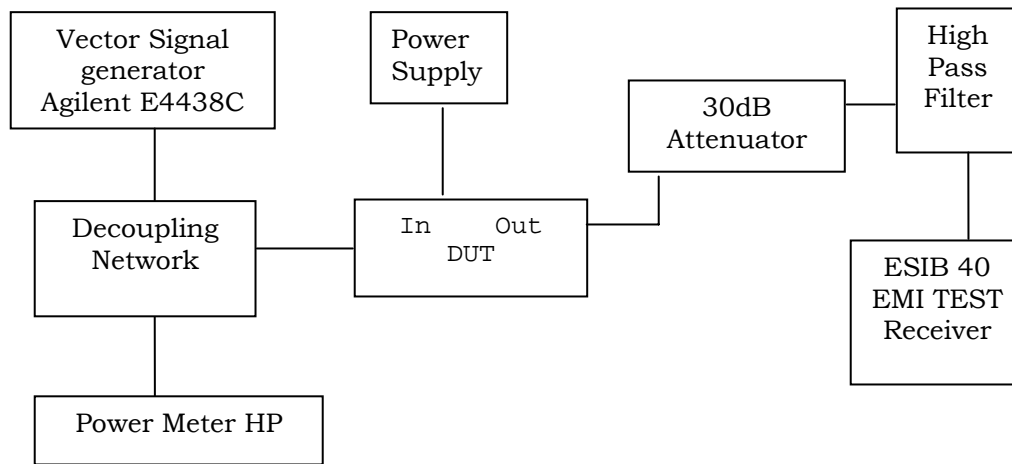

Radiated Spurious Emissions

The spectrum was scanned from 30 MHz to at least the tenth harmonic of the fundamental. The CW signal was used to perform this test. This test was conducted per ANSI/TIA-603-C: 2004 using the substitution method.

Radiated Spurious Emissions Test Setup Diagram

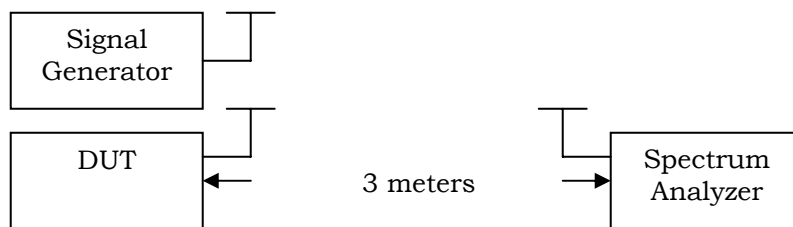

Equipment placed 80 cm above ground on a rotating table platform.

RF POWER OUTPUT

Rule Part(s) No.: Pt 2.1046(a)

Requirements: Pt 2.1046(a)

Test Result: As the following table indicates. Notes: the maximum power output value was obtained with analog FM modulation at 815MHz and 851MHz.

Test Data Table 1 – Output Power – FM – Uplink/Downlink

Tuned Frequency (MHz)	Power Input (dBm)	Power Output (dBm)	Power Output (mW)
806.02	-47.0	19.1	81
815.00	-46.0	19.2	83
823.98	-47.0	18.8	76

Tuned Frequency (MHz)	Power Input (dBm)	Power Output (dBm)	Power Output (mW)
851.02	-46.0	18.5	71
860.00	-48.0	18.0	63
868.98	-46.0	18.1	65

Test Data Table 2 – Output Power – APCO25 – Uplink/Downlink

Tuned Frequency (MHz)	Power Input (dBm)	Power Output (dBm)	Power Output (mW)
806.01	-47.0	18.4	69
815.00	-46.0	18.8	76
823.99	-49.0	18.4	69

Tuned Frequency (MHz)	Power Input (dBm)	Power Output (dBm)	Power Output (mW)
851.01	-46.0	18.5	71
860.00	-48.0	18.2	66
868.99	-46.0	18.2	66

Test Data Table 3 – Output Power – IDEN – Uplink/Downlink

Tuned Frequency (MHz)	Power Input (dBm)	Power Output (dBm)	Power Output (mW)
806.02	-50.0	15.7	37
815.00	-49.0	15.7	37
823.98	-53.0	14.9	31

Tuned Frequency (MHz)	Power Input (dBm)	Power Output (dBm)	Power Output (mW)
851.02	-52.0	13.4	22
860.00	-53.0	14.0	25
868.98	-52.0	13.5	22



INPUT/OUTPUT MODULATED AMPLITUDE COMPARISON AND BAND-EDGES COMPLIANCE

Rule Parts No.: Pt 2.1049, Pt 2.1051, 22H, 24E

Requirements: The power of any emission outside of the authorized operating frequency ranges must be attenuated below the transmitting power (P) by a factor of at least $43 + 10 \log(P)$ dB.

Test Data: The DUT meets the requirements.

Bandedge compliance: Measurements were performed in accordance with Part 24.238

The Reference level on the following plots was calibrated using a 3MHz RBW=VBW.

Compensating for RBW (1%) using $10 \log(12.5/3) = 6.2$ dB we get the following amplitudes at the bandedge:

Test Data Table 4 – FM – Uplink/Downlink

Channel (MHz)	Bandedge Frequency (MHz)	Amplitude bandedge (dBm)	Limit (dBm)	Margin (dB)
806.02	805.99	-43.77	-13	30.77
823.98	824.01	-45.09	-13	32.09
851.02	850.99	-42.5	-13	29.5
868.98	869.01	-43.78	-13	30.78

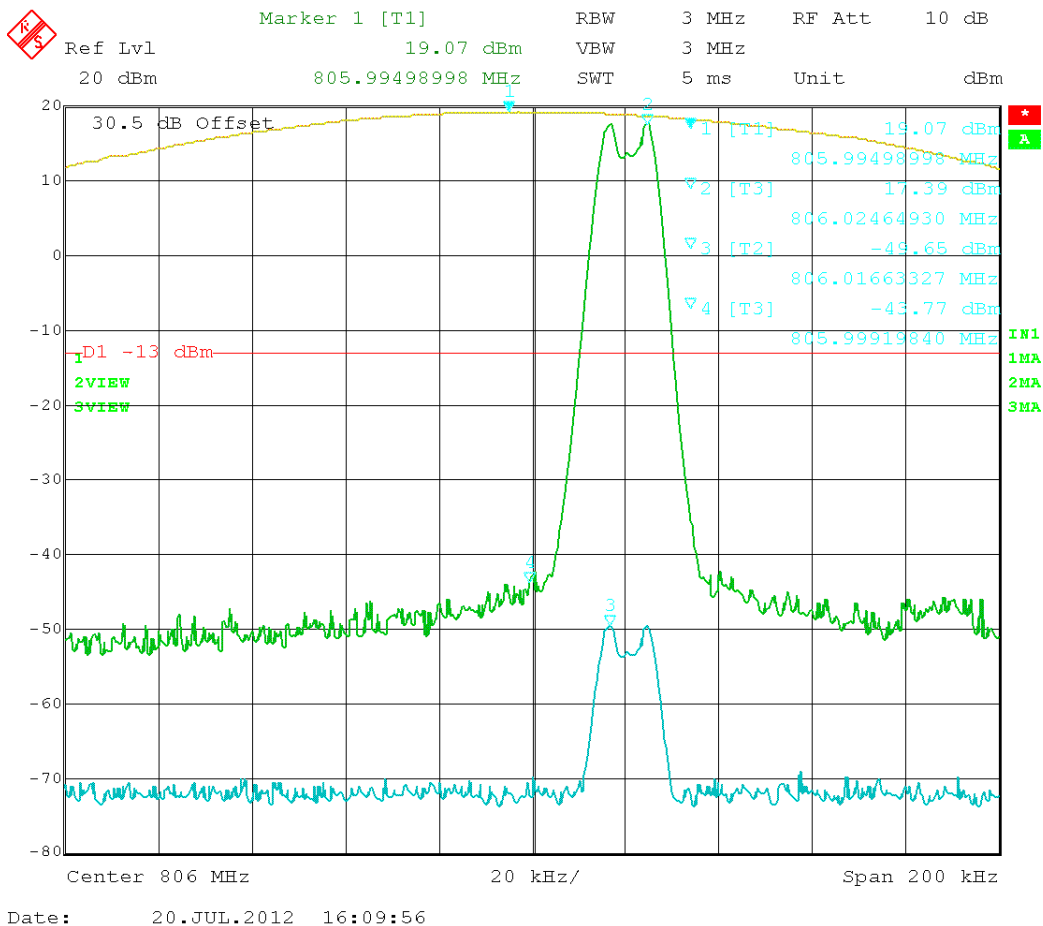

Figure 1: FM – In vs. Out 806.02MHz

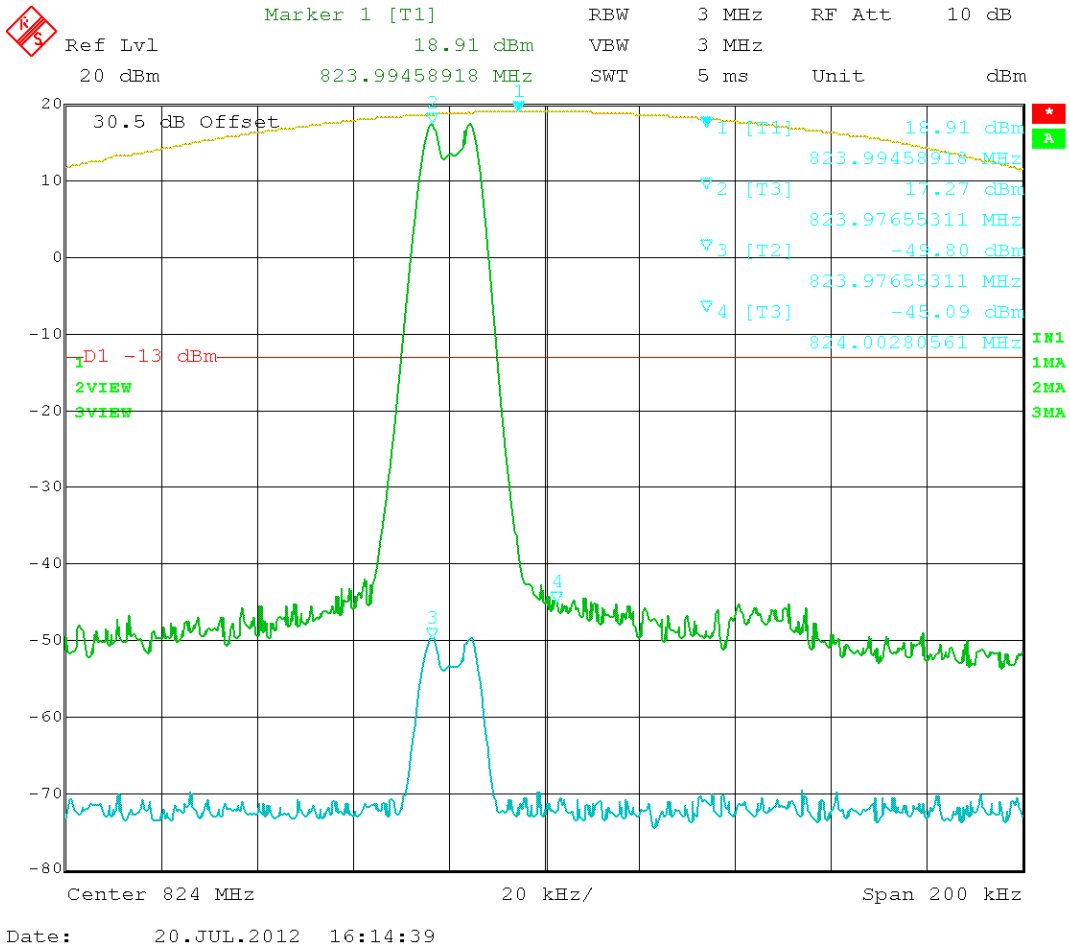

Figure 2: FM – In vs. Out 823.98MHz

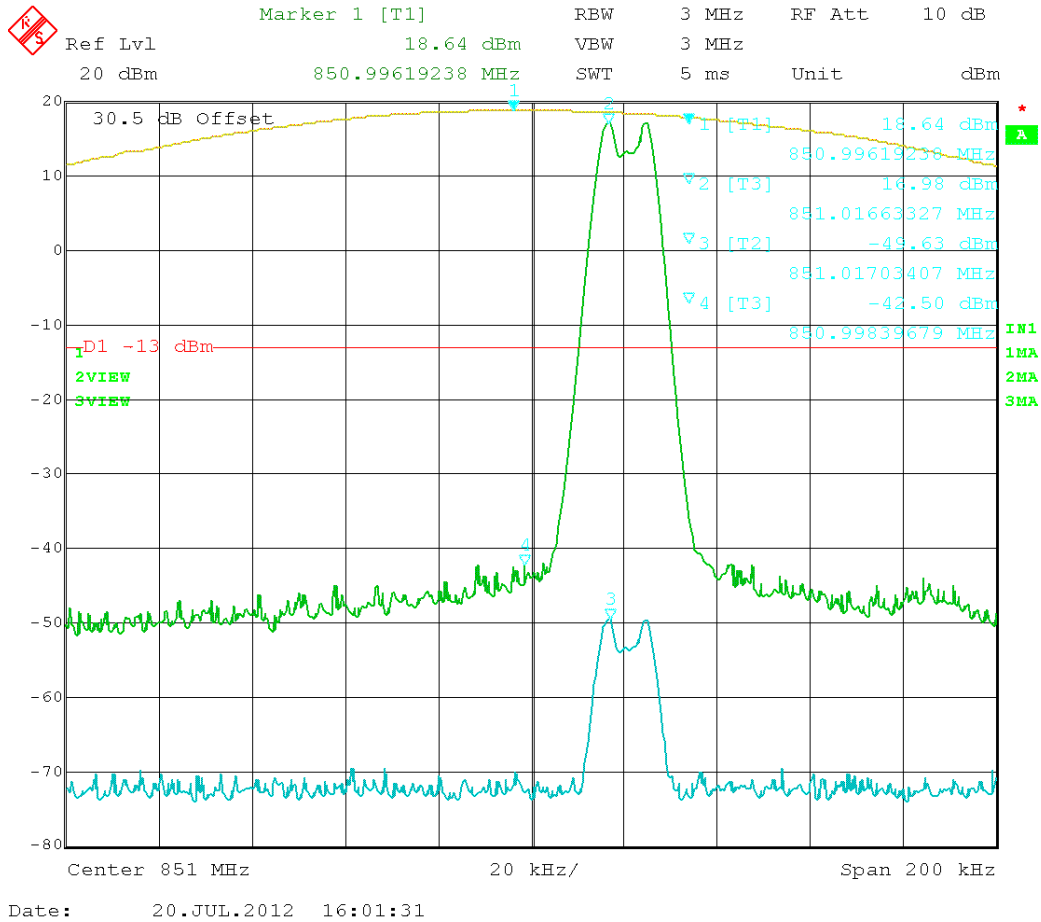

Figure 3: FM – In vs. Out 851.02MHz

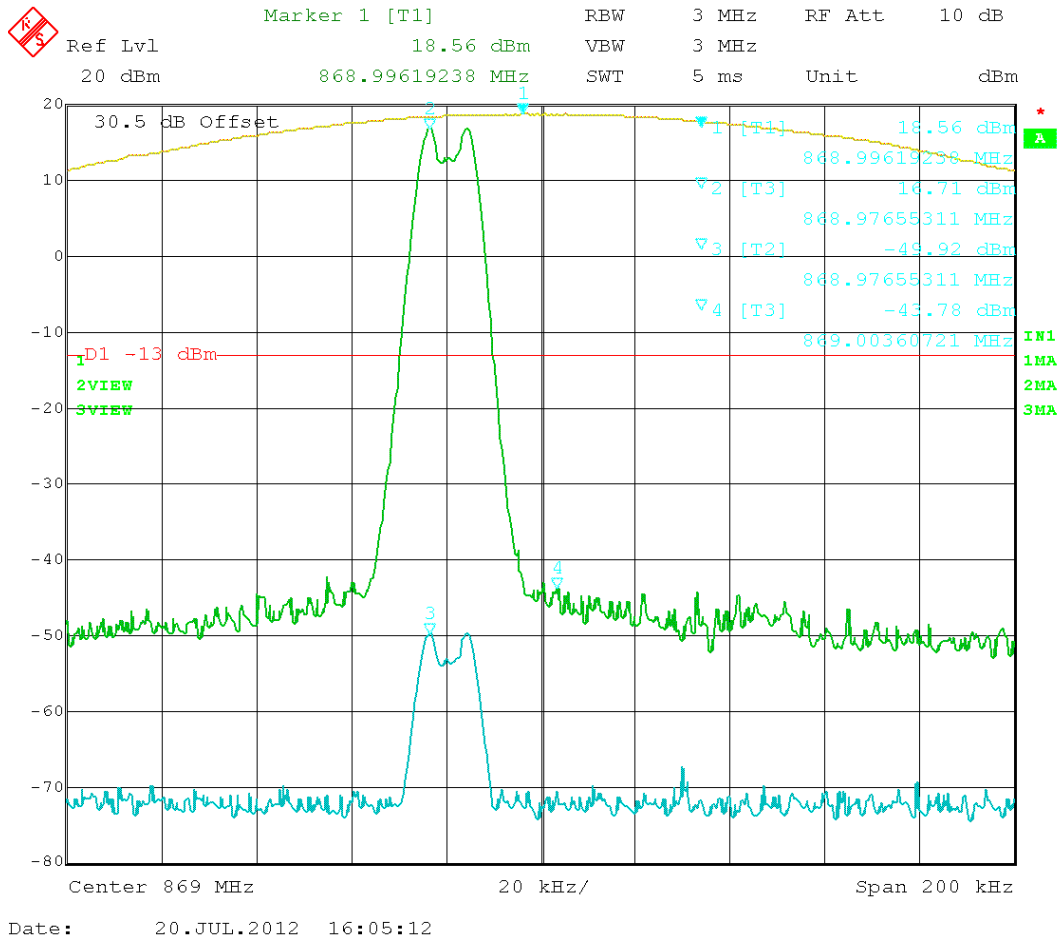
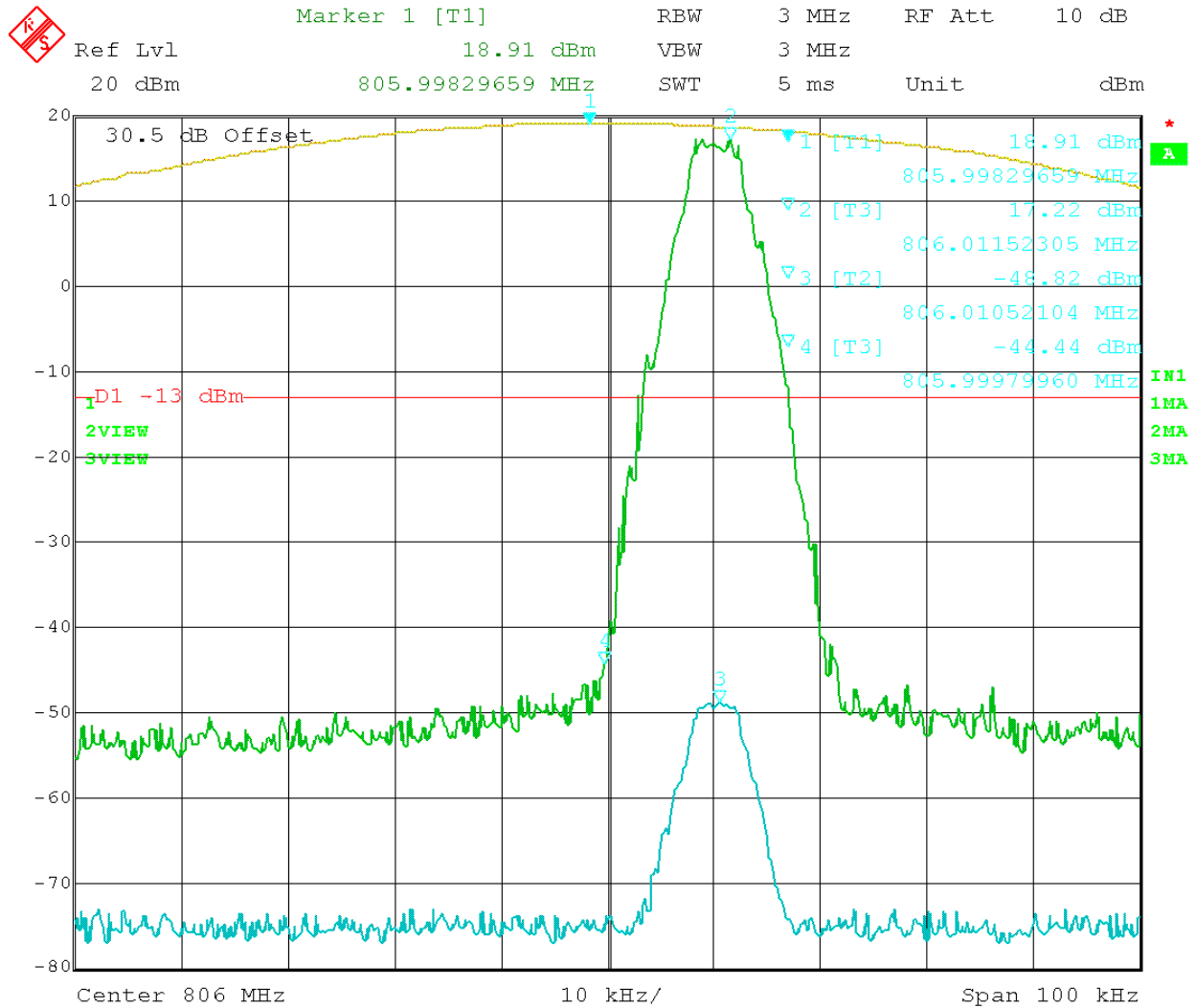

Figure 4: FM – In vs. Out 868.98MHz

Test Data Table 5 – APCO25 – Uplink/Downlink

Channel (MHz)	Bandedge Frequency (MHz)	Amplitude bandedge (dBm)	Limit (dBm)	Margin (dB)
806.01	805.99	-44.44	-13	31.44
823.99	824.01	-44.3	-13	31.3
851.01	850.99	-43.29	-13	30.29
868.99	869.01	-42.75	-13	29.75



Date: 20.JUL.2012 13:50:35

Figure 5: APCO25 – In vs. Out 806.01 MHz

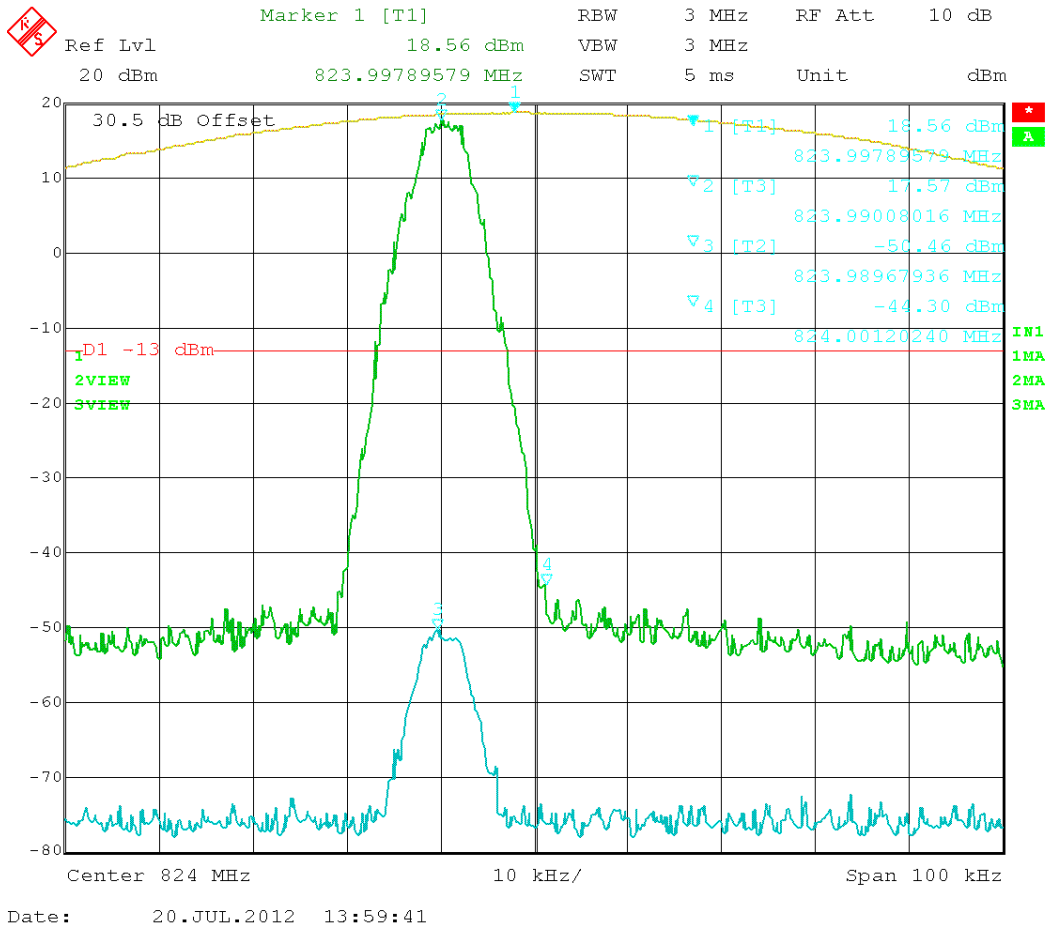

Figure 6: APCO25 – In vs. Out 823.99 MHz

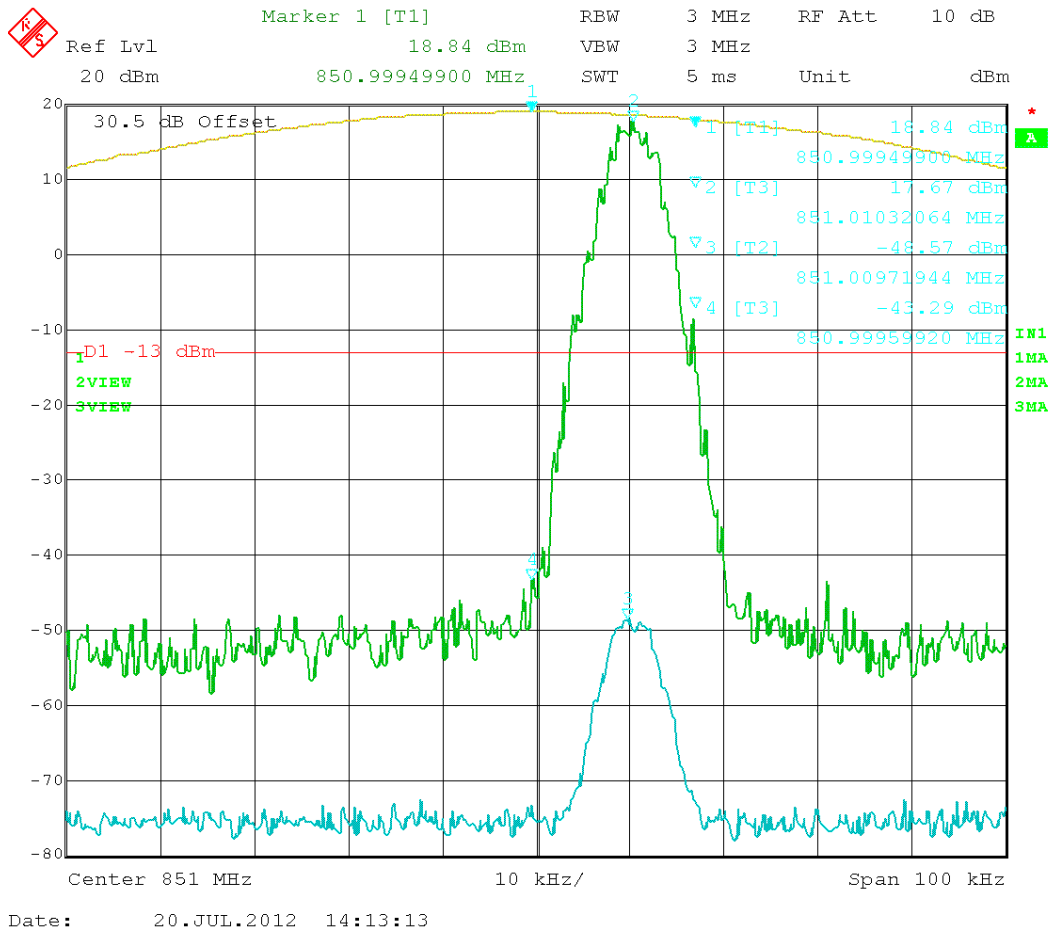

Figure 7: APCO25 – In vs. Out 851.01 MHz

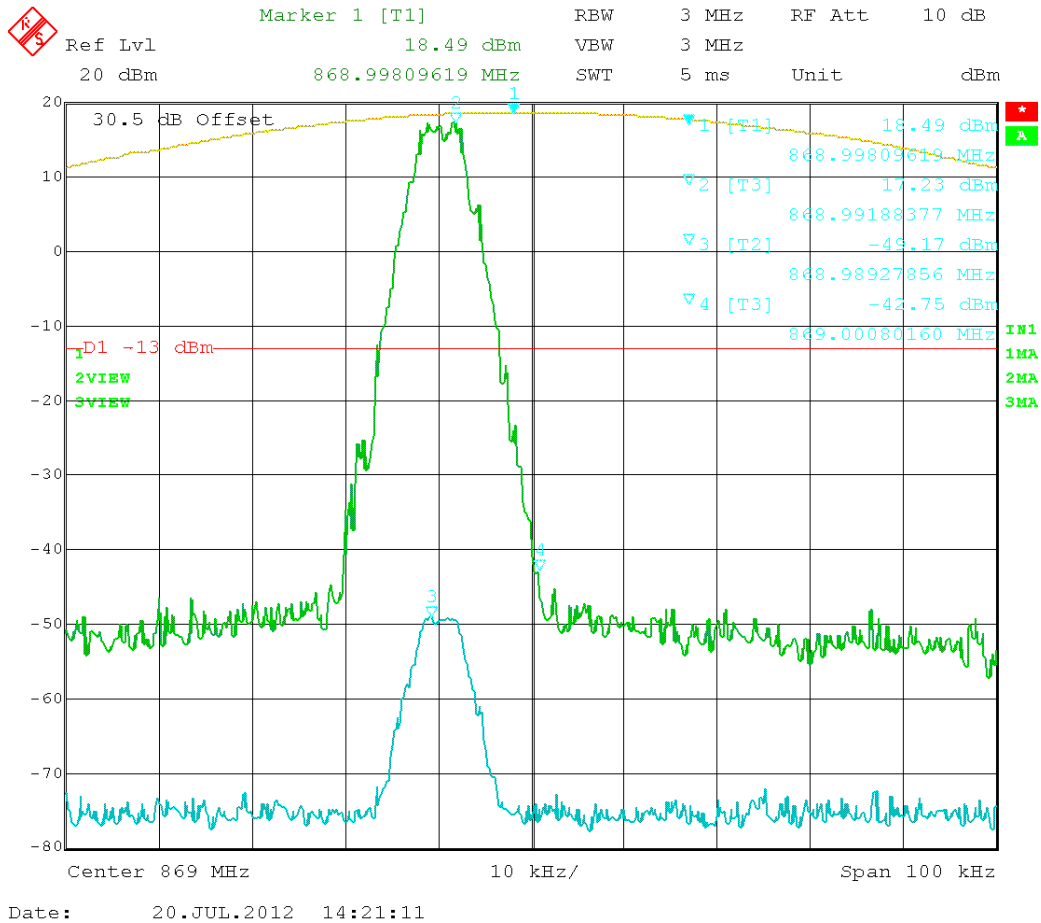

Figure 8: APCO25 – In vs. Out 868.99 MHz

Test Data Table 6 – IDEN – Uplink/Downlink

Channel (MHz)	Band-edge Frequency (MHz)	Amplitude level at the band-edge (dBm)	Limit (dBm)	Margin (dB)
806.02	805.99	-48.73	-13	35.73
823.98	824.01	-45.95	-13	32.95
851.02	850.99	-47.83	-13	34.83
868.98	869.01	-48.36	-13	35.36

The Reference level on the following plots was calibrated using a 3MHz RBW=VBW.

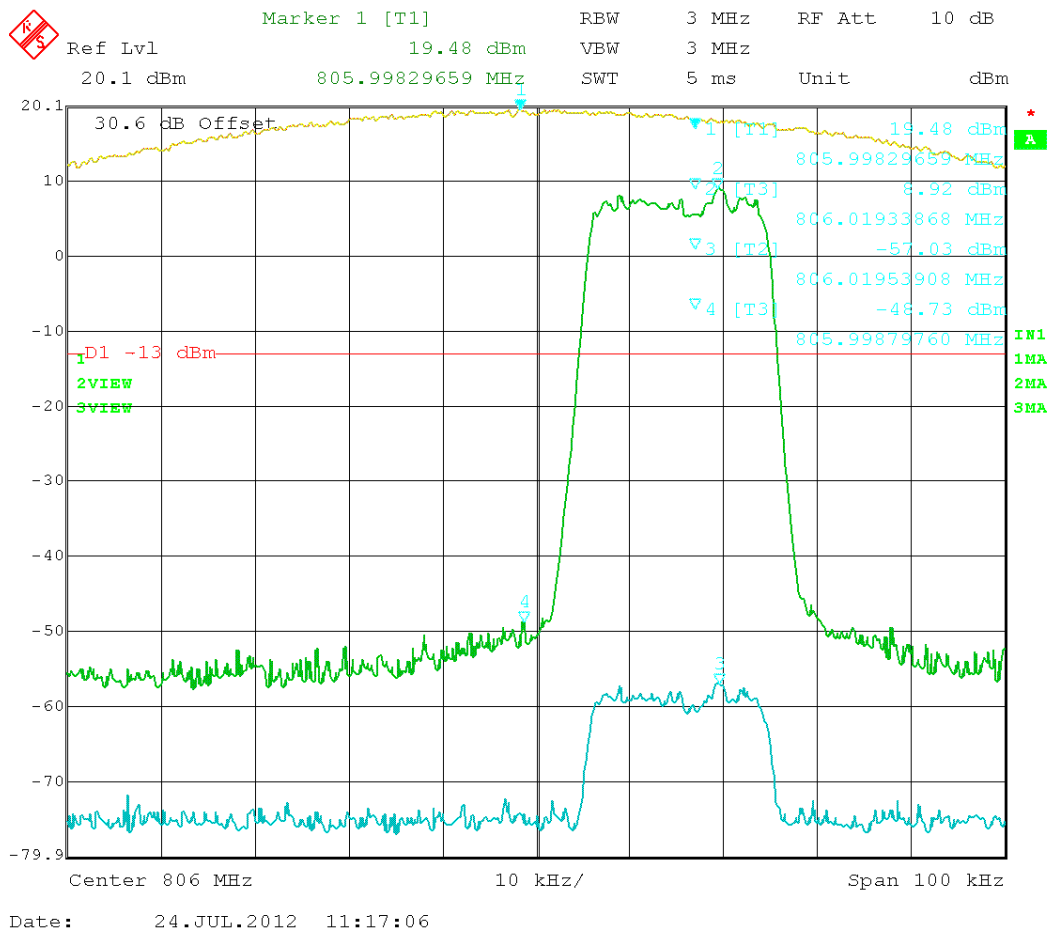

Figure 9: IDEN – In vs. Out 806.02MHz

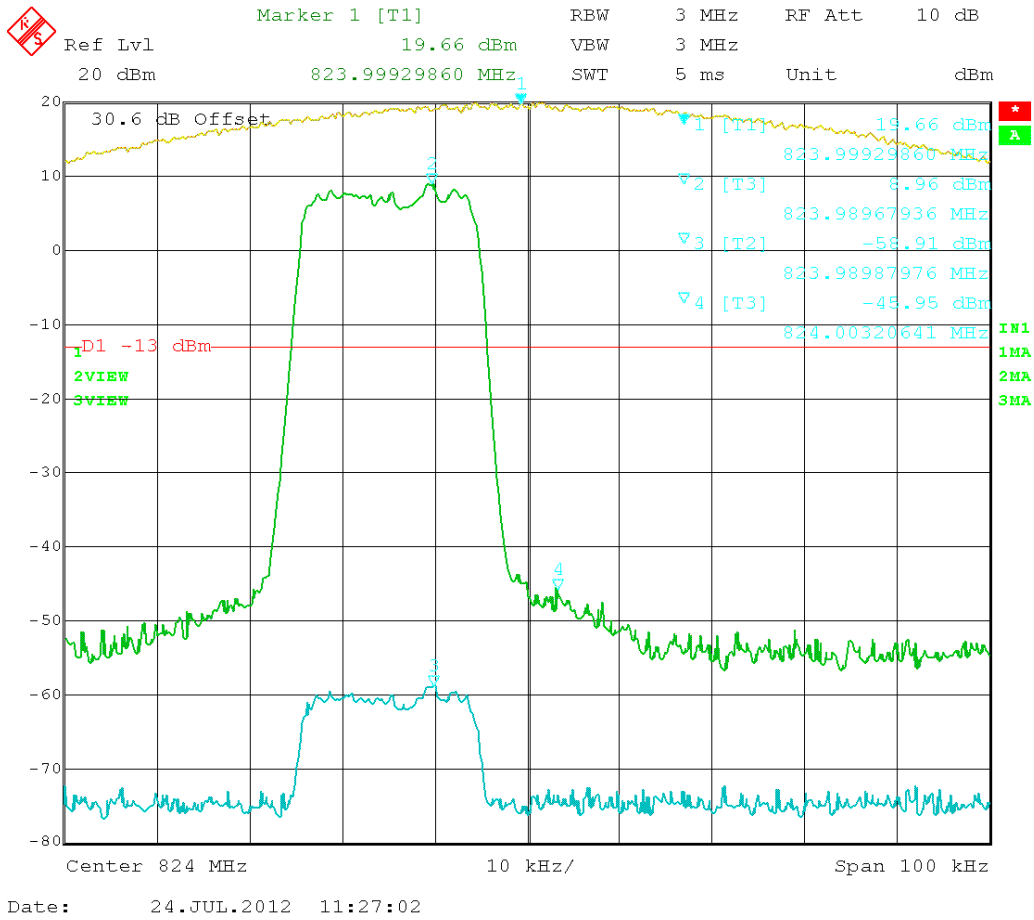

Figure 10: IDEN – In vs. Out 823.98MHz

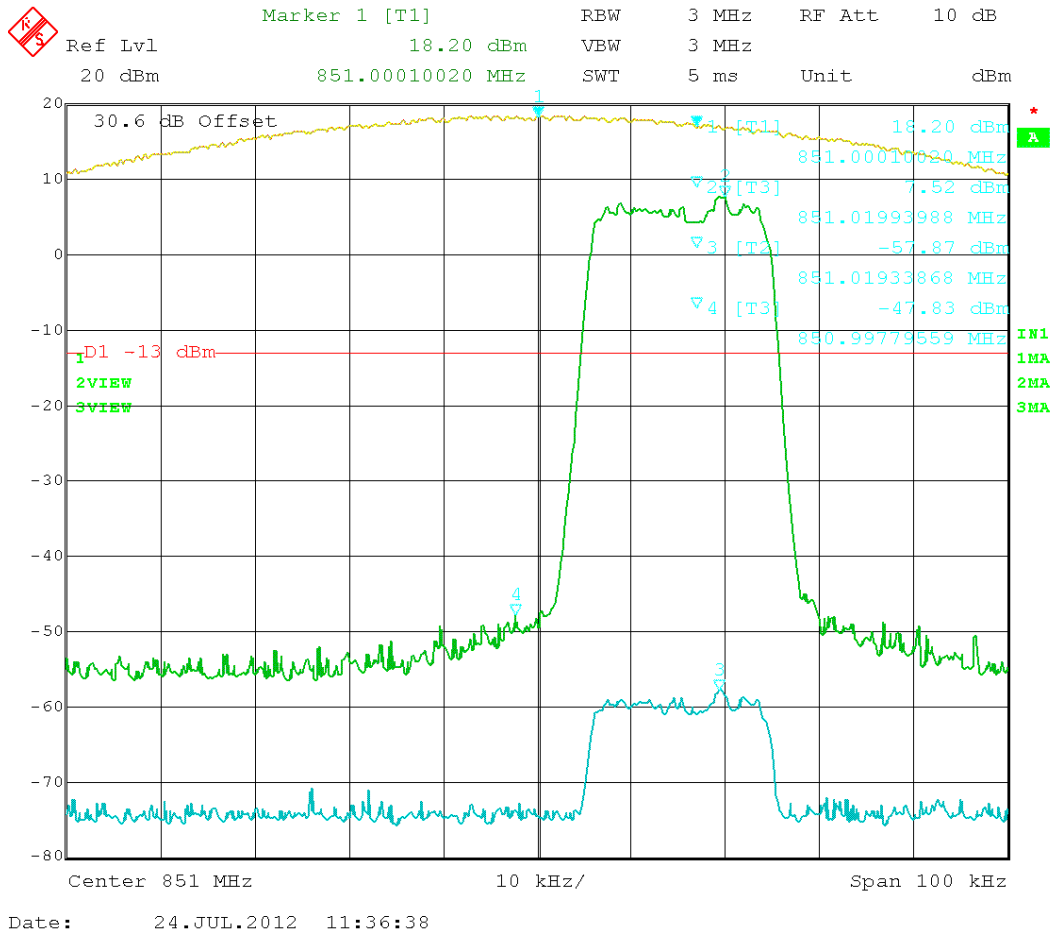

Figure 11: IDEN – In vs. Out 851.02MHz

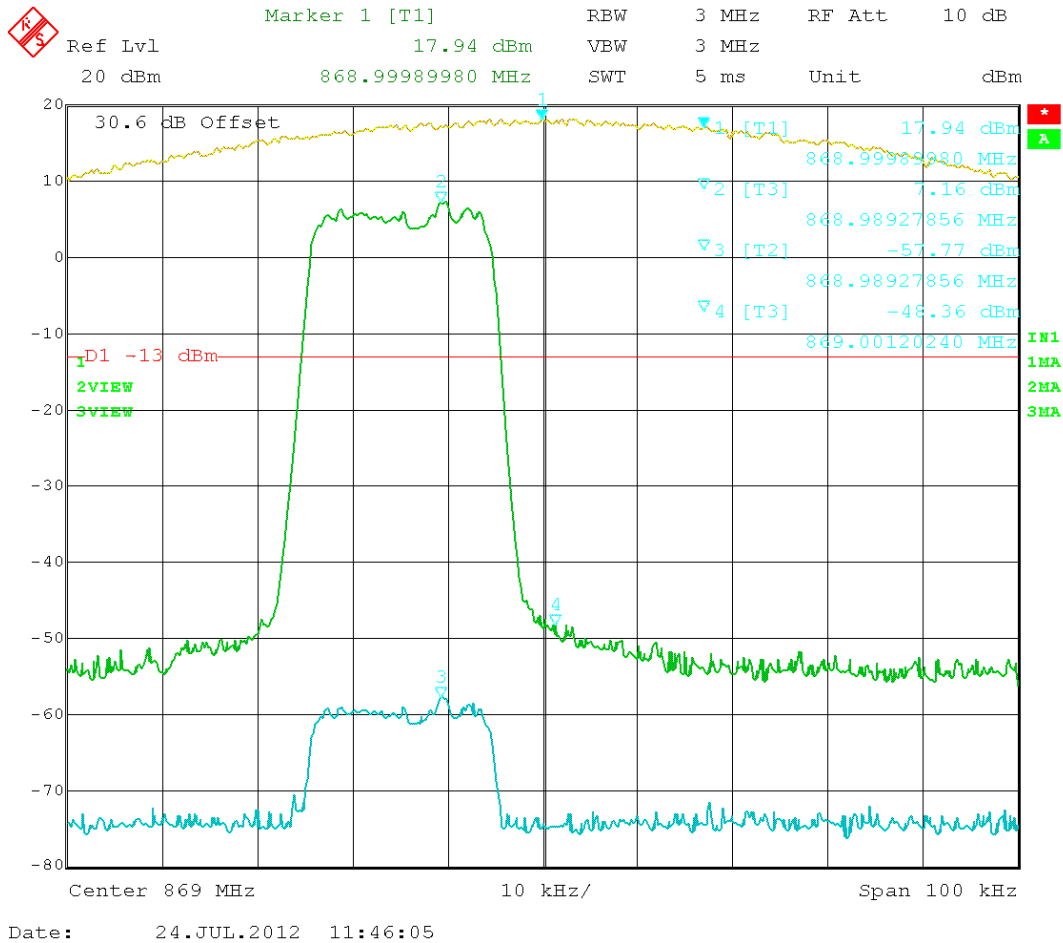

Figure 12: IDEN – In vs. Out 868.98MHz

INTERMODULATION PRODUCT SPURIOUS EMISSIONS

Rule Parts No.: Pt 2.1051

Requirements: Emissions must be $43 + 10 \log (P_o)$ dB below the mean power output of the transmitter or below the -13 dBm

All the modulation types were tested using the three tone test method. The input power to the amplifier was set at maximum drive level by combining the three tones. The three tones were chosen in such a way (1) the third order intermodulation product frequencies are located within the pass band of the DUT and (2) they produce the worst-case emissions out of band.

Test Data: The DUT appears to meet the requirements.

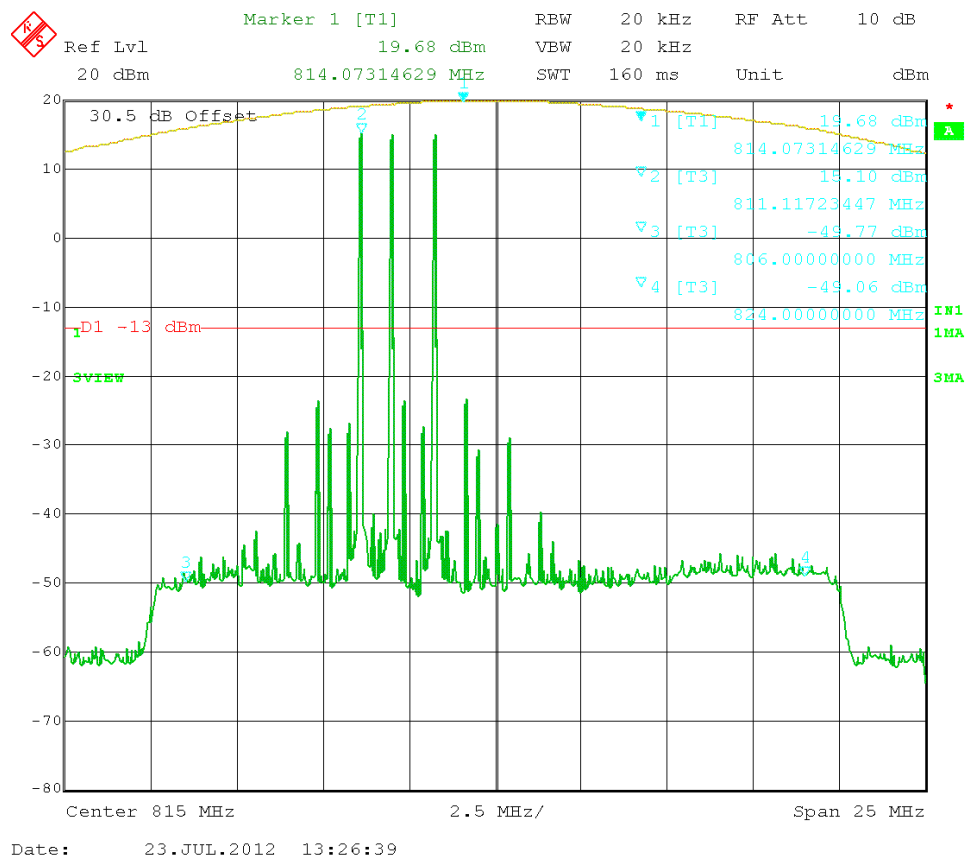

Figure 13: APCO25 3 tones intermodulation - (806 - 824) MHz.

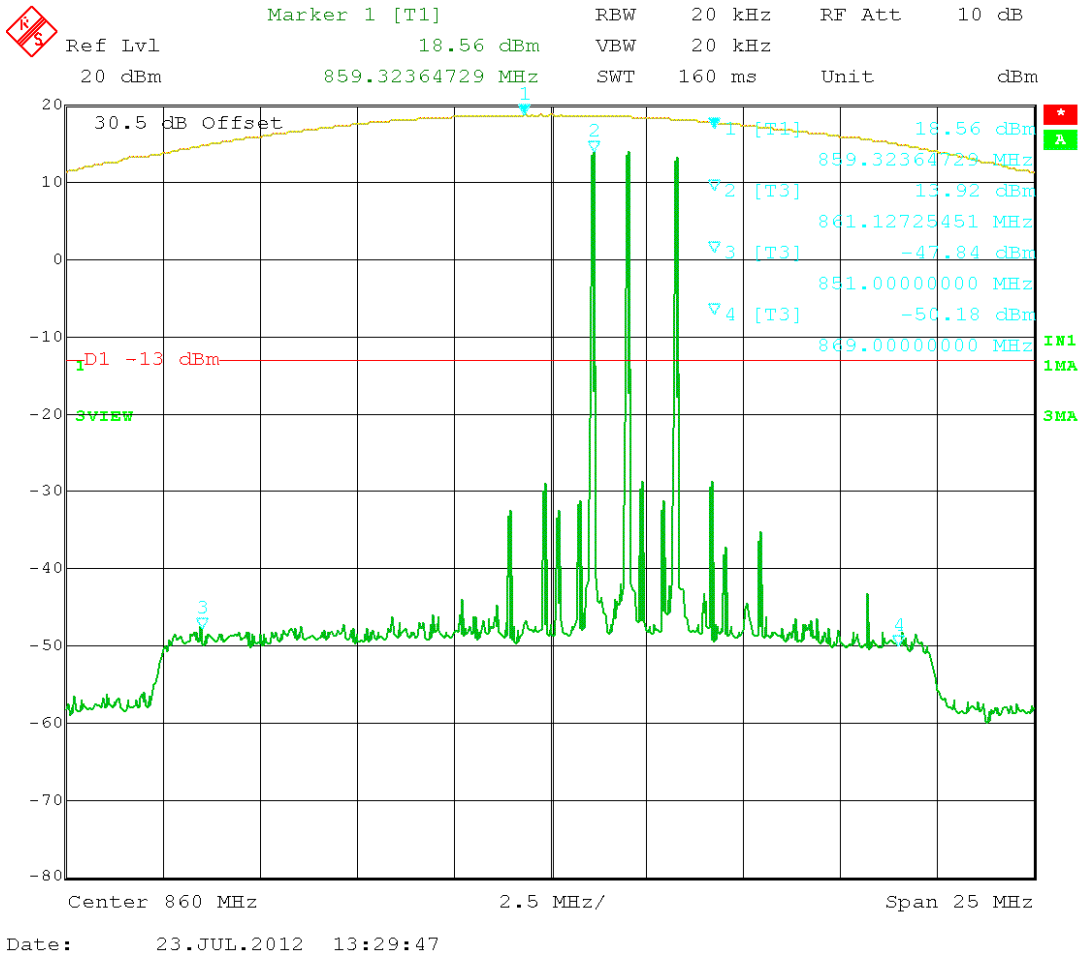

Figure 14: APCO25 3 tones intermodulation - (851 - 869) MHz.

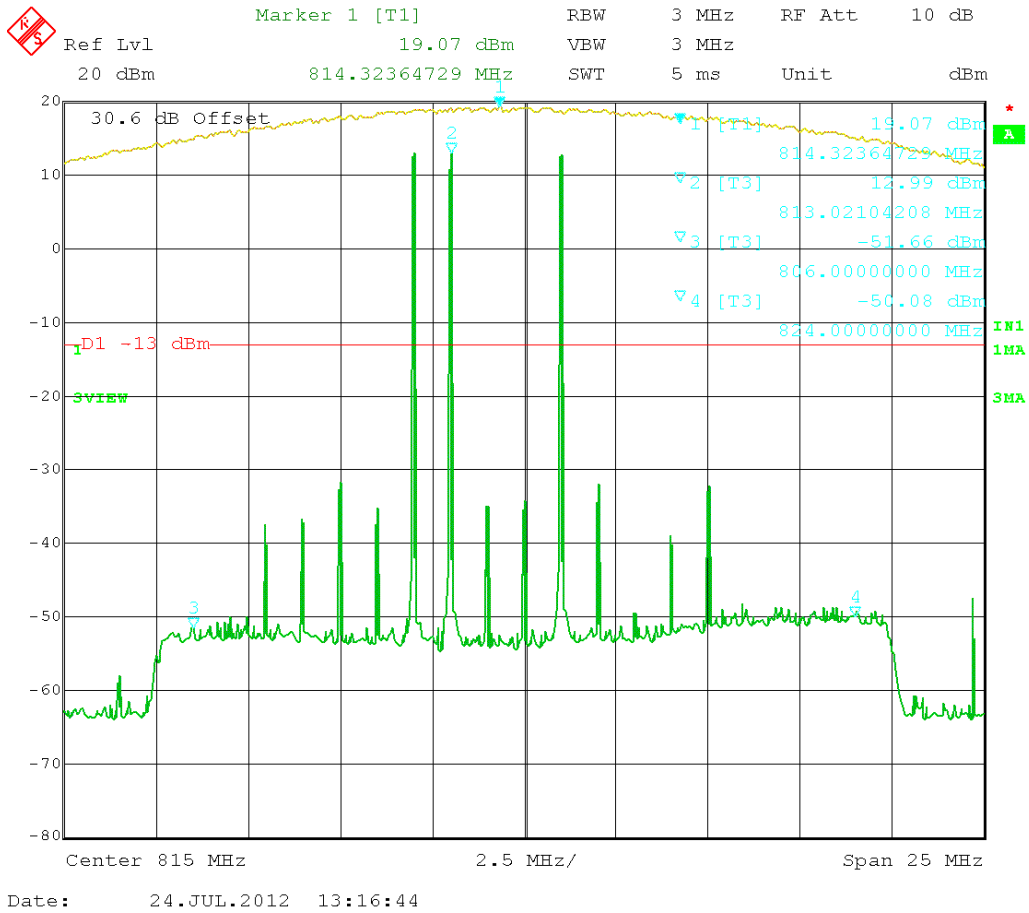

Figure 15: IDEN 3 tones intermodulation - (806 - 824) MHz.

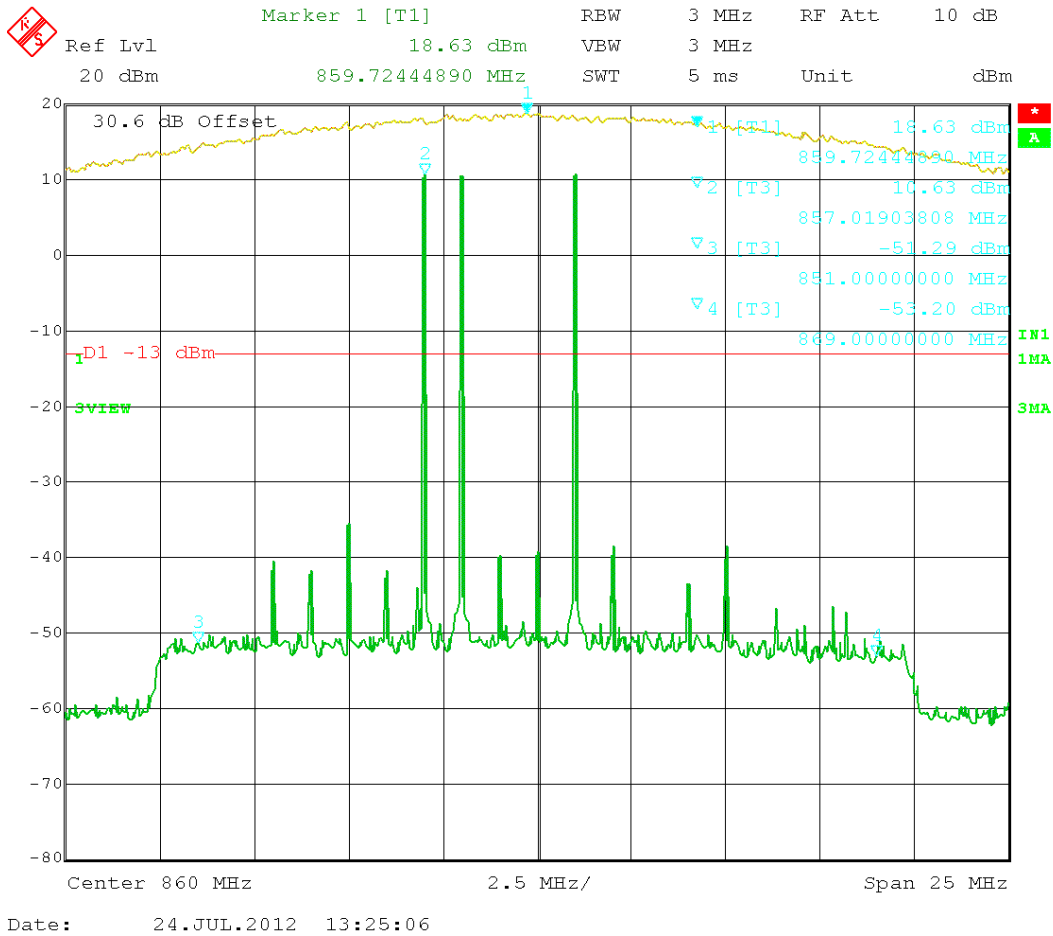

Figure 16: IDEN 3 tones intermodulation - (851 - 869) MHz.

SPURIOUS EMISSIONS AT ANTENNA TERMINALS

Rule Parts No.: Pt 2.1051

Requirements: Emissions must be $43 + 10\log(P_o)$ dB below the mean power output of the transmitter:

$$806 - 824 \text{ MHz: } 43 + 10\log(0.10) = 33.0 \text{ dBc}$$

$$851 - 869 \text{ MHz: } 43 + 10\log(0.10) = 33.0 \text{ dBc}$$

Test Result: The DUT appears to meet the requirements.

Test Data Table 7 – Conducted Emissions – CW 800 – Uplink

Emission Frequency MHz	dB Below Carrier (dBc)	Emission Frequency MHz	dB Below Carrier (dBc)	Emission Frequency MHz	dB Below Carrier (dBc)
806.02	0	815.00	0	823.98	0
1612.04	55.1	1630.00	53.0	1647.96	58.8
2418.06	78.4	2445.00	79.3	2471.94	84.1
3224.08	79.4	3260.00	79.1	3295.92	84.6
4030.10	79.1	4075.00	79.6	4119.90	84.0
4836.12	79.4	4890.00	78.9	4943.88	84.1
5642.14	75.2	5705.00	75.2	5767.86	81.1
6448.16	75.6	6520.00	76.1	6591.84	79.6
7254.18	77.5	7335.00	76.2	7415.82	81.5
8060.20	78.1	8150.00	76.3	8239.80	81.9

Test Data Table 8 – Conducted Emissions – CW 800 – Downlink

Emission Frequency MHz	dB Below Carrier (dBc)	Emission Frequency MHz	dB Below Carrier (dBc)	Emission Frequency MHz	DB Below Carrier (dBc)
851.02	0	860.00	0	868.98	0
1702.04	71.5	1720.00	76.9	1737.96	76.1
2553.06	78.0	2580.00	77.0	2606.94	77.2
3404.08	78.7	3440.00	79.1	3475.92	78.0
4255.10	78.6	4300.00	78.9	4344.90	78.4
5106.12	77.6	5160.00	77.9	5213.88	77.4
5957.14	75.8	6020.00	75.3	6082.86	75.1
6808.16	74.3	6880.00	74.1	6951.84	72.8
7659.18	75.1	7740.00	76.9	7820.82	76.6
8510.20	77.1	8600.00	77.4	8689.80	76.3

APPLICANT: FIPLEX COMMUNICATIONS INC.

FCC ID: P3TCBDAS-1A1S

Report #: F\FIPLEX_P3T\1631AUT12\1631AUT12TestReport.doc

FIELD STRENGTH OF SPURIOUS EMISSIONS

Rule Parts No.: Pt 2.1053

Requirements: Emissions must be 43+10log(Po) dB below the mean power output of the amplifier:

$$43 + 10\log(0.10) = 33.0 \text{ dB}$$

$$43 + 10\log(0.10) = 33.0 \text{ dB}$$

Test Result: The test data indicates the DUT meets the requirements

Test Data Table 9 – Radiated Emissions – CW (800 MHz) – Uplink /Downlink

Emission Frequency MHz	Ant. Polarity	dB Below Carrier (dBc)	Emission Frequency MHz	Ant. Polarity	dB Below Carrier (dBc)
815.00	0	0	860.00	0	0
1630.00	H	82.34	1720.00	H	76.70
2445.00	V	75.75	2580.00	H	70.92
3260.00	H	73.14	3440.00	H	73.26
4075.00	V	73.03	4300.00	H	68.19
4890.00	H	69.12	5160.00	H	67.42
5705.00	V	66.94	6020.00	H	64.17
6520.00	V	69.55	6880.00	V	67.67
7335.00	V	70.19	7740.00	V	66.22
8150.00	V	71.78	8600.00	V	64.80

Notes: *No other emissions were found up to the 10th harmonics - NOISE FLOOR

OUT OF BAND REJECTION: FREQUENCY RESPONSE

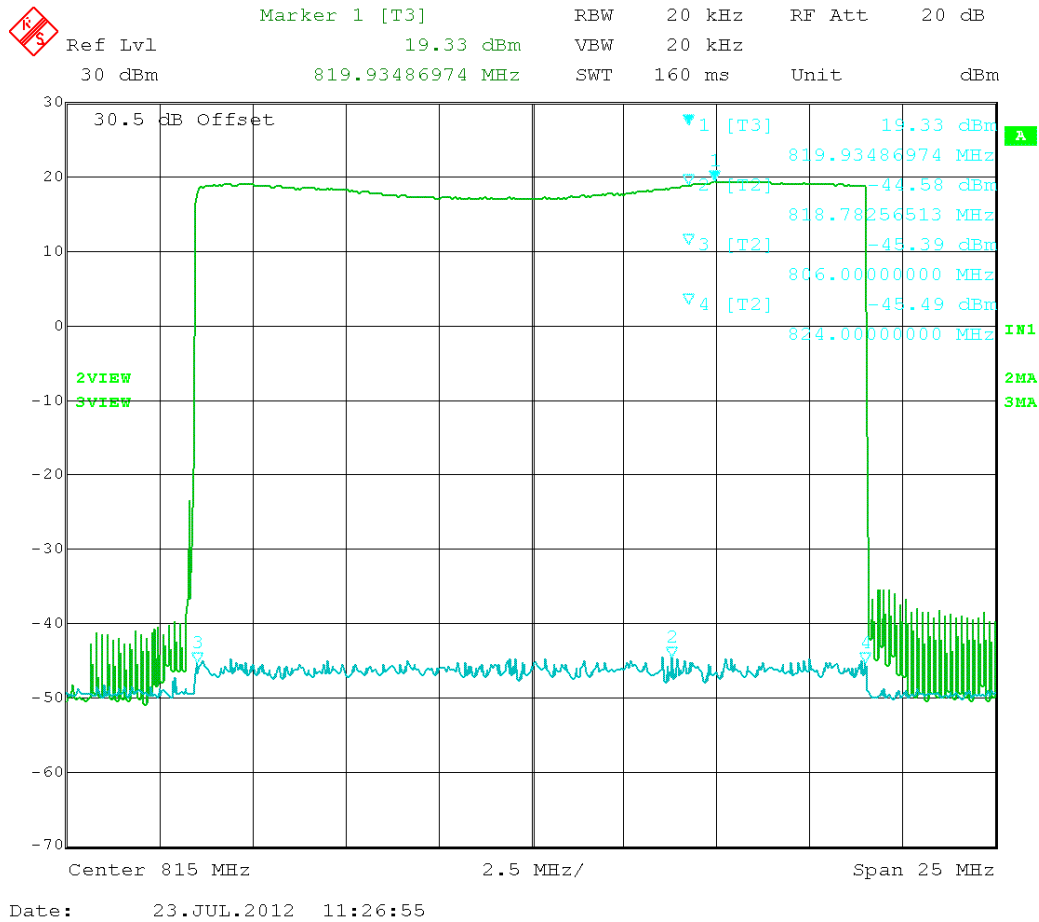

Figure 17. Frequency response (806 – 824) MHz band

Input	-44.58
Output	19.33
Pass Band Gain	63.91

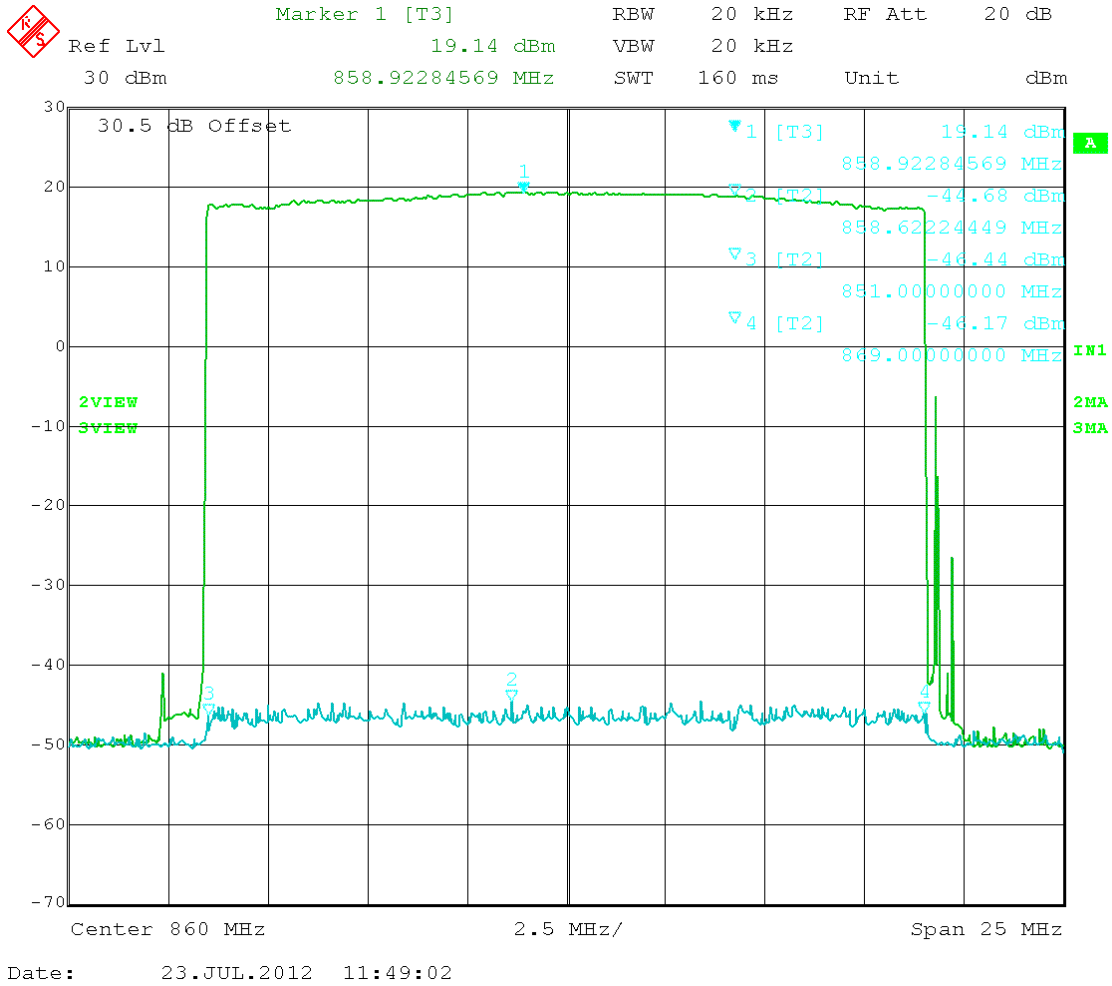

Figure 18. Frequency response (851 – 869) MHz band

Input	-44.68
Output	19.14
Pass Band Gain	63.82